



Network Box Camera

Quick Start Guide

Quick Start Guide

© 2020 Hangzhou Hikvision Digital Technology Co., Ltd. All rights reserved.

About this Manual

The Manual includes instructions for using and managing the Product. Pictures, charts, images and all other information hereinafter are for description and explanation only. The information contained in the Manual is subject to change, without notice, due to firmware updates or other reasons. Please find the latest version of this Manual at the Hikvision website (<http://www.hikvision.com/>).

Please use this Manual with the guidance and assistance of professionals trained in supporting the Product.

Trademarks

- **HIKVISION** and other Hikvision's trademarks and logos are the properties of Hikvision in various jurisdictions.
- Other trademarks and logos mentioned are the properties of their respective owners.

Disclaimer

TO THE MAXIMUM EXTENT PERMITTED BY APPLICABLE LAW, THIS MANUAL AND THE PRODUCT DESCRIBED, WITH ITS HARDWARE, SOFTWARE AND FIRMWARE, ARE PROVIDED "AS IS" AND "WITH ALL FAULTS AND ERRORS". HIKVISION MAKES NO WARRANTIES, EXPRESS OR IMPLIED, INCLUDING WITHOUT LIMITATION, MERCHANTABILITY, SATISFACTORY QUALITY, OR FITNESS FOR A PARTICULAR PURPOSE. THE USE OF THE PRODUCT BY YOU IS AT YOUR OWN RISK. IN NO EVENT WILL HIKVISION BE LIABLE TO YOU FOR ANY SPECIAL,

CONSEQUENTIAL, INCIDENTAL, OR INDIRECT DAMAGES, INCLUDING, AMONG OTHERS, DAMAGES FOR LOSS OF BUSINESS PROFITS, BUSINESS INTERRUPTION, OR LOSS OF DATA, CORRUPTION OF SYSTEMS, OR LOSS OF DOCUMENTATION, WHETHER BASED ON BREACH OF CONTRACT, TORT (INCLUDING NEGLIGENCE), PRODUCT LIABILITY, OR OTHERWISE, IN CONNECTION WITH THE USE OF THE PRODUCT, EVEN IF HIKVISION HAS BEEN ADVISED OF THE POSSIBILITY OF SUCH DAMAGES OR LOSS.

YOU ACKNOWLEDGE THAT THE NATURE OF INTERNET PROVIDES FOR INHERENT SECURITY RISKS, AND HIKVISION SHALL NOT TAKE ANY RESPONSIBILITIES FOR ABNORMAL OPERATION, PRIVACY LEAKAGE OR OTHER DAMAGES RESULTING FROM CYBER-ATTACK, HACKER ATTACK, VIRUS INSPECTION, OR OTHER INTERNET SECURITY RISKS; HOWEVER, HIKVISION WILL PROVIDE TIMELY TECHNICAL SUPPORT IF REQUIRED.

YOU AGREE TO USE THIS PRODUCT IN COMPLIANCE WITH ALL APPLICABLE LAWS, AND YOU ARE SOLELY RESPONSIBLE FOR ENSURING THAT YOUR USE CONFORMS TO THE APPLICABLE LAW. ESPECIALLY, YOU ARE RESPONSIBLE, FOR USING THIS PRODUCT IN A MANNER THAT DOES NOT INFRINGE ON THE RIGHTS OF THIRD PARTIES, INCLUDING WITHOUT LIMITATION, RIGHTS OF PUBLICITY, INTELLECTUAL PROPERTY RIGHTS, OR DATA PROTECTION AND OTHER PRIVACY RIGHTS. YOU SHALL NOT USE THIS PRODUCT FOR ANY PROHIBITED END-USES, INCLUDING THE DEVELOPMENT OR PRODUCTION OF WEAPONS OF MASS DESTRUCTION, THE DEVELOPMENT OR PRODUCTION OF CHEMICAL OR BIOLOGICAL WEAPONS, ANY ACTIVITIES IN THE CONTEXT RELATED TO ANY

NUCLEAR EXPLOSIVE OR UNSAFE NUCLEAR FUEL-CYCLE, OR IN SUPPORT OF HUMAN RIGHTS ABUSES.

IN THE EVENT OF ANY CONFLICTS BETWEEN THIS MANUAL AND THE APPLICABLE LAW, THE LATER PREVAILS.

Regulatory Information

FCC Information

Please take attention that changes or modification not expressly approved by the party responsible for compliance could void the user's authority to operate the equipment.

FCC compliance: This equipment has been tested and found to comply with the limits for a Class B digital device, pursuant to part 15 of the FCC Rules. These limits are designed to provide reasonable protection against harmful interference in a residential installation. This equipment generates, uses and can radiate radio frequency energy and, if not installed and used in accordance with the instructions, may cause harmful interference to radio communications. However, there is no guarantee that interference will not occur in a particular installation. If this equipment does cause harmful interference to radio or television reception, which can be determined by turning the equipment off and on, the user is encouraged to try to correct the interference by one or more of the following measures:

- Reorient or relocate the receiving antenna.
- Increase the separation between the equipment and receiver.
- Connect the equipment into an outlet on a circuit different from that to which the receiver is connected.
- Consult the dealer or an experienced radio/TV technician for help

FCC Conditions

This device complies with part 15 of the FCC Rules. Operation is subject to the following two conditions:

1. This device may not cause harmful interference.
2. This device must accept any interference received, including interference that may cause undesired operation.

EU Conformity Statement



This product and - if applicable - the supplied accessories too are marked with "CE" and comply therefore with the applicable harmonized European standards listed under the EMC Directive 2014/30/EU, the RoHS Directive 2011/65/EU.



2012/19/EU (WEEE directive): Products marked with this symbol cannot be disposed of as unsorted municipal waste in the European Union. For proper recycling, return this product to your local supplier upon the purchase of equivalent new equipment, or dispose of it at designated collection points. For more information see:

www.recyclethis.info.



2006/66/EC (battery directive): This product contains a battery that cannot be disposed of as unsorted municipal waste in the European Union. See the product documentation for specific battery information. The battery is marked with this symbol, which may include lettering to indicate cadmium (Cd), lead (Pb), or mercury (Hg). For proper recycling, return the battery to your

supplier or to a designated collection point. For more information see: www.recyclethis.info.

Industry Canada ICES-003 Compliance

This device meets the CAN ICES-3 (B)/NMB-3(B) standards requirements.



Safety Instruction

These instructions are intended to ensure that user can use the product correctly to avoid danger or property loss.

The precaution measure is divided into "Warnings" and "Cautions"

Warnings: Serious injury or death may occur if any of the warnings are neglected.

Cautions: Injury or equipment damage may occur if any of the cautions are neglected.

 Warnings	 Cautions
Warnings Follow these safeguards to prevent serious injury or death.	Cautions Follow these precautions to prevent potential injury or material damage.



Warnings

- Proper configuration of all passwords and other security settings is the responsibility of the installer and/or end-user.

- In the use of the product, you must be in strict compliance with the electrical safety regulations of the nation and region. Please refer to technical specifications for detailed information.
- The power source should meet limited power source or PS2 requirements according to IEC 60950-1 or IEC 62368-1 standard. Refer to the appropriate documentation for detailed information.
- Do not connect several devices to one power adapter as adapter overload may cause over-heating or a fire hazard.
- Please make sure that the plug is firmly connected to the power socket. When the product is mounted on wall or ceiling, the device shall be firmly fixed.
- If smoke, odor or noise rise from the device, turn off the power at once and unplug the power cable, and then please contact the service center.



Cautions

- CAUTION: Hot parts! Burned fingers when handling the parts.



Wait one-half hour after switching off before handling parts. This sticker is to indicate that the marked item can be hot and should not be touched without taking care. For device with this sticker, this device is intended for installation in a restricted access location, access can only be gained by service persons or by users who have been instructed about the reasons for the restrictions

applied to the location and about any precautions that shall be taken.

- Make sure the power supply voltage is correct before using the camera.
- Do not drop the camera or subject it to physical shock.
- Do not touch sensor modules with fingers. If cleaning is necessary, use clean cloth with a bit of ethanol and wipe it gently. If the camera will not be used for an extended period, please replace the lens cap to protect the sensor from dirt.
- Do not aim the camera at the sun or extra bright places. Blooming or smearing may occur otherwise (which is not a malfunction), and affect the endurance of sensor at the same time.
- The sensor may be burned out by a laser beam, so when any laser equipment is in using, make sure that the surface of sensor will not be exposed to the laser beam.
- Do not place the camera in extremely hot, cold (the operating temperature shall be $-30\text{ }^{\circ}\text{C}$ to $+60\text{ }^{\circ}\text{C}$ ($-22\text{ }^{\circ}\text{F}$ to $140\text{ }^{\circ}\text{F}$)), dusty or damp locations, and do not expose it to high electromagnetic radiation.
- To avoid heat accumulation, good ventilation is required for operating environment.
- Keep the camera away from liquid while in use.
- While in delivery, the camera shall be packed in its original packing, or packing of the same texture.

- Regular part replacement: a few parts (e.g. electrolytic capacitor) of the equipment shall be replaced regularly according to their average enduring time. The average time varies because of differences between operating environment and using history, so regular checking is recommended for all the users. Please contact with your dealer for more details.
- This equipment is not suitable for use in locations where children are likely to be present.
- CAUTION: Risk of explosion if the battery is replaced by an incorrect type. Dispose of used batteries according to the instructions

ATTENTION: IL Y A RISQUE D'EXPLOSION SI LA BATTERIE EST REMPLACÉE PAR UNE BATTERIE DE TYPE INCORRECT. METTRE AU REBUT LES BATTERIES USAGÉES CONFORMÉMENT AUX INSTRUCTIONS

- Improper replacement of the battery with an incorrect type may defeat a safeguard (for example, in the case of some lithium battery types).
- Do not dispose of the battery into fire or a hot oven, or mechanically crush or cut the battery, which may result in an explosion.
- Do not leave the battery in an extremely high temperature surrounding environment, which may result in an explosion or the leakage of flammable liquid or gas.
- Do not subject the battery to extremely low air pressure, which may result in an explosion or the leakage of flammable liquid or gas.

- If the product does not work properly, please contact your dealer or the nearest service center. Never attempt to disassemble the camera yourself. (We shall not assume any responsibility for problems caused by unauthorized repair or maintenance.)

Table of Contents

1 Appearance Description	11
2 Installation	14
2.1 Memory Card Installation.....	14
2.2 Lens Installation	15
2.3 Camera Mounting	16
2.3.1 Pendant Mounting	17
2.3.2 Wall Mounting.....	18
2.4 Mounting with Housing.....	20
2.4.1 Mounting Type I Housing.....	20
2.4.2 Mounting Type II Housing.....	25
2.5 Zoom and Focus Adjustment.....	30
3 Activate and Access Network Camera	32

1 Appearance Description

The overview of the box camera is shown below:

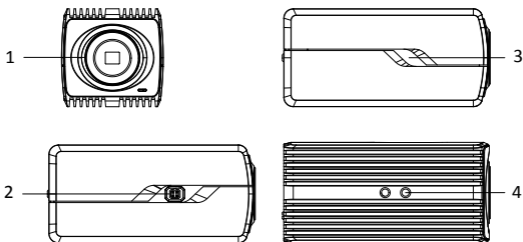



Figure 1-1 Overview

Table 1-1 Description

No.	Description	No.	Description
1	Lens mount	2	Auto-iris interface
3	Power indicator	4	¼-20 UNC screw hole

The interfaces on the rear panel are described as follows. The actual interfaces may vary with the device model.

Table 1-2 Rear Panel Interface Description

Item	Description	Item	Description
VIDEO OUT/CVBS	Analog video output interface	RS-485	D+ or D- connect to 485
AUDIO IN	Audio input interface	AUDIO OUT	Audio output interface
ALARM IN	Alarm input interface, IN1 and GND1, IN2 and GND2 are two pairs of alarm inputs	ALARM OUT	Alarm output interface, 1A and 1B, 2A and 2B, 3A and 3B are three pairs of alarm outputs
SFP	Optical interface	LAN(PoE)	Network interface, PoE supported
RESET	One-key reset button	ABF	Auto back focus adjusting knob
DC 12V, AC 24V	Power input	DC12V, GND /DC 12V_OUT	Power output interface
	Grounding	MicroSD 	Memory card slot Insert the memory card for local storage

DEBUG	Debugging interface		
-------	---------------------	--	--

Note:

- Power indicator: red stands for starting and blue for working.
- To reset the camera default parameters, you need to press and hold the RESET button and power on the camera. After the power on of the camera, you must still press and hold the Reset button for about 10 seconds.
- ABF is supported by certain camera models.

2 Installation

Before you start:

- Make sure the device in the package is in good condition and all the assembly parts are included.
- The standard power supply is 12 VDC or 24 VAC or PoE, please make sure your power supply matches with your camera.
- Make sure all the related equipment is power-off during the installation.
- Check the specification of the products for the installation environment.
- Make sure that the wall is strong enough to withstand four times the weight of the camera and the bracket.

For the camera that supports IR, you are required to pay attention to the following precautions to prevent IR reflection:

- Make sure that there is no reflective surface too close to the camera lens. The IR light from the camera may reflect back into the lens causing reflection.

2.1 Memory Card Installation

Only certain camera models support memory card installation. The actual device appearance may vary with the model. The following takes a model as an example to illustrate the installation steps.

Steps:

1. Insert the memory card to memory card slot on the rear panel of the camera.

- (Optional) If you want to unmount the memory card, push to get it ejected.

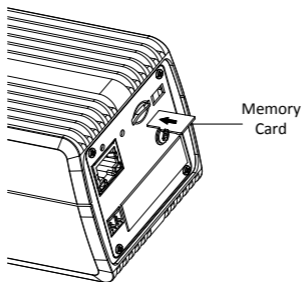

Figure 2-1 Memory Card Installation

2.2 Lens Installation

The actual device appearance may vary with the model. The following takes a model as an example to illustrate the installation steps.

Before you start:

The lens shown below is only for demonstration.

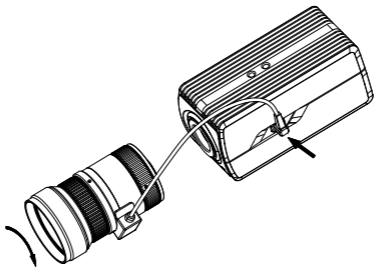

Figure 2-2 Lens Installation

Steps:

1. Fit the lens (not supplied) to the camera and rotate it to get it tightened.

Notes:

- Install the adapter ring to the lens interface if a C-mount lens is used.
 - A manual-iris lens can be directly installed to the camera without plugging the power cable of the auto-iris to the auto-iris interface.
2. Plug the auto-iris cable to the auto-iris interface.

2.3 Camera Mounting

The actual device appearance may vary with the model. The following takes a model as an example to illustrate the installation steps.

2.3.1 Pendant Mounting

Before you start:

Pendant mount is not included in package. If you adopt this mounting style, you need to prepare a mounting bracket in advance. The shown pendant mount is for demonstration.

Steps:

1. Install the pendant mount to the ceiling with the supplied screws.

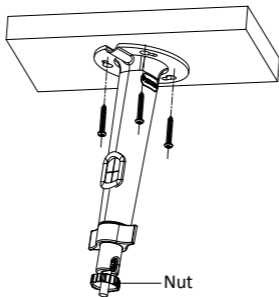

Figure 2-3 Install the Mount

2. Screw the camera to pendant mount and tighten the nut.
3. Adjust surveillance angle

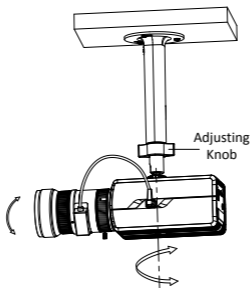

Figure 2-4 Adjust Surveillance Angle

- 1). Loosen the adjusting knob.
- 2). Hold the camera body to adjust panning and tilting position.
- 3). Tighten the knob after adjustment.
4. Adjust zoom and focus level. Refer to *Section 2.5*.

2.3.2 Wall Mounting

Before you start:

Wall mount is not included in package. If you adopt this mounting style, you need to prepare a mounting bracket in advance. The shown wall mount is for demonstration.

Steps:

1. Separate the pedestal from the wall mount.

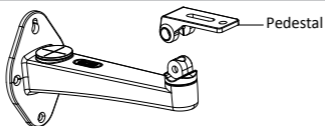

Figure 2-5 Separate Pedestal

2. Fix the pedestal to camera body.

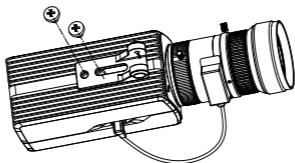

Figure 2-6 Fix Pedestal to Camera

3. Install the wall mount to wall.
4. Install the pedestal together with the camera back to wall mount.

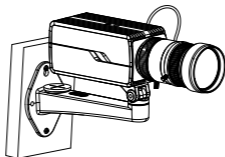

Figure 2-7 Install Camera to Wall Mount

5. Adjust the surveillance angle.
 - 1). Loosen tilt adjusting screw. Tighten the screw after adjusting.
 - 2). Loosen pan adjusting screw. Tighten the screw after adjusting.

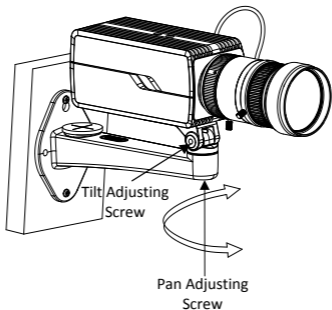

Figure 2-8 Adjust Surveillance Angle

6. Adjust zoom and focus level. Refer to *Section 2.5*.

2.4 Mounting with Housing

Before you start:

The shown housing is not included in package. You need to prepare one if you adopt this mounting style.

Also, for housing mounting, you need to prepare suitable brackets in advance.

2.4.1 Mounting Type I Housing

Steps:

1. Screw the camera to mounting plate of the housing.

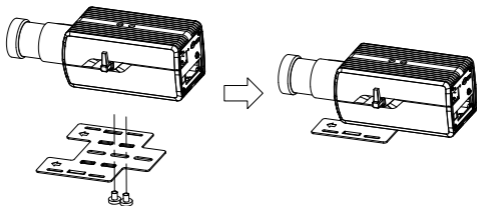

Figure 2-9 Install Camera to Mounting Plate

2. Screw the mounting plate together with the camera back to the housing.

Note:

Push the camera as close to the window as possible.

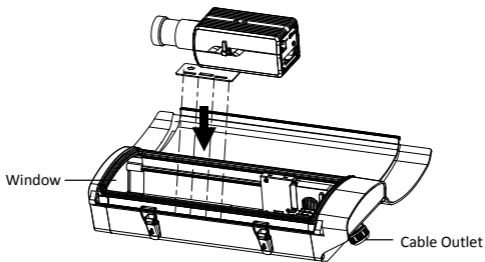
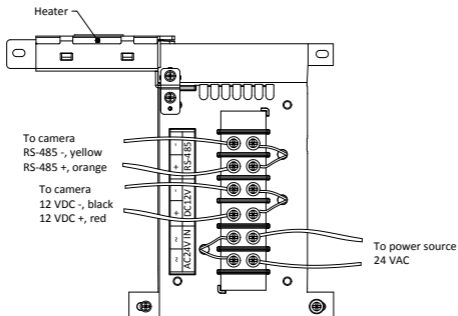

Figure 2-10 Install Camera to Housing

3. Connect and route cables through the cable outlet of the housing.

Network Box Camera ▪ Quick Start Guide

- 1). For network, alarm input and output, and audio input and output, plug corresponding plugs to the rear panel of the camera. See Figure 1-1.
- 2). For power supply and RS-485, see the following figure.



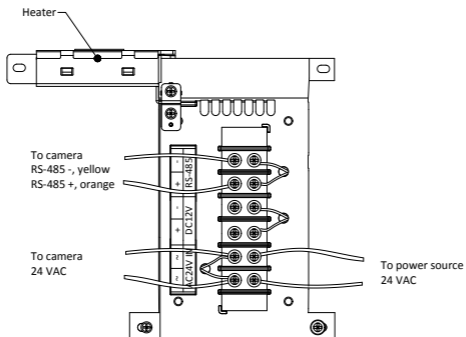
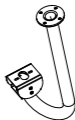
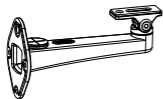

Figure 2-11 Wiring Board in Housing

4. Buckle the housing.
5. Install the housing to surveillance scene.
Using brackets, the housing supports wall mounting, pole mounting, and pendant mounting. The brackets are shown in the figures below:



Wall Mount

Horizontal Pole Mount

Pendant Mount

- 1). Install the bracket onto the wall/ceiling/pole. The wall mounting bracket, pole mounting bracket, and the pendant bracket are shown in the figures below.

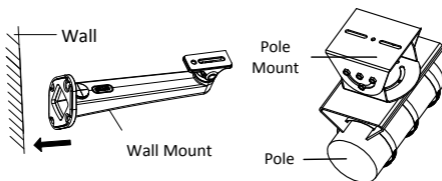

Figure 2-12 Install the Bracket to Mounting Place (1)

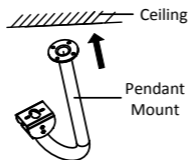

Figure 2-13 Install the Bracket to Mounting Place (2)

- 2). Fix the housing (with camera) onto the bracket with the supplied screws.
- 3). Loosen the adjusting screw to adjust the surveillance angle of the camera. Tighten the screw after adjustment.

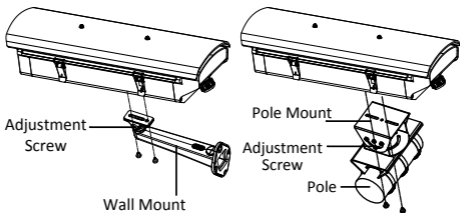

Figure 2-14 Fix the Housing to Brackets (1)

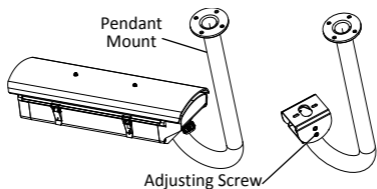

Figure 2-15 Fix the Housing to Brackets (2)

6. Adjust zoom and focus. Refer to *Section 2.5*.

2.4.2 Mounting Type II Housing

Steps:

1. Connect and route cables through the cable outlet of the housing.

- 1). For network, alarm input and output, and audio input and output, plug corresponding plugs to the rear panel of the camera. See Figure 1-1.
- 2). For power supply and RS-485, see the following figure.

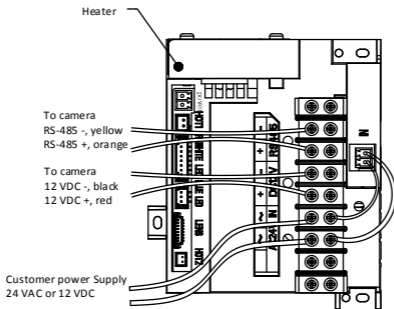
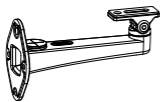

Figure 2-16 Wiring Board in Housing

2. Buckle the housing.
3. Install the housing to surveillance scene.
Using brackets, the housing supports wall mounting, pole mounting, pendant mounting, column mounting, integrated mounting, and integrated mounting with junction box. The brackets are shown in the figures below:



Wall Mount



Horizontal Pole Mount

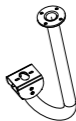

Pendant Mount

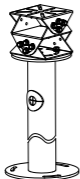

Column Mount

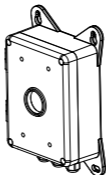

Junction Box

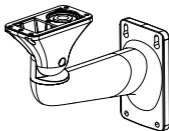

Integrated Mount

- 1). Install the bracket onto the wall/ceiling/pole/ground. The wall mounting bracket, pole mounting bracket, pendent bracket, column mounting bracket, integrated mounting bracket, and junction box are shown in the figures below.

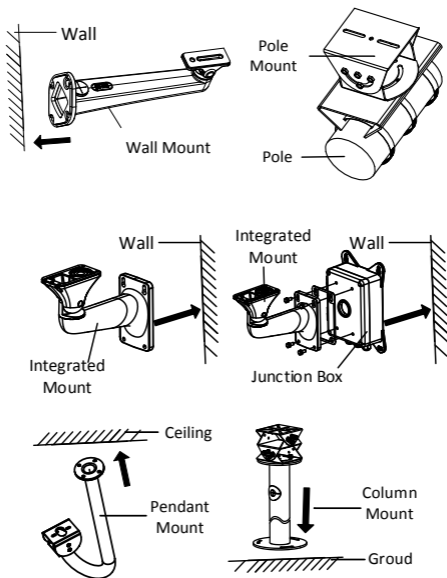

Figure 2-17 Install the Bracket to Mounting Place

- 2). Fix the housing (with camera) onto the bracket with the supplied screws.
- 3). Loosen the adjusting screw to adjust the surveillance angle of the camera. Tighten the screw after adjustment.

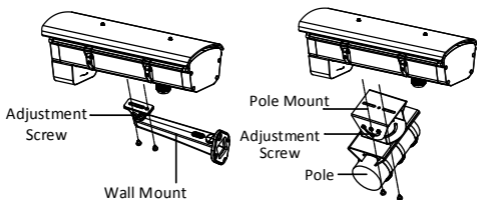

Figure 2-18 Fix the Housing to Brackets (1)

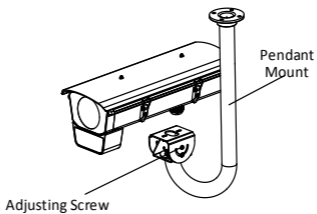

Figure 2-19 Fix the Housing to Brackets (2)

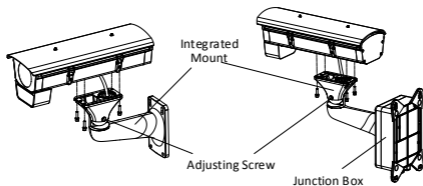

Figure 2-20 Fix the Housing to Brackets (3)

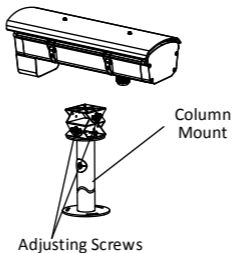

Figure 2-21 Fix the Housing to Brackets (4)

4. Adjust zoom and focus. Refer to *Section 2.5*.

2.5 Zoom and Focus Adjustment

Steps:

1. Power on the camera.

2. Connect the video out interface of the camera to the installation display device.
3. Adjust zoom and focus.

- For certain camera models, zoom and focus must be manually adjusted via zoom/focus lever according to the image on the display device.

Note:

For the camera equipped with the auto iris, it is suggested you change the iris mode to manual from the camera menu (accessed via web browser), and re-change it back to auto iris after you adjust the focus by the focus lever.

- For camera equipped with a motor-driven lens, adjust the zoom and focus on PTZ control panel by visiting the camera via web browser or client software.
4. (Optional) For the camera supports ABF, you can adjust the focus manually, or click the ABF button on the rear panel of the camera to adjust the focus automatically.

3 Activate and Access Network Camera

Scan the QR code to get *Activate and Visit Network Camera*. Note that mobile data charges may apply if Wi-Fi is unavailable



