

SR61T

Tethered Scanner

User's Guide



Intermec[®]

Intermec Technologies Corporation

Worldwide Headquarters

6001 36th Ave.W.

Everett, WA 98203

U.S.A.

www.intermec.com

The information contained herein is provided solely for the purpose of allowing customers to operate and service Intermec-manufactured equipment and is not to be released, reproduced, or used for any other purpose without written permission of Intermec Technologies Corporation.

Information and specifications contained in this document are subject to change without prior notice and do not represent a commitment on the part of Intermec Technologies Corporation.

© 2009-2010 by Intermec Technologies Corporation. All rights reserved.

The word Intermec, the Intermec logo, Norand, ArciTech, Beverage Routebook, CrossBar, dcBrowser, Duratherm, EasyADC, EasyCoder, EasySet, Fingerprint, i-gistics, INCA (under license), Intellitag, Intellitag Gen2, JANUS, LabelShop, MobileLAN, Picolink, Ready-to-Work, RoutePower, Sabre, ScanPlus, ShopScan, Smart Mobile Computing, SmartSystems, TE 2000, Trakker Antares, and Vista Powered are either trademarks or registered trademarks of Intermec Technologies Corporation.

There are U.S. and foreign patents as well as U.S. and foreign patents pending.

Document Change Record

This page records changes to this document. The document was originally released as Revision 001.

Version Number	Date	Description of Change
002	3/2009	Revised to support hardware and software for release 2. Updates included new cables and data transmission settings.
003	8/2010	Revised to support all new SR61T models (SR61T1D-xxx, SR61TL-xxx, SR61T2D-xxx, SR61THP-xxx, and SR61TXR-xxx). Version 002 of this document remains valid for legacy models (SR61TVxxxx, SR61TAxxxx, SR61TLxxxx and SR61TExxxx).

Contents

Document Change Record.....	iii
Before You Begin.....	viii
Safety Information.....	viii
Global Services and Support.....	ix
Warranty Information.....	ix
Web Support.....	ix
Telephone Support.....	ix
Service Location Support.....	ix
Who Should Read This Manual.....	x
Related Documents.....	x
Patent Information.....	xi
1 Introducing the SR61T.....	1
What is the SR61T Tethered Scanner.....	2
Supported Interfaces.....	3
Powering the SR61T.....	3
Connecting the Interface Cable.....	4
Removing the Interface Cable.....	4
Accessories.....	5
Required Accessories.....	5
Optional Accessories.....	6
Desktop Stand.....	6
Hands-Free Stand.....	6
Wall or Vehicle Mount Holder.....	7
2 Scanning With the SR61T.....	9
Understanding the SR61T Behavior.....	10
Understanding the Status Light.....	10
Understanding the Beeps.....	11
Stacked Code Crackle.....	11
Using Vibrate Alert.....	12
Scanning Bar Codes.....	13

Hands-Free Scanning 16

3 SR61T Interfaces 17

USB Interface 18
 Connecting a USB Cable 18
 Setting up the USB Interface 19
 International Keyboard 19
 USB Cable Mode 21

RS-232 Interface 24
 Connecting an RS-232 Cable 24
 Setting up the RS-232 Interface 25
 Baud Rate 25
 Data Bits 26
 Parity 26
 Stop Bits 26

Keyboard Wedge/Y-Cable Interface 27
 Connecting a Keyboard Wedge or Y-Cable 27

Wand Emulation Interface 29
 Connecting a Wand Emulation Cable 29
 Setting up the Wand Emulation Interface 29
 Logical Signal State During Transmission 29

4 Configuring the SR61T 31

Basic Setup with Configuration Bar Codes 32
 Resetting Your Scanner 32
 Configuring Predefined Imager Modes 32
 Configuring the Postamble 32

Configuring Your Scanner with EasySet 33
 Online Setup with EasySet 33
 Offline Setup with EasySet 35

5 Troubleshooting and Maintaining the SR61T 37

Troubleshooting the SR61T 38
 Calling Product Support 38
 Problems and Possible Solutions 39

Maintaining the SR61T 41

Upgrading the SR61T 41
Scanner Recovery 45
Cleaning the SR61T 46

A Specifications and Reading Distances 47

Specifications 48

Reading Distances 51

SR61T1D 51

SR61TL 52

SR61T2D 53

SR61THP 54

SR61TXR 55

Before You Begin

This section provides you with safety information, technical support information, and sources for additional product information.

Safety Information

Your safety is extremely important. Read and follow all warnings and cautions in this document before handling and operating Intermec equipment. You can be seriously injured, and equipment and data can be damaged if you do not follow the safety warnings and cautions.

This section explains how to identify and understand warnings, cautions, and notes that are in this document.



A warning alerts you of an operating procedure, practice, condition, or statement that must be strictly observed to avoid death or serious injury to the persons working on the equipment.



A caution alerts you to an operating procedure, practice, condition, or statement that must be strictly observed to prevent equipment damage or destruction, or corruption or loss of data.



Note: Notes either provide extra information about a topic or contain special instructions for handling a particular condition or set of circumstances.

Global Services and Support

Warranty Information

To understand the warranty for your Intermec product, visit the Intermec web site at www.intermec.com and click **Support > Returns and Repairs > Warranty**.

Disclaimer of warranties: The sample code included in this document is presented for reference only. The code does not necessarily represent complete, tested programs. The code is provided “as is with all faults.” All warranties are expressly disclaimed, including the implied warranties of merchantability and fitness for a particular purpose.

Web Support

Visit the Intermec web site at www.intermec.com to download our current manuals (in PDF). To order printed versions of the Intermec manuals, contact your local Intermec representative or distributor.

Visit the Intermec technical knowledge base (Knowledge Central) at www.intermec.com and click **Support > Knowledge Central** to review technical information or to request technical support for your Intermec product.

Telephone Support

In the U.S.A. and Canada, call **1-800-755-5505**.

Outside the U.S.A. and Canada, contact your local Intermec representative. To search for your local representative, from the Intermec web site, click **About Us > Contact Us**.

Service Location Support

For the most current listing of service locations, go to www.intermec.com and click **Support > Returns and Repairs > Repair Locations**.

For technical support in South Korea, use the after service locations listed below:

Awoo Systems

102-1304 SK Ventium

522 Dangjung-dong

Gunpo-si, Gyeonggi-do Korea, South 435-776

Contact: Mr. Sinbum Kang

Telephone: +82-31-436-1191

Email: mjyun@awoo.co.kr

IN Information System PTD LTD

6th Floor

Daegu Venture Center Bldg 95

Shinchun 3 Dong

Donggu, Daegu City, Korea

E-mail: jmyou@idif.co.kr or korlim@gw.idif.co.kr

Who Should Read This Manual

This guide is for the person who is responsible for installing, configuring, and maintaining the SR61T.

This guide provides you with information about the features of the SR61T, and how to install, configure, operate, maintain, and troubleshoot it.

Related Documents

The Intermec web site at www.intermec.com contains our documents (as PDF files) that you can download for free.

To download documents

- 1 Visit the Intermec web site at www.intermec.com.
- 2 Click the **Products** tab.
- 3 Using the **Products** menu, navigate to your product page. For example, to find the CN3 computer product page, click **Computers > Handheld Computers > CN3**.
- 4 Click the **Manuals** tab.

If your product does not have its own product page, click **Support > Manuals**. Use the **Product Category** field, the **Product Family** field, and the **Product** field to help you locate the documentation for your product.

Patent Information

Product is covered by one or more of the following patents:

4,882,476; 4,894,523; 4,953,113; 4,970,379; 4,988,852; 5,019,699;
5,021,642; 5,038,024; 5,081,343; 5,095,197; 5,144,119; 5,144,121;
5,182,441; 5,187,355; 5,187,356; 5,216,233; 5,216,550; 5,218,191;
5,233,172; 5,241,488; 5,243,602; 5,258,606; 5,288,985; 5,308,966;
5,342,210; 5,359,185; 5,389,770; 5,397,885; 5,414,251; 5,416,463;
5,442,167; 5,464,972; 5,468,947; 5,468,950; 5,477,044; 5,486,689;
5,500,516; 5,502,297; 5,504,367; 5,514,858; 5,534,684; 5,536,924;
5,539,191; 5,541,419; 5,548,108; 5,550,362; 5,550,364; 5,565,669;
5,572,007; 5,576,529; 5,594,230; 5,598,007; 5,608,578; 5,616,909;
5,619,027; 5,640,001; 5,659,431; 5,672,860; 5,684,290; 5,719,678;
5,729,003; 5,742,041; 5,761,219; 5,764,798; 5,777,308; 5,777,309;
5,777,310; 5,786,583; 5,798,509; 5,798,513; 5,804,805; 5,811,776;
5,811,777; 5,818,027; 5,821,523; 5,834,749; 5,837,987; 5,841,121;
5,842,070; 5,854,478; 5,862,267; 5,869,840; 5,873,070; 5,877,486;
5,878,395; 5,886,338; 5,895,906; 5,902,987; 5,902,988; 5,912,452;
5,923,022; 5,936,224; 5,949,056; 5,969,321; 5,969,326; 5,979,768;
5,987,192; 5,992,750; 6,003,775; 6,012,640; 6,016,960; 6,018,597;
6,024,289; 6,034,379; 6,036,093; 6,039,252; 6,064,763; 6,095,422;
6,097,839; 6,102,289; 6,102,295; 6,119,941; 6,128,414; 6,138,915;
6,149,061; 6,149,063; 6,152,370; 6,155,490; 6,158,661; 6,164,542;
6,164,545; 6,173,893; 6,195,053; 6,234,393; 6,234,395; 6,249,008;
6,328,214; 6,330,975; 6,345,765; 6,356,949; 6,367,699; 6,375,075;
6,375,076; 6,435,411; 6,484,944; 6,641,046; 6,669,087; 6,681,994;
6,688,523; 6,732,930; 6,879,428; 6,889,903; 6,974,085.

There may be other U.S. and foreign patents pending.

Before You Begin

1

Introducing the SR61T

This chapter provides an overview of the SR61T Tethered Scanner. This chapter covers these topics:

- **What is the SR61T Tethered Scanner**
- **Supported Interfaces**
- **Powering the SR61T**
- **Connecting the Interface Cable**
- **Removing the Interface Cable**
- **Accessories**

What is the SR61T Tethered Scanner

The SR61T Tethered Scanner is a small, rugged handheld scanner. The SR61T is lightweight, ergonomically designed, and it interfaces seamlessly with Intermec computers and other host computers.

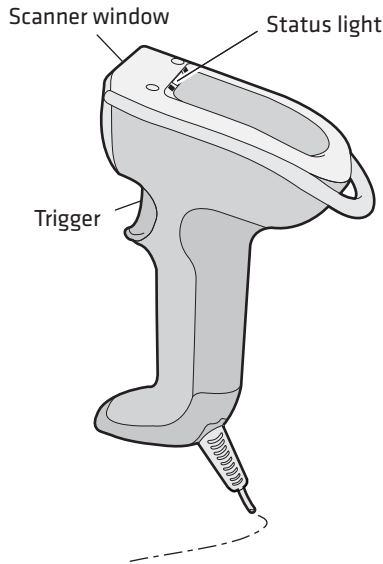

SR61T Tethered Scanner

The SR61T comes with one of these scan engine options:

- 1D linear imager—SR61T1D-xxx
- 2D area imager—SR61T2D-xxx
- Laser scanner—SR61TL-xxx
- Extra range area imager—SR61TXR-xxx
- High performance 2D area imager—SR61THP-xxx

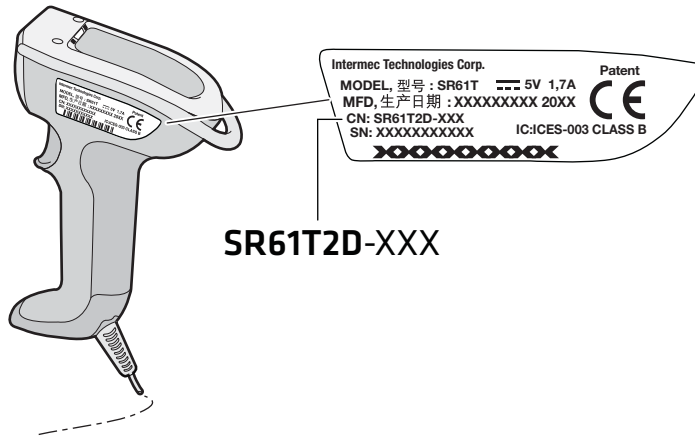

SR61T Scan Engine Option: The scan engine option of your SR61T can be found in the first part of the configuration number. In this illustration, the scan engine option is SR61T2D for 2D linear imager.

Supported Interfaces

The SR61T supports the following interfaces:

- USB—keyboard HID and virtual COM
- Standard RS-232
- Keyboard wedge/Y-Cable
- Wand emulation

Powering the SR61T

The SR61T is powered through the accessory cable that connects it to the host computer. Depending on your connection, power for the SR61T comes from either the host computer or an external power supply connected to the interface cable.

Connecting the Interface Cable

The cable you use depends on the interface and host device. However all cables are connected to the scanner in the same way.

- 1 Insert cable. Press firmly until inserted all the way.

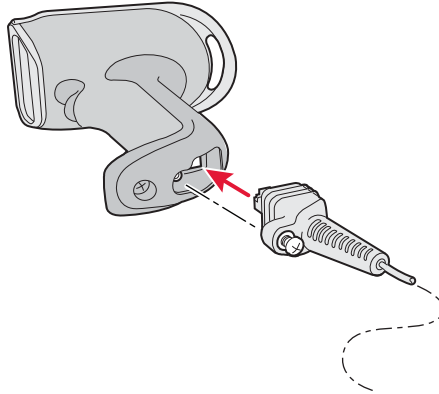

- 2 Tighten the screw on the cable to secure it.

Removing the Interface Cable

To remove the cable follow these steps:

- 1 Loosen the screw on the cable.
- 2 Pull out the cable.

Accessories

There are several different accessories available. Here you will find a list of required and optional accessories.

Required Accessories

You will need one or more of the following cables for your SR61T.

SR61T Cable List

Cable	Part Number
USB cable	236-240-xxx
USB cable with power jack	236-241-xxx
RS-232 cable (6.5 feet)	236-184-xxx
RS-232 cable (12 feet)	236-197-xxx
RS-232 cable (6.5 feet) with power jack	236-185-xxx
RS-232 cable (12 feet) with power jack	236-198-xxx
Keyboard wedge cable	236-186-xxx
Keyboard wedge cable with power jack	236-187-xxx
Keyboard wedge Y-Cable	236-214-xxx
Wand cable (10 pin industry standard)	236-189-xxx
Wand cable (10 pin)	236-188-xxx
Wand cable (9 pin)	236-190-xxx
Download cable	236-239-xxx
Universal Intermec power supply 5V	851-089-205



Note: A power cord is also needed to plug in the power supply. The power cord needed depends on your country and is sold separately.

Optional Accessories

The following accessories are optional.

Desktop Stand

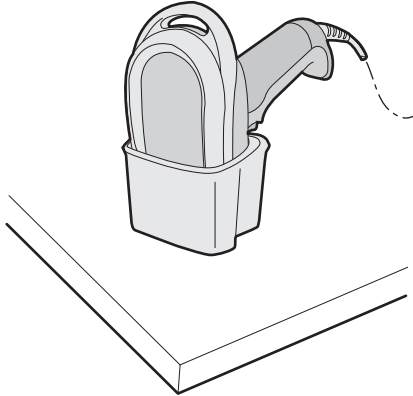

SR61T Desktop Stand (P/N 203-878-xxx): The desktop stand provides you with a convenient way to store the SR61T when you are not using it.

Hands-Free Stand

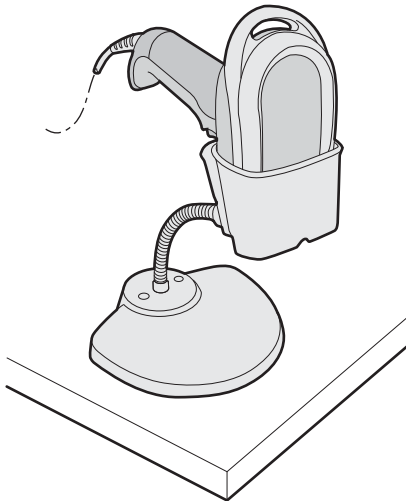

SR61T Hands-Free Stand (P/N 203-877-xxx): The hands-free stand provides you with a convenient way to store the SR61T when you are not using it or scan items without having to hold your scanner.

Wall or Vehicle Mount Holder

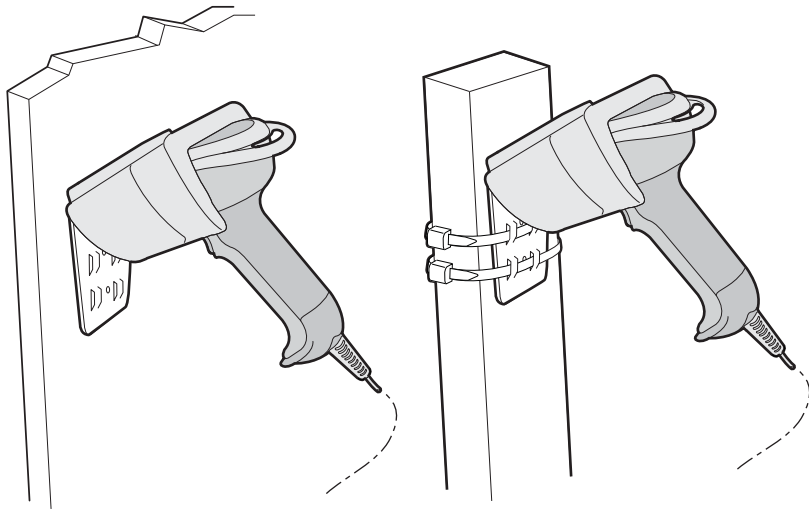

SR61T Wall or Vehicle Mount Holder (P/N 203-876-xxx): The wall or vehicle mount holder provides you with a convenient way to store the SR61T when you are not using it. You can either attach the holder to a wall with screws or attach the holder to a vehicle with tie-wraps.

2

Scanning With the SR61T

This chapter explains how to scan bar codes and includes the following sections:

- **Understanding the SR61T Behavior**
- **Scanning Bar Codes**

Understanding the SR61T Behavior

The SR61T uses lights, beeps and vibrations to indicate if a bar code has been successfully decoded. The status light and beeps described in this section are new and do not correspond to the legacy SR61T models (SR61TV, SR61TA, SR61TL or SR61TE).



Note: If you prefer to use the legacy beep and LED mode you can activate the legacy mode using EasySet. For information on using EasySet see [Chapter 4, “Configuring the SR61T” on page 31](#).

Understanding the Status Light

The status light on the SR61T flashes red or green depending on the status of the scanner.

Default Status Light Description

Light State	What it Means
Series of green flashes (USB interface only)	Power-up At power-up the status light flashes to indicate the activated USB interface: –1 flash = Keyboard HID –3 flashes = Virtual COM The status light only flashes at power up for a USB interface.
Green light on for 2 seconds	The scanner successfully decoded a bar code and sent the data to the host device.
Green light flashes 2 times	A configuration bar code was successfully read.
Red light on for 2 seconds	Transmission error OR Configuration bar code was not accepted

Understanding the Beeps

The SR61T beeps to give you audio feedback when performing some functions. For example, you hear a beep each time you scan a valid bar code.

Default SR61T Beep Descriptions

Beep Sequence	What it Means
Two beeps	Power-up
Single beep	The scanner successfully scanned a bar code.
Two fast beeps	Configuration bar code successfully scanned
Six very fast beeps	Transmission error OR Configuration bar code was not accepted

Stacked Code Crackle

When using SR61TL (laser scanner) by default the scanner makes a crackle noise when reading stacked codes (such as PDF417). For more information see EasySet.



Note: You can modify many of the default settings for the light, beeps and crackle using EasySet version 5.6.4.0 or higher. EasySet is available on the Intermec website at www.intermec.com/EasySet.

Using Vibrate Alert

You can configure the SR61T to vibrate when it successfully decodes a bar code. This feature can be useful in these situations:

- You are in a noisy environment, such as a busy warehouse, where it can be difficult to hear the beep.
- You are working in a quiet environment, such as a library, where you do not want to make a lot of noise.

To turn on vibrate alert

- Scan this bar code:

Turn On Vibrate Alert



To turn off vibrate alert

- Scan this bar code:

Turn Off Vibrate Alert



Scanning Bar Codes



For the SR61TL, SR61TXR, SR61THP and SR61T2D do not look directly into the window area or at a reflection of the laser beam or laser aiming beam while scanning. Long-term exposure to the laser beam can damage your vision.

The SR61T contains either a 1D linear imager (SR61T1D), 2D area imager (SR61T2D or SR61THP), laser scan engine (SR61TL), or near-far range area imager (SR61TXR) to scan bar code data. The type of scan engine you are using and the type of bar code you are decoding determines the way you scan the bar code.

When you unpack the SR61T, these bar code symbologies are enabled:

- Code 39
- Code 128 / GS1-128
- EAN/UPC
- PDF417 (SR61TL, SR61T2D, SR61THP and SR61TXR only)
- DataMatrix (SR61T2D, SR61THP and SR61TXR only)

If you are using bar code labels that are encoded in a different symbology, you need to enable the symbology on your SR61T. Use EasySet version 5.6.4.0 or later to enable and disable symbologies for your scanner. EasySet is available on the Intermec web site at www.intermec.com/EasySet.

To scan a bar code label with a laser scanner or 1D linear imager

- 1 Point the SR61T at the bar code label and hold the SR61T at a slight angle 15 to 25 cm (6 to 10 in) from the label.
- 2 Pull the trigger, and direct the red beam so that it falls across all bars in the bar code label.

Use this test bar code:

Code 39 Test Bar Code



123456

Tip: Depending on your screen resolution, you can scan bar codes displayed on your computer screen except when scanning with the SR61TL (laser imager). Print out and scan bar codes with the SR61TL (laser imager).

When the SR61T successfully reads a bar code label, the SR61T beeps one time, the status light briefly turns green, and the scanner beam turns off. If Vibrate Alert is enabled, the SR61T briefly vibrates.

- 3 Release the trigger.

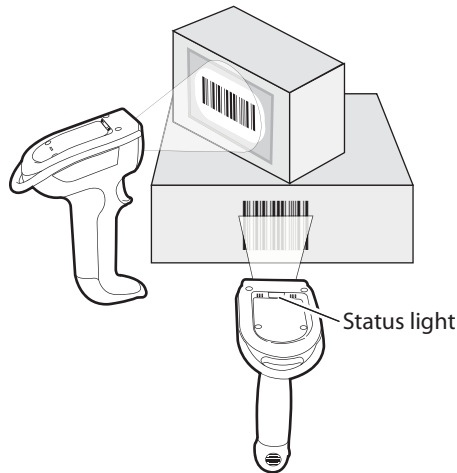

Scanning Bar Codes: The aiming and scanner beams that you see depend on which SR61T model you are using.

To scan omni-directionally with the 2D, 2D high performance or near-far range area imager

- 1** Point the scanner window at the bar code label and hold the SR61T steady a few inches from the label.
- 2** Pull the trigger.
 - If you are scanning with one of the 2D imagers, use the laser framing to position the imager over the bar code or area to capture.

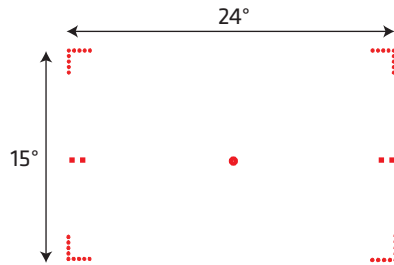

SR61T2D Laser Framing

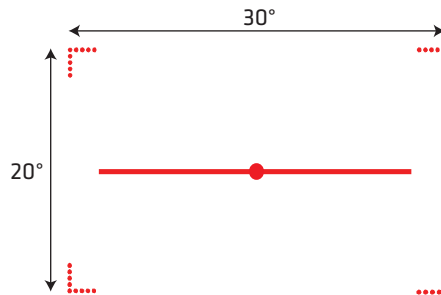

SR61THP Laser Framing

- If you are scanning with a near-far range area imager at a near distance (< 30 cm / 11.8 in), position the red aiming beam just to the right of the center of the bar code label.

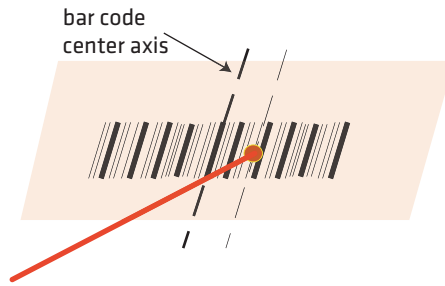

SR61TXR Aiming Beam



Note: When scanning from a far distant (> 30 cm / 11.8 in) position the red aiming beam closer to the center of the bar code.

- 3** When the SR61T successfully reads a bar code label, the SR61T beeps one time, the status light briefly turns green, and the scanner lighting turns off. If Vibrate Alert is enabled, the SR61T briefly vibrates.
- 4** Release the trigger.

Hands-Free Scanning

The SR61T is a hand-held scanner however using the Hands-Free Stand (P/N 203-877-xxx) you can also set up your scanner for scanning items without having to hold your scanner in your hand (see “**Hands-Free Stand**” on page 6. For hands-free scanning you will need to use EasySet to change the default trigger mode. See EasySet version 5.6.4.0 or higher for more information.

3

SR61T Interfaces

This chapter explains the different interfaces available with the SR61T:

- **USB Interface**
- **RS-232 Interface**
- **Keyboard Wedge/Y-Cable Interface**
- **Wand Emulation Interface**

USB Interface

The SR61T can be connected to a USB host using one of the USB cables. The SR61T is USB 2.0 and operates at full speed. Power is provided either by the host or by the external power supply connected to the USB cable. See the **“Required Accessories” on page 5** for a list of part numbers for the different cables.

Connecting a USB Cable

To connect with a USB cable

- 1 Turn off your host device.
- 2 Connect the USB cable to your SR61T and to the host.

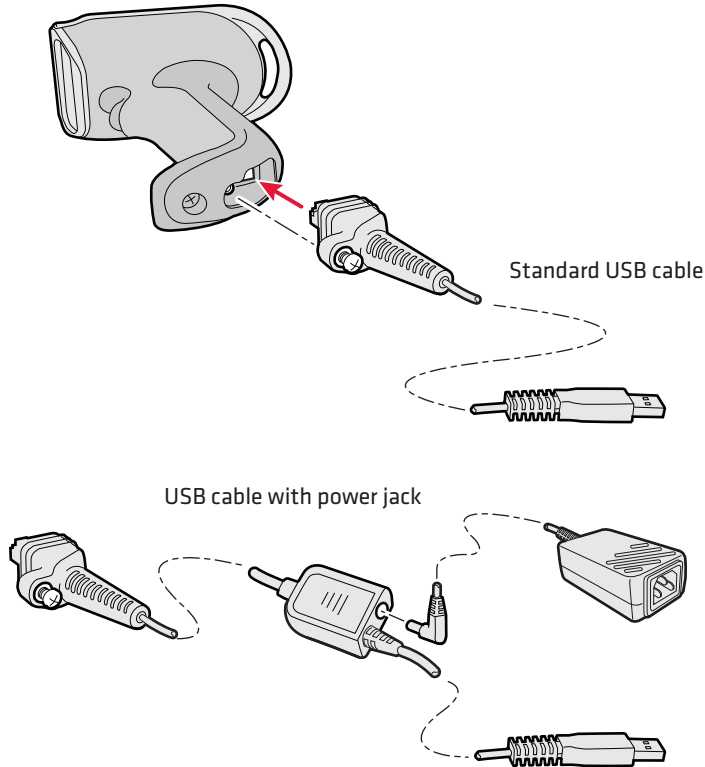

- 3 Connect the power supply to the cable and an AC power outlet if you are using the externally powered USB cable.

- 4 Turn on your host device.



Note: If you are using a non-powered USB cable, you may get a message that the host does not provide enough power. For example when you connect the USB cable to a keyboard hub or if there are other USB devices connected. In this case use a different hub or disconnect other USB devices. Otherwise use a powered USB cable.

- 5 If necessary, use the configuration bar codes in the next section to configure your SR61T for an International keyboard. The default keyboard is North America.

Setting up the USB Interface

This section provides configuration bar codes for a basic USB interface setup. All bar codes marked with (*) indicate the default value. For more configuration options see [Chapter 4, "Configuring the SR61T" on page 31](#).

International Keyboard

By default the SR61T uses the keyboard HID USB cable mode. Use these configuration bar codes to select the keyboard for your country. For additional keyboards see EasySet.

North American Windows (*)



French Windows



French Canadian Windows 95/98



French Canadian Windows XP/2000



Chapter 3 – SR61T Interfaces

German Windows



Spanish Windows



Italian Windows



Swedish Windows



UK English Windows



Japanese Windows



Brazilian Portuguese Windows



Czech Republic Windows



Slovakian Windows



Hungarian 101-Key



USB Cable Mode

By default the USB cable mode is set to keyboard HID. However you can also set up your scanner to use the virtual COM USB cable mode.

USB Keyboard HID (*)



USB Virtual COM



For a first time setup when using the virtual COM USB cable mode you will need to download and install the driver (IntermecVCOM.inf). You can download the driver from Knowledge Central on the Intermec website.

To download the USB virtual COM driver:

- 1 Go to <http://intermec.custhelp.com>.
- 2 Click on the **Find Answers** tab.
- 3 Type “12516” in the **Search by Keyword** field and click on the **Search** button or press Enter on your keyboard.
- 4 Open the Technical Bulletin and download the IntermecVCOM.ZIP file to your PC. Extract the file to your PC.

When you connect your scanner in virtual COM USB cable mode for the first time you will be prompted to install the driver.

To install the USB driver (IntermecVCOM.inf file)

- 1 Windows informs you that it has found new hardware. Select **No, not at this time** then click **Next**.



- 2 On the next screen, select **Install from a list or specific location (Advanced)**. Click **Next**.

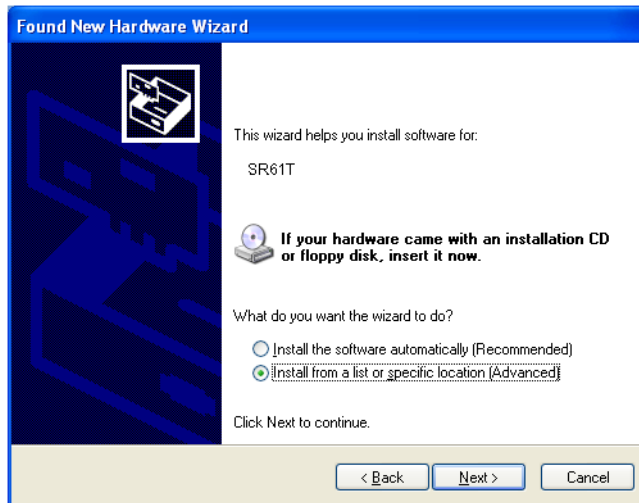

- 3 Use the **Browse** button to find the IntermecVCOM.inf file. Click **Next**.

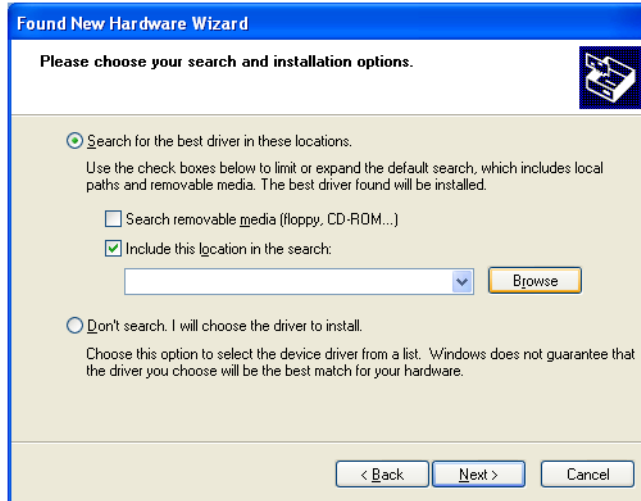

- 4 Windows informs you that this software has not passed Windows testing. Click **Continue Anyway**.
- 5 Click **Finish** and the install is complete.

To test that the install is successful, press the trigger. If the scanner turns on (lighting on) the install is successful.

RS-232 Interface

The SR61T can be connected to a host using one of the RS-232 cables. Power is provided either by the host or by the external power supply connected to the RS-232 cable. See the **“Required Accessories”** on [page 5](#) for a list of part numbers for the different cables.

Connecting an RS-232 Cable

To connect with an RS-232 cable

- 1 Turn off your host device.
- 2 Connect the RS-232 cable to your SR61T and the host.

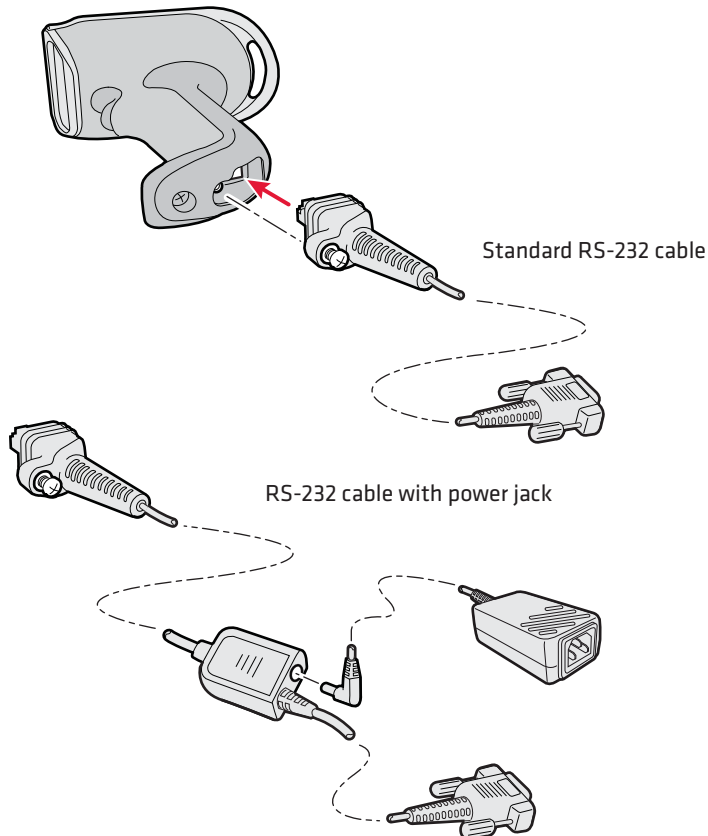

- 3 Connect the power supply to the cable and an AC power outlet if you are using the externally powered RS-232 cable.

- 4 Turn on the host device.
- 5 If necessary, use the configuration bar codes in the next section to configure your SR61T serial parameters to match the PC.

The default serial parameters for the SR61T are:

Serial Parameter	Default Setting
Baud rate	57600
Data bits	8
Parity	None
Stop bits	1

Setting up the RS-232 Interface

This section provides configuration bar codes for a basic setup. All bar codes marked with (*) indicate the default value. For more configuration options see [Chapter 4, "Configuring the SR61T" on page 31](#).

Baud Rate

38400



57600 (*)



115200



128000



230400



256000



460800



Data Bits

7



8 (*)



Parity

None (*)



Even



Odd



Stop Bits

1 (*)



2



Keyboard Wedge/Y-Cable Interface

The SR61T can be connected to a host using a keyboard wedge or Y-cable. Power is provided either by the host or by the external power supply connected to the cable. See the **“Required Accessories”** on [page 5](#) for a list of part numbers for the different cables

Connecting a Keyboard Wedge or Y-Cable

To connect with a keyboard wedge cable

- 1 Turn off your host device.
- 2 Connect the keyboard wedge cable to your SR61T and the host.

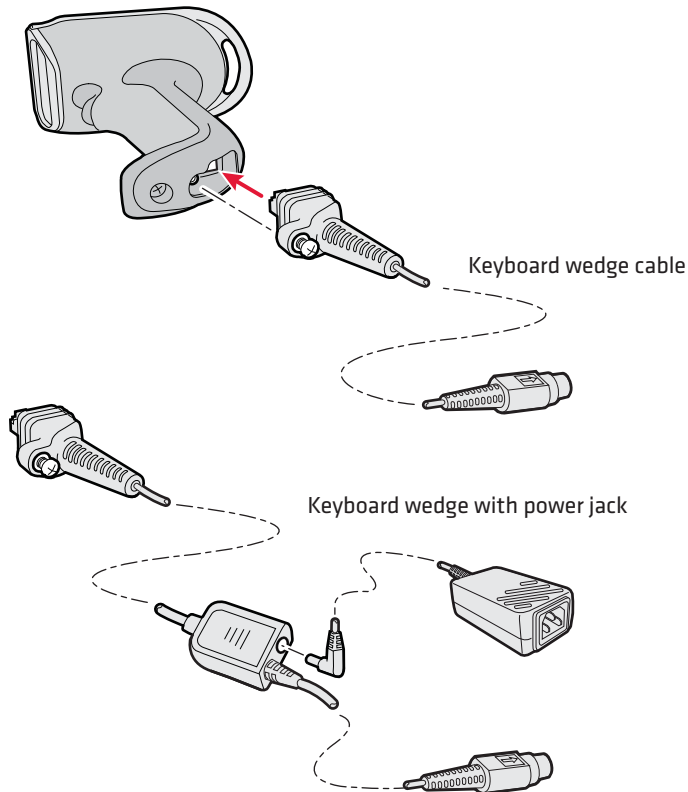

- 3 Connect the power supply to the cable and an AC power outlet if you are using the externally powered keyboard wedge cable.

- 4 Turn on your host device.
- 5 If necessary, configure your SR61T for an International keyboard (see **“International Keyboard” on page 19**). The default keyboard is North America.

To connect with a Y-cable

- 1 Turn off your host device.
- 2 Connect the Y-cable to your SR61T.

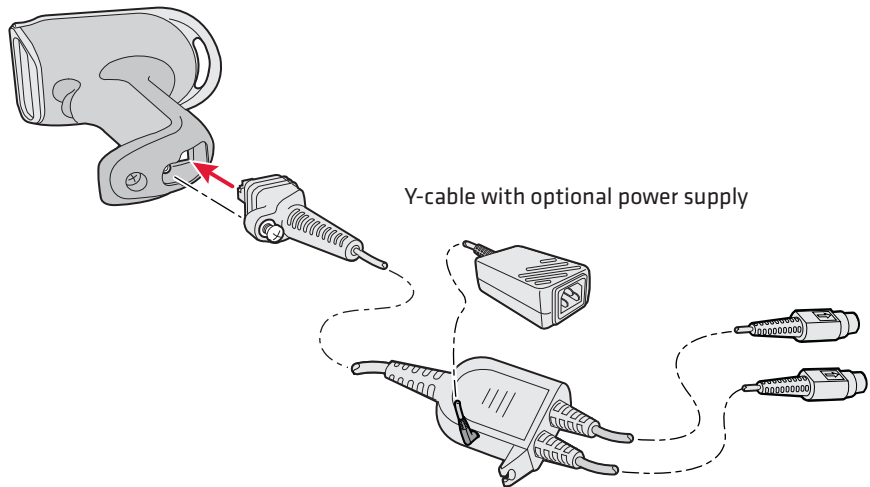

- 3 Connect one end of the Y-cable to your host device and the other end to a PS2 keyboard. If your host device does not provide enough power, connect the power supply to the Y-cable and an AC power outlet.
- 4 Turn on your host device.
- 5 If necessary, configure your SR61T for an International keyboard (see **“International Keyboard” on page 19**). The default keyboard is North America.

Wand Emulation Interface

The SR61T can be connected to a host using a wand emulation cable. See the **“Required Accessories” on page 5** for a list of part numbers for the different cables. The type of cable depends on the host device or intermec computer you are using. No power supply is necessary.



Note: You can connect the following Intermec computers using a wand emulation cable: 2420, 2425, 2435, 2455, 2475, 2480, 2481, 2485, 2486.

Connecting a Wand Emulation Cable

To create a wand emulation connection

- 1 Turn off your host device or Intermec computer.
- 2 Connect the wand emulation cable to your SR61T and the host or Intermec computer.
- 3 If necessary, use the configuration bar codes in the next section to configure your SR61T for wand emulation interface.

Setting up the Wand Emulation Interface

This section provides configuration bar codes for a basic setup. All bar codes marked with (*) indicate the default value. For more configuration options see **Chapter 4, “Configuring the SR61T” on page 31**.

Logical Signal State During Transmission

Bar = 0, Space = 1 (*)



Bar = 1, Space = 0



Note: When using a wand emulation connection the postamble and preamble are not available.

4

Configuring the SR61T

This chapter provides some basic configuration bar codes and information on how to configure the SR61T using the EasySet configuration application. This chapter includes:

- **Basic Setup with Configuration Bar Codes**
- **Configuring Your Scanner with EasySet**

Basic Setup with Configuration Bar Codes

This chapter provides you with configuration bar codes for a basic setup. For more configuration options, use EasySet (see [“Configuring Your Scanner with EasySet” on page 33](#)).

Resetting Your Scanner

To reset your scanner, read the reset factory defaults configuration bar code.

Reset factory defaults



Configuring Predefined Imager Modes

When using an SR61T2D, SR61THP or SR61TXR, you can configure predefined imager modes according to the types of bar codes you want to read. Use the following configuration bar codes to enable one of the predefined imager modes.

1D bar codes only



Standard 1D and 2D bar codes



Configuring the Postamble

The default postamble is <CR> <LF>. For certain applications or when using USB Keyboard HID you may need to change this setting. Use the following configuration bar codes to change the default postamble in your scanner.

Carriage Return + Line Feed (*)



None



Carriage Return



Enter



Configuring Your Scanner with EasySet

EasySet is an Intermec configuration application that provides you with two ways to configure your scanner.

- Online setup—send configuration commands from EasySet directly to the product.
- Offline setup—send configuration commands to a bar code setup sheet, print the setup sheet and use a connected scanner to scan the bar codes.

EasySet is available on the Intermec website at www.intermec.com/EasySet. Simply download and install.

Online Setup with EasySet

Online setup with EasySet is only available if you are using an RS-232 cable or a USB cable.

To configure your scanner online by sending commands from EasySet

- 1 Connect the scanner to a host PC using an RS-232 or USB cable and set connection parameters if necessary.
- 2 Start EasySet. The first time you start EasySet, the Select product dialog box appears.

If the Select product dialog box does not appear, choose **Product > Select** or click on the product icon in the upper left corner.

- 3 Select your product.

- 4** Select **Communication > Select Communication Interface**. The Communication Interface dialog box appears.
- 5** Select the communication interface that you are using for your scanner and click **OK**.
- 6** For RS-232 or USB Virtual Com interface: The **Connection Parameters** dialog box appears. Select the COM port then click **Apply**.



Note: You can find the COM port by opening the Windows **Device Manager** (Open the Windows **Control Panel** and click on **System**. Click on the **Hardware** tab and then click on the **Device Manager** button.). The Intermec Virtual COM port is listed under **Ports (COM & LPT)**.

For USB Keyboard HID interface: The **Online setup** dialog box appears. Select your device and click **OK**.

- 7** EasySet connects to your scanner and retrieves the current configuration. These configurations are indicated with a blue check mark or blue text. Open the folders to find the configuration commands needed. Double click each command to send it to the scanner.



Note: The scanner does not beep when you send configuration commands online from EasySet.

Offline Setup with EasySet

To configure your scanner offline by scanning bar codes

- 1** Start EasySet. The first time you start EasySet, the Select product dialog box appears.
If the Select product dialog box does not appear, choose **Product > Select** or click on the product icon in the upper left corner.
- 2** Select your product.
- 3** Open the folders to find the configuration commands needed.
Double-click each command to send each command to the setup sheet.
- 4** Click on the Word icon to export the setup sheet to Microsoft Word. Print out the setup sheet and scan the commands.

5

Troubleshooting and Maintaining the SR61T

Use this chapter to solve problems you may have while using the SR61T. This chapter contains these topics:

- **Troubleshooting the SR61T**
- **Maintaining the SR61T**

Troubleshooting the SR61T

If you have problems using the SR61T, use this chapter to find a possible solution.

Calling Product Support

To talk to an Intermec Product Support representative:

- In the U.S.A. and Canada, call **1-800-755-5505**
- Outside the U.S.A. and Canada, contact your local Intermec representative. For help, go to www.intermec.com > **About Us** > **Contact Us**.

Before you call Intermec Product Support, make sure you have the following information:

- SR61T firmware version
- SR61T decode version
- SR61T sub-system version

To get the firmware version, decode version, and sub-system version

- 1 Run an application that can accept bar code information from the SR61T:
 - If you are using a USB Keyboard HID or keyboard wedge interface, use Microsoft® Notepad.
 - If you are using an RS-232 or USB Virtual Com interface, use the EasySet ISCP Terminal window. For help, see the EasySet software.

- 2 Scan one of these bar codes:

Get firmware version



Get decode version



Get sub-system version





Problems and Possible Solutions

Use this section to find possible solutions to problems you may have.

Problems and Possible Solutions

Problem	Possible Solution
You pull the trigger, but nothing happens.	The SR61T receives power from either a host or an external power supply through an accessory cable. Make sure: <ul style="list-style-type: none">• You are using the appropriate cable. For more information, see “Required Accessories” on page 5.• The cable is connected to the appropriate port on the host computer.• The universal power supply (if necessary) is properly plugged in.
You pull the trigger, the red scanning beam turns on, but you cannot successfully scan a bar code.	Try these possible solutions: <ul style="list-style-type: none">• Make sure that the SR61T is configured for the symbology you are scanning.• Make sure that the SR61T is at the appropriate scanning distance from the bar code. Move the SR61T closer and farther away to find the appropriate distance.• Make sure that the SR61T is configured for the type (1D, 2D, etc.) of bar code you are scanning.• The bar code you are trying to scan may be poorly printed or too small. Scan a known good bar code to make sure that the SR61T is working properly. For more information, see “Scanning Bar Codes” on page 13 .

Problems and Possible Solutions (continued)

Problem	Possible Solution
You scan a bar code and the status light turns on, but the SR61T does not beep.	The beep duration, volume, frequency, and number may be configured so the SR61T does not beep. To reset the SR61T, scan this bar code: Reset factory defaults 
You scan a configuration bar code and the SR61T beeps six very fast beeps.	The SR61T does not recognize or support the configuration bar code you scanned.
You scan a bar code, the SR61T beeps once, and the status light blinks green once, but the data is not transmitted to the host computer.	Try these possible solutions: <ul style="list-style-type: none">• Make sure that your data collection application is set up to receive data from the SR61T.• If you are using an RS-232 cable, make sure that the serial parameters on the SR61T match the serial parameters of the host computer. The default serial parameters for the SR61T are: 57600 baud, 8 data bits, no parity, and 1 stop bit.
You cannot scan the Firmware upgrade bar code on your computer screen.	Print out this bar code and scan it: Firmware upgrade 

Maintaining the SR61T

To keep your SR61T in good working order, you may need to upgrade the SR61T firmware and clean the scanner window.

Upgrading the SR61T

You may need to upgrade the SR61T firmware if there is an update that incorporates changes to a feature or adds functionality to the scanner. When you upgrade your scanner the current settings are erased and replaced with the default settings. The process of upgrading the SR61T takes about 10 minutes to complete.

To upgrade the SR61T you need:

- An RS-232, USB, or download cable. For more information on cables, see **“Required Accessories” on page 5**.
- Minimum PC operating system requirements are Microsoft® Windows® XP with SP2 or Microsoft Windows 2000 with SP4 or higher versions.
- EasySet version 5.6.4.0 or later with WinFlash version 3.1.1.1 or later.
- The firmware update file (.bin).



Note: Before you start the upgrade process, make sure that you are not using the selected COM port for any other application or you receive an error and cannot use the COM port.

To upgrade the SR61T firmware

- 1 Download the latest SR61T firmware update package from the Intermec web site at www.intermec.com.
 - a Go to **Support > Downloads**.
 - b From the **Product Category** drop-down list, choose **Bar Code Scanners**.
 - c From the **Product Family** drop-down list, choose **Tethered**.
 - d From the **Product** drop-down list, choose **SR61T Hand Held Scanner** and click **Submit**.

- e Click the link to download the firmware upgrade package and save it to your PC.
 - f Unzip the .zip file.
- 2** Connect your SR61T to a host PC with the appropriate cable



Note: If using a USB cable, you must use the USB Virtual Com USB cable mode. See **“USB Cable Mode” on page 21.**

- 3** Scan the Reset Factory Defaults bar code:

Reset factory defaults



- 4** Start EasySet version 5.6.4.0 or later.
- 5** From the **Tools** menu, select **Upgrade product firmware** to start WinFlash version 3.1.1.1 or later.
- 6** If WinFlash is not already installed you will be asked to install it. Click **Yes** and following the installation instructions. After installing Winflash, start WinFlash from the **Tools** menu, select **Upgrade product firmware.**

7 Select the cable and click **Next**.

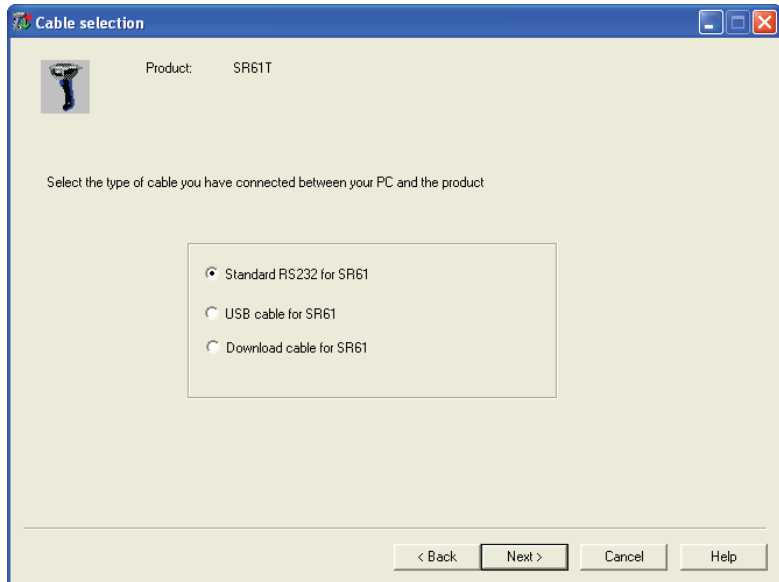

8 Use **Browse** to browse to the location of the firmware upgrade file (.bin), select the file, and click **Open**. Click **Next**.

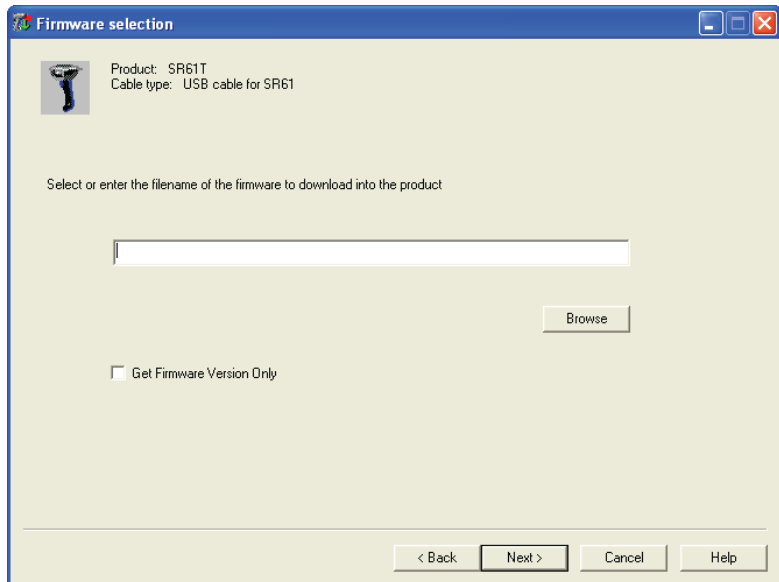

- 9 For USB cables only, scan the **Firmware upgrade** bar code that appears on the screen then click **OK**. For other cables, go directly to the next step.



Note: If your scanner cannot scan the bar code on your computer screen see **“Problems and Possible Solutions” on page 39** to find the firmware upgrade bar code. Print the page out and scan the bar code.

- 10 Select the Com port and parameters (if necessary) and deselect the **Display help** check box. Click **Next**.



Note: You can find the COM port by opening the Windows **Device Manager** (Open the Windows **Control Panel** and click on **System**. Click on the **Hardware** tab and then click on the **Device Manager** button.). The Intermec Virtual COM port is listed under **Ports (COM & LPT)**.

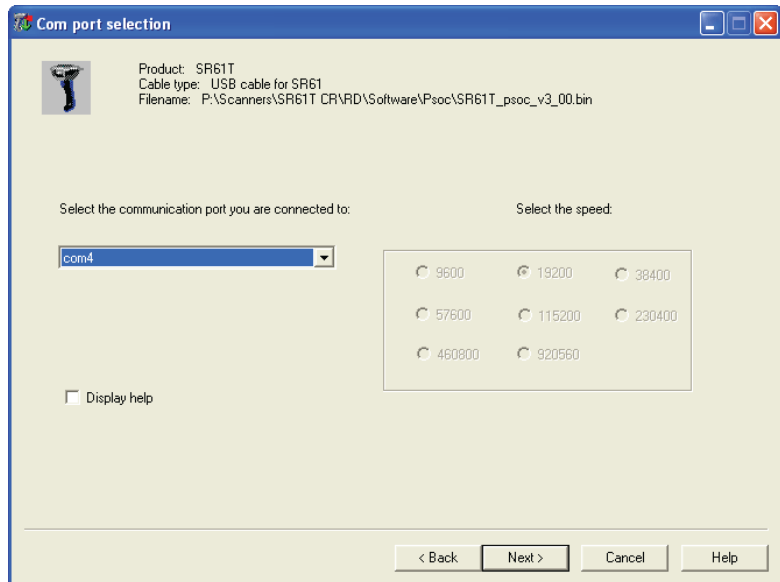

- 11 Click **Start download**.

For RS-232 cables only, scan the **Firmware upgrade** bar code that appears on the screen and click **OK**.



Note: If your scanner cannot scan the bar code on your computer screen see **“Problems and Possible Solutions” on page 39** to find the firmware upgrade bar code. Print the page out and scan the bar code.

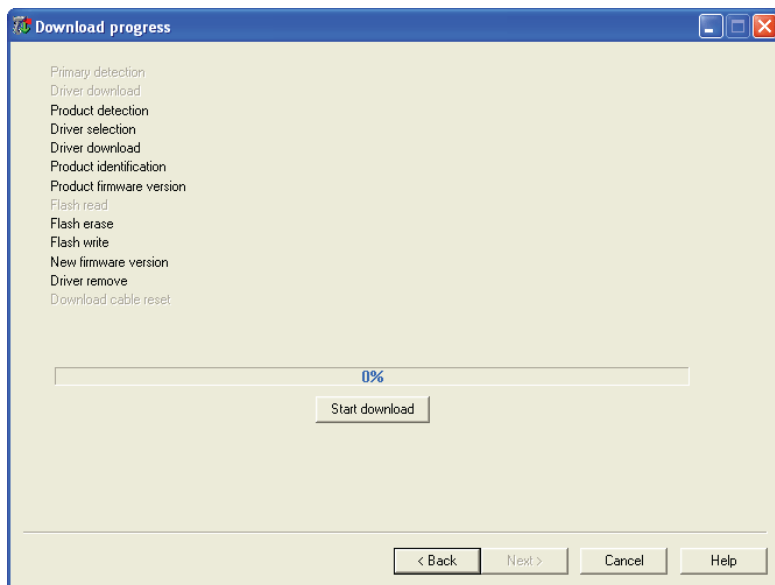

When the firmware download is complete, the “Operation successful” message appears.

- 12 Click **Finish**. You have successfully upgraded your scanner firmware.



Note: If the firmware download is not successful, you must restart the firmware download procedure.

Scanner Recovery

If something happens to your scanner and it does not turn on despite using the correct cables and power supply, the only way to recover the scanner is to reinstall the firmware. This is only possible when using the download cable (see **“Required Accessories” on page 5**). Follow the instructions for upgrading the firmware in this chapter.

Cleaning the SR61T

Clean the scanner window as often as needed for the environment in which you are using the SR61T. To clean the scanner window, you can use soapy water, a solution of ammonia and water, or isopropyl alcohol.



Caution

Opening the SR61T voids the warranty and may cause damage to the internal components.

To clean the scanner window

- 1** Dip a clean towel or rag in soapy water, ammonia and water solution, or isopropyl alcohol and wring out the excess. Wipe the scanner window. Do not allow any abrasive material to touch the window.
- 2** Wipe dry with a lint-free cloth.

A

Specifications and Reading Distances

This appendix contains the technical specifications and reading distances for each scanner model.

Specifications

Use this section to find technical information about the SR61T

Physical Dimensions

Length	19.4 cm (7.6 in)
Height	13.1 cm (5.2 in)
Width	7.2 cm (2.8)
Weight	320 g (11.2 oz)

Electrical Specifications

Electrical rating	≡ 5V, 1.7A
-------------------	------------

Typical Power Consumption (5V power supply, ambient lighting, continuous scanning)

SR61T1D	RS-232 = 126 mA
	USB = 124 mA
SR61TL	RS-232 = 80 mA
	USB = 89 mA
SR61T2D	RS-232 = 246 mA
	USB = 242 mA
SR61THP	RS-232 = 307 mA
	USB = 298 mA
SR61TXR	RS-232 = 321 mA
	USB = 317 mA

Interfaces

RS-232, USB, Keyboard Wedge, Wand Emulation

Temperature and Environmental Specifications

Operating	-20°C to 50°C (-4°F to 122°F) @ 3.3V
Storage	-40°C to 70°C (-40°F to 158°F)
Relative humidity	5 to 95% non-condensing
Shock	2000G, half sinus, 0.7 ms, 6 directions
Vibrations	8G, from 10Hz to 500Hz, 2hr/axis, 3 axes
Environmental rating	IP54
Ambient light	0 to 100 000 lux

Scanning Performance

SR61T1D	Scan angle: 40° Minimum X dimension: 4 mils (0.1 mm)
SR61TL	Scan angle: 38° Min. X dimension: 4 mils
SR61T2D	Scan angles: 26° horizontal, 16.8° vertical Framing angles: 24° horizontal, 15° vertical Min. X dimension 1D: 6 mils Min. X dimension 2D: 7 mils
SR61THP	Scan angles: 34.4° horizontal, 22.2° vertical Framing angles: 30° horizontal, 20° vertical Min. X dimension 1D: 4 mils Min. X dimension 2D: 6.6 mils
SR61TXR	Scan angles: 14° horizontal, 8.7° vertical, 16.4° diagonal Min. X dimension 1D: 3 mils Min. X dimension 2D: 6.8 mils

Bar Code Symbolologies for 2D Models (SR61T2D, SR61THP and SR61TXR)

Australian Post	Infomail
Aztec	Intelligent mail
BPO	Interleaved 2 of 5

Appendix – Specifications and Reading Distances

Bar Code Symbolologies for 2D Models (SR61T2D, SR61THP and SR61TXR)

Canada Post	Japan Post
Codabar	Matrix 2 of 5
Codablock A	Maxicode
Codablock F	Micro PDF417
Code 11	MSI
Code 39	Muticode
Code 93/93i	PDF417
Code 128 / GS1-128	Planet
DataMatrix	Plessey
Dutch Post	Postnet
EAN/UPC	QR Code
GS1 Composite	Standard 2 of 5
GS1 DataBar Expanded	Sweden Post
GS1 DataBar Limited	Telepen
GS1 DataBar Omni-Directional	TLC 39
GS1 DataBar Stacked	PDF417

Bar Code Symbolologies for 1D Models (SR61T1D and SR61TL)

Codabar	GS1 DataBar Omni-Directional*
Codablock A*	GS1 DataBar Stacked*
Codablock F*	Interleaved 2 of 5
Code 11	Matrix 2 of 5
Code 39	Micro PDF417*
Code 93/93i	MSI
Code 128 / GS1-128	PDF417*
EAN/UPC	Plessey
GS1 Composite*	Standard 2 of 5
GS1 DataBar Expanded*	Telepen
GS1 DataBar Limited*	TLC 39

* = These symbolologies are only available with SR61TL (laser scanner).

Reading Distances

The reading distances for each scanner are typical distances measured in an office environment (200 lux).

SR61T1D

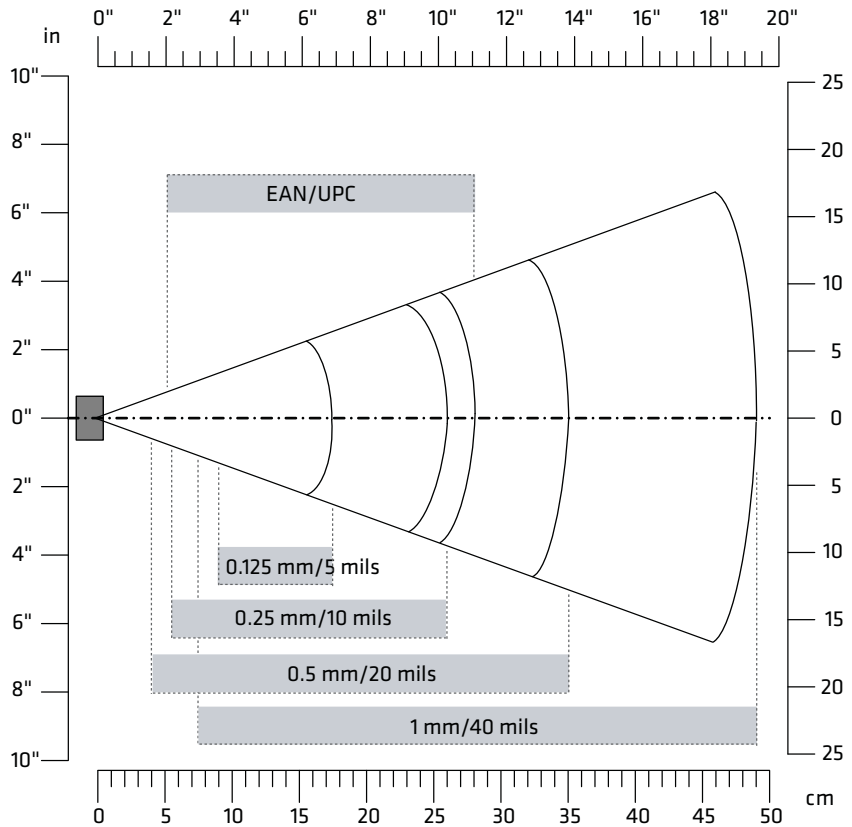

Symbology	Density	Minimum Distance	Maximum Distance
Code 39	0.1 mm (3.8 mils)	10 cm (3.94 in)	14 cm (5.51 in)
	0.125 mm (5 mils)	9 cm (3.54 in)	17.5 cm (6.89 in)
	0.25 mm (10 mils)	5.5 cm (2.17 in)	26 cm (10.24 in)
	0.5 mm (20 mils)	4 cm (1.57 in)	35 cm (13.78 in)
	1 mm (40 mils)	7.5 cm (2.95 in)	49 cm (19.29 in)
EAN/UPC	0.33 mm (13 mils)	5.2 cm (2.05 in)	28.5 cm (11.22 in)

SR61TL

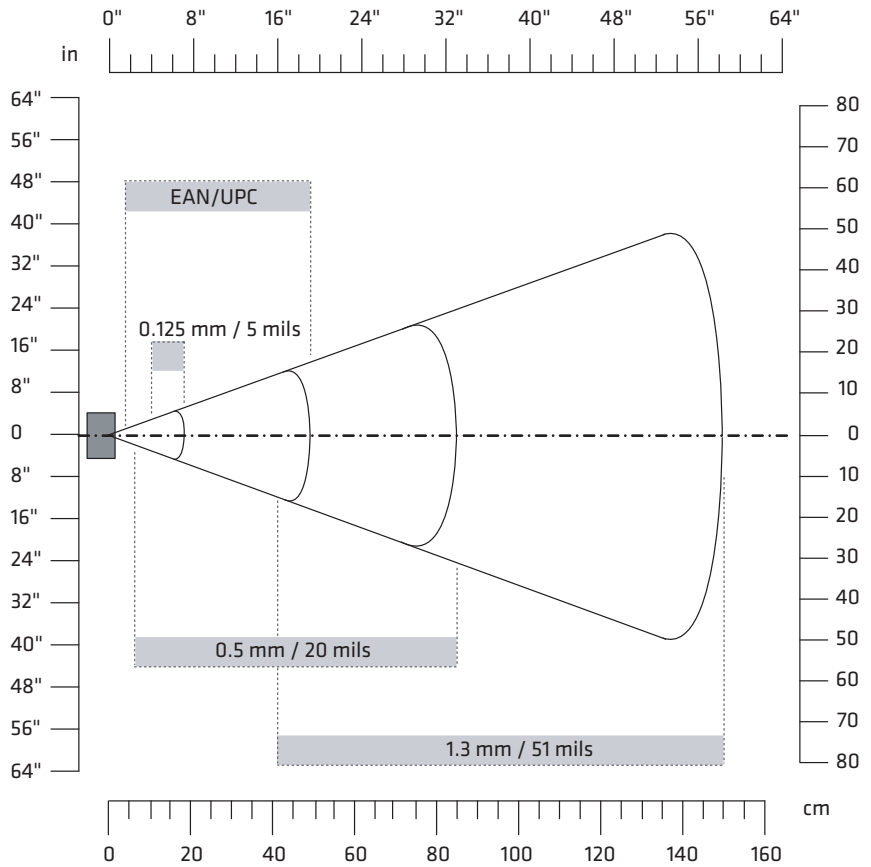

Symbology	Density	Minimum Distance	Maximum Distance
Code 39	0.125 mm (5 mils)	10 cm (3.94 in)	19.5 cm (7.68 in)
	0.5 mm (20 mils)	6 cm (2.36 in)	85 cm (33.46 in)
	1.3 mm (51 mils)	41* cm (16.14 in)	150 cm (59.1 in)
EAN/UPC	0.33 mm (13 mils)	4.5 cm (1.77 in)	49 cm (19.29 in)

*Depends on symbology length and scan angle.

SR61T2D

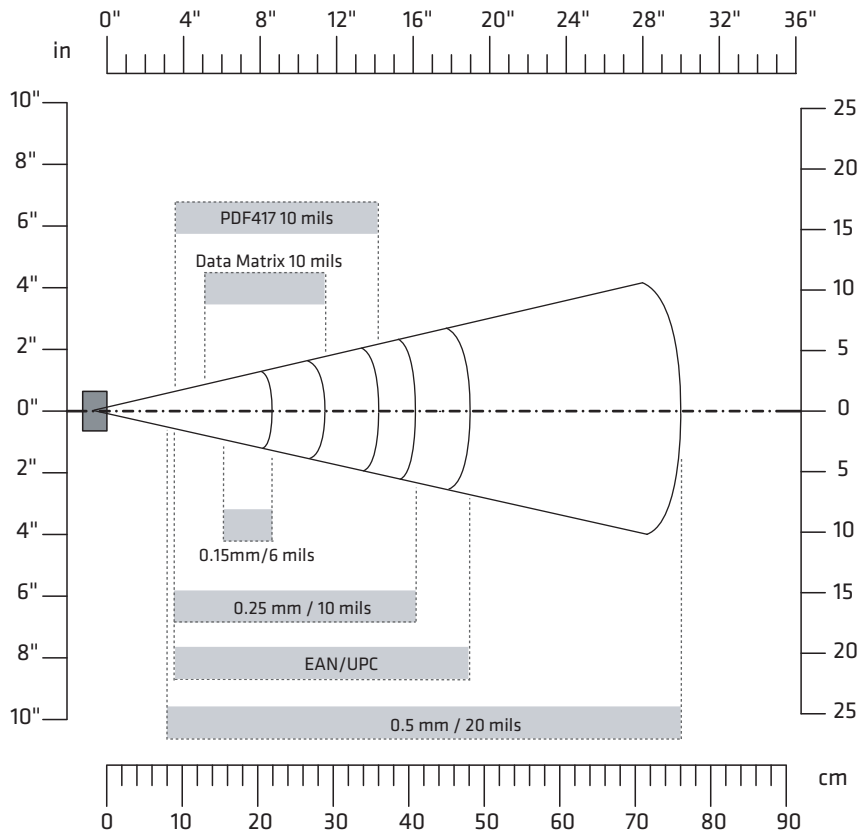

Symbology	Density	Minimum Distance	Maximum Distance
Code 39	0.15 mm (6 mils)	15.5 cm (6.10 in)	22 cm (8.66 in)
	0.2 mm (8 mils)	11.5 cm (4.53 in)	31 cm (12.20 in)
	0.25 mm (10 mils)	9 cm (3.54 in)	41 cm (16.14 in)
	0.5 mm (20 mils)	8 cm (3.15 in)	76 cm (29.92 in)
	1 mm (40 mils)	13 cm 5.12 in)	120 cm (47.24 in)
EAN/UPC	0.33 mm (13 mils)	9 cm (3.54 in)	48 cm (18.9 in)
	0.38 (15 mils)	10 cm (3.94 in)	52 cm (20.47 in)
PDF417	0.17 mm (6.6 mils)	14.5 cm (5.71 in)	22 cm (8.66 in)
	0.25 mm (10 mils)	9 cm (3.54 in)	36 cm (14.17 in)
	0.38 (15 mils)	10 cm (3.94 in)	52 cm (20.47 in)
DataMatrix	.025 mm (10 mils)	13 cm (5.12 in)	29 cm (11.42 in)

SR61THP

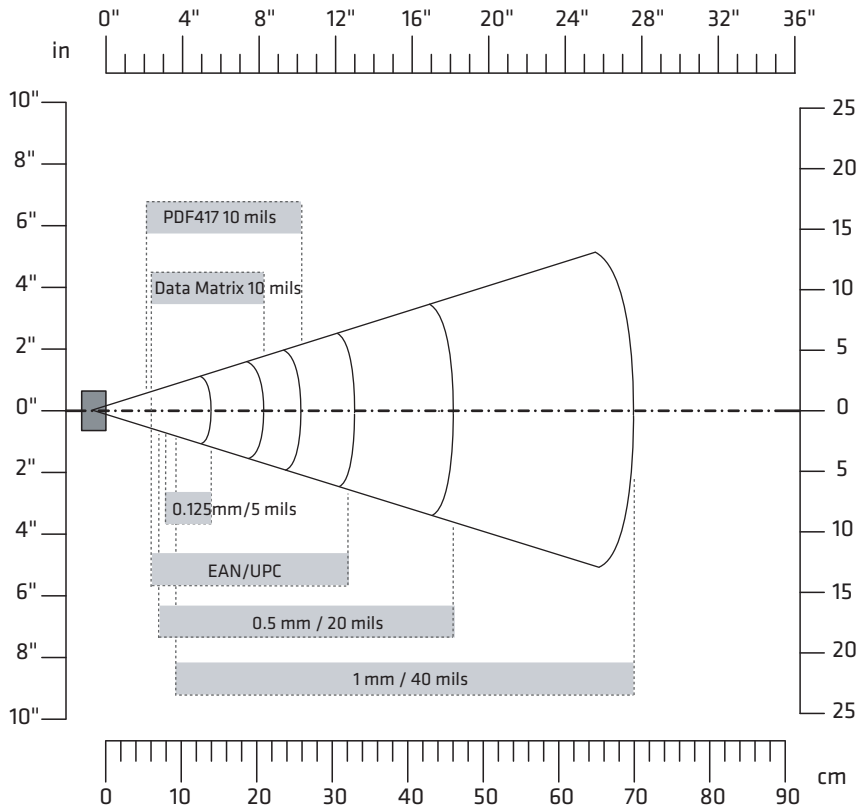

Symbology	Density	Minimum Distance	Maximum Distance
Code 39	0.125 mm (5 mils)	8 cm (3.15 in)	14 cm (5.51 in)
	0.5 mm (20 mils)	7 cm (2.76 in)	46 cm (18.11 in)
	1mm (40 mils)	9.5 cm (3.74 in)	70 cm (27.56 in)
EAN/UPC	0.33 mm (13 mils)	6 cm (2.36 in)	32 cm (12.6 in)
PDF417	0.25 mm (10 mils)	5.5 cm (2.17 in)	26 cm (10.24 in)
	0.38 (15 mils)	6.5 cm (2.56 in)	36 cm (14.17 in)
DataMatrix	.025 mm (10 mils)	6 cm (2.36 in)	21 cm (8.27 in)

SR61TXR

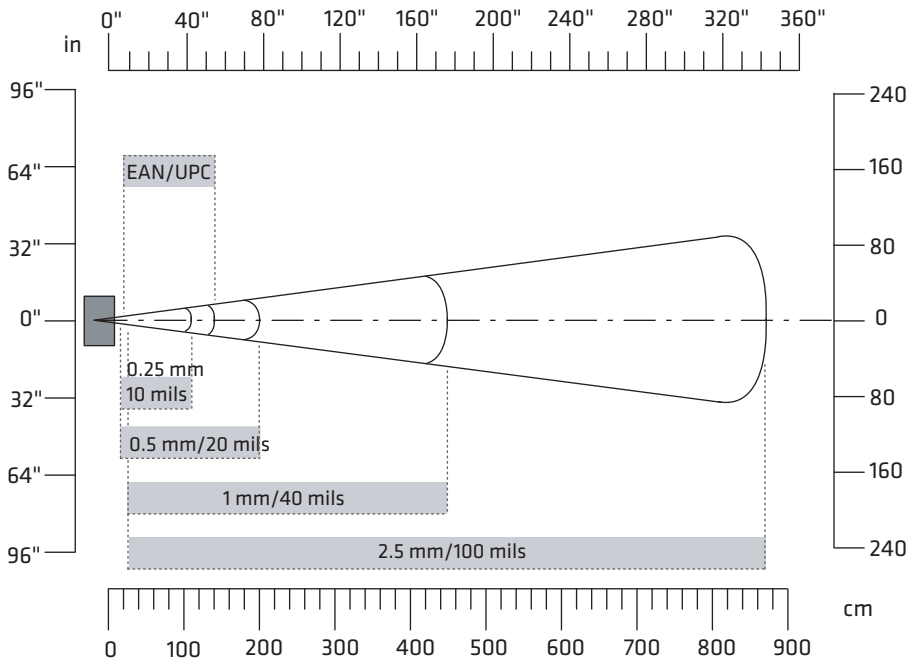

Symbology	Density	Minimum Distance	Maximum Distance
Code 39	0.25 mm (10 mils)	16 cm (6.3 in)	110 cm (3.6 ft)
	0.5 mm (20 mils)	16 cm (6.3 in)	200 cm (6.6 ft)
	1 mm (40 mils)	* cm	450 cm (15 ft)
	1.3 mm (51 mils)	* cm	600 cm (20 ft)
	2.5 mm (100 mils)	* cm	870 cm (28.5 ft)
EAN 100%	0.33 mm	20 cm (7.87 in)	140 cm (4.6 ft)
DataMatrix	0.25 mm (10 mils)	16 cm	80 cm (2.6 ft)
	1.4 mm (55 mils)	* cm	400 cm (13.1 ft)
	2.5 mm (100 mils)	* cm	800 cm (26.2 ft)

*Depends on symbology length and scan angle.

Appendix – Specifications and Reading Distances



Worldwide Headquarters
6001 36th Avenue West
Everett, Washington 98203
U.S.A.

tel 425.348.2600

fax 425.355.9551

www.intermec.com

© 2010 Intermec Technologies
Corporation. All rights reserved.

SR61T Tethered Scanner User's Guide



P/N 934-024-003