

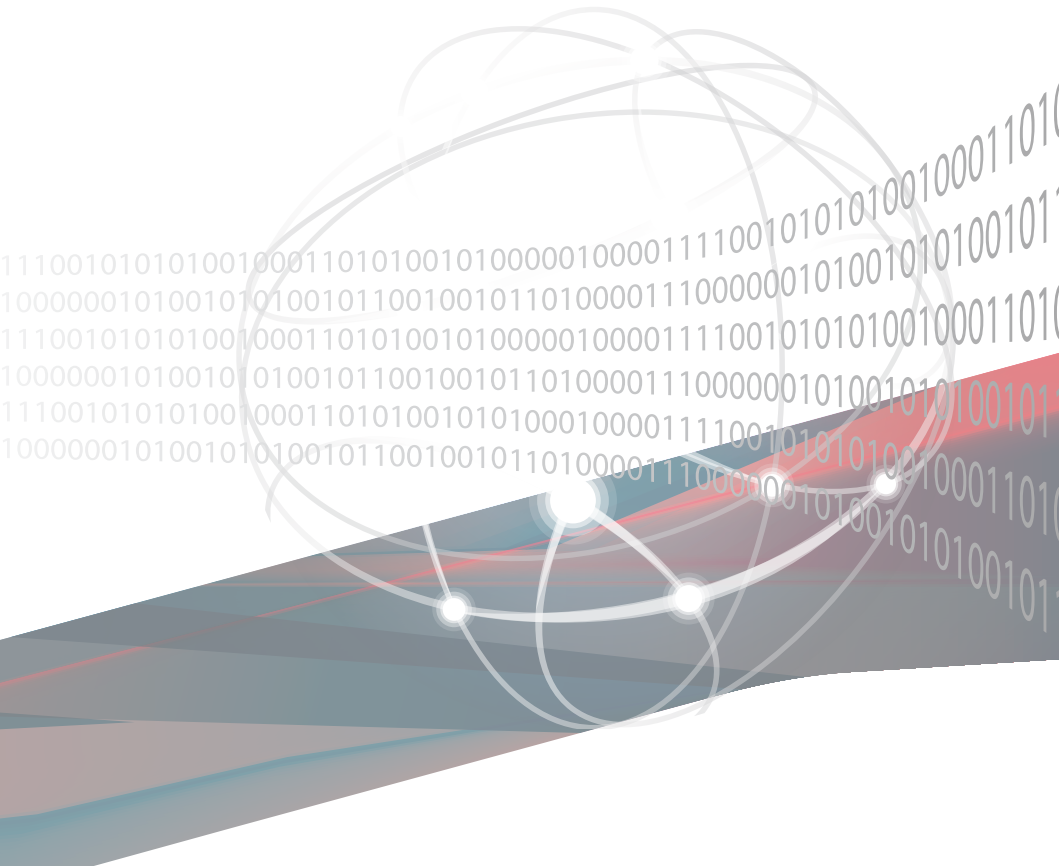

RS720Q-E8-RS8-P

2U Rackmount Server User Guide



E10353
First Edition
April 2015

Copyright © 2015 ASUSTeK COMPUTER INC. All Rights Reserved.

No part of this manual, including the products and software described in it, may be reproduced, transmitted, transcribed, stored in a retrieval system, or translated into any language in any form or by any means, except documentation kept by the purchaser for backup purposes, without the express written permission of ASUSTeK COMPUTER INC. ("ASUS").

ASUS provides this manual "as is" without warranty of any kind, either express or implied, including but not limited to the implied warranties or conditions of merchantability or fitness for a particular purpose. In no event shall ASUS, its directors, officers, employees, or agents be liable for any indirect, special, incidental, or consequential damages (including damages for loss of profits, loss of business, loss of use or data, interruption of business and the like), even if ASUS has been advised of the possibility of such damages arising from any defect or error in this manual or product.

Specifications and information contained in this manual are furnished for informational use only, and are subject to change at any time without notice, and should not be construed as a commitment by ASUS. ASUS assumes no responsibility or liability for any errors or inaccuracies that may appear in this manual, including the products and software described in it.

Product warranty or service will not be extended if: (1) the product is repaired, modified or altered, unless such repair, modification or alteration is authorized in writing by ASUS; or (2) the serial number of the product is defaced or missing.

Products and corporate names appearing in this manual may or may not be registered trademarks or copyrights of their respective companies, and are used only for identification or explanation and to the owners' benefit, without intent to infringe.

Contents

Notices	vii
Safety information.....	viii
Australia statement notice	ix
About this guide.....	x

Chapter 1: Product Introduction

1.1	System package contents	1-2
1.2	Serial number label.....	1-3
1.3	System specifications	1-4
1.4	Front panel features.....	1-6
1.5	Rear panel features.....	1-7
1.6	Internal features	1-10
1.7	LED information	1-11
1.7.1	Front panel LEDs	1-11
1.7.2	HDD status LEDs.....	1-12

Chapter 2: Hardware Information

2.1	Removing the server node.....	2-2
2.2	Air Duct	2-3
2.3	Central Processing Unit (CPU)	2-4
2.3.1	Installing the CPU	2-5
2.3.2	Installing the CPU heatsink.....	2-9
2.4	System memory	2-10
2.4.1	Overview	2-10
2.4.2	Memory Configurations.....	2-10
2.5	Hard disk drives	2-13
2.6	Expansion slots.....	2-15
2.6.1	PCI Express x16 slot (Gen3 x16 link) + x8 slot (Gen3 x8 link)	2-15
2.6.2	Removing the riser card.....	2-16
2.6.3	Installing an expansion card.....	2-17
2.6.4	Configuring an expansion card	2-19
2.6.5	Interrupt assignments.....	2-19
2.7	Removable/optional components.....	2-20
2.7.1	System fan	2-20
2.7.2	Power supply module.....	2-22
2.7.3	Installing an M.2 card.....	2-23

Contents

Chapter 3: Installation Options

3.1	Tool-less Friction Rail Kit.....	3-2
-----	----------------------------------	-----

Chapter 4: Motherboard Information

4.1	Motherboard layout.....	4-2
4.1.1	Layout contents.....	4-3
4.2	Jumpers.....	4-5
4.3	Internal connectors.....	4-11
4.4	Internal LEDs.....	4-17
4.5	Z10PH-D16 Golden Finger	4-21

Chapter 5: BIOS Setup

5.1	Managing and updating your BIOS.....	5-2
5.1.1	ASUS CrashFree BIOS 3 utility.....	5-2
5.1.2	ASUS EZ Flash Utility	5-3
5.1.3	BUUPDATER utility	5-4
5.2	BIOS setup program	5-6
5.2.1	BIOS menu screen.....	5-7
5.2.2	Menu bar.....	5-7
5.2.3	Menu items.....	5-8
5.2.4	Submenu items	5-8
5.2.5	Navigation keys.....	5-8
5.2.6	General help.....	5-8
5.2.7	Configuration fields	5-8
5.2.8	Pop-up window.....	5-8
5.2.9	Scroll bar.....	5-8
5.3	Main menu	5-9
5.3.1	System Date [Day xx/xx/xxxx].....	5-9
5.3.2	System Time [xx:xx:xx]	5-9
5.4	Advanced menu	5-10
5.4.1	ACPI Settings.....	5-11
5.4.2	Smart Settings.....	5-11
5.4.3	NCT6779D Super IO Configuration	5-12
5.4.4	Onboard LAN I210 Configuration	5-13
5.4.5	Serial Port Console Redirection.....	5-14
5.4.6	APM.....	5-17
5.4.7	PCI Subsystem Settings	5-18

Contents

5.4.8	Network Stack Configuration.....	5-19
5.4.9	CSM Configuration.....	5-20
5.4.10	Trusted Computing.....	5-21
5.4.11	USB Configuration	5-22
5.4.12	iSCSI Configuration.....	5-23
5.5	IntelRCSetup menu.....	5-24
5.5.1	Processor Configuration.....	5-25
5.5.2	Advanced Power Management Configuration.....	5-27
5.5.3	Common RefCode Configuration.....	5-28
5.5.4	QPI Configuration.....	5-29
5.5.5	Memory Configuration.....	5-30
5.5.6	IIO Configuration	5-33
5.5.7	PCH Configuration	5-34
5.5.8	Miscellaneous Configuration	5-37
5.5.9	Server ME Configuration.....	5-37
5.5.10	Runtime Error Logging Support	5-37
5.6	Server Mgmt menu.....	5-38
5.7	Event Logs menu.....	5-43
5.7.1	Change Smbios Event Log Settings	5-43
5.7.2	View Smbios Event Log	5-44
5.8	Monitor menu	5-45
5.9	Security menu	5-46
5.10	Boot menu	5-49
5.11	Tool menu.....	5-50
5.12	Exit menu	5-51

Chapter 6: RAID Configuration

6.1	Setting up RAID.....	6-2
6.1.1	RAID definitions	6-2
6.1.2	Installing hard disk drives.....	6-3
6.1.3	Setting the RAID item in BIOS	6-3
6.1.4	RAID configuration utilities	6-3
6.2	LSI Software RAID Configuration Utility	6-4
6.2.1	Creating a RAID set	6-5
6.2.2	Adding or viewing a RAID configuration.....	6-11
6.2.3	Initializing the virtual drives	6-12
6.2.4	Rebuilding failed drives.....	6-16

6.2.5	Checking the drives for data consistency.....	6-18
6.2.6	Deleting a RAID configuration.....	6-21
6.2.7	Selecting the boot drive from a RAID set.....	6-22
6.2.8	Enabling WriteCache	6-23
6.3	Intel® Rapid Storage Technology enterprise SATA Option ROM Utility.....	6-24
6.3.1	Creating a RAID set.....	6-25
6.3.2	Deleting a RAID set.....	6-27
6.3.3	Resetting disks to Non-RAID	6-28
6.3.4	Exiting the Intel® Rapid Storage Technology enterprise SATA Option ROM utility.....	6-29
6.3.5	Rebuilding the RAID.....	6-29
6.3.6	Setting the Boot array in the BIOS Setup Utility.....	6-31
6.4	Intel® Rapid Storage Technology enterprise (Windows).....	6-32
6.4.1	Creating a RAID set.....	6-33
6.4.2	Changing a Volume Type.....	6-35
6.4.3	Deleting a volume	6-36
6.4.4	Preferences.....	6-37

Chapter 7: Driver Installation

7.1	RAID driver installation	7-2
7.1.1	Creating a RAID driver disk.....	7-2
7.1.2	Installing the RAID controller driver.....	7-3
7.2	Management applications and utilities installation	7-13
7.3	Running the Support DVD	7-13
7.4	Intel® chipset device software installation	7-17
7.5	Installing the Intel® I210 Gigabit Adapters driver	7-19
7.6	VGA driver installation	7-22
7.7	Intel® Rapid Storage Technology enterprise 4.0 installation	7-24

Appendix

ASUS contact information.....	A-2
--------------------------------------	------------

Notices

Federal Communications Commission Statement

This device complies with Part 15 of the FCC Rules. Operation is subject to the following two conditions:

- This device may not cause harmful interference, and
- This device must accept any interference received including interference that may cause undesired operation.

This equipment has been tested and found to comply with the limits for a Class B digital device, pursuant to Part 15 of the FCC Rules. These limits are designed to provide reasonable protection against harmful interference in a residential installation. This equipment generates, uses and can radiate radio frequency energy and, if not installed and used in accordance with manufacturer's instructions, may cause harmful interference to radio communications. However, there is no guarantee that interference will not occur in a particular installation. If this equipment does cause harmful interference to radio or television reception, which can be determined by turning the equipment off and on, the user is encouraged to try to correct the interference by one or more of the following measures:

- Reorient or relocate the receiving antenna.
- Increase the separation between the equipment and receiver.
- Connect the equipment to an outlet on a circuit different from that to which the receiver is connected.
- Consult the dealer or an experienced radio/TV technician for help.



WARNING! The use of shielded cables for connection of the monitor to the graphics card is required to assure compliance with FCC regulations. Changes or modifications to this unit not expressly approved by the party responsible for compliance could void the user's authority to operate this equipment.

Canadian Department of Communications Statement

This digital apparatus does not exceed the Class A limits for radio noise emissions from digital apparatus set out in the Radio Interference Regulations of the Canadian Department of Communications.

This Class A digital apparatus complies with Canadian ICES-003.

REACH

Complying with the REACH (Registration, Evaluation, Authorization, and Restriction of Chemicals) regulatory framework, we publish the chemical substances in our products at ASUS REACH website at <http://csr.asus.com/english/REACH.htm>.

Safety information

Electrical Safety

- Before installing or removing signal cables, ensure that the power cables for the system unit and all attached devices are unplugged.
- To prevent electrical shock hazard, disconnect the power cable from the electrical outlet before relocating the system.
- When adding or removing any additional devices to or from the system, ensure that the power cables for the devices are unplugged before the signal cables are connected. If possible, disconnect all power cables from the existing system before you add a device.
- If the power supply is broken, do not try to fix it by yourself. Contact a qualified service technician or your dealer.

Operation Safety

- Any mechanical operation on this server must be conducted by certified or experienced engineers.
- Before operating the server, carefully read all the manuals included with the server package.
- Before using the server, ensure all cables are correctly connected and the power cables are not damaged. If any damage is detected, contact your dealer as soon as possible.
- To avoid short circuits, keep paper clips, screws, and staples away from connectors, slots, sockets and circuitry.
- Avoid dust, humidity, and temperature extremes. Place the server on a stable surface.



This product is equipped with a three-wire power cable and plug for the user's safety. Use the power cable with a properly grounded electrical outlet to avoid electrical shock.

Lithium-Ion Battery Warning

CAUTION! Danger of explosion if battery is incorrectly replaced. Replace only with the same or equivalent type recommended by the manufacturer. Dispose of used batteries according to the manufacturer's instructions.

CD-ROM Drive Safety Warning

CLASS 1 LASER PRODUCT

Heavy System

CAUTION! This server system is heavy. Ask for assistance when moving or carrying the system.



DO NOT throw the motherboard in municipal waste. This product has been designed to enable proper reuse of parts and recycling. This symbol of the crossed out wheeled bin indicates that the product (electrical and electronic equipment) should not be placed in municipal waste. Check local regulations for disposal of electronic products.



DO NOT throw the mercury-containing button cell battery in municipal waste. This symbol of the crossed out wheeled bin indicates that the battery should not be placed in municipal waste.

Australia statement notice

From 1 January 2012 updated warranties apply to all ASUS products, consistent with the Australian Consumer Law. For the latest product warranty details please visit <http://support.asus.com>. Our goods come with guarantees that cannot be excluded under the Australian Consumer Law. You are entitled to a replacement or refund for a major failure and compensation for any other reasonably foreseeable loss or damage. You are also entitled to have the goods repaired or replaced if the goods fail to be of acceptable quality and the failure does not amount to a major failure.

If you require assistance please call ASUS Customer Service 1300 2787 88 or visit us at <http://support.asus.com>

About this guide

Audience

This user guide is intended for system integrators, and experienced users with at least basic knowledge of configuring a server.

Contents

This guide contains the following parts:

1. Chapter 1: Product Introduction

This chapter describes the general features of the server, including sections on front panel and rear panel specifications.

2. Chapter 2: Hardware Information

This chapter lists the hardware setup procedures that you have to perform when installing or removing system components.

3. Chapter 3: Installation Options

This chapter describes how to install optional components into the barebone server.

4. Chapter 4: Motherboard Information

This chapter gives information about the motherboard that comes with the server. This chapter includes the motherboard layout, jumper settings, and connector locations.

5. Chapter 5: BIOS Information

This chapter tells how to change system settings through the BIOS Setup menus and describes the BIOS parameters.

6. Chapter 6: RAID Configuration

This chapter tells how to change system settings through the BIOS Setup menus. Detailed descriptions of the BIOS parameters are also provided.

7. Chapter 7: Driver Installation

This chapter provides instructions for installing the necessary drivers for different system components.

Conventions used in this guide

To ensure that you perform certain tasks properly, take note of the following symbols used throughout this manual.



DANGER/WARNING: Information to prevent injury to yourself when trying to complete a task.



CAUTION: Information to prevent damage to the components when trying to complete a task



IMPORTANT: Instructions that you **MUST** follow to complete a task.



NOTE: Tips and additional information to help you complete a task.

Typography

Bold text

Indicates a menu or an item to select.

Italics

Used to emphasize a word or a phrase.

<Key>

Keys enclosed in the less-than and greater-than sign means that you must press the enclosed key.

Example: <Enter> means that you must press the Enter or Return key.

<Key1> + <Key2> + <Key3>

If you must press two or more keys simultaneously, the key names are linked with a plus sign (+).

Example: <Ctrl> + <Alt> +

Command

Means that you must type the command exactly as shown, then supply the required item or value enclosed in brackets.

Example: At DOS prompt, type the command line:

`format A: /S`

References

Refer to the following sources for additional information, and for product and software updates.

1. **ASUS Server Web-based Management (ASWM) user guide**

This manual tells how to set up and use the proprietary ASUS server management utility.

2. **ASUS websites**

The ASUS websites worldwide provide updated information for all ASUS hardware and software products. Refer to the ASUS contact information.

Product Introduction

1

This chapter describes the general features of the chassis kit. It includes sections on front panel and rear panel specifications.

1.1 System package contents

Check your system package for the following items.

Model Name	RS720Q-E8-RS8-P
Chassis	ASUS 2U Rackmount Chassis
Motherboard	ASUS Z10PH-D16 Server Board
	2 x 2000W Power Supply
	4 x PCIe Riser Card
	2 x Front Panel Board
	2 x Power Supply Distribution Board
Component	1 x Power Connection Board
	1 x Backplane Board
	1 x Midplane Board
	4 x System Fans (80mm x 38mm)
	8 x Hot-swappable 2.5" HDD trays*
	1 x ASUS RS720Q-E8-RS8-P Support DVD (includes User Guide)
	1 x ASWM Enterprise SDVD
	1 x ASMB8-iKVM Support DVD
Accessories	8 x CPU Heatsinks
	1 x Bag of Screws
	2 x AC Power Cables
	1 x Friction Rail Kit

*May vary according to region or territory



If any of the above items is damaged or missing, contact your retailer.

1.2 Serial number label

Please take note of the product's serial number. The Serial number contains 12 characters such as xxS0xxxxxxx similar to the figure shown below.

You need to provide the correct serial number to the ASUS Technical Support team member if you need assistance or, when requesting support.



1.3 System specifications

The ASUS RS720Q-E8-RS8-P is a 2U server system featuring the ASUS Z10PH-D16 Server Board. The server supports Intel® LGA2011 R3 Intel® Xeon® E5-2600 v3 product family plus other latest technologies through the chipsets onboard.

Model Name		ASUS RS720Q-E8-RS8-P
Processor Support / System Bus		2 x Socket LGA2011 R3 Intel® Xeon® Processor E5-2600 v3 product family
Core Logic		Intel® C612 Wellsburg
ASUS Features	Fan Speed Control	✓
	ASWM Enterprise	✓
Memory	Total Slots	16 per node (4-channel per CPU, 2 DIMM per channel)
	Capacity	Maximum up to 512 GB per node
	Memory Type	DDR4 2133/1866/1600/1333* RDIMM/LR-DIMM/NVDIMM 2133MT/s@1DPC only
	Memory Size	4GB, 8 GB, 16GB, 32GB** (RDIMM) 32GB, 64GB** (LRDIMM)
Expansion Slots	Total PCI/PCI-E Slots	2 per node
	Slot Type	1 x PCI-E x16 (Gen3 x16 link), LP, HL 1 x PCI-E x8 (Gen3 x8 link), proprietary***
Storage	SATA Controller	Per Node: Intel® C612 6 x SATA 6Gb/s ports or 5 x SATA 6Gb/s ports + 1 x M.2 connector
		Intel® RSTe (For Windows® only; supports software RAID 0, 1, 10 and 5) LSI MegaRAID driver supports software RAID 0, 1, and 10 (Windows® and Linux)
	SAS Upgrade	Optional kits: ASUS PIKE 3008 8-port SAS 12G RAID card ASUS PIKE 3108 8-port SAS 12G HW RAID card

* Refer to www.asus.com for the complete list of supported CPUs.

** Refer to ASUS Server AVL for latest update

*** Supports the following ASUS add-on cards (optional)

PEM-FDR (56Gb/s FDR InfiniBand card)

PEB-10G/57840-2S (Dual Port 10 Gigabit/s Ethernet card)

PEB-10G/57811-1S (Single Port 10 Gigabit/s Ethernet card)

(continued on the next page)

Model Name		ASUS RS720Q-E8-RS8-P
HDD Bays	I = internal A or S will be hot-swappable	8 x Hot-swap 2.5" HDD Bays (2 x Hot-swap 2.5" HDD Bays per node)
Networking	LAN	Per node: 2 x Intel® I210AT 1 x Management Port
Graphic	VGA	Aspeed AST2400 32MB
Rear I/O Connectors	External USB Port	2 x USB 3.0
	VGA Port	1
	RJ-45	2 x GbE LAN 1 x Management LAN
	80 LED port	1
Management Solution	Software	ASWM Enterprise
	Out of Band Remote Management	On-board ASMB8-iKVM for KVM-over-IP
OS support		Windows® Server 2008 R2 Windows® Server 2012 RedHat® Enterprise Linux SuSE® Linux Enterprise Server CentOS VMware Citrix XenServer Please find the latest OS support from http://www.asus.com/
Regulatory Compliance		BSMI, CE, C-TICK, FCC (Class A)
Dimension		750 mm x 444 mm x 88 mm (2U)
Net Weight Kg (CPU, DRAM, and HDD not included)		30 Kg
Power Supply		1 + 1 Redundant 2000W 80Plus Titanium PSU Ratings: 100-140Vac or 180-240Vac, 12-9.5A (x2) or 9.5-7A, 50-60Hz, Class 1
Environment		Operating temperature: 10°C – 35°C Non operating temperature: -40°C – 70°C Non operating humidity: 20% – 90% (Non condensing)



Specifications are subject to change without notice.

1.4 Front panel features

The barebone server displays easily accessible features such as the power and reset buttons, LED indicators, and optical drive.



Refer to the **Front panel LEDs** section for the LED descriptions.

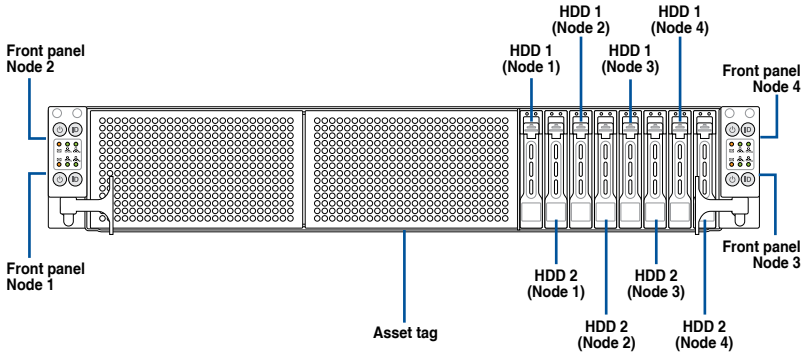

Turn off the system power and detach the power supply before removing or replacing any system component.

Asset tag

The Asset tag is a small polyester film located on the bottom side of the server's front panel. It provides information about the server such as asset barcode or serial number and is useful in asset tracking and inventory management.

1.5 Rear panel features

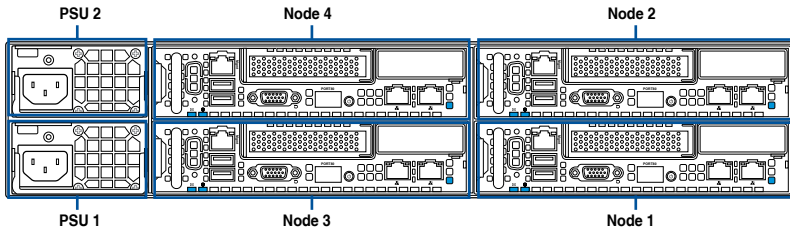

When installing only two nodes, install the nodes to node slot number 1 and 3 or number 2 and 4.

Rear node features

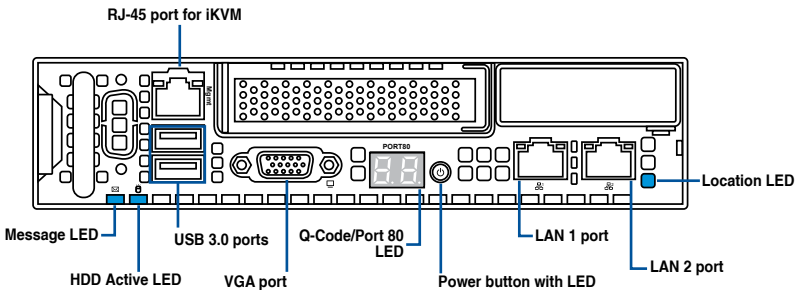

The ports for the USB, VGA, and Gigabit LANs do not appear on the rear panel if the motherboard is not present.

1. **RJ-45 port for iKVM.** This RJ45 port functions only when you enable ASMB8 controller.
2. **USB 3.0 ports 1 and 2.** These two 4-pin Universal Serial Bus (USB) ports are available for connecting USB 3.0 devices.
3. **Video Graphics Adapter (VGA) port.** This port is for a VGA monitor or other VGA-compatible devices.
4. **Message LED.** For details, refer to page 1-12.
5. **Location LED.** For details, refer to page 1-12.
6. **HDD Active LED.** For details, refer to page 1-13.
7. **Power LED/button.** Press this button to turn the system on/off.

8. **LAN (RJ-45) ports 1 and 2.** These ports allow Gigabit connection to a Local Area Network (LAN) through a network hub. Refer to the **LAN port LED indications table** for more information.

LAN port LED indications

Activity/Link LED		Speed LED	
Status	Description	Status	Description
OFF	No link	OFF	10 Mbps connection
GREEN	Linked	ORANGE	100 Mbps connection
BLINKING	Data activity	GREEN	1 Gbps connection

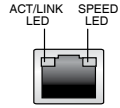

9. **Q-Code/Port 80 LED.** The Q-Code LED provides a 2-digit display that shows the status of your system. Refer to the **Q-Code table** of this user guide for more information about the 2-digit codes.

Q-Code table

Action	PHASE	POST CODE	TYPE	DESCRIPTIONz
Normal boot	Security Phase	01	Progress	First post code(POWER_ON_POST_CODE)
		02	Progress	Load BSP microcode(MICROCODE_POST_CODE)
		03	Progress	Set cache as ram for PEI phase(CACHE_ENABLED_POST_CODE)
		06	Progress	CPU Early init.(CPU_EARLY_INIT_POST_CODE)
		04	Progress	initializes South bridge for PEI preparation
		10	Progress	PEI Core Entry
	PEI (Pre-EFI initialization) phase	15	Progress	NB initialize before installed memory
		19	Progress	SB initialize before installed memory
		78-00	Progress	Wait BMC ready(duration: 120 seconds).
		A1	MRC Progress	QPI initialization
		A3	MRC Progress	QPI initialization
		A7	MRC Progress	QPI initialization
		A8	MRC Progress	QPI initialization
		A9	MRC Progress	QPI initialization
		AA	MRC Progress	QPI initialization
		AB	MRC Progress	QPI initialization
		AC	MRC Progress	QPI initialization
		AD	MRC Progress	QPI initialization
		AE	MRC Progress	QPI initialization
		AF	MRC Progress	QPI initialization Complete
		2F	Progress	Memory Init.
		B0	MRC Progress	Memory Init.
		B1	MRC Progress	Memory Init.
		AF	MRC Progress	RC Reset if require
		B4	MRC Progress	Memory Init.
		B2	MRC Progress	Memory Init.
		B3	MRC Progress	Memory Init.
		B5	MRC Progress	Memory Init.
		B6	MRC Progress	Memory Init.
		B7	MRC Progress	Memory Init.
		B8	MRC Progress	Memory Init.
		B9	MRC Progress	Memory Init.
		BA	MRC Progress	Memory Init.
BB		MRC Progress	Memory Init.	
BC		MRC Progress	Memory Init.	
BF		MRC Progress	Memory Init. Done	
5A		MRC Progress	Other config. After RC end	
31		Progress	Memory already installed.	
32		Progress	CPU Init.	
34		Progress	CPU Init.	
36		Progress	CPU Init.	
4F		Progress	DXE Initial Program Load(IPL)	

(continued on the next page)

Q-Code table

Action	PHASE	POST CODE	TYPE	DESCRIPTION	
Normal boot	D X E (D r i v e r E x e c u t i o n E n v i r o n m e n t) p h a s e	60	Progress	DXE Core Started	
		61	Progress	DXE NVRAM Init.	
		62	Progress	SB run-time init.	
		63	Progress	DXE CPU Init	
		68	Progress	NB Init.	
		69	Progress	NB Init.	
		6A	Progress	NB Init.	
		70	Progress	SB Init.	
		71	Progress	SB Init.	
		72	Progress	SB Init.	
		78	Progress	ACPI Init.	
		79	Progress	CSM Init.	
		BDS(Boot Device Selection) phase	90	Progress	BDS started
			91	Progress	Connect device event
			92	Progress	PCI Bus Enumeration.
			93	Progress	PCI Bus Enumeration.
			94	Progress	PCI Bus Enumeration.
			95	Progress	PCI Bus Enumeration.
			96	Progress	PCI Bus Enumeration.
	97		Progress	Console output connect event	
	98		Progress	Console input connect event	
	99		Progress	AMI Super IO start	
	9A		Progress	AMI USB Driver Init.	
	9B		Progress	AMI USB Driver Init.	
	9C		Progress	AMI USB Driver Init.	
	9D		Progress	AMI USB Driver Init.	
	b2		Progress	Legacy Option ROM Init.	
	b3		Progress	Reset system	
	b4		Progress	USB hotplug	
	b6		Progress	NVRAM clean up	
	b7		Progress	NVRAM configuration reset	
	A0		Progress	IDE, AHCI Init.	
	A1		Progress	IDE, AHCI Init.	
	A2		Progress	IDE, AHCI Init.	
	A3	Progress	IDE, AHCI Init.		
	A8	Progress	BIOS Setup Utility password verify		
	A9	Progress	BIOS Setup Utility start		
	AB	Progress	BIOS Setup Utility input wait		
	AD	Progress	Ready to boot event		
	AE	Progress	Legacy boot event		
	Operating system phase	AA	Progress	APIC mode	
AC		Progress	PIC mode		

1.6 Internal features

The barebone server includes the basic components as shown.

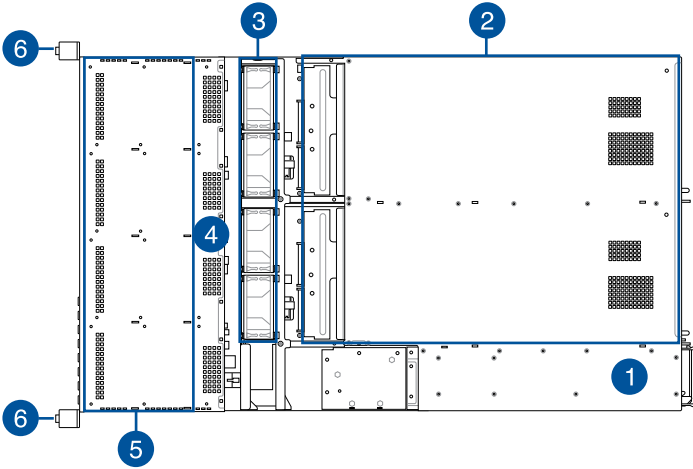

1. 2 x Power supply and power fan
2. ASUS Z10PH-D16 Server Board
3. System fans
4. SATA/SAS backplane (hidden)
5. Hot-swap HDD trays (SAS and SATA)
6. Front LED Boards



Turn off the system power and detach the power supply before removing or replacing any system component.

WARNING
HAZARDOUS MOVING PARTS
KEEP FINGERS AND OTHER BODY PARTS AWAY

1.7 LED information

1.7.1 Front panel LEDs

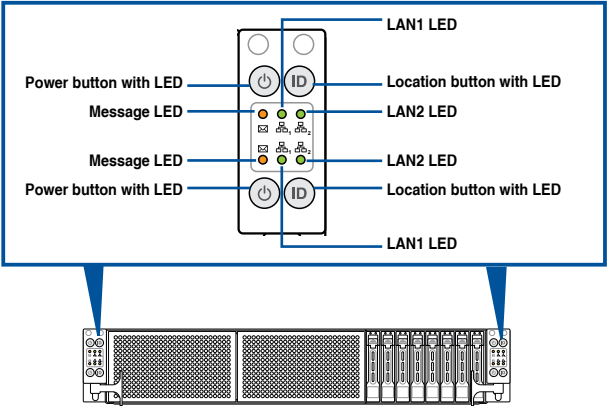

LED	Icon	Display status	Description
Power LED	💡	ON	System power ON
Message LED	✉️	OFF	System is normal; no incoming event
		ON	A hardware monitor event is indicated
LAN LEDs		OFF	No LAN connection
		Blinking	LAN is transmitting or receiving data
		ON	LAN connection is present
Location LED	🔗	ON	Location switched is pressed
		OFF	Normal status. (Press the location switch again to turn off.)

1.7.2 HDD status LEDs

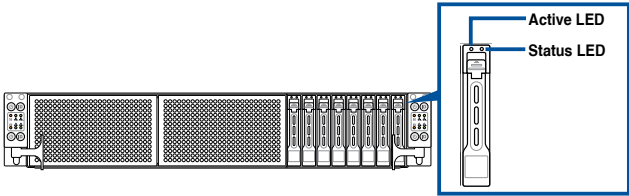

HDD LED	Description	
HDD Activity LED (Green)	OFF	HDD not present
	ON	HDD present, no activity
	Blinking	1. Read/write data from/into the SATAII/SAS HDD 2. Locating (blinking with the HDD status LED)
HDD Status LED (Red)	OFF	HDD not present
	ON	HDD has failed and should be swapped immediately
	Blinking	1. RAID rebuilding 2. Locating (blinking with the HDD activity LED)

Hardware Information

2

This chapter lists the hardware setup procedures that you have to perform when installing or removing system components.

2.1 Removing the server node

1. Remove the screw located on the node latch.

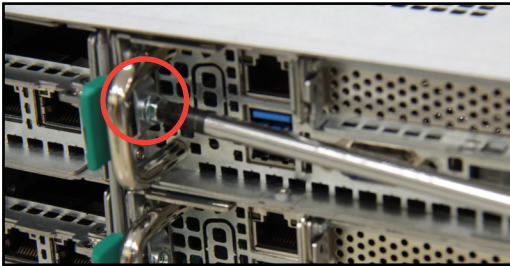

2. Hold the server node lever and press the green node latch.



3. Firmly pull the server node out of the server chassis.

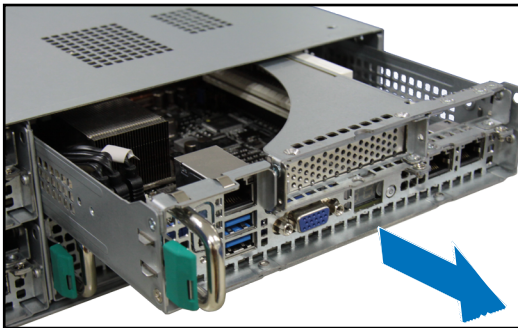

When installing only two nodes, install the nodes to node slot number 1 and 3 or number 2 and 4. Refer to section **1.5 Rear panel features** for details.

2.2 Air Duct

The RS720Q-E8-RS8-P server system comes with a motherboard fan air duct to enable better air flow inside the motherboard while the system is running.

Removing the air duct

1. Remove the screws securing the air duct in place
2. Carefully lift the air duct out of the chassis.

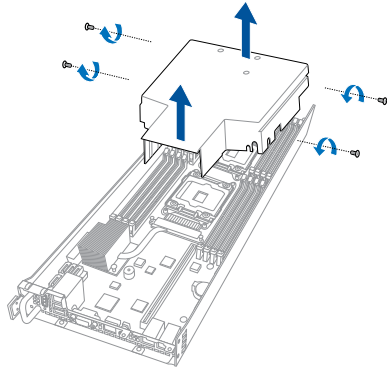

Installing the air duct

Position the air duct on top of the motherboard then carefully fit it on top of the motherboard. Refer to the following illustration for the right orientation of the air duct.



Insert the air duct on the gaps between the memory slots.



Ensure that the air duct is firmly fitted to the motherboard.

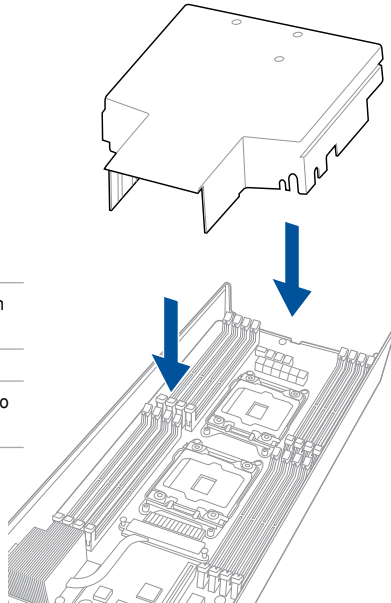

2.3 Central Processing Unit (CPU)

The motherboard comes with a surface mount LGA2011 R3 Socket designed for the Intel® Xeon® Processor E5-2600 v3 product family processor.



Ensure that all power cables are unplugged before installing the CPU.



- Upon purchase of the motherboard, ensure that the PnP cap is on the socket and the socket contacts are not bent. Contact your retailer immediately if the PnP cap is missing, or if you see any damage to the PnP cap/socket contacts/motherboard components. ASUS shoulders the repair cost only if the damage is shipment/transit-related.
 - Keep the cap after installing the motherboard. ASUS will process Return Merchandise Authorization (RMA) requests only if the motherboard comes with the cap on the LGA 2011 R3 socket.
 - The product warranty does not cover damage to the socket contacts resulting from incorrect CPU installation/removal, or misplacement/loss/incorrect removal of the PnP cap.
-



2.3.1 Installing the CPU

To install a CPU:

1. Locate the CPU socket on the motherboard.

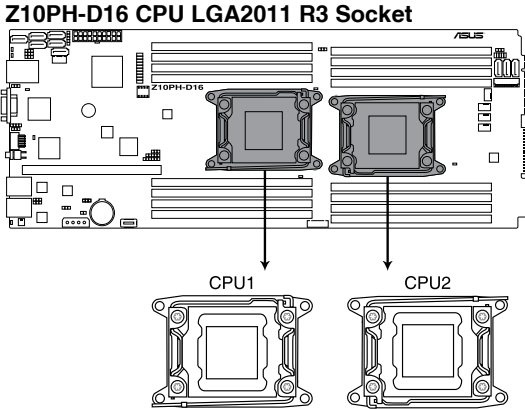

- To prevent damage to the socket pins, do not remove the PnP cap unless you are installing a CPU.
- Before installing the CPU, ensure that the socket box is facing toward you and the triangle mark is on the lower-left position.

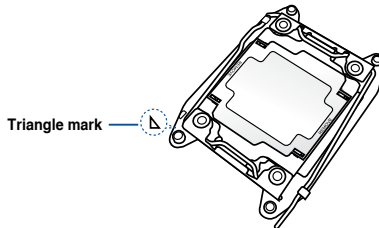

2. Press the right load lever with your thumb (A), then slide it to the left (B) until it is released from the retention tab.



DO NOT force to lift the load lever completely.

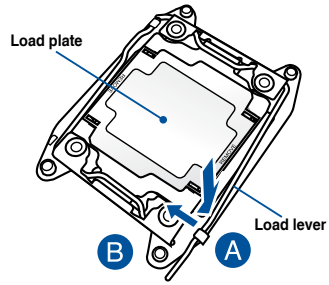

3. Press the left load lever with your thumb (C), slide it to the right (D) until it is released from the retention tab, then lift it completely (E) as shown.

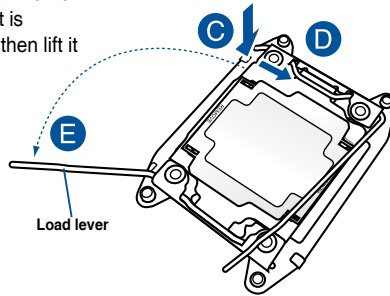

4. Slightly push down the right load lever just enough to lift the load plate (F).



DO NOT insert the load lever into the retention tab.

5. Hold the edge of the load plate then lift the load plate until it is lifted completely (G).

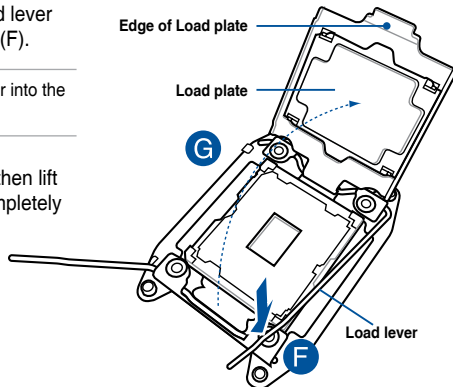

6. Get the CPU.
7. Align and position the CPU over the socket ensuring that the triangle mark on the CPU matches the triangle mark on the socket box.
8. Install the CPU into the slot.

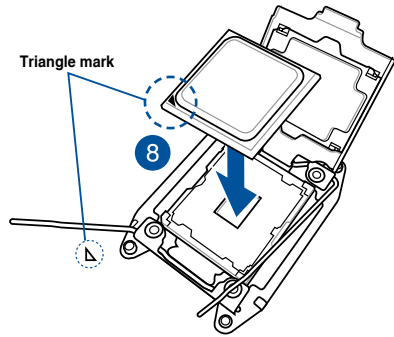

The CPU fits in only one correct orientation. DO NOT force the CPU into the socket to prevent bending the CPU pins on the socket.

9. Gently push the load plate just enough to let it sit on top of the CPU.



Do not force to close the load plate as it may damage the CPU.

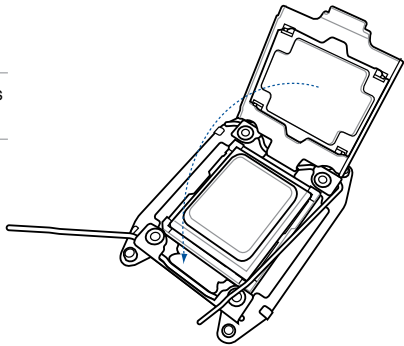

10. Push down the left load lever (H) ensuring that the edge of the load plate is fixed and tucked securely under the lever (I) then insert the left load lever under the retention tab (J).

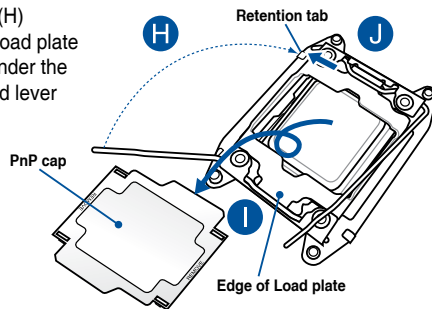

The PnP cap pops out of the load plate when the left load lever is inserted into the retention tab.



Keep the PnP cap. ASUS will process Return Merchandise Authorization (RMA) requests only if the motherboard comes with the PnP cap on the LGA2011 R3 socket.

11. Push down the right load lever (K) then insert it under the retention tab (L).

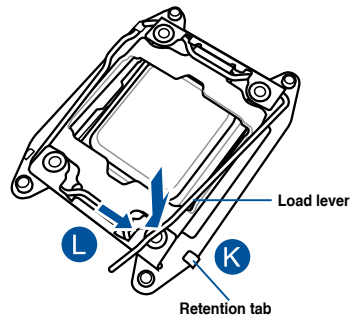

12. Apply some Thermal Interface Material to the exposed area of the CPU that the heatsink will be in contact with, ensuring that it is spread in an even thin layer.



Some heatsinks come with pre-applied thermal paste. If so, skip this step.

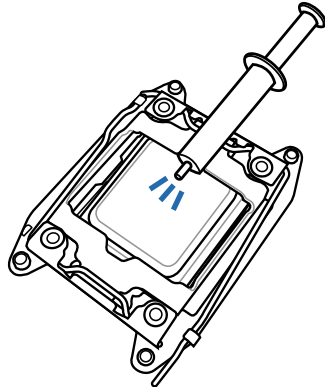

2.3.2 Installing the CPU heatsink

To install the CPU heatsink:

1. Place the heatsink on top of the installed CPU, ensuring that the four fasteners match the holes on the motherboard.
2. Twist each of the four screws with a Phillips (cross) screwdriver just enough to attach the heatsink to the motherboard. When the four screws are attached, tighten them one by one to completely secure the heatsink.



Tighten the four heatsink screws in a diagonal sequence.

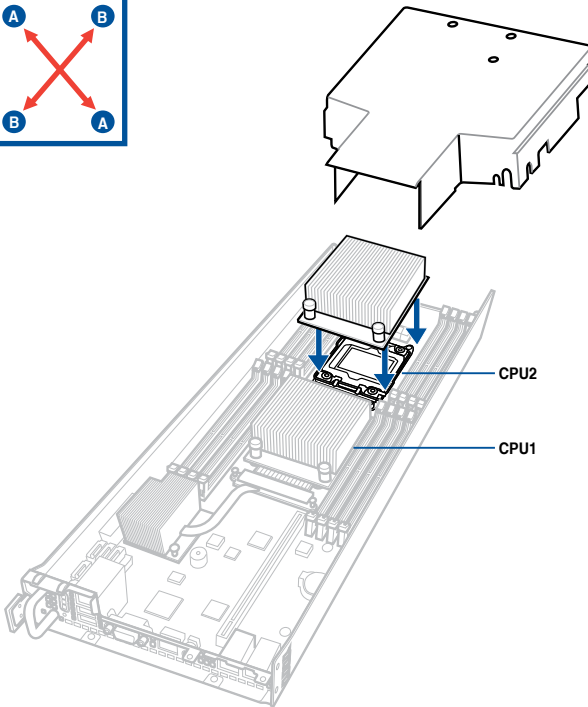
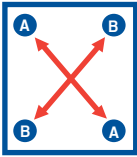

2.4 System memory

2.4.1 Overview

The motherboard comes with sixteen (16) Double Data Rate 4 (DDR4) Dual Inline Memory Modules (DIMM) sockets.

The figure illustrates the location of the DDR4 DIMM sockets:

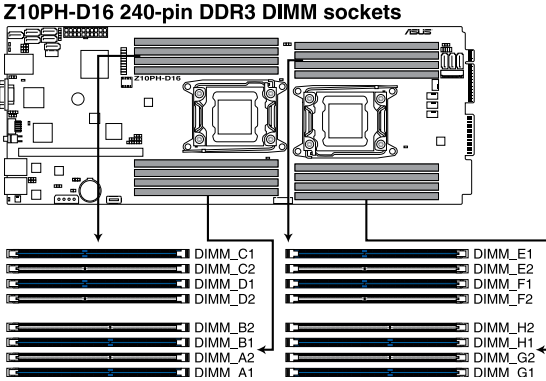

2.4.2 Memory Configurations

You may install 4 GB, 8 GB, 16 GB, and 32 GB RDIMMs or 32 GB, 64 GB LR-DIMMs and NVDIMM into the DIMM sockets using the memory configurations in this section.



- Refer to ASUS Server AVL for the updated list of compatible DIMMs.
- When installing only one DIMM in a single CPU configuration, install the DIMM on either A1 or B1.
- Always install DIMMs with the same CAS latency. For optimum compatibility, it is recommended that you obtain memory modules from the same vendor.

Single CPU configuration

You can refer to the following recommended memory population for a single CPU configuration.

Single CPU configuration (must be installed on CPU1)								
	DIMM							
	A2	A1	B2	B1	C2	C1	D2	D1
1 DIMM		✓						
1 DIMM				✓				
2 DIMMs		✓		✓				
4 DIMMs		✓		✓		✓		✓
8 DIMMs	✓	✓	✓	✓	✓	✓	✓	✓

Dual CPU configuration

You can refer to the following recommended memory population for a dual CPU configuration.

Dual CPU configuration																
	DIMM (CPU1)								DIMM (CPU2)							
	A2	A1	B2	B1	C2	C1	D2	D1	E2	E1	F2	F1	G2	G1	H2	H1
2 DIMMs		✓								✓						
4 DIMMs		✓		✓						✓		✓				
8 DIMMs		✓		✓		✓		✓		✓		✓		✓		✓
12 DIMMs	✓	✓	✓	✓		✓		✓	✓	✓	✓	✓		✓		✓
16 DIMMs	✓	✓	✓	✓	✓	✓	✓	✓	✓	✓	✓	✓	✓	✓	✓	✓

2.4.3 Installing a DIMM on a single clip DIMM socket

1. Unlock a DIMM socket by pressing the retaining clip outward.
2. Align a DIMM on the socket such that the notch on the DIMM matches the DIMM slot key on the socket.

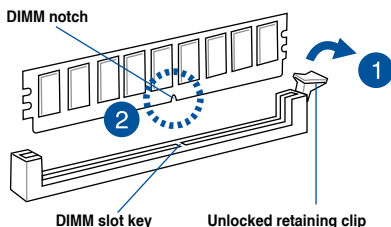

A DIMM is keyed with a notch so that it fits in only one direction. **DO NOT** force a DIMM into a socket in the wrong direction to avoid damaging the DIMM.

3. Hold the DIMM by both of its ends, then insert the DIMM vertically into the socket. Apply force to both ends of the DIMM simultaneously until the retaining clip snaps back into place, and the DIMM cannot be pushed in any further to ensure proper sitting of the DIMM.

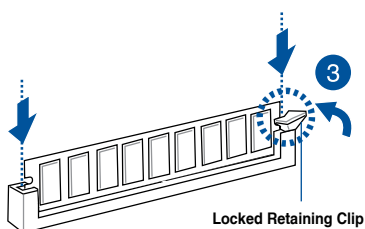

Always insert the DIMM into the socket **VERTICALLY** to prevent DIMM notch damage.



- To install two or more DIMMs, refer to the user guide bundled in the motherboard package.
- Refer to the user guide for qualified vendor lists of the memory modules.

Removing a DIMM from a single clip DIMM socket

1. Press the retaining clip outward to unlock the DIMM.
2. Remove the DIMM from the socket.

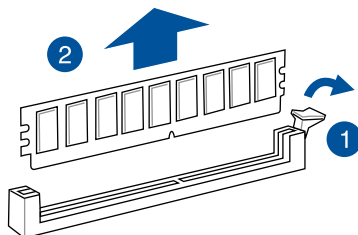

Support the DIMM lightly with your fingers when pressing the retaining clips. The DIMM might get damaged when it flips out with extra force.

2.5 Hard disk drives

The system supports two hot-swap SATA/SAS hard disk drives per node (available only when an optional ASUS PIKE SAS RAID card is installed) or two hot-swap SATA hard disk drives per node. The hard disk drive installed on the drive tray connects to the motherboard SATA/SAS ports via the SATA/SAS backplane.

To install a hot-swap SATA/SAS HDD

1. Press the spring lock to release the tray lever and to partially eject the tray from the bay.
2. Firmly hold the tray lever and carefully pull the drive tray out of the bay. Place the drive tray in a clean and flat surface.

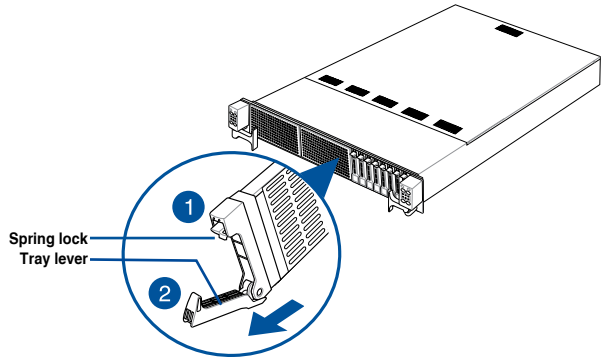

3. Release the screws on each side of the drive tray to release the drive tray metal beam.



The drive tray metal beam provides horizontal support to the empty drive tray and prevents the drive tray from being bent or deformed.

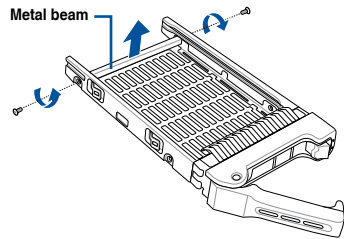

4. Orient and place the Serial ATA (SATA) HDD/ SAS HDD into the tray. Ensure that the SATA HDD/ SAS HDD is fitted firmly inside the drive tray and that the four screws of the HDD matches the four screw holes of the drive tray.

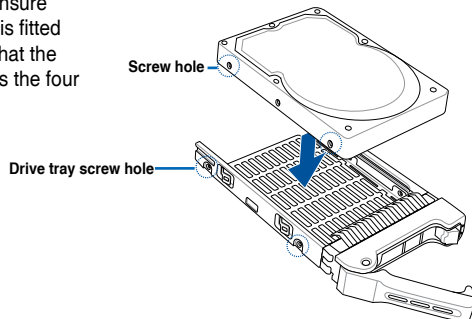

5. Secure the SATA HDD/ SAS HDD to the drive tray with four bundled screws.

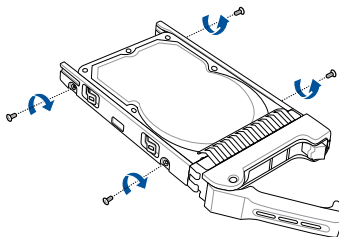

6. Align and insert the 2.5-inch SATA HDD/ SAS HDD and drive tray assembly into the drive bay.

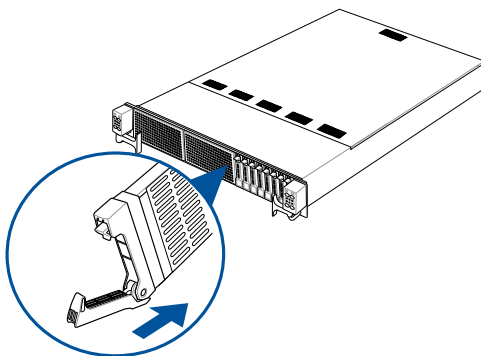

7. Repeat steps 1-6 to install the other 2.5-inch SATA HDD/ SAS HDDs.

2.6 Expansion slots

The following subsections describe the slots and expansion cards that they support.



Ensure to unplug the power cord before adding or removing expansion cards. Failure to do so may cause you physical injury and damage motherboard components.

2.6.1 PCI Express x16 slot (Gen3 x16 link) + x8 slot (Gen3 x8 link)

The onboard PCI Express slot provides x24 link from the Intel® Xeon E5-2600 v3 family processor. The slot can switch to one x16 slot (16 link) and one x 8 slot (8 link) by installing the default riser card that ships with the motherboard. This slot supports various server class high performance add-on cards.

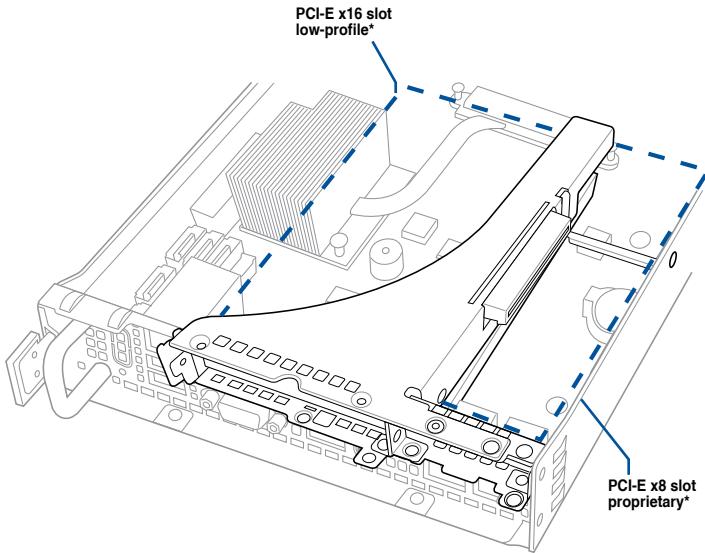

* Supports the following ASUS add-on cards:

PEM-FDR (56Gb/s FDR InfiniBand card)

PEB-10G/57840-2S (Dual Port 10 Gigabit/s Ethernet card)

PEB-10G/57811-1S (Single Port 10 Gigabit/s Ethernet card)

2.6.2 Removing the riser card

To remove the riser card:

1. Locate the PCI-E x24 slot in the motherboard, then loosen the three screws securing the riser card in place.

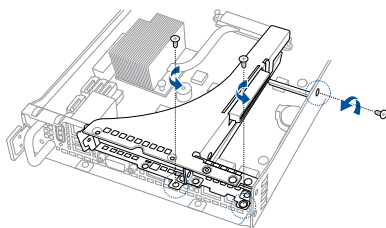

2. Gently pull out the riser card from the motherboard.

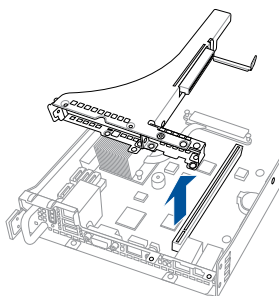

2.6.3 Installing an expansion card



Before installing an expansion card, read the documentation that came with it and ensure to make the necessary hardware settings.

To install an expansion card:

1. Prepare the expansion card.
2. Align and insert the golden finger connectors of the expansion card to the PCI-E slot on the riser card ensuring that the notch on the expansion card matches the notch on the riser card.



The default riser card provides two PCI-E slots . One PCI-E x8 slot and one PCI-E x16 slot. You can install an expansion card on either of the PCIE slot or both.

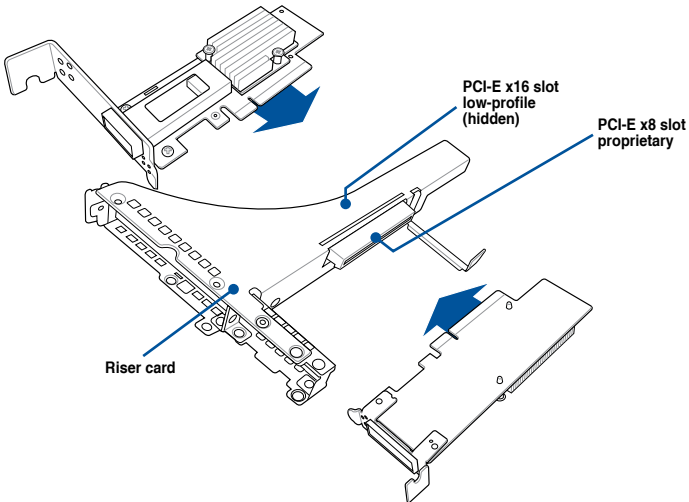

3. Align and insert the riser card and expansion card assembly into the PCI-E slot on the motherboard.



The expansion card fits in one orientation only. If it does not fit, try reversing it.

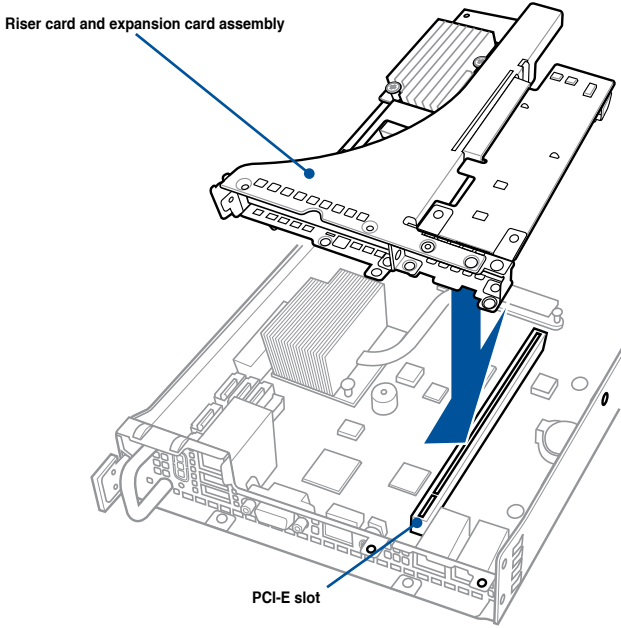

2.6.4 Configuring an expansion card

After installing the expansion card, configure it by adjusting the software settings.

1. Turn on the system and change the necessary BIOS settings, if any. See **Chapter 4** for information on BIOS setup.
2. Assign an IRQ to the card.

Refer to the table **Standard Interrupt assignments** in section **Interrupt assignments** for more information.

3. Install the software drivers for the expansion card.



When using PCI cards on shared slots, ensure that the drivers support "Share IRQ" or that the cards do not need IRQ assignments. Otherwise, conflicts may arise between the two PCI groups, making the system unstable and the card inoperable.

2.6.5 Interrupt assignments

Standard Interrupt assignments

IRQ	Priority	Standard function
0	1	System Timer
1	2	Keyboard Controller
2	-	Programmable Interrupt
4*	12	Communications Port (COM1)
5*	13	--
6	14	Floppy Disk Controller
7*	15	--
8	3	System CMOS/Real Time Clock
9*	4	ACPI Mode when used
10*	5	IRQ Holder for PCI Steering
11*	6	IRQ Holder for PCI Steering
12*	7	PS/2 Compatible Mouse Port
13	8	Numeric Data Processor
14*	9	Primary IDE Channel
15*	10	Secondary IDE Channel

* These IRQs are usually available for ISA or PCI devices.

2.7 Removable/optional components

You may need to remove previously installed system components when installing or removing system devices. Or you may need to install the optional components into the system. This section tells how to remove/install the following components:

1. System fans
2. Power supply module
3. M.2 card



Ensure that the system is turned off before removing any components.

2.7.1 System fan

To replace a system fan:

1. Loosen the six screws on the top and the two sides of the top cover.

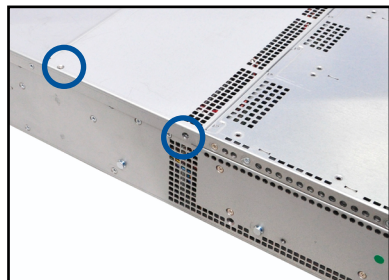
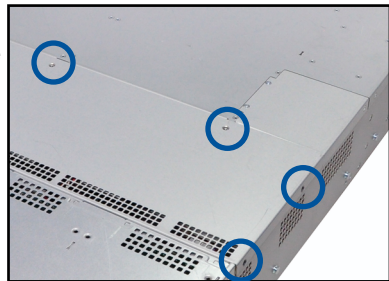

- Lift the rear end of the top cover, and follow the direction of the arrow in the right figure to slide the cover toward the rear panel until it is disengaged from the chassis.

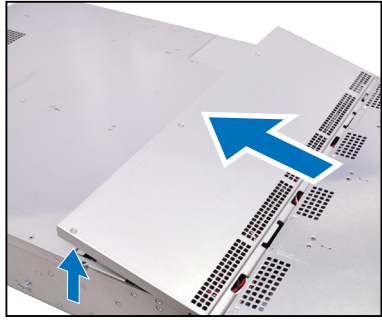

- Prepare a replacement fan of the same type and size.
- Disconnect the system fan cable from the fan connector on the HDD backplane.

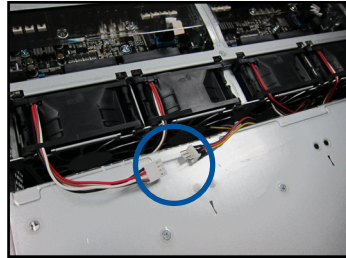

- Lift the fan then set aside.
- Repeat steps 4 to 5 to uninstall the other system fans.

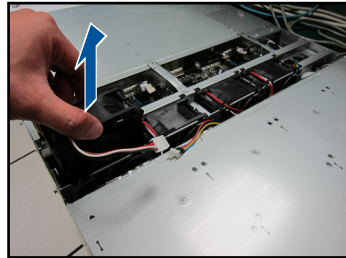

2.7.2 Power supply module

To install a second power supply module

1. Press and hold the latch on the dummy cover and pull out the cover from the server chassis.



Ensure to remove the plastic cover before installing the module.

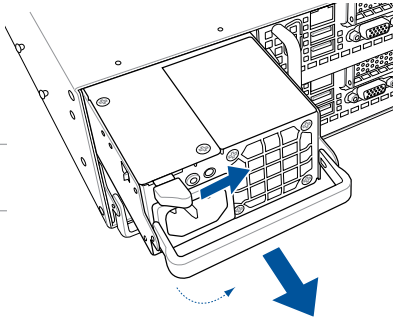

2. Take out the second power supply module from its package. Firmly push the power supply module into the chassis until the latch locks to the server chassis.

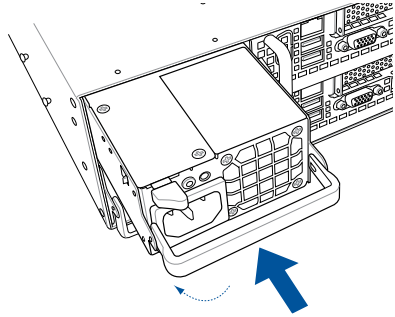

- If you install two or more nodes, please install both the power supply modules.
- The system automatically combines the two power supply modules as a single one.
- To enable the hot-swap feature (redundant mode), keep the total power consumption of the installed nodes under the maximum output power of an individual power supply module.
- For steady power input, use only the power cables that come with the server system package.

2.7.3 Installing an M.2 card

Follow the steps below to install an optional M.2 card on your motherboard.

1. Locate the M.2 connector on your motherboard and unfasten the screw for your M.2 card.

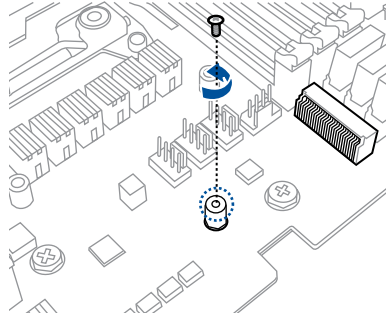

2. Align and insert the M.2 card into the M.2 connector of your motherboard.

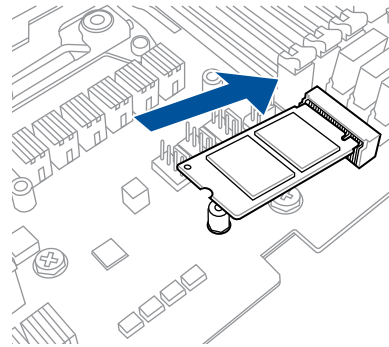

3. Replace the screw you removed earlier.

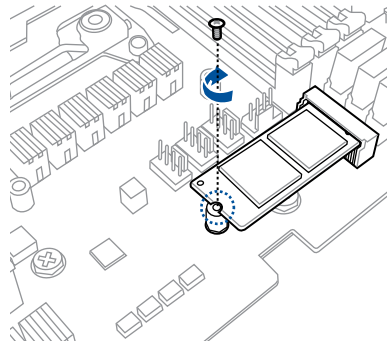

Installation Options

3

This chapter describes how to install the optional components and devices into the barebone server.

3.1 Tool-less Friction Rail Kit

The tool less design of the rail kit allows you to easily install the rack rails into the server rack without the need for additional tools. The kit also comes with a metal stopping bracket that can be installed to provide additional support and stability to the server.

The tool-less rail kit package includes:

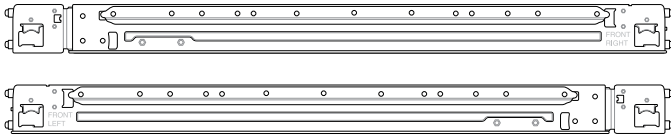
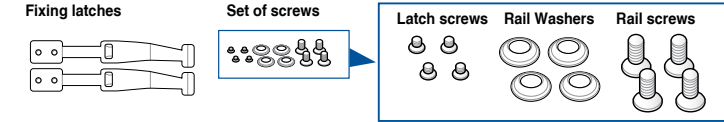

Installing the tool-less rack rail

To install the tool-less rack rails into the rack:

1. Secure the two fixing latches to the two sides of the server using the set of latch screws.



The locations of the screw holes vary with different server models. Refer to your server user manual for details.

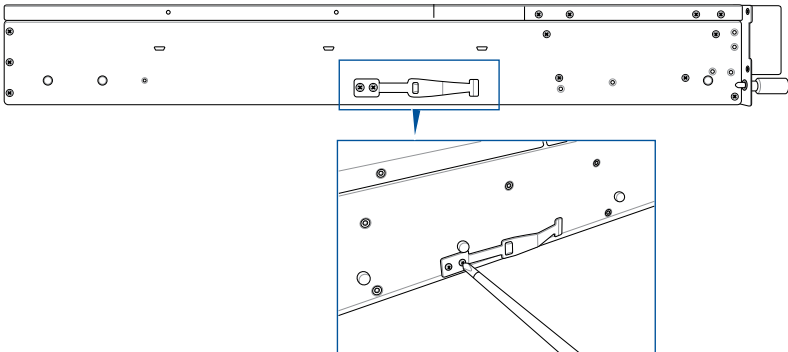

2. Select a desired space and place the appropriate rack rail (left and right) on opposite positions on the rack.



A 1U space is consists of three square mounting holes with two thin lips on the top and the bottom.

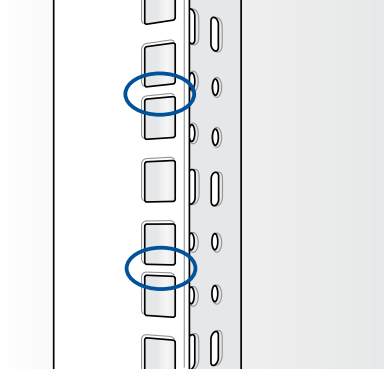

3. Press the spring lock then insert the studs into the selected square mounting holes on the rack post.
4. Press the spring lock on the other end of rail then insert the stud into the mounting hole on the rack post. Extend the rack rail, if necessary.
5. (Optional) Use the rail screw and rail washer that comes with the kit to secure the rack rail to the rack post.
6. Perform steps 3 to 5 for the other rack rail.



Ensure that the installed rack rails (left and right) are aligned, secured, and stable in place.

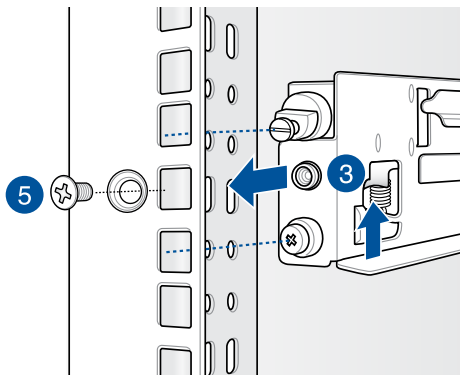

7. Lift the server chassis and insert into the rack rail.

-
- Ensure that the rack rail cabinet and the rack posts are stable and standing firmly on a level surface.
 - We strongly recommend that at least two able-bodied persons perform the steps described in this guide.
 - We recommend the use of an appropriate lifting tool or device, if necessary.
-

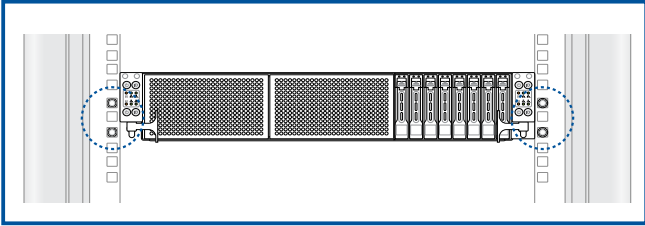

Ensure to include the side knots on the two sides of the server in the rack rail holders.



The illustrations shown above are for reference only.

Motherboard Information

4

This chapter includes the motherboard layout and brief descriptions of the jumpers and internal connectors.

4.1 Motherboard layout

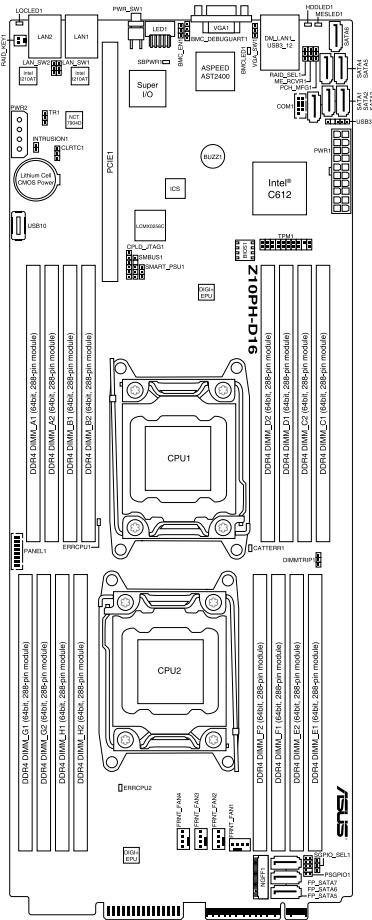

4.1.1 Layout contents

Jumpers	Page
1. Clear RTC RAM (3-pin CLRTC1)	4-5
2. VGA controller setting (3-pin VGA_SW1)	4-6
3. LAN controller setting (3-pin LAN_SW1, LAN_SW2)	4-6
4. RAID configuration utility selection (3-pin RAID_SEL1)	4-7
5. ME firmware force recovery setting (3-pin ME_RCVR1)	4-7
6. DDR4 thermal event setting (3-pin DIMMTRIP1)	4-8
7. Serial General Purpose Input/Output setting (3-pin SGPIO_SEL1)	4-8
8. BMC Setting (3-pin BMC_EN)	4-9
9. PMBus 1.2 PSU select jumper (3-pin SMART_PSU1)	4-9
10. Chassis Intrusion (2-pin INTRUSION1)	4-10

Internal connectors	Page
1. Serial ATA 6.0 Gb/s connectors (7-pin SATA1-6 [Light blue])	4-11
2. USB connector (5-1 pin USB3; A-Type USB10)	4-12
3. Front fan connectors (4-pin FRNT_FAN1-4)	4-12
4. Thermal sensor cable connectors (3-pin TR1)	4-13
5. Trusted Platform Module connector (20-1 pin TPM1)	4-13
6. M.2 (NGFF) connector (NGFF1)	4-14
7. Proprietary power connectors (20-pin PWR1, 4-pin PWR2)	4-15
8. System panel connector (16-pin PANEL1 [White])	4-16

Internal LEDs	Page
1. CPU warning LED (ERRCPU1, ERRCPU2)	4-17
2. BMC LED (BMCLED1)	4-17
3. Standby Power LED (SBPWR1)	4-18
4. CATT ERR LED (CATTERR1)	4-18
5. Hard disk activity LED (HDDLED1)	4-19
6. Message LED (MESLED1)	4-19
7. Location LED (LOCLED1)	4-20

Golden Finger	Page
1. Golden Finger	4-21
2. Golden Finger Power connector	4-22
3. FP Serial ATA connectors (7-pin FP_SATA5-6 [Light blue], FP_SATA7 [light gray])	4-22

4.2 Jumpers

1. Clear RTC RAM (3-pin CLRTC1)

This jumper allows you to clear the Real Time Clock (RTC) RAM in CMOS. You can clear the CMOS memory of date, time, and system setup parameters by erasing the CMOS RTC RAM data. The onboard button cell battery powers the RAM data in CMOS, which include system setup information such as system passwords.

To erase the RTC RAM:

1. Turn OFF the computer and unplug the power cord.
2. Move the jumper cap from pins 1–2 (default) to pins 2–3. Keep the cap on pins 2–3 for about 5–10 seconds, then move the cap back to pins 1–2.
3. Plug the power cord and turn ON the computer.
4. Hold down the key during the boot process and enter BIOS setup to re-enter data.



Except when clearing the RTC RAM, never remove the cap on CLRTC jumper default position. Removing the cap will cause system boot failure!



If the steps above do not help, remove the onboard battery and move the jumper again to clear the CMOS RTC RAM data. After the CMOS clearance, reinstall the battery.

Z10PH-D16 Clear RTC RAM

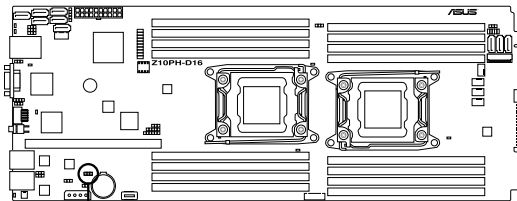

CLRTC1

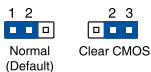

2. VGA controller setting (3-pin VGA_SW1)

This jumper allows you to enable or disable the onboard VGA controller. Set to pins 1–2 to activate the VGA feature.

Z10PH-D16 VGA setting

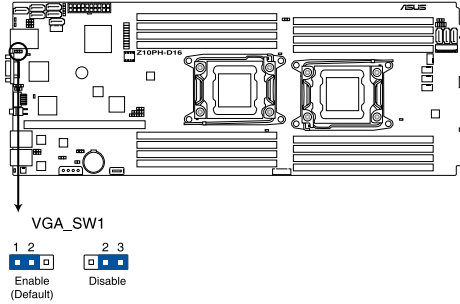

3. LAN controller setting (3-pin LAN_SW1, LAN_SW2)

These jumpers allow you to enable or disable the onboard Intel® I210AT Gigabit LAN controllers. Set to pins 1–2 to activate the Gigabit LAN feature.

Z10PH-D16 LAN setting

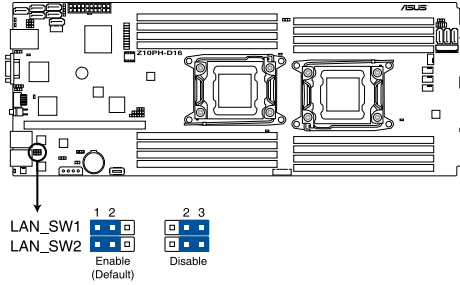

4. RAID configuration utility selection (3-pin RAID_SEL1)

This jumper allows you to select the RAID configuration utility to use when you create disk arrays. Place the jumper caps over pins 1–2 to use the third party software LSI MegaRAID software RAID Configuration Utility; otherwise, place the jumper caps over pins 2–3 to use the Intel® Rapid Storage Technology enterprise SATA Option ROM Utility.

Z10PH-D16 RAID setting

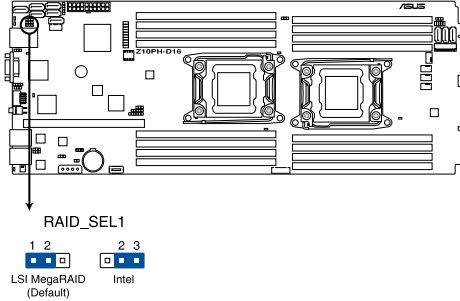

5. ME firmware force recovery setting (3-pin ME_RCVR1)

This jumper allows you to quickly recover the Intel Management Engine (ME) firmware when it becomes corrupted.

Z10PH-D16 ME firmware setting

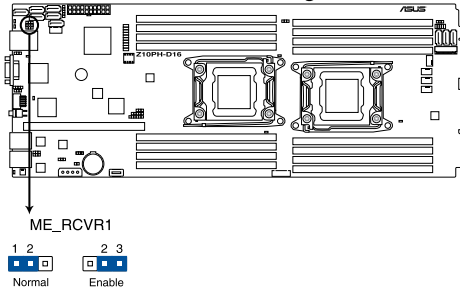

6. **DDR4 thermal event setting (3-pin DIMMTRIP1)**

This jumper allows you to enable or disable DDR4 DIMM thermal sensing event pin.

Z10PH-D16 DIMM Thermaltrip setting

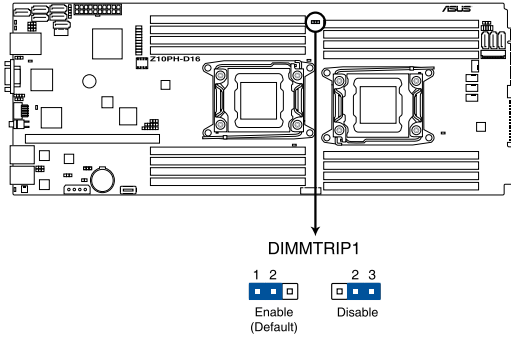

7. **Serial General Purpose Input/Output setting (3-pin SGPIO_SEL1)**

This jumper allows you to select a storage device. Set to pin 1-2 to enable onboard C612 chipset SATA SGPIO function (default) or set to pin 2-3 to enable Add-on RAID card.

Z10PH-D16 SGPIO setting

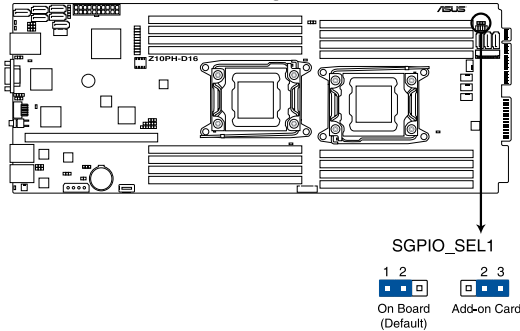

8. BMC Setting (3-pin BMC_EN)

This jumper allows you to enable or disable the ASMB8.

Z10PH-D16 BMC setting

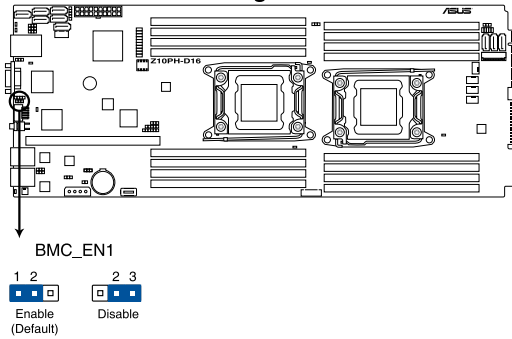

9. PMBus 1.2 PSU select jumper (3-pin SMART_PSU1)

This jumper allows you to select PSU PMBus version. Set to pins 1–2 for PMBus, set to pins 2–3 for others.

Z10PH-D16 PMBus 1.2 PSU setting

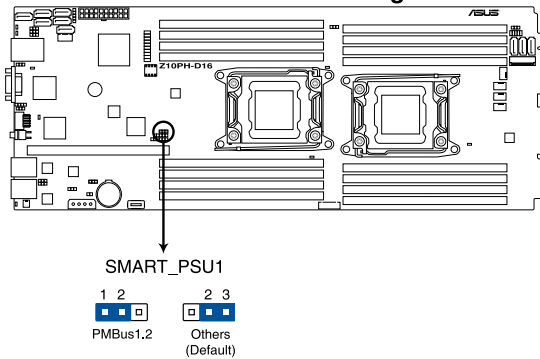

10. Chassis Intrusion (2-pin INTRUSION1)

These leads are for the intrusion detection feature for chassis with intrusion sensor or microswitch. When you remove any chassis component, the sensor triggers and sends a high level signal to these leads to record a chassis intrusion event. The default setting is short CHASSIS# and GND pin by jumper cap to disable the function.

Z10PH-D16 INTRUSION connector

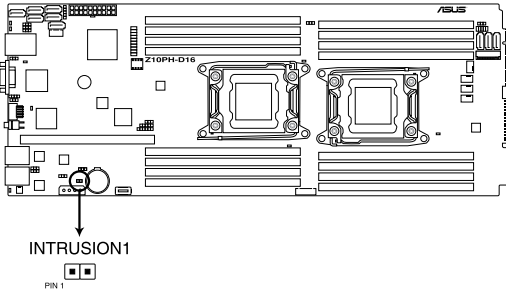

4.3 Internal connectors

1. Serial ATA 6.0 Gb/s connectors (7-pin SATA1-6 [Light blue])

These connectors are for the Serial ATA signal cables for Serial ATA hard disk drives. These connectors can also be used with the golden finger design of the motherboard using a SATA cable. For more information, refer to the **Z10PH-D16 Golden Finger** section of this user guide.

If you installed Serial ATA hard disk drives, you can use a software RAID solution to create a RAID 0, RAID 1, RAID 5, or a RAID 10 configuration. For more information on the SATA RAID solutions supported on this motherboard, refer to the **RAID Configuration** chapter of this user guide.

Z10PH-D16 SATA connectors

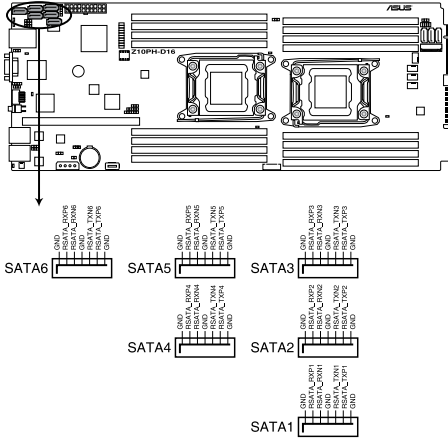

The actual data transfer rate depends on the speed of Serial ATA hard disks installed.

2. USB connector (5-1 pin USB3; A-Type USB10)

These connectors are for USB 2.0 ports. Connect the USB module cables to connectors USB3, then install the modules to a slot opening at the back of the system chassis. These USB connectors comply with USB 2.0 specification that supports up to 480 Mbps connection speed.

Z10PH-D16 USB 2.0 connectors

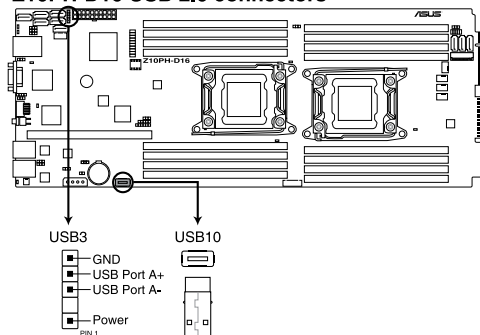

3. Front fan connectors (4-pin FRNT_FAN1-4)

The fan connectors support cooling fans of 350 mA–740 mA (8.88 W max.) or a total of 3.15 A–6.66 A (53.28 W max.) at +12V. Connect the fan cables to the fan connectors on the motherboard, ensuring that the black wire of each cable matches the ground pin of the connector.



- DO NOT forget to connect the fan cables to the fan connectors. Insufficient air flow inside the system may damage the motherboard components.
- These are not jumpers! DO NOT place jumper caps on the fan connectors!
- All fans feature the ASUS Smart Fan technology.

Z10PH-D16 FAN connectors

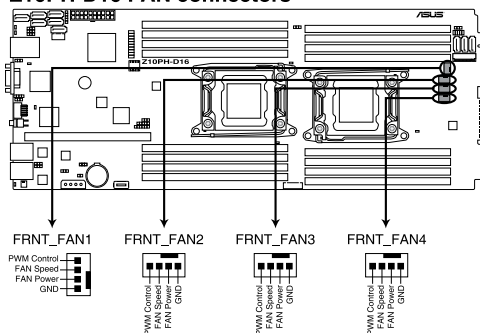

4. Thermal sensor cable connectors (3-pin TR1)

This connector is for temperature monitoring. Connect the thermal sensor cables to these connectors and place the other ends to the devices, which you want to monitor temperature.

Go to BIOS setup to change the default setting of TR1 from “Disabled” to “Enabled” before using the thermal sensor cable.

Z10PH-D16 Thermal sensor cable connector

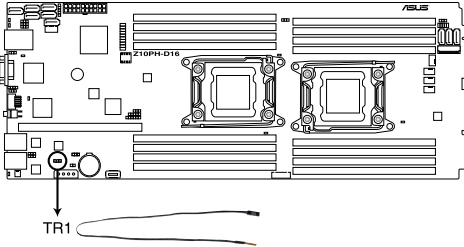

5. Trusted Platform Module connector (20-1 pin TPM1)

This connector supports a Trusted Platform Module (TPM) system, which can securely store keys, digital certificates, passwords, and data. A TPM system also helps enhance network security, protects digital identities, and ensures platform integrity.

Z10PH-D16 TPM connector

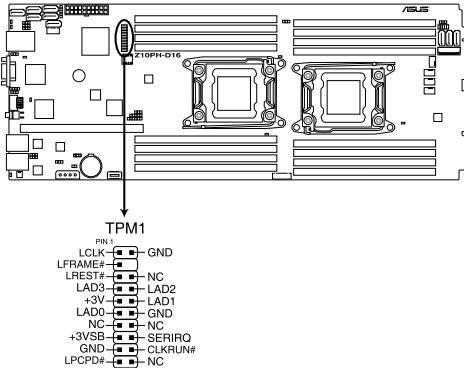

6. M.2 (NGFF) connector (NGFF1)

This connector allows you to install an M.2 device.

Z10PH-D16 NGFF1 connector

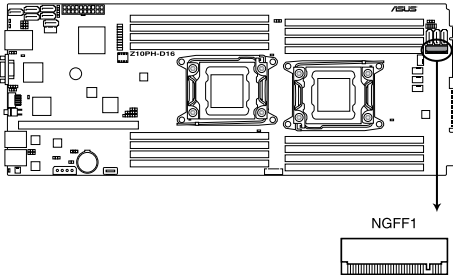

- This connector supports type 2242 devices on both SATA and PCI-E interface.
- Please refer to the following guidelines in installing an M.2 device:
 - **For SATA Interface:** Connect the FP_SATA7 (light gray) port to any of the onboard SATA ports (SATA 1-6) or any SATA port from the add-on storage card using a SATA cable.
 - **For PCIe Interface:** You need to install a second CPU (on CPU2) to support this function.



The M.2 (NGFF) device is purchased separately

7. Proprietary power connectors (20-pin PWR1, 4-pin PWR2)

These connectors are for Proprietary power supply plugs. The power supply plugs are designed to fit these connectors in only one orientation. Orient the connectors and push down firmly until they completely fit.

The 4-pin PWR2 is designed for hard disk drives power supply. **DO NOT** connect other 4-pin power connectors of the power supply unit (PSU) to this connector.



- Use of a PSU with a higher power output is recommended when configuring a system with more power-consuming devices. The system may become unstable or may not boot up if the power is inadequate.
- **USE ONLY THE PROPRIETARY POWER SUPPLY** and ensure that your PSU can provide at least the minimum power required by your system.

Z10PH-D16 Proprietary power connectors

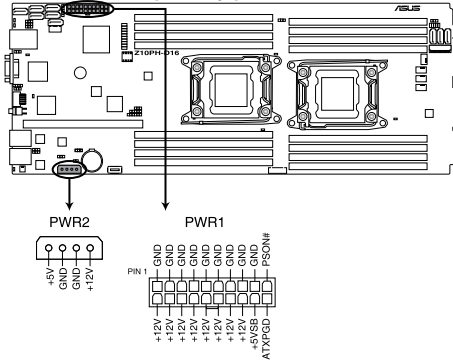

8. System panel connector (16-pin PANEL1 [White])

This connector supports several chassis-mounted functions.

Z10PH-D16 System panel connector

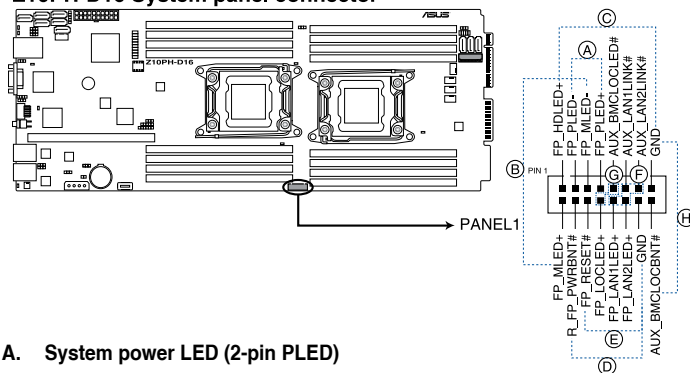

A. System power LED (2-pin PLED)

This 2-pin connector is for the system power LED. Connect the chassis power LED cable to this connector. The system power LED lights up when you turn on the system power, and blinks when the system is in sleep mode.

B. Message LED (2-pin MLED)

This 2-pin connector is for the message LED cable that connects to the front message LED. The message LED is controlled by Hardware monitor to indicate an abnormal event occurrence.

C. Hard disk drive activity LED (2-pin HDDLED)

This 2-pin connector is for the HDD Activity LED. Connect the HDD Activity LED cable to this connector. The IDE LED lights up or flashes when data is read from or written to the HDD.

D. Proprietary power button/soft-off button (2-pin PWRSW)

This connector is for the system power button. Pressing the power button turns the system on or puts the system in sleep or soft-off mode depending on the BIOS settings. Pressing the power switch for more than four seconds while the system is ON turns the system OFF.

E. Reset button (2-pin RESET)

This 2-pin connector is for the chassis-mounted reset button for system reboot without turning off the system power.

F. LAN activity LED (2-pin LAN1_LINKACTLED, LAN2_LINKACTLED)

These connectors are for Gigabit LAN activity LEDs on the front panel.

G. Locator LED (2-pin LOCATORLED)

This 2-pin connector is for the Locator LED on the front panel. When you connect the Locator LED cable to this 2-pin connector, the LED lights up when the Locator button is pressed.

H. Locator Button/Switch (2-pin LOCATORBTN#)

This 2-pin connector is for the Locator button on the front panel. This button queries the state of the system locator.

4.4 Internal LEDs

1. CPU warning LED (ERRCPU1, ERRCPU2)

The CPU warning LEDs light up to indicate an impending failure of the corresponding CPU.

Z10PH-D16 ERR CPU LED

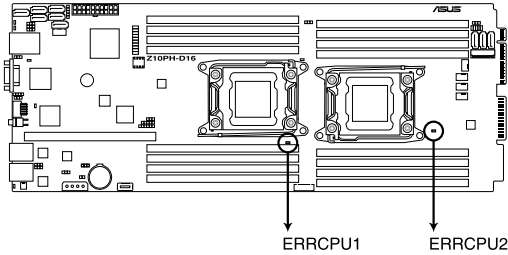

2. BMC LED (BMCLED1)

The green heartbeat LED blinks per second to indicate that the ASMB8 is working normally.

Z10PH-D16 BMC LED

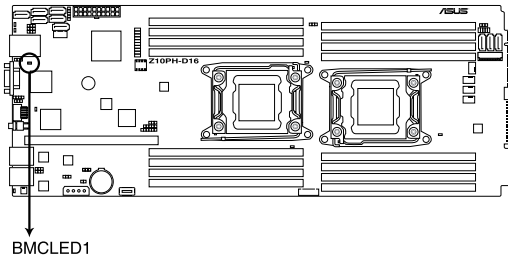

- The heartbeat LED functions only when you enable the ASUS ASMB8.
- Everytime after the AC power is replugged, you have to wait for about 30 seconds for the system to power up.

3. Standby Power LED (SBPWR1)

The motherboard comes with a standby power LED. The green LED lights up to indicate that the system is ON, in sleep mode, or in soft-off mode. This is a reminder that you should shut down the system and unplug the power cable before removing or plugging in any motherboard component. The illustration below shows the location of the onboard LED.

Z10PH-D16 Onboard LED

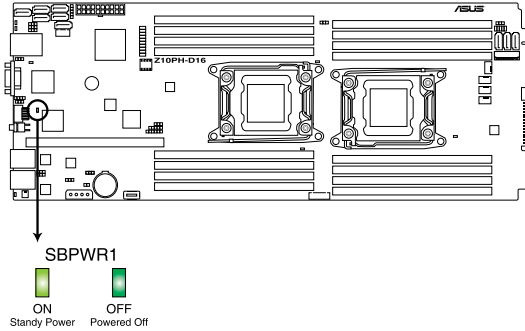

4. CATT ERR LED (CATTERR1)

The CATT ERR LED indicates that the system has experienced a fatal or catastrophic error and cannot continue to operate.

Z10PH-D16 CATTERR LED

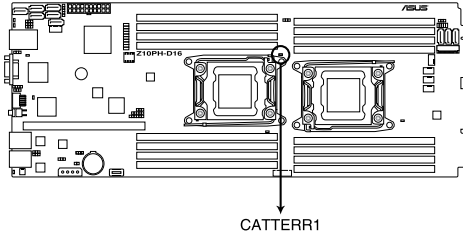

5. Hard disk activity LED (HDDLED1)

This LED is for the storage add-on card cable connected to the SATA or SAS add-on card. The read or write activities of any device connected to the SATA or SAS add-on card causes the front panel LED to light up.

Z10PH-D16 HDDLED

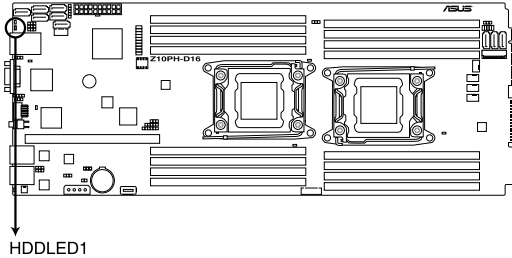

6. Message LED (MESLED1)

This onboard LED lights up to red when there is a temperature warning or a BMC event log is generated.

Z10PH-D16 MESLED

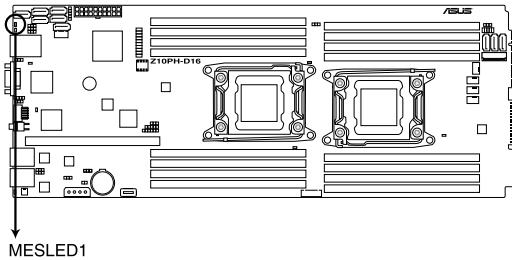

7. Location LED (LOCLED1)

This onboard LED lights up when the Location button on the server is pressed or when triggered by a system management software. The Location LED helps visually locate and quickly identify the server in error on a server rack.

Z10PH-D16 Location LED

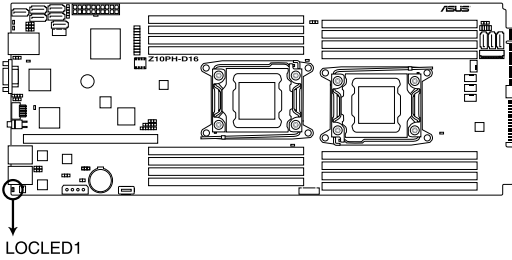

4.5 Z10PH-D16 Golden Finger

1. Golden Finger

The Z10PH-D16 golden finger is a proprietary connector that integrates most of the functions of the motherboard's onboard connectors and switches.

Refer to the following illustration for the golden finger's pin definitions.

Z10PH-D16 Golden finger

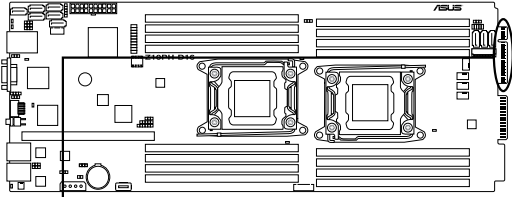

Golden finger

Top side (A)

Bottom side (B)

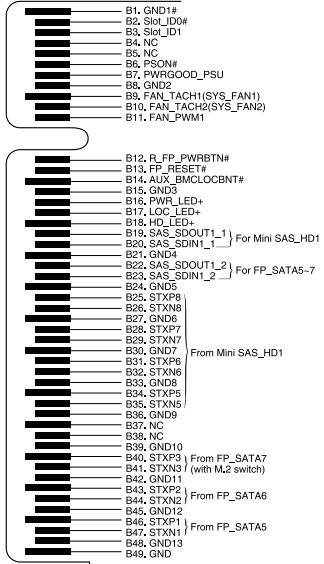
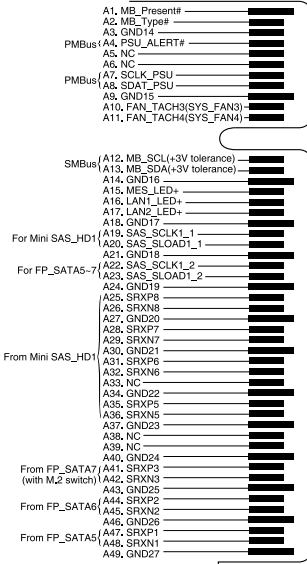

The golden finger of Z10PH-D16 ships with a cap to protect the pins. Ensure to remove the cap before using the golden finger.

2. Golden Finger Power connector

Refer to the following illustration for the golden finger's power pin definition.

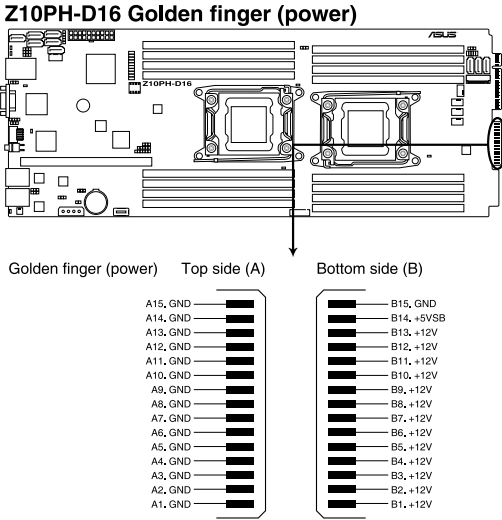

3. FP Serial ATA connectors (7-pin FP_SATA5-6 [Light blue], FP_SATA7 [light gray])

These connectors switches to Golden finger for system design when you connect the FP_SATA5-7 to any of the onboard SATA ports (SATA1-6) or from any SATA port from the add-on storage cards.

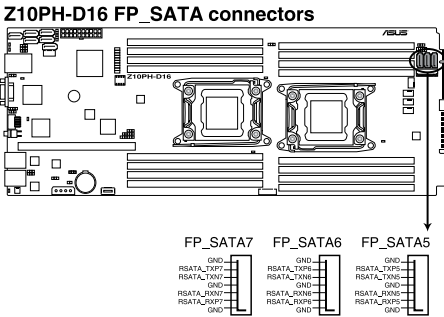

BIOS Setup

5

This chapter tells how to change the system settings through the BIOS Setup menus. Detailed descriptions of the BIOS parameters are also provided.

5.1 Managing and updating your BIOS

The following utilities allow you to manage and update the motherboard Basic Input/Output System (BIOS) setup:

1. **ASUS CrashFree BIOS 3**

To recover the BIOS using a bootable USB flash disk drive when the BIOS file fails or gets corrupted.

2. **ASUS EzFlash**

Updates the BIOS using a USB flash disk.

3. **BUPDATER**

Updates the BIOS in DOS mode using a bootable USB flash disk drive.

Refer to the corresponding sections for details on these utilities.



Save a copy of the original motherboard BIOS file to a bootable USB flash disk drive in case you need to restore the BIOS in the future. Copy the original motherboard BIOS using the BUPDATER utility.

5.1.1 **ASUS CrashFree BIOS 3 utility**

The ASUS CrashFree BIOS 3 is an auto recovery tool that allows you to restore the BIOS file when it fails or gets corrupted during the updating process. You can update a corrupted BIOS file using a USB flash drive that contains the updated BIOS file.



Prepare a USB flash drive containing the updated motherboard BIOS before using this utility.

Recovering the BIOS from a USB flash drive

To recover the BIOS from a USB flash drive:

1. Insert the USB flash drive with the original or updated BIOS file to one USB port on the system.
2. The utility will automatically recover the BIOS. It resets the system when the BIOS recovery finished.



DO NOT shut down or reset the system while recovering the BIOS! Doing so would cause system boot failure!



The recovered BIOS may not be the latest BIOS version for this motherboard. Visit the ASUS website at www.asus.com to download the latest BIOS file.

5.1.2 ASUS EZ Flash Utility

The ASUS EZ Flash Utility feature allows you to update the BIOS without having to use a DOS-based utility.



Before you start using this utility, download the latest BIOS from the ASUS website at www.asus.com.

To update the BIOS using EZ Flash Utility:

1. Insert the USB flash disk that contains the latest BIOS file into the USB port.
2. Enter the BIOS setup program. Go to the **Tool** menu then select **ASUS EZ Flash Utility**. Press <Enter>.

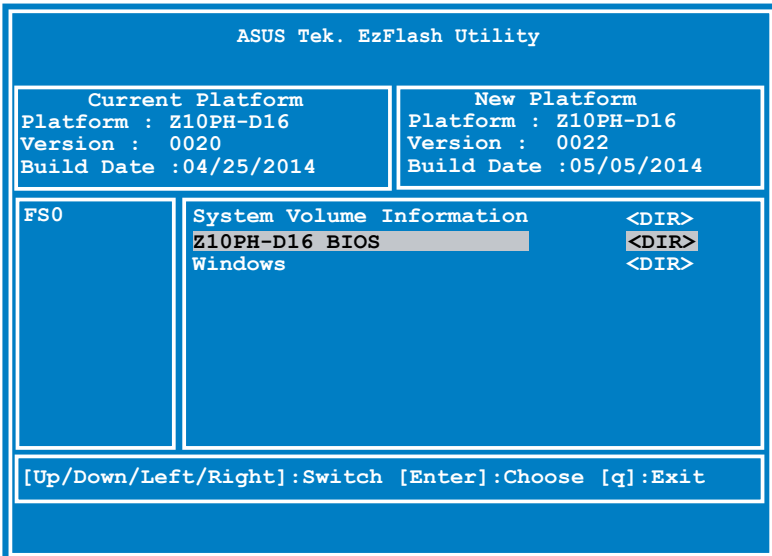

3. Press <Tab> to switch to the **Drive** field.
4. Press the Up/Down arrow keys to find the USB flash disk that contains the latest BIOS, then press <Enter>.
5. Press <Tab> to switch to the **Folder Info** field.
6. Press the Up/Down arrow keys to find the BIOS file, and then press <Enter> to perform the BIOS update process. Reboot the system when the update process is done.



-
- This function can support devices such as a USB flash disk with FAT 32/16 format and single partition only.
 - DO NOT shut down or reset the system while updating the BIOS to prevent system boot failure!
-



Ensure to load the BIOS default settings to ensure system compatibility and stability. Press <F5> and select **Yes** to load the BIOS default settings.

5.1.3 BUPDATER utility



The succeeding BIOS screens are for reference only. The actual BIOS screen displays may not be the same as shown.

The BUPDATER utility allows you to update the BIOS file in the DOS environment using a bootable USB flash disk drive with the updated BIOS file.

Updating the BIOS file

To update the BIOS file using the BUPDATER utility:

1. Visit the ASUS website at www.asus.com and download the latest BIOS file for the motherboard. Save the BIOS file to a bootable USB flash disk drive.
2. Copy the BUPDATER utility (BUPDATER.exe) from the ASUS support website at support.asus.com to the bootable USB flash disk drive you created earlier.
3. Boot the system in DOS mode, then at the prompt, type:

```
BUPDATER /i [filename] .CAP
```

where [filename] is the latest or the original BIOS file on the bootable USB flash disk drive, then press <Enter>.

```
A:\>BUPDATER /i[file name].CAP
```

- The utility verifies the file, then starts updating the BIOS file.

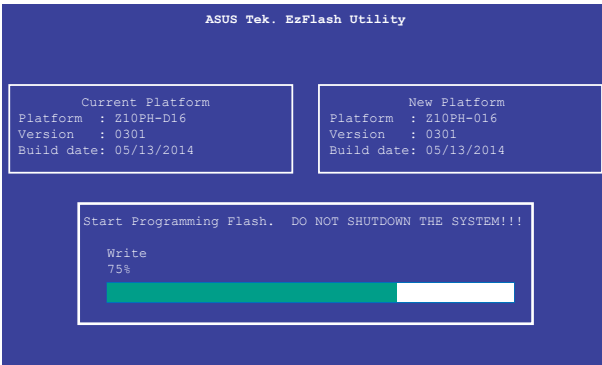

DO NOT shut down or reset the system while updating the BIOS to prevent system boot failure!

- The utility returns to the DOS prompt after the BIOS update process is completed. Reboot the system from the hard disk drive.

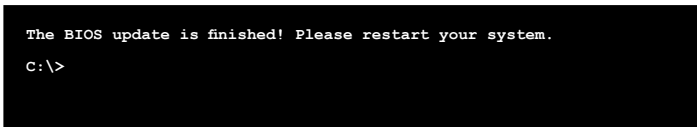

5.2 BIOS setup program

This motherboard supports a programmable firmware chip that you can update using the provided utility described in section 5.1 **Managing and updating your BIOS**.

Use the BIOS Setup program when you are installing a motherboard, reconfiguring your system, or prompted to “Run Setup.” This section explains how to configure your system using this utility.

Even if you are not prompted to use the Setup program, you can change the configuration of your computer in the future. For example, you can enable the security password feature or change the power management settings. This requires you to reconfigure your system using the BIOS Setup program so that the computer can recognize these changes and record them in the CMOS RAM of the firmware chip.

The firmware chip on the motherboard stores the Setup utility. When you start up the computer, the system provides you with the opportunity to run this program. Press during the Power-On Self-Test (POST) to enter the Setup utility; otherwise, POST continues with its test routines.

If you wish to enter Setup after POST, restart the system by pressing <Ctrl>+<Alt>+<Delete>, or by pressing the reset button on the system chassis. You can also restart by turning the system off and then back on. Do this last option only if the first two failed.

The Setup program is designed to make it as easy to use as possible. Being a menu-driven program, it lets you scroll through the various sub-menus and make your selections from the available options using the navigation keys.



- The default BIOS settings for this motherboard apply for most conditions to ensure optimum performance. If the system becomes unstable after changing any BIOS settings, load the default settings to ensure system compatibility and stability. Press <F5> and select **Yes** to load the BIOS default settings.
- The BIOS setup screens shown in this section are for reference purposes only, and may not exactly match what you see on your screen.
- Visit the ASUS website (www.asus.com) to download the latest BIOS file for this motherboard.

The system then runs the power-on self-test or POST. While the tests are running, the BIOS beeps or additional messages appear on the screen. If you do not see anything within 30 seconds from the time you turned on the power, the system may have failed a power-on test. Check the jumper settings and connections or call your retailer for assistance. The following shows the possible beep codes and its corresponding error condition.

BIOS Beep codes	
Beep	Error condition
1 short	Power supply surges detected during the previous power on.
1 short	No Keyboard Detected.
1 short, 2 short	No DIMM Detected.
1 short, 8 short	No VGA Detected.
2 long	Chassis Intrusion.
2 long	BIOS-image Crash Detected.

5.2.1 BIOS menu screen

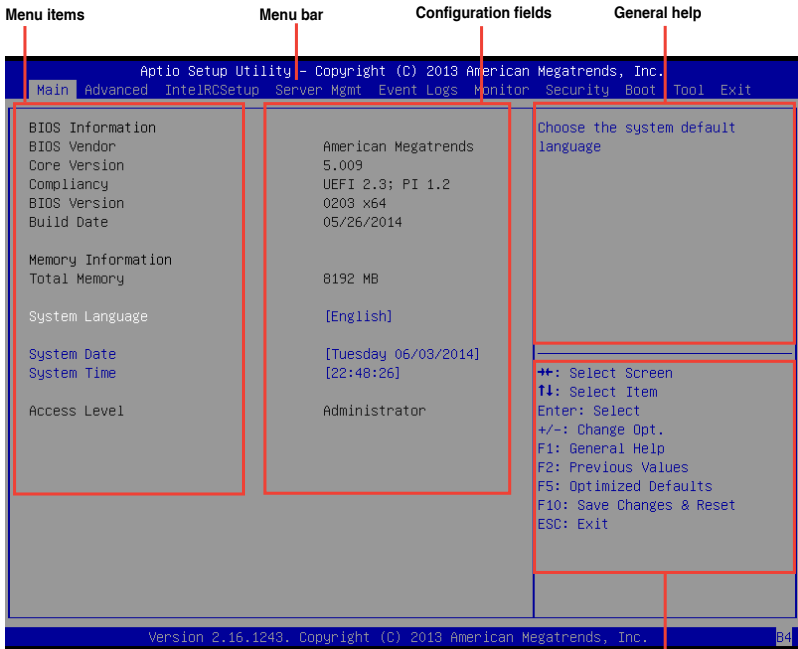

Navigation keys

5.2.2 Menu bar

The menu bar on top of the screen has the following main items:

- | | |
|---------------------|--|
| Main | For changing the basic system configuration |
| Advanced | For changing the advanced system settings |
| IntelRCSetup | For changing the Intel RC settings |
| Server Mgmt | For changing the Server Mgmt settings |
| Event Logs | For changing the event log settings |
| Monitor | For displaying the system temperature, power status, and changing the fan settings |
| Security | For changing the security settings |
| Boot | For changing the system boot configuration |
| Tool | For configuring options for special functions |
| Exit | For selecting the exit options |

To select an item on the menu bar, press the right or left arrow key on the keyboard until the desired item is highlighted.

5.2.3 Menu items

The highlighted item on the menu bar displays the specific items for that menu. For example, selecting **Main** shows the Main menu items.

The other items (Event Logs, Advanced, Monitor, Boot, Tool, and Exit) on the menu bar have their respective menu items.

5.2.4 Submenu items

A solid triangle before each item on any menu screen means that the item has a submenu. To display the submenu, select the item then press <Enter>.

5.2.5 Navigation keys

At the bottom right corner of a menu screen are the navigation keys for the BIOS setup program. Use the navigation keys to select items in the menu and change the settings.

5.2.6 General help

At the top right corner of the menu screen is a brief description of the selected item.

5.2.7 Configuration fields

These fields show the values for the menu items. If an item is user-configurable, you can change the value of the field opposite the item. You cannot select an item that is not user-configurable.

A configurable field is enclosed in brackets, and is highlighted when selected. To change the value of a field, select it and press <Enter> to display a list of options.

5.2.8 Pop-up window

Select a menu item and press <Enter> to display a pop-up window with the configuration options for that item.

5.2.9 Scroll bar

A scroll bar appears on the right side of a menu screen when there are items that do not fit on the screen. Press the Up/Down arrow keys or <Page Up> /<Page Down> keys to display the other items on the screen.

5.3 Main menu

When you enter the BIOS Setup program, the Main menu screen appears. The Main menu provides you an overview of the basic system information, and allows you to set the system date, time, language, and security settings.

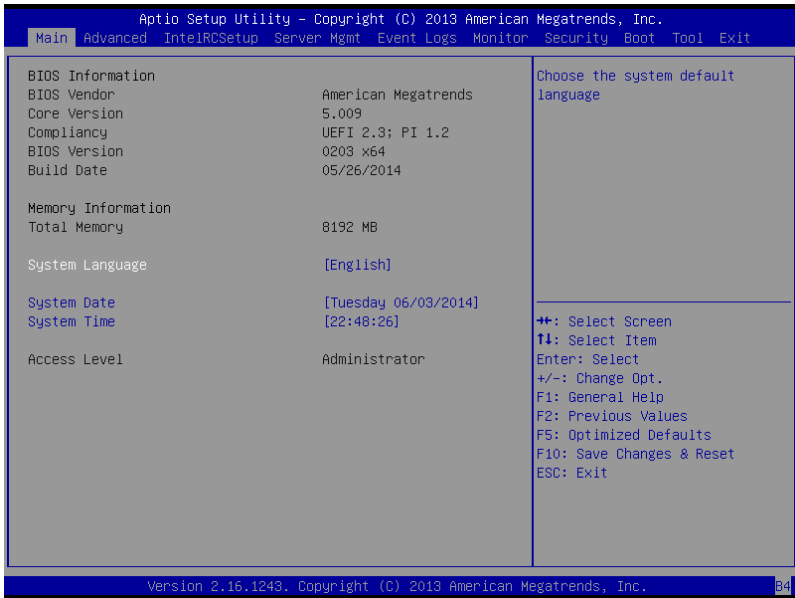

5.3.1 System Date [Day xx/xx/xxxx]

Allows you to set the system date.

5.3.2 System Time [xx:xx:xx]

Allows you to set the system time.

5.4 Advanced menu

The Advanced menu items allow you to change the settings for the CPU and other system devices.



Take caution when changing the settings of the Advanced menu items. Incorrect field values can cause the system to malfunction.

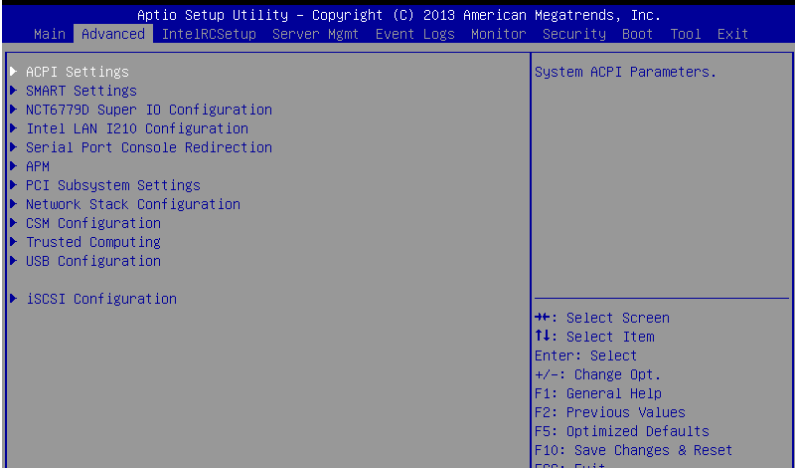

5.4.1 ACPI Settings

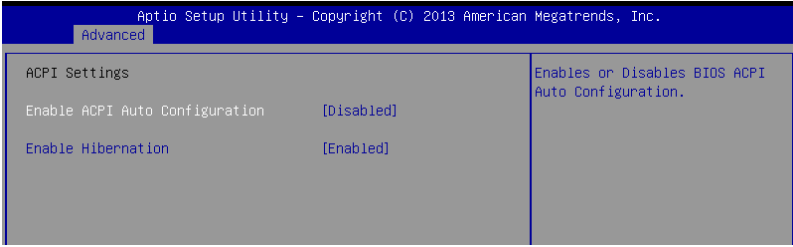

Enable ACPI Auto Configuration [Disabled]

Allows you to enable or disable the BIOS ACPI Auto Configuration.

Configuration options: [Disabled] [Enabled]

Enable Hibernation [Enabled]

Allows you to enable or disable the ability of the system to hibernate (OS/Sleep State).

Configuration options: [Disabled] [Enabled]



This option may be not effective with some OS.

5.4.2 Smart Settings

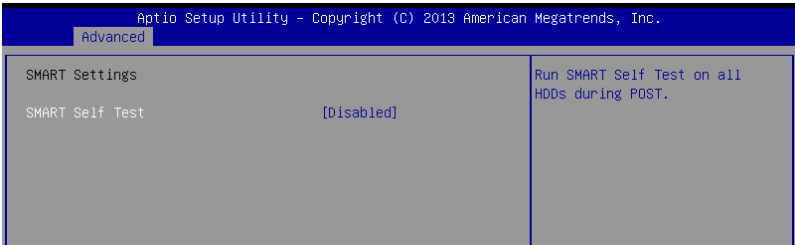

SMART Self Test [Disabled]

Allows you to run SMART Self Test on all HDDs during POST.

Configuration options: [Disabled] [Enabled]

5.4.3 NCT6779D Super IO Configuration

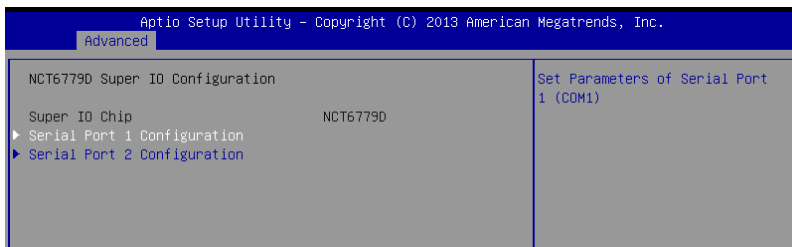

Serial Port 1 / Serial Port 2 Configuration

Allows you to set the parameters of Serial Port 1/ Serial Port 2.

Serial Port [Enabled]

Allows you to enable or disable Serial Port.

Configuration options: [Disabled] [Enabled]

Change Settings [Auto]

Allows you to choose the setting for Super IO device.

Configuration options: [Auto] [IO=3F8h; IRQ=4;] [IO=3F8h; IRQ=3, 4, 5, 6, 7, 9, 10, 11, 12;]
[IO=2F8h; IRQ=3, 4, 5, 6, 7, 9, 10, 11, 12;] [IO=3E8h; IRQ=3, 4, 5, 6, 7, 9, 10, 11, 12;]
[IO=2E8h; IRQ=3, 4, 5, 6, 7, 9, 10, 11, 12;]

5.4.4 Onboard LAN I210 Configuration

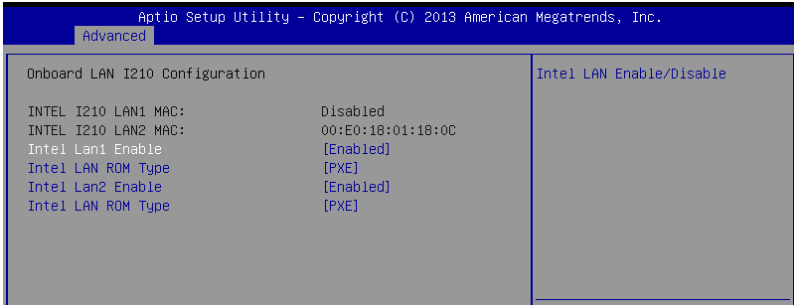

Intel LAN I210 LAN1 / LAN2 Enable [Enabled]

Allows you to enable or disable the Intel LAN.

Configuration options: [Disabled] [Enabled]



The following items appear only when Intel LAN I210 LAN1 / LAN2 Enable is set to [Enabled].

LAN1/ LAN2 Option ROM Support [Enabled]

Allows you to load the Intel LAN ROM.

Configuration options: [Disabled] [Enabled]

Intel LAN ROM Type [PXE]

Allows you to select the Intel LAN ROM type.

Configuration options: [PXE] [iSCSI]

5.4.5 Serial Port Console Redirection

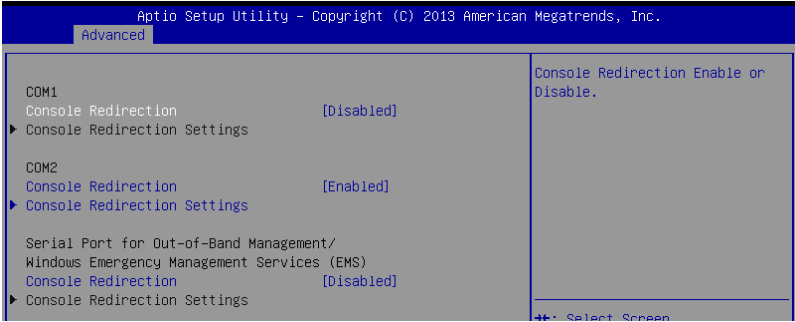

COM1/COM2

Console Redirection [Enabled]

Allows you to enable or disable the console redirection feature.

Configuration options: [Disabled] [Enabled]



The following item appears only when you set **Console Redirection** to [Enabled].

Console Redirection Settings

This item becomes configurable only when you enable the **Console Redirection** item. The settings specify how the host computer and the remote computer (which the user is using) will exchange data. Both computers should have the same or compatible settings.

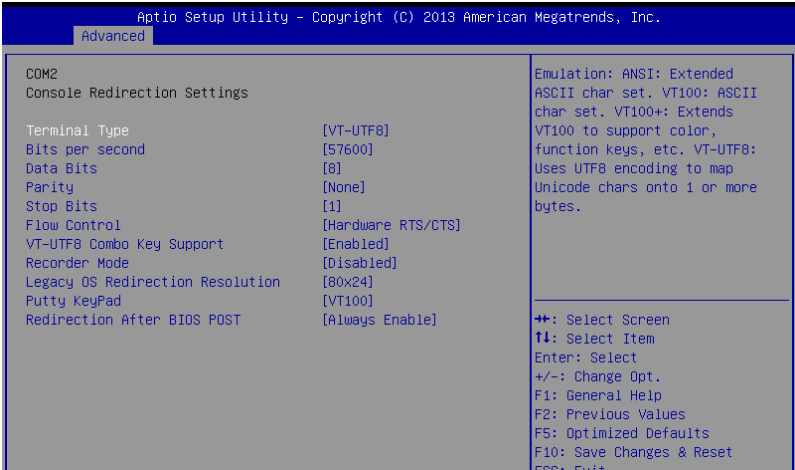

Terminal Type [VT-UTF8]

Allows you to set the terminal type.

[VT100]	ASCII char set.
[VT100+]	Extends VT100 to support color, function keys, et.
[VT-UTF8]	Uses UTF8 encoding to map Unicode chars onto 1 or more bytes
[ANSI]	Extended ASCII char set

Bits per second [57600]

Selects serial port transmission speed. The speed must be matched on the other side. Long or noisy lines may require lower speeds.

Configuration options: [9600] [19200] [38400] [57600] [115200]

Data Bits [8]

Configuration options: [7] [8]

Parity [None]

A parity bit can be sent with the data bits to detect some transmission errors. [Mark] and [Space] parity do not allow for error detection.

[None]	None
[Even]	parity bit is 0 if the num of 1's in the data bits is even
[Odd]	parity bit is 0 if num of 1's in the data bits is odd
[Mark]	parity bit is always 1
[Space]	parity bit is always 0

Stop Bits [1]

Stop bits indicate the end of a serial data packet. (A start bit indicates the beginning.) The standard setting is 1 stop bit. Communication with slow devices may require more than 1 stop bit.

Configuration options: [1] [2]

Flow Control [Hardware RTS/CTS]

Flow control can prevent data loss from buffer overflow. When sending data, if the receiving buffers are full, a "stop" signal can be sent to stop the data flow. Once the buffers are empty, a "start" signal can be sent to re-start the flow. Hardware flow control uses two wires to send start/stop signals.

Configuration options: [None] [Hardware RTS/CTS]

VT -UTF8 Combo Key Support [Enabled]

This allows you to enable the VT -UTF8 Combination Key Support for ANSI/VT100 terminals. Configuration options: [Disabled] [Enabled]

Recorder Mode [Disabled]

With this mode enabled only text will be sent. This is to capture Terminal data.

Configuration options: [Disabled] [Enabled]

Legacy OS Redirection Resolution [80x24]

This allows you to set the number of rows and columns supported on the Legacy OS.

Configuration options: [80x24] [80x25]

Putty Keypad [VT100]

This allows you to select the FunctionKey and Keypad on Putty.

Configuration options: [VT100] [LINUX] [XTERMR6] [SCO] [ESCN] [VT400]

Redirection After BIOS POST [Always Enable]

This setting allows you to specify if Bootloader is selected than Legacy console redirection.

Configuration options: [Always Enable] [Bootloader]

Serial Port for Out-of-Band Management/

Windows Emergency Management Services (EMS)

Console Redirection [Disabled]

Allows you to enable or disable the console redirection feature.

Configuration options: [Disabled] [Enabled]



The following item appears only when you set **Console Redirection** to [Enabled].

Console Redirection Settings

Out-of-Band Mgmt Port [COM1]

Microsoft Windows Emergency Management Services (EMS) allow for remote management of a Windows Server OS through a serial port.

Configuration options: [COM1] [COM2]

Terminal Type [VT-UTF8]

Microsoft Windows Emergency Management Services (EMS) allow for remote management of a Windows Server OS through a serial port.

Configuration options: [VT100] [VT100+] [VT-UTF8] [ANSI]

Bits per second [115200]

Microsoft Windows Emergency Management Services (EMS) allow for remote management of a Windows Server OS through a serial port.

Configuration options: [9600] [19200] [57600] [115200]

Flow Control [None]

Microsoft Windows Emergency Management Services (EMS) allow for remote management of a Windows Server OS through a serial port.

Configuration options: [None] [Hardware RTS/CTS] [Software Xon/Xoff]

5.4.6 APM

Allows you to configure the Advance Power Management (APM) settings.

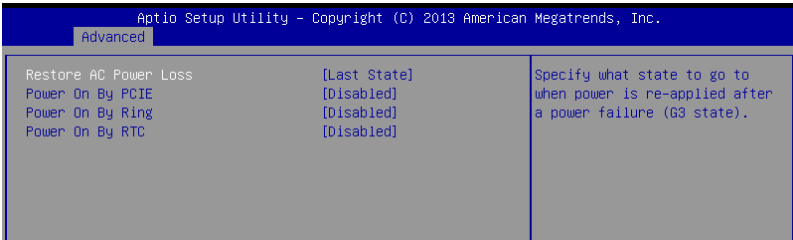

Restore AC Power Loss [Last State]

When set to [Power Off], the system goes into off state after an AC power loss. When set to [Power On], the system will reboot after an AC power loss. When set to [Last State], the system goes into either off or on state, whatever the system state was before the AC power loss.

Configuration options: [Power Off] [Power On] [Last State]

Power On By PCIE [Disabled]

[Disabled] Disables the PCIE devices to generate a wake event.

[Enabled] Enables the PCIE devices to generate a wake event.

Power On By Ring [Disabled]

[Disabled] Disables the PCIE devices to generate a wake event.

[Enabled] Enables the PCIE devices to generate a wake event.

Power On By RTC [Disabled]

[Disabled] Disables RTC to generate a wake event.

[Enabled] When set to [Enabled], the items **RTC Alarm Date (Days)** and **Hour/Minute/Second** will become user-configurable with set values.

5.4.7 PCI Subsystem Settings

Allows you to configure PCI, PCI-X, and PCI Express Settings.

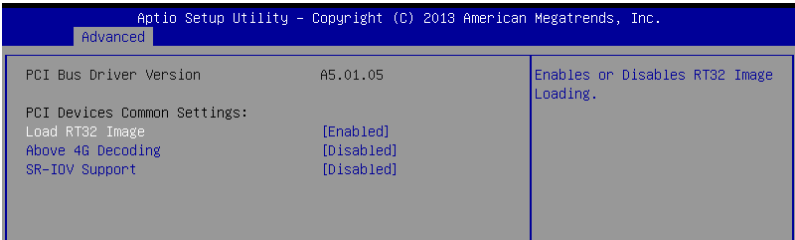

Load RT32 Image [Enabled]

Allows you to enable or disable RT32 Image Loading.

Configuration options: [Disabled] [Enabled]

Above 4G Decoding [Disabled]

Allows you to enable or disable 64-bit capable devices to be decoded in above 4G address space. It only works if the system supports 64-bit PCI decoding.

Configuration options: [Disabled] [Enabled]

SR-IOV Support [Disabled]

This option enables or disables Single Root IO Virtualization Support if the system has SR-IOV capable PCIe devices.

Configuration options: [Disabled] [Enabled]

5.4.8 Network Stack Configuration

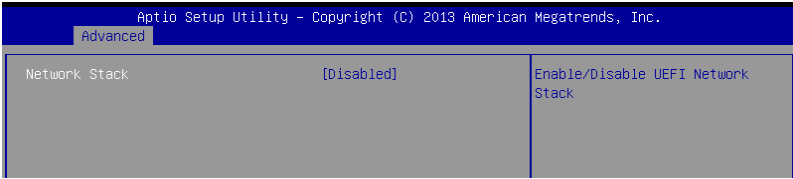

Network stack [Disabled]

Enables or disables the network stack feature. Configuration options: [Disable] [Enable]



The following item appears only when **Network stack** is set to [Enabled].

Ipv4 PXE Support [Enabled]

Enables or disables the Ipv4 PXE Boot Support. If disabled, Ipv4 PXE boot option will not be created.

Configuration options: [Disabled] [Enabled].

Ipv6 PXE Support [Enabled]

Enables or disables the Ipv6 PXE Boot Support. If disabled, Ipv6 PXE boot option will not be created.

Configuration options: [Disabled] [Enabled].

PXE boot wait time [0]

Wait time to press ESC key to abort the PXE boot.

Media detect time [0]

Wait time (in seconds) to detect media.

5.4.9 CSM Configuration

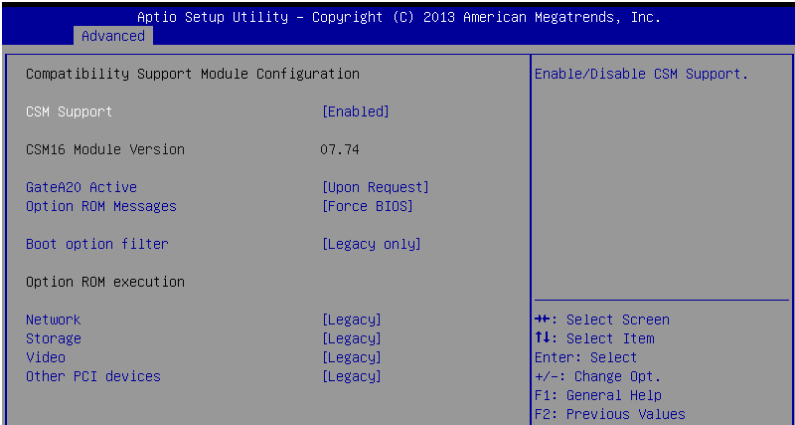

CSM Support [Enabled]

This option allows you to enable or disable CSM Support.

Configuration options: [Disabled] [Enabled]

GateA20 Active [Upon Request]

This allows you to set the GA20 option.

Configuration options: [Upon Request] [Always]

Option ROM Messages [Force BIOS]

This allows you to set the display mode for option ROM.

Configuration options: [Force BIOS] [Keep Current]

Boot Option filter [Legacy only]

This option allows you to control the Legacy/UEFI ROMs priority.

Configuration options: [UEFI and Legacy] [Legacy only] [UEFI only]

Network / Storage / Video [Legacy]

This option allows you to control the execution of UEFI and Legacy PXE/ Storage/ Video OpROM.

Configuration options: [UEFI] [Legacy]

Other PCI devices [Legacy]

This item determines the OpROM execution policy for devices other than Network, Storage, or Video.

Configuration options: [UEFI] [Legacy]

5.4.10 Trusted Computing

Aptio Setup Utility - Copyright (C) 2013 American Megatrends, Inc.		
Advanced		
Configuration		
Security Device Support	[Disabled]	Enables or Disables BIOS support for security device. O.S. will not show Security Device. TCG EFI protocol and INT1A interface will not be available.
Current Status Information		
NO Security Device Found		

Configuration

Security Device Support [Disabled]

Allows you to enable or disable the BIOS support for security device.

Configuration options: [Disabled] [Enabled]

5.4.11 USB Configuration

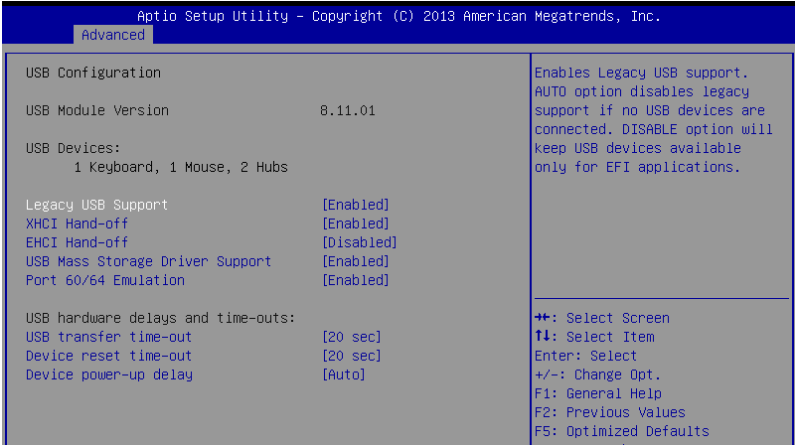

Legacy USB Support [Enabled]

Allows you to enable or disable Legacy USB device support.

Configuration options: [Enabled] [Disabled] [Auto]

XHCI Hand-off [Enabled]

This is a workaround for OSes without XHCI hand-off support. The XHCI ownership change should be claimed by XHCI driver.

Configuration options: [Disabled] [Enabled]

EHCI Hand-off [Disabled]

This is a workaround for OSes without EHCI hand-off support. The EHCI ownership change should be claimed by EHCI driver.

Configuration options: [Disabled] [Enabled]

USB Mass Storage Driver Support [Enabled]

Allows you to enable or disable the USB Mass Storage driver support.

Configuration options: [Disabled] [Enabled]

Port 60/64 Emulation [Enabled]

This allows you to enable the I/O port 60h/64h emulation support. This should be enabled for the complete USB keyboard legacy support for non-USB aware OSes.

Configuration options: [Disabled] [Enabled]

USB hardware delays and time-outs

USB transfer time-out [20 sec]

The time-out value for control, bulk, and interrupt transfer.

Configuration options: [1 sec] [5 sec] [10 sec] [20 sec]

Device reset time-out [20 sec]

USB mass storage device start unit command time-out.

Configuration options: [10 sec] [20 sec] [30 sec] [40 sec]

Device power-up delay [Auto]

This is the maximum time the device will take before it properly reports itself to the host controller.

Configuration options: [Auto] [Manual]

Mass Storage Devices

Generic 8.07 [Auto]

Allows you to select the mass storage device emulation type.

Configuration options: [Auto] [Floppy] [Forced FDD] [Hard Disk] [CD-ROM]

5.4.12 iSCSI Configuration

Allows you to configure the iSCSI parameters.

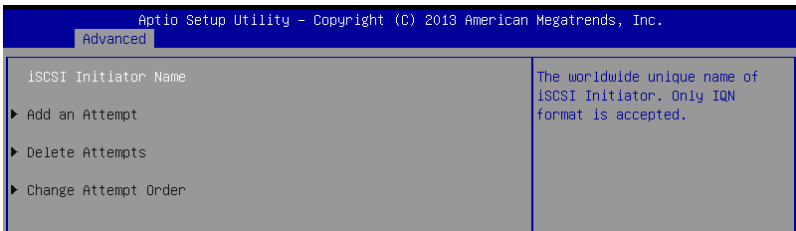

5.5 IntelRCSetup menu

The IntelRCSetup menu items allow you to change the processor and chipset settings.

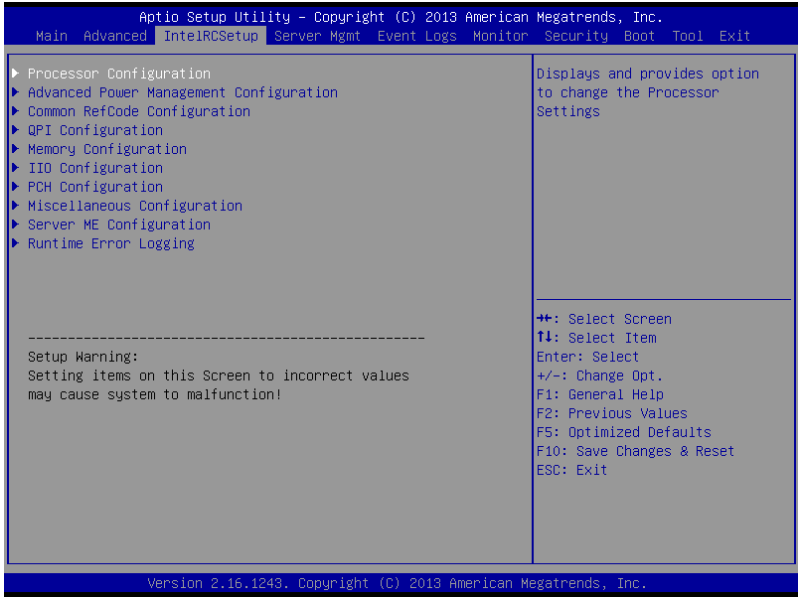

5.5.1 Processor Configuration

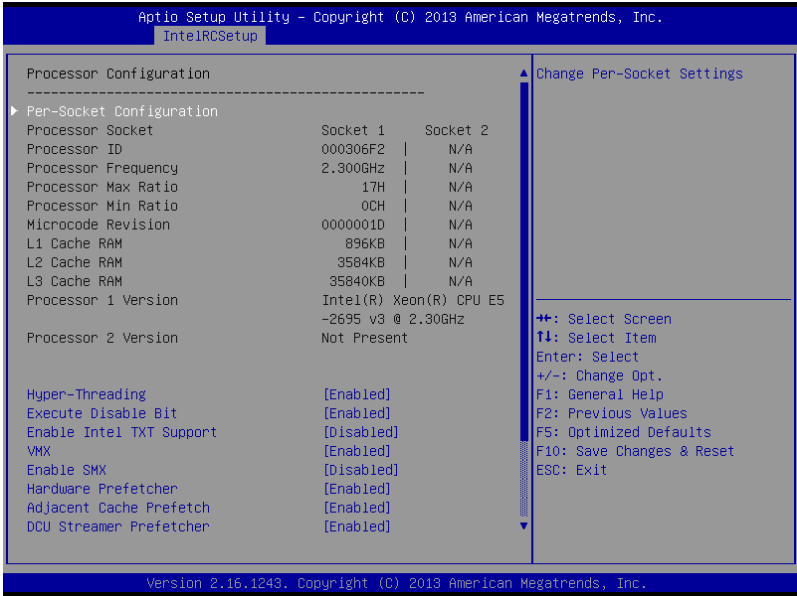

Per Socket Configuration

Allows you to set the number of cores to enable. 0 means all cores. Total of 14 cores available.

Hyper Threading [Enabled]

Allows you to enable or disable the Intel® Hyper-Threading Technology function. When disabled, only one thread per activated core is enabled.

Configuration options: [Disabled] [Enabled]

Execute Disable Bit [Enabled]

XD can prevent certain classes of malicious buffer overflow attacks when combined with a supporting OS (Windows Server 2003 SP1, Windows XP SP2, SuSE Linux 9.2, Redhat Enterprise 3 Update 3).

Configuration options: [Disabled] [Enabled]

Enable Intel TXT Support [Disabled]

Forces the XD feature log to always return 0 when disabled.

Configuration options: [Disabled] [Enabled]

VMX [Enabled]

Enables the Vanderpool Technology. Takes effect after reboot.

Configuration options: [Disabled] [Enabled]

Enable SMX [Disabled]

Enables the Safer Mode Extensions

Configuration options: [Disabled] [Enabled]

Hardware Prefetcher [Enabled]

This Item allows you to turn on/off the mid level cache(L2) streamer prefetcher.

Configuration options: [Disabled] [Enabled]

Adjacent Cache Prefetch [Enabled]

This Item allows you to turn on/off prefetching of adjacent cache lines.

Configuration options: [Disabled] [Enabled]

DCU Streamer Prefetcher [Enabled]

This Item allows you to enable or disable prefetcher of next L1 data line.

Configuration options: [Disabled] [Enabled]

DCU IP Prefetcher [Enabled]

This Item allows you to enable or disable prefetch of next L1 line based upon sequential load history.

Configuration options: [Disabled] [Enabled]

DCU Mode [32K 8Way Without ECC]

Configuration options: [32K 8Way Without ECC] [16K 4Way With ECC]

Direct Cache Access (DCA) [Auto]

This Item allows you to enable or disable Direct Cache Access.

Configuration options: [Auto] [Disabled] [Enabled]

DCA Prefetch Delay [32]

This Item allows you to set the time for the DCA Prefetch delay Help.

Configuration options: [Disabled] [8] [16] [24] [32] [40] [48] [56] [64] [72] [80] [88] [96] [104] [112]

AES-NI [Enabled]

This Item allows you to enable or disable the AES-NI support.

Configuration options: [Disabled] [Enabled]

Down Stream PECI [Disabled]

This Item allows you to enable the PCIe Down Stream PECI writer.

Configuration options: [Disabled] [Enabled]

5.5.2 Advanced Power Management Configuration



Power Technology [Energy Efficient]

This item allows you to enable power management features.
Configuration options: [Disabled] [Energy Efficient] [Custom]

Config TDP [Disabled]

This item allows you to enable/disable the Config TDP.
Configuration options: [Disabled] [Enabled]

CPU Advanced PM Turning

This item allows you to set additional CPU Power Management settings.

Energy Perf BIAS

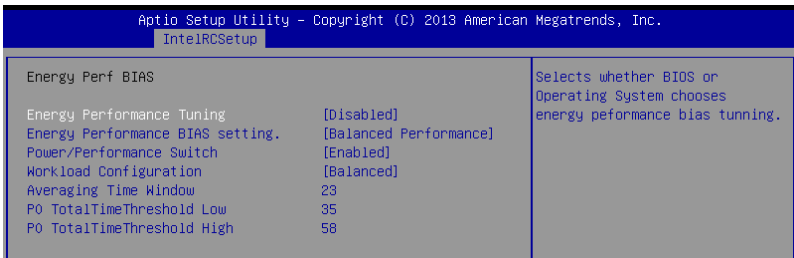

Energy Performance Tuning [Disabled]

Allows your system to select from BIOS or operating system to choose enable energy performance bias tuning.
Configuration options: [Disabled] [Enabled]

Energy Performance Bias setting [Balanced Performance]

Allows you to set the Energy Performance Bias which overrides the OS setting.
Configuration options: [Performance] [Balanced Performance] [Balanced Power] [Power]

Power/Performance Switch [Enabled]

Allows you to switch between Power or performance.

Configuration options: [Disabled] [Enabled]

Workload Configuration [Balanced]

Optimization for the workload characterization.

Configuration options: [Balanced] [I/O sensitive]

Averaging Time Window [23]

This is used to control the effective window of the average for CO and PO time.

PO TotalTimeThreshold Low [35]

The HW switching mechanism disables the performance setting (0) when the total PO time is less than this threshold.

PO TotalTimeThreshold High [58]

The HW switching mechanism enables the performance setting (0) when the total PO time is greater than this threshold.

5.5.3 Common RefCode Configuration

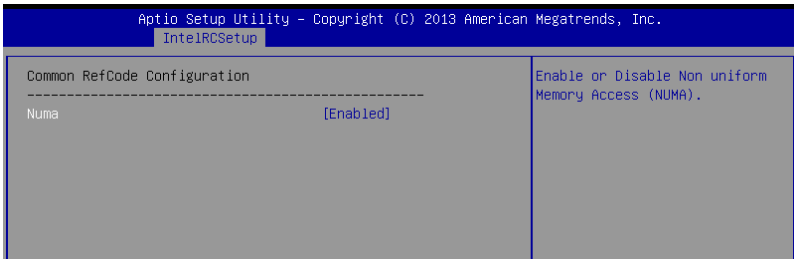

Numa [Enabled]

This item enables or disables the Non uniform Memory Access (NUMA).

Configuration options: [Disabled] [Enabled]

5.5.4 QPI Configuration

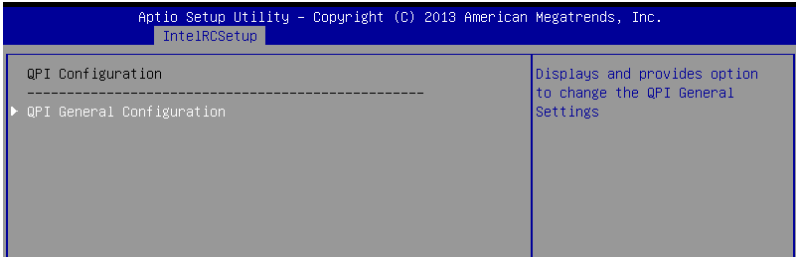

QPI General Configuration

QPI Status

This item displays information about the QPI status.

Link Speed Mode [Fast]

This item allows you to select the QPI link speed as either the fast mode or slow mode.

Configuration options: [Slow] [Fast]

Link Frequency Select [Auto]

This item allows you for selecting the QPI link frequency

Configuration options: [Auto] [6.4 GT/s] [8.0 GT/s] [9.6 GT/s]

QPI Link0p Enable [Enable]

Configuration options: [Disable] [Enable]

QPI Link1 Enable [Enable]

Configuration options: [Disable] [Enable]

QPI Status

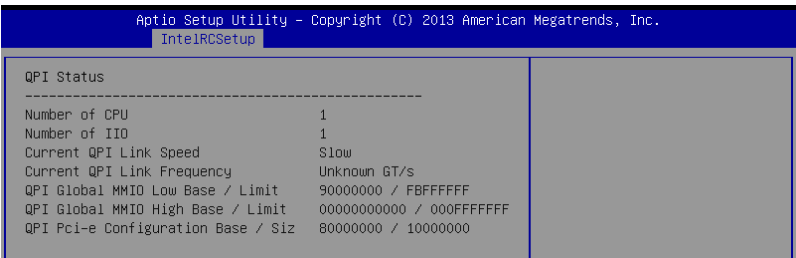

5.5.5 Memory Configuration

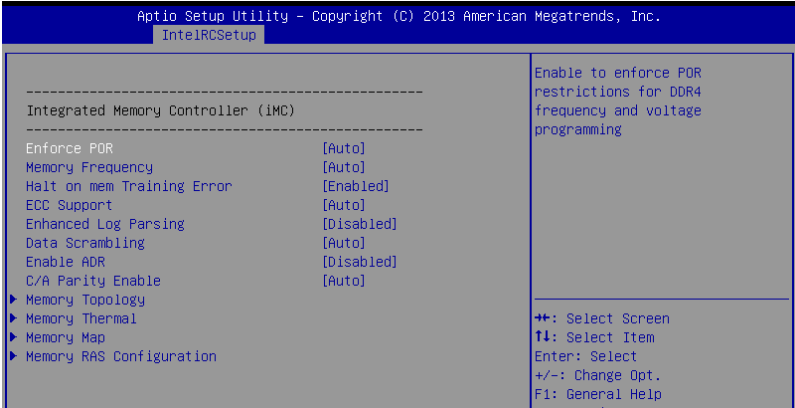

Enforce POR [Auto]

Allows you to enforce POR restrictions for DDR4 frequency and voltage programming.

Configuration options: [Auto] [Enforce POR] [Disabled] [Enforce Stretch Goals]

Memory Frequency [Auto]

Allows you to select the memory frequency setting.

Configuration options: [Auto] [1333] [1600] [1866] [2133]

Halt on mem Training Error [Enabled]

Allows you to enable or disable halt on mem Training Error.

Configuration options: [Disabled] [Enabled]

ECC Support [Auto]

Allows you to enable or disable the ECC support.

Configuration options: [Auto] [Disabled] [Enabled]

Enhanced Log Parsing [Disabled]

Allows you to enable or disable the Enhanced Log Parsing.

Configuration options: [Auto] [Disabled] [Enabled]

Data Scrambling [Auto]

Allows you to enable/disable data scrambling.

Configuration options: [Auto] [Disabled] [Enabled]

Enable ADR [Disabled]

Allows you to set the detecting and enabling of ADR.

Configuration options: [Disabled] [Enabled]

C/A Parity Enable [Auto]

Allows you to enable or disable the DDR4's command address parity.

Configuration options: [Auto] [Disabled] [Enabled]

Memory Topology

Displays memory topology with DIMM population information.

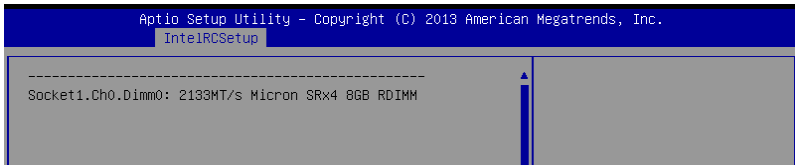

Memory Thermal

Allows you to configure thermal settings.

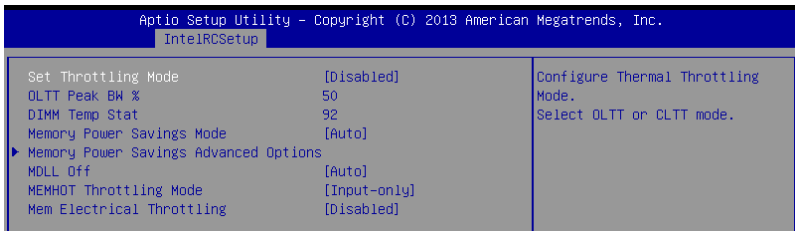

Set Throttling Mode [Disabled]

Configuration options: [Disabled] [OLTT] [CLTT]

OLTT Peak BW [xxx]

Allows you to set the peak allowed bandwidth for OLTT. This is in percentage and valid offset values is from 25-100.

DIMM Tem Stat [xx]

Allows you to select DIMMTEMPSTAT as temp_mid or temp_hi.

Memory Power Savings Mode [Auto]

Allows you to configure the CKE and other related Memory Power Savings features.

Configuration options: [Auto] [Disabled] [APD On] [User Defined] [Reserve] [Reserved]

Memory Power Savings Advanced Options

CK in SR [Auto]

Configuration options: [Auto] [Driven] [Tri-State] [Pulled Low] Pulled High]

MDLL Off [Auto]

Allows you to shutdown MDLL during SR when enabled.

Configuration options: [Auto] [Disabled] [Enabled]

MEMHOT Throttling Mode [Input-only]

Allows you to shutdown MDLL during SR when enabled.

Configuration options: [Disabled] [Input-only] [Output-only]

Mem Electrical Throttling [Disabled]

Allows you to configure Memory Electrical throttling.

Configuration options: [Disabled] [Enabled] [Auto]

Memory Map

Aptio Setup Utility - Copyright (C) 2013 American Megatrends, Inc.		
IntelRCSetup		
Channel Interleaving	[Auto]	Select Channel Interleaving setting
Rank Interleaving	[Auto]	

Channel Interleaving [Auto]

Select different channel interleaving setting.

Configuration options: [Auto] [1-way Interleave] [2-way Interleave] [3-way Interleave] [4-way Interleave]

Rank Interleaving [Auto]

Select different rank interleaving setting.

Configuration options: [Auto] [1-way Interleave] [2-way Interleave] [4-way Interleave] [8-way Interleave]

Memory RAS Configuration

Aptio Setup Utility - Copyright (C) 2013 American Megatrends, Inc.		
IntelRCSetup		
----- Memory RAS Configuration Setup -----		Enable/Disable RAS modes. Enabling Sparing and Mirroring is not supported. In case if enabled, Sparing will be selected.
RAS Mode	[Disabled]	
Memory Rank Sparing	[Disabled]	
Correctable Error Threshold	32767	
Patrol Scrub	[Enabled]	
Demand Scrub	[Enabled]	

RAS Mode [Disabled]

Allows you to enable or disable RAS Modes. Enabling Sparing and Mirroring is not supported. In case enabled, Sparing will be selected.

Configuration options: [Disabled] [Mirror] [Lockstep Mode]

Memory Rank Sparing [Disabled]

Allows you to enable or disable Memory Rank Sparing.

Configuration options: [Disabled] [Enabled]

Correctable Error Threshold [32767]

Allows you to set the Correctable Error Threshold used for sparing, tagging, and leaky bucket. The range is from 1 to 32767.

Patrol Scrub [Enabled]

Allows you to enable or disable Patrol Scrub.

Configuration options: [Disabled] [Enabled]

Demand Scrub [Enabled]

Allows you to enable or disable Demand Scrub.

Configuration options: [Disabled] [Enabled]

5.5.6 IIO Configuration

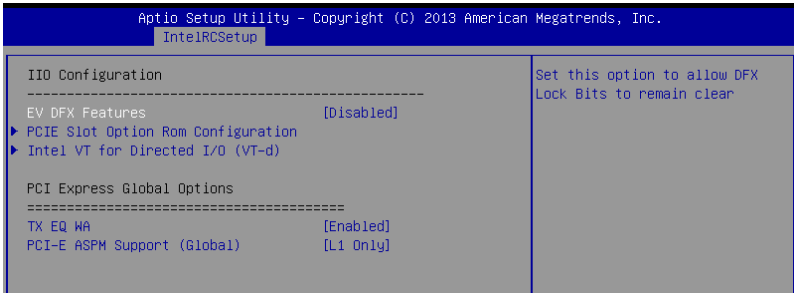

EV DFX Features [Disabled]

Set this option to allow DFX Lock Bits to remain clear.

Configuration options: [Disabled] [Enabled]

PCI Express Global Options

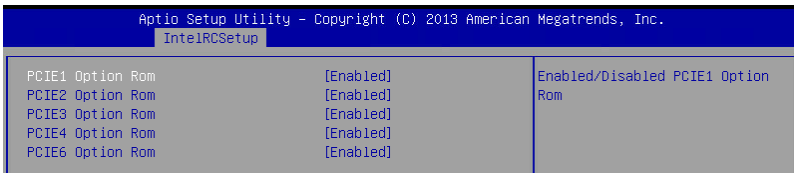

PCIE1/ PCIE2 Option ROM [Enabled]

Allows you to enable or disable the PCIE1/ PCIE2 Option ROM.

Configuration options: [Disabled] [Enabled]

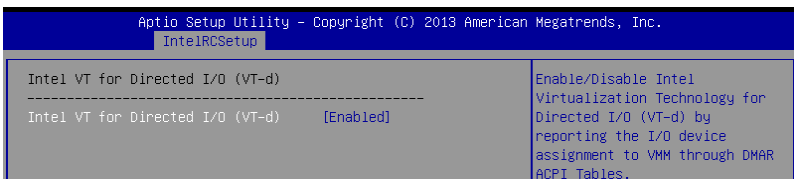

Intel VT for Directed I/O (VT-d)

Intel VT for Directed I/O (VT-d) [Enabled]

Allows you to enable or disable the Intel Virtualization Technology for Directed I/O.

Configuration options: [Disabled] [Enabled]

PCI Express Global Options

TX EQ WA [Enabled]

Use special table for TX_EQ and vendor specific cards.

Configuration options: [Disabled] [Enabled]

PCI-E ASPM Support (Global) [L1 Only]

This option enables or disables the ASPM support for all downstream devices.
Configuration options: [Disabled] [L1 Only]

5.5.7 PCH Configuration

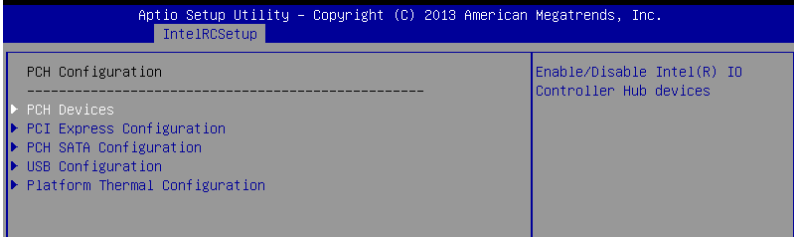

PCH Devices

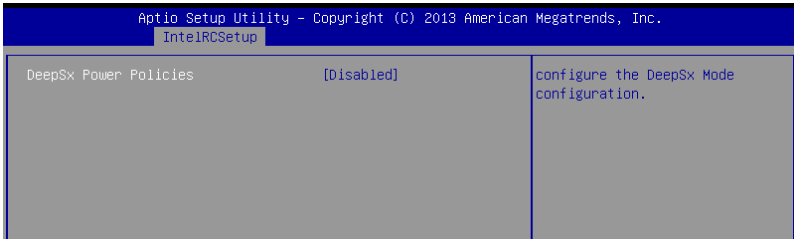

DeepSx Power Policies [Disabled]

Allows you to configure the DeepSx Mode configuration.
Configuration options: [Disabled] [Enabled in S5] [Enabled in S4 and S5]

PCI Express Configuration

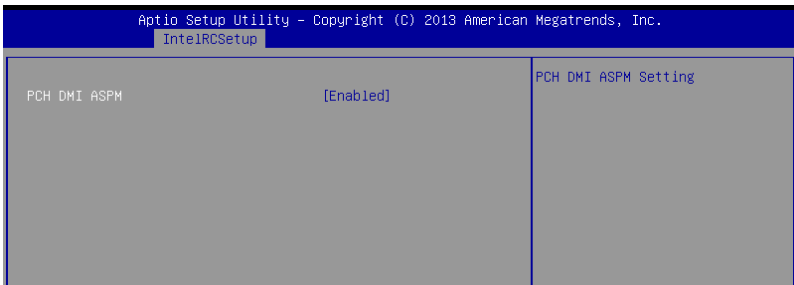

PCH DMI ASPM [Enabled]

Allows you to configure the PCH DMI ASPM.
Configuration options: [Disabled] [Enabled]

PCH SATA Configuration

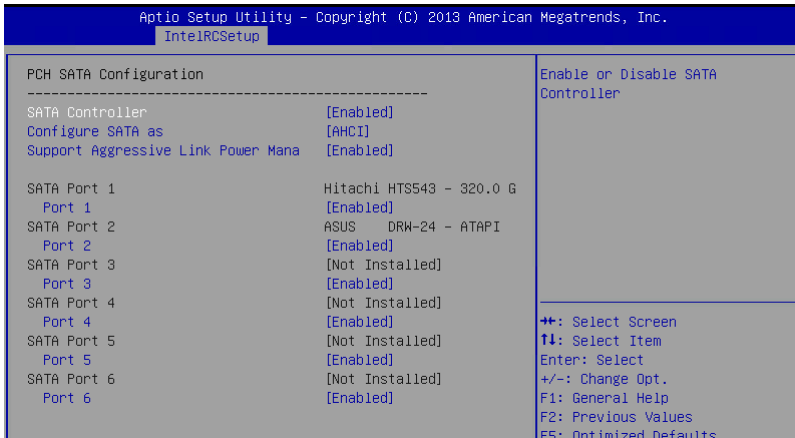

SATA Controller [Enabled]

Allows you to enable or disable the SATA Controller.

Configuration options: [Disabled] [Enabled]

Configure SATA as [AHCI]

Allows you to identify the SATA port is connected to Solid State Drive or Hard Disk Drive.

Configuration options: [IDE] [AHCI] [RAID]

Support Aggressive Link Power Management [Enabled]

Allows you to enable or disable the Support Aggressive Link Power (SALP) Management.

Configuration options: [Disabled] [Enabled]

SATA Port 1~6

Port 1/ Port 2/ Port 3/ Port 4/ Port 5/ Port 6 [Enabled]

Allows you to enable or disable the SATA port

Configuration options: [Disabled] [Enabled]

USB Configuration

Aptio Setup Utility - Copyright (C) 2013 American Megatrends, Inc.		
IntelRCSetup		
xHCI Mode	[Auto]	Mode of operation of xHCI controller.
USB Ports Per-Port Disable Control	[Disabled]	

xHCI Mode [Auto]

Allows you to enable or disable the mode of operation of xHCI controller.

Configuration options: [Auto] [Disabled] [Enabled]

USB Ports Per-Port Disable Control [Disabled]

Allows you to control each of the USB ports 1 to 8 disabling.

Configuration options: [Disabled] [Enabled]



The following items appears only when the USB Ports Per-Port Disable Control is set to [Enabled].

USB Port #1/ #2/ #3/ [Enabled]

Configuration options: [Disabled] [Enabled]

USB 3.0 Port #1/ #2/ [Enabled]

Configuration options: [Disabled] [Enabled]

Platform Thermal Configuration

Aptio Setup Utility - Copyright (C) 2013 American Megatrends, Inc.		
IntelRCSetup		
PCH Thermal Device	[Auto]	Enable/Disable PCH Thermal Device(D31:F6)
Alert Enable Lock	[Disabled]	

PCH Thermal Device [Auto]

Allows you to enable or disable the PCH Thermal Device (D31:F6).

Configuration options: [Auto] [Disabled] [Enabled]

Alert Enable Lock [Disabled]

Allows you to lock all Alert Enable settings.

Configuration options: [Disabled] [Enabled]

5.5.8 Miscellaneous Configuration

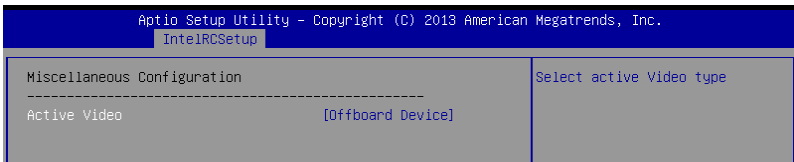

Active Video [Offboard Device]

Allows you to select the video type.

Configuration options: [Onboard Device] [Offboard Device]

5.5.9 Server ME Configuration

Displays the Server ME Technology parameters on your system.

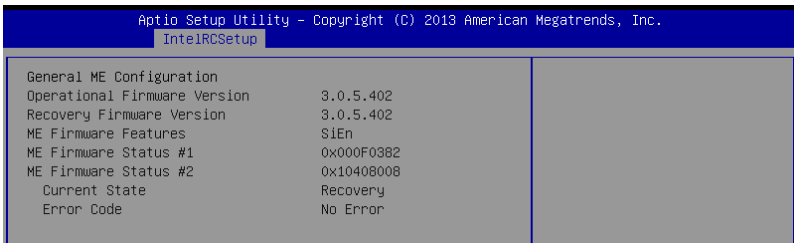

5.5.10 Runtime Error Logging Support

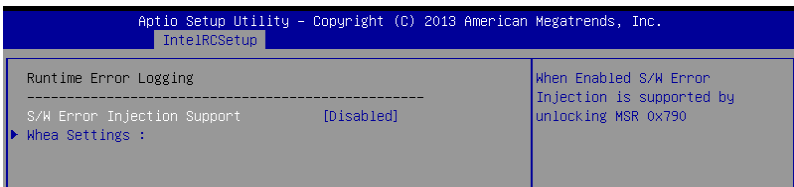

Runtime Error Logging

S/W Error Injection Support [Disabled]

When enabled, S/W Error Injection is supported by unlocking MSR 0x790.

Configuration options: [Disabled] [Enabled]

Whea Settings

Whea Support [Enabled]

This item allows you to enable or disable the WHEA support.

Configuration options: [Disabled] [Enabled]

5.6 Server Mgmt menu

The Server Management menu displays the server management status and allows you to change the settings.

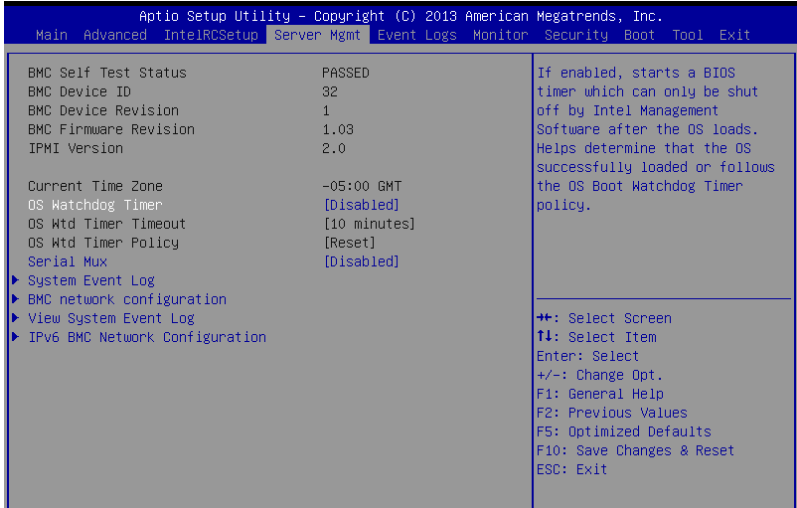

OS Watchdog Timer [Disabled]

This item allows you to start a BIOS timer which can only be shut off by Intel Management Software after the OS loads.

Configuration options: [Disabled] [Enabled]



The following items is configurable only when the OS Watchdog Timer is set to [Enabled].

OS Wtd Timer Timeout [10 minutes]

Allows you to configure the length fo the OS Boot Watchdog Timer.

Configuration options: [5 minutes] [10 minutes] [15 minutes] [20 minutes]

OS Wtd Timer Policy [Reset]

This item allows you to configure the how the system should respond if the OS Boot Watch Timer expires.

Configuration options: [Do Nothing] [Reset] [Power Down]

Serial Mux [Disabled]

This item allows you to enable or disable Serial Mux configuration.

Configuration options: [Disabled] [Enabled]

System Event Log

Allows you to change the SEL event log configuration.

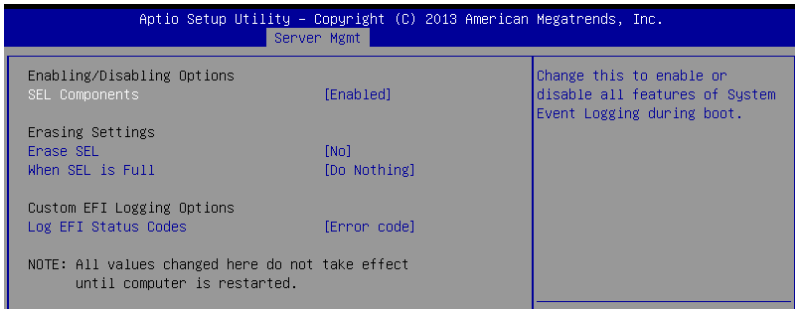

SEL Components [Enabled]

Allows you to enable or disable all features of system Event Logging during boot.

Configuration options: [Disabled] [Enabled]



- The following items appears only when you set **SEL Components** to [Enabled].
- All values changed here do not take effect until computer is restarted.

Erase SEL [No]

Allows you to choose options for erasing SEL.

Configuration options: [No] [Yes, On next reset] [Yes, On every reset]

When SEL is Full [Do Nothing]

Allows you to choose options for reactions to a full SEL.

Configuration options: [Do Nothing] [Erase Immediately]

Log EFI Status Codes [Error code]

Disable the logging of EFI Status Codes, or log only error code, or only progress code or, both.

Configuration options: [Disabled] [Both] [Error code] [Progress code]

Bmc network configuration

The sub-items in this configuration allow you to configure the BMC network parameters.

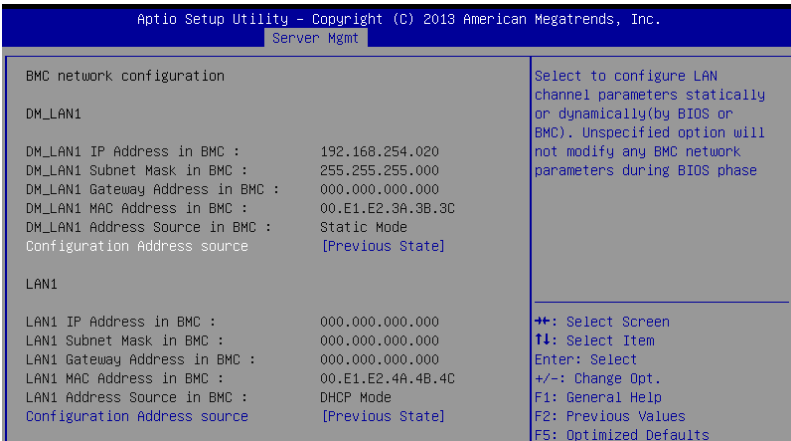

Configuration Address source DM_LAN1/LAN1 [Previous State]

This item allows you to configure LAN channel parameters statistically or dynamically (by BIOS or BMC). Unspecified option will not modify any BMC network parameters during BIOS phase.

Configuration options: [Previous State] [Unspecified] [Static] [DynamicBmcDhcp]

View System Event Log

This item allows you to view the system event log records.

IPv6 BMC Network Configuration

This item allows you to configure the parameter settings of IPv6 BMC network.

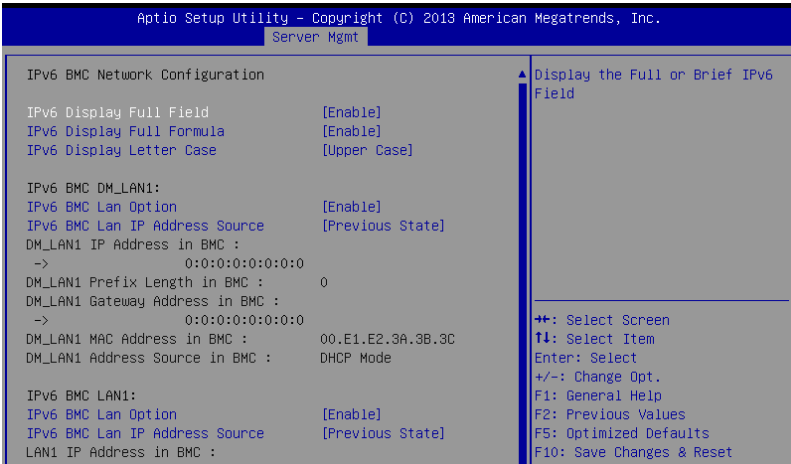

IPv6 Display Full Field [Enable]

Displays the full or brief IPv6 Field.

Configuration options: [Disable] [Enable]

IPv6 Display Full Formula [Enable]

Displays the full or brief IPv6 Formula.

Configuration options: [Disable] [Enable]

IPv6 Display Letter Case [Upper Case]

Displays the uppercase or lowercase letters of the alphabet.

Configuration options: [Lower Case] [Upper Case]

IPv6 BMC Lan Option [Enable]

This item allows you to enable or disable the IPv6 BMC LAN channel function.

Disabling this item will not modify any BMC network during BIOS phase.

Configuration options: [Disable] [Enable]

IPv6 BMC LAN IP Address source [Previous State]

Select to configure LAN channel parameters statically or dynamically(by BIOS or BMC).

Configuration options: [Previous State] [Static] [Dynamic-Obtained by BMC running DHCP]



The following items appear only when you set **IP BMC Lan IP Address Source** to [Static].

IPv6 BMC LAN IP Address

Allows you to input IPv6 BMC Lan IP address.

IPv6 BMC LAN IP Prefix Length

Allows you to input IPv6 BMC Lan IP Prefix Length.

IPv6 BMC LAN Default Gateway

Allows you to input IPv6 BMC Lan Default Gateway.

IPv6 BMC LAN DNS Settings

Allows you to enter IPv6 BMC LAN DNS Settings.

IPv6 BMC LAN Link IP Address

Allows you to enter IPv6 BMC LAN Link IP address.

IPv6 BMC LAN Link IP Prefix Length

Allows you to input IPv6 BMC Lan Link IP Prefix Length.

IPv6 BMC Lan Option [Enable]

This item allows you to enable IPv6 BMC LAN channel function. Disabling this option will not modify any BMC network during BIOS phase.



The following item appears only when you set **IP BMC Lan Option** to [Enable].

IPv6 BMC LAN IP Address Source [Previous State]

Select to configure LAN channel parameters statically or dynamically (by BIOS or BMC).

Configuration options: [Previous State] [Static] [Dynamic-Obtained by BMC running DHCP]



The following items appear only when you set **IP BMC Lan IP Address Source** to [Static].

IPv6 BMC LAN IP Address

Allows you to input IPv6 BMC Lan IP address.

IPv6 BMC LAN IP Prefix Length

Allows you to input IPv6 BMC Lan IP Prefix Length.

IPv6 BMC LAN Default Gateway

Allows you to input IPv6 BMC Lan Default Gateway.

IPv6 BMC LAN DNS Settings

Allows you to enter IPv6 BMC LAN DNS Settings.

IPv6 BMC LAN Link IP Address

Allows you to enter IPv6 BMC LAN Link IP address.

IPv6 BMC LAN Link IP Prefix Length

Allows you to input IPv6 BMC Lan Link IP Prefix Length.

5.7 Event Logs menu

The Event Logs menu items allow you to change the event log settings and view the system event logs.

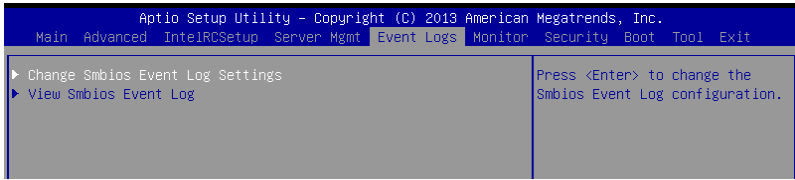

5.7.1 Change Smbios Event Log Settings

Press <Enter> to change the Smbios Event Log configuration.

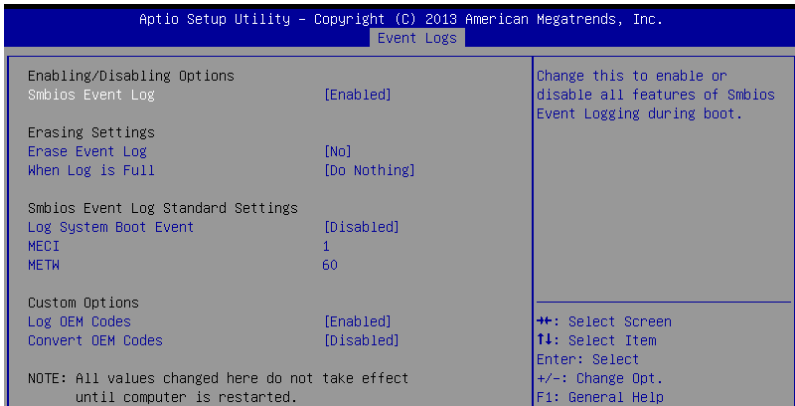

All values changed here do not take effect until computer is restarted.

Enabling/Disabling Options

Smbios Event Log [Enabled]

Change this to enable or disable all features of Smbios Event Logging during boot.

Configuration options: [Disabled] [Enabled]

Erasing Settings

Erase Event Log [No]

Choose options for erasing Smbios Event Log. Erasing is done prior to any logging activation during reset.

Configuration options: [No] [Yes, Next reset] [Yes, Every reset]

When Log is Full [Do Nothing]

Allows you to choose options for reactions to a full Smbios Event Log.

Configuration options: [Do Nothing] [Erase Immediately]

Smbios Event Log Standard Settings

Log System Boot Event [Disabled]

Allows you to choose options to enable/disable logging of System boot event.

Configuration options: [Enabled] [Disabled]

MECI [1]

Multiple Event Count Increment (MECI). The number of occurrences of a duplicate event that must pass before the multiple-event counter associated with the log entry is updated, specified as a numeric value in the range 1 to 255.

METW [60]

Multiple Event Time Windows (METW). The number of minutes which must pass between duplicate log entries which utilize a multiple-event counter. The value ranges from 0 to 99 minutes.

Custom Option

Log OEM Codes [Enabled]

Enable or disable the logging of EFI Status Codes as OEM Codes (if not already converted to legacy).

Configuration options: [Disabled] [Enabled]

Convert OEM Codes [Disabled]

Enable or disable the converting of EFI Status Codes to Standard Smbios Types (Not all may be translated).

Configuration options: [Disabled] [Enabled]

5.7.2 View Smbios Event Log

Press <Enter> to view all smbios event logs.

5.8 Monitor menu

The Monitor menu displays the system temperature/power status, and allows you to change the fan settings.

Aptio Setup Utility - Copyright (C) 2013 American Megatrends, Inc.		
Main Advanced IntelRCSetup Server Mgmt Event Logs Monitor Security Boot Tool Exit		
CPU1 Temperature	[49.5°C/121.1°F]	CPU1 Temperature
CPU2 Temperature	[N/A]	
FRNT FAN1 Speed	[N/A]	
FRNT FAN2 Speed	[5421 RPM]	
FRNT FAN3 Speed	[N/A]	
FRNT FAN4 Speed	[N/A]	
+VCCIO	[+1.056 V]	
+VCORE1	[+1.812 V]	
+VCORE2	[N/A]	
+VDDQ_AB	[+1.202 V]	
+VDDQ_CD	[+1.202 V]	
+VDDQ_EF	[N/A]	
+VDDQ_GH	[N/A]	



Scroll down to view the other items

CPU1/2 Temperature [xxx°C/xxx°F]

The onboard hardware monitor automatically detects and displays the CPU temperatures.

FRNT FAN1–4 Speed [xxxx RPM] or [N/A]

The onboard hardware monitor automatically detects and displays the speed of CPU fans, front fans, and rear fan in rotations per minute (RPM). If the fan is not connected to the motherboard, the field shows N/A.

+VCCIO, VCORE1/2 Voltage, +VDDQ_AB, +VDDQ_CD, +VDDQ_EF, +VDDQ_GH Voltage, +5VSB Voltage, +5V Voltage, +12V Voltage, +3.3V Voltage, VBAT Voltage, +3.3VSB Voltage

The onboard hardware monitor automatically detects the voltage output through the onboard voltage regulators.

FAN Speed Control [Generic Mode]

Allows you to configure the fan speed control.

Configuration options: [Generic Speed] [High Speed] [Full Speed] [Manual Mode]

5.9 Security menu

This menu allows a new password to be created or a current password to be changed. The menu also enables or disables the Secure Boot state and lets the user configure the System Mode state.

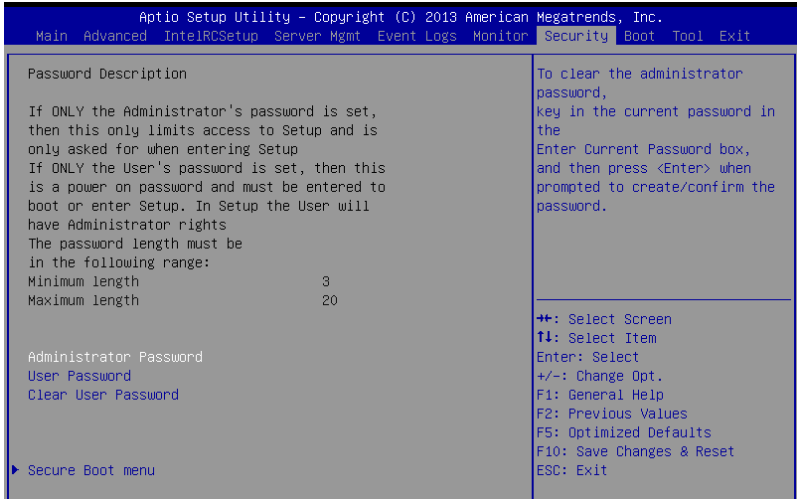

Administrator Password

To set an administrator password:

1. Select the Administrator Password item and press <Enter>.
2. From the Create New Password box, key in a password, then press <Enter>.
3. Confirm the password when prompted.

To change an administrator password:

1. Select the Administrator Password item and press <Enter>.
2. From the Enter Current Password box, key in the current password, then press <Enter>.
3. From the Create New Password box, key in a new password, then press <Enter>.
4. Confirm the password when prompted.



To clear the administrator password, follow the same steps as in changing an administrator password, but press <Enter> when prompted to create/confirm the password.

User Password

To set a user password:

1. Select the User Password item and press <Enter>.
2. From the Create New Password box, key in a password, then press <Enter>.
3. Confirm the password when prompted.

To change a user password:

1. Select the User Password item and press <Enter>.
2. From the Enter Current Password box, key in the current password, then press <Enter>.
3. From the Create New Password box, key in a new password, then press <Enter>.
4. Confirm the password when prompted.

To clear a user password:

1. Select the Clear User Password item and press <Enter>.
2. Select **Yes** from the Warning message window then press <Enter>.

Secure Boot Menu

This item allows you to customize the Secure Boot settings.

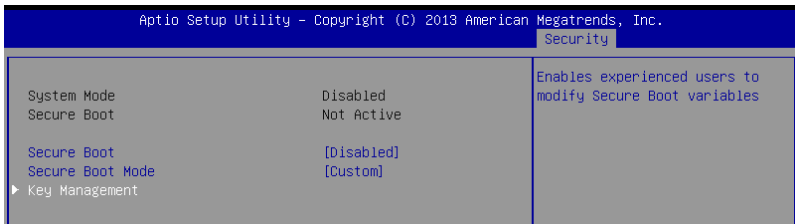

Secure Boot [Disabled]

Secure Boot can be enabled if the system is running in User mode with enrolled platform Key (EPK) or if the CSM function is disabled.

Configuration options: [Disabled] [Enabled]

Secure Boot Mode [Custom]

Allows you to set the Secure Boot selector.

Configuration options: [Custom] [Standard]

Key Management

This item only appears when the item Secure Boot Mode is set to [Custom]. The Key Management item allows you to modify Secure Boot variables and set Key Management page.

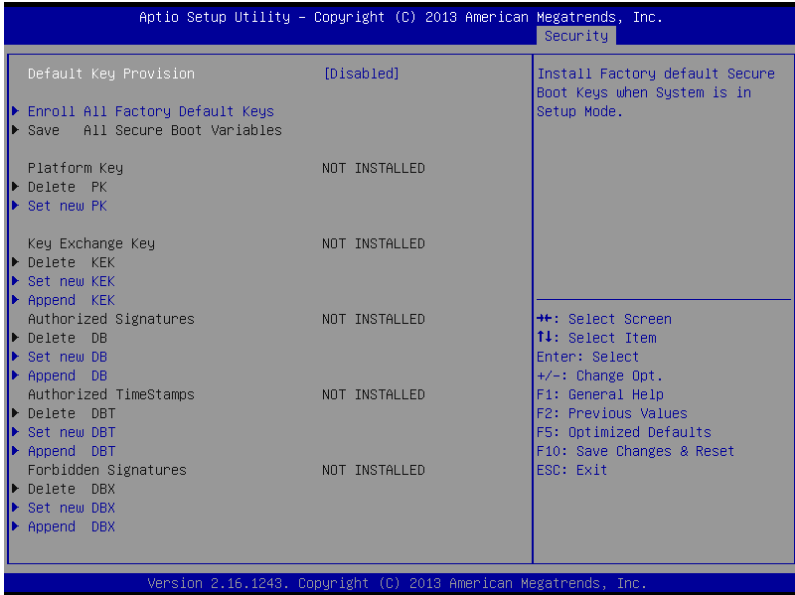

Default Key Provision [Disabled]

Configuration options: [Disabled] [Enabled]

Enroll All Factory Default Keys

This item will ask you if you want to Install Factory Default secure keys. Select Yes if you want to load the default secure keys, otherwise select No.

Save All Secure Boot Variables

This item will ask you if you want to save all secure boot variables. Select Yes if you want to save all secure boot variables, otherwise select No.

Platform Key (PK)/ Key Exchange Key (KEK)/ Authorized Signatures (DB)/ Authorized TimeStamps (DBT)/ Forbidden Signatures (DBX)

Configuration options: [Delete] [Set New] [Append]

5.10 Boot menu

The Boot menu items allow you to change the system boot options.

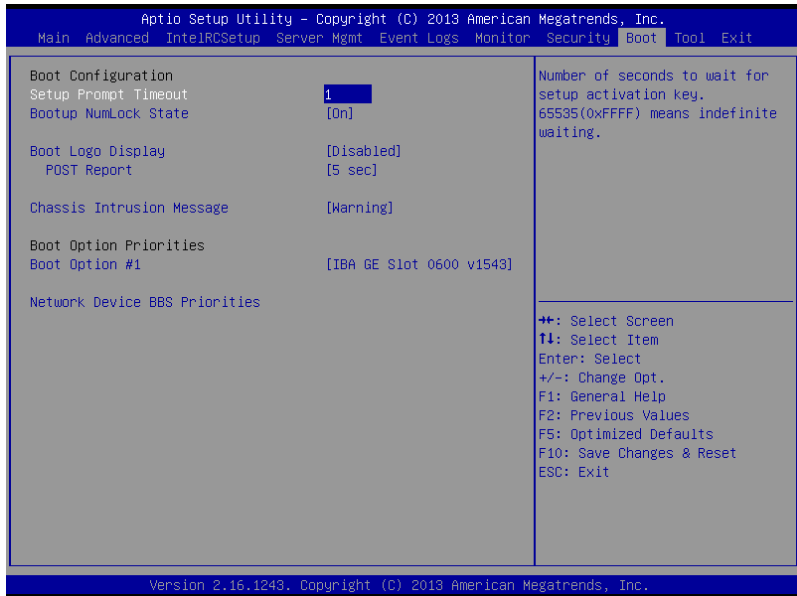

Setup Prompt Timeout [xx]

Use the <+> and <-> keys to adjust the number of seconds to wait for setup activation key.

Bootup NumLock State [On]

Allows you to select the power-on state for the NumLock.

Configuration options: [Off] [On]

Boot Logo Display [Disabled]

Allows you to enable or disable the full screen logo display feature.

Configuration options: [Auto] [Full Screen] [Disabled]

POST Report [5 sec]

Allows you to set the desired POST Report waiting time from 1 to 10 seconds.

Configuration options: [1 sec] ~ [10 sec] [Until Press ESC]

Chassis Intrusion [Warning]

Allows you to set an action when chassis intrusion has occurred.

Configuration options: [Warning] [Halt]

Boot Option Priorities

These items specify the boot device priority sequence from the available devices. The number of device items that appears on the screen depends on the number of devices installed in the system.



- To select the boot device during system startup, press <F8> when ASUS Logo appears.
- To access Windows OS in Safe Mode, please press <F8> after POST.

Set the booting order of network devices.

Boot Option #1/#2 [SATA P2: ASUS ...]

Configuration options: [SATA P2: ASUS ...] [SATA P3: WDC WD160...]
[AMI Virtual Floppy...][IBA GE Slot 0700 v...]

CD/DVD ROM Drive BBS Priorities

Hard Drive BBS Priorities / Network Device BBS Priorities

These items appear only when you connect SATA ODD or hard drive to the SATA ports and allow you to set the booting order of the SATA devices.

5.11 Tool menu

The Tool menu items allow you to configure options for special functions. Select an item then press <Enter> to display the submenu.

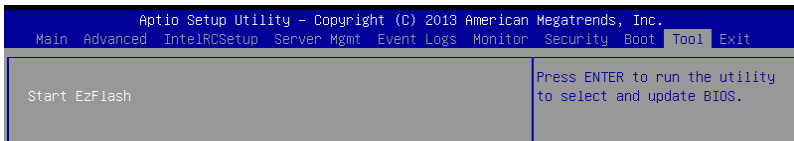

ASUS EZ Flash

Allows you to run ASUS EZ Flash BIOS ROM Utility when you press <Enter>. Refer to the ASUS EZ Flash Utility section for details.

5.12 Exit menu

The Exit menu items allow you to save or discard your changes to the BIOS items.

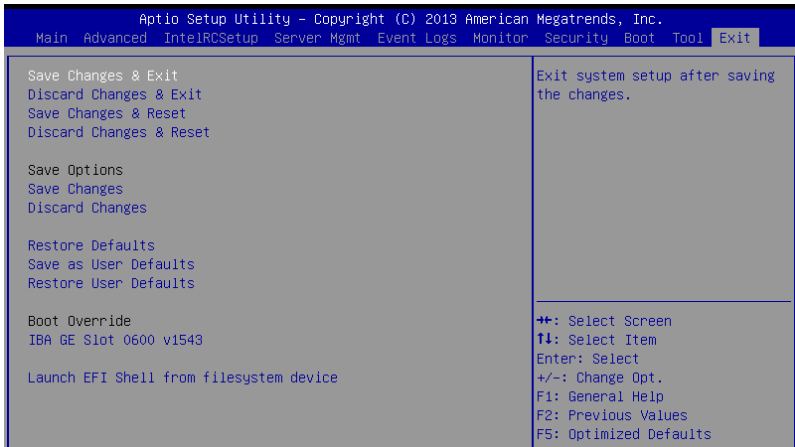

Pressing <Esc> does not immediately exit this menu. Select one of the options from this menu or <F10> from the legend bar to exit.

Save Changes & Reset

Exit System setup after saving the changes.

Discard Changes & Exit

Exit System setup without saving any changes.

Save Changes & Reset

Reset the system setup after saving the changes.

Discard Changes & Reset

Reset system setup without saving any changes.

Save Options

Save Changes

Save changes done so far to any of the setup options.

Discard Changes

Discard changes done so far to any of the setup options.

Restore Defaults

Restore/load default values for all the setup options.

Save as User Defaults

Save the changes done so far as User Defaults.

Restore User Defaults

Restore the User Defaults to all the setup options.

Boot Override

These items displays the available devices. The device items that appears on the screen depends on the number of devices installed in the system. Click an item to start booting from the selected device.

Launch EFI Shell from filesystem device

Attempts to launch EFI Shell application (shellx64.efi) from one of the available filesystem devices.

RAID Configuration

6

This chapter provides instructions for setting up, creating, and configuring RAID sets using the available utilities.

6.1 Setting up RAID

The motherboard supports the following SATA RAID solutions:

- **LSI MegaRAID software RAID Configuration Utility** with RAID 0, RAID 1, and RAID 10 support (for both Linux and Windows OS).
- **Intel® Rapid Storage Technology enterprise Option ROM Utility** with RAID 0, RAID 1, RAID 10, and RAID 5 support (for Windows OS only).

6.1.1 RAID definitions

RAID 0 (*Data striping*) optimizes two identical hard disk drives to read and write data in parallel, interleaved stacks. Two hard disks perform the same work as a single drive but at a sustained data transfer rate, double that of a single disk alone, thus improving data access and storage. Use of two new identical hard disk drives is required for this setup.

RAID 1 (*Data mirroring*) copies and maintains an identical image of data from one drive to a second drive. If one drive fails, the disk array management software directs all applications to the surviving drive as it contains a complete copy of the data in the other drive. This RAID configuration provides data protection and increases fault tolerance to the entire system. Use two new drives or use an existing drive and a new drive for this setup. The new drive must be of the same size or larger than the existing drive.

RAID 10 is data striping and data mirroring combined without parity (redundancy data) having to be calculated and written. With the RAID 10 configuration you get all the benefits of both RAID 0 and RAID 1 configurations. Use four new hard disk drives or use an existing drive and three new drives for this setup.

RAID 5 stripes both data and parity information across three or more hard disk drives. Among the advantages of RAID 5 configuration include better HDD performance, fault tolerance, and higher storage capacity. The RAID 5 configuration is best suited for transaction processing, relational database applications, enterprise resource planning, and other business systems. Use a minimum of three identical hard disk drives for this setup.



-
- If you want to boot the system from a hard disk drive included in a created RAID set, copy first the RAID driver from the support DVD to a floppy disk before you install an operating system to the selected hard disk drive.
 - Please refer to chapter 2 for how to select the RAID configuration utility. Move the jumper to choose between LSI MegaRAID and Intel® Rapid RAID.
-

6.1.2 Installing hard disk drives

The motherboard supports Serial ATA for RAID set configuration. For optimal performance, install identical drives of the same model and capacity when creating a disk array.

To install the SATA hard disks for RAID configuration:

1. Install the SATA hard disks into the drive bays following the instructions in the system user guide.
2. Connect a SATA signal cable to the signal connector at the back of each drive and to the SATA connector on the motherboard.
3. Connect a SATA power cable to the power connector on each drive.

6.1.3 Setting the RAID item in BIOS

You must set the RAID item in the BIOS Setup before you can create a RAID set from SATA hard disk drives attached to the SATA connectors supported by Intel® C612 chipset.

To do this:

1. Enter the BIOS Setup during POST.
2. Go to the **Advanced Menu > PCH SATA Configuration**, then press <Enter>.
3. Set **SATA Mode** to [RAID Mode].
4. Press <F10> to save your changes and exit the BIOS Setup.



Refer to Chapter 5 for details on entering and navigating through the BIOS Setup.

6.1.4 RAID configuration utilities

Depending on the RAID connectors that you use, you can create a RAID set using the utilities embedded in each RAID controller. For example, use the **LSI MegaRAID Software Configuration Utility** or the **Intel® Rapid Storage Technology** if you installed Serial ATA hard disk drives on the Serial ATA connectors supported by the Intel® C612 chipset.

Refer to the succeeding section for details on how to use the RAID configuration utility.

6.2 LSI Software RAID Configuration Utility

The LSI MegaRAID software RAID configuration utility allows you to create RAID 0, RAID 1, or RAID 10 set(s) from SATA hard disk drives connected to the SATA connectors supported by the motherboard's chip.

To enter the LSI MegaRAID software RAID configuration utility:

1. Turn on the system after installing all the SATA hard disk drives.
2. During POST, the LSI MegaRAID software RAID configuration utility automatically detects the installed SATA hard disk drives and displays any existing RAID set(s). Press <Ctrl> + <M> to enter the utility.

```
LSI MegaRAID Software RAID BIOS Version A.10 09231523R
LSI SATA RAID Found at PCI Bus No:00 Dev No:1F
Device present at Port 0      ST3160812AS      152114MB
Device present at Port 1      ST3160812AS      152114MB
Device present at Port 2      ST3160812AS      152114MB
Device present at Port 3      ST3160812AS      152114MB
Press Ctrl-M or Enter to run LSI Software RAID Setup Utility.
```



- The LSI MegaRAID software RAID configuration utility automatically configures to RAID 1 when the SATA to RAID Mode is enabled.
- The RAID setup screens shown in this section are for reference only and may not exactly match the items on your screen due to the controller version difference.
- When you create RAID sets with the LSI MegaRAID software RAID configuration utility, the boot priority of the SATA optical drive has to be manually adjusted. Otherwise, the system will not boot from the connected SATA ODD.

3. The utility main window appears. Use the arrow keys to select an option from the **Management Menu** and then press <Enter>. Refer to the Management Menu descriptions on the next page.

At the bottom of the screen is the legend box. The keys on the legend box allow you to navigate through the setup menu options or execute commands. The keys on the legend box vary according to the menu level.

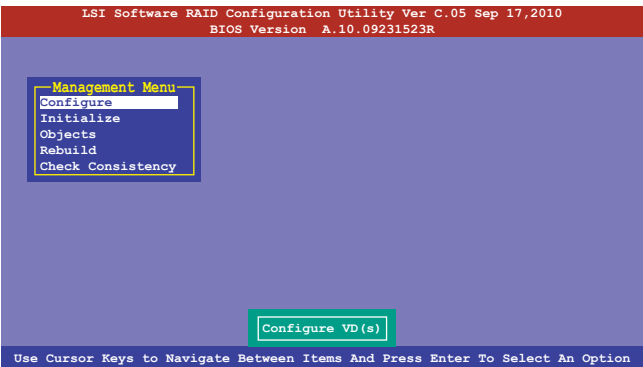

Menu	Description
Configure	Allows you to create RAID 0, RAID 1 or RAID 10 set using the Easy Configuration or the New Configuration command. This menu also allows you to view, add, or clear RAID configurations or select the boot drive
Initialize	Allows you to initialize the virtual drives of a created RAID set
Objects	Allows you to initialize virtual drives or change the virtual drive parameters
Rebuild	Allows you to rebuild failed drives
Check Consistency	Allows you to check the data consistency of the virtual drives of a created RAID set

6.2.1 Creating a RAID set

The LSI Software RAID Configuration Utility allows you to create a RAID 0, RAID 1, or RAID 10 set using two types of configurations: **Easy** and **New**.

In **Easy Configuration**, the virtual drive parameters are set automatically.

In **New Configuration**, you manually set the virtual drive parameters.

Using Easy Configuration

To create a RAID set using the **Easy Configuration** option:

1. From the **Management Menu**, select **Configure > Easy Configuration**, and then press <Enter>.

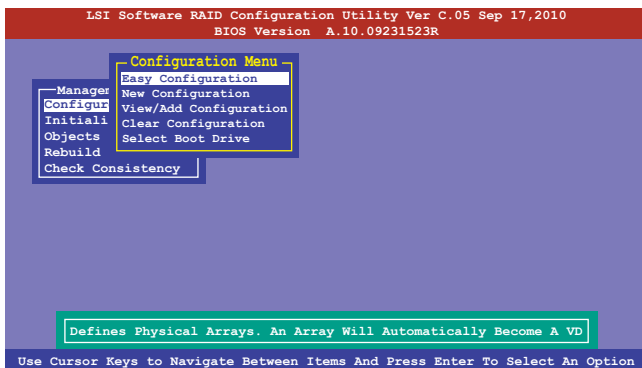

- The **ARRAY SELECTION MENU** displays the available drives connected to the SATA ports. Use the up/down arrow keys to select the drives you want to include in the RAID set, and then press <Space>. When selected, the drive indicator changes from **READY** to **ONLIN A[X]-[Y]**, where X is the array number, and Y is the drive number.

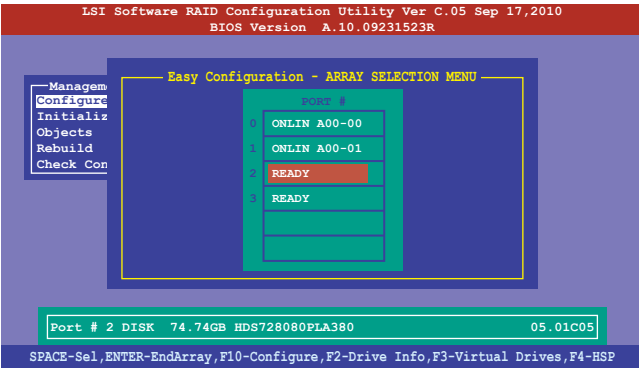

- The information of the selected hard disk drive displays at the bottom of the screen.
- You need at least two identical hard disk drives when creating a RAID 1 set.
- You need at least four identical hard disk drives when creating a RAID 10 set.

- Select all the drives required for the RAID set, and then press <F10> to configure array setting.
- Press <Space> to select the configurable array.

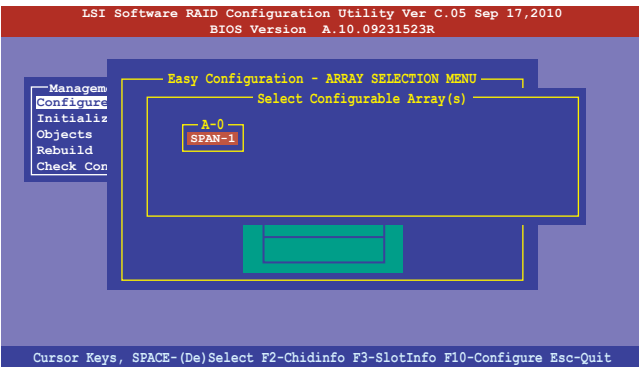

5. Press <F10> again, the virtual drive information appears including a **Virtual Drive** menu that allows you to change the virtual drive parameters.

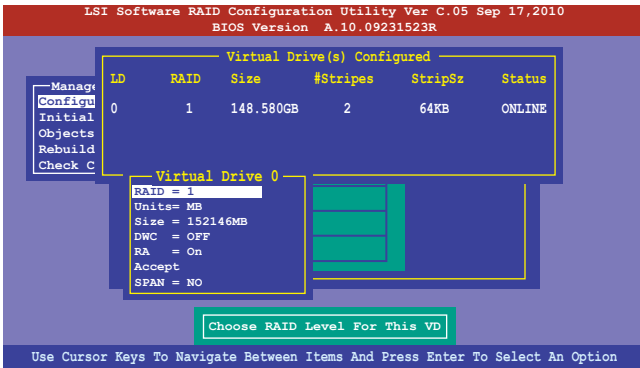

6. Select **RAID** from the **Virtual Drive** sub-menu, and then press <Enter>.
7. Select the **RAID** level from the menu, and then press <Enter>.

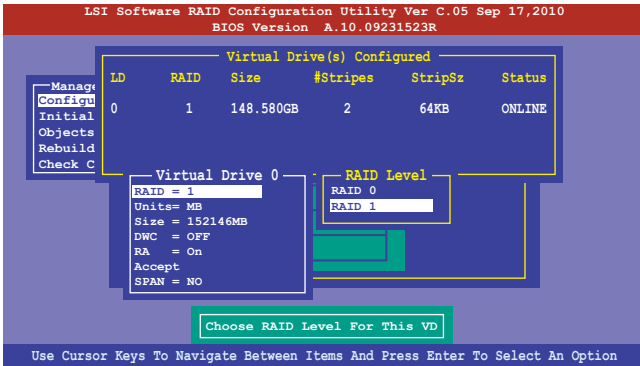

8. Select **Units** from the **Virtual Drive** sub-menu, and then press <Enter>.
9. Select the units for virtual drive size from the menu, and then press <Enter>.

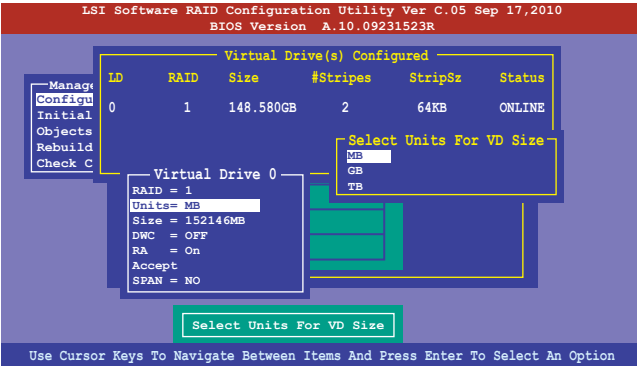

10. When creating a **RAID 1** or a **RAID 10** set, select **DWC** from the **Virtual Drive** menu, and then press <Enter>.
- When creating a **RAID 0** set, proceed to step 12.
11. Select **On** to enable the **Disk Write Cache** setting, and then press <Enter>.

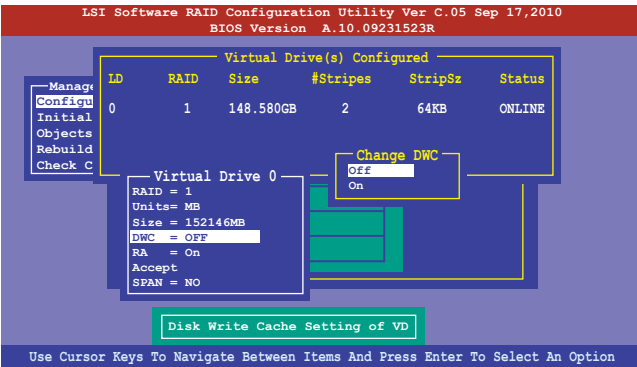

Enabling DWC can improve the performance, but with the risk of data loss.

12. When finished setting the selected virtual drive configuration, select **Accept** from the menu, and then press <Enter>.

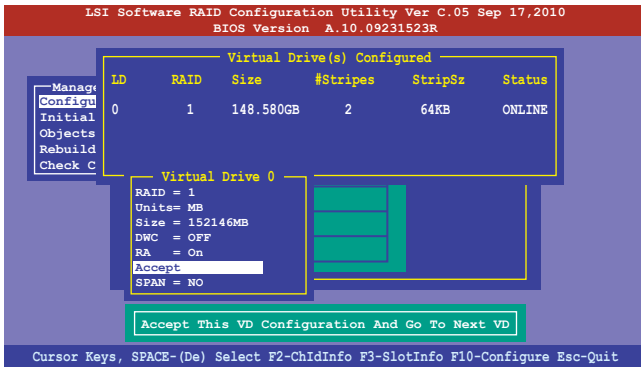

13. Follow step 2 to 12 to configure additional virtual drives.
14. Press <Esc> to finish RAID configuration. When prompted to save configuration, select **Yes** from the menu, and then press <Enter>.

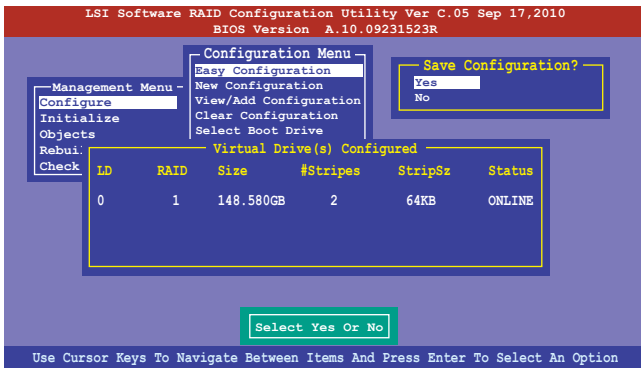

Using New Configuration



When a RAID set already exists, using the **New Configuration** command erases the existing RAID configuration data. If you do not want to delete the existing RAID set, use the **View/Add Configuration** command to view or create another RAID configuration.

To create a RAID set using the **New Configuration** option:

1. From the **Management Menu**, select **Configure > New Configuration**, and then press <Enter>.

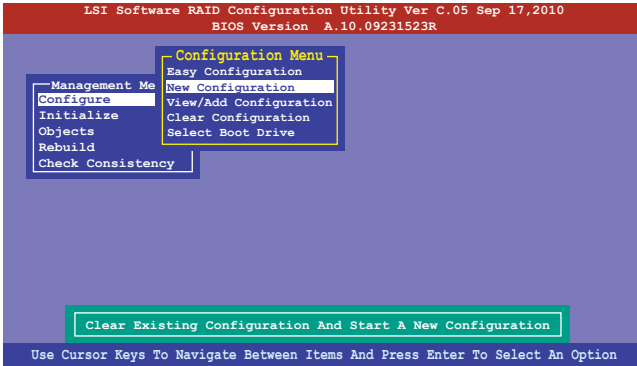

2. Follow step 2 to 9 of the previous section: **Using Easy Configuration**.
3. Select **Size** from the **Virtual Drive** menu, and then press <Enter>.
4. Key-in the desired virtual drive size, and then press <Enter>.

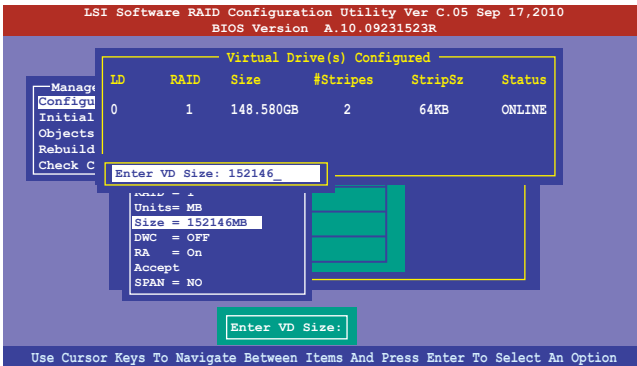

5. Follow step 10 to 14 of the previous section: **Using Easy Configuration** to create the RAID set.

6.2.2 Adding or viewing a RAID configuration

You can add a new RAID configuration or view an existing configuration using the **View/Add Configuration** command.

Adding a new RAID configuration

To add a new RAID configuration:

1. From the **Management Menu**, select **Configure > View/Add Configuration**, and then press <Enter>.

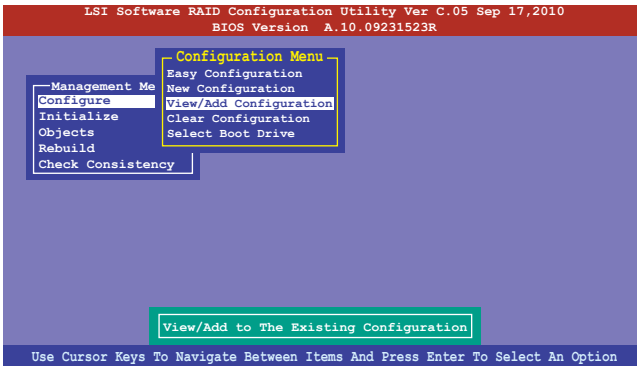

2. The **ARRAY SELECTION MENU** displays the available drives connected to the SATA ports. Select the drive(s) you want to include in the RAID set, then press <Space>. When selected, the drive indicator changes from **READY** to **ONLIN A[X]-[Y]**, where X is the array number, and Y is the drive number.

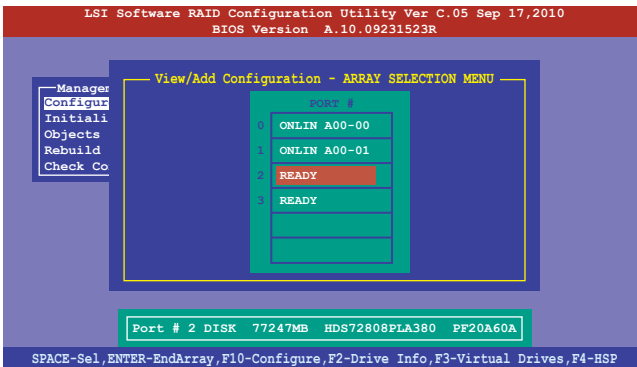

The information of the selected hard disk drive displays at the bottom of the screen.

3. Follow step 3 to 12 of section **5.2.1 Creating a RAID set: Using Easy Configuration** to add a new RAID set.

6.2.3 Initializing the virtual drives

After creating the RAID set(s), you must initialize the virtual drives. You may initialize the virtual drives of a RAID set(s) using the **Initialize** or **Objects** command on the **Management Menu**.

Using the Initialize command

To initialize the virtual drive using the Initialize command

1. From the **Management Menu**, select **Initialize**, and then press <Enter>.

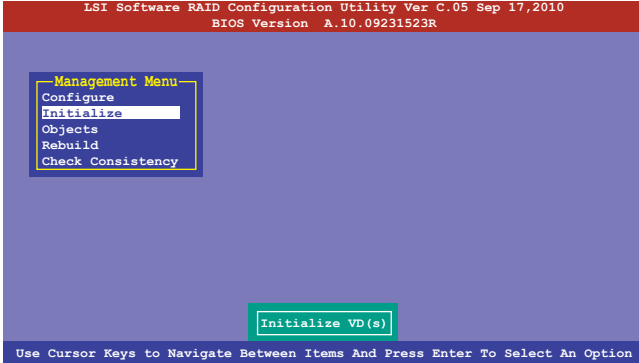

2. The screen displays the available RAID set(s) and prompts you to select the virtual drive to initialize. Use the arrow keys to select the virtual drive from the **Virtual Drive** selection, and then press <Space>.

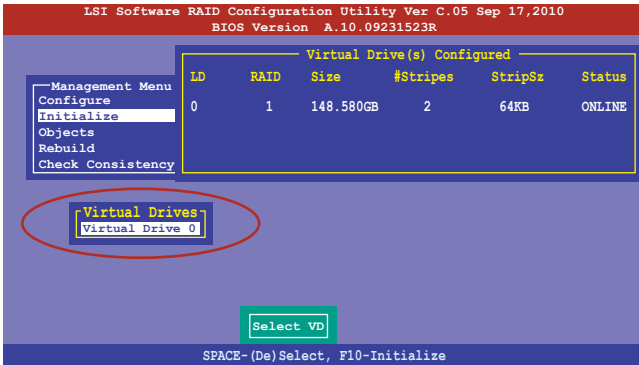

3. Press <F10> to start initialization. When prompted, select **Yes** from the **Initialize?** dialog box, and then press <Enter>.

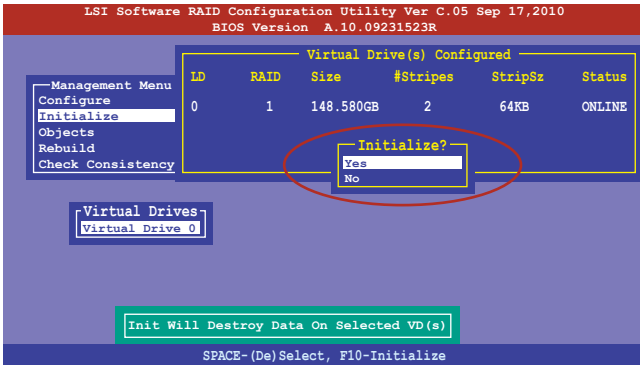

Initializing a virtual drive erases all data on the drive.

4. A progress bar appears on screen. If desired, press <Esc> to abort initialization. When initialization is completed, press <Esc>.

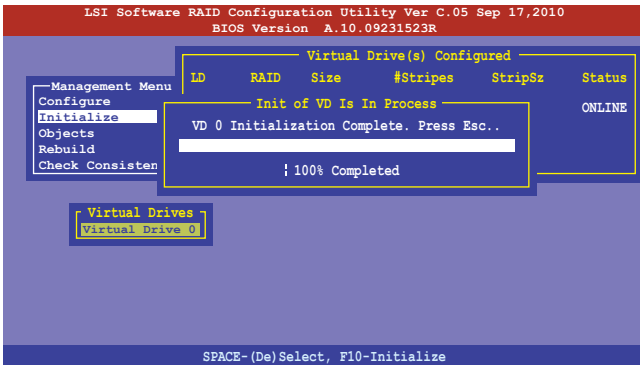

Using the Objects command

To initialize the virtual drives using the **Objects** command

1. From the **Management Menu**, select **Objects > Virtual Drive**, and then press <Enter>.

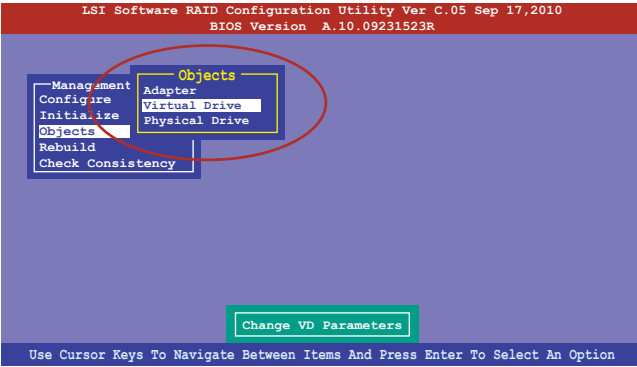

2. Select the virtual drive to initialize from the **Virtual Drives** sub-menu, and then press <Enter>.

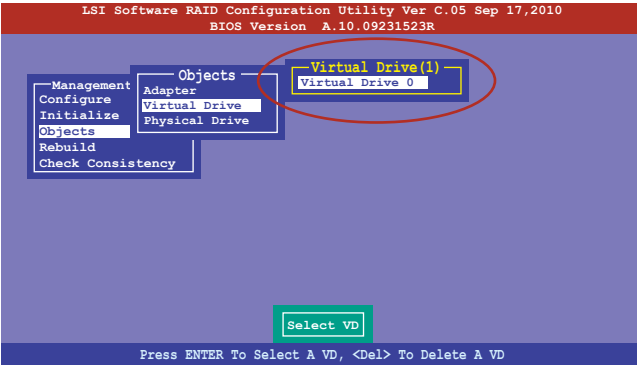

3. Select **Initialize** from the pop-up menu, and then press <Enter> to start initialization.

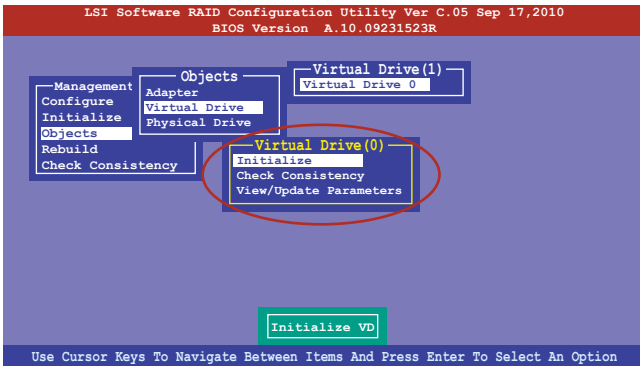

4. When prompted, press the <Space> to select **Yes** from the **Initialize?** dialogue box, and then press <Enter>.

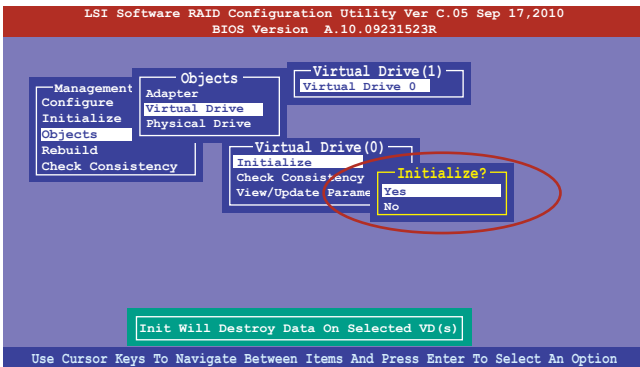

5. A progress bar appears on screen. If desired, press <Esc> to abort initialization. When initialization is completed, press <Esc>.

6.2.4 Rebuilding failed drives

You can manually rebuild failed hard disk drives using the **Rebuild** command in the **Management Menu**.

To rebuild a failed hard disk drive

1. From the **Management Menu**, select **Rebuild**, and then press <Enter>.

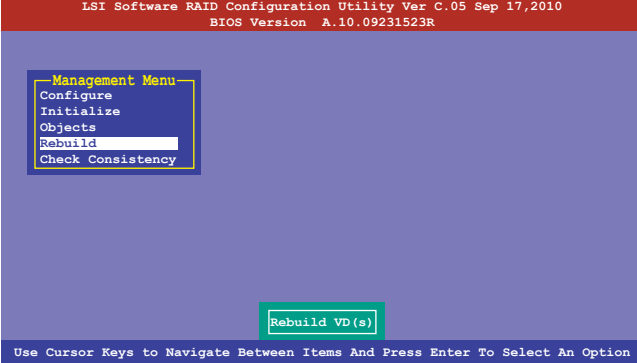

2. The **PHYSICAL DRIVES SELECTION MENU** displays the available drives connected to the SATA ports. Select the drive you want to rebuild, and then press <Space>.

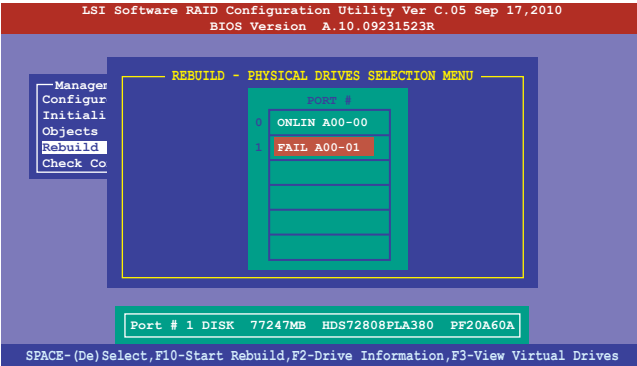

3. After selecting the drive to rebuild, press <F10>. When prompted, press <Y> to rebuild the drive.

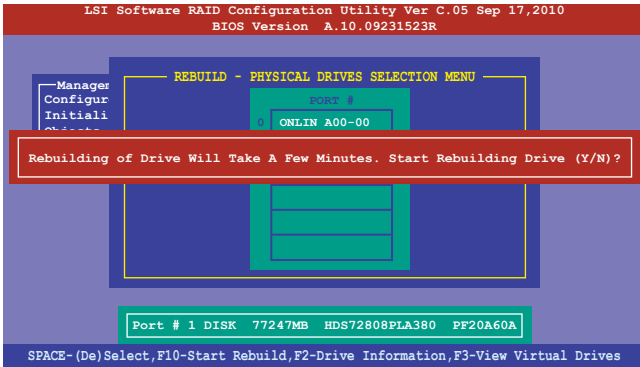

4. When rebuild is complete, press any key to continue.

6.2.5 Checking the drives for data consistency

You can check and verify the accuracy of data redundancy in the selected virtual drive. The utility can automatically detect and/or detect and correct any differences in data redundancy depending on the selected option in the **Objects > Adapter** menu.



The **Check Consistency** command is available only for virtual drives included in a RAID 1 or RAID 10 set.

Using the Check Consistency Command

To check data consistency using the **Check Consistency** command

1. From the **Management Menu**, select **Check Consistency**, and then press <Enter>.

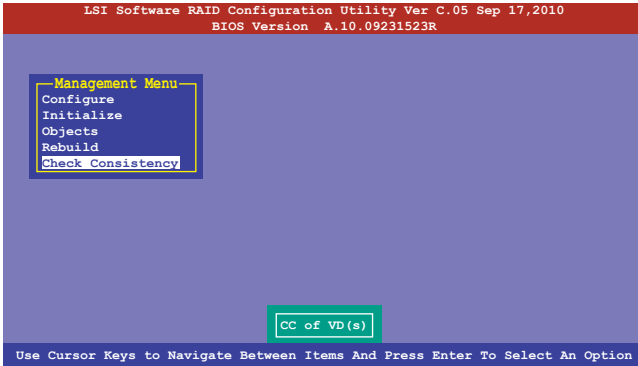

2. The screen displays the available RAID set(s) and prompts you to select the virtual drive to check. Press <Space> to select the virtual drive from the **Virtual Drive** sub-menu, and then press <F10>.

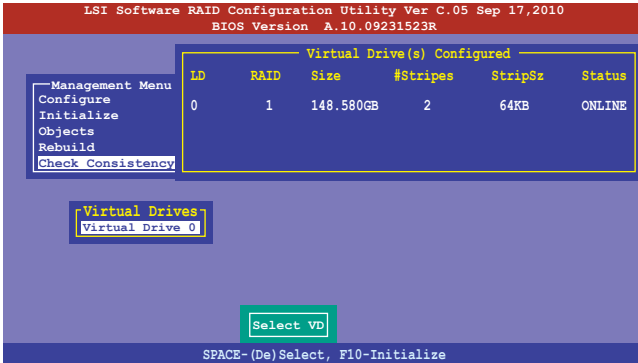

- When prompted, use the arrow keys to select **Yes** from the **Consistency Check?** dialog box, and then press <Enter>.

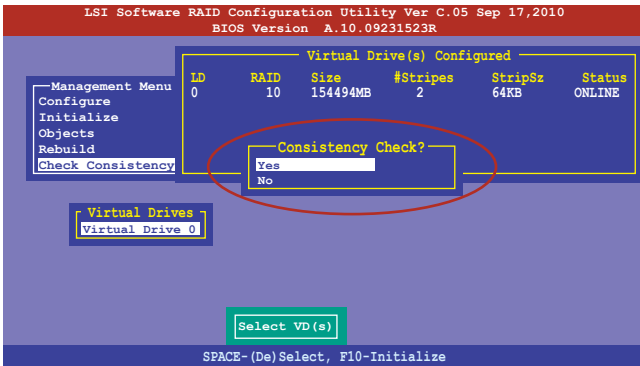

A progress bar appears on screen.

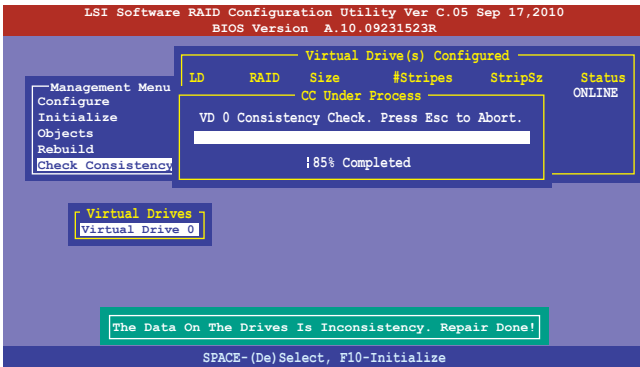

- While checking the disk consistency, press <Esc> to display the following options.
 - Stop** - Stops the consistency check. The utility stores the percentage of disk checked, and when you restart checking, it continues from the last percentage completed rather than from zero percent.
 - Continue** - Continues the consistency check.
 - Abort** - Aborts the consistency check. When you restart checking, it continues from zero percent.
- When checking is complete, press any key to continue.

Using the Objects command

To check data consistency using the **Objects** command

1. From the **Management Menu**, select **Objects**, and then select **Virtual Drive** from the sub-menu.
2. Use the arrow keys to select the virtual drive you want to check, and then press <Enter>.
3. Select **Check Consistency** from the pop-up menu, and then press <Enter>.
4. When prompted, use the arrow keys to select **Yes** from the dialogue box to check the drive.
5. When checking is complete, press any key to continue.

6.2.6 Deleting a RAID configuration

To delete a RAID configuration

1. From the **Management Menu**, select **Configure > Clear Configuration**, and then press <Enter>.

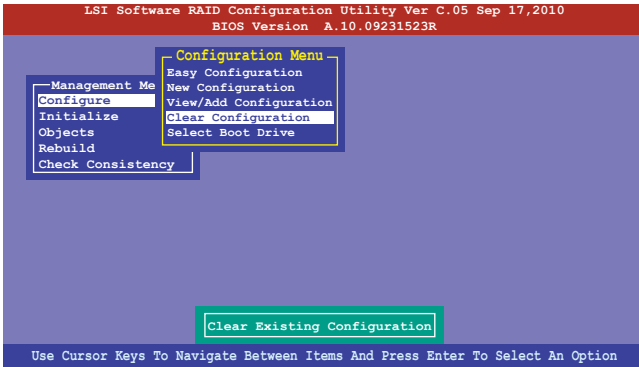

2. When prompted, use the arrow keys to select **Yes** from the **Clear Configuration?** dialog box, and then press <Enter>.

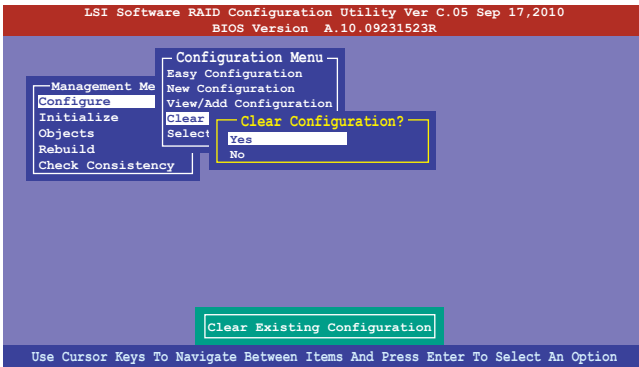

The utility clears all the current array(s).

3. Press any key to continue.

6.2.7 Selecting the boot drive from a RAID set

You must have created a new RAID configuration before you can select the boot drive from a RAID set. See section 5.2.1 **Creating a RAID set: Using New Configuration** for details.

To select the boot drive from a RAID set

1. From the **Management Menu**, select **Configure > Select Boot Drive**, and then press <Enter>.

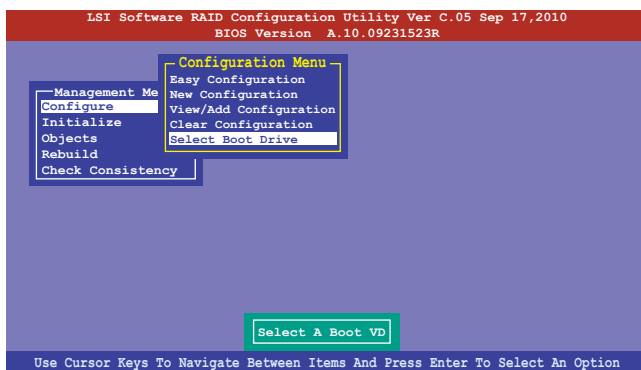

2. When prompted, use the arrow keys to select the bootable virtual drive from the list, then press <Enter>.

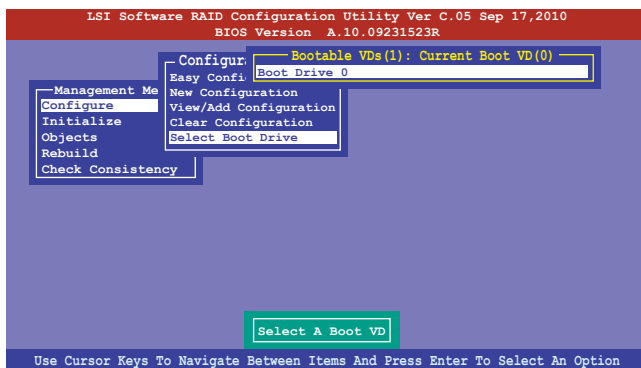

3. The virtual drive is selected as boot drive. Press any key to continue.

6.2.8 Enabling WriteCache

You may manually enable the RAID controller's WriteCache option after creating a RAID set to improve the data transmission performance.



When you enable WriteCache, you may lose data when a power interruption occurs while transmitting or exchanging data among the drives.



The WriteCache function is recommended for RAID 1 and RAID 10 sets.

To enable WriteCache

1. From the **Management Menu**, select **Objects > Adapter**, select an existing adapter, and then press <Enter> to display the adapter properties.
2. Select **Disk WC**, and then press <Enter> to turn on the option.

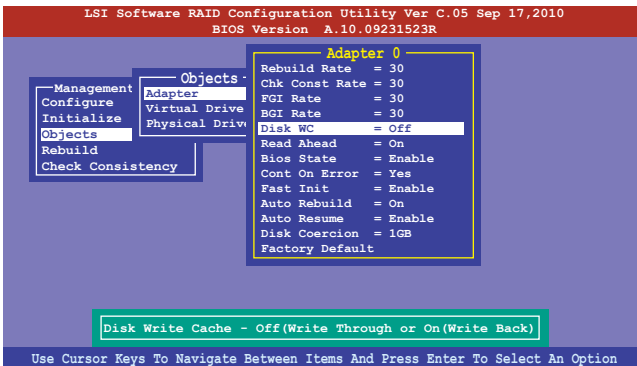

3. From the **Management Menu**, select **Objects > Virtual Drive**, select an existing adapter and press <Enter>. Select **View/Update Parameters** and press <Enter> to display the adapter properties.
4. Select **Disk WC**, and then press <Enter> to turn on the option.

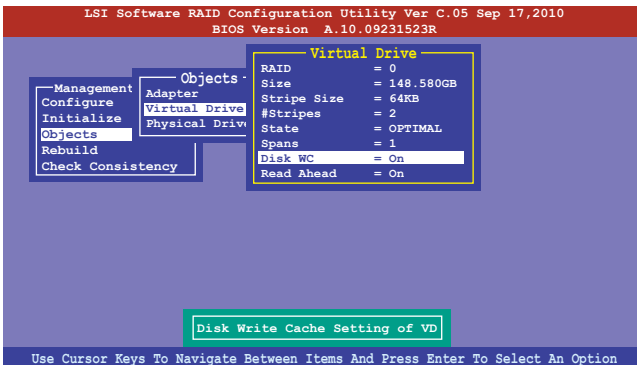

5. When finished, press any key to continue.

6.3 Intel® Rapid Storage Technology enterprise SATA Option ROM Utility

The Intel® Rapid Storage Technology enterprise SATA Option ROM utility allows you to create RAID 0, RAID 1, RAID 10 (RAID 1+0), and RAID 5 set from Serial ATA hard disk drives that are connected to the Serial ATA connectors supported by the Southbridge.



Before you proceed, ensure that you have installed the Serial ATA hard disk drives, have set the correct jumper settings of the motherboard, and have set the correct SATA mode in the BIOS setup. You can refer to the **Installing hard disk drives**, **Setting Jumpers**, and **Setting the RAID mode sections in BIOS** for more information.

To launch the Intel® Rapid Storage Technology enterprise SATA Option ROM utility:

1. Turn on the system.
2. During POST, press <Ctrl>+<I> to display the utility main menu.

```
Intel(R) Rapid Storage Technology enterprise - SATA Option ROM - 3.6.0.1023
Copyright(C) 2003-12 Intel Corporation. All Rights Reserved.

----- [ MAIN MENU ] -----
  1. Create RAID Volume          3. Reset Disks to Non-RAID
  2. Delete RAID Volume        4. Exit

----- [ DISK/VOLUME INFORMATION ] -----

RAID Volumes:
None defined.

Physical Disks:
ID Drive Model      Serial #           Size   Type/Status (Vol_ID)
0  ST3300656SS      HWS00000991753TR 279.3GB Non-RAID Disk
1  ST3300656SS      37VN00009846RAJ1 279.3GB Non-RAID Disk
2  ST3300656SS      397600009846UEDY 279.3GB Non-RAID Disk
3  ST3300656SS      GWC50000991756G6 279.3GB Non-RAID Disk

[↑↓]-Select      [ESC]-Exit      [ENTER]-Select Menu
```

The navigation keys at the bottom of the screen allow you to move through the menus and select the menu options.



The RAID BIOS setup screens shown in this section are for reference only and may not exactly match the items on your screen.

6.3.1 Creating a RAID set

To create a RAID set:

1. From the utility main menu, select **1. Create RAID Volume** and press <Enter>.
2. Key in a name for the RAID set and press <Enter>.

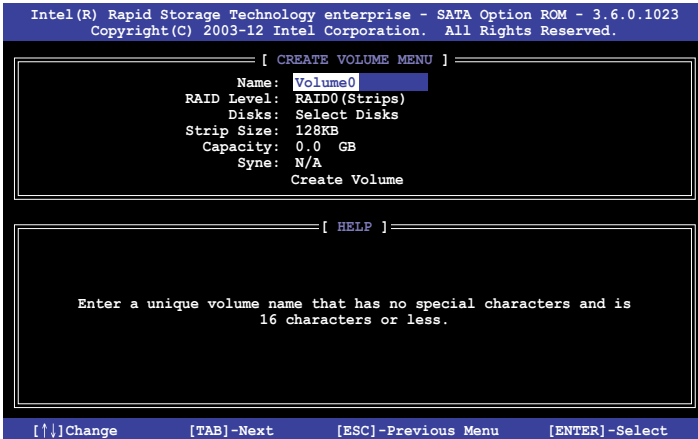

3. Press the up/down arrow keys to select a RAID Level that you wish to create then press <Enter>.
4. From the **Disks** item field, press <Enter> to select the hard disk drives that you want to include in the RAID set.

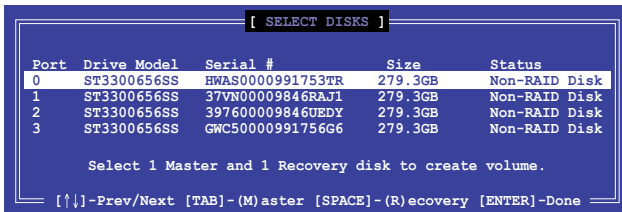

5. Use the up/down arrow keys to move the selection bar then press <Space> to select a disk. A small triangle before the Port number marks the selected drive. Press <Enter> when you are done.

6. Use the up/down arrow keys to select the stripe size for the RAID array (for RAID 0, 10 and 5 only) then press <Enter>. The available stripe size values range from 4 KB to 128 KB. The following are typical values:

RAID 0: 128KB

RAID 10: 64KB

RAID 5: 64KB



We recommend a lower stripe size for server systems, and a higher stripe size for multimedia computer systems used mainly for audio and video editing.

7. In the **Capacity** field item, key in the RAID volume capacity that you want to use and press <Enter>. The default value field indicates the maximum allowed capacity.
8. Press <Enter> to start creating the RAID volume.
9. From the following warning message, press <Y> to create the RAID volume and return to the main menu, or press <N> to go back to the **CREATE VOLUME** menu.



6.3.2 Deleting a RAID set



Take caution when deleting a RAID set. You will lose all data on the hard disk drives when you delete a RAID set.

To delete a RAID set:

1. From the utility main menu, select **2. Delete RAID Volume** and press <Enter>.
2. From the Delete Volume Menu, press the up/down arrow keys to select the RAID set you want to delete then press .

```
Intel(R) Rapid Storage Technology enterprise - SATA Option ROM - 3.6.0.1023
Copyright(C) 2003-12 Intel Corporation. All Rights Reserved.

[ DELETE VOLUME MENU ]

Name      Level      Drives  Capacity  Status  Bootable
Volume0   RAID0(Stripe)  2       298.0GB  Normal  Yes

[ HELP ]

Deleting a volume will reset the disks to non-RAID
WARNING: ALL DISK DATA WILL BE DELETED.
(This does not apply to Recovery volumes)

[↑/↓]-Select      [ESC]-Previous Menu      [DEL]-Delete Volume
```

3. Press <Y> to confirm deletion of the selected RAID set and return to the utility main menu, or press <N> to return to the **DELETE VOLUME** menu.

```
[ DELETE VOLUME VERIFICATION ]

ALL DATA IN THE VOLUME WILL BE LOST!
(This does not apply to Recovery volumes)

Are you sure you want to delete volume "Volume0"? (Y/N):
```

6.3.3 Resetting disks to Non-RAID



Take caution before you reset a RAID volume hard disk drive to non-RAID. Resetting a RAID volume hard disk drive deletes all internal RAID structure on the drive.

To reset a RAID set:

1. From the utility main menu, select **3. Reset Disks to Non-RAID** and press <Enter>.
2. Press the up/down arrow keys to select the drive(s) or disks of the RAID set you want to reset, then press <Space>. A small triangle before the Port number marks the selected drive. Press <Enter> when you are done.

```
[ RESET RAID DATA ]
Resetting RAID disk will remove its RAID structures
and revert it to a non-RAID disk.

WARNING: Resetting a disk causes all data on the disk to be lost.
(This does not apply to Recovery volumes)

Port  Drive Model  Serial #          Size      Status
---  -
0     ST3300656SS    HWAS0000991753TR 279.3GB  Member Disk
1     ST3300656SS    37VN00009846RAJ1 279.3GB  Member Disk

Select the disks that should be reset.

[↑↓]-Previous/Next [SPACE]-Selects [ENTER]-Selection Complete
```

3. Press <Y> in the confirmation window to reset the drive(s) or press <N> to return to the utility main menu.

6.3.4 Exiting the Intel® Rapid Storage Technology enterprise SATA Option ROM utility

To exit the utility:

1. From the utility main menu, select **4. Exit** then press <Enter>.
2. Press <Y> to exit or press <N> to return to the utility main menu.



6.3.5 Rebuilding the RAID



This option is only for the RAID 1 set.

Rebuilding the RAID with other non-RAID disk

If any of the SATA hard disk drives included in the RAID 1 array failed, the system displays the status of the RAID volume as **"Degraded"** during POST. You can rebuild the RAID array with other installed non-RAID disks.

To rebuild the RAID with other non-RAID disk:

1. During POST, press <Ctrl>+<I> at the prompt to enter the Intel Rapid Storage Technology option ROM utility.
2. If there is a non-RAID SATA Hard Disk available, the utility will prompt you to rebuild the RAID. Press the up/down arrow keys to select the destination disk then Press <Enter> to start the rebuilding process, or press <ESC> to exit.

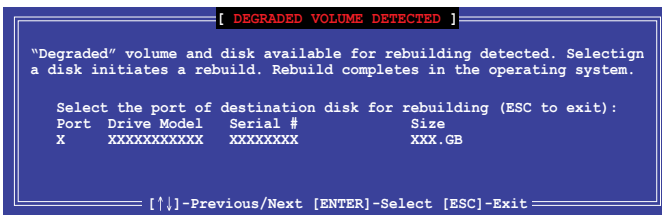

Select a destination disk with the same size as the original hard disk.

- The utility immediately starts rebuilding after the disk is selected. When done, the status of the degraded RAID volume is changed to **“Rebuild”**.

```

Intel(R) Rapid Storage Technology enterprise - SATA Option ROM - 3.6.0.1023
Copyright (C) 2003-12 Intel Corporation. All Rights Reserved.

[ MAIN MENU ]
1. Create RAID Volume
2. Delete RAID Volume
3. Reset Disks to Non-RAID
4. Exit

[ DISK/VOLUME INFORMATION ]

RAID Volumes:
ID Name Level Strip Size *Data is Encrypted
1 Volume0 RAID1 (Mirror) N/A 149.0GB Rebuild Status Bootable
Yes

Physical Devices:
Port Drive Model Serial # Size Type/Status (Vol ID)
1 ST3160812AS 9LS0F4HL 149.0GB Member Disk (0)
2 ST3160812AS 3LS0JYL8 149.0GB Member Disk (0)

Volumes with "Rebuild" status will be rebuilt within the operating system.

[↑↓]-Select [ESC]-Exit [ENTER]-Select Menu

```

- Press <Esc> to exit Intel Rapid Storage Technology and reboot the system.
- Select **Start > Programs > Intel Rapid Storage > Intel Rapid Storage Console** or click the **Intel Rapid Storage Technology** tray icon to load the Intel Rapid Storage Manager utility.
- From the **View** menu, select **Advanced Mode** to display the details of the Intel Rapid Storage Console.
- From the **Volumes view** option, select **RAID volume** to view the rebuilding status. When finished, the status is changed to **“Normal”**.

Rebuilding the RAID with a new hard disk

If any of the SATA hard disk drives included in the RAID array failed, the system displays the status of the RAID volume as **“Degraded”** during POST. You may replace the disk drive and rebuild the RAID array.

To rebuild the RAID with a new hard disk:

- Remove the failed SATA hard disk and install a new SATA hard disk of the same specification into the same SATA Port.



Select a destination disk with the same size as the original hard disk.

- Reboot the system then follow the steps in section **Rebuilding the RAID with other non-RAID disk**.

6.3.6 Setting the Boot array in the BIOS Setup Utility

You can set the boot priority sequence in the BIOS for your RAID arrays when creating multi-RAID using the Intel® Rapid Storage Technology enterprise SATA Option ROM utility.

To set the boot array in the BIOS:



Set at least one of the arrays bootable to boot from the hard disk.

1. Reboot the system and press to enter the BIOS setup utility during POST.
2. Go to the **Boot** menu and select the boot option priority.
3. Use up/down arrow keys to select the boot priority and press <Enter>. See the **Boot menu** section of Chapter 4 for more details.
4. From the **Exit** menu, select **Save Changes & Exit**, then press <Enter>.
5. When the confirmation window appears, select **Yes**, then press <Enter>.

6.4 Intel® Rapid Storage Technology enterprise (Windows)

The Intel® Rapid Storage Technology enterprise allows you to create RAID 0, RAID 1, RAID 10 (RAID 1+0), and RAID 5 set(s) from Serial ATA hard disk drives that are connected to the Serial ATA connectors.



You need to manually install the Intel® Rapid Storage Technology enterprise utility on a Windows® operating system. Please refer to the installation instructions in Chapter 6.

To enter the Intel® Rapid Storage Technology enterprise utility under Windows operating system:

1. Turn on the system and go to the windows desktop.
2. Click the **Intel® Rapid Storage Technology enterprise** icon to display the main menu.

Your storage system is configured for data protection, increased performance and optimal data storage capacity. You can create additional volumes to further optimize your storage system.

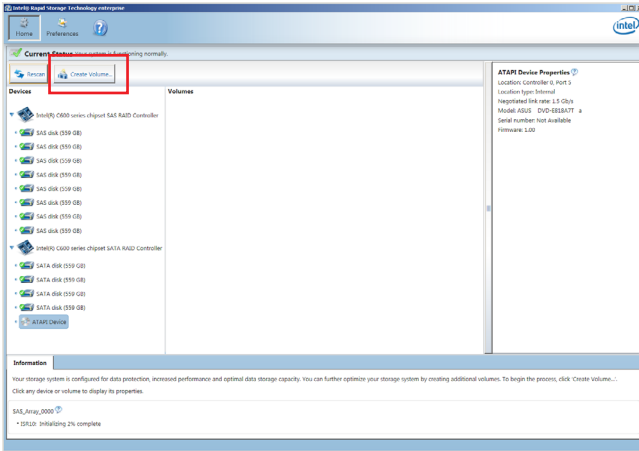

You can click **Rescan** to re-scan any attached hard disks.

6.4.1 Creating a RAID set

To create a RAID set:

1. From the utility main menu, select **Create Volume** and select volume type.
2. Click **Next**.

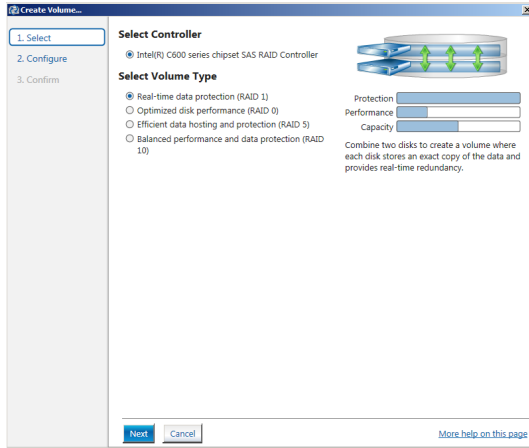

3. Enter a name for the RAID set, then select the array disks.
4. Select **Volume Size** tab, you can drag the bar to decide the volume size.
5. Click **Next**.

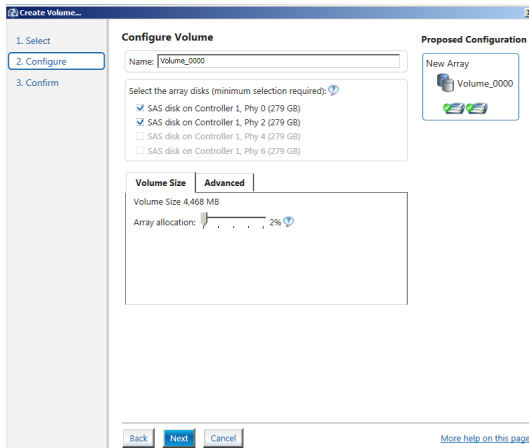

- If you do not want to keep the data on one of the selected disks, select **NO** when prompted.
- If you want to **Enable volume write-back cache** or **Initialize volume**, click **Advanced**.

6. Confirm the volume creation, then click **Create Volume** to continue.



This process could take a while depending on the number and size of the disks. You can continue using other applications during this time.

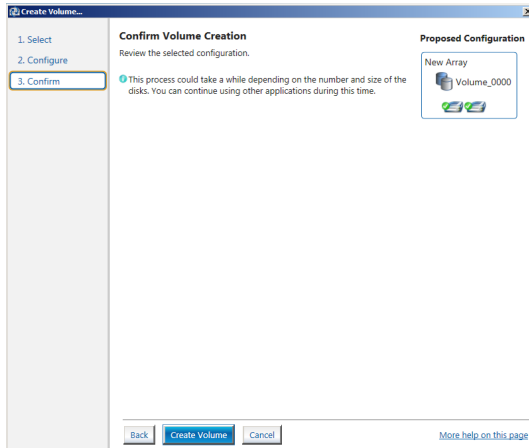

7. Wait until the process is completed, then click **OK** when prompted.

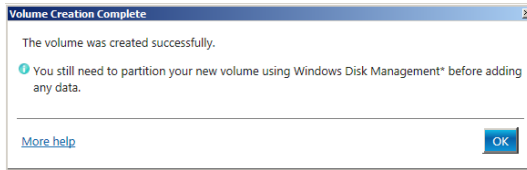

You still need to partition your new volume using Windows Disk Management before adding any data.

The RAID set is displayed in the **Volumes** list and you can change the settings in **Volume Properties**.

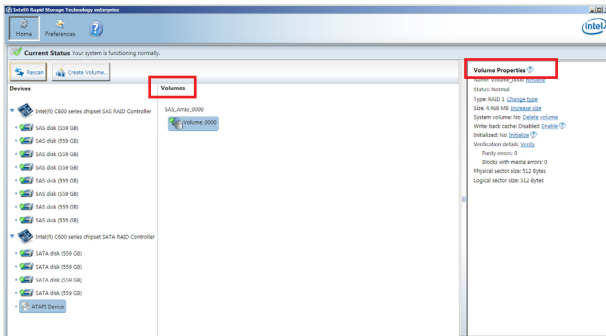

6.4.2 Changing a Volume Type

To change the volume type in **Volume Properties**:

1. Click the SATA array items you want to change in **Volumes** field.
2. From the **Volume Properties** field, select **Type:RAID 1 Change type**.

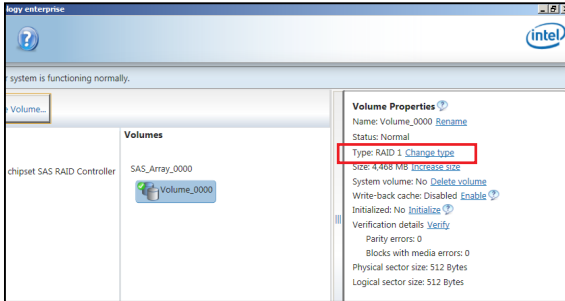

3. You can change the **Name**, **Select the new volume type**, and **Select additional disks to include in the new volume** if needed.
4. Select the **Data stripe size** for the RAID array (for RAID 0, 10 and 5 only), and click **OK**. The available stripe size values range from 4 KB to 128 KB. The following are typical values:
RAID 0: 128KB
RAID 10: 64KB
RAID 5: 64KB

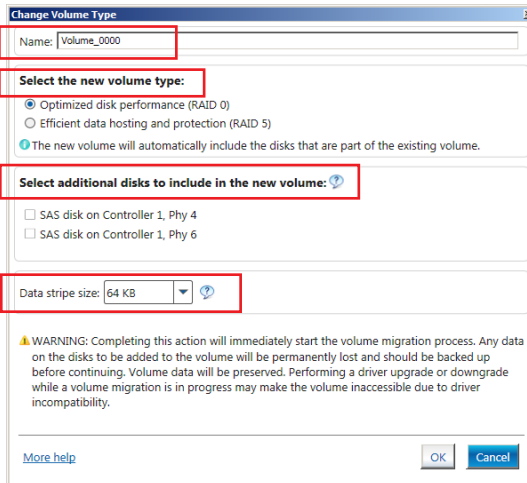

We recommend a lower stripe size for server systems, and a higher stripe size for multimedia computer systems used mainly for audio and video editing.

6.4.3 Deleting a volume



Be cautious when deleting a volume. You will lose all data on the hard disk drives. Before you proceed, ensure that you back up all your important data from your hard drives.

To delete a volume:

1. From the utility main menu, select the volume (exp. Volume_0000) in **Volumes** field you want to delete.

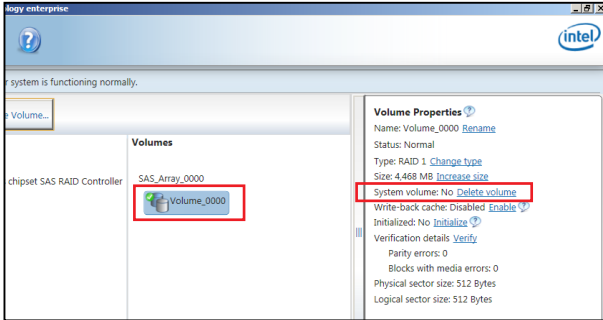

2. Select **Delete volume** in **Volume Properties** field. The following screen appears.

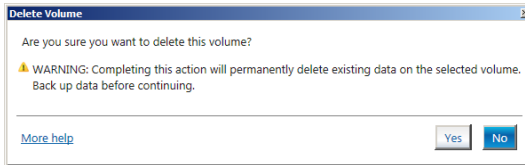

3. Click **Yes** to delete the volume and return to the utility main menu, or click **No** to return to the main menu.

6.4.4 Preferences

System Preferences

Allow you to set to show the notification area icon and show system information, warning, or errors here.

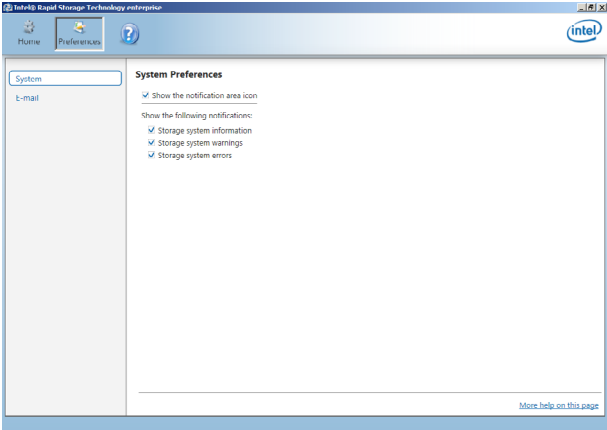

E-Mail Preferences

Allow you to set to sent e-mail of the following events:

- Storage system information
- Storage system warnings
- Storage system errors

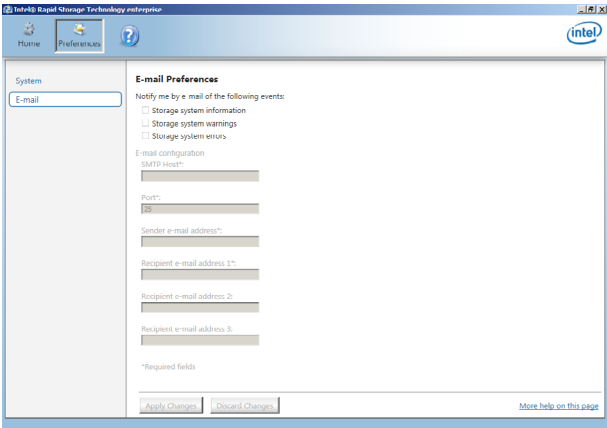

Driver Installation

7

This chapter provides the instructions for installing the necessary drivers for different system components in both Linux[®] and Windows[®] Operating Systems.

7.1 RAID driver installation

After creating the RAID sets for your server system, you are now ready to install an operating system to the independent hard disk drive or bootable array. This part provides the instructions on how to install the RAID controller drivers during OS installation.

7.1.1 Creating a RAID driver disk



The system does not include a floppy drive. You have to use a USB floppy drive when creating a SATA RAID driver disk.



If you have created RAID sets with the LSI Software RAID configuration utility, the boot priority of the SATA optical disk drive has to be manually adjusted. Otherwise, the system will not boot from the connected SATA ODD.

To create a RAID driver disk in Windows® environment

1. Start Windows®.
2. Place the motherboard support DVD into the optical drive.
3. Go to the **Make disk** menu, and then select the type of RAID driver disk you want to create.
4. Insert a floppy disk into the USB floppy disk drive.
5. Follow succeeding screen instructions to complete the process.



Write-protect the floppy disk to avoid computer virus infection.

To create a RAID driver disk in Red Hat® Enterprise Linux server environment

1. Insert a blank formatted high-density floppy disk to the USB floppy disk drive.
2. Type `dd if=xxx.img of=/dev/fd0` to decompress the file into the floppy disk from the following path in the support DVD:

For LSI MegaRAID Driver

`\Drivers\C610 LSI RAID\Driver\makediskLinux`

3. Eject the floppy disk.

7.1.2 Installing the RAID controller driver

During Windows® Server 2008 R2 OS installation

To install the RAID controller driver when installing Windows® Server 2008 R2 OS

1. Boot the computer using the Windows® Server 2008 R2 OS installation disc. Follow the screen instructions to start installing Windows Server 2008 R2.
2. When prompted to choose a type of installation, click **Custom (advanced)**.

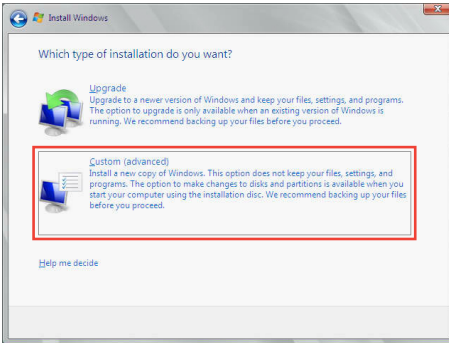

3. Click **Load Driver**.

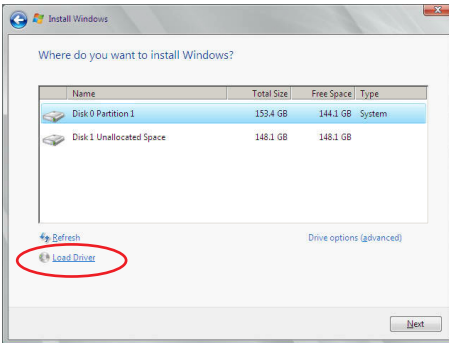

4. A message appears, reminding you to insert the installation media containing the driver of the RAID controller driver. If you have only one optical drive installed in your system, eject the Windows OS installation disc and replace with the motherboard Support DVD into the optical drive. Click **Browse** to continue.

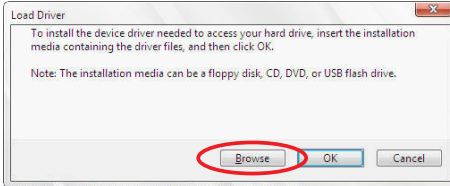

5. Locate the driver in the corresponding folder of the Support DVD then click **OK** to continue.
6. Select the RAID controller driver you need from the list and click **Next**.
7. When the system finishes loading the RAID driver, replace the motherboard Support DVD with the Windows Server installation disc. Select the drive to install Windows and click **Next**.

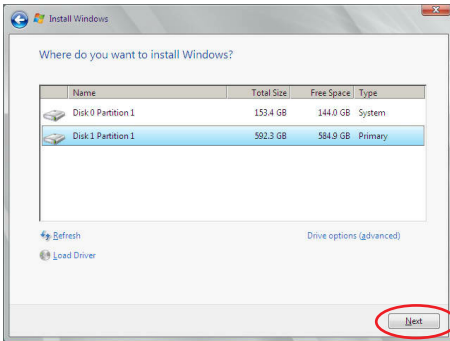

8. Setup then proceeds with the OS installation. Follow screen instructions to continue.

Red Hat® Enterprise Linux OS 5.x

To load the LSI MegaRAID controller driver when installing Red Hat® Enterprise OS:

1. Boot the system from the Red Hat® OS installation CD.
2. At the `boot:`, type `linux dd` then press <Enter>.

```
- To install or upgrade in graphical mode, press the <ENTER> key.
- To install or upgrade in text mode, type: linux text <ENTER>.
- Use the function keys listed below for more information.
[F1-Main] [F2-Options] [F3-General] [F4-Kernel] [F5-Rescue]
boot: linux dd
```

3. Select **Yes** using the <Tab> key when asked if you have the driver disk, then press <Enter>.

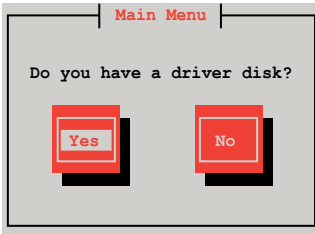

4. Insert the Red Hat® Enterprise RAID driver disk to the USB floppy disk drive, select **OK**, then press <Enter>.

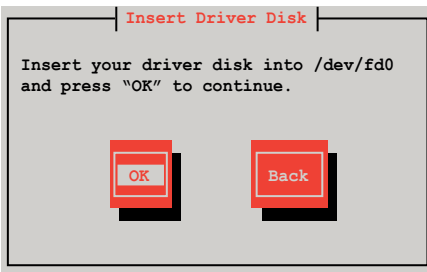

The drivers for the RAID card are installed to the system.

5. When asked if you will load additional RAID controller drivers, select **No**, then press <Enter>.

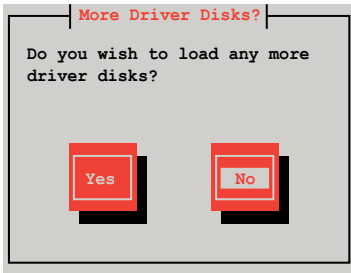

6. Follow the onscreen instructions to finish the OS installation.
7. When the installation is completed, DO NOT click **Reboot**. Press <Ctrl> + <Alt> + <F2> to switch to the command-line interface from graphic user interface.
8. Type the following commands when using a Legacy floppy.

```
mkdir /mnt/driver
mount /dev/fd0 /mnt/driver
cd /mnt/driver
sh replace_ahci.sh
reboot
```

Red Hat® Enterprise Linux OS 6.x

To install the LSI MegaRAID controller driver when installing Red Hat® Enterprise OS:

1. Boot the system from the Red Hat® OS installation CD.
2. Press <Tab> to edit options.

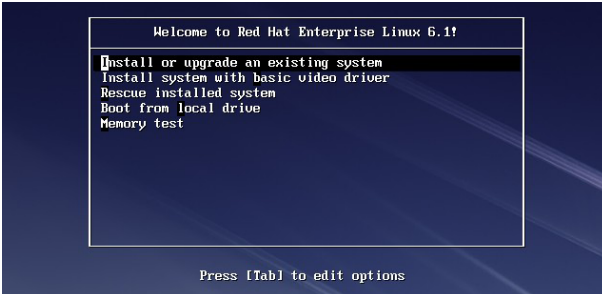

3. While booting from DVD, press <ESC> to give the third party driver. Enter the following command at the boot: `Linux dd blacklist=iscsi blacklist=ahci nodmraid`, then press <ENTER>.



4. Select Yes using the <Tab> key when asked if you have the driver disk, then press <Enter>.

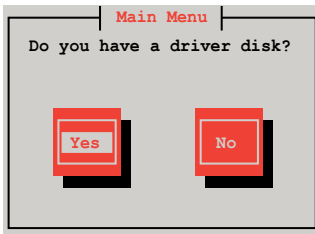

- 5 . You have multiple devices which could serve as source for a driver disk. Choose one you like to use and select **OK**, then press <Enter>.

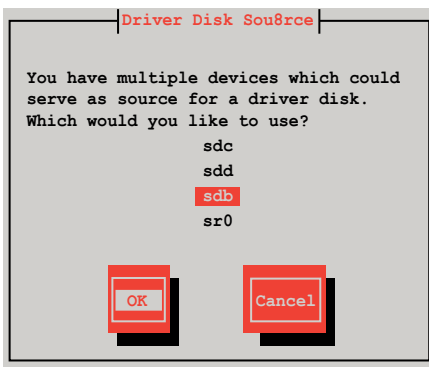

6. Insert the Red Hat® Enterprise RAID driver disk to the USB floppy disk drive, select **OK**, then press <Enter>.

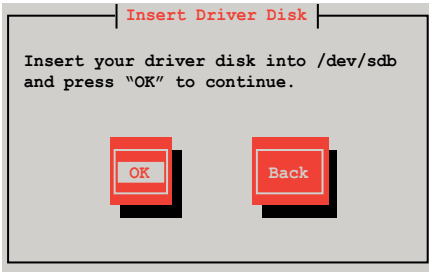

The drivers for the RAID card are installed to the system.

7. When asked if you will load additional RAID controller drivers, select **No**, then press <Enter>.

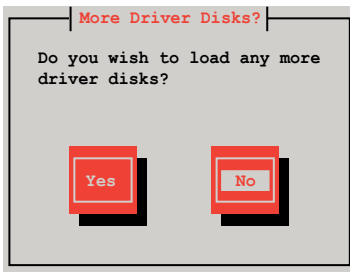

8. Follow the onscreen instructions to finish the OS installation.

Preparing the Linux Driver

Ensure that there is another computer with a Linux-based OS to create the RAID driver. When creating the RAID driver, you may refer to the examples below which uses a 64bit SUSE Linux system to create a 64bit RAID driver for SUSE11 sp1.

1. Copy the image file into the Linux system.

Example: `megasr-15.00.0120.2012-1-sles11-ga-x86_64.img`

2. Create a folder.

Example: `image`

3. Mount the image file into the image folder using this command format:

`mount -o loop [image file name] image`

Example: `mount -o loop megasr-15-15.00.0120.2012-1-sles11-ga-x86_64.img image`

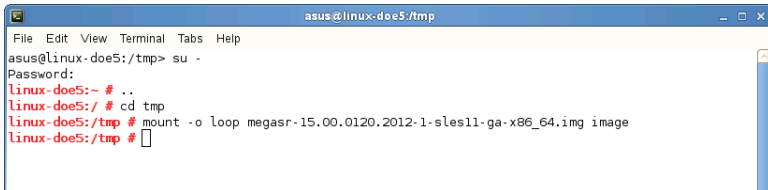

4. Copy the contents of the image directory, labeled as **01**, into a FAT32 USB drive.

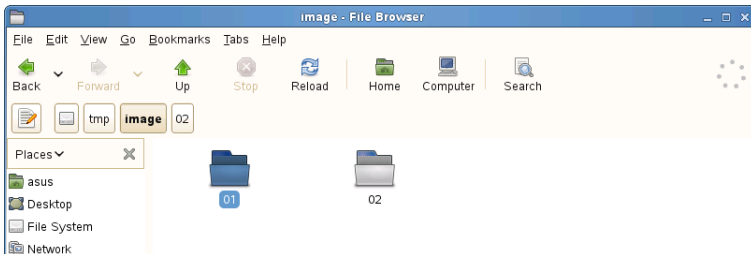

5. Rename the **01** folder to **CD Image**.

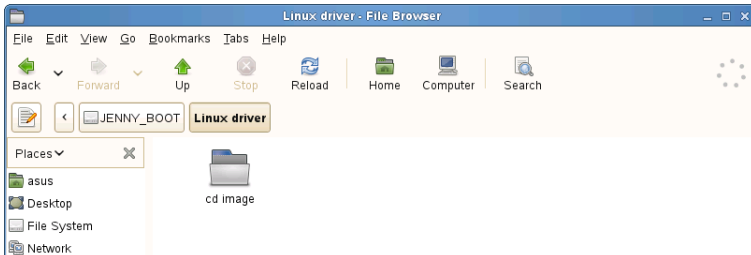

Installing SUSE 11 Linux OS

To install the LSI MegaRAID controller driver when installing SUSE Linux Enterprise Server OS:

1. Boot the system from the SUSE OS installation CD.
2. Use the arrow keys to select **Installation** from the **Boot Options** menu.



3. Press <F6>, then select **Yes** from the menu. Press <Enter>.



4. Use the USB drive to provide the third-party driver during the OS installation. Type the command **brokenmodules=ahci** in **Boot Options** field, and press <Enter>.

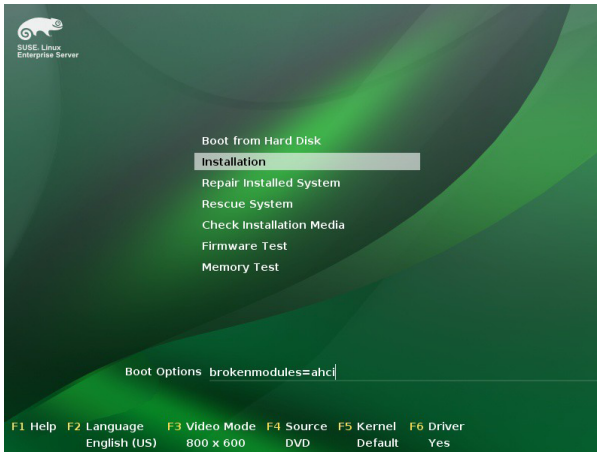

5. When below screen appears, select the USB floppy disk drive (sda) as the driver update medium. Select **OK**, then press <Enter>.

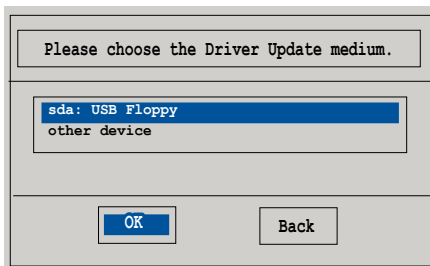

6. Select **Back** and follow the onscreen instructions to finish the installation.

7.2 Management applications and utilities installation

The support DVD that is bundled with your motherboard contains drivers, management applications, and utilities that you can install to maximize the features of your motherboard.



1. The contents of the support DVD are subject to change at any time without notice. Visit the ASUS website (www.asus.com) for the latest updates on software and utilities.
2. The support DVD is supported on Windows® Server 2008 R2 and Windows® Server 2012.

7.3 Running the Support DVD

When you place the support DVD into the optical drive, the DVD automatically displays the main screen if Autorun is enabled in your computer. By default, the Drivers tab is displayed.



If Autorun is NOT enabled in your computer, browse the contents of the support DVD to locate the file **ASSETUP.EXE** from the **BIN** folder. Double-click the **ASSETUP.EXE** to run the support DVD.

The main screen of the Support DVD contains the following tabs:

1. Drivers
2. Utilities
3. MakeDisk
4. Manual
5. Contact



The main screen of the Support DVD looks exactly the same on the Windows® Server 2008 R2 and on the Windows® Server 2012 Operating System (OS).

7.3.1 Drivers menu tab

The Drivers Menu shows the available device drivers if the system detects installed devices. Install the necessary drivers to activate the devices.



7.3.2 Utilities menu tab

The Utilities menu displays the software applications and utilities that the motherboard supports.

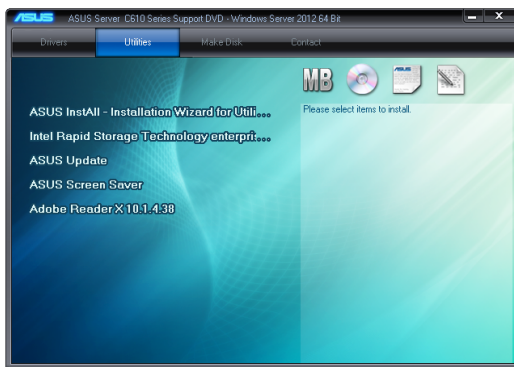

7.3.3 MakeDisk menu tab

The MakeDisk menu contains items to create the Intel RAID driver disks.



Press the arrow down button in the lower part of the menu to view more items.

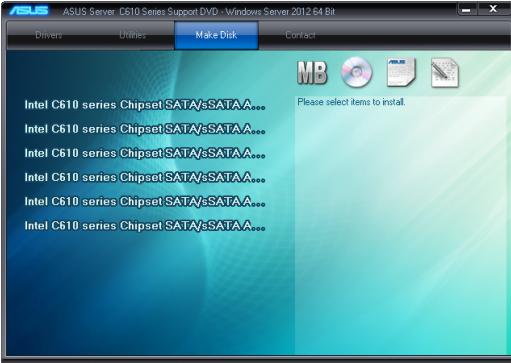

7.3.4 Manual menu

The Manual menu provides the link to the Broadcom NetXtreme II Network Adapter user guide.



You need an internet browser installed in your OS to view the User Guide.



7.3.5 Contact information menu

The Contact menu displays the ASUS contact information, e-mail addresses, and useful links if you need more information or technical support for your motherboard.

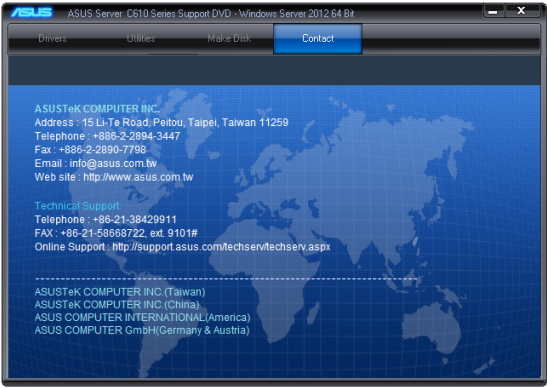

7.4 Intel® chipset device software installation

This section provides the instructions on how to install the Intel® chipset device software on the system.

You need to manually install the Intel® chipset device software on a Windows operating system.

To install the Intel® chipset device software:

1. Restart the computer, and then log on with **Administrator** privileges.
2. Insert the motherboard/system support DVD to the optical drive. The support DVD automatically displays the **Drivers** menu if Autorun is enabled in your computer.



If Autorun is NOT enabled in your computer, browse the contents of the support DVD to locate the file **ASSETUP.EXE** from the **BIN** folder. Double-click the **ASSETUP.EXE** to run the support DVD.

3. Click the item **Intel Chipset Device Software** from the menu.

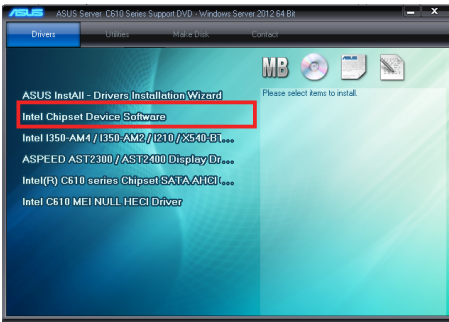

4. The **Intel® Chipset Device Software** window appears. Click **Next** to start installation.



5. Select **Yes** to accept the terms of the **License Agreement** and continue the process.

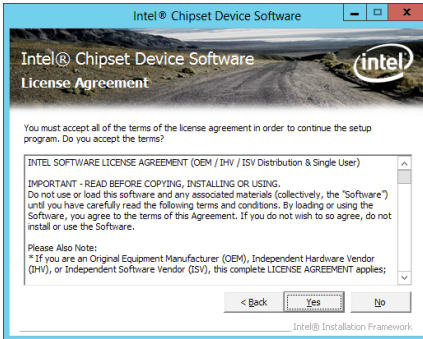

6. Read the **Readme File Information** and press **Next** to continue the installation.

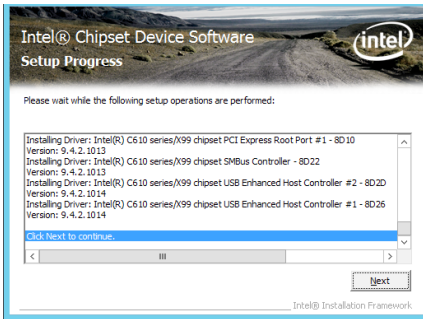

7. Toggle **Yes, I want to restart the computer now** and click **Finish** to complete the setup process.



7.5 Installing the Intel® I210 Gigabit Adapters driver

This section provides the instructions on how to install the **Intel® I210 Gigabits Adapter Driver** on the system.

To install the **Intel® I210 Gigabit Adapters Driver** on the Windows® operating system:

1. Restart the computer.
2. Log on with **Administrator** privileges.
3. Insert the motherboard/system support DVD to the optical drive.



If Autorun is NOT enabled in your computer, browse the contents of the support DVD to locate the file **ASSETUP.EXE** from the **BIN** folder. Double-click the **ASSETUP.EXE** to run the support DVD.

4. Click **Intel® I350-AM1/I350-AM2/I210/X540-BT2 Gigabit Adapters Drivers** in the **Drivers** menu of the main screen to start the installation.

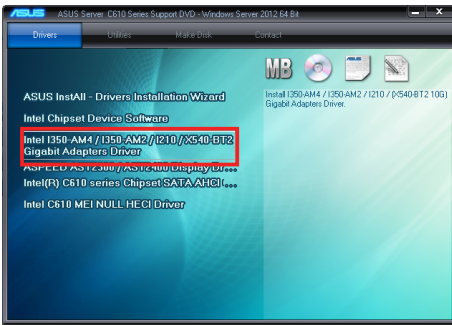

5. Click **Install Drivers and Software** option to begin installation.

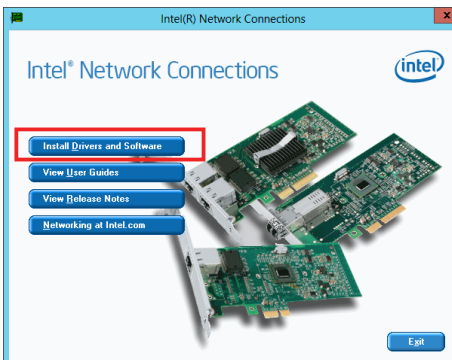

6. Click **Next** when the **Intel(R) Network Connections–InstallShield Wizard** window appears.

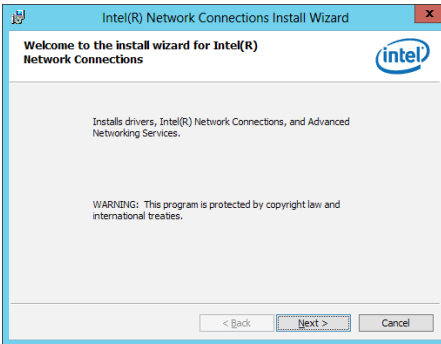

7. Tick **I accept the terms in the license agreement** and click **Next** to continue.

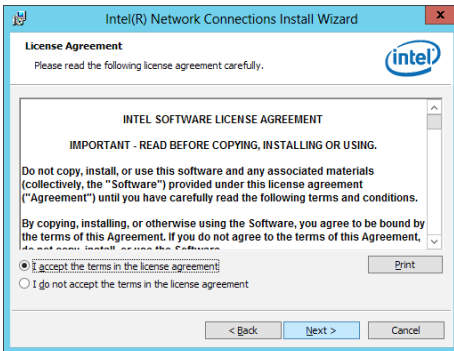

8. From the **Setup Options** window, click **Next** to start the installation.



By default, **Intel(R) PROSet for Windows Device Manager** and **Windows PowerShell Module** are ticked.

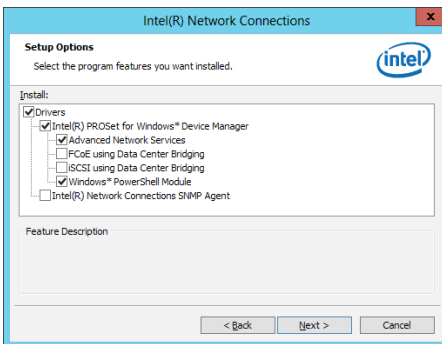

9. Click **Install** to start the installation.

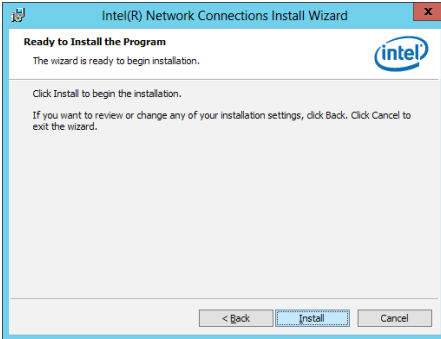

10. When the installation is done, press **Finish** to complete the installation.

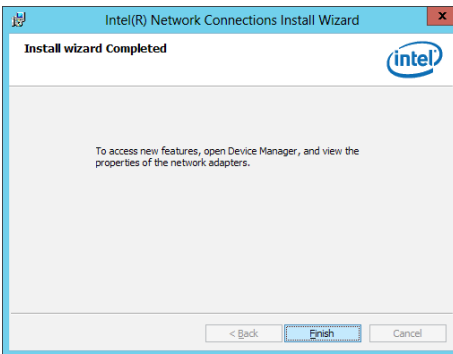

7.6 VGA driver installation

This section provides the instructions on how to install the ASPEED Video Graphics Adapter (VGA) driver.

You need to manually install the ASPEED VGA driver on a Windows® operating system.

To install the ASPEED VGA driver:

1. Restart the computer, and then log on with **Administrator** privileges.
2. Insert the motherboard/system support DVD to the optical drive. The support DVD automatically displays the **Drivers** menu if Autorun is enabled in your computer.



If Autorun is **NOT** enabled in your computer, browse the contents of the support DVD to locate the file **ASSETUP.EXE** from the **BIN** folder. Double-click the **ASSETUP.EXE** to run the support DVD.

3. Click the **ASPEED AST2300 / AST2400 Display Driver** to begin installation.

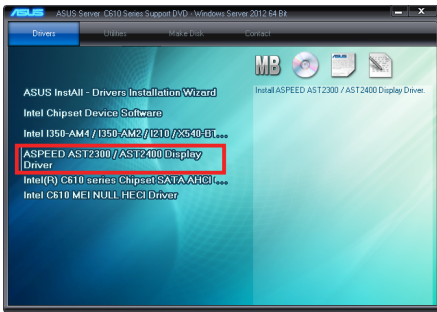

4. From the installation window, click **Next** to start the installation.



5. Click **Install** to proceed with the installation.

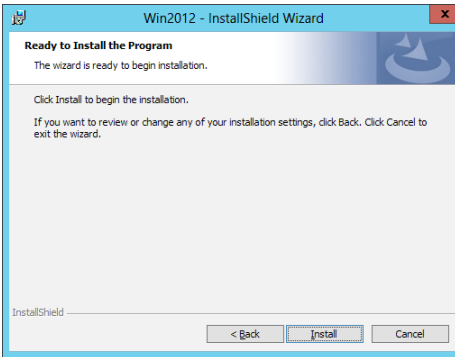

6. Click **Finish** to complete the installation.

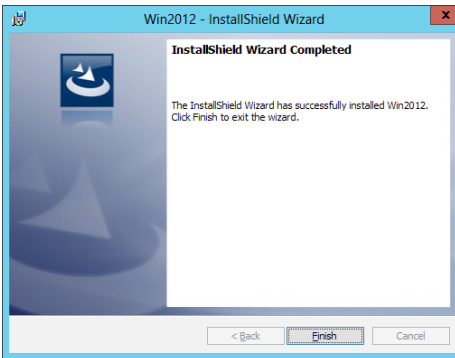

7.7 Intel® Rapid Storage Technology enterprise 4.0 installation

This section provides the instructions on how to install the Intel® Rapid Storage Technology enterprise 4.0 on the system.

You need to manually install the Intel® Rapid Storage Technology enterprise 4.0 utility on a Windows® operating system.

To install the Intel® Rapid Storage Technology enterprise 4.0 utility:

1. Restart the computer, and then log on with **Administrator** privileges.
2. Insert the motherboard/system support DVD to the optical drive, and find the utility menu.
3. Click the **Intel® Rapid Storage Technology enterprise 4.0** to begin installation.



4. When the **Welcome to the Setup Program** appears, click **Next** to start the installation.

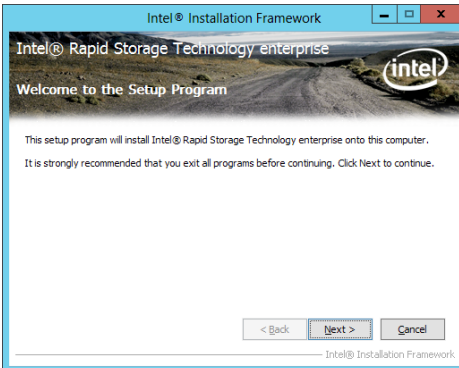

5. Read the **Warning** message and click **Next** to continue.

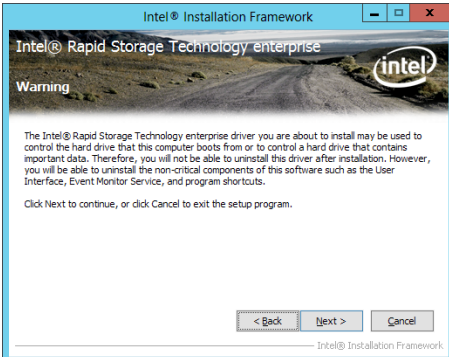

6. Read the **License Agreement** and click **Yes** to continue.

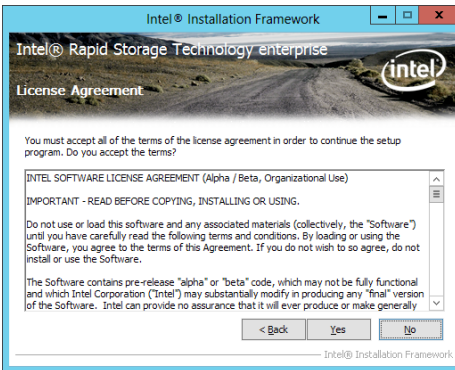

7. Read the **Readme File Information** and click **Next** to continue.

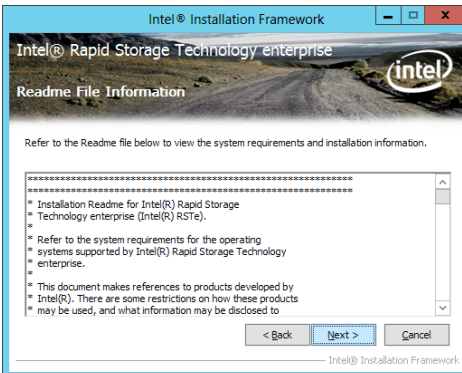

8. After completing the installation, click **Next** to complete the setup process.

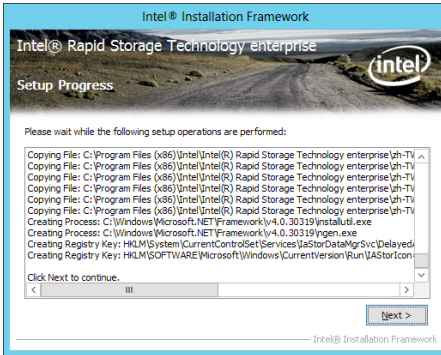

9. Select **Yes, I want to restart my computer now** and click **Finish** to restart your computer before using the program.

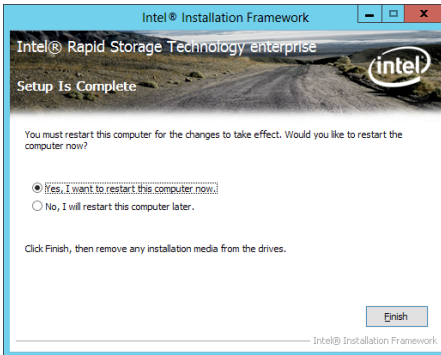

Appendix

A

ASUS contact information

ASUSTeK COMPUTER INC.

Address 15 Li-Te Road, Peitou, Taipei, Taiwan 11259
Telephone +886-2-2894-3447
Fax +886-2-2890-7798
E-mail info@asus.com.tw
Web site <http://www.asus.com.tw>

Technical Support

Telephone +86-21-38429911
Fax +86-21-58668722 ext: 9101
Online Support <http://support.asus.com/techserv/techserv.aspx>

ASUSTeK COMPUTER INC. (Taiwan)

Address 15 Li-Te Road, Peitou, Taipei, Taiwan 11259
Telephone +886-2-2894-3447
Fax +886-2-2890-7798
E-mail info@asus.com.tw
Web site <http://www.asus.com.tw>

Technical Support

Telephone +886-2-2894-3447 (0800-093-456)
Online Support <http://support.asus.com/techserv/techserv.aspx>

ASUSTeK COMPUTER INC. (China)

Address No.508, Chungong Road, Xinzhuang Industrial Zone,
Minhang District, Shanghai, China.
Telephone +86-21-5442-1616
Fax +86-21-5442-0099
Web site <http://www.asus.com.cn>

Technical Support

Telephone +86-21-3407-4610 (800-820-6655)
Online Support <http://support.asus.com/techserv/techserv.aspx>

ASUS contact information

ASUS COMPUTER INTERNATIONAL (America)

Address 800 Corporate Way, Fremont, CA 94539, USA
Fax +1-510-608-4555
Web site <http://usa.asus.com>

Technical Support

Support fax +1-812-284-0883
General support +1-812-282-2787
Online support <http://support.asus.com/techserv/techserv.aspx>

ASUS COMPUTER GmbH (Germany and Austria)

Address Harkort Str. 21-23, D-40880 Ratingen, Germany
Fax +49-2102-959911
Web site <http://www.asus.de>
Online contact <http://www.asus.de/sales>

Technical Support

Telephone +49-1805-010923
Support Fax +49-2102-959911
Online support <http://support.asus.com/techserv/techserv.aspx>

ASUS Czech Service s.r.o. (Europe)

Address Na Rovince 887, 720 00 Ostrava – Hrabová, Czech Republic
Telephone +420-596766888
Web site <http://www.asus.cz>

Technical Support

Telephone +420-596-766-891
Fax +420-596-766-329
E-mail advance.rma.eu@asus.com
Online Support <http://support.asus.com/techserv/techserv.aspx>

ASUS contact information

ASUS Holland BV (The Netherlands)

Address Marconistraat 2, 7825GD EMMEN, The Netherlands
Web site <http://www.asus.com>

Technical Support

Telephone +31-(0)591-5-70292
Fax +31-(0)591-666853
E-mail advance.rma.eu@asus.com
Online Support <http://support.asus.com/techserv/techserv.aspx>

ASUS Polska Sp. z o.o. (Poland)

Address Ul. Postępu 6, 02-676 Warszawa, Poland
Web site <http://pl.asus.com>

Technical Support

Telephone +48-225718033
Online Support <http://support.asus.com/techserv/techserv.aspx>

ASK-Service (Russia and CIS)

Address г.Москва, ул. Орджоникидзе, д.10, Россия
Telephone (495) 640-32-75
Web site <http://ru.asus.com>

Technical Support

Telephone 008-800-100-ASUS (008-800-100-2787)
Online Support <http://vip.asus.com/eservice/techserv.aspx?SLanguage=ru>