Nightblade Z97
Nightblade Z97C
Nightblade B85
Nightblade B85C

Contents

Copyright Notice.....	iii
Trademarks	iii
Revision	iii
Upgrade and Warranty	iv
Acquisition of Replaceable Parts	iv
Technical Support	iv
Green Product Features.....	iv
Environmental Policy	v
Chemical Substances Information	v
Battery Information.....	v
Safety Instructions.....	vi
CE Conformity.....	viii
FCC-B Radio Frequency Interference Statement	viii
WEEE Statement	viii

1. Overview 1-1

Nightblade Z97 Overview	1-2
Nightblade Z97C Overview	1-3
Nightblade B85 Overview	1-4
Nightblade B85C Overview	1-5
Packing Contents	1-6
Optional Accessories	1-6
OC Genie Button (Nightblade Z97)	1-7
LED Light Button (Nightblade Z97C/ B85/ B85C)	1-7
BIOS and Driver Updates	1-7
Cleaning the Dust Container	1-8

2. System Operations 2-1

Power Management	2-2
Network Connection (Windows 8.x)	2-4
System Recovery (Windows 8.x)	2-7

Copyright Notice

The material in this document is the intellectual property of MICRO-STAR INTERNATIONAL. We take every care in the preparation of this document, but no guarantee is given as to the correctness of its contents. Our products are under continual improvement and we reserve the right to make changes without notice.

Trademarks

All trademarks are the properties of their respective owners.

Revision

Revision	Date
V4.0	2014/ 07

Upgrade and Warranty

Please note that certain components preinstalled in the product may be upgradable or replaceable by user's request. For any further information about the product users purchased, please contact the local dealer. Do not attempt to upgrade or replace any component of the product if you are not an authorized dealer or service center, since it may cause the warranty void. It is strongly recommended that you contact the authorized dealer or service center for any upgrade or replace service.

Acquisition of Replaceable Parts

Please be noticed that the acquisition of replaceable parts (or compatible ones) of the product users purchased in certain countries or territories may be fulfilled by the manufacturer within 5 years at most since the product has been discontinued, depending on the official regulations declared at the time. Please contact the manufacturer via <http://www.msi.com/support/> for the detailed information about the acquisition of spare parts.

Technical Support

If a problem arises with your system and no solution can be obtained from the user's manual, please contact your place of purchase or local distributor. Alternatively, please try the following help resources for further guidance. Visit the MSI website for technical guide, BIOS updates, driver updates and other information via <http://www.msi.com/support/>

Green Product Features

- ☐ Reduced energy consumption during use and stand-by
- ☐ Limited use of substances harmful to the environment and health
- ☐ Easily dismantled and recycled
- ☐ Reduced use of natural resources by encouraging recycling
- ☐ Extended product lifetime through easy upgrades
- ☐ Reduced solid waste production through take-back policy

Environmental Policy

- ☐ The product has been designed to enable proper reuse of parts and recycling and should not be thrown away at its end of life.
- ☐ Users should contact the local authorized point of collection for recycling and disposing of their end-of-life products.
- ☐ Visit the MSI website and locate a nearby distributor for further recycling information.
- ☐ Users may also reach us at gpcontdev@msi.com for information regarding proper Disposal, Take-back, Recycling, and Disassembly of MSI products.



Chemical Substances Information

In compliance with chemical substances regulations, such as the EU REACH Regulation (Regulation EC No. 1907/2006 of the European Parliament and the Council), MSI provides the information of chemical substances in products at:

http://www.msi.com/html/popup/csr/evmtprtt_pcm.html

Battery Information



European Union:

Batteries, battery packs, and accumulators should not be disposed of as unsorted household waste. Please use the public collection system to return, recycle, or treat them in compliance with the local regulations.



Taiwan:

For better environmental protection, waste batteries should be collected separately for recycling or special disposal.

廢電池請回收

California, USA:

The button cell battery may contain perchlorate material and requires special handling when recycled or disposed of in California.

For further information please visit:

<http://www.dtsc.ca.gov/hazardouswaste/perchlorate/>

Danger of explosion if battery is incorrectly replaced. Replace only with the same or equivalent type recommended by the manufacturer.

Safety Instructions



- ☐ Read the safety instructions carefully and thoroughly.
- ☐ All cautions and warnings on the equipment or user's manual should be noted.



Keep the User's Guide that comes with the package for future reference.



Keep this equipment away from humidity and high temperature.



Lay this equipment on a reliable flat surface before setting it up.

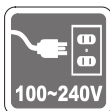

- ☐ Make sure that the power voltage is within its safety range and has been adjusted properly to the value of 100~240V before connecting the equipment to the power outlet. Do not disable the protective earth pin from the plug. The equipment must be connected to an earthed mains socket-outlet.
- ☐ Always unplug the AC power cord before installing any add-on card or module to the equipment.
- ☐ Always disconnect the AC power cord or switch the wall socket off if the equipment would be left unused for a certain time to achieve zero energy consumption.
- ☐ Power Supply: AC 100-240V~, 50/60Hz, 5-2.5A (option 1)
AC 100-127V~, 50/60Hz, 9.0A; AC 220-240V~, 50/60Hz, 4.5A (option 2)

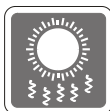

The ventilator on the enclosure is used for air convection and to prevent the equipment from overheating. Do not cover the ventilator.



Do not leave the equipment in an unconditioned environment with a storage temperature above 60°C (140°F) or below 0°C (32°F), which may damage the equipment.

NOTE: The maximum operating temperature is around 40°C.



Never pour any liquid into the opening that could damage or cause electrical shock.



Place the power cord in a way that people are unlikely to step on it. Do not place anything on the power cord.



- ☐ When installing the coaxial cable to the TV Tuner, it is necessary to ensure that the metal shield is reliably connected to protective earthing system of the building.
- ☐ Cable distribution system should be grounded (earthed) in accordance with ANSI/NFPA 70, the National Electrical Code (NEC), in particular Section 820.93, Grounding of Outer Conductive Shield of a Coaxial Cable.



Always keep the strong magnetic or electrical objects away from the equipment.

If any of the following situations arises, get the equipment checked by service personnel:



- ☐ The power cord or plug is damaged.
- ☐ Liquid has penetrated into the equipment.
- ☐ The equipment has been exposed to moisture.
- ☐ The equipment does not work well or you can not get it work according to user's manual.
- ☐ The equipment has dropped and damaged.
- ☐ The equipment has obvious sign of breakage.

1. The optical storage devices are classified as CLASS 1 LASER PRODUCT. Use of controls or adjustments or performance of procedures other than those specified is prohibited.
2. Do not touch the lens inside the drive.

CE Conformity

Hereby, Micro-Star International CO., LTD declares that this device is in compliance with the essential safety requirements and other relevant provisions set out in the European Directive.



FCC-B Radio Frequency Interference Statement

This equipment has been tested and found to comply with the limits for a Class B digital device, pursuant to Part 15 of the FCC Rules. These limits are designed to provide reasonable protection against harmful interference in a residential installation. This equipment generates, uses and can radiate radio frequency energy and, if not installed and used in accordance with the instruction manual, may cause harmful interference to radio communications. However, there is no guarantee that interference will not occur in a particular installation. If this equipment does cause harmful interference to radio or television reception, which can be determined by turning the equipment off and on, the user is encouraged to try to correct the interference by one or more of the measures listed below:



- Reorient or relocate the receiving antenna.
- Increase the separation between the equipment and receiver.
- Connect the equipment into an outlet on a circuit different from that to which the receiver is connected.
- Consult the dealer or an experienced radio/television technician for help.

Notice 1

The changes or modifications not expressly approved by the party responsible for compliance could void the user's authority to operate the equipment.

Notice 2

Shielded interface cables and AC power cord, if any, must be used in order to comply with the emission limits.

VOIR LA NOTICE D'INSTALLATION AVANT DE RACCORDER AU RESEAU.

This device complies with Part 15 of the FCC Rules. Operation is subject to the following two conditions:

1. this device may not cause harmful interference, and
2. this device must accept any interference received, including interference that may cause undesired operation.

WEEE Statement

Under the European Union ("EU") Directive on Waste Electrical and Electronic Equipment, Directive 2002/96/EC, which takes effect on August 13, 2005, products of "electrical and electronic equipment" cannot be discarded as municipal waste anymore and manufacturers of covered electronic equipment will be obligated to take back such products at the end of their useful life.



1

Overview

Nightblade Z97 Overview

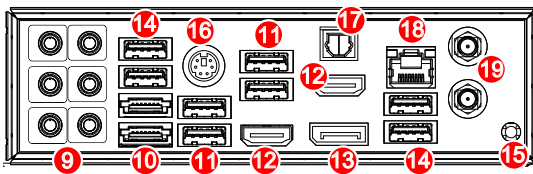
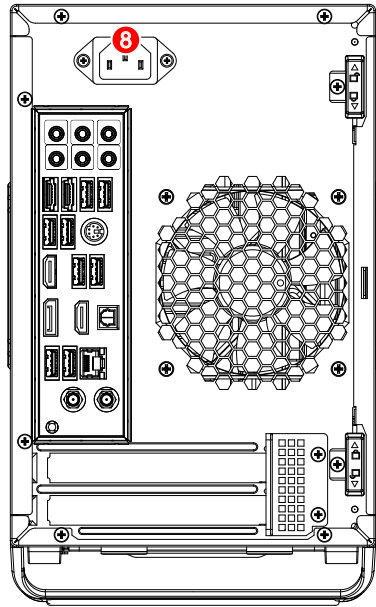
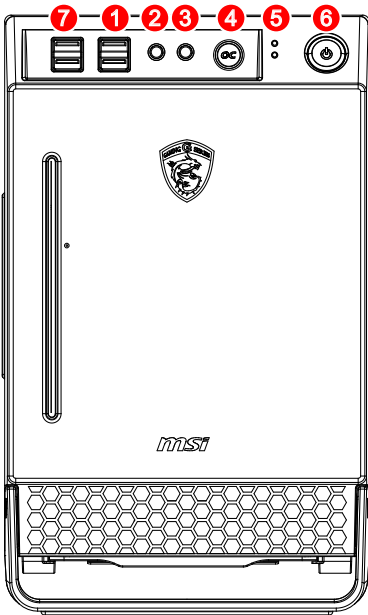

- | | |
|------------------------|------------------------------------|
| 1. USB 3.0 port | 11. USB 2.0 port |
| 2. Microphone jack | 12. HDMI port |
| 3. Line-Out jack | 13. Displayport |
| 4. OC button | 14. USB 3.0 port |
| 5. LED indicator | 15. Clear CMOS button |
| 6. System power button | 16. PS/2 Keyboard/Mouse combo port |
| 7. USB 2.0 port | 17. Optical S/PDIF-Out |
| 8. Power jack | 18. RJ-45 LAN port |
| 9. Audio port | 19. Antenna connector |
| 10. eSATA port | |

Nightblade Z97C Overview

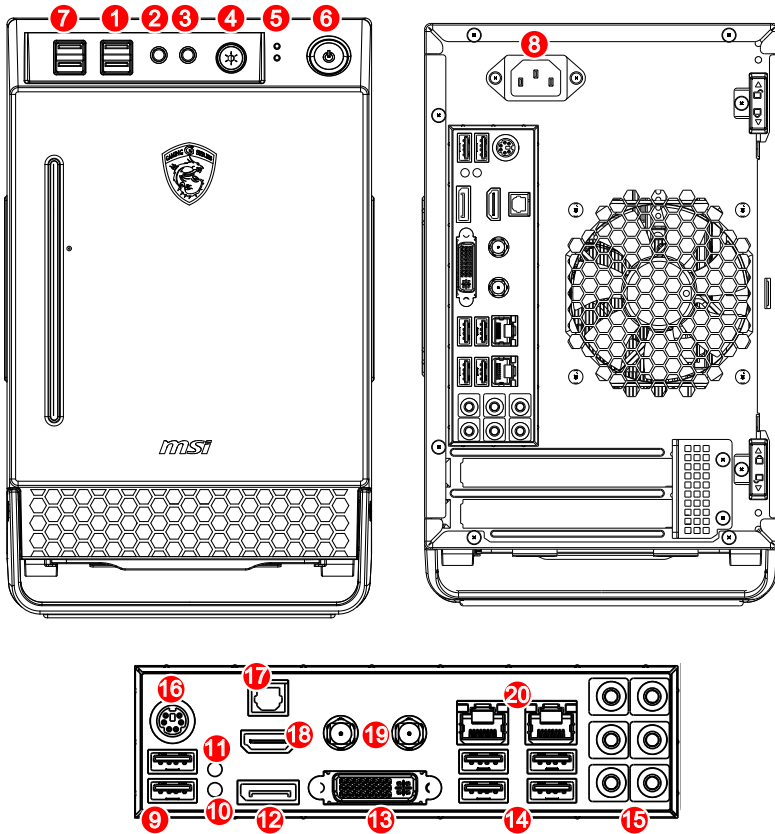

- | | |
|------------------------|------------------------------------|
| 1. USB 3.0 port | 11. GO2BIOS button |
| 2. Microphone jack | 12. Displayport |
| 3. Line-Out jack | 13. DVI-I port |
| 4. LED light button | 14. USB 3.0 port |
| 5. LED indicator | 15. Audio port |
| 6. System power button | 16. PS/2 Keyboard/Mouse combo port |
| 7. USB 2.0 port | 17. Optical S/PDIF-Out |
| 8. Power jack | 18. HDMI port |
| 9. USB 2.0 port | 19. Antenna connector |
| 10. Clear CMOS button | 20. RJ-45 LAN port |

Nightblade B85 Overview

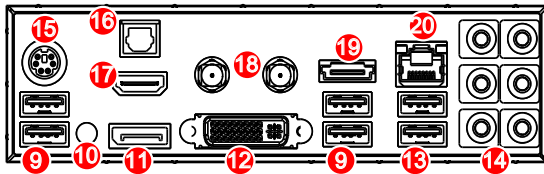
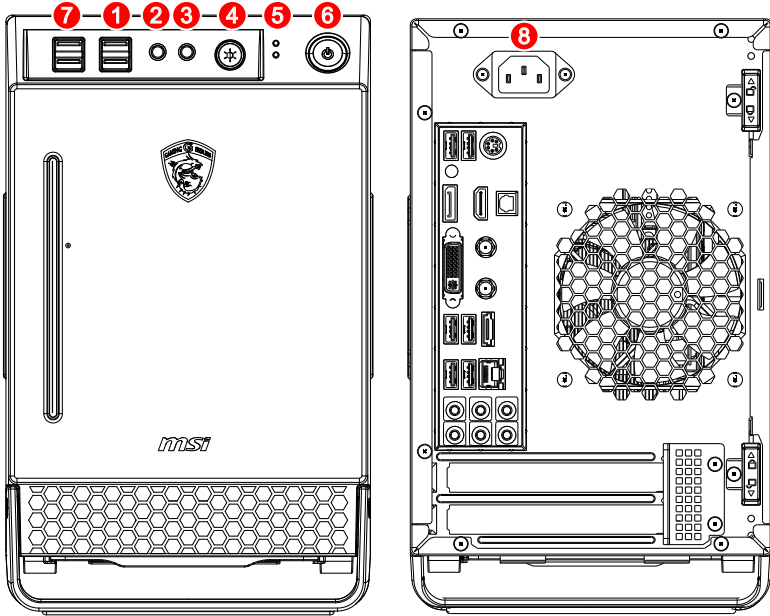

1-4

- | | |
|------------------------|------------------------------------|
| 1. USB 3.0 port | 11. Displayport |
| 2. Microphone jack | 12. DVI-I port |
| 3. Line-Out jack | 13. USB 3.0 port |
| 4. LED light button | 14. Audio port |
| 5. LED indicator | 15. PS/2 Keyboard/Mouse combo port |
| 6. System power button | 16. Optical S/PDIF-Out |
| 7. USB 2.0 port | 17. HDMI port |
| 8. Power jack | 18. Antenna connector |
| 9. USB 2.0 port | 19. eSATA port |
| 10. Clear CMOS button | 20. RJ-45 LAN port |

Nightblade B85C Overview

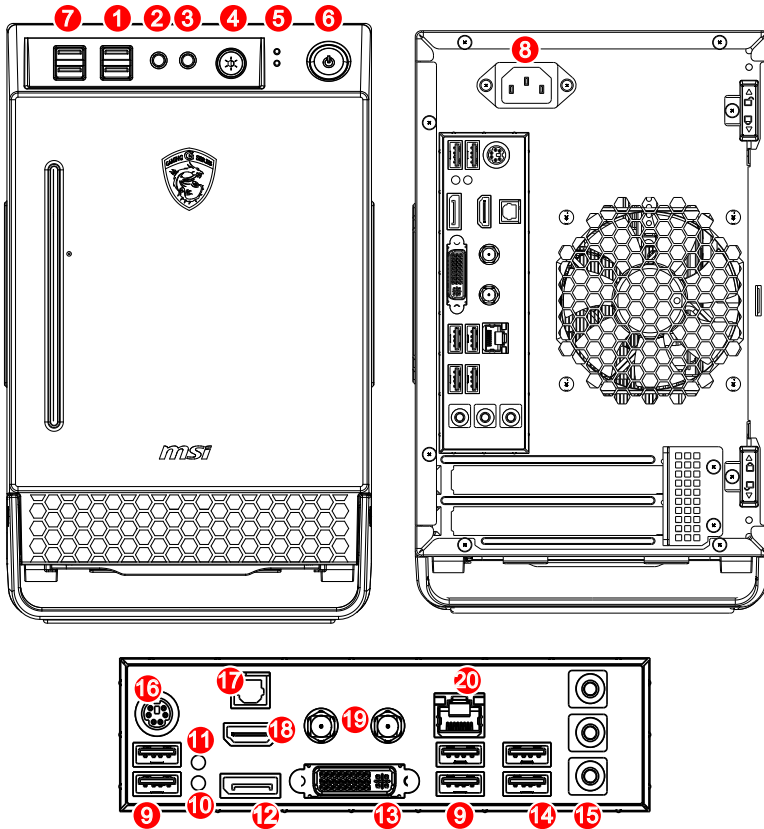

- | | |
|------------------------|------------------------------------|
| 1. USB 3.0 port | 11. GO2BIOS button |
| 2. Microphone jack | 12. Displayport |
| 3. Line-Out jack | 13. DVI-I port |
| 4. LED light button | 14. USB 3.0 port |
| 5. LED indicator | 15. Audio port |
| 6. System power button | 16. PS/2 Keyboard/Mouse combo port |
| 7. USB 2.0 port | 17. Optical S/PDIF-Out |
| 8. Power jack | 18. HDMI port |
| 9. USB 2.0 port | 19. Antenna connector |
| 10. Clear CMOS button | 20. RJ-45 LAN port |

Packing Contents

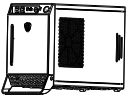

Nightblade



Drivers Disc



Utilities Disc



User Guide

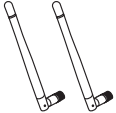

Antenna x 2
(Optional)

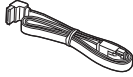

SATA Cable



M2 Screw



M3 Screw



#6-32 Flat Screw



#6-32 Sunk Screw



T5 Screw

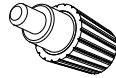

Thumber Screw

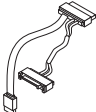

Slim ODD Cable

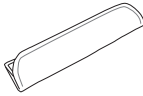

Handle Sleeve

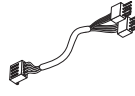

Fan Power Cable
(Optional)



VGA Sponge

1-6

Optional Accessories



CPU Cooler



CPU Cooler

* Please contact us immediately if any of the items is damaged or missing.

* The illustrations are for reference only and your packing contents may slightly vary depending on the model you purchased.

OC Genie Button (Nightblade Z97)

OC Genie button can help to gain the better performance while playing 3D games.

- Push the OC Genie button before booting.
- The button will light when the system is powered on.
- To disable the OC, please make sure that the OC Genie button is off before booting.

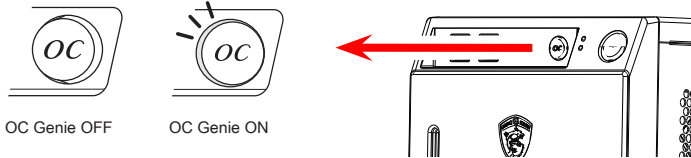

LED Light Button (Nightblade Z97C/ B85/ B85C)

Push the LED light button to turn on or off the LED on the bottom of the chassis.

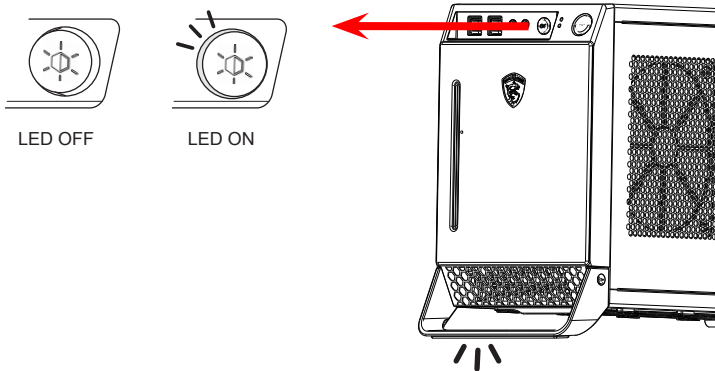

BIOS and Driver Updates

Visit the MSI website for technical guide, BIOS updates, driver updates, and other information.

<http://www.msi.com/service/download/>

Keyword: *Nightblade*



Cleaning the Dust Container

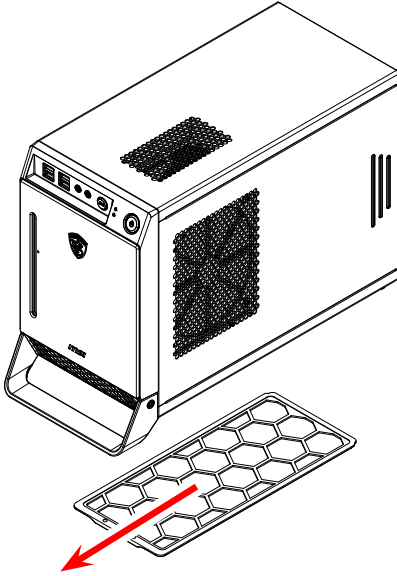

1-8

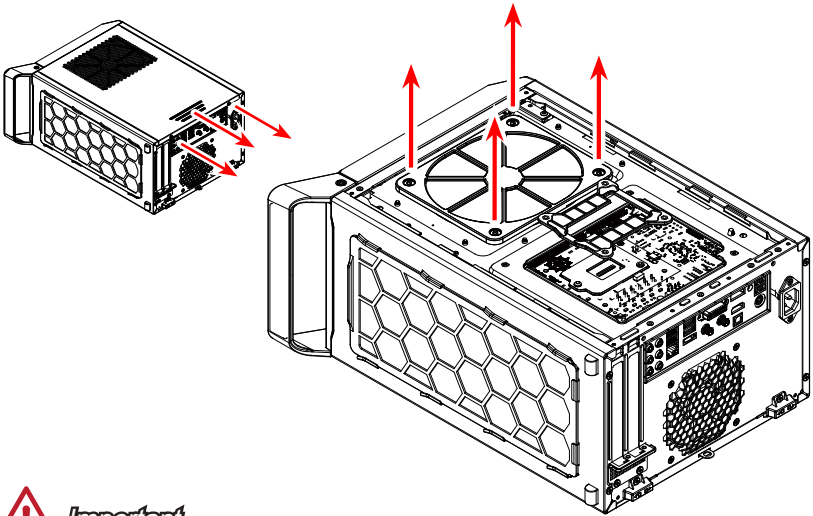

Important

Regularly cleaning the dust container could keep the system well-ventilated. Clean the dust container with clean water and dry it before replacing it to the system.

2

System Operations

This chapter provides you with essential information on system operations.

Important

All information is subject to change without prior notice.

Power Management

Power management of personal computers (PCs) and monitors has the potential to save significant amounts of electricity as well as deliver environmental benefits.

To be energy efficient, turn off your display or set your PC to sleep mode after a period of user inactivity.

► Power Management in Windows 8.x

- [Power Options] in Windows OS allow you to control the power management features of your display, hard drive, and battery. Go to [Start] > [Control Panel] > [System and Security].



2-2

Then click on the [Power Options] link.

Select a power plan that suits your personal needs. You may also fine-tune the settings by clicking [Change plan settings].

- The Shut Down Computer menu presents the options of Sleep (S3/S4) & Shut Down (S5) for rapid and easy management of your system power.

► Power Management through ENERGY STAR qualified monitors

The power management feature allows the computer to initiate a low-power or "Sleep" mode after a period of user inactivity. When used with an external ENERGY STAR qualified monitor, this feature also supports similar power management features of the monitor. To take advantage of these potential energy savings, the power management feature has been preset to behave in the following ways when the system is operating on AC power:

- Turn off the display after 15 minutes
- Initiate Sleep after 30 minutes

► Waking the System Up

The computer shall be able to wake up from power saving mode in response to a command from any of the following:

- the power button,
- the network (Wake On LAN),
- the mouse,
- the keyboard.



Energy Saving Tips:

- Turn off the monitor by pressing the monitor power button after a period of user inactivity.
- Tune the settings in Power Options under Windows OS to optimize your PC's power management.
- Install power saving software to manage your PC's energy consumption.
- Always disconnect the AC power cord or switch the wall socket off if your PC would be left unused for a certain time to achieve zero energy consumption.



ENERGY STAR

Network Connection (Windows 8.x)

► Wired LAN

1. Go to [Start] > [Control Panel].
2. Select [View network status and tasks] under [Network and Internet].

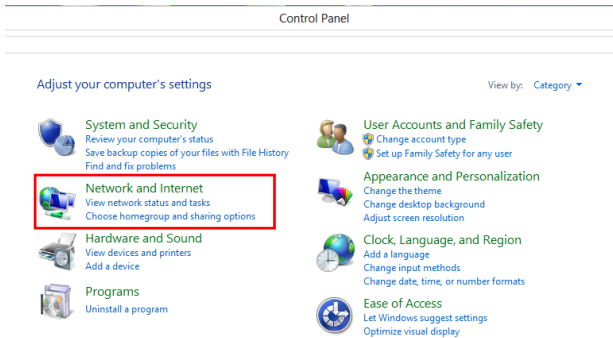

2-4

3. To establish a new connection, select [Network and Sharing Center].
4. Select [Set up a new connection or network].

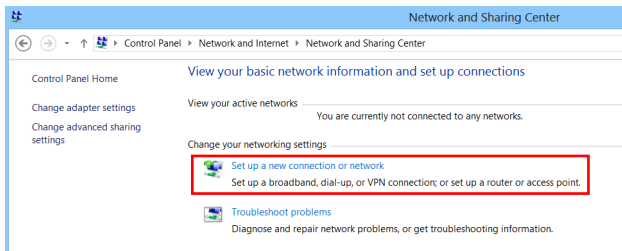

5. Choose [Connect to the Internet].
6. Select [Broadband (PPPoE)] to connect using DSL or cable that requires a user name and password.

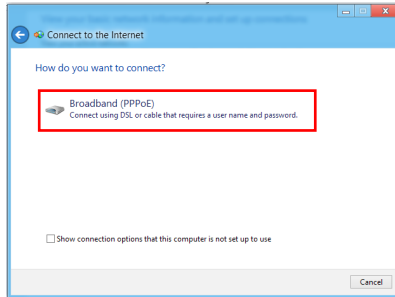

7. Type the information from your Internet Service Provider (ISP) and click [Connect] to establish your LAN connection.

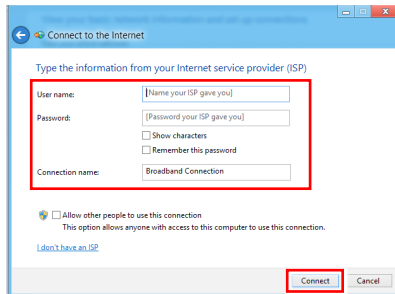

► Wireless LAN

1. Select [Settings]  on Desktop, locate a wireless icon with available network.
2. A list of available WLAN connections pops up. Choose a connection from the list.
3. To establish a new connection, select [Network and Sharing Center] under [Network and Internet] in [Control Panel].

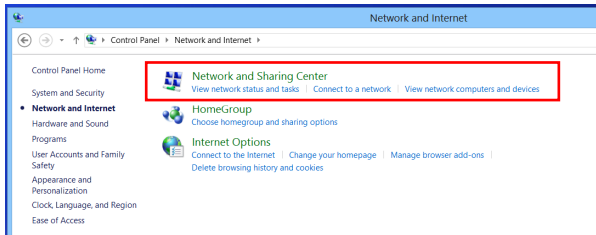

4. Select [Set up a new connection or network].
5. Followingly, choose [Manually connect to a wireless network] and click [Next] to continue.
6. Enter information for the wireless network you intend to add and click [Next] to proceed.

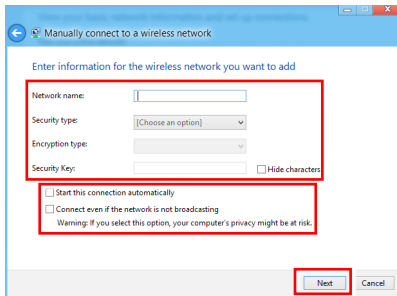

7. A new WLAN connection has been made. Click [Close] to exit or select [Change connection settings] to modify the WLAN settings.

System Recovery (Windows 8.x)

Important

The System Recovery Function is only available on systems bundled with Windows OS and MSI utilities by default.

The purposes for using the System Recovery Function may include:

- Restore the system back to the initial status of original manufacturer's default settings.
- When some errors have occurred to the operating system in use.
- When the operating system is affected by virus and is not able to work normally.
- When you want to install the OS with other built-in languages.

Before using the System Recovery Function, please back up the important data saved on your system drive to other storage devices.

If the following solution fails to recover your system, please contact the authorized local distributor or service center for further assistance.

► Recovery from the Operating System

▣ Refresh PC

The Refresh PC utility checks whether the system files, Windows registry, and other important system components are working fine or not; on finding issues with Windows files, it will attempt to repair your PC. If your PC isn't running well, you can refresh it without losing your personal files.

1. Click [Settings]  on desktop, then select [Change PC settings] > [Update and recovery].
2. Click [Recovery] > [Refresh your PC without affecting your files], and select [Get started].

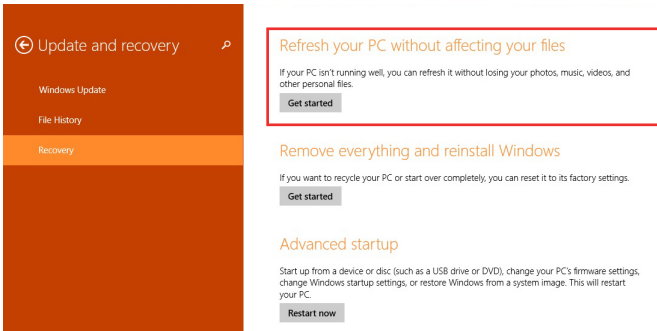

2-8

3. It will show the changes which will be made during the process, click [Next] to continue.

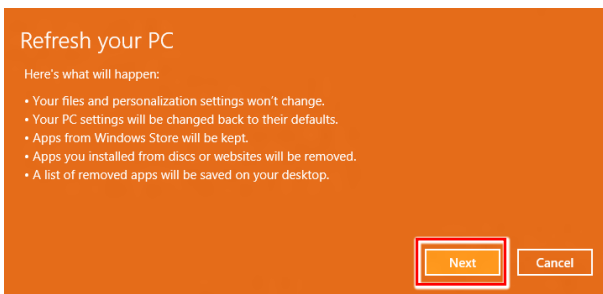

4. A message indicates that your PC is ready to be refreshed, click [Refresh] to start. This might take a while.

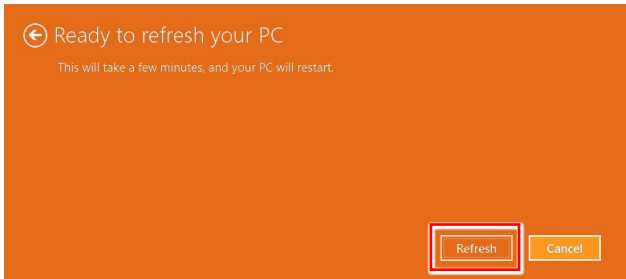

5. After the refresh process ends, you will be back to Windows Start Screen where you can find all default Windows utilities and widgets.

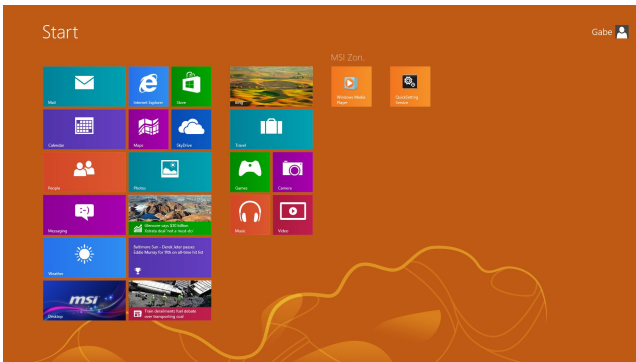

Reset PC

The Reset utility will bring the system back to original factory settings.

1. Click [Settings]  on desktop, then select [Change PC settings] > [Update and recovery].
2. Click [Recovery] > [Remove everything and reinstall Windows], and select [Get started].

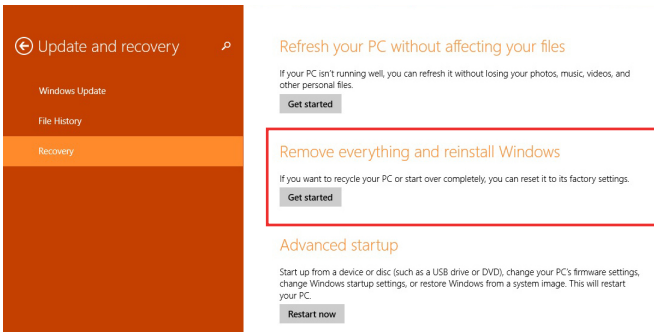

2-10

3. It will show the changes to be made during the process, click [Next] to continue.

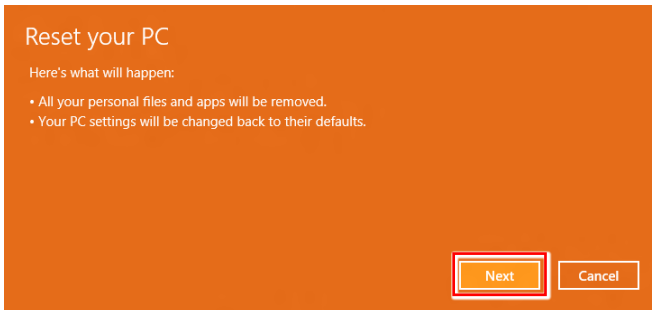

4. You will be prompted to choose which drive you want to clean for a hard disk with multiple partitions.

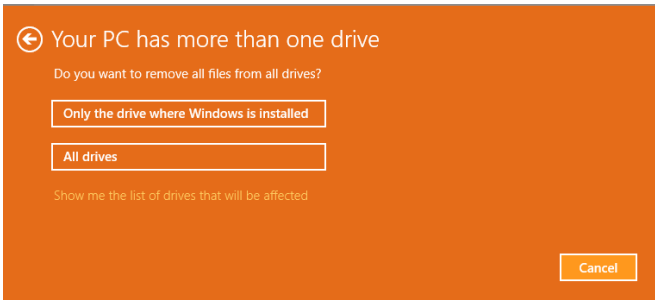

5. Now, select either to remove files or to fully clean drives according to your needs.

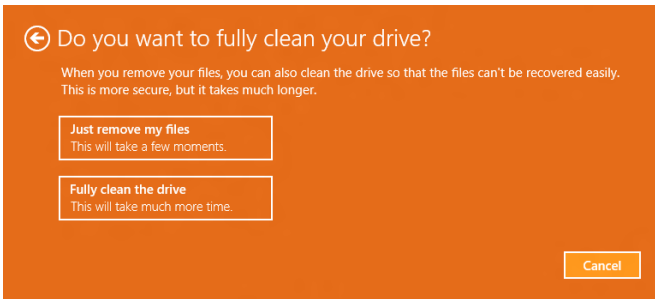

6. It is now ready to reset your PC, click [Reset] and follow the on-screen instructions to restart your PC.

