

# K375s MULTI-DEVICE

Setup Guide | Guide d'installation

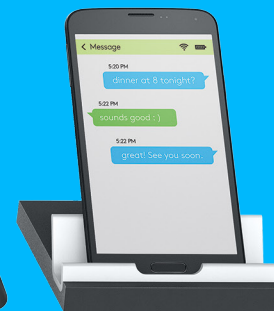

logitech®

**3** ENGLISH

**10** FRANÇAIS

**17** ESPAÑOL

**24** PORTUGUÊS

# K375s MULTI-DEVICE AT A GLANCE

- 1 Easy-Switch keys with three channels
- 2 Separate smartphone/tablet stand
- 3 Dual-printed layout: Windows®/Android™ and Mac OS/iOS
- 4 Tilt legs for adjustable angle
- 5 Battery door
- 6 Dual connectivity: Unifying receiver and Bluetooth® Smart

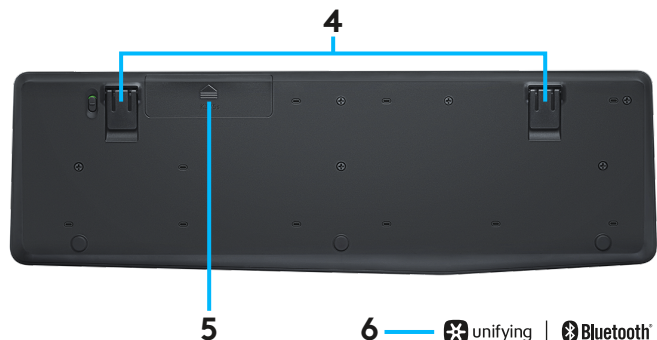
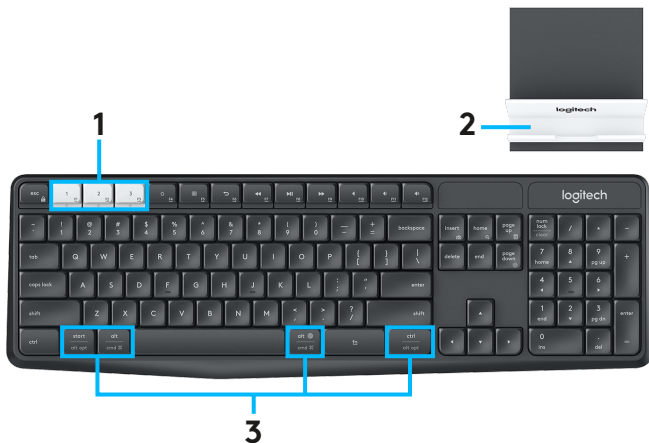

# GET CONNECTED

The K375s Multi-Device wireless keyboard and stand allows you to connect up to three devices either via *Bluetooth* Smart or via the included pre-paired Unifying USB receiver.

## Quick Setup

Follow these steps to easily connect to your computer, laptop, or tablet. For more information on how to connect with Unifying or *Bluetooth* Smart, go to the following sections.

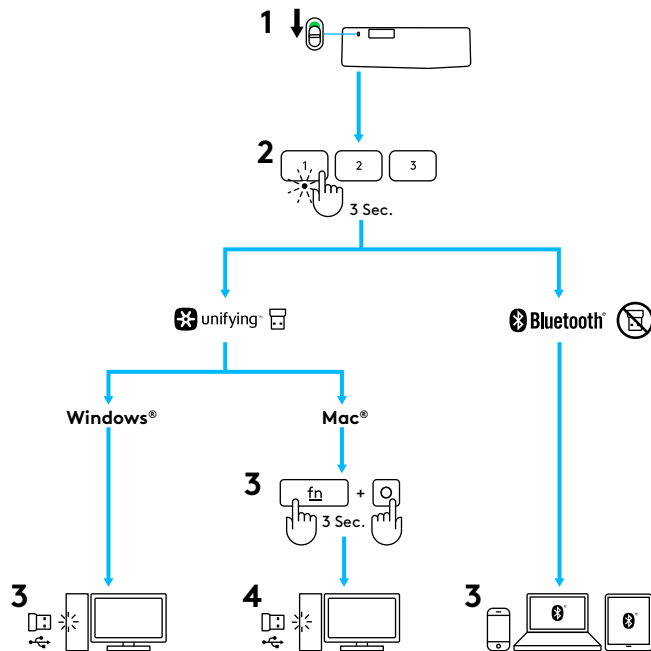

# CONNECT WITH UNIFYING

The K375s Multi-Device keyboard comes with a pre-paired receiver that provides a plug-and-play connection to your computer or laptop. If you want to pair a second time to the receiver in the box or pair to an existing Unifying receiver, follow these steps.

## Requirements

- USB port
- Unifying software
- Windows® 10 or later, Windows® 8, Windows® 7
- Mac OS X 10.10 or later
- Chrome OS™

## How to connect

- 1 Download Unifying software. You can download the software at [www.logitech.com/unifying](http://www.logitech.com/unifying).
- 2 Make sure your keyboard is turned on.
- 3 Press and hold one of the white Easy-Switch keys for three seconds. (The LED on the selected channel will blink rapidly.)
- 4 Configure your keyboard according to your operating system:
  - **For Mac OS/iOS:**  
Press and hold **fn + o** for three seconds. (The LED on selected channel will light up.)
  - **For Windows, Chrome, or Android:**  
Press and hold **fn + p** for three seconds (The LED on selected channel will light up.)
- 5 Plug in the Unifying receiver.
- 6 Open the Unifying software and follow the instructions on the screen.

## CONNECT WITH *BLUETOOTH SMART*

The K375s Multi-Device keyboard allows you to connect via *Bluetooth Smart*. Please ensure your device is *Bluetooth Smart* ready and runs one of the following operating systems:

### Requirements

- Windows® 10 or later, Windows® 8
- Android™ 5.0 or later
- Mac OS X 10.10 or later
- iOS 5 or later
- Chrome OS™

### How to connect

- 1 Make sure your K375s Multi-Device is turned on and *Bluetooth* is enabled on your computer, tablet, or phone.
- 2 Press and hold one of the white Easy-Switch keys for three seconds. (The LED on the selected channel will blink rapidly.)
- 3 Open *Bluetooth* settings on your device and pair with “Keyboard K375s.”
- 4 Type the on-screen password and press enter or return.

# ENHANCED FUNCTIONS

The K375s Multi-Device has a number of enhanced functions to get even more out of your new keyboard. The following enhanced functions and shortcuts are available.

## Hot keys and media keys







The table below shows hot keys and media keys available for Windows, Mac OS, Android, and iOS.

|                        |  |  |  |  |  |  |  |  |  |
|------------------------|---|---|---|---|---|--|---|---|---|
| Windows 10             | Task view   | Contextual menu   | Back in browser   | Previous track  | Play/pause  | Next track   | Mute  | Volume down   | Volume up   |
| Windows 8<br>Windows 7 | Browser home page   | Contextual menu   | Back in browser   | Previous track  | Play/pause  | Next track   | Mute  | Volume down   | Volume up   |
| Android                | Home  | Menu  | Back  | Previous track  | Play/pause  | Next track   | Mute  | Volume down   | Volume up   |
| iOS                    | Home  | Show/hide virtual keyboard  | Home  | Previous track  | Play/pause  | Next track   | Mute  | Volume down   | Volume up   |
| Mac OS                 | Mission Control   | Dashboard/launchpad*  | Back in browser*  | Previous track  | Play/pause  | Next track   | Mute  | Volume down   | Volume up   |

\*Requires installation of Logitech Options software

## Fn shortcuts

To perform a shortcut, hold down the **fn** (function) key while pressing the key associated with an action. The table below shows function key combinations for the different operating systems.

|                        |  |  |  |  |  |  |
|------------------------|---|---|---|--|---|---|
| Windows 10             | Lock F-functions  | F-function  | Print screen  | Cortana search   | Calculator  | Switch language   |
| Windows 8<br>Windows 7 | Lock F-functions  | F-function  | Print screen  | Search   | Calculator  | Switch language   |
| Android                | Lock F-functions  | —   | Print screen  | Search   | —   | —   |
| iOS                    | Lock F-functions  | —   | Screenshot  | Search   | —   | Switch language   |
| Mac OS                 | Lock F-functions  | F-function  | Print screen  | Spotlight in Finder  | —   | Switch language   |



# DUAL LAYOUT

Unique dual-printed keys make the K375s Multi-Device compatible across different operating systems (e.g. Mac OS, iOS, Windows, Chrome OS, Android). Key label colors and split lines identify functions or symbols reserved for different operating systems.

## Key label color

Grey labels indicate functions valid on Apple devices running Mac OS or iOS.



White labels on grey circles identify symbols reserved for Alt GR on Windows computers.



## Split keys

Modifier keys on either side of the space bar display two sets of labels separated by split lines. The label above the split line shows the modifier sent to a Windows or Android device.

The label below the split line shows the modifier sent to an Apple computer, iPhone, or iPad. The keyboard automatically uses modifiers associated with the currently selected device.



## How to configure your keyboard

To configure the layout according to your operating system you need to press one of the following shortcuts for three seconds. (The LED on selected channel will light up to confirm when the layout has been configured.)

iOS: **fn + i**



Mac OS: **fn + o**



Windows: **fn + p**



If you connect via *Bluetooth* Smart this step is not necessary as OS detection will configure it automatically.

# APERÇU DU CLAVIER K375s MULTIDISPOSITIF

- 1 Touches Easy-Switch trois canaux
- 2 Support pour smartphone/tablette distinct
- 3 Disposition à double libellé Windows®/Android™ et Mac OS /iOS
- 4 Pieds inclinables ou angle réglable
- 5 Compartiment des piles
- 6 Double connectivité: Récepteur Unifying et Bluetooth® Smart

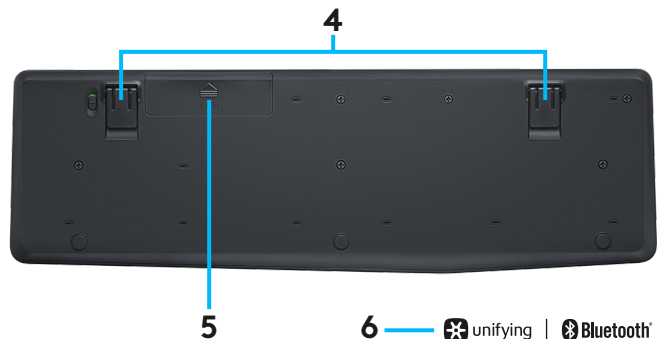
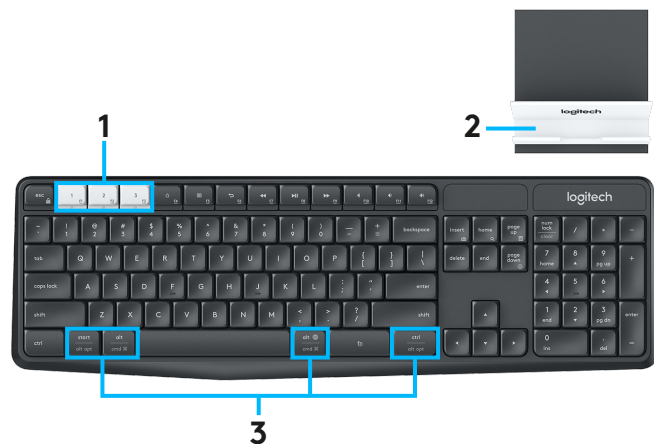

# SOYEZ CONNECTÉ

Le clavier et support sans fil K375s multidispositif vous permet de connecter jusqu'à trois dispositifs via *Bluetooth* Smart ou via le récepteur USB Unifying déjà couplé.

## Configuration rapide

Suivez les étapes ci-dessous pour le connecter facilement à votre ordinateur, ordinateur portable ou tablette. Pour plus d'informations sur la connexion grâce à Unifying ou *Bluetooth* Smart, consultez les sections ci-dessous.

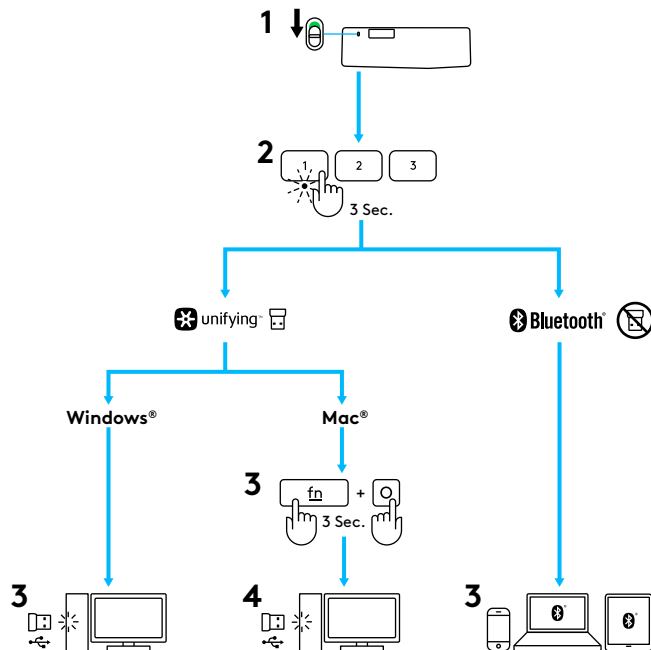

# CONNECTEZ-VOUS AVEC UNIFYING

Le clavier K375s multidispositif est fourni avec un récepteur déjà couplé qui propose une connexion prête à l'emploi pour votre ordinateur ou ordinateur portable. Si vous souhaitez à nouveau le coupler au récepteur fourni ou à un récepteur Unifying existant, suivez les étapes suivantes.

## Configuration requise

- Port USB
- Logiciel Unifying
- Windows® 10 ou version ultérieure, Windows® 8, Windows® 7
- Mac OS X 10.10 ou version ultérieure
- Chrome OS™

## Procédure de connexion

- 1 Téléchargez le logiciel Unifying. Vous pouvez télécharger le logiciel à l'adresse [www.logitech.com/unifying](http://www.logitech.com/unifying).
- 2 Vérifiez que le clavier est sous tension.
- 3 Appuyez sur une touche Easy-Switch pendant trois secondes. (Le témoin lumineux du canal sélectionné clignote rapidement.)
- 4 Configurez votre clavier en fonction de votre système d'exploitation:
  - **Pour Mac OS /iOS:**  
Appuyez sur **fn + o** pendant trois secondes.  
(Le témoin lumineux du canal sélectionné s'allume.)
  - **Pour Windows, Chrome ou Android:**  
Appuyez sur **fn + p** pendant trois secondes.  
(Le témoin lumineux du canal sélectionné s'allume.)
- 5 Branchez le récepteur Unifying.
- 6 Démarrez le logiciel Unifying et suivez les instructions à l'écran.

## CONNECTEZ-VOUS AVEC LA TECHNOLOGIE *BLUETOOTH* SMART

Le clavier K375s multidispositif vous permet de vous connecter via *Bluetooth* Smart. Assurez-vous que votre dispositif est compatible avec *Bluetooth* Smart et qu'il fonctionne avec l'un des systèmes d'exploitation suivants:

### Configuration requise

- Windows® 10 ou versions ultérieures, Windows® 8
- Android™ 5.0 ou version ultérieure
- Mac OS X 10.10 ou version ultérieure
- iOS 5 ou version ultérieure
- Chrome OS™

### Procédure de connexion









- 1 Vérifiez que le clavier K375s multidispositif est sous tension et que le *Bluetooth* est activé sur votre ordinateur, tablette ou téléphone.
- 2 Appuyez sur une touche Easy-Switch pendant trois secondes. (Le témoin lumineux du canal sélectionné clignote rapidement.)
- 3 Ouvrez les paramètres *Bluetooth* de votre dispositif et couplez-le avec "Clavier K375s".
- 4 Saisissez le mot de passe à l'écran et appuyez sur entrée ou retour.

# FONCTIONS AVANCÉES

Le clavier K375s multidispositif dispose d'un certain nombre de fonctions avancées qui vous permettent de tirer le meilleur profit de votre nouveau clavier. Les fonctions avancées et raccourcis suivants sont disponibles.

## Touches de raccourci et touches multimédia







Le tableau ci-dessous présente les touches de raccourci et les touches multimédia disponibles pour les systèmes Windows, Mac OS, Android et iOS.

|                        |  |  |  |  |  |  |  |  |  |
|------------------------|---|---|---|---|---|--|---|---|---|
| Windows 10             | Vue de la tâche   | Menu contextuel   | Retour au navigateur  | Piste précédente  | Lecture/pause   | Piste suivante   | Sourdine  | Volume -  | Volume +  |
| Windows 8<br>Windows 7 | Page d'accueil du navigateur  | Menu contextuel   | Retour au navigateur  | Piste précédente  | Lecture/pause   | Piste suivante   | Sourdine  | Volume -  | Volume +  |
| Android                | Accueil   | Menu  | Précédent   | Piste précédente  | Lecture/pause   | Piste suivante   | Sourdine  | Volume -  | Volume +  |
| iOS                    | Accueil   | Afficher/Masquer le clavier virtuel   | Accueil   | Piste précédente  | Lecture/pause   | Piste suivante   | Sourdine  | Volume -  | Volume +  |
| Mac OS                 | Mission Control   | Dashboard/launchpad*  | Retour au navigateur*   | Piste précédente  | Lecture/pause   | Piste suivante   | Sourdine  | Volume -  | Volume +  |

\*Nécessite l'installation du logiciel Logitech Options

## Raccourcis des touches Fn

Pour utiliser un raccourci, maintenez la touche **fn** (fonction) enfoncée et appuyez sur la touche associée à l'action que vous souhaitez exécuter. Le tableau ci-dessous décrit les combinaisons de touches de fonction pour les différents systèmes d'exploitation.

|                        |  |  |  |  |  |  |
|------------------------|---|---|---|--|---|---|
| Windows 10             | Verrouiller les raccourcis de fonction  | Raccourci de fonction   | Impression d'écran  | Recherche Cortana  | Calculatrice  | Changer de langue   |
| Windows 8<br>Windows 7 | Verrouiller les raccourcis de fonction  | Raccourci de fonction   | Impression d'écran  | Recherche  | Calculatrice  | Changer de langue   |
| Android                | Verrouiller les raccourcis de fonction  | —   | Impression d'écran  | Rechercher   | —   | —   |
| iOS                    | Verrouiller les raccourcis de fonction  | —   | Capture d'écran   | Rechercher   | —   | Changer de langue   |
| Mac OS                 | Verrouiller les raccourcis de fonction  | Raccourci de fonction   | Impression d'écran  | Infos produit dans le Finder   | —   | Changer de langue   |

# DISPOSITION DOUBLE

Les touches à double fonction rendent le clavier K375s multidispositif compatible avec différents systèmes d'exploitation (par exemple, Mac OS, iOS, Windows, Chrome OS et Android). Les couleurs des libellés de touches et les lignes de division identifient les fonctions et symboles réservés aux différents systèmes d'exploitation.

## Couleurs des libellés de touches

Les libellés gris indiquent des fonctions disponibles sur les dispositifs Apple sous Mac OS ou iOS.



Les libellés blancs sur cercles gris identifient les symboles réservés à une utilisation avec la touche Alt + Gr sur les ordinateurs Windows.



## Touches divisées

Les touches de combinaison des deux côtés de la barre d'espacement affichent deux jeux de libellés séparés par des lignes de division. Le libellé au-dessus de la ligne de division identifie la combinaison envoyée au dispositif Windows ou Android.

Le libellé en dessous de la ligne de division identifie la combinaison envoyée à l'ordinateur Apple, ou au dispositif iPhone ou iPad. Le clavier utilise automatiquement les combinaisons associées au dispositif actuellement sélectionné.



## Configurer votre clavier

Pour configurer la disposition en fonction de votre système d'exploitation, vous devez appuyer sur l'un des raccourcis suivants pendant 3 secondes. Le témoin lumineux du canal sélectionné s'allume pour confirmer que la disposition a été configurée.

iOS: **fn + i**



Mac OS : **fn + o**



Windows: **fn + p**



Si vous vous connectez via *Bluetooth Smart*, cette étape n'est pas nécessaire car OS détecte et configure automatiquement.



# VISIÓN GENERAL DE K375s MULTI-DEVICE

- 1 Teclas Easy-Switch con tres canales
- 2 Soporte para smartphone/tablet independiente
- 3 Doble identificación de teclas: Windows®/Android™ y Mac OS/iOS
- 4 Patas con ángulo ajustable
- 5 Tapa de compartimento de baterías
- 6 Conectividad doble: Receptor Unifying y Bluetooth® Smart

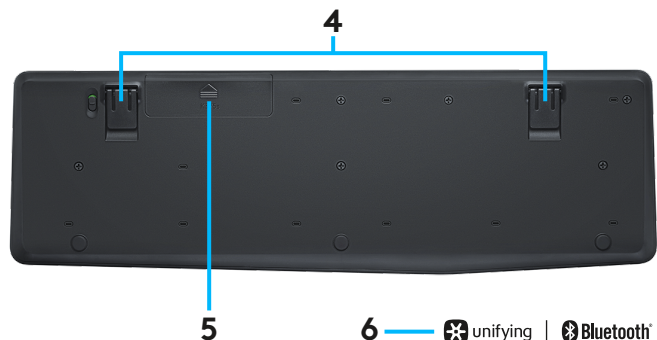
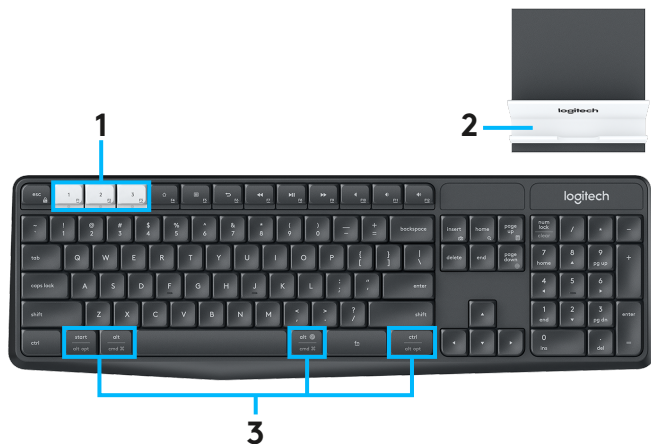

# CONEXIÓN

El teclado inalámbrico K375s Multi-Device y el soporte admiten hasta tres dispositivos conectados mediante *Bluetooth Smart* o con el receptor USB Unifying preemparejado.

## Procedimiento rápido

Sigue los pasos detallados a continuación para conectar fácilmente el teclado a tu computadora, laptop o tablet. Para obtener más información sobre cómo establecer la conexión vía Unifying o *Bluetooth Smart*, consulta las secciones siguientes.

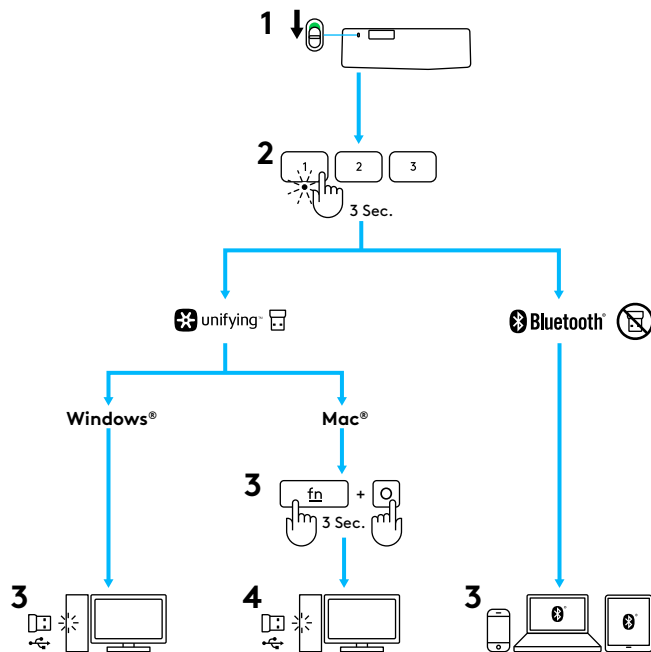

# CONECTAR CON UNIFYING

El teclado K375s Multi-Device se suministra con un receptor preemparejado que proporciona una conexión Plug and Play a la computadora o laptop. Para un segundo emparejamiento con el receptor suministrado o con otro receptor Unifying existente, sigue el procedimiento descrito a continuación.

## Requisitos

- Puerto USB
- Software Unifying
- Windows® 10 o posterior, Windows® 8, Windows® 7
- Mac OS X 10.10 o posterior
- Chrome OS™

## Cómo conectar

- 1 Descarga el software Unifying. Puedes descargar el software desde [www.logitech.com/unifying](http://www.logitech.com/unifying).
- 2 Asegúrate de que el teclado está encendido.
- 3 Mantén presionada una de las teclas Easy-Switch blancas durante tres segundos. El LED del canal seleccionado emitirá destellos rápidos.
- 4 Configura el teclado según el sistema operativo:
  - **Para Mac OS/iOS:**  
Mantén presionadas las teclas **fn + o** durante tres segundos.  
Se iluminará el LED del canal seleccionado.
  - **Para Windows, Chrome o Android:**  
Mantén presionadas las teclas **fn + p** durante tres segundos  
(se iluminará el LED del canal seleccionado).
- 5 Conecta el receptor Unifying.
- 6 Abre el software Unifying y sigue las instrucciones en pantalla.

# CONEXIÓN CON TECNOLOGÍA *BLUETOOTH* SMART

El teclado K375s Multi-Device se puede conectar usando *Bluetooth* Smart. Asegúrate de que tu dispositivo es compatible con *Bluetooth* Smart y tiene uno de estos sistemas instalados:

## Requisitos

- Windows® 10 o posterior, Windows® 8
- Android™ 5.0 o posterior
- Mac OS X 10.10 o posterior
- iOS 5 o posterior
- Chrome OS™

## Cómo conectar

- 1 Asegúrate de que el teclado K375s Multi-Device está encendido y *Bluetooth* está activado en la computadora, la tablet o el teléfono.
- 2 Mantén presionada una de las teclas Easy-Switch blancas durante tres segundos. El LED del canal seleccionado emitirá destellos rápidos.
- 3 Accede a la configuración *Bluetooth* del dispositivo y emparéjalo con “Keyboard K375s”.
- 4 Escribe la contraseña en pantalla y presiona Entrar o Intro.

## FUNCIONES MEJORADAS

El teclado K375s Multi-Device tiene varias funciones mejoradas para un aprovechamiento máximo. A continuación se muestran las disponibles y los accesos directos.

### Teclas de acceso rápido y multimedia







La tabla siguiente muestra las teclas de acceso rápido y multimedia disponibles para Windows, Mac OS, Android y iOS.

|                        |  |  |  |  |  |  |  |  |  |
|------------------------|---|---|---|---|---|--|---|---|---|
| Windows 10             | Vista de tarea  | Menú contextual   | Atrás en navegador  | Pista anterior  | Reproducir/pausa  | Pista siguiente  | Silencio  | Bajar volumen   | Subir volumen   |
| Windows 8<br>Windows 7 | Página de inicio de navegador   | Menú contextual   | Atrás en navegador  | Pista anterior  | Reproducir/pausa  | Pista siguiente  | Silencio  | Bajar volumen   | Subir volumen   |
| Android                | Inicio  | Menú  | Atrás   | Pista anterior  | Reproducir/pausa  | Pista siguiente  | Silencio  | Bajar volumen   | Subir volumen   |
| iOS                    | Inicio  | Mostrar/ocultar teclado virtual   | Inicio  | Pista anterior  | Reproducir/pausa  | Pista siguiente  | Silencio  | Bajar volumen   | Subir volumen   |
| Mac OS                 | Mission Control   | Dashboard/Launchpad*  | Atrás en navegador*   | Pista anterior  | Reproducir/pausa  | Pista siguiente  | Silencio  | Bajar volumen   | Subir volumen   |

\*Requiere la instalación del software Logitech Options

## Accesos directos mediante teclas Fn

Para usar un acceso directo, mantén presionada la tecla de función (**fn**) mientras presionas la tecla asignada a la acción. La tabla siguiente muestra las combinaciones de teclas de función especiales para los distintos sistemas operativos.

|                        |  |  |  |  |  |  |
|------------------------|---|---|---|--|---|---|
| Windows 10             | Funciones F de bloqueo  | Función F   | Imprimir pantalla   | Búsquedas con Cortana  | Calculadora   | Cambiar idioma  |
| Windows 8<br>Windows 7 | Funciones F de bloqueo  | Función F   | Imprimir pantalla   | Buscar   | Calculadora   | Cambiar idioma  |
| Android                | Funciones F de bloqueo  | —   | Imprimir pantalla   | Buscar   | —   | —   |
| iOS                    | Funciones F de bloqueo  | —   | Captura de pantalla   | Buscar   | —   | Cambiar idioma  |
| Mac OS                 | Funciones F de bloqueo  | Función F   | Imprimir pantalla   | Spotlight en Finder  | —   | Cambiar idioma  |

# DOBLE IDENTIFICACIÓN DE TECLAS

Las teclas con etiquetas dobles facilitan el uso del teclado K375s Multi-Device en distintos sistemas operativos (por ejemplo, Mac OS, iOS, Windows, Chrome OS, Android). Los colores y las divisiones de las teclas identifican las funciones o los símbolos reservados para los distintos sistemas operativos.

## Color de etiqueta de tecla

Las etiquetas de color gris indican funciones disponibles en dispositivos Apple con Mac OS o iOS.



Las etiquetas de color blanco sobre círculos grises identifican los símbolos reservados para su uso con Alt GR en computadoras con Windows.



## Teclas divididas

Las teclas modificadoras a ambos lados de la barra espaciadora muestran dos conjuntos de etiquetas separadas por líneas divisorias. La etiqueta situada sobre la línea divisoria identifica los modificadores enviados a dispositivos con Windows o Android.

La etiqueta situada debajo de la línea divisoria identifica los modificadores enviados a una computadora Apple, un iPhone o un iPad. El teclado utiliza de manera automática los modificadores asociados al dispositivo seleccionado actualmente.



## Cómo configurar el teclado

Para configurar el teclado de acuerdo con el sistema operativo, presiona uno de estos accesos directos durante tres segundos. El LED del canal seleccionado se iluminará para confirmar que se ha establecido la configuración.

iOS: **fn + i**



Mac OS: **fn + o**



Windows: **fn + p**



Si usas *Bluetooth Smart* para la conexión, este paso no es necesario, ya que la función de detección de sistema operativo se encarga de la configuración automáticamente.

## K375s MULTI-DEVICE EM LINHAS GERAIS

- 1 Teclas de mudança rápida com três canais
- 2 Suporte separado para smartphone/tablet
- 3 Layout de impressão dupla: Windows®/Android™ e Mac OS/iOS
- 4 Braços giratórios para ângulos ajustáveis
- 5 Porta do compartimento da pilha
- 6 Conectividade dupla: Receptor Unifying e Bluetooth® Smart

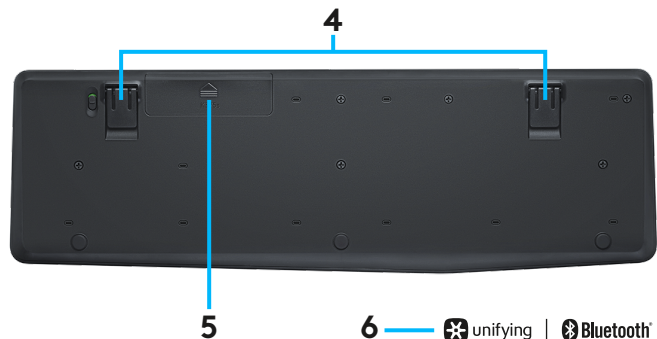
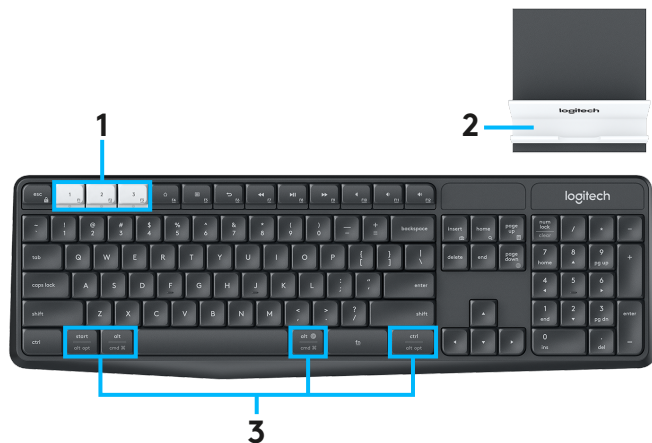



# CONECTE-SE

O suporte e teclado multidispositivo K375s sem fio permite se conectar a até três dispositivos por *Bluetooth* Smart ou por um receptor USB Unifying pré-emparelhado.

## Instalação rápida

Siga estas etapas para se conectar facilmente ao seu computador, laptop ou tablet. Para obter mais informações sobre como se conectar com o Unifying ou com o *Bluetooth* Smart, consulte as seções a seguir.

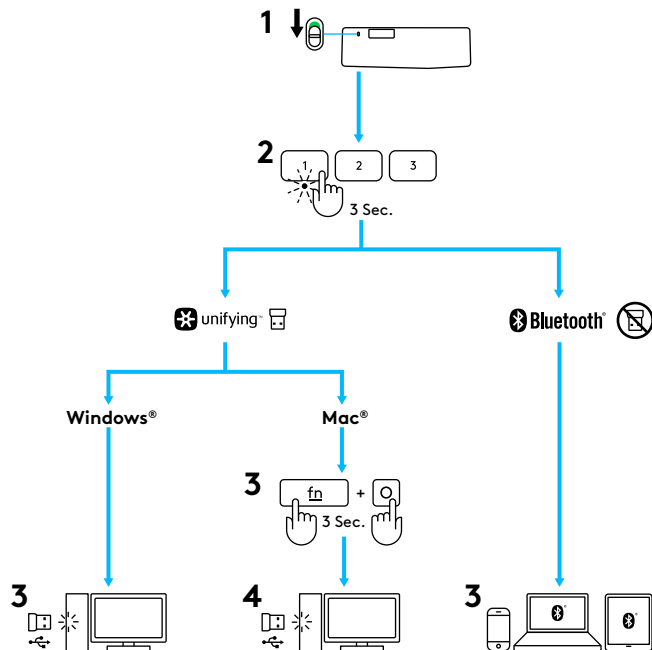

# CONEXÃO COM UNIFYING

O teclado multidispositivo K375s vem com um receptor pré-emparelhado para uma conexão plug-and-play com computador ou laptop. Se você quiser emparelhar uma segunda vez ao receptor da caixa ou emparelhar com um receptor Unifying existente, siga estas etapas.

## Requisitos

- Porta USB
- Software Unifying
- Windows® 10 ou posterior, Windows® 8, Windows® 7
- Mac OS X 10.10 ou posterior
- Chrome OS™

## Como conectar

- 1 Baixe o software Unifying. Baixe o software em [www.logitech.com/unifying](http://www.logitech.com/unifying).
- 2 Certifique-se de que o teclado esteja ligado.
- 3 Mantenha pressionada uma das teclas de mudança fácil brancas por três segundos. (O LED no canal selecionado piscará rapidamente).
- 4 Configure o teclado de acordo com seu sistema operacional:
  - **No Mac OS/iOS:**  
Mantenha pressionado **fn + o** por três segundos. (O LED no canal selecionado vai acender).
  - **No Windows, Chrome ou Android:**  
Pressione e mantenha **fn + p** por três segundos (o LED no canal selecionado se acenderá).
- 5 Conecte o Unifying Receiver.
- 6 Abra o software Unifying e siga as instruções exibidas na tela.

## CONEXÃO POR *BLUETOOTH SMART*

O teclado multidispositivo K375s permite se conectar via *Bluetooth Smart*. Certifique-se de que o *Bluetooth Smart* do dispositivo esteja ligado e utiliza um dos seguintes sistemas operacionais:

### Requisitos

- Windows® 10 ou posterior, Windows® 8
- Android™ 5.0 ou posterior
- Mac OS X 10.10 ou posterior
- iOS 5 ou posterior
- Chrome OS™

### Como conectar

- 1 Certifique-se de que o teclado multidispositivo K375s esteja ligado e o *Bluetooth* ativado em seu computador, tablet ou telefone.
- 2 Mantenha pressionada uma das teclas de mudança fácil brancas por três segundos. (O LED no canal selecionado piscará rapidamente).
- 3 Abra as configurações do *Bluetooth* no seu dispositivo e emparelhe com "Keyboard K375s".
- 4 Digite a senha na tela e pressione Enter ou Return.

# FUNÇÕES APRIMORADAS

O teclado multidispositivo K375s inclui uma série de funções aprimoradas para aproveitar ainda mais seus recursos. Ele integra os atalhos e funções aprimoradas a seguir.

## Teclas de atalho e de mídia







A tabela abaixo mostra as teclas de atalho e mídia disponíveis para Windows, Mac OS, Android e iOS.

|                        |  |  |  |  |  |  |  |  |  |
|------------------------|---|---|---|---|---|--|---|---|---|
| Windows 10             | Exibição de tarefa  | Menu de contexto  | Voltar no navegador   | Faixa anterior  | Reproduzir/Pausar   | Próxima faixa  | Sem som   | Menos volume  | Mais volume   |
| Windows 8<br>Windows 7 | Página inicial do navegador   | Menu de contexto  | Voltar no navegador   | Faixa anterior  | Reproduzir/Pausar   | Próxima faixa  | Sem som   | Menos volume  | Mais volume   |
| Android                | Início  | Menu  | Voltar  | Faixa anterior  | Reproduzir/Pausar   | Próxima faixa  | Sem som   | Menos volume  | Mais volume   |
| iOS                    | Início  | Mostrar/ocultar teclado virtual   | Início  | Faixa anterior  | Reproduzir/Pausar   | Próxima faixa  | Sem som   | Menos volume  | Mais volume   |
| Mac OS                 | Mission Control   | Painel/launchpad*   | Voltar no navegador*  | Faixa anterior  | Reproduzir/Pausar   | Próxima faixa  | Sem som   | Menos volume  | Mais volume   |

\*Requer a instalação do software Logitech Options

## Atalhos fn

Para executar um atalho, mantenha a tecla **fn** (função) pressionada juntamente com a tecla associada a uma ação. A tabela abaixo mostra as combinações da tecla de função para os diferentes sistemas operacionais.

|                        |  |  |  |  |  |  |
|------------------------|---|---|---|--|---|---|
| Windows 10             | Bloquear funções F  | Função F  | Print Screen  | Pesquisa Cortana   | Calculadora   | Alternar idioma   |
| Windows 8<br>Windows 7 | Bloquear funções F  | Função F  | Print Screen  | Pesquisa   | Calculadora   | Alternar idioma   |
| Android                | Bloquear funções F  | —   | Print Screen  | Pesquisa   | —   | —   |
| iOS                    | Bloquear funções F  | —   | Captura de tela   | Pesquisa   | —   | Alternar idioma   |
| Mac OS                 | Bloquear funções F  | Função F  | Print Screen  | Spotlight no Finder  | —   | Alternar idioma   |

# LAYOUT DUPLO

Teclas exclusivas de impressão dupla fazem com o que o teclado multidispositivo K375s seja compatível em vários sistemas operacionais (por exemplo, Mac OS, iOS, Windows, Chrome, Android). As cores das etiquetas das teclas e as linhas de divisão identificam as funções ou símbolos reservados para diferentes sistemas operacionais.

## Cor de etiquetas das teclas

As etiquetas de cor cinza indicam funções válidas em dispositivos Apple com Mac OS ou iOS.



Etiquetas de cor branca em círculos de cor cinza identificam símbolos reservados para ALT GR em computadores com Windows.



## Teclas de divisão

Teclas modificadoras em cada lado da barra de espaço exibem dois conjuntos de etiquetas separados por linhas de divisão. A etiqueta acima da linha de divisão mostra o modificador enviado a um dispositivo Windows ou Android. A etiqueta abaixo da linha de divisão mostra o modificador enviado a um computador Apple, iPhone ou iPad. O teclado usa automaticamente os modificadores associados ao dispositivo atualmente selecionado.



## Como configurar seu teclado

Para configurar o layout de acordo com seu sistema operacional, você precisa pressionar um dos seguintes atalhos por três segundos. (O LED no canal selecionado se acenderá para confirmar que o layout foi configurado.)

iOS: **fn + i**



Mac OS: **fn + o**



Windows: **fn + p**



Se você se conectar ao *Bluetooth Smart*, esta etapa não é necessária, pois o OS Detection vai configurá-lo automaticamente.

© 2016 Logitech. Logitech, Logi, and other Logitech marks are owned by Logitech and may be registered. The *Bluetooth*® word mark and logos are registered trademarks owned by Bluetooth SIG, Inc. and any use of such marks by Logitech is under license. All other trademarks are the property of their respective owners.

© 2016 Logitech. Logitech, Logi et les autres marques Logitech sont la propriété de Logitech et sont susceptibles d'être déposées. La marque et les logos *Bluetooth*® sont des marques déposées détenues par Bluetooth SIG, Inc. et sont utilisés par Logitech sous licence. Toutes les autres marques sont la propriété exclusive de leurs détenteurs respectifs.

WEB-621-000801.002