

OLYMPUS

DIGITAL VOICE RECORDER

VP-20

USER MANUAL

Getting started

1

Recording

2

Playback

3

Menu

4

Use with a PC

5

Other information

6

Thank you for purchasing an Olympus digital voice recorder.
Please read these instructions for information about using the product correctly and safely.
Keep the instructions handy for future reference.

-
- To ensure successful recording, we recommend that you test the record function and volume before use.
 - If there are additions and/or modifications of functions due to firmware update, contents may differ. For the latest information, please visit Olympus website.

EN

Table of contents

Names of parts	4
Recorder.....	4
Display.....	5

1 Getting started

Setup	6
Inserting the battery.....	7
Turning the power ON.....	8
Setting the inserted battery.....	8
Setting the time/date.....	9
Charging the battery by connecting to a PC's USB connector.....	10
Charging the battery by connecting to an USB-AC adapter with a USB connection (model F-SAC).....	11

Batteries	13
------------------------	-----------

Turning the power OFF	15
Turning the power OFF.....	15

2 Recording

Recording	16
Basic recording procedure.....	16
Using earphones.....	19

Selecting the automatic recording setting [Rec Scene]	20
Selecting the automatic recording setting [Rec Scene].....	20

Recording with an External Microphone	22
--	-----------

Recording by Connecting to an External Device	23
Recording sounds of an external device.....	23
Recording sounds of the voice recorder in an external device.....	23

Changing the information screen during recording	24
Changing the information screen during recording.....	24

3 Playback

Playback	25
Basic playback procedure.....	25
Fast-forwarding.....	26
Rewinding.....	26
Skipping to the beginning of a file.....	27
Listening with earphones.....	28

Selecting the automatic playback operation [Play Scene]	29
Selecting the automatic playback operation [Play Scene].....	29

Changing the playback speed	30
Changing the playback speed.....	30

Index marks/temp marks	31
Writing an index mark/temp mark.....	31
Erasing an index mark/temp mark.....	31

Preventing accidental operation	32
Setting HOLD mode.....	32
Releasing HOLD mode.....	32

Changing the information screen during playback or stop	33
Changing the information screen during playback or stop.....	33

Searching for a file [Date Search]	34
Using the date search function.....	34

Erasing files	35
Erasing files.....	35

4 Menu

Setting menu items	37
Basic operation.....	37

File menu [File Menu]	39
Preventing accidental file erasure [File Lock].....	39
Dividing files [File Divide].....	39
Displaying file information [Property].....	39

Recording menu [Rec Menu]	40
Selecting the recording sensitivity [Rec Level].....	40
Setting the recording mode [Rec Mode].....	40
Reducing noise caused by rubbing during recording [Anti-Rustle].....	41
Start recording after the set time has elapsed [Self-timer].....	41
Reducing noise during recording [Low Cut Filter].....	41
Voice-activated recording function [VCVA].....	41

Playback menu [Play Menu]	43
Reducing noise during playback [Noise Cancel].....	43
Adjusting low volume portions during playback [Voice Balancer].....	43
Specifying the range to play back [Playback Range].....	43
Setting the repeat playback [Repeat].....	44
Setting a skip space [Skip Space].....	44
Changing the folder for playback [Play Folder].....	45

LCD/Sound menu [LCD/Sound]	46
Setting the backlight [Backlight].....	46
Adjusting the contrast [Contrast].....	46
Setting the LED indicator light [LED].....	46
Turning beeping sound ON/OFF [Beep].....	46
Switching the display language [Language].....	47
Selecting the speaker output [Speaker].....	47
Playing the beginning of files automatically [Intro Play].....	47

Table of contents

Device menu [Device]	48
Switching the microphone/earphone jack [Select Jack]	48
Setting auto power off mode [Power Off]	48
Setting the recording standby duration [Rec Standby]	48
Setting the battery in use [Battery]	49
Setting the time/date [Time & Date]	49
Restoring the default settings [Reset Settings]	50
Formatting the internal memory [Format]	50
Checking the internal memory information [Memory Info.]	51
Confirming the voice recorder information [System Info.]	51
Dividing files [File Divide]	52
Dividing files [File Divide]	52
Changing the folder for playback [Play Folder]	54
Changing the folder for playback [Play Folder]	54
Formatting the internal memory [Format]	56
Formatting the internal memory [Format]	56

5 Use with a PC

PC operating environment	58
PC connection/disconnection	60
Connecting the voice recorder to a PC	60
Disconnecting the voice recorder from a PC	62
Loading a file to a PC	63
Usage as external memory of the PC	65
Listening to files transferred from a PC	66
To listen a transferred file	66

6 Other information

Alarm message list	68
Troubleshooting	70
Other	73
Recorder care	73
Accessories (optional)	73
Copyright and trademark information	74
Safety precautions	75
Specifications	79

Names of parts

Recorder

Names of parts

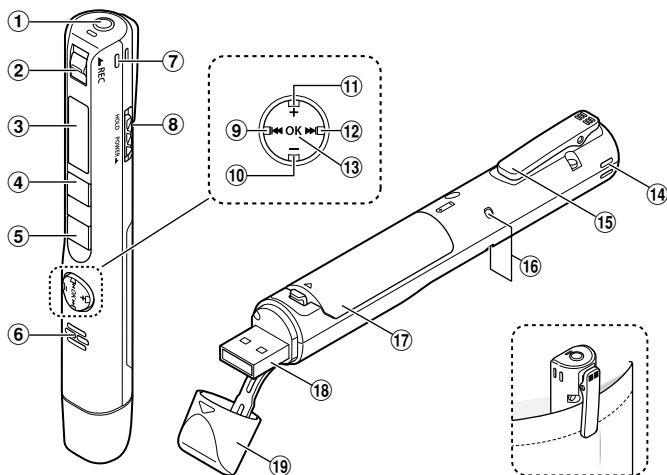

- ① Microphone/Earphone jack (🎧)
- ② **REC** (record) switch
- ③ Display
- ④ **MENU/SCENE** button
- ⑤ **▶PLAY/■STOP** button
- ⑥ Built-in speaker
- ⑦ Built-in stereo microphone (R)
- ⑧ **POWER/HOLD** switch
- ⑨ **◀◀** button
- ⑩ **-** button

- ⑪ **+** button
- ⑫ **▶▶** button
- ⑬ **OK** button
- ⑭ Built-in stereo microphone (L)
- ⑮ Clip
- ⑯ **LED** indicator light (LED)
- ⑰ Battery cover
- ⑱ **USB** connector
- ⑲ **USB** connector cover

Display

■ During recording

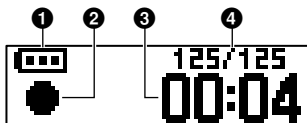

① Battery (☞ P.12)

② Voice recorder status indicator

[●]: Recording (☞ P.16)

[●]: VCVA recording stand-by (☞ P.42)

[■]: Stop

[▶]: Playback (☞ P.25)

[||]: Playback pause (☞ P.25)

[▶▶]: Fast forward (☞ P.26)

[◀◀]: Fast rewind (☞ P.26)

[▶F]: Fast playback (☞ P.30)

[▶S]: Slow playback (☞ P.30)

③ Elapsed recording time

④ Current file number in folder/Total number of recorded files in folder

■ During stop or playback



⑤ File length/Elapsed playback time

⑥ Playback range (☞ P.43)

⑦ Repeat

⑧ File lock (☞ P.39)

⑨ Playback folder (when [Music] folder is selected)

Getting started

Setup

1

After unpacking the voice recorder, follow the steps below to have it ready for use.

Setup

Step 1

Inserting the battery



Step 2

Turning the power ON



Step 3

Selecting the battery setting

Select the battery setting to match the inserted battery. Select the setting for a nickel-metal hydride rechargeable battery or the setting for an alkaline battery.



Step 4

Setting the time/date

Set the voice recorder's clock for use with file management.



Step 5

Charging the recorder

Inserting the battery

Before using the voice recorder, insert the battery in the battery compartment of the voice recorder.

- 1 Open the battery cover while pressing the cover lock knob in the direction of the arrow.**

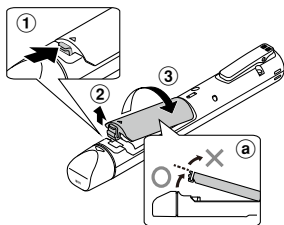

- (a) Do not attempt to open the battery cover by force.

- 2 Insert an AAA battery, making sure its positive and negative terminals are placed correctly.**

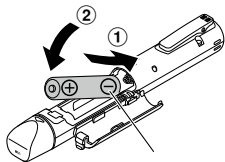

Insert the battery's negative terminal first.

- 3 Close the battery cover until it is completely closed.**

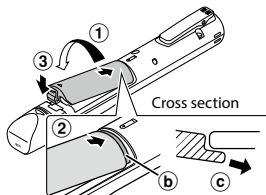

- (b) Tab
(c) When attaching the cover, slide the tab of the battery cover under the outer shell of the recorder.

NOTE

- Be sure to firmly close the battery cover (close until the battery cover lock clicks).
- Be sure to charge the battery before you start recording.

Turning the power ON

- 1 While the voice recorder is turned off, slide the **POWER/HOLD** switch in the direction of the arrow.

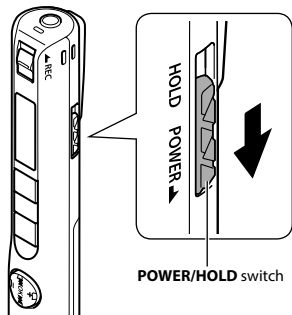

Setting the inserted battery

- 1 Press the **+** or **-** button to select the type of battery you inserted.



[Ni-MH] (Ni)

Select if you inserted an Olympus nickel-metal hydride rechargeable battery (model BR404).

[Alkaline] (Al)

Select if you inserted an alkaline battery.

- 2 Press the **OK** button to finalize the setting.

Setting the time/date

- 1 Press the **▶▶▶** or **◀◀◀** button to select the item to set.



- 2 Press the **+** or **-** button to change the number.



- To change the setting of another item, press the **▶▶▶** or **◀◀◀** button to move the blinking cursor, then press the **+** or **-** button to change the number.

- 3 Press the **OK** button to finalize the setting.

TIP

- You can change the clock display format. See “**Setting the time/date [Time & Date]**” (P.49) for the procedure.

Charging the battery by connecting to a PC's USB connector

NOTE

- Before charging the battery, insert the rechargeable battery provided and set [Battery] to [Ni-MH].

- 1 Start the PC.
- 2 Remove the USB connector cover.

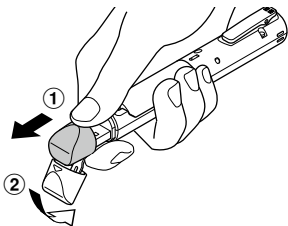

Slide open the USB connector cover using the pad of your finger.

- 3 After making sure the voice recorder is stopped, connect the USB connector to a USB port on a PC.

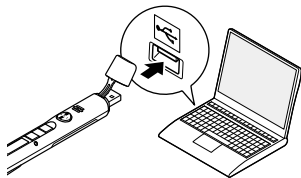

- 4 Press the OK button to start charging.



- Press the **OK** button while this message is blinking.
- The LED indicator light lights while charging.

- 5 Charging has finished when [Battery full] appears.



Charging the battery by connecting to an USB-AC adapter with a USB connection (model F-5AC)

The battery can be recharged by connecting the recorder to the provided USB-AC adapter (F-5AC).

NOTE

- Before charging the battery, insert the rechargeable battery provided and set [Battery] to [Ni-MH].

1 Remove the USB connector cover.

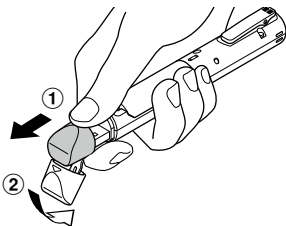

Slide open the USB connector cover using the pad of your finger.

2 Connect the voice recorder to the USB connector on the USB-AC adapter.

To USB connector of USB-AC adapter (model F-5AC)

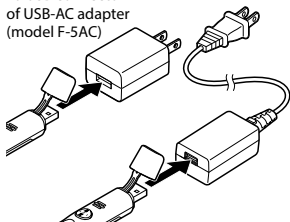

3 Connect the USB-AC adapter to an AC power outlet.

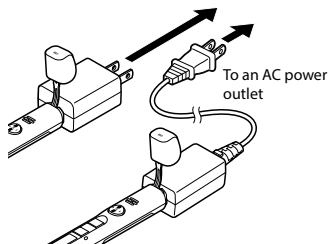

4 Press the OK button to start charging.



- Press the **OK** button while this message is blinking.
- The LED indicator light lights while charging.

5 Charging has finished when [Battery full] appears.



NOTE

- Use only the Olympus USB connecting USB-AC adapter model provided (F-5AC).

Battery indicator

As the battery loses its remaining charge, the battery indicator on the display changes as follows:







- [] indicates there is little remaining battery charge. Charge the battery. When the battery has run out, [] and **[Battery low]** appears, operation stops.

TIP

- Charging the recorder, release the HOLD mode. While the recorder is in HOLD mode, any button operations are disabled (refer P.32).
- Charging time: About 3 hours*
 - * Approximate time needed to fully charge a completely flat battery at room temperature.
 - The charging time depends on the amount of remaining power and the state of the battery.

NOTE

- Never attempt to charge an alkaline battery, lithium battery or other primary cell battery. Fluid leakage or overheating may cause the recorder to malfunction.
- The power of PC must be ON to charge the battery using the USB connector. You cannot charge the battery when the power of PC is OFF, or the PC is in standby, sleep or auto power off mode.

- Do not use a USB hub when charging the battery by connecting to the PC.
- When []¹ or []² is displayed the battery cannot be charged. Charge the battery in an ambient temperature of between 5 and 35°C (41 and 95°F).
 - *1 []: Ambient temperature is too low.
 - *2 []: Ambient temperature is too high
- If battery life has become noticeably short on a full charge, replace the battery with a new one.
- Insert the USB connector securely all the way. Operation will not be normal if the connection is not made properly.
- Use the USB extension cable provided if needed.
- Use only a compatible Olympus USB extension cable. Operation is not guaranteed if another manufacturer's cable is used. Only use the Olympus USB extension cable with the voice recorder and never use if a product from another manufacturer is used.
- Use only the Olympus USB connecting USB-AC adapter model provided (F-5AC).

Rechargeable batteries

Read the information below carefully when using a nickel-metal hydride rechargeable battery (model BR404).

■ Discharging

Rechargeable batteries discharge naturally when not in use. Be sure to charge the battery before use.

■ Operating temperature

Rechargeable batteries are chemical-based products. Their performance can vary even when used within the recommended operating temperature range. This variation is normal.

■ Recommended temperature range

When powering voice recorder: 0 to 42°C (32 to 107.6°F)

When being charged: 5 to 35°C (41 to 95°F)

During long-term storage: -20 to 30°C (-4 to 86°F)

Use of a rechargeable battery outside the temperature ranges above may result in drops in battery performance or life. When not using the voice recorder for an extended period, remove the rechargeable battery before storage to prevent fluid leakage or rust.

NOTE

- The voice recorder does not support manganese batteries.
- When replacing the battery, use an AAA alkaline dry cell battery or an Olympus nickel-metal hydride rechargeable battery (model BR404). Operation is not guaranteed. If a battery from another manufacturer is used.
- The **[Battery]** screen appears automatically after you have replaced the battery. You can also use a menu operation to display this screen and set the battery (☞ P.49). After replacing the battery, turn on the power and then make sure you set the settings on the **[Battery]** screen and **[Time & Date]** screen before recording.
- You may need to reset the time/date if the battery is removed from the voice recorder for over one minute, or if the battery is quickly removed and replaced. See "**Setting the time/date [Time & Date]**" (☞ P.49) for the procedure.
- Due to the nature of nickel-metal hydride rechargeable batteries, new batteries and batteries not used for an extended period (one month or more) may not charge completely. The battery should become fully charged after charging and discharging the battery up to three times.
- Always dispose rechargeable batteries in the legally prescribed manner. Before disposing rechargeable batteries that are not fully discharged, take steps to prevent shorting such as insulating their terminals with tape.

- Always turn power off before replacing the battery. Files may be damaged if the battery is removed while the voice recorder is recording or performing an operation such as erasing a file.
- Even if the battery indicator is , playback with the built-in speaker at some volumes may result in a drop in battery output voltage, causing the voice recorder to reset. Lower the volume in this case.
- The continuous battery usage time of a nickel-metal hydride rechargeable battery that has been used repeatedly will be reduced due to battery degradation (P.80).
- Battery life will be shorter when using a nickel-metal hydride rechargeable battery that has been used repeatedly (P.80).

For customers in Germany:

Olympus has an agreement with the GRS (Joint Battery Disposal Association) in Germany to ensure environmentally-friendly battery disposal.

Turning the power OFF

Turning the power OFF

Existing data, mode settings and the clock setting are saved when the power is turned OFF.

- 1 Slide the **POWER/HOLD** switch in the direction of the arrow for at least 0.5 seconds.

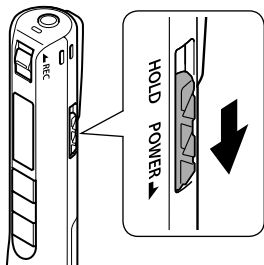

- The playback stop position at power OFF is stored in the memory.

TIP

- Turning the power OFF whenever the voice recorder is not in use minimizes battery consumption.

Auto power off mode

When the voice recorder has been stopped for at least 5 minutes (default setting) after power ON, the display disappears and the voice recorder automatically turns off (P.48).

- To reuse the voice recorder, turn the power ON again.

NOTE

- The voice recorder will not be turned off during recording, even if the **POWER/HOLD** switch operated.
- If the [**Rec Standby**] function is enabled, the voice recorder will remain in recording standby state even after the power is turned off so the battery will deplete more quickly. Once the time set for [**Rec Standby**] elapses, the power turns off completely (P.48).

Recording

Recording

Even if a recording opportunity suddenly arises, you can start recording from the power off state. Up to 999 recordings can be made.

2

Recording

Basic recording procedure

- 1 **Point the built-in microphone in the direction of the sound to record.**

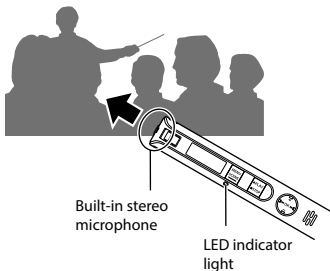

- 2 **Slide the REC switch to start recording in the direction of the arrow.**

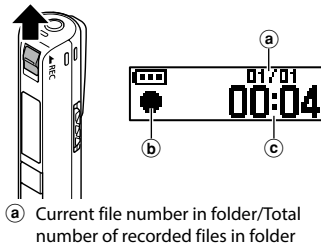

- a Current file number in folder/Total number of recorded files in folder

- b Recording indicator
- c Elapsed recording time

- The LED indicator light lights, and [●] appears in the display.
- After replacing the battery, turn on the power and then make sure you set the settings on the [Battery] screen and [Time & Date] screen before recording.
- If you record simple recording content at the beginning, it will be convenient for searching later using the [Date Search] function (P.34).

- 3 **Slide the REC switch to stop recording in the direction of the arrow.**

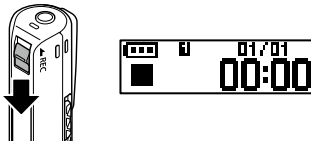

- [■] appears in the display.

TIP

- Recording is not stopped by pressing the ►PLAY/■STOP button.

Sound files recorded with the voice recorder are automatically given a file name in the format below.

VP200001 .MP3

①

②

① **File number**

File numbers are assigned consecutively.

② **Extension**

A file extension indicating the recording format the file was recorded in by the voice recorder.

- Linear PCM format: **“.WAV”**
- MP3 format: **“.MP3”**

TIP

- When recording with the voice recorder in a pocket or alike, secure it with a clip to prevent it from moving.
- Even if recording starts during playback of a file in the **[Music]** folder, the recorded file will be saved in the **[Recorder]** folder (P.54).

NOTE

- To prevent the beginning of the recording being cut off, start recording after the LED indicator light has lit or mode indicator has appeared in the display.
- When the remaining possible recording time is 60 seconds, the LED indicator light starts flashing. It flashes more rapidly as the remaining time decreases (at the 30- and 10-second points).
- When **[Folder full]** appears, no more recording can be done. You will need to delete unneeded files to record more (P.35, P.68).
- If **[Memory full]** appears, the voice recorder has no more available memory space. You will need to delete unneeded files to record more (P.35, P.68).
- Processing performance may be reduced when data has been repeatedly written to or deleted from the recording media. Please initialize the recording media in this case (P.56).

Recording linear PCM format data over 2 GB

When recording a linear PCM format file, recording will continue even after the file size exceeds 2 GB.

- The data is divided and saved in separate files of up to 2 GB. The files are processed as multiple files during playback.
- After recording 999 files which exceed 2GB recording stops.

Recording settings

For various recording conditions, different recording settings are available.

[Rec Level] (^{ESP} P.40)	Sets the recording sensitivity.
[Rec Mode] (^{ESP} P.40)	Sets the recording sound quality.
[Self Timer] (^{ESP} P.41)	Recording starts when the set time has elapsed.
[Anti-Rustle] * (^{ESP} P.41)	Reduce noise caused by the voice recorder rubbing against clothing (rustling sounds) when recording in your pocket.
[Low Cut Filter] (^{ESP} P.41)	Reduces humming sounds from equipment such as air-conditioners or projectors.
[VCVA] (^{ESP} P.41)	Sets the trigger level for voice-activated recording (VCVA).
[Rec Scene] (^{ESP} P.20)	Used to select one of multiple preregistered templates of recording settings. When selected, each template enters several settings tailored to a particular recording location or condition all in a single operation.

- * When recording with the voice recorder in a pocket or alike, secure it with a clip to prevent it from moving.

Using earphones

If you connect commercially available earphones to the microphone/earphone jack (🎧) of the voice recorder, you will be able to listen to the audio during recording and playback.

- Use the +/- button to adjust the recording monitor volume.
- Earphones are not supplied with this product.

1 Connect the earphones to the voice recorder's microphone/earphone jack (🎧).

To microphone/earphone jack



- Changing the volume will not affect the recording level.
- There will be no sound from the speaker when the earphones are connected.





NOTE

- To avoid unpleasantly loud sound, set the volume to **[00]** before plugging in the earphone.
- To prevent feedback, do not place the earphone near the microphone while recording.
- Avoid excessive volume when listening to playback through the earphones. It may cause hearing damage or loss.
- If the volume is set too loud, a warning screen may appear.
- Battery life depletes quickly while recordings are monitored. To conserve battery life, leave the earphone disconnected while recording.
- If the **[Anti-Rustle]** function (P.41) is enabled, you may sound like an echo during monitoring the recording.
- If you cannot hear sound even after connecting the earphones, set **[Select Jack]** to **[Earphone]**.

Selecting the automatic recording setting [Rec Scene]

Selecting the automatic recording setting [Rec Scene]

The voice recorder has preregistered templates of optimum settings tailored to various recording applications such as conference and dictation. When selecting one of these templates you can enter several settings recommended for your recording application all in a single operation.

[Pocket]		Suitable for recording sounds over a wide area while the voice recorder is still in your pocket.
[DNS]		For Speech Recognition Software.
[Dictation]		Suitable for recording your own voice and other sounds that are extremely close.
[Conference]		Suitable for recording conferences in a large space and other sounds over a wide area.
[Meeting]		Suitable for recording meetings held in a small space and other sounds that are fairly close.

- 1 While the voice recorder is in stop mode, press and hold the MENU/SCENE button.



- 2 Press the OK button.

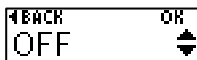

- Press the  button to return to the previous screen.

- 3 Press the + or – button to select the desired recording application.



- 4 Press the OK button to finalize the setting.



- According to the setting, the setting icon is displayed.

- 5 Press the ►PLAY/■STOP button to exit the menu screen.



- See "Preregistered [Rec Scene] settings" for more information (P.21).

Selecting the automatic recording setting [Rec Scene]

Selecting the automatic recording setting [Rec Scene]

NOTE

- When a recording scene is selected, recording-related menu settings cannot be used in combination with the recording scene. If you attempt to use any of those functions, the **[Rec Scene]** setting will be automatically set to **[OFF]**.

Preregistered [Rec Scene] settings

[Pocket]:

[Rec Level]	[High] ^{*1}
[Rec Mode]	[MP3 128k ST]
[Anti-Rustle]	[High]
[Low Cut Filter]	[OFF]

[Dictation]:

[Rec Level]	[Low] ^{*2}
[Rec Mode]	[MP3 128k ST]
[Anti-Rustle]	[OFF]
[Low Cut Filter]	[ON]

[Conference]:

[Rec Level]	[Auto]
[Rec Mode]	[MP3 128k ST]
[Anti-Rustle]	[OFF]
[Low Cut Filter]	[ON]

[Meeting]:

[Rec Level]	[High]
[Rec Mode]	[MP3 128k ST]
[Anti-Rustle]	[Low]
[Low Cut Filter]	[OFF]

[DNS]:

[Rec Level]	[Low] ^{*2}
[Rec Mode]	[MP3 128k ST]
[Anti-Rustle]	[OFF]
[Low Cut Filter]	[OFF]

^{*1} The recording sensitivity is set to a level that is even higher than **[High]**.

^{*2} The recording sensitivity is set to a level that is even lower than **[Low]**.

Recording with an External Microphone

Sound can be recorded by connecting an external microphone to the microphone/earphone jack (🎧) of the voice recorder.

2

Recording with an External Microphone

- 1 **Connect an external microphone to the microphone/earphone jack (🎧) of the voice recorder.**



To microphone/
earphone jack

- 2 **Start recording.**

- See “Recording” for about the recording procedure (☞ P.16).

TIP

- You can use a plug-in power compatible microphone.
- See “Accessories (optional)” for about usable external microphones (☞ P.73).

NOTE

- Set [**Select Jack**] to [**Microphone**] when it is set to [**Earphone**] or when the connected external microphone cannot be detected properly even if [**Auto**] is selected (☞ P.48).
- When an external monaural microphone is connected and recording is performed, sound is recorded only on the L channel if you set [**Rec Mode**] to stereo (☞ P.40).
- When an external stereo microphone is connected and recording is performed, sound from only the L channel microphone is recorded if you set [**Rec Mode**] to monaural (☞ P.40).

Recording by Connecting to an External Device

Recording sounds of an external device

Connect the audio output terminal (earphone jack) of an external device and the microphone/earphone jack (🔊) of the voice recorder using the connecting cord KA333 (sold separately) to record sounds of the connected device.

- Set **[Select Jack]** to **[Microphone]** in advance (☞ P.48).

To microphone/
earphone jack



To output terminal of
the external device

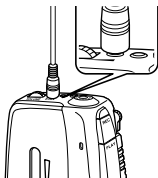

NOTE

- When connecting an external device, make a trial recording and adjust the output level of the external device.

Recording sounds of the voice recorder in an external device

Connect the audio input terminal (microphone jack) of an external device and the microphone/earphone jack (🔊) of the voice recorder using the connecting cord KA333 (sold separately) to record sounds of the voice recorder in the connected device.

- Set **[Select Jack]** to **[Earphone]** in advance (☞ P.48).

To microphone/
earphone jack

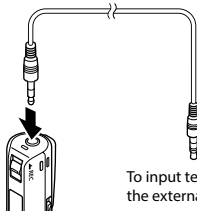

To input terminal of
the external device

NOTE

- When you adjust various playback-related sound quality settings on the voice recorder, the audio signal output from the microphone/earphone jack (🔊) also changes (☞ P.60, P.62).

Changing the information screen during recording

Changing the information screen during recording

You can change the information screen during recording.

1 While the voice recorder is in recording mode, press the **OK** button.



- Each press of the **OK** button changes the information screen.

① Elapsed recording time screen (default screen)



You can display the elapsed recording time and current file number in folder.

② Recording level meter screen

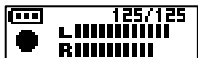

The meter changes according to recording volume and recording function setting.

③ Functions indicator screen



You can display the indicator of functions and remaining recording time.

④ Time and date screen



You can display the current time and date.

■ Meanings of indicators (same for all modes)

[Ni]: Battery type (☞ P.49)

[Ⓜ]: Select Jack (☞ P.48)

[00]: Possible recording time

[[M]]: Noise Cancel (☞ P.43)

[[V]]: Voice Balancer (☞ P.43)

[[A]]: Rec Level (☞ P.40)

[[X]]: Low Cut Filter (☞ P.41)

[[R]]: Anti-Rustle (☞ P.41)

[[R]]: Rec Mode (☞ P.40)

[[CONF]]: Rec Scene (☞ P.20)

[[P]]: Play Scene (☞ P.29)

NOTE

- The information screen return to default screen if the voice recorder will be changed to other operation (stop, playback, recording).

Playback

Playback

In addition to files recorded by the voice recorder, you can also play files in WAV, MP3 format transferred from a PC.

Basic playback procedure

- 1 Press the **▶▶|** or **|◀◀** button to select the desired playback file.

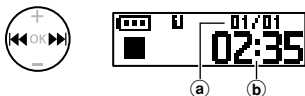

- a Current file number in folder/Total number of recorded files in folder
- b File length

TIP

- The file length display appears for 3 seconds.
- You can search for voice files by specifying a recording date (see P.34).

- 2 Press the **▶PLAY/■STOP** button to start playback.

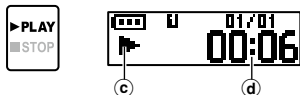

- c Playback indicator
 - d Elapsed playback time
- [▶] appears in the display.

- 3 Press the **+** or **-** button to adjust the volume to the desired level.



- The volume can be adjusted to a setting between [00] to [30]. The higher the number, the louder the volume.
- If the volume is set too loud, a warning screen may appear.

- 4 Press the **▶PLAY/■STOP** button to stop playback.

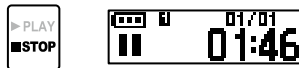

- [■] appears in the display.
- The file being played stops right away. The resume function automatically stores the playback stop position in memory. The position is retained even if the power is turned OFF. The next time the power is turned ON, playback can be resumed from the stop position stored in the memory.

Fast-forwarding

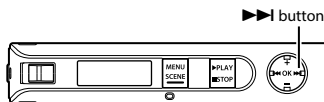

Rewinding

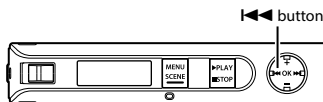

Fast-forwarding during playback

1 Press and hold the ▶▶ button during playback.

- Playback starts from the current position when you release the ▶▶ button.
- If an index mark or temp mark in the file is reached, fast-forwarding stops at the mark (☞ P.31).
- Fast-forwarding stops when the end of the file is reached. Press and hold the ▶▶ button again to fast-forward from the beginning of the next file.

Rewinding during playback

1 Press and hold the ◀◀ button during playback.

- Playback starts from the current position when you release the ◀◀ button.
- If an index mark or temp mark in the file is reached, rewinding stops at the mark (☞ P.31).
- Rewinding stops when the beginning of the file is reached. Press and hold the ◀◀ button again to rewind from the end of the previous file.

Skipping to the beginning of a file

Skipping to the beginning of the next file

- 1 Press the **▶▶|** button while the voice recorder is in stop mode, or during playback.

Skipping to the beginning of the current file

- 1 Press the **|◀◀** button while the voice recorder is in stop mode, or during playback.

Skipping to the beginning of the previous file

- 1 Press the **|◀◀** button when the playback position is the beginning of the file.
 - To skip to the beginning of the previous file during playback, press the **|◀◀** button twice consecutively.

TIP

- To skip the files continuously, pressing the **|◀◀** or **▶▶|** button while the recorder is in stop mode.

NOTE

- If an index mark or temp mark is reached when skipping to the beginning of a file during playback, playback starts from the position of the mark. When skipping to the beginning of a file while the voice recorder is in stop mode, the mark is ignored (P.31).
- If a setting other than **[File Skip]** is set for **[Skip Space]**, playback starts after the set amount of time has been skipped backwards or forwards. Playback does not skip to the beginning of the file.

Playback settings

You can select various file playback methods tailored to different applications and tastes.

[Noise Cancel]* (<small>ESP</small> P.43)	A setting that makes recorded voices more discernable when muffled by projector noise or similar sounds.
[Voice Balancer]* (<small>ESP</small> P.43)	Compensates low-volume portions of recorded audio files during playback.
[Playback Range] (<small>ESP</small> P.43)	Selects whether to play back individual files or all files in a folder.
[Repeat] (<small>ESP</small> P.44)	Repeatedly plays back the range selected in [Playback Range] .
[Skip Space] (<small>ESP</small> P.44)	A handy function for quickly moving the playback position, and playing short segments repeatedly.
[Play Scene] (<small>ESP</small> P.29)	Switches to the playback operation setting. In this setting transcription can be made while listening to recorded content.
[Play Folder] (<small>ESP</small> P.54)	Use this when you wish to switch to the [Recorder] folder or another folder in [Music] .

* This function is only available when a file in the **[Recorder]** folder is selected.

Listening with earphones

You can connect earphones to the microphone/earphone jack (🎧) of the voice recorder to listen to its sound.

- Earphones are not included.

- 1 Connect the earphones to the microphone/earphone jack of the voice recorder.**



To microphone/earphone jack

- 2 Press the ►PLAY/■STOP button to start playback.**

- When the earphones are connected, no sound is output from the speaker.

⚠ CAUTION

Avoid excessive volume when listening to playback through the earphones. It may cause hearing damage or loss.



NOTE

- To avoid irritation to ears, set the volume to **[00]** before wearing earphones.
- If the volume is set too high when using the earphones, a warning screen may be displayed.
- Set **[Select Jack]** to **[Earphone]** when you cannot hear sound even when the earphones are connected, or when playing back with an external speaker (ESP P.48).

Selecting the automatic playback operation [Play Scene]

Selecting the automatic playback operation [Play Scene]

The beginning or end of the wrong file is never selected even when you perform the forward or return operation repeatedly. You can also use the fast or slow playback function at the same time.

[Transcription] 	This is convenient for creating the minutes and written records from audio files of meetings, interviews, and other events where multiple people speak.
[Language study] 	This is convenient for playing back conversations and language study content many times repeatedly.

- 1 While the voice recorder is in stop mode, press and hold the MENU/ SCENE button.



- 2 Press the + or - button to select [Play Scene].



- 3 Press the OK button.

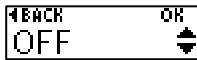

- Press the  button to return to the previous screen.

- 4 Press the + or - button to select the desired preset playback settings package.



- 5 Press the OK button to finalize the setting.



- 6 Press the  button to exit the menu screen.



- See "Preregistered [Play Scene] settings" for more information (P.38).

Changing the playback speed

Changing the playback speed

You can change the playback speed. Changing the playback speed is handy for speeding up conference presentations, or for slowing down parts difficult to discern when learning a language.

- 1 Press and hold the **▶PLAY/■STOP** button during playback.

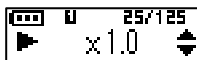

- 2 Press the **+** or **-** button to select the desired playback speed.

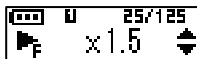

- You can set the playback speed from [x 0.5] (slow) to [x 1.0] (normal) to [x 2.0] (fast).

- 3 Press the **OK** button.



a

- a Playback speed display
- To return to the normal playback speed, set the setting to [x1.0].

NOTE

- Altered playback speed settings are retained even after power OFF.
- Changing the playback speed will make the battery deplete more quickly.
- The function below cannot be used when changing the playback speed.
 - [Noise Cancel] (P.43)

Fast playback restrictions

Depending on their sampling rate and bit rate, some files may not play normally. In this case you will need to reduce the playback speed.

Index marks/temp marks

Writing an index mark or temp mark in a file enables you to quickly access desired position in the file with the same operations used for fast-forwarding, rewinding or skipping to the start of a file.

You can write the index marks in the files created with this product. You may not be able to write the index marks in the files created with other Olympus recorders. You can write the temp marks in the files which index marks cannot be written in. For files created with a device of other than Olympus, you can write the temp marks. You can write the index marks during recording, playback, and stop.

Writing an index mark/temp mark

- 1 **At the position to add an index mark or temp mark, press and hold the OK button.**



NOTE

- Temp marks are temporary markings. They are automatically erased when you select a different file, transfer the file to a PC, or move the file on a PC.
- You can write up to 99 index marks/temp marks in a single file. The message [Index Full] or [Temp Full] appears if you attempt to write more than 99 marks.
- You cannot write or erase index marks/temp marks in files that have been locked by the file lock function (see P.39).
- Index marks may not be written in a file created on this product and played on a computer.

Erasing an index mark/temp mark

- 1 **Select a file that contains index mark/temp mark you want to erase and start playback.**
- 2 **Use the >>> or <<< button to select the index mark/temp mark you want to erase.**

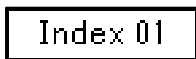

- 3 **When the number of the index mark/temp mark to erase is being shown (for about 2 seconds) in the display, press and hold the OK button.**
 - Any subsequent index marks/temp marks in the file are automatically renumbered.

Preventing accidental operation

Setting the voice recorder to HOLD mode maintains the current operation and disables button operations. HOLD mode is a handy feature for preventing unintentional operation from accidental button presses when the voice recorder is carried in a bag or pocket.

Setting HOLD mode

- 1 Slide the **POWER/HOLD** switch to the **[HOLD]** position.

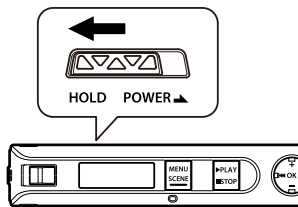

- **[Hold]** appears in the display, and the recorder enters HOLD mode.
- ON and OFF of the **REC** switch are active in the HOLD mode.

Releasing HOLD mode

- 1 Slide the **POWER/HOLD** switch to position **A** shown below.

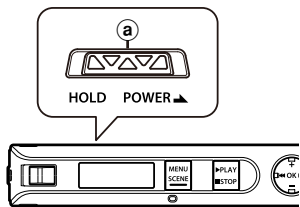

NOTE

- When any button is pressed during HOLD mode, **[Hold]** appears in the display for 2 seconds. No other operation is performed.
- Setting HOLD mode during voice recorder playback continues the playback operation and prevents any other operation from being performed (the voice recorder stops when playback ends).

Changing the information screen during playback or stop

Changing the information screen during playback or stop

You can change the information screen during playback or stop.

- 1 While the voice recorder is in playback mode or stop mode, press the **OK** button.



• Each press of the **OK** button changes the information screen.

- 1 Elapsed playback time screen (default screen)



You can display the elapsed playback time and current file number in folder.

- 2 Recording time/date screen ([Recorder] folder is selected)

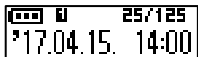

You can display the recording time and date of current file.

- File name screen ([Music] folder is selected)



You can display the name of current file.

- 3 Functions indicator screen



You can display the indicator of functions and remaining recording time (see P.24).

- 4 Time and date screen



You can display the current time and date.

NOTE

- The information screen return to default screen if the voice recorder will be changed to other operation (stop, playback, recording).

Searching for a file [Date Search]

Using the date search function

You can search for voice files by specifying a recording date.

NOTE

- Only files in the [Recorder] folder can be searched..

3

Searching for a file [Date Search]

- 1 While the voice recorder is in stop mode, press and hold the MENU/SCENE button.



- 2 Press the + or - button to select [Date Search].



- 3 Press the OK button.



- 4 Press the + or - button to select the desired recording date.

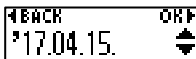

- All of the dates on which recordings were made are displayed. Select the date you are searching for from the dates.

- 5 Press the OK button.



- 6 Press the + or - button to select the desired file.

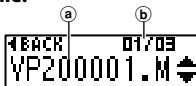

- a File name
- b File number/Number of files registered for the selected date

TIP

- Each time you select a file, the voice recorder can automatically play the beginning of the file for 10 seconds (☞ P.47).
- To prevent the voice recorder from playing back automatically, set [Intro Play] to [OFF] (☞ P.47).

- 7 Press the OK button to start playback.



NOTE

- To perform a date search, you need to set [Time & Date] in advance (☞ P.49).

Erasing files

Erasing files

This section describes how to erase a single unneeded file from a folder, erase all the files in the current folder at once.

- 1 Press the **▶▶** or **◀◀** button to select the file you want to erase.**



The file of this number is erased. After it is erased, renumbering is performed automatically.

- 2 While the voice recorder is in stop mode, press the **MENU/SCENE** button.**

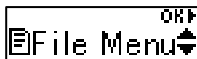

- 3 Press the **OK** button.**



- The voice recorder returns to the stopped mode if no operation is performed for 3 minutes.

- 4 Press the **OK** button again.**



- 5 Press the **+** or **-** button to select **[One file]** or **[All in folder]**.**



[One file]:

Erases only the selected file.

[All in folder]:

Erases all the files saved in the same folder as the selected file.

- 6 Press the **OK** button.**



- If no operation is performed for 8 seconds during menu operation, the previous screen is redisplayed.

- 7 Press the **+** button to select **[Start]**.**



- 8 Press the **OK** button.**



- **[Erasing]** appears in the display, and the erasing process starts. **[Erased]** appears when the process has finished.

NOTE

- Stop recording or playback before erasing.
- Files cannot be restored after being erased, so please check carefully before erasing a file.
- Locked files and read-only files cannot be erased (P.39).
- If there is a file that cannot be recognized by the recorder, the file will not be erased. The voice recorder must be connected to a PC to erase these files.
- Before erasing a file, charge or replace the battery to ensure it will not run out before the process has finished. Erasing processes can take over 10 seconds to complete. To prevent the risk of damage to data, never remove the battery before an erasing process has finished.

Menu

Setting menu items

Basic operation

The menus consist of the following five setting menus: **[File Menu]**, **[Rec Menu]**, **[Play Menu]**, **[LCD/Sound]**, and **[Device]**, which each provide useful functions to meet a variety of needs. Follow the steps below to set a menu item.

- 1 Press the MENU/SCENE button during recording, playback or stop.**



TIP

- Some menus contain items that can be set during recording/playback (see P.38).

- 2 Press the + or – button to select the setting menu containing item you want to set.**



- 3 Press the OK button.**



- The setting item of the selected setting menu is displayed.
- You can also use the ►►► button to perform this operation.

- Press the ◀◀◀ button to return to the previous screen.

- 4 Press the + or – button to select the desired setting item.**

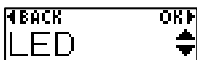

- 5 Press the OK button.**



- 6 Press the + or – button to change the setting.**



- 7 Press the OK button to finalize the setting.**



- A message indicating the setting has been entered appears.

Setting menu items

Basic operation

- 8 Press the **▶PLAY/■STOP** button to exit the menu screen.



- When you enter the menu screen during recording or playback, press the **MENU/SCENE** button to return to the previous screen without interrupting recording or playback.

NOTE

- For menu settings done while the voice recorder is in stop mode, the voice recorder exits the menu and returns to the stopped mode if no operation is performed for 3 minutes. The selected setting item is not changed in this case.
- For menu settings done during recording/playback, the voice recorder exits the menu if no operation is performed for 8 seconds.

- **Menu items that can be set during recording;**

- Backlight
- LED

- **Menu items that can be set during playback;**

- Property
- Backlight
- LED

Preregistered [Play Scene] settings

[Transcription]:

[STOP (■)]	[Auto Back (3 sec)]*
[▶▶I (CUE)]	[x2.0 Play Back]
[I◀◀ (REV)]	[Reviewing]
[▶▶I (SKIP)]	[10 sec. Skip]
[I◀◀ (SKIP)]	[3 sec. Skip]
[Voice Balancer]	[ON]

[Language study]:

[STOP (■)]	[Stop]
[▶▶I (CUE)]	[x2.0 Play Back]
[I◀◀ (REV)]	[Reviewing]
[▶▶I (SKIP)]	[10 sec. Skip]
[I◀◀ (SKIP)]	[3 sec. Skip]
[Voice Balancer]	[OFF]

- * If you press the **▶PLAY/■STOP** button during playback, the audio is rewound 3 seconds from the position at which the button was pressed and then stopped.

File menu [File Menu]

Preventing accidental file erasure [File Lock]

The file lock feature lets you lock important files to prevent them being accidentally erased. Once locked, a file is not erased even if the operation for erasing all the files in its folder is performed (☞ P.35).

1 Select the file you want to lock (☞ P.25).

[ON]:

Locks the file.

[OFF]:

File lock is canceled.

Dividing files [File Divide]

Large files or files with long recording times can be divided for easier management and editing.

See “Dividing files [File Divide]” (☞ P.52) for the procedure.

Displaying file information [Property]

You can display the information of a file from a menu screen.

File information

1 Press the + or – button to switch the screen.

- [Name] [Date] [Size] [Bit Rate]*1
[Artist]*2 [Album]*2 are displayed.

*1 When a linear PCM format file is selected, the sampling rate and bit count are displayed in the [Bit Rate] field.

*2 If there is no tag information in the file, [UNKNOWN_ARTIST] and [UNKNOWN_ALBUM] are displayed.

Recording menu [Rec Menu]

Selecting the recording sensitivity [Rec Level]

You can change the recording level (sensitivity) as needed for your recording application.

[Auto]:

The recording sensitivity changes automatically following the input volume. This is suitable for recording general audio.

[High]:

The highest recording sensitivity. Suited to recording lectures, large conferences and other applications with distant or quiet sound sources.

[Low]:

The lowest sensitivity, this level is suitable for dictation.

TIP

- When you wish to record a speaking voice clearly, set [Rec Level] to [Low], and place the voice recorder's built-in microphone near the speaker's mouth (5 to 10 cm away).

NOTE

- The recording level is adjusted automatically. Excessively loud sound input may generate noise.

Setting the recording mode [Rec Mode]

You can prioritize sound quality or recording time. Select the recording mode that best matches your recording application.

[PCM]

[MP3 128k ST]

[MP3 32k Mono]*

[MP3 8k Mono]*

* Mono recording

TIP

- PCM format allows you to faithfully record the original sound because compression and other processing is not performed, but the file size will be large. Check that you have enough remaining memory before recording.
- To record conferences and presentations clearly, it is recommended to set [Rec Mode] setting to [MP3 128k ST].

Reducing noise caused by rubbing during recording [Anti-Rustle]

Reduce noise caused by the voice recorder rubbing against clothing (rustling sounds) when recording in your pocket.

NOTE

- When recording with the voice recorder in a pocket or alike, secure it with a clip to prevent it from moving.

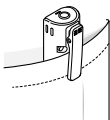

[High] [Low]:

Reduces noise caused by rubbing sounds (rustling sounds) during recording.

[OFF]:

Turns the rustling sound reduction function off.

Start recording after the set time has elapsed [Self-timer]

Self-timer function starts recording after the set time has elapsed. By setting the time until recording starts in advance, you can prevent forgetting to record.

[3 min.][5 min.][10 min.]:

Sets the time until recording starts.

[OFF]:

Turn off the self-timer.

Reducing noise during recording [Low Cut Filter]

The voice recorder's low cut filter function lets you make recordings that reduce humming sounds from air-conditioners or low-frequency sounds from equipment such as projectors.

[ON]:

Turns the low cut filter ON.

[OFF]:

The low cut filter is disabled.

Voice-activated recording function [VCVA]

The voice-activated recording function (VCVA) automatically starts recording when a sound louder than a preset voice activation level is detected, and automatically pauses recording when the sound volume level falls. Use this function to automatically omit unneeded quiet segments when recording (such as long silences during conferences), saving memory.

[ON]:

Turns VCVA ON. You can adjust the voice activation level used for VCVA.

[OFF]:

Turns VCVA OFF. Restores standard recording.

Adjusting the voice activation level for voice-activated recording

1 Slide the REC switch to start recording.

- Recording pauses automatically about 1 second after the input sound becomes quieter than the set activation sensitivity.

The LED indicator light becomes lit when recording is activated and flashes when recording is paused.

2 Press the ►► or ◀◀ button to adjust the voice activation level.

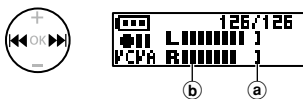

- a Voice activation level (moves left/right to match set level)
 - b Level meter (changes in proportion to recording sound volume)
- The setting can be adjusted in 23 steps.

TIP

- Each press of the ◀◀ button increases the activation sensitivity level of VCVA, and a high level will result in recording starting even with small sounds.
- Adjust the VCVA voice activation level to suit the recording conditions (to cope with high levels of surrounding noise or alike).
- To avoid recording mistake, it's recommended to perform a test recording beforehand to adjust the voice activation level.

Playback menu [Play Menu]

Reducing noise during playback [Noise Cancel]

Use the **[Noise Cancel]** function to reduce noise when a recorded voice is difficult to discern.

[High] [Low]:
Reduces surrounding noise to play back clearer sound quality.

[OFF]: The noise cancel function is disabled.

NOTE

- **[Noise Cancel]** function is only available when a file in the **[Recorder]** folder is selected.
- If the **[Noise Cancel]** function is used, the battery will deplete more quickly.
- The following function will not be available while you are using the **[Noise Cancel]** function.
 - Changing the playback speed (P.30)

Adjusting low volume portions during playback [Voice Balancer]

The **[Voice Balancer]** function adjusts low-volume portions of recorded audio files to make them louder.

[ON]:
Adjusts low-volume portions of audio files during playback, making them louder.

[OFF]:
The voice balancer function is disabled.

NOTE

- **[Voice Balancer]** function is only available when a file in the **[Recorder]** folder is selected.
- Using the **[Voice Balancer]** function will drain the battery faster.

Specifying the range to play back [Playback Range]

Select the playback range according to your preference.

1 Press the + or – button to select [Recorder] or [Music].

[Recorder]:
Set the playback range for playing files recorded with the built-in microphone.

[Music]:
Set the playback range for playing files transferred from a PC.

2 Press the + or – button to select the setting.

[File]:
Stops playback after the current file has been played.

[Folder]:
Plays all the files in the current folder consecutively, stopping playback after the last file in the folder is played.

NOTE

- When you set **[Playback range]** to **[File]**, **[End]** blinks in the display for 2 seconds after the last file in the folder has been played, then playback stops at the start position of the last file.
- While **[Playback range]** is set to **[Folder]**, **[End]** blinks in the display for 2 seconds after the last file in the folder has been played, then playback stops at the start position of the first file in the folder.

Setting the repeat playback [Repeat]

You can select ON or OFF for repeat playback.

1 Press the + or – button to select [Recorder] or [Music].**[Recorder]:**

Set repeat playback for playing files recorded with the built-in microphone.

[Music]:

Set repeat playback for playing music files transferred from a PC.

2 Press the + or – button to select the setting.**[ON]:**

Repeatedly plays back the range selected in **[Playback Range]**.

[OFF]:

Cancels repeat playback.

Setting a skip space [Skip Space]

This function skips (forward) or reverse skips (rewinds) the file being played back for a set amount of time and it is a convenient way to move the playback position or repeat playing a short phrase.

1 Press the + or – button to select [Forward Skip] or [Reverse Skip].**[Forward Skip]:**

Starts playback after moving the playback position forward by the set amount.

[Reverse Skip]:

Rewinds the set amount of time and starts playback.

2 Press the + or – button to select the setting.**When [Forward Skip] was selected:**

[File Skip], **[30 sec. Skip]**, **[5 min. Skip]**

When [Reverse Skip] was selected:

[File Skip], **[3 sec. Skip]**, **[30 sec. Skip]**,
[5 min. Skip]

NOTE

- Forward/reverse skip operations over a skip space that contains an index mark/temp mark or the starting position of a file will stop at that mark or at the start position.

Forward/reverse skip playback

- 1 Press the ►PLAY/■STOP button to start playback.**
- 2 Press the ►►| or |◄◄ button during playback.**
 - Playback starts after skipping forward or backward by the set amount.

Changing the folder for playback [Play Folder]

You can switch the play folder to the **[Recorder]** folder containing the files recorded with the built-in microphone or the **[Music]** folder containing music files and study content transferred from a PC. See “**Changing the folder for playback [Play Folder]**” (P.54) for the procedure.

LCD/Sound menu [LCD/Sound]

Setting the backlight [Backlight]

The display backlights are switched on for a preset amount of time when a button operation is performed.

[5 sec.] [10 sec.] [30 sec.] [1 min.]:

Set the amount of time that the backlight stays lit.

[OFF]:

Disables the backlight.

Adjusting the contrast [Contrast]

You can adjust the contrast of the display to 12 different levels.

- The setting can be adjusted to between [01] to [12].

Setting the LED indicator light [LED]

You can set the unit so that the LED indicator light does not light. The LED indicator light is lit or flashing during recording and charging and while files are being transferred between the voice recorder and a PC.

[ON]:

LED indicator light is switched on.

[OFF]:

The LED indicator does not light.

- Even if you set the [LED] setting to [OFF], the LED indicator light will flash while files are being transferred between the voice recorder and a PC.

Turning beeping sound ON/OFF [Beep]

The voice recorder makes beeping sounds when buttons are pressed, or to warn in case of operation errors. You can select whether the voice recorder makes these beeping sounds.

[ON]:

Enables beeping sounds.

[OFF]:

Disables beeping sounds.

Switching the display language [Language]

You can select the display language of the voice recorder.

[English]
[繁體中文]

Selecting the speaker output [Speaker]

You can set the built-in speaker to be ON or OFF when the earphones are not connected.

[ON]:
When the earphone is connected, sound is output from the earphone and when the earphone is disconnected, sound is output from the built-in speaker.

[OFF]:
Sound is not output from the built-in speaker even though the earphone is disconnected.

Playing the beginning of files automatically [Intro Play]

Each time you select a file, the voice recorder can automatically play the beginning of the file for 10 seconds. This function is convenient for searching for a file because it allows you to check the content of files.

[ON]:
Each time you select a file, the beginning of that file is played for 10 seconds.

[OFF]:
Turns [Intro Play] off.

Device menu [Device]

Switching the microphone/ earphone jack [Select Jack]

This jack is used for both microphone and earphones. When **[Auto]** is selected, the connected device is automatically detected.

[Auto]:

Automatically detects whether the connected plug is from an external microphone or from earphones.

[Microphone]:

Recognizes the connected device as a microphone.

[Earphone]:

Recognizes the connected device as earphones.

NOTE

- When a device is connected to the microphone/earphone jack, detection information is displayed.

Setting auto power off mode [Power Off]

The voice recorder turns OFF automatically when a preset amount of time has elapsed while the voice recorder is in stop mode after power ON.

[5 min.] [10 min.] [15 min.] [30 min.]:

Select the desired amount of time.

[OFF]:

Disables auto power off mode. Note that leaving the voice recorder On will quickly deplete the battery.

NOTE

- If the **[Rec Standby]** function is enabled, the voice recorder will remain in recording standby state even after the power is turned off so the battery will deplete more quickly. Once the time set for **[Rec Standby]** elapses, the power turns off completely.

Setting the recording standby duration [Rec Standby]

Set the recording standby duration for after the power is turned off. This allows you to start recording immediately from the power off state during the set duration.

[1 hr.] [3 hr.] [5 hr.] [10 hr.]:

Select the desired amount of time.

[OFF]:

Turns recording standby off.

NOTE

- If the **[Rec Standby]** function is enabled, the voice recorder will remain in recording standby state even after the power is turned off so the battery will deplete more quickly. Once the time set for **[Rec Standby]** elapses, the power turns off completely.

Setting the battery in use [Battery]

Set the battery type to match the battery you are using.

[Ni-MH]:

Select this setting when using an Olympus Ni-MH rechargeable battery (model BR404).

[Alkaline]:

Select this setting when using an alkaline dry cell battery.

Setting the time/date [Time & Date]

Set the time and date beforehand to enable easier management of recorded files.

- 1 Press the **▶▶▶** or **◀◀◀** button to select the desired setting item.



- 2 Press the **+** or **-** button to change the number.



- To change another item, use the **▶▶▶** or **◀◀◀** button to move flashing position and use the **+** or **-** button to change the number.

- 3 Press the **OK** button to finalize the setting.

TIP

- When setting the month and day, each time the **MENU/SCENE** button is pressed, the display order changes.

Example: March 24, 2020

3M 24D 2020Y
(default format)



24D 3M 2020Y

- When setting the year, the **MENU/SCENE** button is pressed, the display order changes.

Example: March 24, 2020

3M 24D 2020Y
(default format)



2020Y 3M 24D

NOTE

- Even if the voice recorder is not used for a long period of time, when the battery is used up, the time and date must be re-entered.

Restoring the default settings [Reset Settings]

This setting is used to return various functions to the factory default settings (factory default). The clock setting and file numbers are retained.

1 Press the + button to select [Start].

Rec Menu:

Rec Level: Auto
Rec Mode: MP3 128k ST
Anti-Rustle: OFF
Self Timer: OFF
Low Cut Filter: OFF
VCVA: OFF
Rec Scene: OFF

Play Menu:

Noise Cancel: OFF
Voice Balancer: OFF
Playback Range:
 Recorder: File
 Music: Folder
Repeat:
 Recorder: OFF
 Music: OFF
Skip Space:
 Forward Skip: File Skip
 Reverse Skip: File Skip
Play Scene: OFF
Playback Folder: Recorder

LCD/Sound:

Backlight: 10 sec.
Contrast: Level 06
LED: ON
Beep: ON
Language: English
Speaker: ON
Intro Play: ON

Device:

Select Jack: Auto
Power Off: 5 min.
Rec Standby: OFF
Battery: Ni-MH

Formatting the internal memory [Format]

Formatting the internal memory erases all existing files saved on it. Be sure to transfer all important files to a PC before formatting. See "**Formatting the internal memory [Format]**" (P.56) for the procedure.

Checking the internal memory information [Memory Info.]

You can display the capacity and remaining memory space of the internal memory from a menu screen.

NOTE

- Some memory capacity is used as a management area, so the actual usable capacity will always be slightly less than the displayed capacity.

Confirming the voice recorder information [System Info.]

You can display voice recorder information from a menu screen.

- Displays system information about the voice recorder, such as [Model], [Version], and [Serial No.].

Dividing files [File Divide]

Dividing files [File Divide]

Large files or files with long recording times can be divided for easier management and editing.

NOTE

- Only MP3-format and PCM-format files recorded on the voice recorder can be divided.

4

Dividing files [File Divide]

- 1 Play the file to divide, and stop playback at the desired division point.**
 - Press and hold the **▶▶** or **◀◀** button to fast-forward/rewind.
 - Writing an index mark at the division point beforehand is handy.
- 2 While the voice recorder is in stop mode, press the MENU/SCENE button.**
- 3 Press the OK button.**
- 4 Press the + or – button to select [File Divide].**
- 5 Press the OK button.**

- 6 Press the + button to select [Start].**



- 7 Press the OK button.**

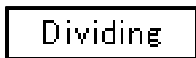

- **[Dividing]** appears in the display, and the file dividing process starts. **[Completed]** appears when the process has finished.

- 8 Press the ▶PLAY/■STOP button to exit the menu screen.**

Dividing files [File Divide]

Dividing files [File Divide]

TIP

- The file names after division become “**File name_1**” for the first half and “**File name_2**” for the latter half.

NOTE

- Files cannot be divided if there are 999 files in the folder.
- Locked files (☞ P.39) cannot be divided.
- It may not be possible to divide some MP3 or PCM files with extremely short recording times.
- To prevent the risk of data damage, never attempt to remove the battery during dividing a file.

Changing the folder for playback [Play Folder]

Changing the folder for playback [Play Folder]

You can switch the play folder to the **[Recorder]** folder containing the files recorded with the built-in microphone or the **[Music]** folder containing music files and study content transferred from a PC. The voice recorder can recognize folders up to the second level (C) in the figure in the **[Music]** folder.

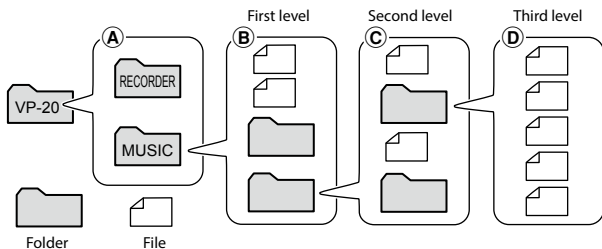

- 1 While the voice recorder is in stop mode, press the MENU/SCENE button.
- 2 Press the + or – button to select [Play Menu].
- 3 Press the OK button.
- 4 Press the + or – button to select [Play Folder].
- 5 Press the OK button.
- 6 Press the + or – button to select [Recorder] or [Music] (Fig. A).

[Recorder]:

Select this for playing files recorded with the built-in microphone.

[Music]:

Select this for playing files transferred from a PC.

- Press the ◀◀ button to return to the previous screen.

When [Recorder] was selected

◀◀ Go to Step 13

When [Music] was selected

◀◀ Go to Step 7

- 7 Press the OK button.

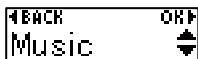

Changing the folder for playback [Play Folder]

Changing the folder for playback [Play Folder]

- 8 Press the + or – button to select the file or sub folder (Fig. B).**

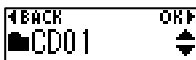

When the sub folder was selected



When the file was selected

- Press the ◀◀ button to return to the previous screen.

When the file was selected

☞ Go to Step 13

When the sub folder was selected

☞ Go to Step 9

- 9 Press the OK button.**

- 10 Press the + or – button to select the file or sub folder (Fig. C).**

When the file was selected

☞ Go to Step 13

When the sub folder was selected

☞ Go to Step 11

- 11 Press the OK button.**

- 12 Press the + or – button to select the file (Fig. D).**

- The voice recorder cannot recognize any folders at the third level (D) in the figure) in the [Music] folder.

- 13 Press the OK button to finalize the setting.**

Formatting the internal memory [Format]

Formatting the internal memory [Format]

Formatting the internal memory erases all existing files saved on it.

1 While the voice recorder is in stop mode, press the **MENU/SCENE** button.

2 Press the **+** or **-** button to select **[Device]**.

3 Press the **OK** button.

4 Press the **+** or **-** button to select **[Format]**.

5 Press the **OK** button.

6 Press the **+** button to select **[Start]**.



7 Press the **OK** button.

8 Press the **+** button again to select **[Start]**.

9 Press the **OK** button.

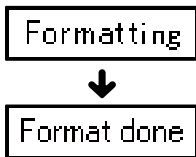

- **[Formatting]** is displayed when formatting starts.
- When **[Format done]** is displayed, formatting is completed.

TIP

- Perform **[Reset Settings]** to return various functions to the factory default (P.50).

Formatting the internal memory [Format]

Formatting the internal memory [Format]

NOTE

- Never format the voice recorder from a PC.
- Formatting erases all the existing data, including locked files and read-only files.
- Before formatting, charge or replace the battery to ensure it will not run out before the process is finished. The formatting process can sometimes take over 10 seconds to complete. To prevent the risk of damage to data, never remove the battery before a formatting process has finished: Doing so may damage the data.
- Even when formatting or erasing (Ⓜ P.35) is performed, only the file management information of the internal memory is updated and the recorded data is not completely erased. Before giving the voice recorder to somebody or disposing of it, perform initialization and then record silence until there is no recording time remaining in order to prevent the leakage of personal information.

Use with a PC

When connecting the voice recorder to a PC you can do the following:

- You can enjoy language content or music files in MP3 and WAV format stored on your PC (☞ P.66).
- Use the voice recorder as external storage to save or load data to/from your PC (☞ P.65).

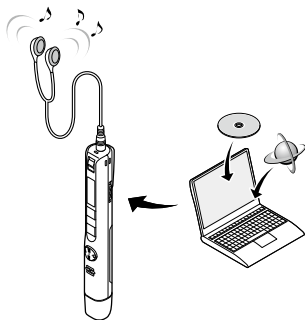

Earphones are not supplied with this product.

5

PC operating environment

PC operating environment

Windows

Operating system:

Microsoft Windows 8.1 / Windows 10
standard installation

PC:

Windows PC with at least one available
USB port

Macintosh

Operating system:

OS X v10.10 - v10.11, macOS v10.12 - v10.14
standard installation

PC:

Apple Macintosh series PC with at least
one available USB port

NOTE

- The requirements shown are the operating environments needed for using a USB connection to save files recorded by the voice recorder on a PC.
- Even when the requirements for the operating environment are satisfying, updated versions, multi-boot environments, self-modified PCs and other compatible machines will not be covered under the operational warranty.

EN

PC connection precautions

- When uploading or downloading a file to or from the voice recorder, data transfer will continue as long as the voice recorder's LED indicator light is flashing, even if the PC data communication screen disappears. Never disconnect the USB connector before data communication has finished. Always use the procedure on [P.62](#) to disconnect the USB connector. Data may not be transferred correctly if you disconnect the connector before the drive has stopped.
- Do not format (initialize) the voice recorder's drive from a PC. Formatting done from a PC will not be done correctly. To perform formatting, use the **[Format]** menu of the voice recorder ([P.56](#)).
- Voice recorder folders or files that are moved or renamed in a Windows or Macintosh file management screen may be reordered or become unrecognizable.
- Note that it will still be possible to read and write data on the voice recorder after setting the attribute of the voice recorder's drive to 'Read only' on a PC.
- To prevent nearby electronic devices being affected by noise, disconnect the earphones when connecting the voice recorder to a PC.

PC connection/disconnection

Connecting the voice recorder to a PC

- 1 Start the PC.
- 2 Remove the USB connector cover.

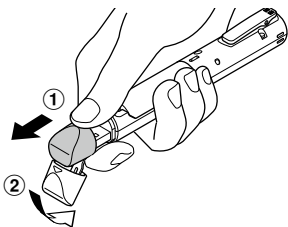

Slide open the USB connector cover using the pad of your finger

- 3 After making sure the voice recorder is stopped, connect the USB connector to a USB port on a PC.

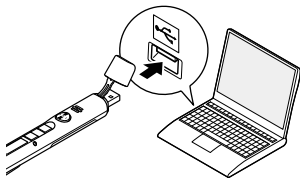

When you use an Olympus nickel-metal hydride rechargeable battery:

- To charge the battery, press the **OK** button.
- To cancel the battery charging, press the any button other than **OK**.

- While connected to USB, **[Remote]** is displayed on the voice recorder.
- You can transfer files to the PC while charging the recorder.

TIP

- Windows: The voice recorder is recognized and displayed in the **[Computer]** folder with the model name as the drive name.
- Macintosh: The voice recorder is recognized and displayed on the desktop with the model name as the drive name.
- For information on the PC's USB port, see the PC's user manual.
- Use the USB extension cable provided if needed.

Connecting the voice recorder to a PC

NOTE

- Insert the USB connector securely all the way. Operation will not be normal if the connection is not made properly.
- Connecting the voice recorder through a USB hub may result in unstable operation. Do not use a USB hub if operation is unstable.
- Use only a compatible Olympus USB extension cable. Operation is not guaranteed if another manufacturer's cable is used. Also, never use this dedicated cable with any other company's products.

Disconnecting the voice recorder from a PC

Windows

- 1 Click [⏏] on the task bar in the lower right hand corner of the screen and click [Eject DIGITAL VOICE RECORDER].



- The letter used to identify the drive will vary according to your PC.
- When the window indicating it is safe to remove hardware appears, close the window.

- 2 Check that the LED indicator light of the voice recorder has stopped blinking and then disconnect the USB cable.

Macintosh

- 1 Drag-and-drop the removable disk icon for the voice recorder shown on the desktop to the trash can icon.



- 2 Check that the LED indicator light of the voice recorder has stopped blinking and then disconnect the USB cable.

TIP

- You can disconnect the USB cable and use the voice recorder before the battery is fully charged.

NOTE

- To prevent the risk of data damage, never disconnect the voice recorder from the USB port while the LED indicator light is flashing.

Loading a file to a PC

Files recorded with the built-in microphone are saved in a folder named **[RECORDER]** on the PC. You can copy voice recorder files to any folder on the PC.

■ Voice recorder drive name and folder names on the PC

Copying files recorded with the built-in microphone to a PC

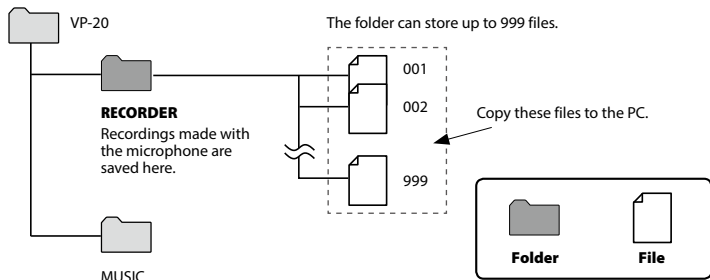

Transferring music files and study content

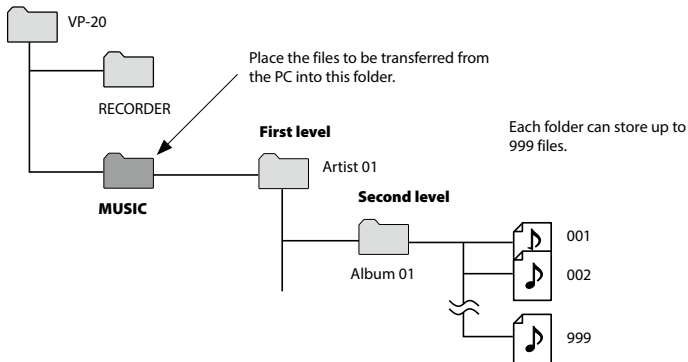

Loading a file to a PC

TIP

- Up to 130 folders can be created within the **[Music]** folder (including a **[Music]** folder itself).
- The voice recorder can only recognize two folder sublevels.

NOTE

- To prevent the risk of data damage, never disconnect the voice recorder from the USB port while the LED indicator light is flashing.

Usage as external memory of the PC

Connecting the voice recorder to a PC lets you transfer voice recorder data to save in the PC, and vice-versa.

Windows

- 1 **Connect the voice recorder to the PC** (P.60).
- 2 **Open Windows Explorer.**
 - When you open **[Computer]**, the voice recorder is recognized by the drive letter that includes the product name.
- 3 **Click on the folder labeled with your voice recorder's model name.**
- 4 **Copy the desired data to the PC.**
- 5 **Disconnect the voice recorder from the PC** (P.62).

Macintosh

- 1 **Connect the voice recorder to the PC** (P.60).
 - When connected to a Mac OS, the voice recorder is recognized on the desktop by the drive letter that includes the product name.
- 2 **Double-click the removable disk icon labeled with your voice recorder's model name.**
- 3 **Copy the desired data to the PC.**
- 4 **Disconnect the voice recorder from the PC** (P.62).

NOTE

- During data communication, **[Busy]** appears in the voice recorder's display and the LED indicator light flashes. To prevent the risk of data damage, never disconnect the voice recorder from the USB port while the LED indicator light is flashing.

Listening to files transferred from a PC

To listen a transferred file

You can listen to music files, study content, etc. transferred from a PC.

NOTE

- Connect the voice recorder to a PC and transfer the music files and study content to the [Music] folder of the voice recorder beforehand (☞ P.63).
- The voice recorder cannot recognize any folders at the third level in the [Music] folder.

5

Listening to files transferred from a PC

1 Select the desired file to playback.



- Use the [Play Folder] menu function to switch to the [Music] folder and then select the file (☞ P.54).

2 Press the ►PLAY/■STOP button to start playback.



3 Press the + or – button to adjust the volume to the desired level.

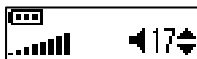

- If the volume is set too loud, a warning screen may appear.

4 Press the ►PLAY/■STOP button to stop playback.



Listening to files transferred from a PC

To listen a transferred file

Playable files

The sampling rate, bit count and bit rate combinations supported for file playback are shown below.

File format	Sampling rate	Bit count/bit rate
WAV format	22.05 kHz, 44.1 kHz	16 bits
MP3 format	MPEG 1 Layer 3: 32 kHz, 44.1 kHz, 48 kHz MPEG 2 Layer 3: 16 kHz, 22.05 kHz, 24 kHz	8 to 320 kbps



- MP3 files with variable bit rates (bit rates converted variably in a single file) may not play normally.
- Linear PCM-format WAV files are the only WAV files the voice recorder can play. Playback of other WAV files is not supported.
- Even if the file formats is compatible for playback on this recorder, the recorder does not support every encoder.

Other information

Alarm message list

Message	Meaning	Action required
Battery Low	The remaining battery power is low.	Replace or charge the battery (☞ P.7, P.10).
File Locked	The file is locked.	You must unlock the file before you can erase it (☞ P.39).
Index Full	The maximum number of index marks (99) have been written in the file.	Erase unneeded index marks (☞ P.31).
Temp Full	The maximum number of temp marks (99) have been written in the file.	Erase unneeded temp marks (☞ P.31).
Folder Full	The maximum number of files (999) have been saved in the folder.	Erase unneeded files (☞ P.35).
Mem. Error	An internal memory error occurred.	Contact the Olympus Customer Support Center (☞ back cover).
Memory Full	There is no remaining memory.	Erase unneeded files (☞ P.35).
No File	There are no files in the folder.	Record a new file, or select another folder (☞ P.16, P.55).
	No file has been selected.	You must select a file before you can perform the operation (☞ P.25, P.66).
Format Err	A formatting problem occurred.	Format the memory again (☞ P.56).
Sysfile Err	The voice recorder is unable to create a management file due to low remaining memory.	Connect the voice recorder to a PC and erase unneeded files.
Cannot Play	The file's format is not supported.	Select a file that can be played by the voice recorder (☞ P.67).
File Error	An attempt was made to divide a file that is not an MP3- or WAV-format file recorded by the voice recorder.	Select another file.

Alarm message list

Message	Meaning	Action required
Pos Error	An attempt was made to divide a file at a position where dividing is not possible.	It may not be possible to divide some MP3 or PCM files with extremely short recording times (☞ P.52).
Noise Off	[Noise Cancel] function is enabled.	[Noise Cancel] function turns off automatically (☞ P.43).
Scene Off	[Rec Scene] or [Play Scene] function is enabled.	[Rec Scene] or [Play Scene] function turns off automatically (☞ P.20, P.29).
x 1.0 Play	The playback speed function is set to other than [x1.0].	The playback speed function returns to [x1.0] automatically (☞ P.30).
Power Error	A bus power error occurred.	Cancel the USB connection (☞ P.62).
can't charge 	An attempt was made to charge an AAA alkaline battery or a rechargeable battery other than one specified.	Use an Olympus nickel-metal hydride rechargeable battery (BR404).
can't charge_2 	A bus power error occurred.	Cancel the USB connection (☞ P.62).

Troubleshooting

Problem	Possible cause	Solution
The display is blank.	The battery is not inserted properly.	Check that the positive and negative terminals of the battery are placed correctly (☞ P.7).
	The remaining battery power is low.	Replace or charge the battery (☞ P.7, P.10).
	The power is OFF.	Turn the power ON (☞ P.8).
Unable to operate the voice recorder.	The remaining battery power is low.	Replace or charge the battery (☞ P.7, P.10).
	The power is OFF.	Turn the power ON (☞ P.8).
	The voice recorder is in HOLD mode.	Release HOLD mode (☞ P.32).
Unable to record.	There is no remaining memory.	Erase unneeded files (☞ P.35).
	The maximum number of recordable files has been reached.	Erase unneeded files (☞ P.35).
Unable to record with an external microphone	The microphone connected to the microphone/earphone jack is not detected properly.	Set [Select Jack] to [Microphone] (☞ P.48).
	[Select Jack] is set to [Earphone] .	
Playback is inaudible.	The earphones are connected to the earphone jack.	To output the playback through the built-in speaker, disconnect the earphones.
	[OFF] has been selected for [Speaker] .	To output the playback through the built-in speaker, select [ON] for [Speaker] (☞ P.47).
	The volume is set to [00] .	Adjust the volume (☞ P.25).
Playback is inaudible from the earphones.	The earphones connected to the microphone/earphone jack are not detected properly.	Set [Select Jack] to [Earphone] (☞ P.48).
	[Select Jack] is set to [Microphone] .	
	The volume is set to [00] .	Adjust the volume (☞ P.25).

Troubleshooting

Problem	Possible cause	Solution
The recording is too quiet.	[Low] has been selected for [Rec Level].	Redo recording after setting the recording level to [High] (P.40).
	The voice recorder is far away from the recording target.	Move the voice recorder closer to the recording target.
Audio file sound is distorted.	The recording level is adjusted automatically. Excessively loud sound input may generate noise.	Record with the voice recorder farther away from the recording target.
An audio file is not recorded in stereo.	[Rec Mode] is set to MP3 32k Mono or MP3 8k Mono format.	Set [Rec Mode] to [PCM] or [MP3 128k ST] (P.40).
Noise during playback.	Objects brushed against the voice recorder while recording.	Avoid touching the voice recorder as much as possible during recording.
	The voice recorder was placed near a mobile phone or fluorescent light during recording or playback.	Redo the operation with the voice recorder in a different location.
Unable to erase a file.	The file is locked.	You must unlock the file before you can erase it (P.39).
	The file is a read-only file.	Unlock the file, or undo the read-only setting on a PC.
Noise when monitoring a recording.	Feedback is being caused.	Connecting a speaker with a built-in amplifier may cause feedback during recording. It is recommended that you use earphones before starting recording (P.19).
		Adjust the recording setup such as by moving the earphones and microphone farther apart, or ensuring the microphone is not facing the earphones.
Unable to write index marks/temp marks.	The maximum number of marks (99) has been reached.	Erase unneeded marks (P.31).
	The file is locked.	You must unlock the file before you can erase it (P.39).
	The file is a read-only file.	Unlock the file, or undo the read-only setting on a PC.

Troubleshooting

Problem	Possible cause	Solution
Unable to charge the battery.	[Alkaline] has been selected for [Battery].	To use the rechargeable battery provided, select [Ni-MH] for [Battery]. Do not use the rechargeable battery at higher/lower temperatures than the recommended range (☞ P.8, P.13, P.49).
	The OK button was not pressed.	Press the OK button as directed in the confirmation screen shown when connecting the USB connector.
Button operations are abnormal.	[Play Scene] function is enabled.	Set the [Play Scene] setting to [OFF] (☞ P.29).
Playback speed is fast (or slow).	Playback speed function is set to anything other than [x1.0].	Set the playback speed function setting to [x1.0] (☞ P.30).
Files cannot be played consecutively.	[File] has been selected for [Playback Range].	Set the [Playback Range] setting to [Folder] (☞ P.43).
	[ON] has been selected for [Repeat].	Set the [Repeat] setting to [OFF] (☞ P.44).
Unable to skip to the next or previous file during playback.	[File] has been selected for [Playback Range].	Set the [Playback Range] setting to [Folder] (☞ P.43).
	[ON] has been selected for [Repeat].	Set the [Repeat] setting to [OFF] (☞ P.44).
	The [Skip Space] is set to other than [File Skip].	Set the [Skip Space] setting to [File Skip] (☞ P.44).
When files are switched, playback starts automatically.	[ON] has been selected for [Intro Play].	Set the [Intro Play] setting to [OFF] (☞ P.47).

Recorder care

● Exterior

Wipe gently with a soft cloth. If the recorder is very dirty, soak the cloth in mild soapy water and wring well. Wipe the recorder with the damp cloth and then wipe it with a dry cloth.

● Display

Wipe gently with a soft cloth.

NOTE

- Do not use benzene, alcohol or other strong solvents, or chemical cleaning cloths.

Accessories (optional)

BR404 nickel-metal hydride AAA rechargeable battery

A high-efficiency, long-lasting rechargeable battery.

Stereo microphone: ME51SW

The built-in microphone with large diameter enables high-sensitivity stereo recording.

Desktop zoom microphone (unidirectional): ME34

Since it is integrated with a microphone stand, it is suitable for recording sound from a remote location such as a conference or lecture by installing it on a table.

Boundary microphone: ME33

Conference recording microphone that can be connected up to 3 units in two rows. Cascade connection can extend the total of the two rows up to about 12m, so you can record a wide range of sounds.

2-channel microphone (omnidirectional): ME30W

An omnidirectional microphone with a low-noise design suitable for recording in large conference rooms. For recording, the left and right microphones can be placed up to about 5 m apart.

Telephone pickup microphone: TP8

You can talk with the earphone type microphone in your ear. Your voice and conversation during a call can be recorded clearly.

Connecting cord: KA333

A connection cord with resistors with stereo mini plugs ($\phi 3.5$) at both ends. This is used when recording by connecting the earphone output and microphone input. A monaural mini plug ($\phi 3.5$) or a conversion plug adapter (PA331/PA231) for monaural mini mini plug ($\phi 2.5$) is also included.

F-5AC USB-AC adapter

A USB-AC adapter that provides 5-volt DC output. (AC100-240V 50/60Hz)

Copyright and trademark information

- The information in this document is subject to change in future without prior notice. Contact Olympus Customer Support Center for the latest product names, model numbers and other information.
- The display and illustrations of the voice recorder used in this manual may differ from the actual product. While every precaution has been taken to ensure the accuracy of the information in this manual, errors may occasionally arise. Any questions or concerns regarding doubtful information, or possible errors or omissions should be directed to the Olympus Customer Support Center.
- Olympus Corporation is the copyright holders of this manual. Copyright law prohibits unauthorized reproduction of this manual, or unauthorized distribution of reproductions thereof.
- Note that Olympus will assume no liability in the event of damages, lost earnings, or any claims from third parties resulting from improper use of the product.

Trademarks and registered trademarks

- IBM and PC/AT are trademarks or registered trademarks of International Business Machines Corporation.
- Microsoft, Windows and Windows Media are registered trademarks of Microsoft Corporation.
- Macintosh and iTunes are trademarks of Apple Inc.
- The product uses MP3 audio coding technology licensed from Fraunhofer IIS and Thomson.

All other brand or product names in this manual are the trademarks or registered trademarks of their respective owners.

Safety precautions

Before using the voice recorder, read this manual to ensure correct and safe operation. After reading this manual, be sure to keep it on hand for ready reference whenever needed.

Important safety precautions

- Important items about safety are indicated by the following display and sentences. Always follow these precautions to prevent harming yourself or others, or causing damage to property.
- The meaning of each precaution type is given below.



DANGER

A precaution about an imminent danger that is expected to result in death or serious injury if equipment is handled incorrectly.



WARNING

A precaution about a situation that is expected to potentially result in death or serious injury if equipment is handled incorrectly.



CAUTION

A precaution about a situation that is expected to potentially result in injury, or is expected to result only in property damage, if equipment is handled incorrectly.

Voice recorder safety precautions



WARNING

- **Do not use the voice recorder in an atmosphere that might contain flammable or explosive gases.**
It may cause fire or explosion.
- **Do not attempt to disassemble, repair or modify the voice recorder.**
It may cause electric shock or injury.
- **Do not operate the voice recorder while operating a vehicle (such as a bicycle, motorcycle or car).**
It may cause traffic accidents.
- **Do not leave the voice recorder in a location accessible to an infant or child.**

Pay attention when using the voice recorder near an infant or child, taking care not to leave it unattended. Infants and children are unable to understand voice recorder safety precautions, and are at risk of accidents such as:

- Strangulation caused by accidental entanglement of the earphone cord around the neck.
- Operation errors resulting in injury or electric shock.

- **If you notice unusual odor, noise, heat, burning odor or smoke coming from the recorder:**
 - ① Disconnect the battery and USB connection immediately, taking care not to burn or injure yourself. Continued use may result in fire or burns (Do not touch the product with bare hands when it's overheating).

Safety precautions

- ② Contact your place of purchase or an Olympus service center.
- **If the voice recorder is dropped in water or, if water, metal or combustible foreign matter gets inside:**
 - ① Remove the battery immediately.
 - ② Contact your place of purchase or an Olympus service center for repair. Continued use may result in fire or electric shock.
- **Do not use the voice recorder or use it only as directed in airplanes, hospitals or other locations where use of electronic devices is restricted.**
- **Stop using the voice recorder if you notice unusual odor, noise, or smoke coming from it.**

It may cause fire or burns. Remove the battery immediately, taking care not to burn yourself. Contact your place of purchase or an Olympus repair center or service center. (Do not touch the battery with bare hands when removing it. Remove the battery outdoors, and away from flammable objects.)



CAUTION

- **Do not raise the volume before performing an operation.**

Hearing damage or loss may result.

Batteries



DANGER

- **Do not place the battery near ignition sources.**

- **Do not incinerate, heat or disassemble the battery. Do not short-circuit the battery's positive and negative electrodes.**

It may cause fire, ruptures, combustion or overheating.

- **Do not solder connections directly onto the battery. Do not deform, modify or disassemble the battery.**

- **Do not connect the battery's positive and negative terminals.**

It may cause overheating, electric shock or fire.

- **When carrying or storing the battery, always place it in the case to protect its terminals. Do not carry or store the battery together with precious metal items such as key rings.**

It may cause overheating, electric shock or fire.

- **Do not connect the battery directly to a power outlet or car cigarette lighter.**

- **Do not use or leave the battery in a hot location such as in direct sunlight, inside a vehicle on a hot day, or near a room heater.**

It may cause fire, burns or injuries from leaking, overheating or ruptures.



WARNING

- **Do not touch or hold the battery with wet hands.**

It may cause electric shock or malfunctions.

Safety precautions

- **Do not use a battery with a scratched or damaged case.**

It may cause ruptures or overheating.

- **Do not insert the battery with its positive/negative terminals in the opposite direction.**

It may cause leaking, overheating, combustion or ruptures.

- Do not use a battery with a torn casing seal (insulating covering).
- Always remove the battery when the voice recorder will not be used for an long period.
- When disposing used batteries, insulate their contacts with tape and discard them as general waste in the manner prescribed by the local authority.
- Remove the battery from the voice recorder as soon as the battery becomes unusable. It may cause leakage.

- **Battery fluid in the eyes may cause blindness. If battery fluid gets in eyes, do not rub the eyes. Instead, rinse them thoroughly with tap water or other clean water right away. Go to doctor immediately.**

- **Do not attempt to recharge alkaline, lithium or any other non-rechargeable batteries.**

- **Keep the battery out of the reach of infants and children.**

The battery could be swallowed by an infant or child. If swallowed, go to doctor immediately.

- **Do not submerge the battery in freshwater or saltwater, or allow its terminals to become wet.**

- **If you notice abnormal sound, heat, burning odor or smoke from the voice recorder during use:**

- ① Remove the battery immediately, taking care not to injure yourself.
- ② Have the voice recorder repaired by your place of purchase or an Olympus service center. Continued use may result in fire or burns.

- **Discontinue use of the battery if it develops a problem such as leaking, discoloration or deformation.**

- **Stop charging the rechargeable battery if charging has not finished after the specified amount of charging time.**

- **Battery fluid on clothing or skin may damage the skin, so rinse the battery fluid off right away with tap water or other clean water.**



CAUTION

- **Do not throw the battery around, or subject it to strong shocks.**
- **Always charge the rechargeable battery before use when using it for the first time or if it has not been used for a long time.**
- **Rechargeable batteries have a limited life. When the recorders operating time becomes shorter after recharging under the specified condition, please consider that battery is expired and replace it with a new one.**

Disposing the rechargeable battery

- **Recycling batteries helps saving resources. When disposing a used battery, always cover its terminals and observe local laws and regulations.**

Operating precautions

- Do not leave the voice recorder in hot or humid locations such as in direct sunlight inside a vehicle, or on a beach during summer.
- Do not store the voice recorder in humid or dusty locations.
- If the voice recorder becomes wet or damp, wipe off the moisture right away with a dry cloth. Contact with salt water should be particularly avoided.
- Do not place the voice recorder on top of or near a TV, refrigerator or other electrical appliance.
- Prevent sand or mud from getting on the voice recorder. It may cause product not to be repairable.
- Do not subject the voice recorder to intense vibrations or shocks.
- Do not use the voice recorder in humid locations.
- Placing a magnetic card (such as a bank cash card) near the speaker or earphones may cause errors in the data stored on the magnetic card.
- Do not bring the voice recorder close to power lines, fluorescent lights, mobile phones, etc. during recording or playback. The sound may be noisy.
- Olympus will not be held liable for violations of local regulations arising from use of this product outside the country or region of purchase.

<Data loss precautions>

- Recorded content in the internal memory may be destroyed or lost due to reasons such as operating errors, device failure or repair.
- Also, when content is saved in the memory for long period of time or is used repeatedly, operations such as writing to, reading from, or erasing of contents may not be possible.
- Making a backup of important recorded information and saving it on a PC's hard disk or other recording media is recommended.
- Note that Olympus will assume no liability for damages or lost earnings resulting from recorded data damage or loss, regardless of the nature or cause thereof.

<Recorded file precautions>

- Note that Olympus will assume no liability for recorded files being erased or becoming unplayable due to voice recorder or PC failure.
- Recording of copyrighted material is permitted when the recording is for your personal use only. Any other type of use without the permission of the copyright owner is prohibited by copyright law.

<Voice recorder disposal precautions>

- Even when formatting (E30 P.56) or erasing (E30 P.35) are performed, only the file management information of the internal memory is updated and the recorded data is not completely erased. When disposing the voice recorder, be sure to destroy it, format and record silence until the recording time runs out, or perform a similar operation in order to prevent the leakage of personal information.

Specifications

General items

Recording formats

Linear PCM (pulse-code modulation) format

MP3 (MPEG-1 Audio Layer 3) format

MP3 (MPEG-2 Audio Layer3) format

MP3 (MPEG-2.5 Audio Layer3) format

Sampling frequency

Linear PCM format

22.05 kHz/16 bits	22.05 kHz
-------------------	-----------

MP3 format

128 kbps	44.1 kHz
32 kbps mono	22.05 kHz
8 kbps mono	11.025 kHz

Maximum headphone output

3 mW + 3 mW (at 16Ω load)

Recording media*

Internal NAND FLASH memory: 8 GB

* Some memory capacity is used as a management area, so the actual usable capacity will always be slightly less than the displayed capacity.

Speaker

Built-in ø 10 mm round dynamic speaker

Microphone/Earphone jack

Microphone: 3.5 mm diameter, impedance 2 Ω

Earphone: 3.5 mm diameter, impedance 8 Ω or more

Maximum working output

90 mW (8 Ω speaker)

Power source

Standard voltage: 1.5 V

Battery: One AAA dry cell battery (model LR03), or one Olympus nickel-metal hydride rechargeable battery

External dimensions

17 mm × 130 mm × 17 mm
(Not including largest projection)

Weight

37.5 g (including battery)

Operating temperature

0 to 42°C (32 to 107.6°F)

Frequency response

When recording with built-in stereo microphone

Linear PCM format

22.05 kHz/16 bits	40 Hz to 10 kHz
-------------------	-----------------

MP3 format

128 kbps	40 Hz to 17 kHz
32 kbps mono	40 Hz to 7 kHz
8 kbps mono	40 Hz to 3 kHz

Recording with built-in stereo microphone

50 Hz to 17 kHz
(The upper limit of frequency characteristics depends on each recording mode.)

During playback

20 Hz to 20 kHz
(The upper and lower limit of frequency characteristics depends on each recording mode.)

Specifications

Battery life

The figures below are guideline values.

■ When recording with built-in stereo microphone (using internal memory)

Recording mode		Battery life	
		Alkaline dry cell battery	Nickel-metal hydride rechargeable battery
Linear PCM format	22.05 kHz/16 bits	24 hours (approx.)	19 hours (approx.)
MP3 format	128 kbps	27 hours, 30 minutes (approx.)	21 hours (approx.)
	32 kbps mono	40 hours (approx.)	27 hours, 30 minutes (approx.)
	8 kbps mono	50 hours (approx.)	34 hours (approx.)

■ During audio file playback (all playback modes)

During speaker playback

Recording mode		Battery life	
		Alkaline dry cell battery	Nickel-metal hydride rechargeable battery
Linear PCM format	22.05 kHz/16 bits	21 hours (approx.)	16 hours (approx.)
MP3 format	128 kbps	26 hours (approx.)	18 hours (approx.)
	32 kbps mono	26 hours, 30 minutes (approx.)	19 hours (approx.)
	8 kbps mono	27 hours, 30 minutes (approx.)	20 hours (approx.)

During earphone playback

Recording mode		Battery life	
		Alkaline dry cell battery	Nickel-metal hydride rechargeable battery
Linear PCM format	22.05 kHz/16 bits	24 hours, 30 minutes (approx.)	17 hours, 30 minutes (approx.)
MP3 format	128 kbps	34 hours, 30 minutes (approx.)	22 hours (approx.)
	32 kbps mono	35 hours (approx.)	22 hours, 30 minutes (approx.)
	8 kbps mono	36 hours (approx.)	23 hours, 30 minutes (approx.)

NOTE

- The battery life figures shown here were determined using an Olympus test method (When **[LED]** is set to **[OFF]**). Actual battery life figures will vary greatly according to the battery used and usage conditions (Changing the playback speed, or using the **[Noise Cancel]**, **[Voice Balancer]**, **[Rec Scene]**, **[Play Scene]** and **[Rec Standby]** functions may affect the battery life).

Specifications

Recording time

The figures below are guideline values.

■ Linear PCM format

Recording mode		Internal memory (8 GB)
Linear PCM format	22.05 kHz/16 bits	23 hours, 30 minutes (approx.)

■ MP3 format

Recording mode		Internal memory (8 GB)
MP3 format	128 kbps	130 hours (approx.)
	32 kbps mono	525 hours (approx.)
	8 kbps mono	2100 hours (approx.)

NOTE

- Actually available recording times may be shorter than the figures shown here when making short recordings repeatedly (Equipment displays of available/elapsed recording times should be considered guideline values).

Specifications

Maximum recording time per file

- The maximum file size is limited to about 4 GB in the MP3 format, and to about 2 GB in the linear PCM (WAV) format.
- Regardless of the amount of remaining memory, the maximum recording time per file is restricted to the following values.

■ Linear PCM format

Recording mode		Recording time
Linear PCM format	22.05 kHz/16 bits	6 hours, 40 minutes (approx.)

■ MP3 format

Recording mode		Recording time
MP3 format	128 kbps	74 hours, 30 minutes (approx.)
	32 kbps mono	298 hours (approx.)
	8 kbps mono	1193 hours (approx.)

Number of music tracks (songs) that can be recorded

The figures below are guideline values.

8 GB	1900 tracks (approx.)
------	-----------------------

(At 128 kbps, 4 minutes per track)

Note that voice recorder specifications and appearance are subject to change without prior notice for performance improvements or other upgrading.

OLYMPUS AMERICA INC.

3500 Corporate Parkway, P.O. Box 610, Center Valley, PA 18034-0610, U.S.A.
Tel. 484-896-5000

Technical Support (USA):

24/7 online automated help:

<http://www.olympusamerica.com/support>

Phone customer support:

Tel.: 1-888-553-4448 (Toll-free)

Our phone customer support is available from 9

am to 9 pm (Monday to Friday) ET

<http://www.olympusamerica.com/contactus>

Olympus software updates can be obtained at:

<http://www.olympusamerica.com/digital>

date of issue 2020.01.

OLYMPUS

OLYMPUS CORPORATION

2951 Ishikawa-machi, Hachioji-shi, Tokyo 192-8507, Japan.

OLYMPUS EUROPA SE & CO. KG

Premises: Consumer Product Division
Wendenstrasse 14 - 18, 20097 Hamburg, Germany.
Tel. :+49 40 -23 77 3-0 / Fax +49 40 - 23 07 61

Goods delivery: Modul H, Willi-Bleicher Str. 36, 52353 Düren, Germany.

Letters: Postfach 10 49 08, 20034 Hamburg, Germany.

European Technical Customer Support:

Please visit our homepage <http://www.olympus-europa.com>
or call our TOLL FREE NUMBER*: **00800 - 67 10 83 00**

for Austria, Belgium, Czech Republic, Denmark, Finland, France, Germany, Luxemburg, Netherlands, Norway, Poland, Portugal, Russia, Spain, Sweden, Switzerland, United Kingdom.
* Please note some (mobile) phone services / provider do not permit access or request an additional prefix to +800 numbers.

For all not listed European Countries and in case that you can't get connected to the above mentioned number please make use of the following
CHARGED NUMBER: + **49 40 - 237 73 899**.

OLYMPUS AUSTRALIA PTY LTD

Ground Floor, 82 Waterloo Road, Macquarie Park NSW 2113, Australia
PO Box 1991 Macquarie Centre NSW 2113

Tel: +61 2 9886 3992
<http://www.olympus.com.au>

Customer Service Centres:

Australia

Olympus Australia Pty Ltd.
Tel: **1300 659 678**
Fax: **+61 2 9889 7988**
<http://www.olympus.com.au>

New Zealand

Dictation Distributors Ltd.
Tel: **0800 659 678**
Fax: **+64 9 303 3189**
<http://www.dictation.co.nz>