



# Catalyst 2960-S Switch Getting Started Guide

---

- [About This Guide](#)
- [Unpacking the Switch](#)
- [Running Express Setup](#)
- [Managing the Switch](#)
- [Planning and Creating Switch Stacks](#)
- [Rack-Mounting](#)
- [Connecting the FlexStack Cables](#)
- [Connecting to the Switch Ports](#)
- [In Case of Difficulty](#)
- [Obtaining Documentation and Submitting a Service Request](#)

## About This Guide

This guide provides instructions on how to use Express Setup to initially configure your Catalyst switch. It also covers switch management options, basic rack-mounting, stacking guidelines, port and module connection procedures, and troubleshooting help.

For additional installation and configuration information for the switch, see the Catalyst 2960 documentation on Cisco.com. For system requirements, important notes, limitations, open and resolved bugs, and last-minute documentation updates, see the release notes, also on Cisco.com. For translations of the warnings that appear in this publication, see the *Regulatory Compliance and Safety Information for the Catalyst 2960 and 2960-S Switches* on Cisco.com.

When using the online publications, see the documents that match the Cisco IOS software version running on the switch. The software version is on the Cisco IOS label on the switch rear panel.

## Unpacking the Switch

Follow these steps:

1. Unpack and remove the switch and the accessory kit from the shipping box.
2. Return the packing material to the shipping container, and save it for future use.
3. Verify that you have received these items. If any item is missing or damaged, contact your Cisco representative or reseller for instructions.

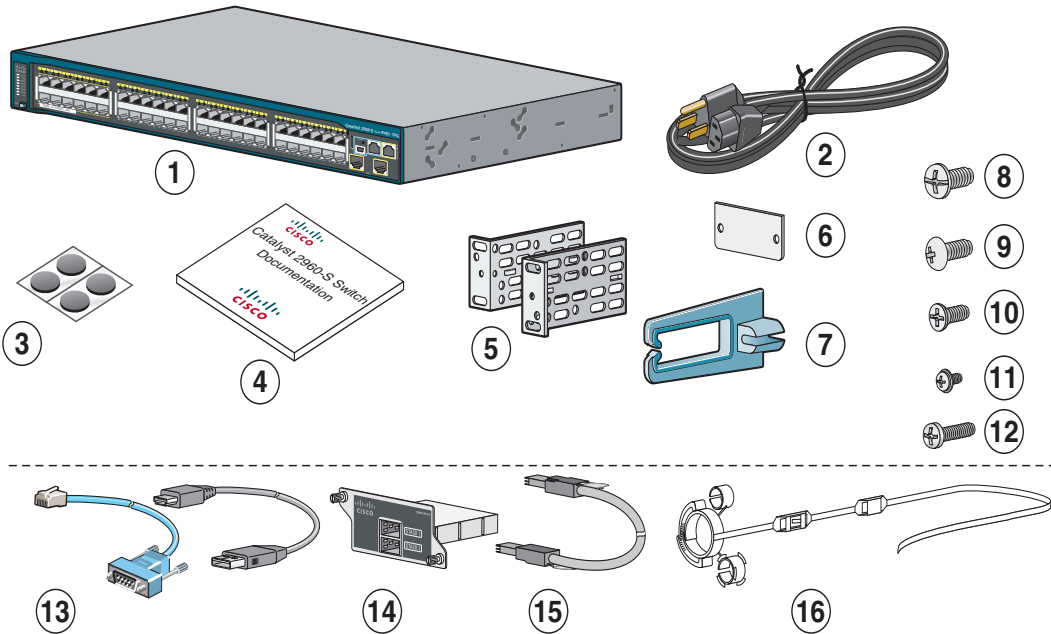

206224

<b>1</b>	Catalyst 2960-S switch <sup>1</sup>	<b>9</b>	Four number-8 Phillips truss-head screws (48-0656-01)
<b>2</b>	AC power cord	<b>10</b>	Four number-8 Phillips flat-head screws (48-0655-01)
<b>3</b>	Four rubber mounting feet	<b>11</b>	Two number-4 pan-head screws (48-0482-01)
<b>4</b>	Documentation	<b>12</b>	One black Phillips machine screw (48-0654-01)
<b>5</b>	Two 19-inch mounting brackets	<b>13</b>	(Optional <sup>3</sup> ) Console cable or USB cable
<b>6</b>	Connector <sup>2</sup> cover for redundant power system	<b>14</b>	(Optional <sup>3</sup> ) Cisco FlexStack module
<b>7</b>	Cable guide	<b>15</b>	(Optional <sup>3</sup> ) Cisco FlexStack cable
<b>8</b>	Four number-12 Phillips pan-head screws (48-0523-01)	<b>16</b>	(Optional <sup>3</sup> ) Power cord retainer

1. Catalyst 2960S-48FPD-L switch shown for example. Your switch model might look different.
2. Only available on some models.
3. Item is orderable.

# Running Express Setup

When you first set up the switch, you should use Express Setup to enter the initial IP information. Doing this enables the switch to connect to local routers and the network. You can then access the switch through the IP address for further configuration.

You need this equipment to set up the switch:

- A PC with Windows 2000, XP, Vista, or Windows Server 2003 installed
- A web browser (Internet Explorer 6.0, 7.0, Firefox 1.5, 2.0, or later) with JavaScript enabled

**Note**

Other laptops and browsers might work.

- A straight-through or crossover Category 5 or 6 Ethernet cable to connect your PC to the switch

**Note**

Before running Express Setup, disable any pop-up blockers or proxy settings in your browser software and any wireless client running on your PC.

**Step 1** Make sure that nothing is connected to the switch.

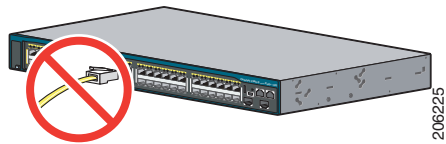

**Step 2** During Express Setup, the switch acts as a DHCP server. If your PC has a static IP address, temporarily configure your PC settings to use DHCP before proceeding to the next step.

**Note** Write down the static IP address. You will need this IP address in [Step 10](#).

**Step 3** Power the switch by connecting the AC power cord to the switch power supply and to a grounded AC outlet.

Approximately 30 seconds after the switch powers on, it begins the power-on self-test (POST), which can take several minutes to complete.

During POST, the SYSTEM LED blinks green, and the RPS, STATUS, DUPLEX, and SPEED LEDs turn solid green.

When POST is complete, the SYSTEM LED remains solid green, and the other LEDs go off. The exception is the STACKMASTER LED, which remains solid green if the switch is stackable and is acting as stack master.

Before proceeding to the next step, wait until POST is complete. This might take up to 5 minutes after the switch is powered on.

**Troubleshooting:**

If the SYSTEM LED blinks green, does not turn solid green, or turns amber, contact your Cisco representative or reseller. The switch failed the power-on self-test (POST).

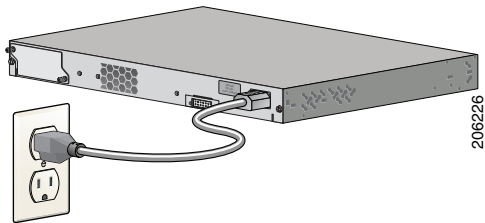

**Step 4** Press and hold the Mode button until all of the LEDs above the Mode button turn solid green. You might need to hold the button for 3 or more seconds.

Release the Mode button after all of the LEDs above the Mode button turn solid green. (The RPS LED remains off on some switch models, and is not present on all models.)

The switch is now in Express Setup mode.

Before proceeding to the next step, make sure that all of the LEDs above the Mode button are solid green.

**Troubleshooting:**

If the LEDs above the Mode button blink after you press the button, release it. Blinking LEDs mean that the switch is already configured and cannot go into Express Setup mode. For more information, see the [“Resetting the Switch”](#) section on page 28.

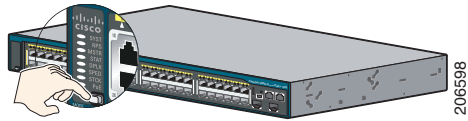

**Step 5** Connect a Category 5 or 6 Ethernet cable to one of these locations:

- Any 10/100 or 10/100/1000 Ethernet downlink port (such as port 1) on the switch front panel.
- The Ethernet management port on the switch front panel.

Connect the other end of the cable to the Ethernet port on your PC.

Before proceeding to the next step, wait until the port LEDs on the switch and your PC or laptop are green (either solid or blinking). The green port LEDs indicate a successful connection.

**Troubleshooting:**

If the port LEDs do not turn green after about 30 seconds, make sure that:

- You connected the Ethernet cable to one of the downlink switch ports (not to an uplink port such as the dual-purpose port).
- You are using an undamaged Category 5 or 6 Ethernet cable.
- The other device is turned on.

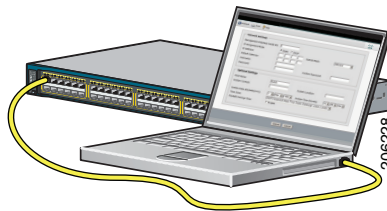

**Step 6** Enter the IP address **10.0.0.1** in a web browser and press **Enter**.

When prompted, enter the default password, *cisco*.

**Note** The switch ignores text in the username field.

The Express Setup window appears.

**Troubleshooting:**

If the Express Setup window does not appear, make sure that any pop-up blockers or proxy settings on your browser are disabled and that any wireless client is disabled on your PC or laptop.





---

**Step 7** Enter the required settings in the Express Setup window.

**Note** All entries must be in English letters and numbers.

### Required Fields

Enter this information in the Network Settings fields:

- In the Management Interface (VLAN ID) field, the default is 1.

**Note** We recommend using the default VLAN value because during Express Setup, VLAN 1 is the only VLAN on the switch.

Enter a new VLAN ID only if you want to change the management interface through which you manage the switch. The VLAN ID range is 1 to 1001.

- In the IP Address field, enter the IP address of the switch.
- In the Subnet Mask field, click the drop-down arrow, and select a subnet mask.
- In the Default Gateway field, enter the IP address for the default gateway (router).
- Enter your password in the Switch Password field. The password can be from 1 to 25 alphanumeric characters, can start with a number, is case sensitive, allows embedded spaces, but does not allow spaces at the beginning or end. In the Confirm Switch Password field, enter your password again.

**Note** You must change the password from the default password, *cisco*.

### Optional Fields

You can enter other administrative settings in the Express Setup window. For example, the optional administrative settings identify and synchronize the switch for enhanced management. The switch clock is automatically synchronized with the network clock by using NTP. You can manually set the system clock settings if the switch should have different time settings.

Click **Submit** to save your changes and to complete the initial setup.

For more information about the Express Setup fields, see the online help for the Express Setup window.

---

**Step 8** After you click **Submit**, these events occur:

- The switch is configured and exits Express Setup mode.
  - The browser displays a warning message and tries to connect with the earlier switch IP address. Typically, connectivity between the PC and the switch is lost because the configured switch IP address is in a different subnet from the IP address on the PC.
-

- 
- Step 9** Disconnect the switch from the PC, and install the switch in your network. See the [“Rack-Mounting” section on page 18](#).
- 
- Step 10** If you changed the static IP address on your PC in [Step 2](#), change it back to the previously configured static IP address.
- 
- Step 11** You can now manage the switch by using Cisco Network Assistant, Device Manager, or both. See the [“Managing the Switch” section on page 11](#) for information about configuring and managing the switch.

We strongly recommend that you download Cisco Network Assistant from Cisco.com and use it to manage the switch. See the [“Managing the Switch” section on page 11](#) for information about configuring and managing the switch.

You can display Device Manager by following these steps:

1. Start a web browser on your PC or laptop.
2. Enter the switch IP address, username, and password (assigned in [Step 7](#)) in the web browser, and press **Enter**. The Device Manager page appears.

#### Troubleshooting:

If Device Manager does not appear:

- Confirm that the port LED for the switch port connected to your network is green.
- Confirm that the PC or laptop you are using to access the switch has network connectivity by connecting to a well-known web server in your network. If there is no network connection, troubleshoot the network settings on the PC or laptop.
- Make sure that the switch IP address in the browser is correct.
- If switch IP address in the browser is correct, the switch interface LED is green, and the PC or laptop has network connectivity, continue troubleshooting by reconnecting the PC or laptop to the switch. Configure a static IP address on the PC or laptop that is in the same subnet as the switch IP address. For example:
  - If your switch IP address is 172.20.20.85 and your PC or laptop IP address is 172.20.20.84, both devices are in the same network.
  - If your switch IP address is 172.20.20.85 and your PC or laptop IP address is 10.0.0.2, the devices are in different networks and cannot communicate directly.
- When the LED on the switch port connected to the PC or laptop is green, reenter the IP address of the switch in a web browser to display Device Manager. Once Device Manager appears, you can continue with the switch configuration.

# Managing the Switch

After completing Express Setup and installing the switch in your network, you can use one of these options for further configuration:

- [Device Manager](#)
- [Cisco Network Assistant](#)
- [Command-Line Interface](#)
- [Other Management Options](#)

## Device Manager

The simplest way to manage the switch is by using Device Manager in the switch memory. This web interface offers quick configuration and monitoring. You can access Device Manager from anywhere in your network through a web browser.

1. Launch a web browser on your PC or workstation.
2. Enter the switch IP address in the web browser, and press **Enter**. The Device Manager page appears.
3. Use Device Manager to perform basic switch configuration and monitoring. See the Device Manager online help for more information.
4. For more advanced configuration, download and run Cisco Network Assistant, which is described in the next section.

## Cisco Network Assistant

Cisco Network Assistant is a software program that you download from Cisco.com and run on your PC. It offers advanced options for configuring and monitoring multiple devices, including switches, switch clusters, switch stacks, routers, and access points. Cisco Network Assistant is free—there is no charge to download, install, or use it.

1. Go to this Web address:  
[http://www.cisco.com/en/US/products/ps5931/tsd\\_products\\_support\\_series\\_home.html](http://www.cisco.com/en/US/products/ps5931/tsd_products_support_series_home.html).

You must be a registered Cisco.com user, but you need no other access privileges.

2. Find the Network Assistant installer.
3. Download the Network Assistant installer and run it. (You can run it directly from the Web if your browser offers this choice.)
4. When you run the installer, follow the displayed instructions. In the final panel, click **Finish** to complete the Network Assistant installation.

See the Network Assistant online help and the getting started guide for more information.

## Command-Line Interface

You can enter Cisco IOS commands and parameters through the CLI. Access the CLI by using one of these options:

- [Switch Console Port](#)
- [Switch Ethernet Management Port](#)
- [Switch USB Port](#)

## Switch Console Port

1. Connect the supplied RJ-45-to-DB-9 adapter cable to the standard 9-pin serial port on the PC. Connect the other end of the cable to the console port on the switch.
2. Start a terminal-emulation program on the PC.
3. Configure the PC terminal emulation software for 9600 baud, 8 data bits, no parity, 1 stop bit, and no flow control.
4. Use the CLI to enter commands to configure the switch. See the software configuration guide and the command reference for more information.

## Switch Ethernet Management Port

1. Connect a Category 5 Ethernet cable to the PC Ethernet port. Connect the other end of the cable to the Ethernet management port on the switch.
2. Start a Telnet session on the PC.
3. Enter the switch IP address that you assigned by using Express Setup.
4. Use the CLI to enter commands to configure the switch. See the software configuration guide and the command reference for more information.

## Switch USB Port

1. Connect an USB cable to the PC USB port. Connect the other end of the cable to the mini B (5-pin-connector) USB port on the switch.
2. Start a terminal-emulation program on the PC.
3. Configure the PC terminal emulation software for 9600 baud, 8 data bits, no parity, 1 stop bit, and no flow control.
4. Use the CLI to enter commands to configure the switch. See the software configuration guide and the command reference for more information.



---

**Note** You cannot use the switch console port and the switch USB port at the same time to access the CLI.

---

## Other Management Options

You can use SNMP management applications such as CiscoWorks LAN Management Solution (LMS) and Cisco netManager to configure and manage the switch. You also can manage it from an SNMP-compatible workstation that is running platforms such as Cisco netManager or SunNet Manager.

The Cisco Configuration Engine is a network management device that works with embedded Cisco Networking Services (CNS) agents in the switch software. You can use it to automate initial configurations and configuration updates on the switch.

See the [“Accessing Help Online” section on page 28](#) for a list of supporting documentation.

## Planning and Creating Switch Stacks



### Note

---

This section applies only to the Catalyst 2960-S stacking switches.

---

Before connecting the switches in a stack, keep in mind these switch stack guidelines:

- Connect only Catalyst 2960-S switches in a switch stack.
- Install the FlexStack module and the FlexStack cable for stacking capability. You can order them in a kit from your Cisco sales representative: C2960S-STACK=.
- Consider the length of FlexStack cable. Depending on your configurations, you might need different sized cables. You can order them from your Cisco sales representative:
  - CAB-STK-E-0.5M= (0.5-meter cable)
  - CAB-STK-E-1M= (1-meter cable)
  - CAB-STK-E-3M= (3-meter cable)

For additional stacking guidelines, see the switch hardware installation guide on Cisco.com. For concepts and procedures to manage switch stacks, see the switch software configuration guide on Cisco.com.

## Installing the FlexStack Module

- Step 1** Use a flat-blade screwdriver to remove the FlexStack module blank cover on the switch back panel.

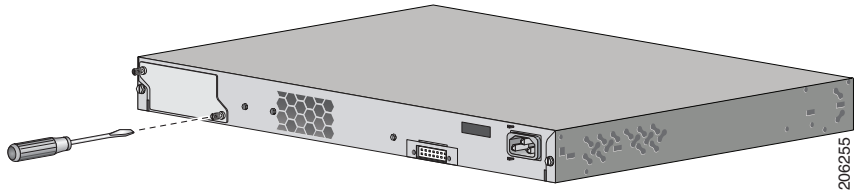

- Step 2** Grasp the FlexStack module on the sides, and insert it into the module slot.

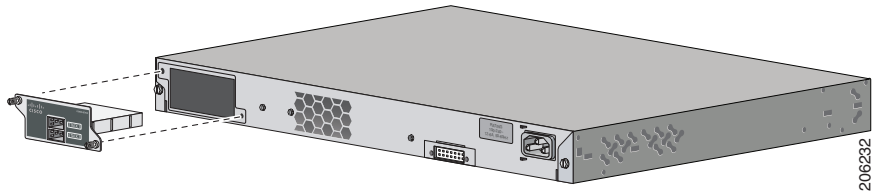

- Step 3** Secure the screws tightly on each side of the module.



**Note** Make sure the screws are finger-tight to avoid overtightening of the screws.

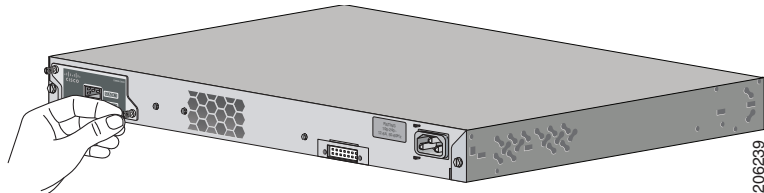

## Cabling Guidelines

These illustrations show the recommended switch stack configurations with redundant stack cabling connections for optimized stack bandwidth. For more configuration examples, see the hardware installation guide on Cisco.com.

This is an example of a redundant stack cable connection using the 0.5-meter FlexStack cable.

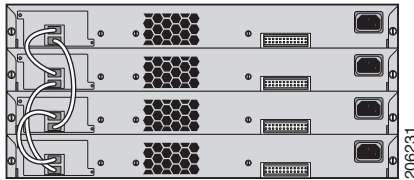



This is an example of a redundant stack cable connection using both the 0.5- and 3-meter FlexStack cables.

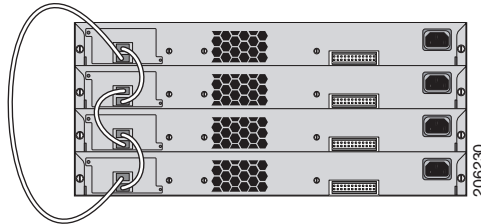

## Powering Guidelines

Consider these guidelines before you power the switches in a stack:

- If you want a particular switch to become the stack master, power on that switch first. This switch becomes the stack master and remains the stack master until a master reelection is required. After 2 minutes, power on the remaining switches in the stack.
- Power off a switch before you add it to or remove it from an existing switch stack.

For more information on stack master elections, see the “Managing Switch Stacks” chapter in the switch software configuration guide on Cisco.com.

# Rack-Mounting

This section covers basic 19-inch rack-mounting and switch port connections. As an example, all the illustrations show the Catalyst 2960S-48FPD-L switch. You can install and connect the other Catalyst 2960-S switches as shown in these illustrations. For alternate mounting procedures, such as installing the switch in a 24-inch rack or on a wall, and for additional cabling information, see the hardware installation guide on Cisco.com.

## Required Tools

You need to supply a number-2 Phillips screwdriver to rack-mount the switch.

## Before You Begin

Before installing the switch, verify that these guidelines are met:

- Clearance to the front panels is sufficient so that the LEDs can be easily read.
- Access to the switch rear panel to connect the optional Cisco Redundant Power Supply (RPS) 2300 or to stack the switches. If you do not have access to the rear panel, you should cable the switches before you rack-mount them.
- AC power cord reaches from the AC power outlet to the connector on the switch rear panel.
- Cabling is away from sources of electrical noise, such as radios, power lines, and fluorescent lighting fixtures. Make sure the cabling is safely away from other devices that might damage the cables.
- Airflow around the switch and through the vents is unrestricted.
- Temperature around the unit does not exceed 113°F (45°C). If the switch is installed in a closed or multirack assembly, the temperature around it might be greater than normal room temperature.
- Humidity around the switch does not exceed 85 percent.
- Altitude at the installation site is not greater than 10,000 feet.

- For 10/100 or 10/100/1000 fixed ports, cable lengths from the switch to connected devices can be up to 328 feet (100 meters).
- For cable lengths for small form-factor pluggable (SFP)-module connections, see the hardware installation guide on Cisco.com and the documentation that shipped with the module.

## Installation Warning Statements

This section includes the basic installation warning statements. Translations of these warning statements appear in the *Regulatory Compliance and Safety Information for the Catalyst 2960 and 2960-S Switches* document on Cisco.com.



**Warning**

---

**To prevent bodily injury when mounting or servicing this unit in a rack, you must take special precautions to ensure that the system remains stable. The following guidelines are provided to ensure your safety:**

**This unit should be mounted at the bottom of the rack if it is the only unit in the rack.**

**When mounting this unit in a partially filled rack, load the rack from the bottom to the top with the heaviest component at the bottom of the rack.**

**If the rack is provided with stabilizing devices, install the stabilizers before mounting or servicing the unit in the rack.** Statement 1006

---



**Warning**

---

**Class 1 laser product.** Statement 1008

---



**Warning**

---

**This equipment must be grounded. Never defeat the ground conductor or operate the equipment in the absence of a suitably installed ground conductor. Contact the appropriate electrical inspection authority or an electrician if you are uncertain that suitable grounding is available.** Statement 1024

---

**Warning**

To prevent the system from overheating, do not operate it in an area that exceeds the maximum recommended ambient temperature of: **<113°F (45°C)**. Statement 1047

**Warning**

To prevent airflow restriction, allow clearance around the ventilation openings to be at least: **3 inches (7.6 cm)**. Statement 1076

## Before Attaching Brackets

To install the switch in a rack, you must first remove the screws from the switch chassis so that the mounting brackets can be attached.

**Note**

You do not need to remove the screws for attaching the brackets in the rear-mounting position.

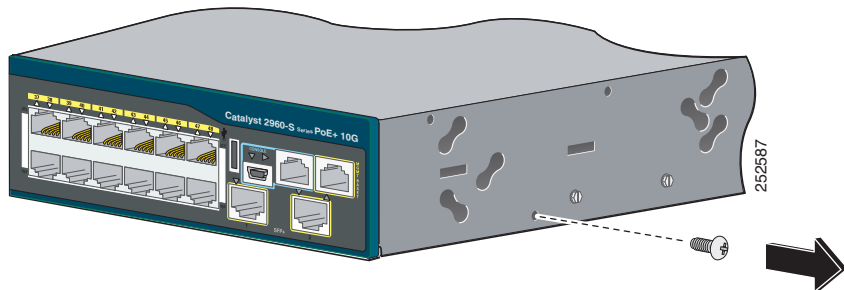

## Attaching the Brackets

Use four Phillips flat-head screws to attach the long side of the brackets to Catalyst 2960-S switches in one of three mounting positions.

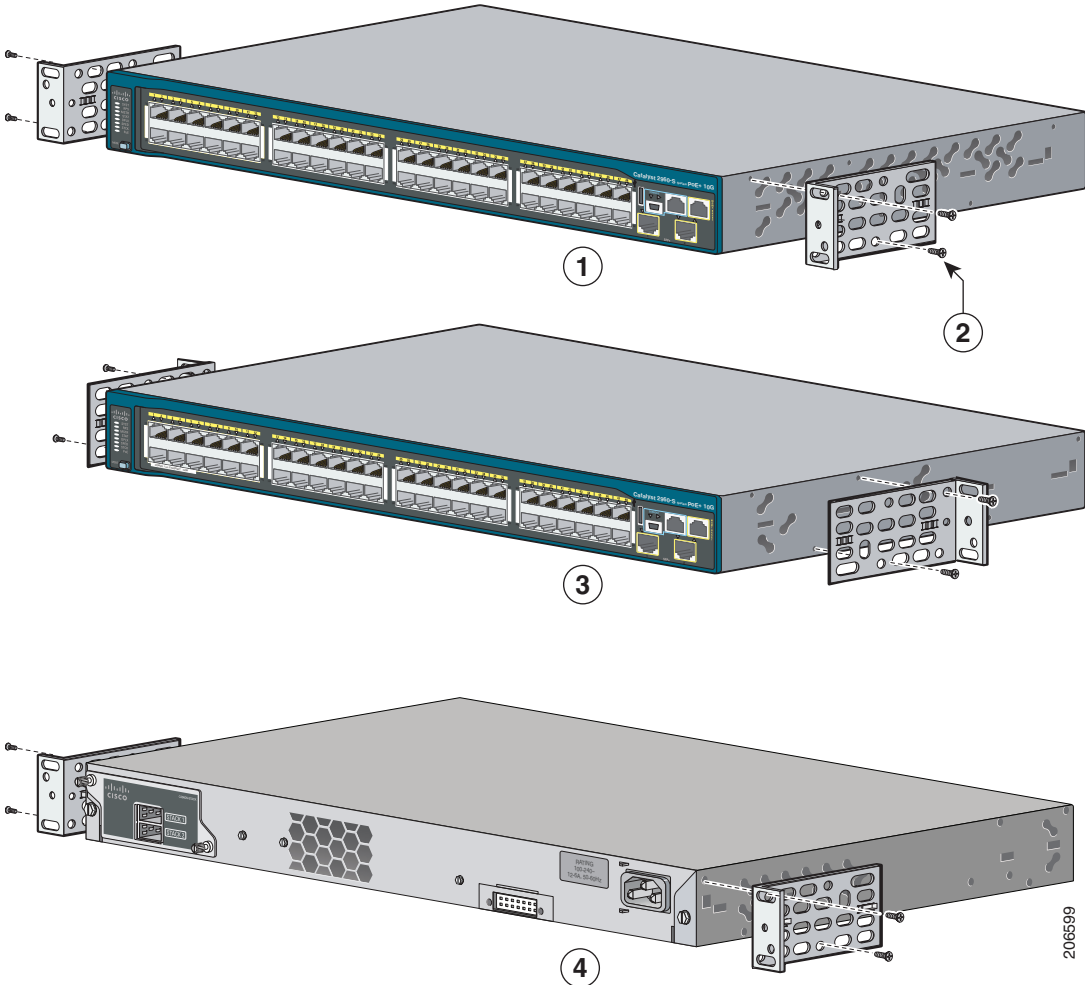

<b>1</b>	Front-mounting position	<b>3</b>	Mid-mounting position
<b>2</b>	Number-8 Phillips flat-head screws (48-0655-01)	<b>4</b>	Rear-mounting position

## Rack-Mount the Switch

Use the four number-12 Phillips machine screws to attach the brackets to the rack. Use the black Phillips machine screw to attach the cable guide to the left or right bracket.

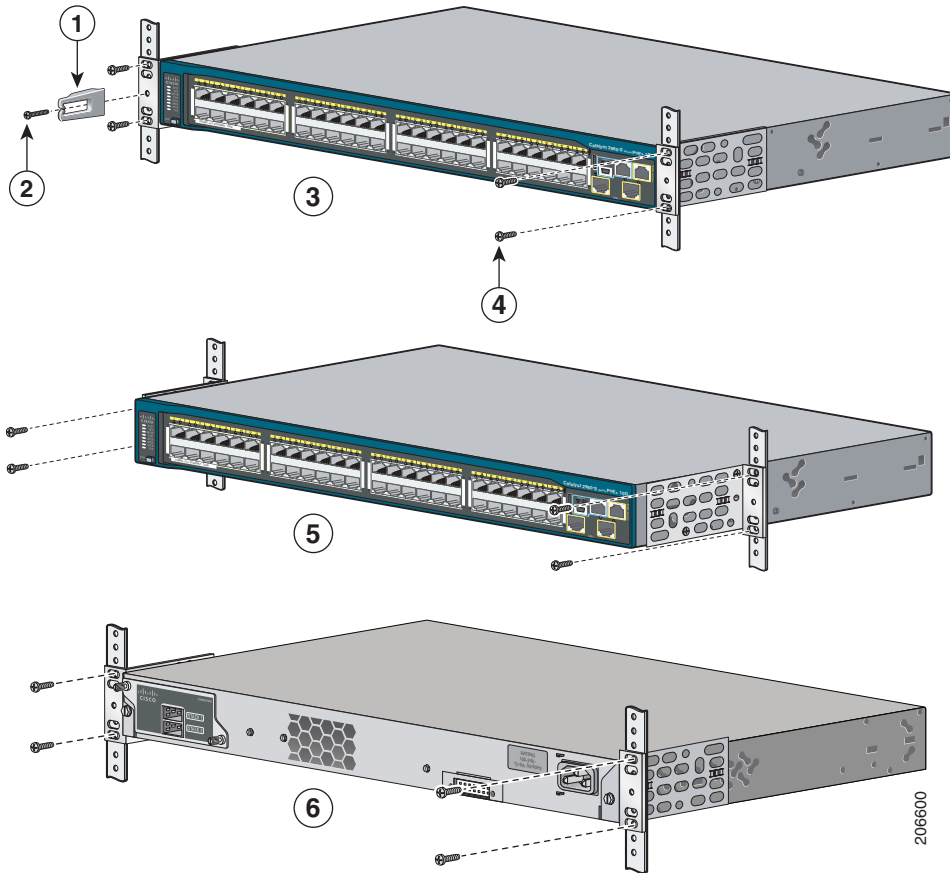

1	Cable guide	4	Number-12 Phillips pan-head screws (48-0523-01)
2	Black Phillips machine screw (48-0654-01)	5	Mid-mounting position
3	Front-mounting position	6	Rear-mounting position

# Connecting the FlexStack Cables

Always use a Cisco-approved FlexStack cable to connect the switches. Connect only Catalyst 2960-S switches in a switch stack.

- Step 1** Remove the dust covers from the FlexStack cables, and store them for future use.

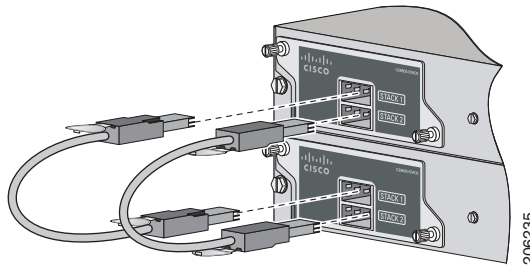

- Step 2** Insert one end of the FlexStack cable into the stack port of the first switch. Insert the other end of the cable into the stack port on the other switch.



**Note**

When you connect the FlexStack cable into the STACK 1 port, the tab should be above the connector. When you connect the FlexStack cable into the STACK 2 port, you should invert the cable so that the tab is below the connector.

- Step 3** Replace the dust covers when you remove the FlexStack cables from the connectors.

Removing and installing the FlexStack cable can shorten its useful life. Do not remove and insert the cable more often than is absolutely necessary.

# Connecting to the Switch Ports

This section describes how to connect to the fixed switch ports and to the SFP module ports.

## Connect to the 10/100 or 10/100/1000 Ports

**Step 1** When you connect to servers, workstations, IP phones, wireless access points, and routers, insert a straight-through, twisted four-pair, Category 5 cable in a switch 10/100 or 10/100/1000 port. Use a crossover, twisted four-pair, Category 5 cable when you connect to other switches, hubs, or repeaters.

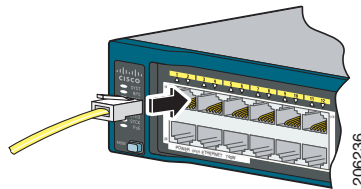

**Step 2** Insert the other cable end into an RJ-45 port on the other device.

The fixed ports on the Catalyst 2960-S Power over Ethernet Plus (PoE+) switches provide:

- PoE+ support for IEEE 802.3at-compliant powered devices
- PoE support for IEEE 802.3af-compliant powered devices
- Support for Cisco enhanced PoE (ePoE)

They also provide Cisco prestandard PoE support for Cisco IP phones and Cisco Aironet Access Points. See the switch hardware guide for information on PoE budgeting.

By default, a Catalyst 2960-S switch PoE port automatically provides power when a compliant device is connected, including ePoE, PoE, and PoE+. For information about configuring and monitoring PoE and PoE+ ports, see the switch software configuration guide.



**Note**

The automatic medium-dependent interface crossover (auto-MDIX) feature is enabled by default. The switch detects the required cable type for copper Ethernet connections and configures the interfaces accordingly. Therefore, you can use either a crossover or a straight-through cable for connections to a copper 10/100 or 10/100/1000 module port on the switch, regardless of the type of device on the other end of the connection.

## Install the SFP or SFP+ Modules

Some Catalyst 2960-S switches have SFP module slots and others have SFP+ module slots. The SFP slots support only the SFP modules. The SFP+ slots support both SFP and SFP+ modules.

- Step 1** Grasp the module on the sides, and insert it into the switch slot until you feel the connector snap into place.

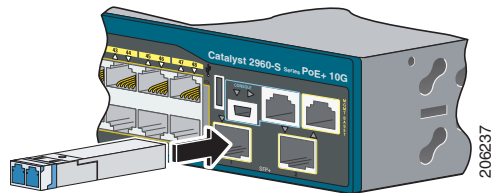

- Step 2** Insert an appropriate cable into the module port. Insert the other cable end into the other device.

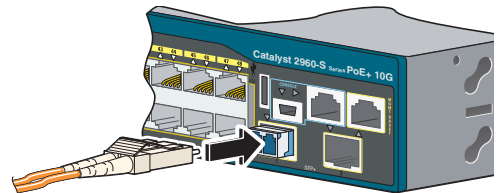

For a list of supported modules, see the release notes on Cisco.com. For detailed instructions on installing, removing, and connecting to SFP modules, see the documentation that came with the SFP module.

**Caution**

Removing and installing an SFP module can shorten its useful life. Do not remove and insert SFP modules more often than is absolutely necessary.

## Verify Port Connectivity

After you connect the switch port and another device, the port LED turns amber while the switch establishes a link. This process takes about 30 seconds, and then the LED turns green. If the LED turns off, the target device might not be turned on, there might be a cable problem, or there might be a problem with the adapter installed in the target device. See the [“In Case of Difficulty” section on page 26](#) for information about online assistance.

## In Case of Difficulty

If you experience difficulty, help is available in this section and also on Cisco.com. This section includes Express Setup troubleshooting, how to reset the switch, how to access help online, and where to find more information.

## Troubleshooting Express Setup

If Express Setup does not run, or if the Express Setup page does not appear in your browser:

---

Did you verify that POST ran successfully before starting Express Setup?

If not, make sure that only the SYST and STAT LEDs are green before you press the Mode button to enter the Express Setup mode.

POST errors are usually fatal. Contact your Cisco technical support representative if your switch fails POST.

Did you press the Mode button while the switch was still running POST?

If yes, wait until POST completes. Power cycle the switch. Wait until POST completes. Confirm that the SYST and STAT LEDs are green. Press the Mode button to enter Express Setup mode.

---

---

Did you try to continue without confirming that the switch was in Express Setup mode?	Verify that all LEDs above the Mode button are green. (The RPS LED is off.) If necessary, press the Mode button to enter Express Setup mode.
Does your PC have a static IP address?	If yes, before connecting to the switch, change your PC settings to temporarily use DHCP.
Did you connect a crossover cable instead of a straight-through Ethernet cable between a switch port and the Ethernet port of the PC?	If yes, connect a straight-through cable to an Ethernet port on the switch and the PC. Wait 30 seconds before you enter <b>10.0.0.1</b> in the browser.
Did you connect the Ethernet cable to the console port instead of to a 10/100 or 10/100/1000 Ethernet port on the switch?	If yes, disconnect the cable from the console port. Then connect the cable to an Ethernet port on the switch and the PC. Wait 30 seconds before you enter <b>10.0.0.1</b> in the browser.  <b>Note</b> The console port is outlined in blue, and the Ethernet port is outlined in yellow.
Did you wait 30 seconds after you connected the switch and the PC before you entered the IP address in your browser?	If not, wait 30 seconds, re-enter <b>10.0.0.1</b> in the browser, and press <b>Enter</b> .
Did you enter the wrong address in the browser, or is there an error message?	If yes, re-enter <b>10.0.0.1</b> in the browser, and press <b>Enter</b> .

---

## Resetting the Switch

Follow these steps to return your switch to the factory default settings. These are reasons why you might want to reset the switch:

- You installed the switch in your network and cannot connect to it because you assigned the wrong IP address.
- You want to clear all configurations from the switch and assign a new IP address.
- You want to reset the password on the switch.

**Caution**

---

Resetting the switch deletes the configuration and reboots the switch.

---

To reset the switch:

Press and hold the Mode button. The switch LEDs begin blinking after about 3 seconds. Continue holding down the Mode button. The LEDs stop blinking after 7 more seconds, and then the switch reboots.

The switch now behaves like an unconfigured switch. You can enter the switch IP information by using Express Setup as described in the [“Running Express Setup” section on page 4](#).

## Accessing Help Online

First look for a solution to your problem in the troubleshooting section of the switch hardware installation guide or the switch software configuration guide on Cisco.com. You can also access the Cisco Technical Support and Documentation website for a list of known hardware problems and extensive troubleshooting documentation.

## For More Information

For more information about the switch, see these documents on Cisco.com:

- *Catalyst 2960-S Switch Hardware Installation Guide*
- *Regulatory Compliance and Safety Information for the Catalyst 2960 and 2960-S Switches*
- *Release Notes for the Catalyst 2960-S Switch*
- *Catalyst 2960 and 2960-S Switch Software Configuration Guide*
- *Catalyst 2960 and 2960-S Switch Command Reference*
- *Catalyst 3750, 3560, 2975, 2960, and 2960-S Switch System Message Guide*
- Device Manager online help (available on the switch)
- *Cisco Small Form-Factor Pluggable Modules Installation Notes*

## Obtaining Documentation and Submitting a Service Request

For information on obtaining documentation, submitting a service request, and gathering additional information, see the monthly *What's New in Cisco Product Documentation*, which also lists all new and revised Cisco technical documentation, at:

<http://www.cisco.com/en/US/docs/general/whatsnew/whatsnew.html>

Subscribe to the *What's New in Cisco Product Documentation* as a Really Simple Syndication (RSS) feed and set content to be delivered directly to your desktop using a reader application. The RSS feeds are a free service and Cisco currently supports RSS version 2.0.

Cisco and the Cisco logo are trademarks or registered trademarks of Cisco and/or its affiliates in the U.S. and other countries. To view a list of Cisco trademarks, go to this URL: [www.cisco.com/go/trademarks](http://www.cisco.com/go/trademarks). Third-party trademarks mentioned are the property of their respective owners. The use of the word partner does not imply a partnership relationship between Cisco and any other company. (1110R)

Any Internet Protocol (IP) addresses used in this document are not intended to be actual addresses. Any examples, command display output, and figures included in the document are shown for illustrative purposes only. Any use of actual IP addresses in illustrative content is unintentional and coincidental.

© 2010-2012 Cisco Systems, Inc. All rights reserved.

