

55EJ5G

ENGLISH Installation Guide

Please read this manual carefully before operating your set and retain it for future reference.

FRANÇAIS Guide d'installation

Veillez lire ce manuel attentivement avant d'utiliser l'appareil et conservez-le pour pouvoir vous y reporter ultérieurement.

ESPAÑOL Guía de instalación

Lea atentamente este manual antes de poner en marcha el equipo y consérvelo para futuras consultas.



A-1

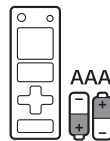

A-2



A-3



A-4

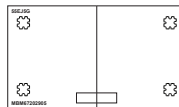

A-5





A-6



A-7

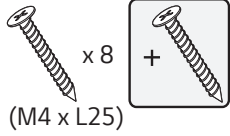

A-8

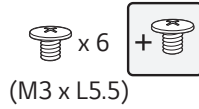

A-9

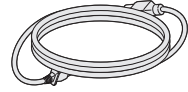

A-10

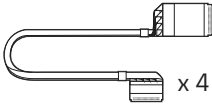

A-11

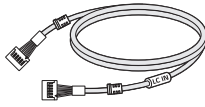

A-12

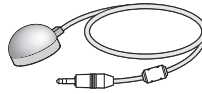

A-13

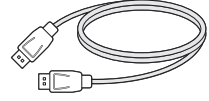

A-14

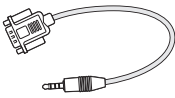

A-15



A-16

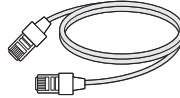

⊕ Depending upon country / Selon le pays / Según el país

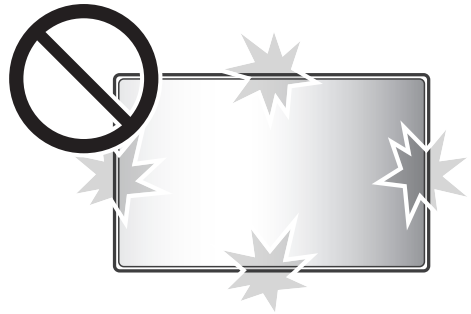
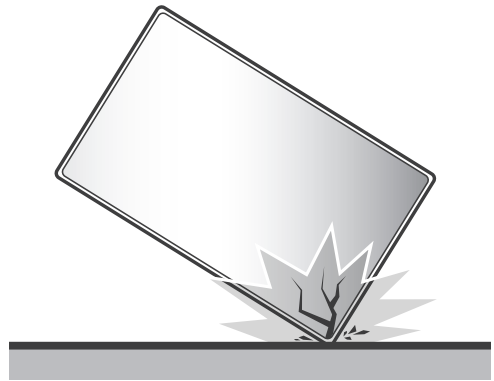
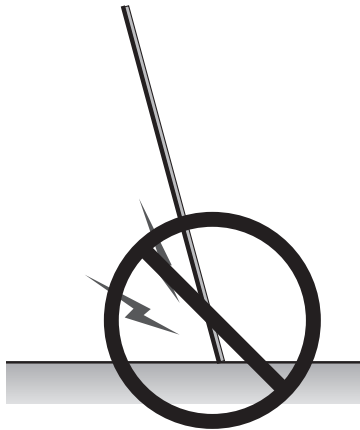

- ▶ www.lg.com/id-manual
- ▶ SuperSign : <http://partner.lge.com>

ENGLISH

You can download more detailed information on our website by searching the model number provided on the cover page.

FRANÇAIS

Vous pouvez télécharger des informations plus détaillées sur notre site Web en faisant une recherche à l'aide du numéro de modèle indiqué sur la page de couverture.

ESPAÑOL

Busque en nuestro sitio web el número de modelo que aparece en la portada y descargue información más detallada.

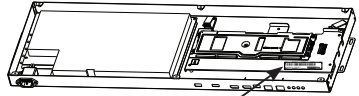
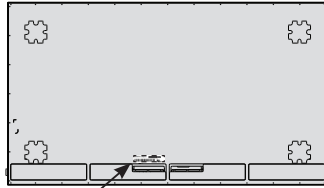
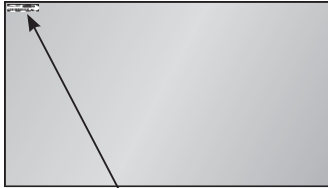

=

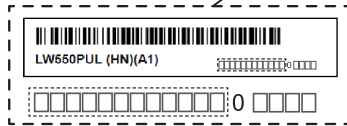



ENGLISH

Dimensions (Width x Height x Depth) / Weight	Display	1 220.3 mm x 696.8 mm x 4.9 mm / 6.5 kg (48.0 inches x 27.4 inches x 0.1 inch / 14.3 lbs)
	Signage Box	782.8 mm x 238.4 mm x 34.7 mm / 3.4 kg (30.8 inches x 9.3 inches x 1.3 inches / 7.4 lbs)

FRANÇAIS

Dimensions (largeur x hauteur x profondeur) / Poids	Affichage	1 220,3 mm x 696,8 mm x 4,9 mm / 6,5 kg (48,0 po x 27,4 po x 0,1 po / 14,3 lb)
	Boîtier d'affichage	782,8 mm x 238,4 mm x 34,7 mm / 3,4 kg (30,8 po x 9,3 po x 1,3 po / 7,4 lb)

ESPAÑOL

Dimensiones (ancho x alto x profundidad) / Peso	Pantalla	1 220,3 mm x 696,8 mm x 4,9 mm / 6,5 kg
	Decodificador	782,8 mm x 238,4 mm x 34,7 mm / 3,4 kg
Alimentación	CA 100-240 V ~ 50/60 Hz 3,7 A	

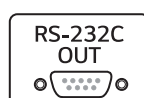
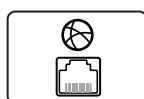
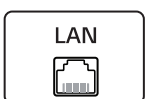
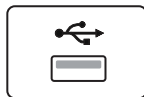
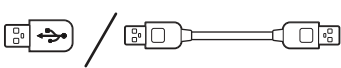
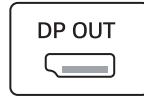
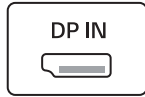



1

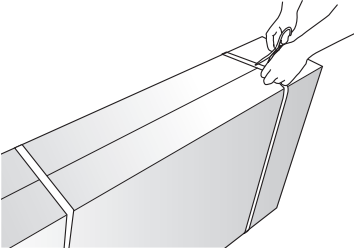

2

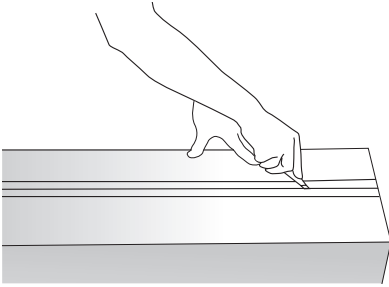

3

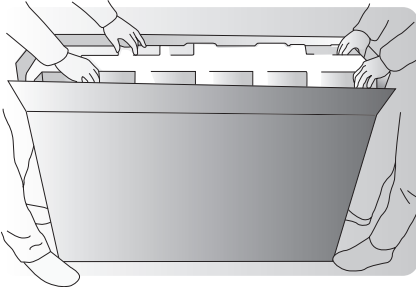

4

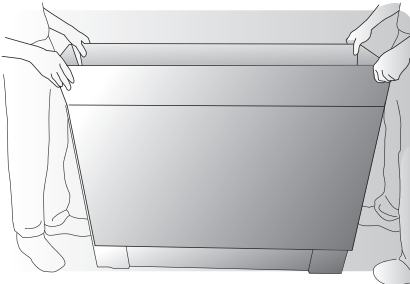

5

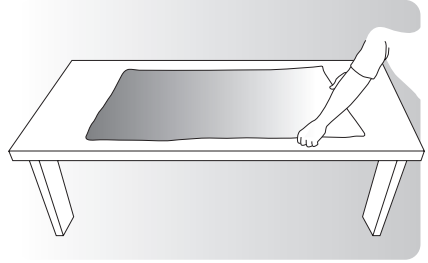

6

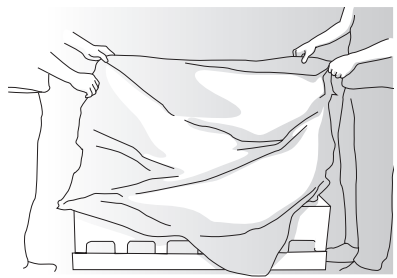

7

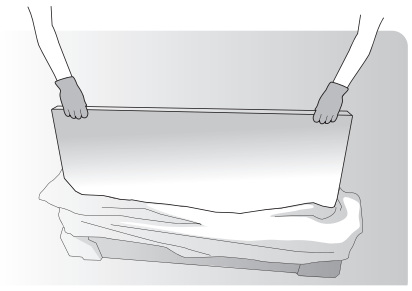

8

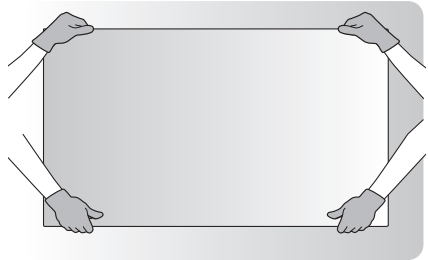

9

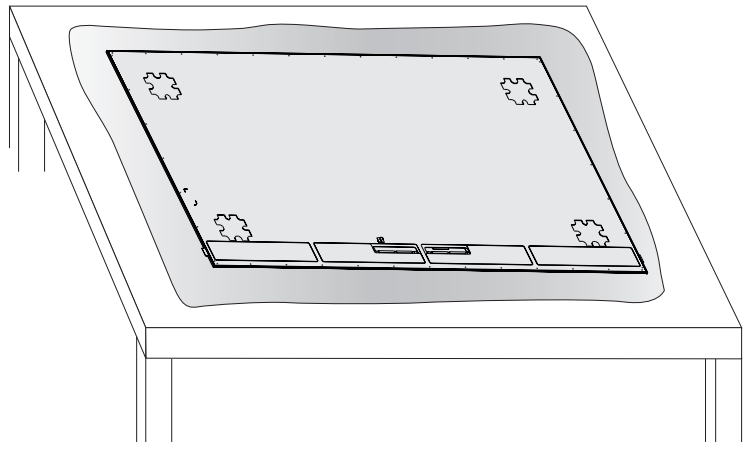

10

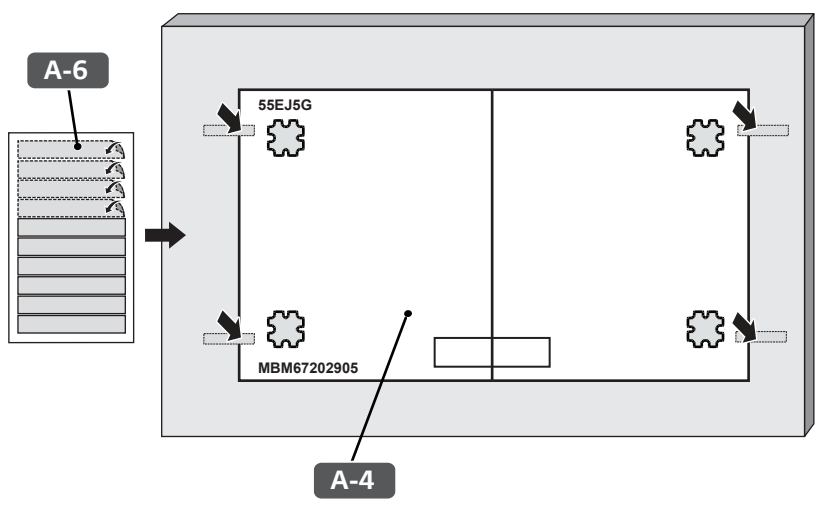

11

 : (M4 x L25)

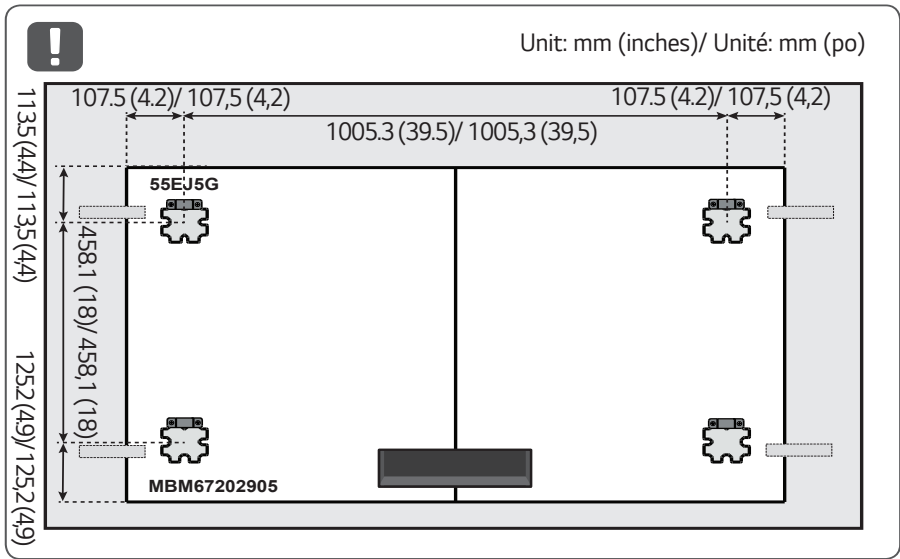
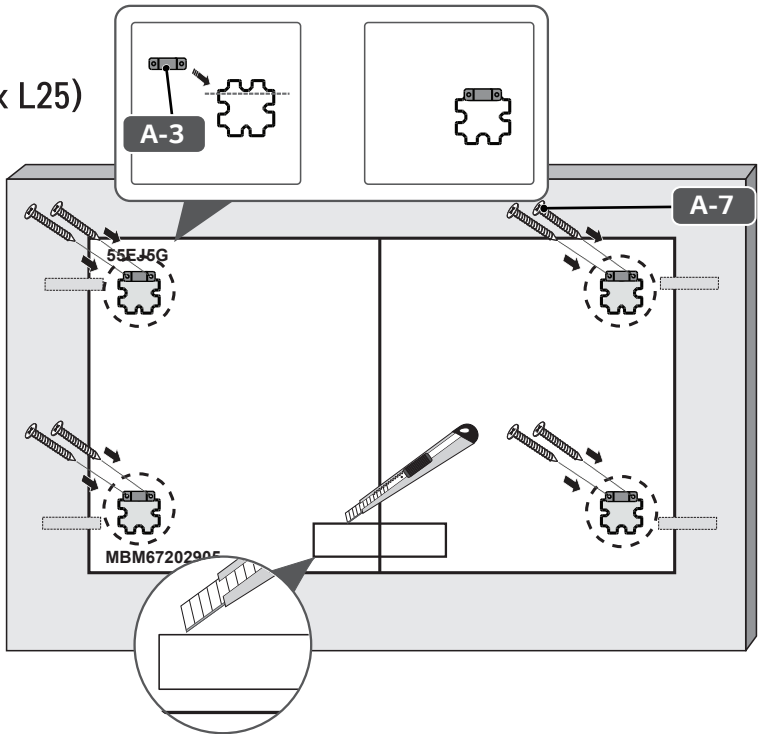

12

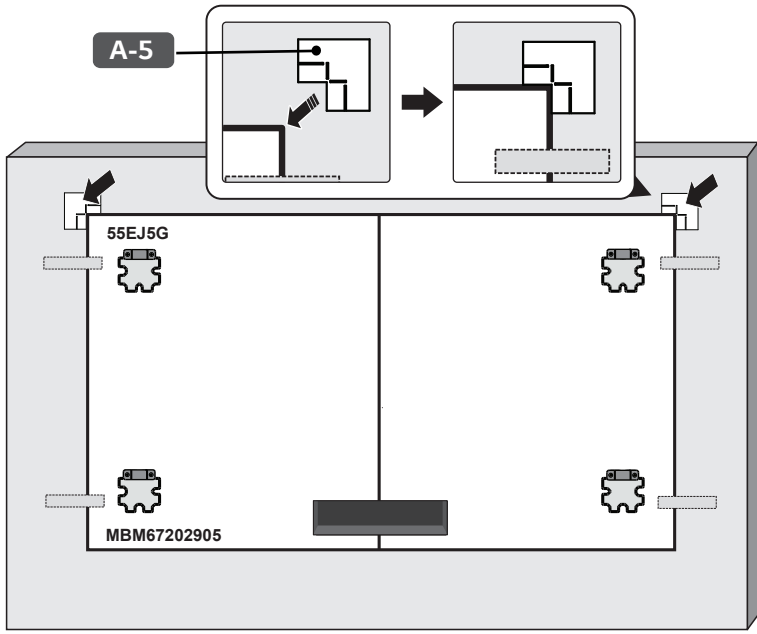

13

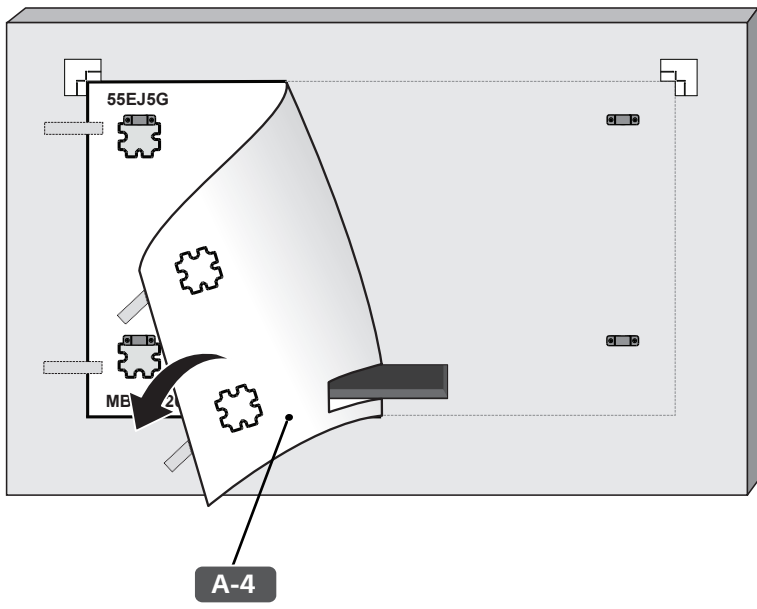

14

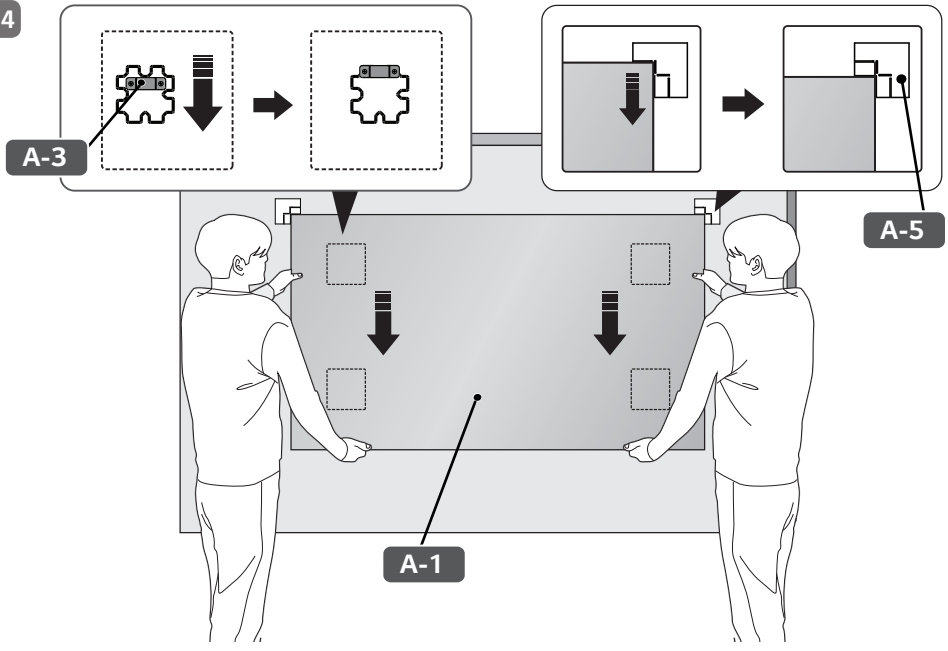

15

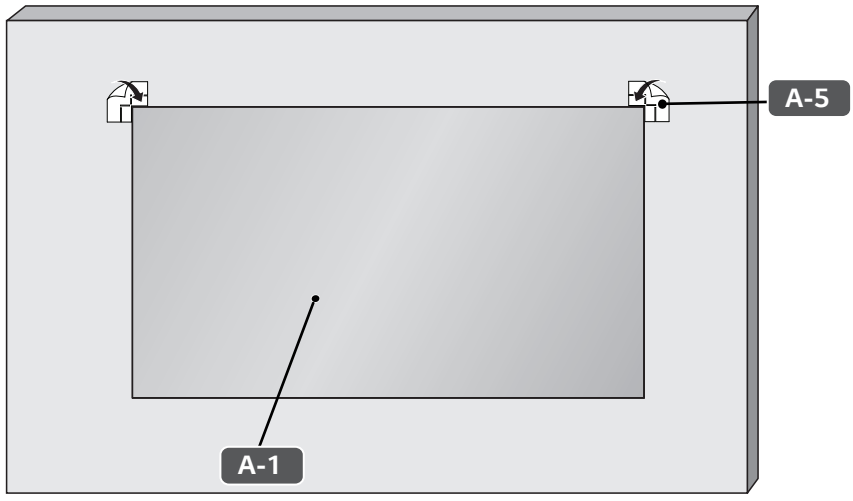

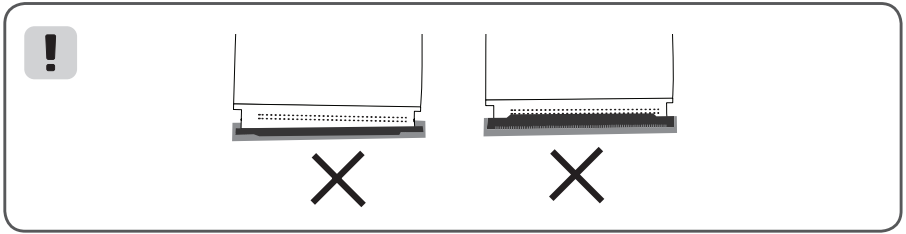
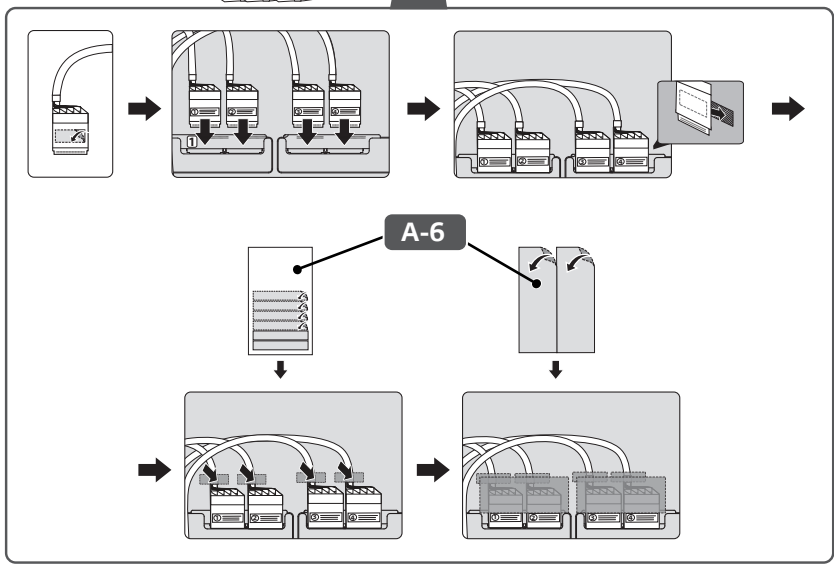
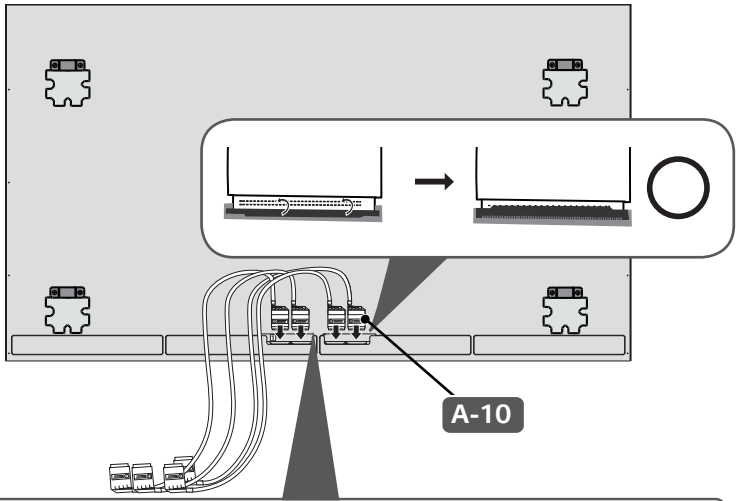

17

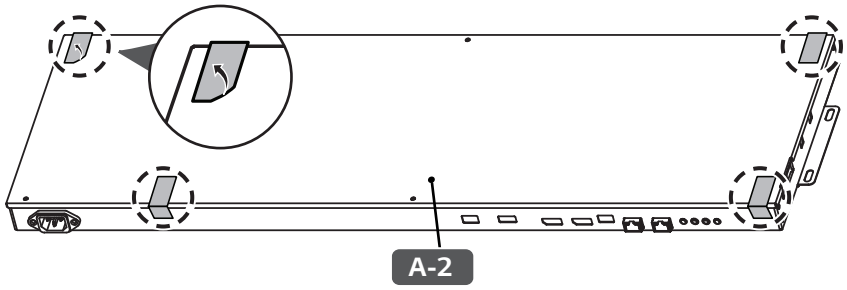

18

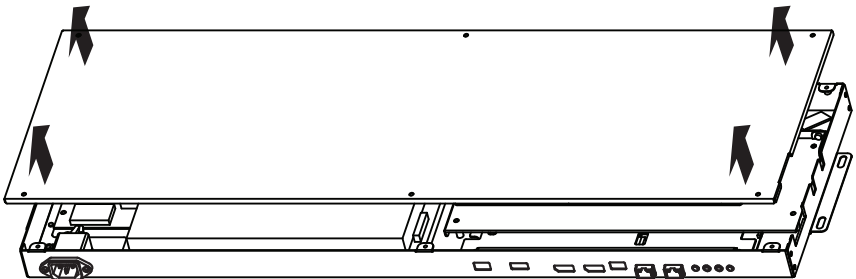

19-1

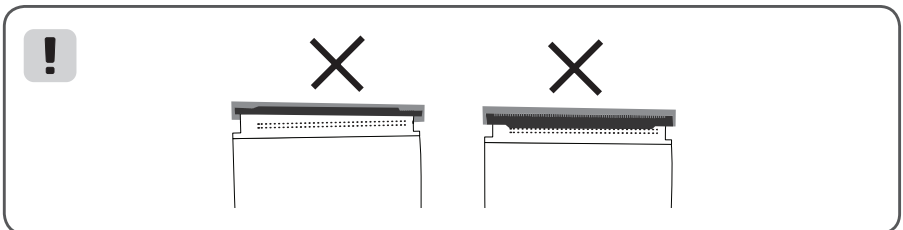
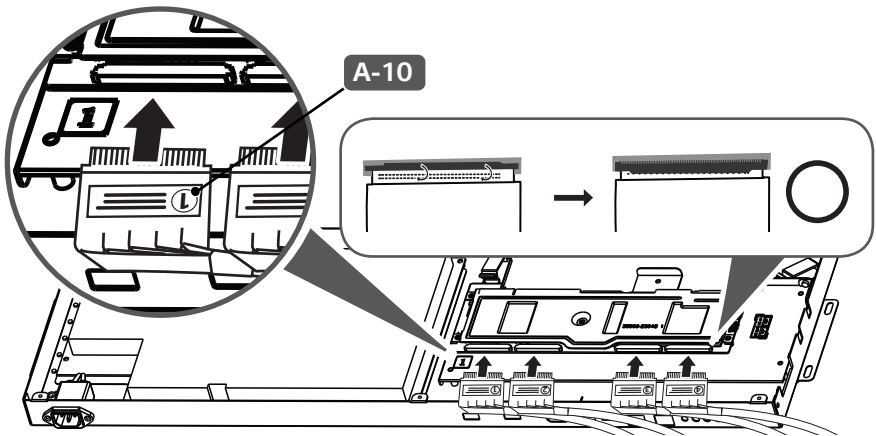

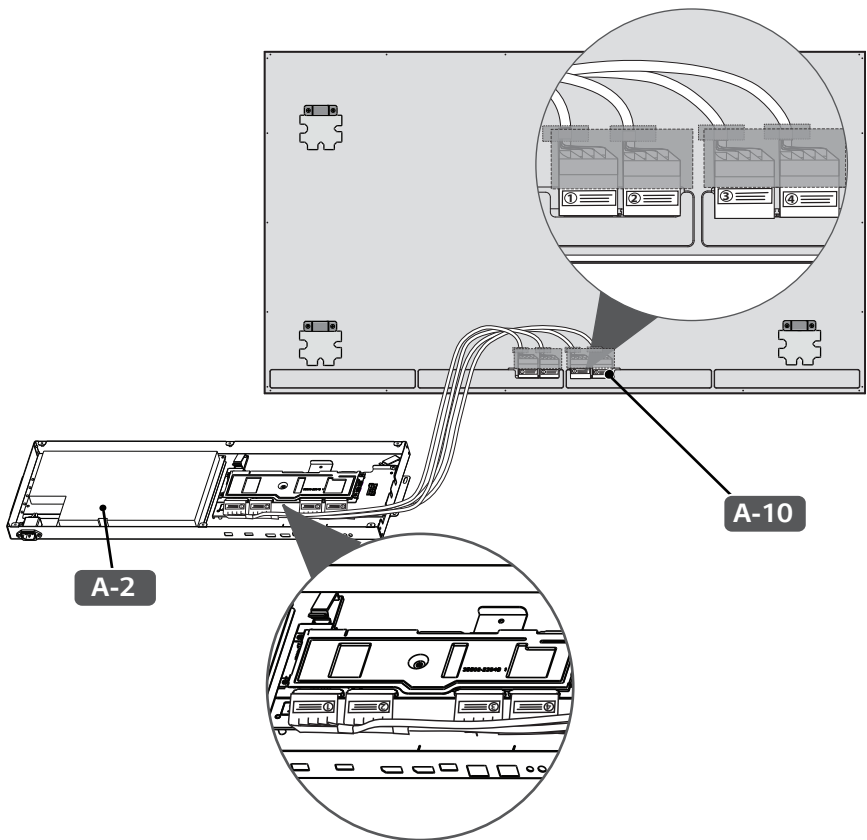

1 = 1



A-2

A-11

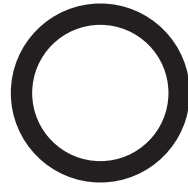
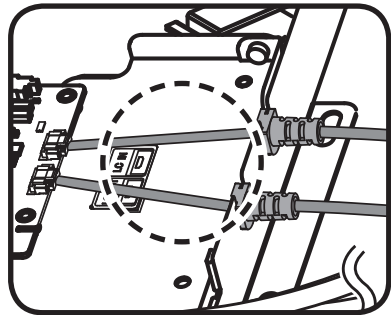
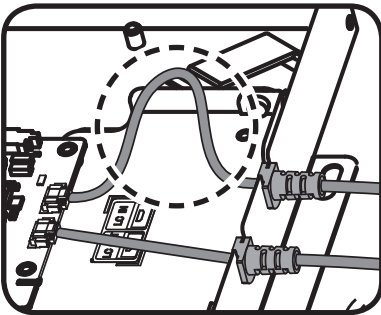
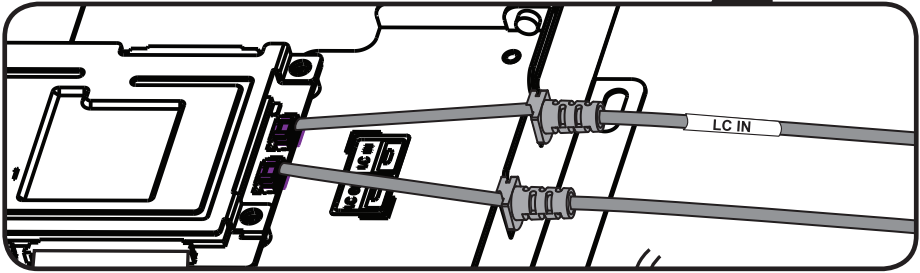
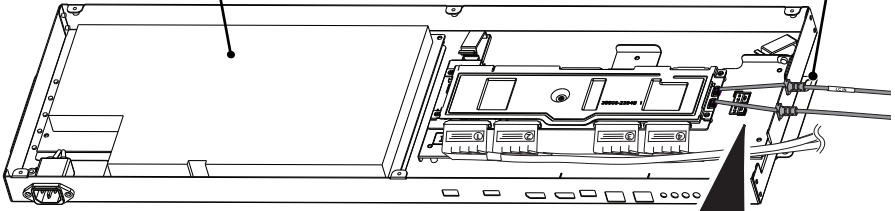

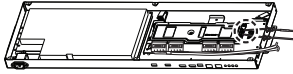

Landscape/
Paysage/
Horizontal

4 x 4

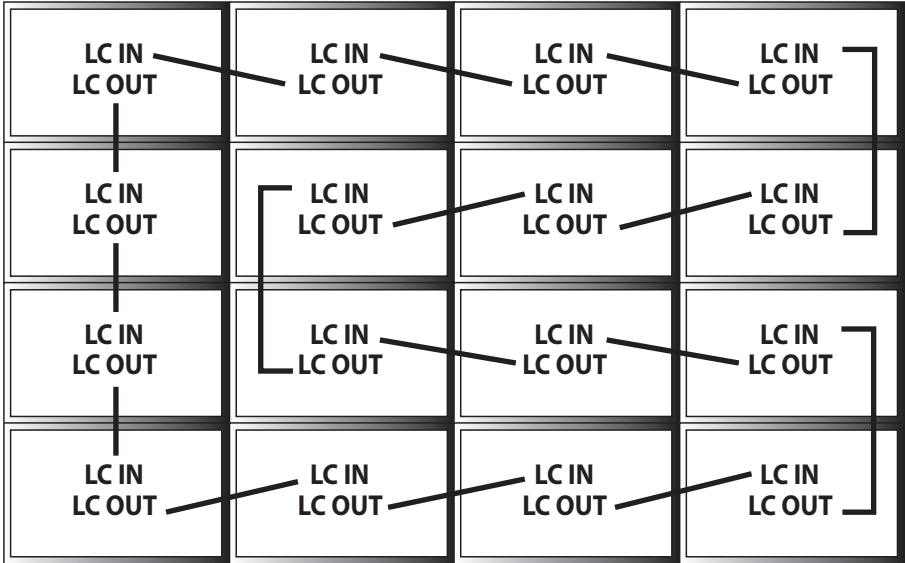

3 x 5

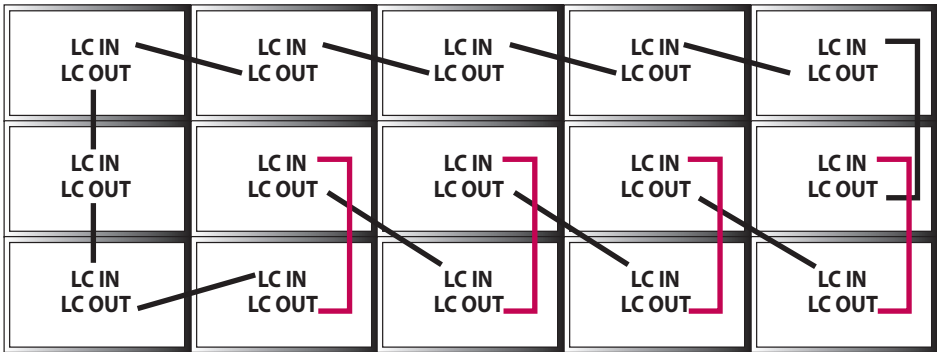

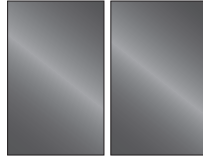
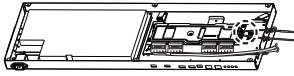

Portrait/
Portrait/
Vertical

4 x 4

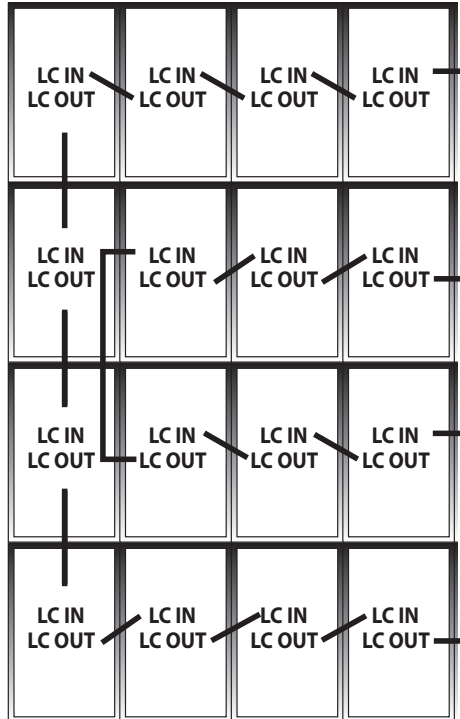

3 x 5

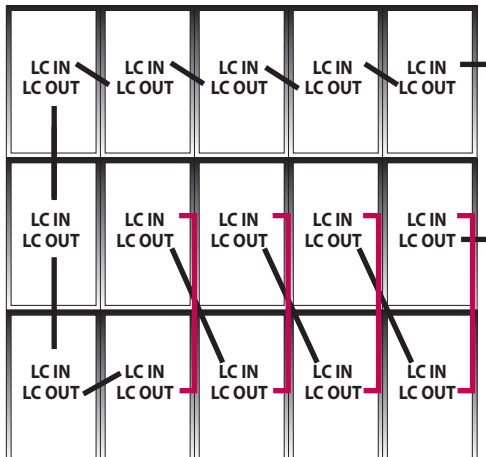

20

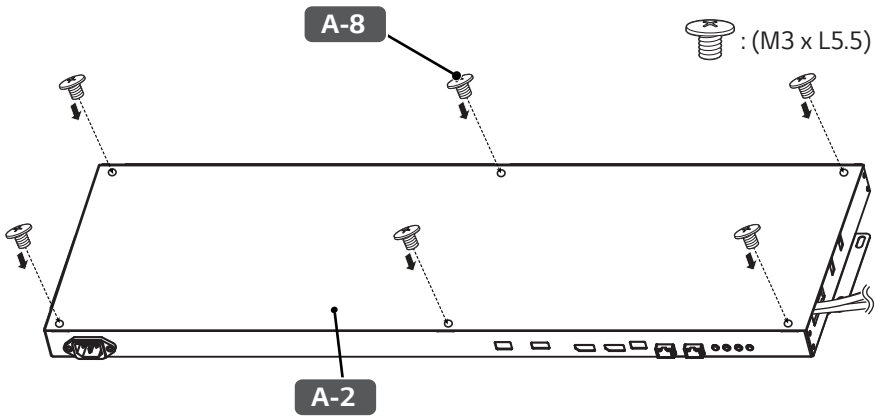

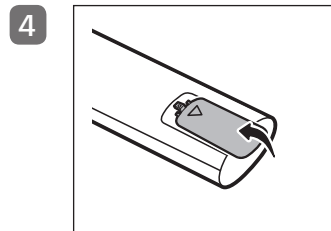
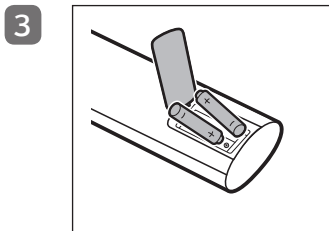
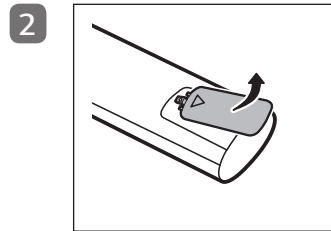
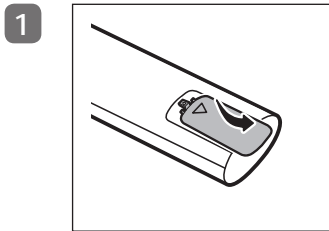
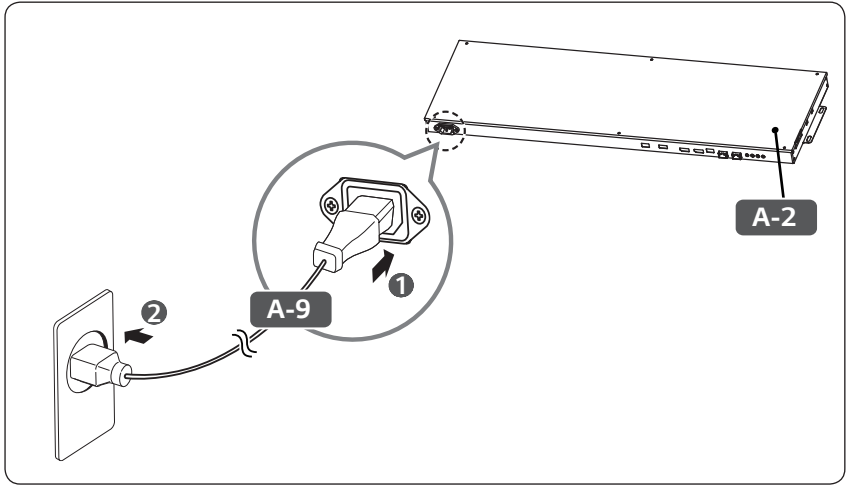

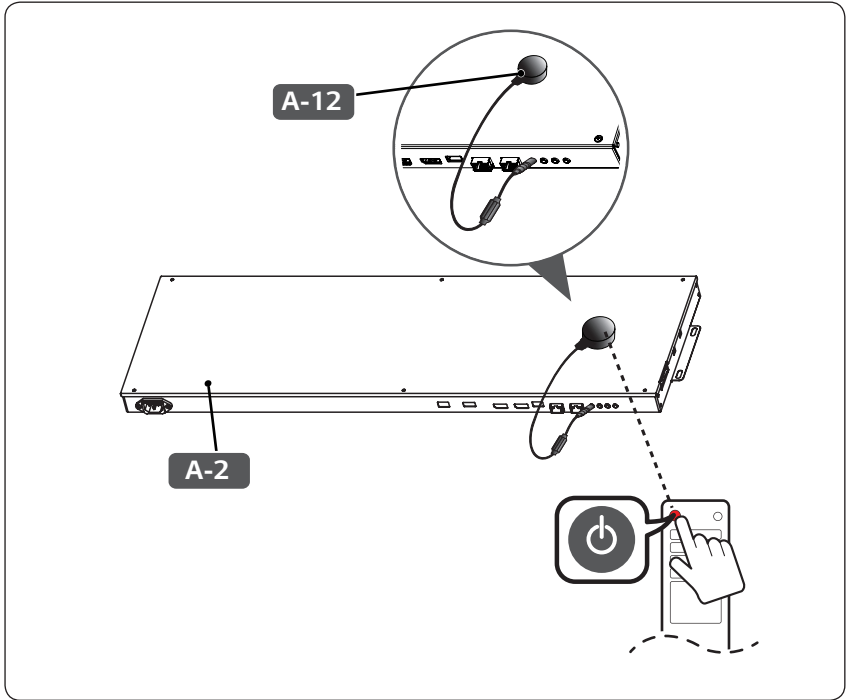



* M F L 7 1 7 9 2 7 0 2 *

(2207-REV01)

