

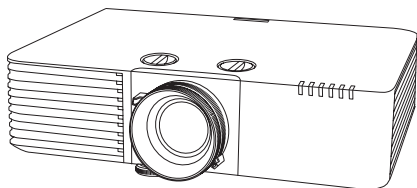

# Multimedia Projector

**EB-L735U**    **EB-L630SU**  
**EB-L730U**    **EB-L630U**  
**EB-L720U**    **EB-L530U**  
**EB-L635SU**   **EB-L520U**



<b>EN</b>	Quick Reference	<b>RO</b>	Ghid informativ
<b>DE</b>	Kurzübersicht	<b>EL</b>	Γρήγορη αναφορά
<b>FR</b>	Référence rapide	<b>TR</b>	Hızlı Referans
<b>IT</b>	Riferimento rapido	<b>SL</b>	Hitre informacije
<b>ES</b>	Referencia rápida	<b>CA</b>	Referència ràpida
<b>PT</b>	Referência Rápida	<b>RU</b>	Краткое руководство
<b>NL</b>	Beknopte handleiding	<b>UK</b>	Короткий довідник
<b>DA</b>	Lynvejledning	<b>KK</b>	Қысқаша анықтама
<b>FI</b>	Pikaopas	<b>AR</b>	مرجع سريع
<b>NO</b>	Hurtigreferanse	<b>ZHS</b>	快速参考
<b>SV</b>	Snabbreferens	<b>ZHT</b>	快速參考
<b>CS</b>	Rychlá reference	<b>KO</b>	빠른 참조
<b>HU</b>	Gyors útmutató	<b>ID</b>	Rujukan Cepat
<b>PL</b>	Skrócona instrukcja obsługi		

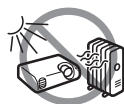

## ■ Unpacking

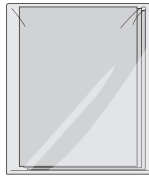
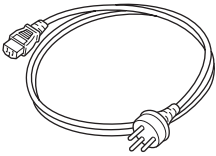
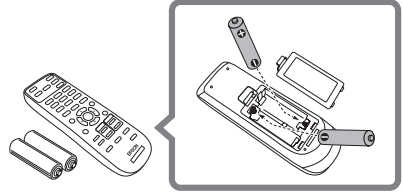
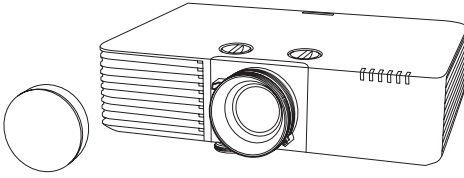

**EB-L735U/EB-L730U/EB-L635SU/  
EB-L630SU/EB-L630U/EB-L530U**

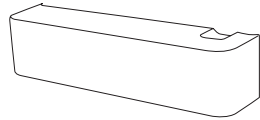

## ■ Remote Control Operating Range

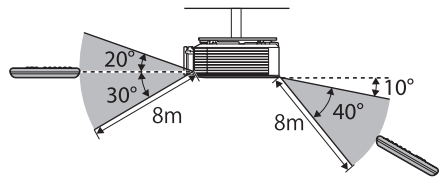
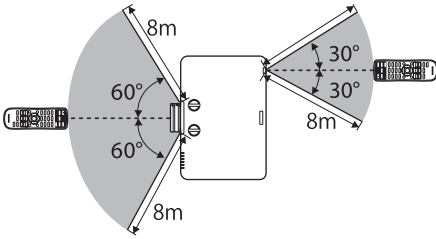

# ■ Installing

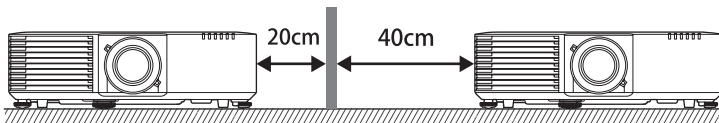
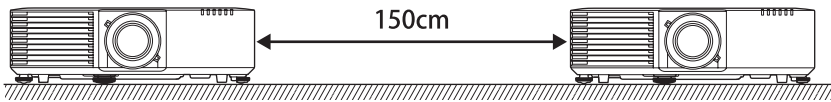
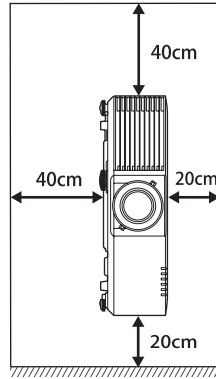
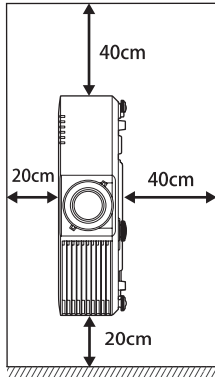
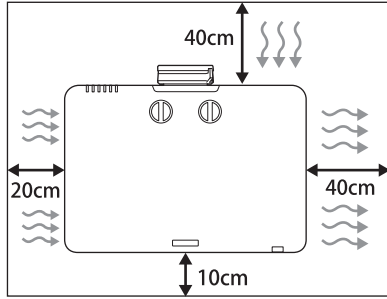

# ■ Turning On/Off the Projector

## Turning On

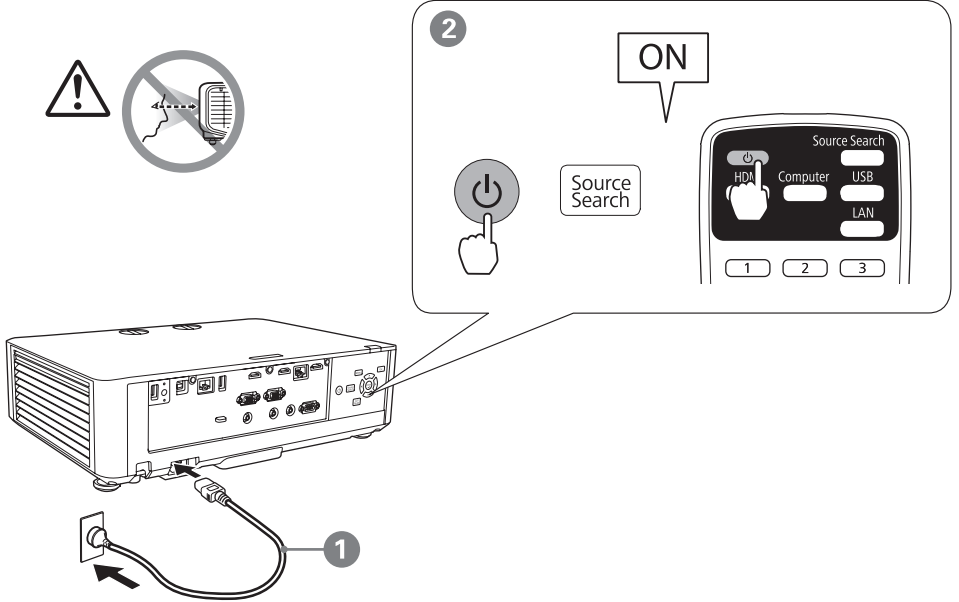

## Turning Off

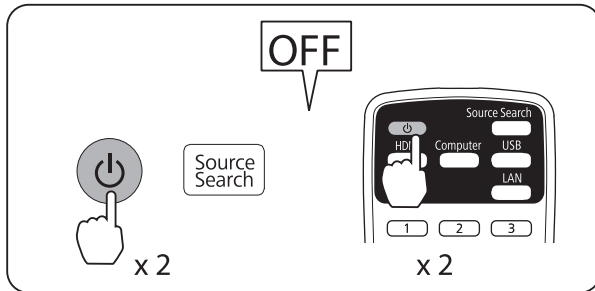

## ■ Adjusting the Projection Size (EB-L735U/EB-L730U/EB-L720U/EB-L630U/EB-L530U/ EB-L520U)

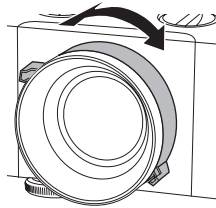
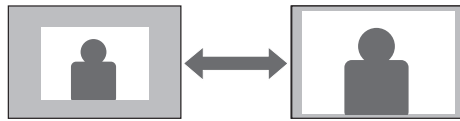

## ■ Adjusting the Focus

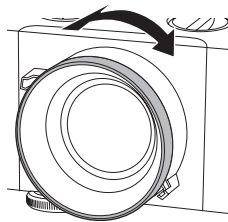
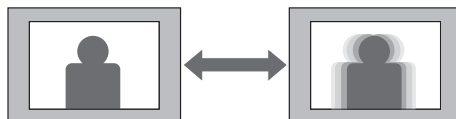

## Initial Setting

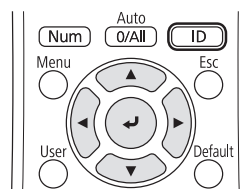
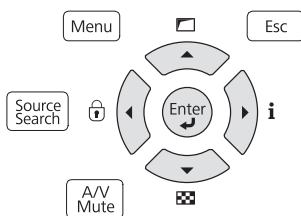

EN

The first time you turn on the projector, the setup wizard is displayed. Follow the on-screen instructions to make the initial settings, such as the projection direction and language, using the arrow and **←[Enter]** buttons on the control panel or remote control.

DE

Wenn Sie den Projektor das erste Mal einschalten, erscheint der Einstellungsassistent. Konfigurieren Sie anhand der Bildschirmanweisungen die Anfangseinstellungen, wie Projektionsrichtung und Sprache, mit den Pfeiltasten und der **←[Enter]**-Taste an Bedienfeld oder Fernbedienung.

FR

La première fois que vous allumez le projecteur, l'assistant de configuration s'affiche. Suivez les instructions à l'écran pour effectuer les réglages initiaux, comme le sens de projection et la langue, à l'aide des touches fléchées et **←[Enter]** du panneau de commande ou de la télécommande.

IT

La prima volta che si accende il proiettore, viene visualizzata la procedura guidata di configurazione. Seguire le istruzioni sullo schermo per effettuare le impostazioni iniziali, come la scelta della direzione di proiezione e della lingua, utilizzando i pulsanti freccia e **←[Enter]** sul pannello di controllo o sul telecomando.

ES

La primera vez que encienda el proyector, se mostrará el asistente de configuración. Siga las instrucciones que aparezcan en la pantalla para realizar la configuración inicial, como la dirección de proyección y el idioma, usando los botones de flecha y **←[Enter]** del panel de control o del mando a distancia.

PT











O assistente de configuração será exibido quando o projetor for ligado pela primeira vez. Siga as instruções apresentadas para configurar as definições iniciais, tais como a direção de projeção e o idioma, utilizando os botões direcionais e **←[Enter]** no painel de controlo ou no controlo remoto.

NL

Als u de projector voor het eerst inschakelt, verschijnt de installatiewizard. Volg de instructies op het scherm om de begininstellingen, zoals de projectierichting en taal, op te geven met de pijl en de knoppen **←[Enter]** op het bedieningspaneel of de afstandsbediening.

DA

Første gang du tænder projektoren, vises opsætningsvejledningen. Følg instruktionerne på skærmen for, at konfigurere de første indstillinger, såsom projektningsretning og sprog. Dette gøres med piletasterne og **←[Enter]**-tasten på betjeningspanelet eller fjernbetjeningen.

FI	Kun kytket projektorin päälle ensimmäistä kertaa, ohjattu asetus tulee näkyviin. Tee alkuasetukset näytön ohjeiden mukaisesti, kuten projisoinnin suunta ja kieli, käyttäen ohjauspaneelin tai kaukosäätimen nuoli- ja  [Enter]-painikkeita.
NO	Første gang du slår på projektoren, vises oppsettsveiviseren. Følg instruksjonene på skjermen for å stille inn de første innstillingene, som projiseringsretning og språk, med pilen og  [Enter]-knappene på kontrollpanelet eller fjernkontrollen.
SV	Den första gången du startar projektorn visas konfigurationsguiden. Följ instruktionerna på skärmen för att göra de initiala inställningarna, sådana som projiceringsriktning och språk, genom att använda pilknapparna och  [Enter]-knappen på kontrollpanelen eller fjärrkontrollen.
CS	Při prvním zapnutí projektoru se zobrazí průvodce nastavením. Postupujte podle zobrazených pokynů a proveďte úvodní nastavení, jako je směr promítání nebo jazyk, pomocí tlačítek se šipkami a tlačítka  [Enter] na ovládacím panelu nebo dálkovém ovladači.
HU	Amikor először kapcsolja be a kivetítőt, a beállításai varázsló jelenik meg. Kövesse a képernyőn megjelenő utasításokat a kezdeti beállítások, például a vetítési irány és a nyelv megadásához, a nyíl gombok és az  [Enter] gombok használatával a kezelőpanelen vagy a távvezérlőn.
PL	Po pierwszym włączeniu projektora, wyświetlany jest kreator ustawień. Wykonaj instrukcje ekranowe w celu wykonania ustawień początkowych, takich jak kierunek projekcji i język, używając strzałek i przycisku  [Enter] na panelu sterowania lub na pilocie.
RO	La prima pornire a proiectorului, se afișează expertul de configurare. Urmați instrucțiunile de pe ecran pentru a realiza setările inițiale, cum ar fi direcția și limba proiectiei, cu ajutorul butoanelor cu săgeți și a butonului  [Enter] de pe panoul de comandă sau de pe telecomandă.
EL	Την πρώτη φορά που θέτετε τον προβολέα σε λειτουργία εμφανίζεται ο οδηγός εγκατάστασης. Ακολουθήστε τις οδηγίες στην οθόνη για να κάνετε τις αρχικές ρυθμίσεις, όπως η κατεύθυνση προβολής και η γλώσσα, χρησιμοποιώντας τα βέλη και το κουμπί  [Enter] στον πίνακα ελέγχου ή το τηλεχειριστήριο.
TR	Projektörü ilk açtığıınızda kurulum sihirbazı görüntülenir. Yansıtma yönü ve dili gibi ilk ayarları yapmak için kontrol paneli veya uzaktan kumanda üzerindeki ok ve  [Enter] düğmelerini kullanarak ekrandaki talimatları izleyin.
SL	Ob prvem vklopu projektorja se prikaže čarovnik za namestitvev. Sledite navodilom na zaslonu, da opravite začetne nastavitve, kot sta usmerjenost projekcije in jezik, pri tem pa uporabite pušične gumbe in gumb  [Enter] na nadzorni plošči ali daljinskem upravljalniku.
CA	La primera vegada que s'encen el projector, apareix l'assistent de configuració. Seguiu les instruccions en pantalla per definir els paràmetres inicials, com ara la direcció de projecció i l'idioma, amb les fletxes i el botó  [Enter] del panell de control o del comandament a distància.

RU	При первом включении проектора отображается мастер настройки. Следуйте экранным инструкциям для выполнения начальных настроек, таких как направление проецирования и язык. Используйте кнопки со стрелками и ←[Enter] на панели управления или пульте ДУ.
UK	При першому увімкненні проектра відображається майстер налаштування. Дотримуйтесь інструкцій на екрані, щоб виконати первинні налаштування, такі як напрям та мова, за допомогою кнопок зі стрілками та кнопки ←[Enter] на панелі керування або на пульті дистанційного керування
KK	Проекторды алғаш рет іске қосқанда, орнату шебері көрсетіледі. Басқару тақтасындағы немесе қашықтан басқару құралындағы көрсеткі және ←[Енгізу] түймелерін пайдалану арқылы проекциялау бағыты және тілі сияқты бастапқы параметрлерді орнату үшін, экрандағы нұсқауларды орындаңыз.
AR	يظهر معالج الإعداد عند تشغيل جهاز العرض للمرة الأولى. اتبع التعليمات المعروضة على الشاشة لضبط الإعدادات الأولية: كاتجاه العرض واللغة ، باستخدام أزرار الأسهم والزر ← [Enter] في لوحة التحكم أو وحدة التحكم عن بُعد.
ZHS	首次启动投影机时，会显示安装向导。请按照屏幕上的说明使用控制面板或遥控器上的 ←[Enter] 按钮进行初始设置，比如投影方向和语言。
ZHT	第一次開啟投影機時，設定精靈會顯示。依照螢幕上的指示，使用操作面板或遙控器上的 ←[Enter] 按鈕進行初始設定，如投影方向和語言。
KO	프로젝터를 처음 켤 경우 시작 마법사가 표시됩니다. 화면상 지침을 따라 조절 패널 또는 리모콘의 화살표 및 ←[Enter] 버튼을 사용하여 투사 방향 및 언어 등 초기 설정을 지정하십시오.
ID	Saat pertama kali Anda menghidupkan proyektor, wizard konfigurasi akan ditampilkan. Ikuti petunjuk di layar untuk melakukan pengaturan awal, misalnya arah proyeksi dan bahasa, dengan menggunakan tombol anak panah dan ←[Enter] pada panel kontrol atau remote control.



## ■ Adjusting the Position of the Image (Lens Shift)

(EB-L735U/EB-L730U/EB-L635SU/EB-L630SU/EB-L630U/  
EB-L530U)

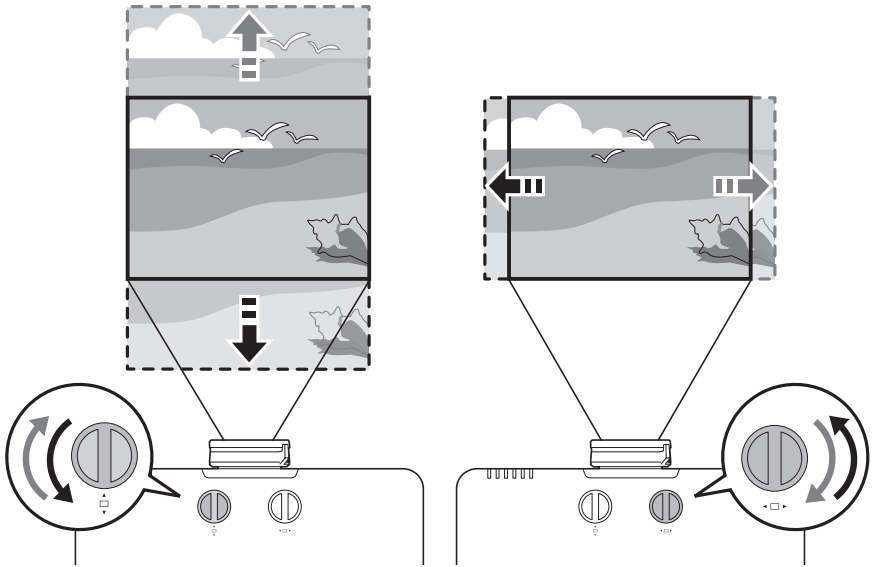

### Lens Shift Adjustment Range

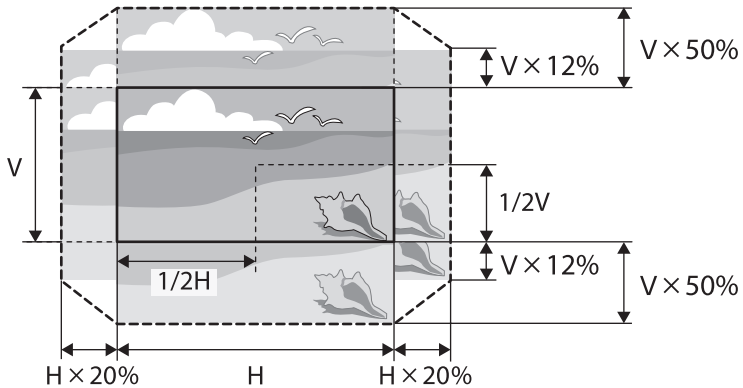

## ■ Connecting a Device

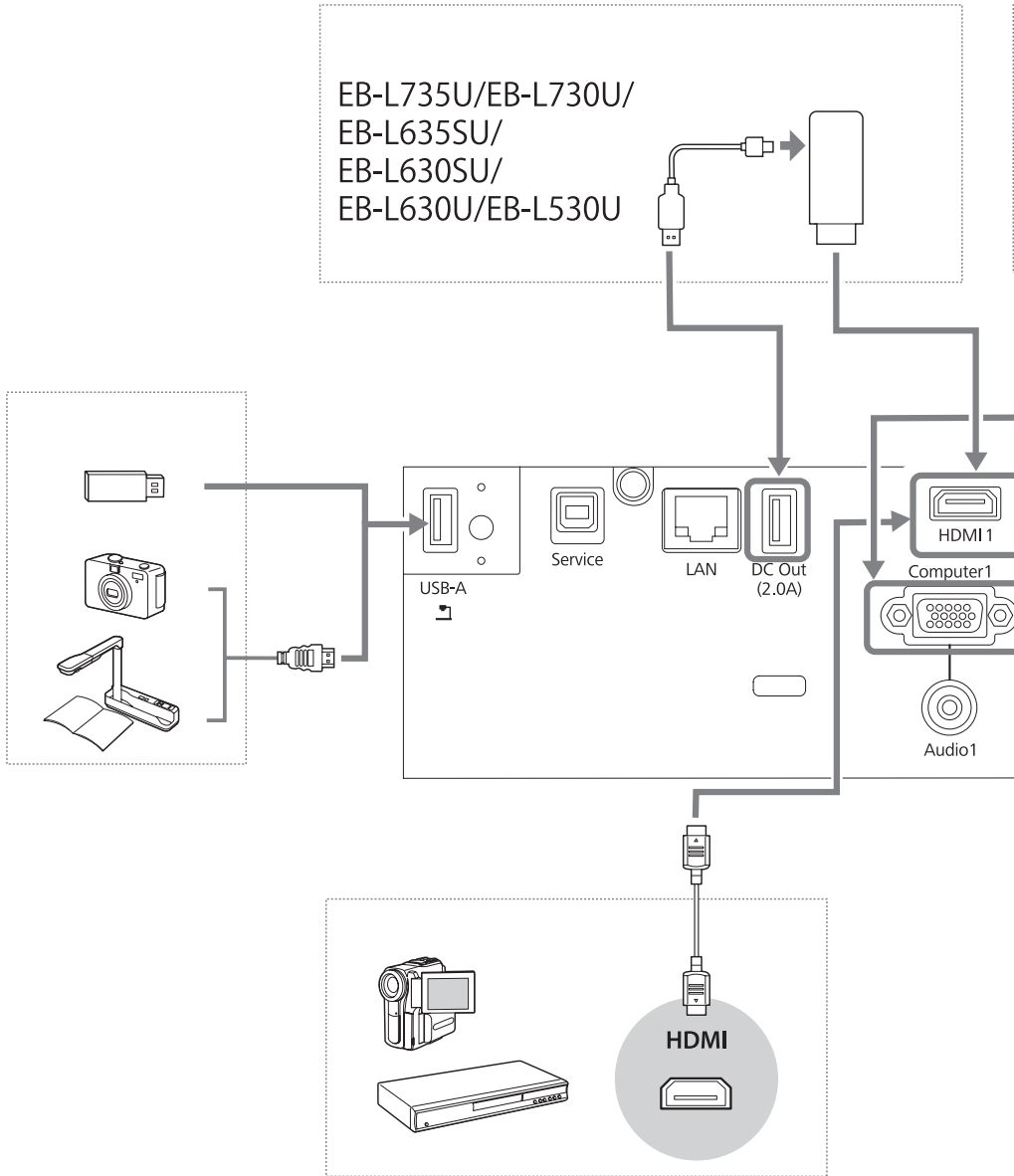

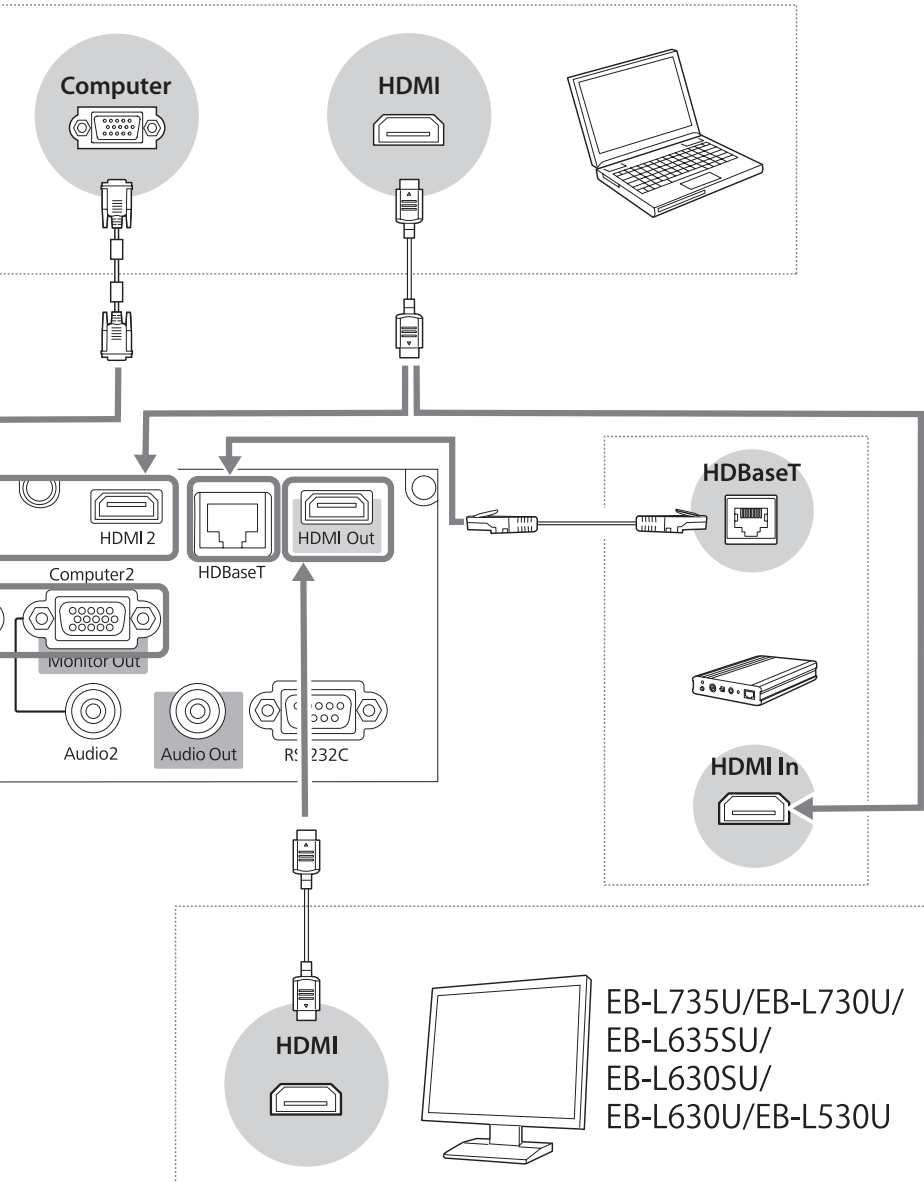

## ■ Installing the Wireless LAN Module

(EB-L720U/EB-L520U)

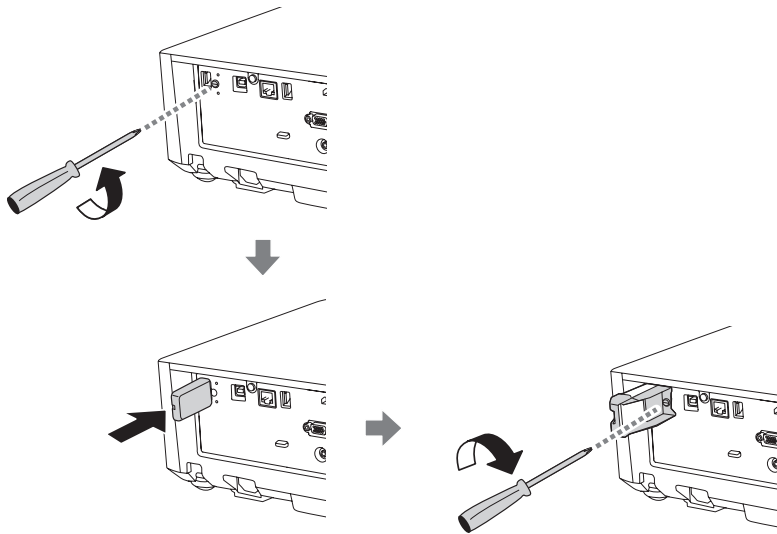

## ■ Attaching the Cable Cover

(EB-L735U/EB-L730U/EB-L635SU/EB-L630SU/EB-L630U/  
EB-L530U)

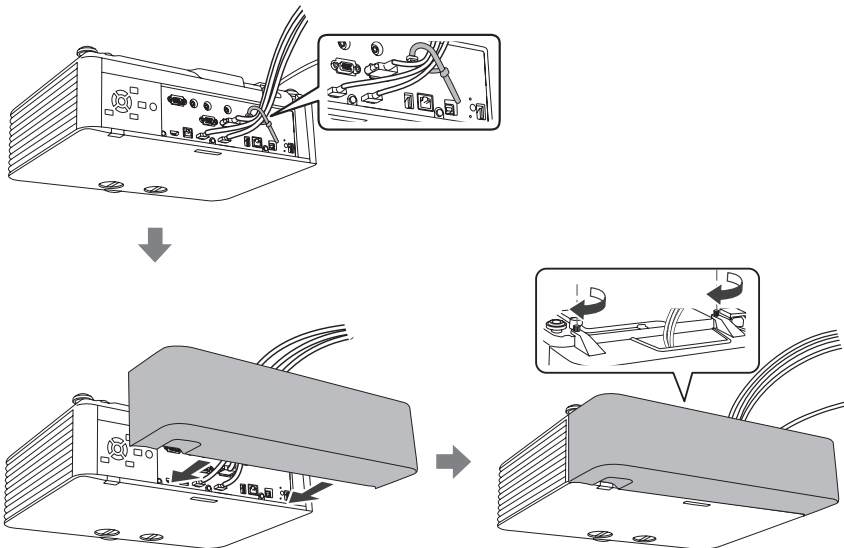

# ■ Projection Distance

## EB-L735U/EB-L730U/EB-L635SU/EB-L630SU/EB-L630U/EB-L530U

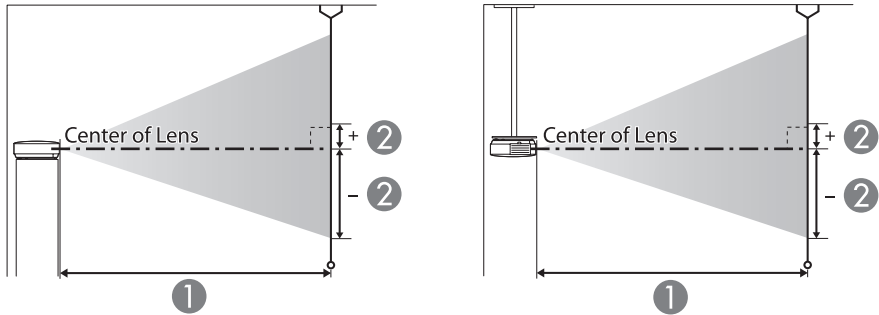

### WUXGA (EB-L735U/EB-L730U/EB-L630U/EB-L530U)

Unit : cm

16:10 screen size		①	②
Inches (Diagonally)	Width × Height	Minimum (Wide) to Maximum (Tele)	Vertical Lens Shift Bottom to Top
50"	108 × 67	144 - 235	-67 - 0
60"	129 × 81	174 - 283	-81 - 0
70"	151 × 94	204 - 331	-94 - 0
80"	172 × 108	233 - 378	-108 - 0
100"	215 × 135	292 - 474	-135 - 0
120"	258 × 162	351 - 569	-162 - 0
150"	323 × 202	440 - 713	-202 - 0
200"	431 × 269	588 - 951	-269 - 0
300"	646 × 404	884 - 1429	-404 - 0
500"	1077 × 673	1476 - 2384	-673 - 0

Unit : cm

4:3 screen size		①	②
Inches (Diagonally)	Width × Height	Minimum (Wide) to Maximum (Tele)	Vertical Lens Shift Bottom to Top
45"	91 × 69	147 - 240	-69 - 0
50"	102 × 76	164 - 267	-76 - 0
60"	122 × 91	197 - 321	-91 - 0
80"	163 × 122	264 - 429	-122 - 0
100"	203 × 152	331 - 537	-152 - 0
110"	224 × 168	365 - 591	-168 - 0
120"	244 × 183	398 - 645	-183 - 0
150"	305 × 229	499 - 807	-229 - 0
200"	406 × 305	666 - 1077	-305 - 0
300"	610 × 457	1001 - 1618	-457 - 0
440"	894 × 671	1470 - 2375	-671 - 0

Unit : cm

16:9 screen size		①	②
Inches (Diagonally)	Width × Height	Minimum (Wide) to Maximum (Tele)	Vertical Lens Shift Bottom to Top
49"	108 × 61	145 - 237	-64 - 3
50"	111 × 62	148 - 242	-66 - 3
60"	133 × 75	179 - 291	-79 - 4
80"	177 × 100	240 - 389	-105 - 6
100"	221 × 125	301 - 487	-131 - 7
110"	244 × 137	331 - 536	-145 - 8
120"	266 × 149	361 - 585	-158 - 8
150"	332 × 187	453 - 733	-197 - 10
200"	443 × 249	605 - 978	-263 - 14
300"	664 × 374	909 - 1469	-394 - 21
480"	1063 × 598	1456 - 2352	-631 - 33

Unit : cm

16:6 screen size		①	②
Inches (Diagonally)	Width × Height	Minimum (Wide) to Maximum (Tele)	Vertical Lens Shift Bottom to Top
46"	109 × 41	147 - 239	-55 - 14
50"	119 × 45	160 - 260	-59 - 15
60"	143 × 54	192 - 313	-71 - 18
70"	166 × 62	225 - 366	-83 - 21
80"	190 × 71	258 - 418	-95 - 24
100"	238 × 89	323 - 524	-119 - 30
120"	285 × 107	388 - 629	-143 - 36
150"	357 × 134	486 - 787	-178 - 45
200"	476 × 178	650 - 1051	-238 - 59
300"	713 × 268	976 - 1578	-357 - 89
452"	1075 × 403	1473 - 2379	-537 - 134

## • WUXGA (EB-L635SU/EB-L630SU)

Unit : cm

16:10 screen size		①	②
Inches (Diagonally)	Width × Height	Minimum (Wide) to Maximum (Tele)	Vertical Lens Shift Bottom to Top
50"	108 × 67	85 - 115	-67 - 0
60"	129 × 81	103 - 139	-81 - 0
80"	172 × 108	138 - 186	-108 - 0
90"	194 × 121	156 - 210	-121 - 0
100"	215 × 135	173 - 234	-135 - 0
148"	319 × 199	258 - 348	-199 - 0
150"	323 × 202	261*	-202 - 0
180"	388 × 242	314*	-242 - 0
200"	431 × 269	349*	-269 - 0

Unit : cm

4:3 screen size		①	②
Inches (Diagonally)	Width × Height	Minimum (Wide) to Maximum (Tele)	Vertical Lens Shift Bottom to Top
45"	91 × 69	87 - 117	-69 - 0
50"	102 × 76	97 - 131	-76 - 0
60"	122 × 91	117 - 157	-91 - 0
80"	163 × 122	157 - 211	-122 - 0
90"	183 × 137	176 - 238	-137 - 0
100"	203 × 152	196 - 265	-152 - 0
120"	244 × 183	236 - 319	-183 - 0
130"	264 × 198	256 - 346	-198 - 0
150"	305 × 229	296*	-229 - 0
176"	358 × 268	348*	-268 - 0

Unit : cm

16:9 screen size		①	②
Inches (Diagonally)	Width × Height	Minimum (Wide) to Maximum (Tele)	Vertical Lens Shift Bottom to Top
49"	108 × 61	86 - 116	-64 - 3
50"	111 × 62	88 - 118	-66 - 3
60"	133 × 75	106 - 143	-79 - 4
80"	177 × 100	142 - 191	-105 - 6
100"	221 × 125	178 - 240	-131 - 7
120"	266 × 149	214 - 289	-158 - 8
144"	319 × 179	258 - 348	-189 - 10
150"	332 × 187	269*	-197 - 10
180"	398 × 224	323*	-237 - 12
194"	429 × 242	348*	-255 - 13

Unit : cm

16:6 screen size		①	②
Inches (Diagonally)	Width × Height	Minimum (Wide) to Maximum (Tele)	Vertical Lens Shift Bottom to Top
46"	109 × 41	86 - 117	-55 - 14
50"	119 × 45	94 - 127	-59 - 15
60"	143 × 54	114 - 153	-71 - 18
80"	190 × 71	153 - 206	-95 - 24
100"	238 × 89	191 - 259	-119 - 30
120"	285 × 107	230 - 311	-143 - 36
134"	319 × 120	258 - 348	-159 - 40
150"	357 × 134	289*	-178 - 45
180"	428 × 161	347*	-214 - 54
181"	430 × 161	349*	-215 - 54

\* Project using Wide (maximum zoom).

**EB-L720U/EB-L520U**

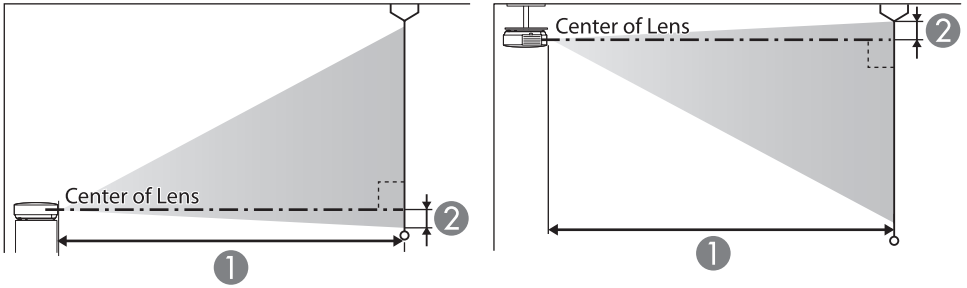

• WUXGA

Unit : cm

16:10 screen size		①	②
Inches (Diagonally)	Width × Height	Minimum (Wide) to Maximum (Tele)	
50"	108 × 67	144 - 235	-2
60"	129 × 81	174 - 283	-3
70"	151 × 94	204 - 331	-3
80"	172 × 108	233 - 378	-4
100"	215 × 135	292 - 474	-5
120"	258 × 162	351 - 569	-6
150"	323 × 202	440 - 713	-7
200"	431 × 269	588 - 951	-10
300"	646 × 404	884 - 1429	-14
500"	1077 × 673	1476 - 2384	-24

Unit : cm

4:3 screen size		①	②
Inches (Diagonally)	Width × Height	Minimum (Wide) to Maximum (Tele)	
45"	91 × 69	147 - 240	-2
50"	102 × 76	164 - 267	-3
60"	122 × 91	197 - 321	-3
70"	142 × 107	231 - 375	-4
80"	163 × 122	264 - 429	-4
100"	203 × 152	331 - 537	-5
120"	244 × 183	398 - 645	-7
150"	305 × 229	499 - 807	-8
200"	406 × 305	666 - 1077	-11
300"	610 × 457	1001 - 1618	-16
440"	894 × 671	1470 - 2375	-24



Unit : cm

16:9 screen size		①	②
Inches (Diagonally)	Width × Height	Minimum (Wide) to Maximum (Tele)	
49"	108 × 61	145 - 237	1
50"	111 × 62	148 - 242	1
60"	133 × 75	179 - 291	1
70"	155 × 87	209 - 340	1
80"	177 × 100	240 - 389	2
100"	221 × 125	301 - 487	2
120"	266 × 149	361 - 585	2
150"	332 × 187	453 - 733	3
200"	443 × 249	605 - 978	4
300"	664 × 374	909 - 1469	6
486"	1076 × 605	1474 - 2381	9

Unit : cm

16:6 screen size		①	②
Inches (Diagonally)	Width × Height	Minimum (Wide) to Maximum (Tele)	
46"	109 × 41	147 - 239	11
50"	119 × 45	160 - 260	12
60"	143 × 54	192 - 313	15
70"	166 × 62	225 - 366	17
80"	190 × 71	258 - 418	20
100"	238 × 89	323 - 524	24
120"	285 × 107	388 - 629	29
150"	357 × 134	486 - 787	37
200"	476 × 178	650 - 1051	49
300"	713 × 268	976 - 1578	73
452"	1075 × 403	1473 - 2379	110



## ■ For more information

epson.sn 🔍



EN	You can get the latest version of the manuals and specifications on the Epson Web site.
DE	Sie finden die aktuelle Version von Anleitungen und Spezifikationen auf der Epson-Website.
FR	Vous pouvez obtenir la dernière version des manuels et des spécifications depuis le site Web Epson.
IT	È possibile ottenere la versione più recente di manuali e specifiche sul sito web Epson.
ES	Puede obtener la última versión de los manuales y las especificaciones en el sitio web de Epson.
PT	Pode aceder à versão mais recente dos manuais e das características técnicas no website da Epson.
NL	U kunt de nieuwste versie van de handleidingen en specificaties verkrijgen op de website van Epson.
DA	Du kan hente de nyeste udgaver af manualerne og specifikationer på Epsons websted.
FI	Voit hakea käyttöoppaiden ja teknisten tietojen uusimmat versiot Epson-verkkosivustolla.
NO	Du finner de nyeste versjonene av håndbøkene og spesifikasjonene på Epsons nettsted.
SV	Du kan hämta den senaste versionen av handböcker och specifikationer på Epsons webbplats.
CS	Nejnovější verzi příruček a specifikací můžete získat na webu společnosti Epson.
HU	Az Epson weboldaláról beszerezheti az útmutatók és specifikációk legújabb verzióit.
PL	Najnowszą wersję podręczników i specyfikacji można uzyskać na stronie internetowej Epson.
RO	Puteti obține cele mai recente versiuni ale manualelor și specificațiilor de pe site-ul web Epson.
EL	Μπορείτε να βρείτε την τελευταία έκδοση των εγχειριδίων και των προδιαγραφών στην τοποθεσία Web της Epson.
TR	Kılavuzların ve teknik özelliklerin son sürümünü Epson Web sitesinde bulabilirsiniz.

epson.sn



<http://epson.sn>



SL	Najnovejše različice priročnikov in specifikacij najdete na spletnem mestu Epson.
CA	Podeu obtenir la versió més recent dels manuals i les especificacions a la pàgina web d'Epson.
RU	Последние версии руководств и технических характеристик доступны на веб-сайте Epson.
UK	Останні версії посібників і технічних характеристик можна отримати на веб-сайті компанії Epson.
KK	Нұсқаулықтың ең соңғы нұсқасын және сипаттамаларды Epson веб-сайтынан алуға болады.
AR	يمكنك الحصول على أحدث إصدار من أدلة الاستخدام والمواصفات من موقع Epson على الويب.
ZHS	您可以访问 Epson 网站获取最新版手册和规格。
ZHT	您可在 Epson Web 網站上，取得最新版的手冊及規格。
KO	EPSON 웹사이트에서 설명서와 사양 최신 버전을 볼 수 있습니다.
ID	Anda bisa mendapatkan versi terbaru buku petunjuk dan spesifikasi di situs Web Epson.