

ET-4810 Series L5590 Series ET-2840 Series L3560 Series

User's Guide



Printing

Copying

Scanning

Faxing

Maintaining the Printer

Solving Problems

Contents

Guide to This Manual

| | |
|---|----|
| Introduction to the Manuals. | 7 |
| Important Safety Instructions (paper manual). | 7 |
| Start Here (paper manual). | 7 |
| User's Guide (digital manual). | 7 |
| Information on the Latest Manuals. | 7 |
| Guide to Web Movie Manuals. | 7 |
| Searching for Information. | 8 |
| Printing Only the Pages You Need. | 8 |
| About This Manual. | 9 |
| Marks and Symbols. | 9 |
| Notes on Screenshots and Illustrations. | 9 |
| Operating System References. | 10 |
| Trademarks. | 10 |
| Copyright. | 11 |

Important Instructions

| | |
|--|----|
| Safety Instructions. | 13 |
| Safety Instructions for Ink. | 13 |
| Printer Advisories and Warnings. | 14 |
| Advisories and Warnings for Setting Up the Printer. | 14 |
| Advisories and Warnings for Using the Printer. | 14 |
| Advisories and Warnings for Using the LCD Screen. | 15 |
| Advisories and Warnings for Connecting to the Internet. | 15 |
| Advisories and Warnings for Using the Printer with a Wireless Connection. | 15 |
| Advisories and Warnings for Transporting or Storing the Printer. | 15 |
| Notes on the Administrator Password. | 15 |
| Protecting Your Personal Information. | 17 |

Part Names and Functions

| | |
|-----------------|----|
| Front. | 19 |
| Inside. | 20 |
| Rear. | 21 |

Guide to the Control Panel

| | |
|------------------------------------|----|
| Control Panel. | 24 |
| Home Screen Configuration. | 25 |
| Guide to the Network Icon. | 26 |
| Entering Characters. | 26 |

| | |
|-----------------------------|----|
| Viewing Animations. | 27 |
|-----------------------------|----|

Loading Paper

| | |
|---|----|
| Paper Handling Precautions. | 29 |
| Paper Size and Type Settings. | 30 |
| List of Paper Type. | 30 |
| Loading Papers. | 31 |
| Loading Paper in the Rear Paper Feeder. | 31 |
| Loading Various Paper. | 33 |
| Loading Envelopes. | 33 |
| Loading Long Papers. | 34 |

Placing Originals

| | |
|--|----|
| Originals that are not Supported by the ADF. | 36 |
| Placing Originals on the ADF. | 36 |
| Placing Originals on the Scanner Glass. | 37 |

Printing

| | |
|---|----|
| Printing Documents. | 40 |
| Printing from a Computer. | 40 |
| Printing Documents from Smart Devices. | 54 |
| Printing on Envelopes. | 56 |
| Printing on Envelopes from a Computer (Windows). | 56 |
| Printing on Envelopes from a Computer (Mac OS). | 56 |
| Printing Photos. | 57 |
| Printing Photos from a Computer. | 57 |
| Printing Web Pages. | 57 |
| Printing Web Pages from a Computer. | 57 |
| Printing Web Pages from Smart Devices. | 57 |
| Printing Using a Cloud Service. | 58 |

Copying

| | |
|--|----|
| Copying in Color or Monochrome. | 60 |
| Copying by Enlarging or Reducing. | 61 |
| Copying Multiple Originals onto One Sheet. | 61 |
| Copying ID card. | 63 |
| Copying Without Margins. | 64 |
| More Menu Options for Copying. | 64 |
| The number of copies:. | 64 |
| B&W:. | 64 |
| Color:. | 64 |

Print Settings: 64

Scanning

Available Scanning Methods. 67
Scanning Originals to a Computer. 67
Scanning Using WSD. 68
 Setting Up a WSD Port. 69
Scanning Originals to a Smart Device. 71

Faxing

Before Using Fax Features. 73
 Connecting the Printer to a Phone Line. 73
 Making the Printer Ready to Send and
 Receive Faxes. 76
 Making Settings for the Printer's Fax Features
 According to Use. 78
 Making Contacts Available. 81
Overview of this Printer's Fax Features. 83
 Feature: Sending Faxes. 83
 Feature: Receiving Faxes. 84
 **Feature: PC-FAX Send/Receive
 (Windows/Mac OS).** 84
 Features: Various Fax Reports. 85
 Feature: Security when Sending and
 Receiving Faxes. 85
 Features: Other Useful Features. 85
Sending Faxes Using the Printer. 86
 Selecting Recipients. 86
 Various Ways of Sending Faxes. 87
Receiving Faxes on the Printer. 89
 Receiving Incoming Faxes. 90
 Receiving Faxes by Making a Phone Call. 91
Menu Options for Faxing. 92
 Fax. 92
 Scan Settings. 92
 Fax Send Settings. 93
 More. 94
 Contacts Manager. 95
Using Other Faxing Features. 95
 Printing Fax Report Manually. 95
Sending a Fax from a Computer. 95
 Sending Documents Created Using an
 Application (Windows). 96
 Sending Documents Created Using an
 Application (Mac OS). 98
Receiving Faxes on a Computer. 100
 Checking for New Faxes (Windows). 100
 Checking for New Faxes (Mac OS). 101

Canceling the Feature that Saves Incoming
Faxes to the Computer. 102

Maintaining the Printer

Checking the Ink Level. 104
Improving Print, Copy, Scan, and Fax Quality. . . . 104
 Checking and Cleaning the Print Head. 104
 Running Power Cleaning. 106
 Preventing nozzle clogging. 107
 Aligning the Print Head. 107
 Cleaning the Paper Path for Ink Smears. 108
 Cleaning the Scanner Glass. 108
 Cleaning the ADF. 109
Cleaning the Printer. 111
Cleaning Spilled ink. 112

In These Situations

When Replacing a Computer. 114
Saving Power. 114
Checking the Total Number of Pages Fed
Through the Printer. 114
Disabling your Wi-Fi Connection. 115
Installing the Applications Separately. 115
 Checking if a genuine Epson printer driver is
 installed - Windows. 116
 Checking if a genuine Epson printer driver is
 installed - Mac OS. 118
Re-Setting the Network Connection. 118
 Making Settings for Connecting to the
 Computer. 118
 Making Settings for Connecting to the Smart
 Device. 119
 Making Wi-Fi Settings from the Control Panel. . 119
 Checking the Printer's Network Connection
 Status (Network Connection Report). 122
 Messages and Solutions on the Network
 Connection Report. 123
Connecting a Smart Device and Printer Directly
(Wi-Fi Direct). 128
 About Wi-Fi Direct. 128
 Connecting to Devices using Wi-Fi Direct. . . . 129
 Disconnecting Wi-Fi Direct (Simple AP)
 Connection. 130
 Changing the Wi-Fi Direct (Simple AP)
 Settings Such as the SSID. 131
Adding or Changing the Printer's Connection. . . . 132
 To Set Up a Printer on Multiple Computers. . . . 132
 Changing the Connection from Wi-Fi to USB. . 133

| | |
|---|-----|
| Changing the Network Connection from Wi-Fi to Ethernet. | 134 |
| Setting a Static IP Address for the Printer. | 134 |
| Transporting and Storing the Printer. | 136 |

Solving Problems

| | |
|---|-----|
| Cannot Print, Scan, or Fax. | 141 |
| Problem Solving. | 141 |
| The Application or Printer Driver do not Work Properly. | 142 |
| The Printer Cannot Connect to the Network. | 145 |
| Cannot Send or Receive Faxes. | 150 |
| Paper Does Not Feed Properly. | 155 |
| Printing, Copying, Scanning, and Faxing | |
| Quality is Poor. | 158 |
| Print Quality is Poor. | 158 |
| Copy Quality is Poor. | 167 |
| Scanned Image Problems. | 173 |
| The Quality of the Sent Fax is Poor. | 176 |
| Received Fax Quality is Poor. | 178 |
| Cannot Select Paper Type or Paper Source in Printer Driver. | 179 |
| A genuine Epson printer driver has not been installed. | 179 |
| An Error Code is Displayed on the LCD Screen. | 179 |
| Paper Gets Jammed. | 180 |
| Removing Jammed Paper. | 180 |
| Removing Jammed Paper from the ADF. | 184 |
| Preventing Paper Jams. | 186 |
| It is Time to Refill the Ink. | 186 |
| Ink Bottle Handling Precautions. | 186 |
| Refilling the Ink Tanks. | 187 |
| It is Time to Replace the Maintenance Box. | 191 |
| Maintenance Box Handling Precautions. | 191 |
| Replacing a Maintenance Box. | 192 |
| Cannot Operate the Printer as Expected. | 195 |
| The Printer Does Not Turn On or Off. | 195 |
| Operations are Slow. | 196 |
| LCD Screen Gets Dark. | 198 |
| Operation Sounds Are Loud. | 198 |
| The Date and Time Are Incorrect. | 198 |
| The Root Certificate Needs to be Updated. | 198 |
| Cannot Perform Manual 2-sided Printing (Windows). | 198 |
| The Print Settings Menu is Not Displayed (Mac OS). | 199 |
| A Message Prompting You to Reset the Ink Level is Displayed Even After Refilling the Ink. | 199 |

| | |
|---|-----|
| The Ink Level Display does not Change Even After Refilling the Ink. | 199 |
| Cannot Make Calls on the Connected Telephone. | 199 |
| Sender's Fax Number Not Displayed. | 199 |
| Sender's Fax Number Displayed on Received Faxes is Wrong. | 200 |
| Answering Machine Cannot Answer Voice Calls | 200 |
| A Lot of Junk Faxes Have Been Received. | 200 |
| Cannot Solve Problem. | 200 |
| Cannot Solve Printing or Copying Problems. | 200 |

Product Information

| | |
|---|-----|
| Paper Information. | 203 |
| Available Paper and Capacities. | 203 |
| Unavailable Paper Types. | 205 |
| Consumable Products Information. | 205 |
| Ink Bottle Codes. | 205 |
| Maintenance Box Code. | 206 |
| Software Information. | 207 |
| Application for Printing from a Computer (Windows Printer Driver). | 207 |
| Application for Printing from a Computer (Mac OS Printer Driver). | 208 |
| Application for Controlling the Scanner (Epson Scan 2). | 208 |
| Application for Configuring Fax Operations and Sending Faxes (FAX Utility). | 209 |
| Application for Sending Faxes (PC-FAX Driver) | 210 |
| Application for Configuring Printer Operations (Web Config). | 210 |
| Application for Updating Software and Firmware (Epson Software Updater). | 211 |
| Settings Menu List. | 212 |
| Maintenance. | 212 |
| Printer Setup. | 213 |
| Network Settings. | 215 |
| Epson Connect Services. | 216 |
| Contacts Manager. | 216 |
| Fax Settings. | 217 |
| Print Status Sheet. | 222 |
| Print Counter. | 223 |
| Customer Research. | 223 |
| Restore Default Settings. | 223 |
| Firmware Update. | 224 |
| Product Specifications. | 224 |
| Printer Specifications. | 224 |
| Scanner Specifications. | 225 |
| ADF Specifications. | 226 |
| Fax Specifications. | 226 |

| | |
|---|-----|
| Interface Specifications. | 227 |
| Network Specifications. | 227 |
| Supported Third Party Services. | 229 |
| Dimensions. | 229 |
| Electrical Specifications. | 230 |
| Environmental Specifications. | 231 |
| System Requirements. | 232 |
| Regulatory Information. | 232 |
| Standards and Approvals. | 232 |
| Restrictions on Copying. | 234 |

Where to Get Help

| | |
|--|-----|
| Technical Support Web Site. | 236 |
| Contacting Epson Support. | 236 |
| Before Contacting Epson. | 236 |
| Help for Users in Europe. | 236 |
| Help for Users in Taiwan. | 237 |
| Help for Users in Australia. | 237 |
| Help for Users in New Zealand. | 238 |
| Help for Users in Singapore. | 238 |
| Help for Users in Thailand. | 238 |
| Help for Users in Vietnam. | 239 |
| Help for Users in Indonesia. | 239 |
| Help for Users in Hong Kong. | 242 |
| Help for Users in Malaysia. | 243 |
| Help for Users in India. | 243 |
| Help for Users in the Philippines. | 243 |

Guide to This Manual

| | |
|---|----|
| Introduction to the Manuals. | 7 |
| Guide to Web Movie Manuals. | 7 |
| Searching for Information. | 8 |
| Printing Only the Pages You Need. | 8 |
| About This Manual. | 9 |
| Trademarks. | 10 |
| Copyright. | 11 |

Introduction to the Manuals

The following manuals are supplied with your Epson printer. As well as the manuals, check the various types of help information available from the printer itself or from the Epson software applications.

Important Safety Instructions (paper manual)

Provides you with instructions to ensure the safe use of this printer.

Start Here (paper manual)

Provides you with information on setting up the printer and installing the software.

User's Guide (digital manual)

This manual. Available as a PDF and Web manual. Provides detailed information and instructions on using the printer and solving problems.

This manual is used for the ET-4810 Series/L5590 Series and ET-2840 Series/L3560 Series. The following features are only available for the ET-4810 Series/L5590 Series.

- Faxing
- ADF (Automatic Document Feeder)
- Ethernet connection

Information on the Latest Manuals

- Paper manual
Visit the Epson Europe support website at <http://www.epson.eu/support>, or the Epson worldwide support website at <http://support.epson.net/>.
- Digital manual
Visit the following website, enter the product name, and then go to **Support**.
<https://epson.sn>

Guide to Web Movie Manuals

You can watch Web Movie Manuals to learn how to use the printer. Access the following website. The contents of the Web Movie Manuals are subject to change without prior notice.



ET-4810 Series: https://support.epson.net/publist/video.php?model=ET-4810_Series

L5590 Series: https://support.epson.net/publist/video.php?model=L5590_Series

ET-2840 Series: https://support.epson.net/publist/video.php?model=ET-2840_Series

L3560 Series: https://support.epson.net/publist/video.php?model=L3560_Series

Searching for Information

The PDF manual allows you to search for information you are looking for by keyword, or jump directly to specific sections using the bookmarks. This section explains how to use a PDF manual that has been opened in Adobe Acrobat Reader DC on your computer.

Searching by keyword

Click **Edit > Advanced Search**. Enter the keyword (text) for information you want to find in the search window, and then click **Search**. Hits are displayed as a list. Click one of the displayed hits to jump to that page.

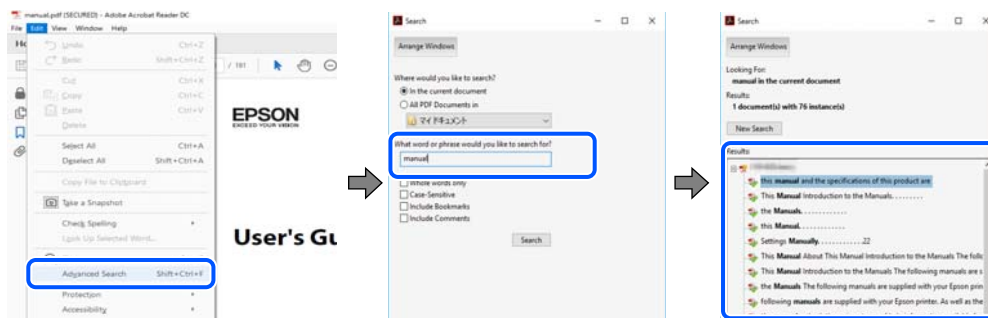

Jumping directly from bookmarks

Click a title to jump to that page. Click + or > to view the lower level titles in that section. To return to the previous page, perform the following operation on your keyboard.

- Windows: Hold down **Alt**. and then press **←**.
- Mac OS: Hold down the command key, and then press **←**.

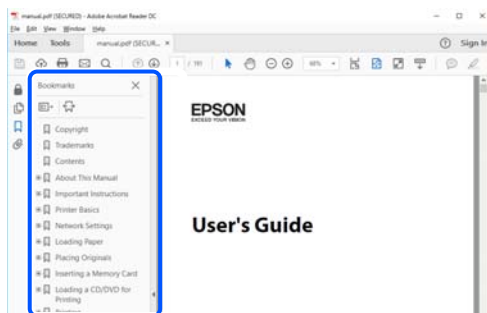

Printing Only the Pages You Need

You can extract and print only the pages you need. Click **Print** in the **File** menu, and then specify the pages you want to print in **Pages in Pages to Print**.

- To specify a series of pages, enter a hyphen between the start page and the end page.

Example: 20-25

- ❑ To specify pages that are not in series, divide the pages with commas.

Example: 5, 10, 15

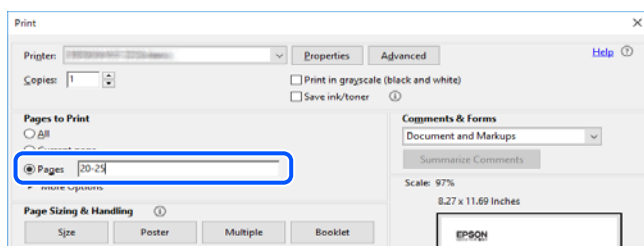

About This Manual

This section explains the meaning of marks and symbols, notes on descriptions, and operating system reference information used in this manual.

Marks and Symbols



Caution:

Instructions that must be followed carefully to avoid bodily injury.



Important:

Instructions that must be observed to avoid damage to your equipment.

Note:

Provides complementary and reference information.

Related Information

➔ Links to related sections.



Provides Web Movie Manuals of the operating instructions. See the related information link.

Notes on Screenshots and Illustrations

- ❑ Screenshots of the printer driver are from Windows 10 or macOS High Sierra (10.13). The content displayed on the screens varies depending on the model and situation.
- ❑ Illustrations used in this manual are examples only. Although there may be slight differences depending on the model, the method of operation is the same.
- ❑ Some of the menu items on the LCD screen vary depending on the model and settings.
- ❑ You can read the QR code using dedicated app.

Operating System References

Windows

In this manual, terms such as "Windows 11", "Windows 10", "Windows 8.1", "Windows 8", "Windows 7", "Windows Vista", "Windows XP", "Windows Server 2022", "Windows Server 2019", "Windows Server 2016", "Windows Server 2012 R2", "Windows Server 2012", "Windows Server 2008 R2", "Windows Server 2008", "Windows Server 2003 R2", and "Windows Server 2003" refer to the following operating systems. Additionally, "Windows" is used to refer to all versions.

- Microsoft® Windows® 11 operating system
- Microsoft® Windows® 10 operating system
- Microsoft® Windows® 8.1 operating system
- Microsoft® Windows® 8 operating system
- Microsoft® Windows® 7 operating system
- Microsoft® Windows Vista® operating system
- Microsoft® Windows® XP operating system
- Microsoft® Windows® XP Professional x64 Edition operating system
- Microsoft® Windows Server® 2022 operating system
- Microsoft® Windows Server® 2019 operating system
- Microsoft® Windows Server® 2016 operating system
- Microsoft® Windows Server® 2012 R2 operating system
- Microsoft® Windows Server® 2012 operating system
- Microsoft® Windows Server® 2008 R2 operating system
- Microsoft® Windows Server® 2008 operating system
- Microsoft® Windows Server® 2003 R2 operating system
- Microsoft® Windows Server® 2003 operating system

Mac OS

In this manual, "Mac OS" is used to refer to Mac OS X 10.9.5 or later as well as macOS 11 or later.

Trademarks

- EPSON® is a registered trademark, and EPSON EXCEED YOUR VISION or EXCEED YOUR VISION is a trademark of Seiko Epson Corporation.
- QR Code is a registered trademark of DENSO WAVE INCORPORATED in Japan and other countries.
- Microsoft®, Windows®, Windows Server®, and Windows Vista® are registered trademarks of Microsoft Corporation.
- Apple, Mac, macOS, OS X, Bonjour, ColorSync, Safari, AirPrint, iPad, iPhone, and iPod touch are trademarks of Apple Inc., registered in the U.S. and other countries.
- Use of the Works with Apple badge means that an accessory has been designed to work specifically with the technology identified in the badge and has been certified by the developer to meet Apple performance standards.

- ❑ Chrome, Google Play, and Android are trademarks of Google LLC.
- ❑ Adobe, Acrobat, and Reader are either registered trademarks or trademarks of Adobe in the United States and/or other countries.
- ❑ Firefox is a trademark of the Mozilla Foundation in the U.S. and other countries.
- ❑ Mopria® and the Mopria® Logo are registered and/or unregistered trademarks and service marks of Mopria Alliance, Inc. in the United States and other countries. Unauthorized use is strictly prohibited.
- ❑ General Notice: Other product names used herein are for identification purposes only and may be trademarks of their respective owners. Epson disclaims any and all rights in those marks.

Copyright

No part of this publication may be reproduced, stored in a retrieval system, or transmitted in any form or by any means, electronic, mechanical, photocopying, recording, or otherwise, without the prior written permission of Seiko Epson Corporation. No patent liability is assumed with respect to the use of the information contained herein. Neither is any liability assumed for damages resulting from the use of the information herein. The information contained herein is designed only for use with this Epson product. Epson is not responsible for any use of this information as applied to other products.

Neither Seiko Epson Corporation nor its affiliates shall be liable to the purchaser of this product or third parties for damages, losses, costs, or expenses incurred by the purchaser or third parties as a result of accident, misuse, or abuse of this product or unauthorized modifications, repairs, or alterations to this product, or (excluding the U.S.) failure to strictly comply with Seiko Epson Corporation's operating and maintenance instructions.

Seiko Epson Corporation and its affiliates shall not be liable for any damages or problems arising from the use of any options or any consumable products other than those designated as Original Epson Products or Epson Approved Products by Seiko Epson Corporation.

Seiko Epson Corporation shall not be held liable for any damage resulting from electromagnetic interference that occurs from the use of any interface cables other than those designated as Epson Approved Products by Seiko Epson Corporation.

© 2022 Seiko Epson Corporation

The contents of this manual and the specifications of this product are subject to change without notice.

Important Instructions

| | |
|---|----|
| Safety Instructions. | 13 |
| Printer Advisories and Warnings. | 14 |
| Protecting Your Personal Information. | 17 |

Safety Instructions

Read and follow these instructions to ensure safe use of this printer. Make sure you keep this manual for future reference. Also, be sure to follow all warnings and instructions marked on the printer.

- Some of the symbols used on your printer are to ensure safety and proper use of the printer. Visit the following Web site to learn the meaning of the symbols.
<http://support.epson.net/symbols/>
- Use only the power cord supplied with the printer and do not use the cord with any other equipment. Use of other cords with this printer or the use of the supplied power cord with other equipment may result in fire or electric shock.
- Be sure your AC power cord meets the relevant local safety standard.
- Never disassemble, modify, or attempt to repair the power cord, plug, printer unit, scanner unit, or options by yourself, except as specifically explained in the printer's manuals.
- Unplug the printer and refer servicing to qualified service personnel under the following conditions:
The power cord or plug is damaged; liquid has entered the printer; the printer has been dropped or the casing damaged; the printer does not operate normally or exhibits a distinct change in performance. Do not adjust controls that are not covered by the operating instructions.
- Place the printer near a wall outlet where the plug can be easily unplugged.
- Do not place or store the printer outdoors, near excessive dirt or dust, water, heat sources, or in locations subject to shocks, vibrations, high temperature or humidity.
- Take care not to spill liquid on the printer and not to handle the printer with wet hands.
- Keep the printer at least 22 cm away from cardiac pacemakers. Radio waves from this printer may adversely affect the operation of cardiac pacemakers.
- If the LCD screen is damaged, contact your dealer. If the liquid crystal solution gets on your hands, wash them thoroughly with soap and water. If the liquid crystal solution gets into your eyes, flush them immediately with water. If discomfort or vision problems remain after a thorough flushing, see a doctor immediately.
- Avoid using a telephone during an electrical storm. There may be a remote risk of electric shock from lightning.
- Do not use a telephone to report a gas leak in the vicinity of the leak.

Safety Instructions for Ink

- Be careful not to touch any ink when you handle the ink tanks, ink tank caps, and opened ink bottles or ink bottle caps.
 - If ink gets on your skin, wash the area thoroughly with soap and water.
 - If ink gets into your eyes, flush them immediately with water. If discomfort or vision problems continue after a thorough flushing, see a doctor immediately.
 - If ink gets into your mouth, see a doctor right away.
- Do not disassemble the maintenance box; otherwise ink may get into your eyes or on your skin.
- Do not shake an ink bottle too vigorously or subject it to strong impacts as this can cause ink to leak.
- Keep ink bottles and maintenance box out of the reach of children. Do not allow children to drink from the ink bottles.

Printer Advisories and Warnings



Read and follow these instructions to avoid damaging the printer or your property. Make sure you keep this manual for future reference.

Advisories and Warnings for Setting Up the Printer

- Do not block or cover the vents and openings in the printer.
- Use only the type of power source indicated on the printer's label.
- Avoid using outlets on the same circuit as photocopiers or air control systems that regularly switch on and off.
- Avoid electrical outlets controlled by wall switches or automatic timers.
- Keep the entire computer system away from potential sources of electromagnetic interference, such as loudspeakers or the base units of cordless telephones.
- The power-supply cords should be placed to avoid abrasions, cuts, fraying, crimping, and kinking. Do not place objects on top of the power-supply cords and do not allow the power-supply cords to be stepped on or run over. Be particularly careful to keep all the power-supply cords straight at the ends.
- If you use an extension cord with the printer, make sure that the total ampere rating of the devices plugged into the extension cord does not exceed the cord's ampere rating. Also, make sure that the total ampere rating of all devices plugged into the wall outlet does not exceed the wall outlet's ampere rating.
- If you plan to use the printer in Germany, the building installation must be protected by a 10 or 16 amp circuit breaker to provide adequate short-circuit protection and over-current protection for the printer.
- When connecting the printer to a computer or other device with a cable, ensure the correct orientation of the connectors. Each connector has only one correct orientation. Inserting a connector in the wrong orientation may damage both devices connected by the cable.
- Place the printer on a flat, stable surface that extends beyond the base of the printer in all directions. The printer will not operate properly if it is tilted at an angle.
- Allow space above the printer so that you can fully raise the document cover.
- Leave enough space in front of the printer for the paper to be fully ejected.
- Avoid places subject to rapid changes in temperature and humidity. Also, keep the printer away from direct sunlight, strong light, or heat sources.

Advisories and Warnings for Using the Printer

- Do not insert objects through the slots in the printer.
- Do not put your hand inside the printer during printing.
- Do not touch the white flat cable and ink tubes inside the printer.
- Do not use aerosol products that contain flammable gases inside or around the printer. Doing so may cause fire.
- Do not move the print head by hand; otherwise, you may damage the printer.
- Be careful not to trap your fingers when closing the scanner unit.
- Do not press too hard on the scanner glass when placing the originals.

- ❑ Prolonged use of the printer when the ink level is below the lower line could damage the printer. Fill the ink tank to the upper line while the printer is not operating. To display the correct ink level estimates, reset the ink level after filling the tank.
- ❑ Always turn the printer off using the  button. Do not unplug the printer or turn off the power at the outlet until the  light stops flashing.
- ❑ If you are not going to use the printer for a long period, be sure to unplug the power cord from the electrical outlet.

Advisories and Warnings for Using the LCD Screen

- ❑ The LCD screen may contain a few small bright or dark spots, and because of its features it may have an uneven brightness. These are normal and do not indicate that it is damaged in any way.
- ❑ Only use a dry, soft cloth for cleaning. Do not use liquid or chemical cleaners.
- ❑ The exterior cover of the LCD screen could break if it receives a heavy impact. Contact your dealer if the screen's surface chips or cracks, and do not touch or attempt to remove the broken pieces.

Advisories and Warnings for Connecting to the Internet

Do not connect this product to the Internet directly. Connect it in a network protected by a router or firewall.

Advisories and Warnings for Using the Printer with a Wireless Connection

- ❑ Radio waves from this printer may negatively affect the operation of medical electronic equipment, causing them to malfunction. When using this printer inside medical facilities or near medical equipment, follow directions from the authorized personnel representing the medical facilities, and follow all posted warnings and directions on the medical equipment.
- ❑ Radio waves from this printer may negatively affect the operation of automatically controlled devices such as automatic doors or fire alarms, and could lead to accidents due to malfunction. When using this printer near automatically controlled devices, follow all posted warnings and directions on these devices.

Advisories and Warnings for Transporting or Storing the Printer

- ❑ When storing or transporting the printer, avoid tilting it, placing it vertically, or turning it upside down; otherwise ink may leak.
- ❑ Before transporting the printer, make sure that the print head is in the home (far right) position.

Notes on the Administrator Password

This printer allows you to set an administrator password to prevent unauthorized access or changes to the device settings and network settings stored in the product when connecting to a network.

Default Value of the Administrator Password

The default value of the administrator password is printed on the label on the product itself, such as the one shown. The position where the label is attached depends on the product, such as the side where the cover is opened, the back, or the bottom.

The following illustration is an example of the label attachment position on the side of the printer where the cover opens.

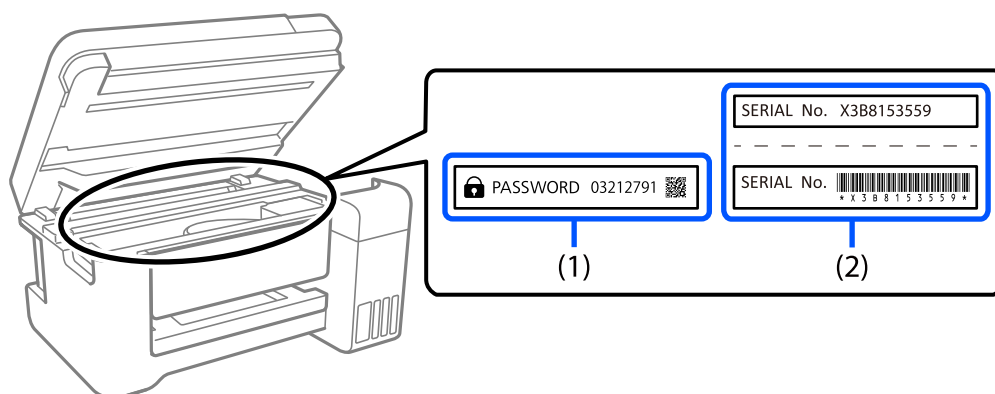

If both labels (1) and (2) are attached, the value next to PASSWORD written on the label in (1) is the default value. In this example, the default value is 03212791.

If only label (2) is attached, the serial number printed on the label in (2) is the default value. In this example, the default value is X3B8153559.

Changing the Administrator Password

It can be changed from the printer control panel and Web Config. When changing the password, set it with at least 8 single-byte alphanumeric characters and symbols.

Related Information

➔ [“Application for Configuring Printer Operations \(Web Config\)” on page 210](#)

Operations that Require You to Enter the Administrator Password

If you are prompted to enter the administrator password when performing the following operations, enter the administrator password set on the printer.

- When updating the firmware of the printer from a computer or smart device
- When logging on to the advanced settings of Web Config
- When setting using an application, such as Fax Utility, that can change the printer's settings.

Initializing the Administrator Password

You can return the administrator password to the default settings by initializing the network settings.

Related Information

- ➔ [“Restore Default Settings” on page 223](#)
- ➔ [“Where to Get Help” on page 235](#)

Protecting Your Personal Information

When you give the printer to someone else or dispose of it, erase all the personal information stored in the printer's memory by selecting **Settings > Restore Default Settings > Clear All Data and Settings** on the control panel.

Part Names and Functions

| | |
|--------------|----|
| Front. | 19 |
| Inside. | 20 |
| Rear. | 21 |

Front

Only for ET-4810 Series/L5590 Series

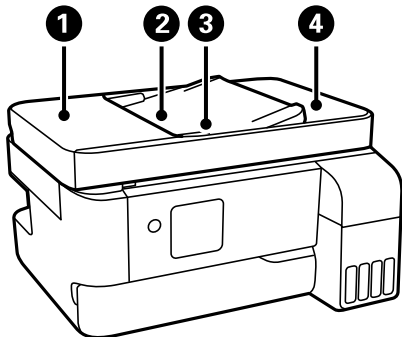

| | | |
|---|---------------------------------------|--|
| ① | ADF (Automatic Document Feeder) cover | Open when removing jammed originals in the ADF. |
| ② | ADF input tray | Feeds originals automatically. |
| ③ | ADF edge guide | Feeds originals straight into the printer. Slide to the edge of the originals. |
| ④ | ADF output tray | Holds originals ejected from the ADF. |

Only for ET-4810 Series/L5590 Series

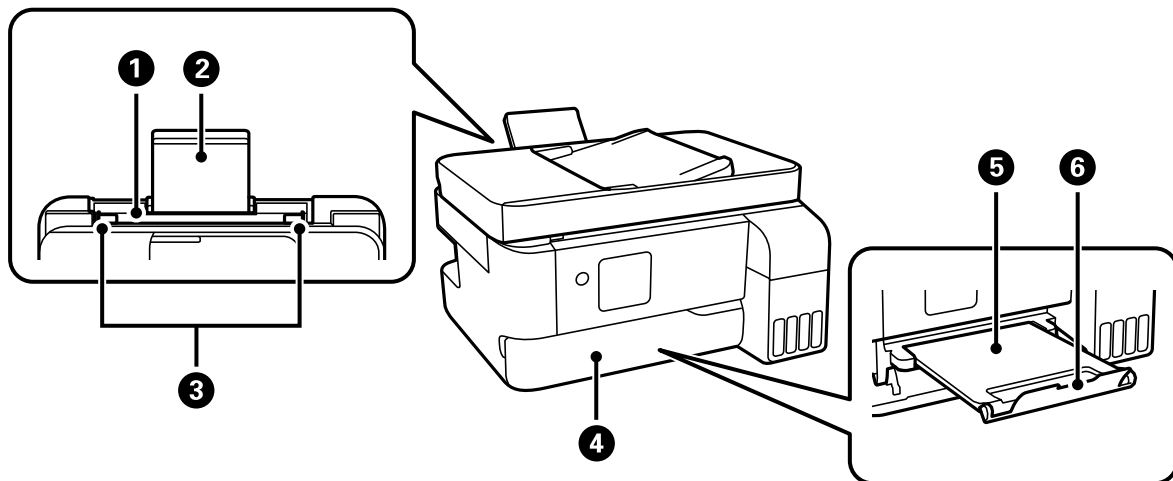

| | | |
|---|-------------------|--|
| ① | Rear paper feeder | Loads paper. |
| ② | Paper support | Supports loaded paper. |
| ③ | Edge guide | Feeds the paper straight into the printer. Slide to the edges of the paper. |
| ④ | Output tray cover | Opens automatically when printing starts. |
| ⑤ | Output tray | Holds the ejected paper. Pull out manually and push it back in to store. |
| ⑥ | Stopper | Position the stopper to prevent printouts from falling from the output tray. |

Only for ET-2840 Series/L3560 Series

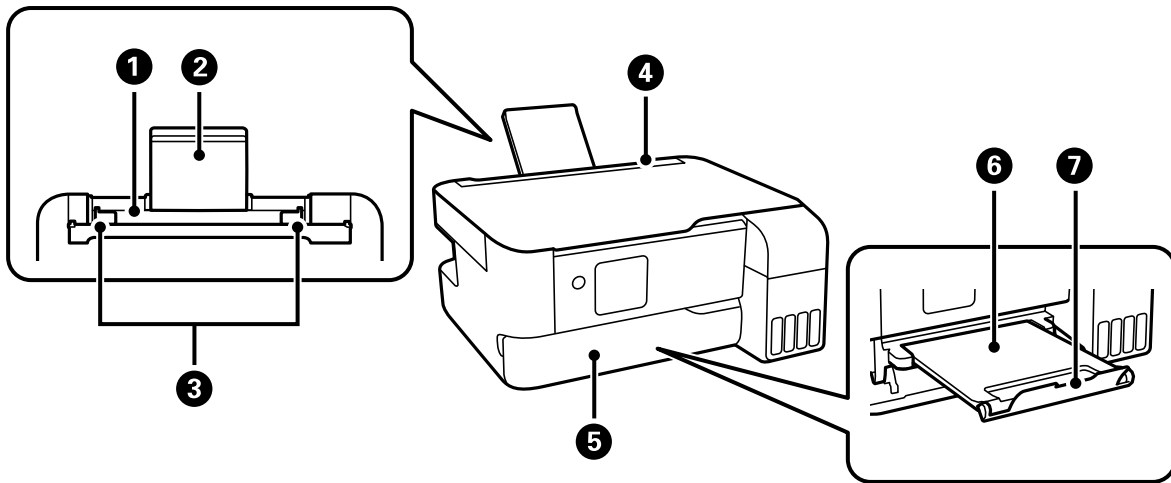

| | | |
|---|-------------------|--|
| ① | Rear paper feeder | Loads paper. |
| ② | Paper support | Supports loaded paper. |
| ③ | Edge guide | Feeds the paper straight into the printer. Slide to the edges of the paper. |
| ④ | Feeder guard | Prevents foreign substance from entering the printer. Usually keep this guard closed. |
| ⑤ | Output tray cover | Opens automatically when printing starts. |
| ⑥ | Output tray | Holds the ejected paper. Pull out manually and push it back in to store. |
| ⑦ | Stopper | Position the stopper to prevent printouts from falling from the output tray. |

Inside

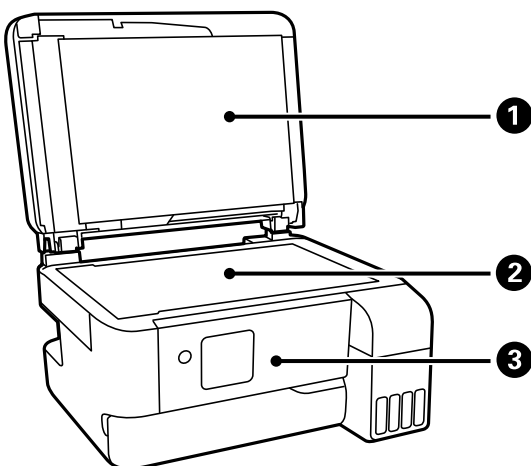

| | | |
|---|----------------|---------------------------------------|
| ① | Document cover | Blocks external light while scanning. |
| ② | Scanner glass | Place the originals. |

| | | |
|---|---------------|---|
| 3 | Control panel | Indicates the printer's status and allows you to make print settings. |
|---|---------------|---|

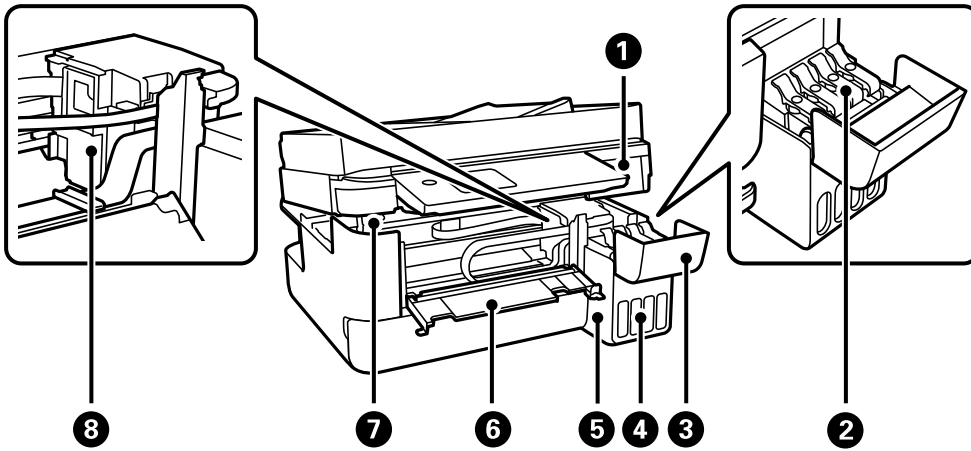

| | | |
|---|-------------------------------|---|
| 1 | Scanner unit | Scans placed originals. Open to remove jammed paper. This unit should usually be kept closed. |
| 2 | Ink tank cap | Open to refill the ink tank. |
| 3 | Ink tank cover | |
| 4 | Ink reservoir tank (Ink tank) | Supplies ink to the print head. |
| 5 | Ink tank unit | Contains the ink tanks. |
| 6 | Inner cover | Open when removing jammed paper inside the printer. |
| 7 | Scanner unit support | Supports the scanner unit when opening it. |
| 8 | Print head | Ink is ejected from the print head nozzles underneath. |

Rear

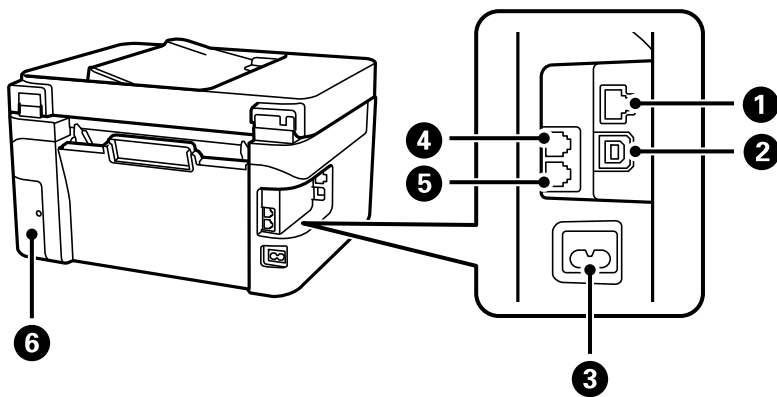

| | | |
|---|-----------|--|
| 1 | LAN port* | Connects a LAN cable. |
| 2 | USB port | Connects a USB cable to connect with a computer. |

| | | |
|---|-----------------------|---|
| ③ | AC inlet | Connects the power cord. |
| ④ | EXT. port* | Connects external phone devices. |
| ⑤ | LINE port* | Connects a phone line. |
| ⑥ | Maintenance box cover | Remove when replacing the maintenance box. You need a flat-head screwdriver to remove the maintenance box. The maintenance box is a container that collects a very small amount of surplus ink during cleaning or printing. |

* Only for ET-4810 Series/L5590 Series

Guide to the Control Panel

| | |
|------------------------------------|----|
| Control Panel. | 24 |
| Home Screen Configuration. | 25 |
| Entering Characters. | 26 |
| Viewing Animations. | 27 |

Control Panel

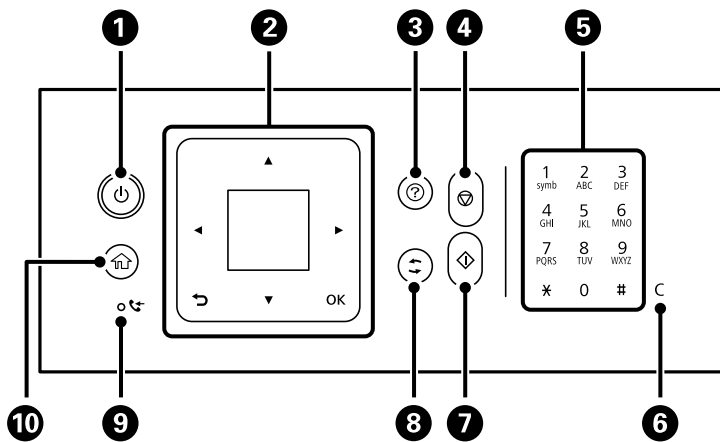







| | |
|------------------|---|
| <p>1</p> | <p>Turns the printer on or off. Unplug the power cord after checking that the power light is off.</p> |
| <p>2</p> | <p>Screen Displays menus and messages. Use buttons on the control panel to select a menu or to make settings.</p> <p>▲ ▼ ◀ ▶ buttons and OK button Use the ▲ ▼ ◀ ▶ buttons to select a menu, and then press the OK button to enter the selected menu.</p> <p>↶ button Returns to the previous screen.</p> |
| <p>3</p> | <p>Displays the solutions when you are in trouble.</p> |
| <p>4</p> | <p>Stops the current operation.</p> |
| <p>5*</p> | <p>Enters numbers, characters, and symbols.</p> |
| <p>6*</p> | <p>Clears number settings such as the number of copies.</p> |
| <p>7</p> | <p>Starts an operation such as printing or copying.</p> |
| <p>8</p> | <p>Applies to a variety of functions depending on the situation.</p> |
| <p>9*</p> | <p>Turns on when received documents that have not yet been printed or saved are stored in the printer's memory.</p> |
| <p>10</p> | <p>Displays the home screen.</p> |

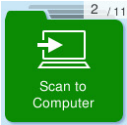

* Only for ET-4810 Series/L5590 Series

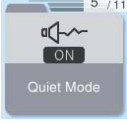
Home Screen Configuration

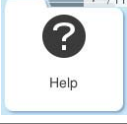





The following home screen is displayed when you turn on the printer or press the  button on the control panel. You can easily copy and print by switching the menu and selecting the option you need.



| | |
|---|---|
|  | <p>Allows you to copy documents.</p> |
|  | <p>Allows you to scan documents and save them to a computer.</p> |
|  | <p>Allows you to scan documents and save them to a computer using the WSD feature.</p> |
|  | <p>Allows you to send faxes.</p> |
|  | <p>Displays Quiet Mode setting that allows you to reduce the noise the printer makes. However, enabling this may reduce print speed. Depending on the paper type and print quality settings you selected, there may be no difference in the printer's noise level.</p> |
|  | <p>Allows you to make settings related to maintenance, printer settings, and operations.</p> |
|  | <p>Displays the Help screen. You can view the operating instructions or the solutions to problems.</p> |
|  | <p>Displays the menus recommended to improve the quality of your printouts such as unclogging nozzles by printing a nozzle check pattern and performing head cleaning, and improving blurring or banding in your printouts by aligning the print head.</p> |

| | |
|---|---|
|  | <p>Provides solutions when you cannot print as expected.</p> |
|  | <p>Select the paper size and paper type you loaded in the paper source.</p> |
|  | <p>Displays menus that allow you to set up the printer for use on a wireless network.</p> |

Guide to the Network Icon

| | |
|---|--|
|  | <p>The printer is not connected to a wired (Ethernet) network or a wireless (Wi-Fi) network.</p> |
|  | <p>The printer is connected to a wired (Ethernet) network.</p> |
|  | <p>The printer is searching for SSID, unset IP address, or having a problem with a wireless (Wi-Fi) network.</p> |
|  | <p>The printer is connected to a wireless (Wi-Fi) network. The number of bars indicates the signal strength of the connection. The more bars there are, the stronger the connection.</p> |
|  | <p>The printer is not connected to a wireless (Wi-Fi) network in Wi-Fi Direct (Simple AP) mode.</p> |
|  | <p>The printer is connected to a wireless (Wi-Fi) network in Wi-Fi Direct (Simple AP) mode.</p> |

Entering Characters

To enter characters and symbols for network settings and register contacts from the control panel, use the ▲, ▼, ◀, and ▶ buttons and the software keyboard on the LCD screen. Press the ▲, ▼, ◀, or ▶ button to select a character or function button on the keyboard, and then press the OK button. When you have finished entering characters, select **OK**, and then press the OK button.



| Function button | Descriptions |
|-----------------|---|
| ◀▶ | Moves the cursor to the left or right. |
| A 1 # | Switches the character type. You can enter alphanumerics or symbols. You can also switch them by using the ↻ button. |
| ␣ | Enters a space. |
| ⌫ | Deletes a character to the left (backspace). |
| OK | Enters the selected characters. |

Viewing Animations

You can view animations of operating instructions such as loading paper or removing jammed paper on the LCD screen.

- Press **?** button: Displays the help screen. Select **How To** and then select the items that you want to view.
- Select **How to** at the bottom of the operation screen: Displays the context-sensitive animation.



Loading Paper

| | |
|---------------------------------------|----|
| Paper Handling Precautions. | 29 |
| Paper Size and Type Settings. | 30 |
| Loading Papers. | 31 |
| Loading Various Paper. | 33 |

Paper Handling Precautions

- ❑ Read the instruction sheets supplied with the paper.
- ❑ To achieve high-quality printouts with genuine Epson paper, use the paper in the environment stated on the sheets supplied with the paper.
- ❑ Fan and align the edges of the paper before loading. Do not fan or curl photo paper. Doing so may damage the printable side.

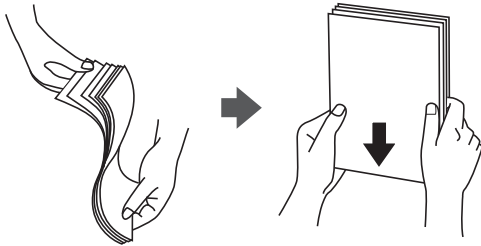

- ❑ If the paper is curled, flatten it or curl it slightly in the opposite direction before loading. Printing on curled paper may cause paper jams and smears on the printout.



- ❑ Paper feed problems may occur frequently for manual 2-sided printing when printing on one side of pre-printed paper. Reduce the number of sheets to half or less, or load one sheet of paper at a time if paper jams continue.
- ❑ Make sure you are using long-grain paper. If you are not sure what type of paper you are using, check the paper packaging or contact the manufacturer to confirm the paper specifications.
- ❑ Fan and align the edges of the envelopes before loading. When the stacked envelopes are puffed up with air, press them down to flatten them before loading.

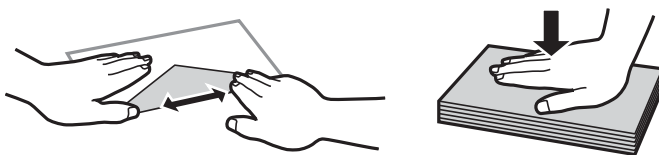

Related Information

- ➔ [“Available Paper and Capacities” on page 203](#)
- ➔ [“Unavailable Paper Types” on page 205](#)

Paper Size and Type Settings

Make sure that you register the paper size and type on the screen displayed when you load paper. The printer informs you when the registered information and print settings differ. This prevents you from wasting paper and ink by making sure you are not printing on the wrong paper size or printing in the wrong color due to using settings that do not match the paper type.

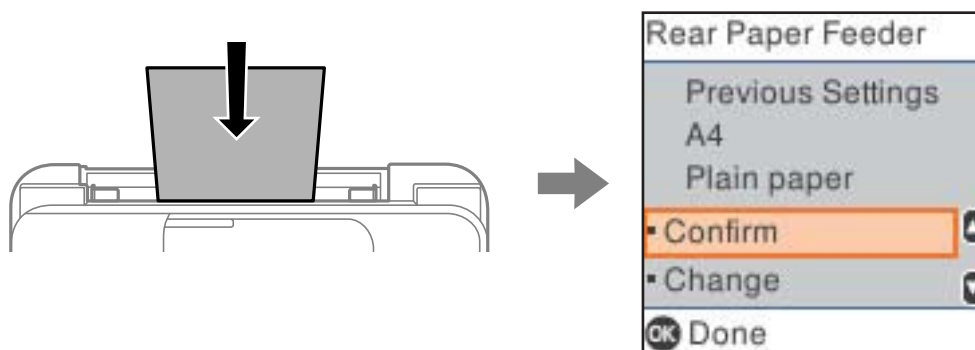

If displayed paper size and type differ from the loaded paper, select **Change** to make changes. Select the paper size and paper type, check the settings, and then press the OK button. If the settings match the loaded paper, select **Confirm**.

Note:

If you do not want to display the paper settings screen automatically when you load paper, select the menus on the home screen as described below.

Settings > Printer Setup > Paper Source Settings > Paper Setup Auto Display > Off.

Related Information

➔ [“Paper Setup Auto Display:” on page 213](#)

List of Paper Type

To obtain optimum printing results, select the paper type that suits the paper.

| Media Name | Media Type | |
|---|-----------------|-------------------------------|
| | Control Panel | Printer Driver, Smart device* |
| Epson Bright White Ink Jet Paper | Plain paper | Plain paper |
| Epson Ultra Glossy Photo Paper | Ultra Glossy | Epson Ultra Glossy |
| Epson Premium Glossy Photo Paper | Prem. Glossy | Epson Premium Glossy |
| Epson Premium Semigloss Photo Paper | Prem. Semigloss | Epson Premium Semigloss |
| Epson Photo Paper Glossy | Glossy | Photo Paper Glossy |
| Epson Matte Paper-Heavyweight Epson Double-Sided Matte Paper | Matte | Epson Matte |

| Media Name | Media Type | |
|---|-----------------------|-------------------------------|
| | Control Panel | Printer Driver, Smart device* |
| Epson Photo Quality Ink Jet Paper Epson Double-sided Photo Quality Ink Jet Paper Epson Photo Quality Self Adhesive Sheets | Photo Quality Ink Jet | Epson Photo Quality Ink Jet |

* For smart devices, these media types can be selected when printing using Epson Smart Panel.

Loading Papers

Loading Paper in the Rear Paper Feeder

1. Pull out the paper support.

ET-4810 Series/L5590 Series

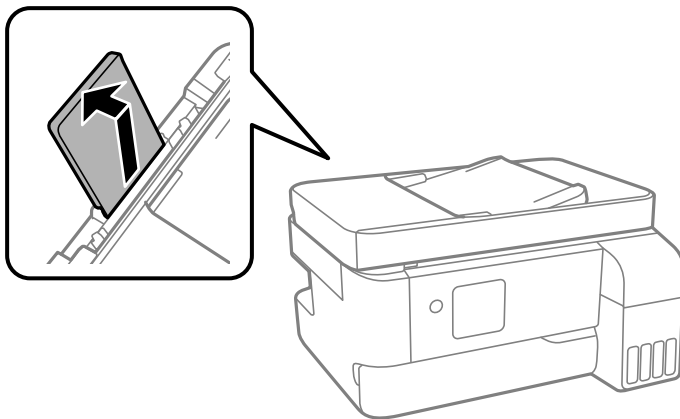

ET-2840 Series/L3560 Series

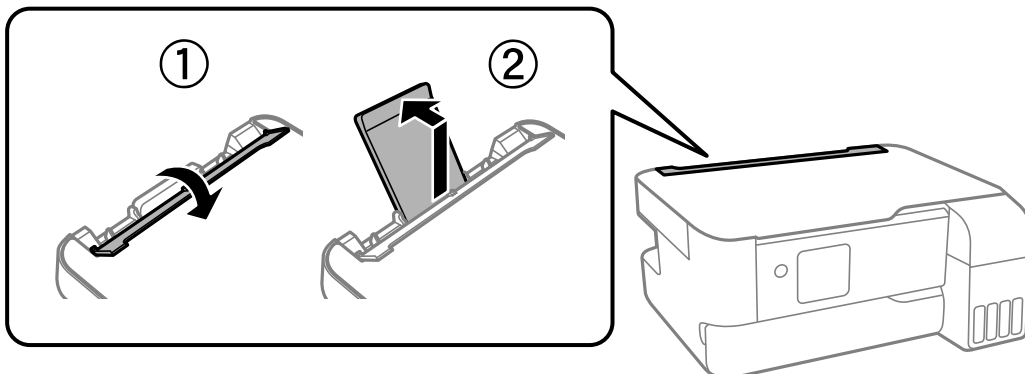

- Slide the edge guides.

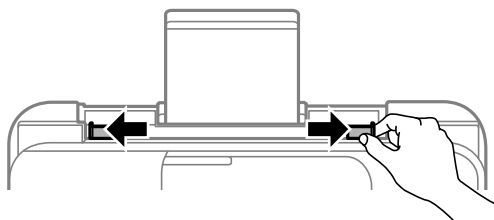

- Load paper at the center of the paper support with the printable side facing up.

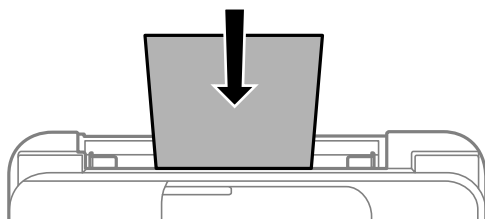

! *Important:*

- Do not load more than the maximum number of sheets specified for the paper. For plain paper, do not load above the line just under the ▼ symbol inside the edge guide.
- Load paper short edge first. However, when you have set the long edge as the width of the user defined size, load paper long edge first.

- Slide the edge guides to the edges of the paper.

ET-2840 Series/L3560 Series: Close the feeder guard after sliding the edge guides.

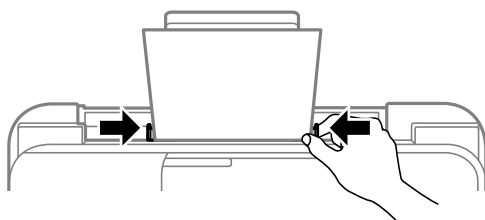

! *Important:*

ET-2840 Series/L3560 Series: Do not place objects on the feeder guard. Doing so may prevent paper from feeding.

- Select the paper size and paper type.

6. Open the output tray cover, and then slide out the output tray.

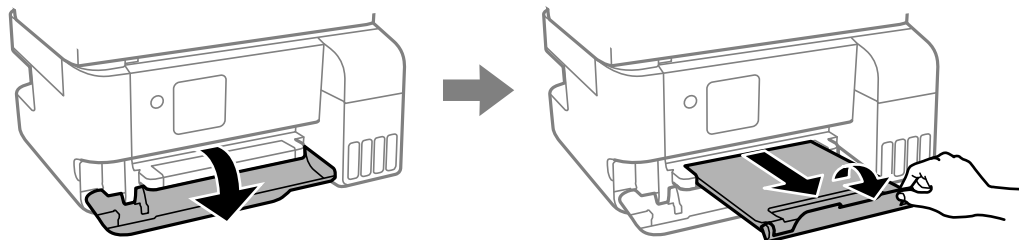

Note:

Return the remaining paper to its package. If you leave it in the printer, the paper may curl or the print quality may decline.

Related Information

- ➔ [“Paper Size and Type Settings” on page 30](#)
- ➔ [“Available Paper and Capacities” on page 203](#)
- ➔ [“Unavailable Paper Types” on page 205](#)

Loading Various Paper

Loading Envelopes

Load envelopes at the center of the paper support, short edge first with the flap facing down, and slide the edge guides to the edges of the envelopes.

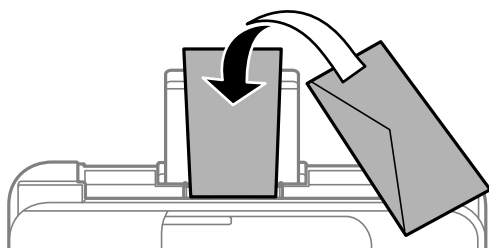

Related Information

- ➔ [“Available Paper and Capacities” on page 203](#)
- ➔ [“Unavailable Paper Types” on page 205](#)

Loading Long Papers

When loading paper longer than legal size, store the paper support, and then flatten the leading edge of the paper. Select **User-Defined** as the paper size setting.

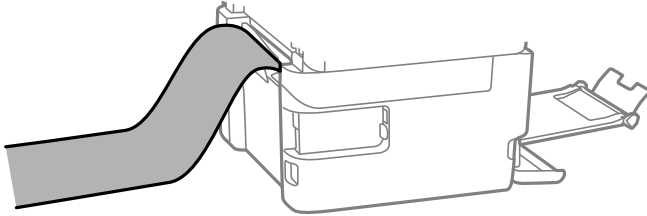

- Make sure the end of the paper is cut perpendicularly. A diagonal cut may cause paper feed problems.
- Long paper cannot be held in the output tray. Prepare a box and so on to make sure that paper does not fall on the floor.
- Do not touch paper that is being fed or ejected. It could injure your hand or cause print quality to decline.

Related Information

- ➔ [“Available Paper and Capacities” on page 203](#)
- ➔ [“Unavailable Paper Types” on page 205](#)

Placing Originals

| | |
|--|----|
| Originals that are not Supported by the ADF. | 36 |
| Placing Originals on the ADF. | 36 |
| Placing Originals on the Scanner Glass. | 37 |

Originals that are not Supported by the ADF



Important:

Do not feed photographs or valuable original artwork into the ADF. Misfeeding may wrinkle or damage the original. Scan these documents on the scanner glass instead.

To prevent paper jams, avoid placing the following originals in the ADF. For these types, use the scanner glass.

- Originals that are torn, folded, wrinkled, deteriorated, or curled
- Originals with binder holes
- Originals held together with tape, staples, paper clips etc.
- Originals that have stickers or labels stuck to them
- Originals that are cut irregularly or not right angled
- Originals that are bound
- OHPs, thermal transfer paper, or carbon backs

Placing Originals on the ADF

1. Align the edges of the originals.
2. Slide out the ADF edge guide.

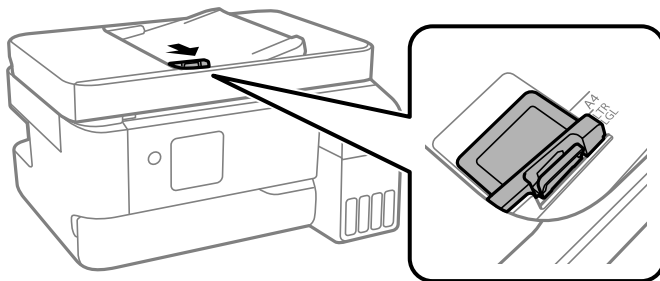

3. Place the originals face-up and short edge first in the ADF, and then slide the ADF edge guide to the edge of the originals.

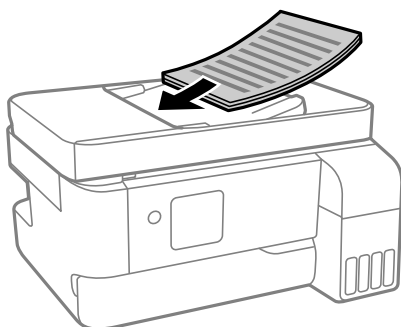

! **Important:**

- ❑ Do not load originals above the line indicated by the triangle symbol on the ADF.

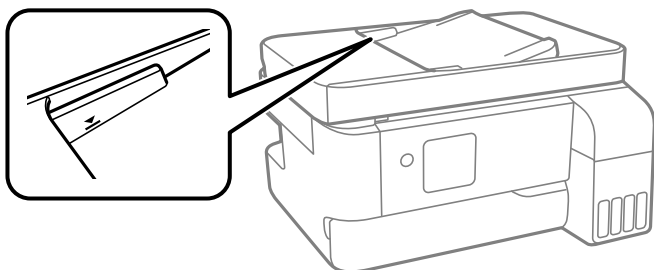

- ❑ Do not add originals while scanning.

Related Information

➔ [“ADF Specifications” on page 226](#)

Placing Originals on the Scanner Glass

1. Open the document cover.

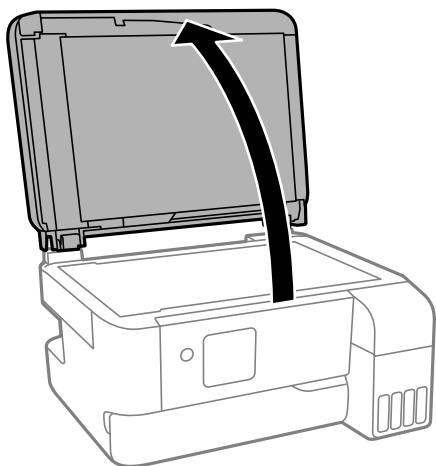

2. Remove any dust or stains on the surface of the scanner glass using a soft, dry, clean cloth.

Note:

If there is any trash or dirt on the scanner glass, the scanning range may expand to include it, so the image of the original may be displaced or reduced.

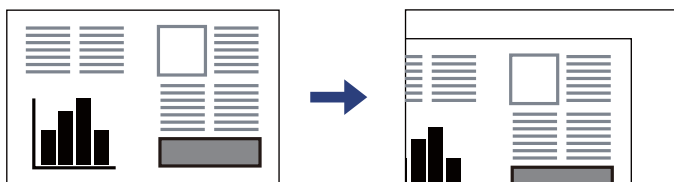

3. Place the original face-down and slide it to the corner mark.

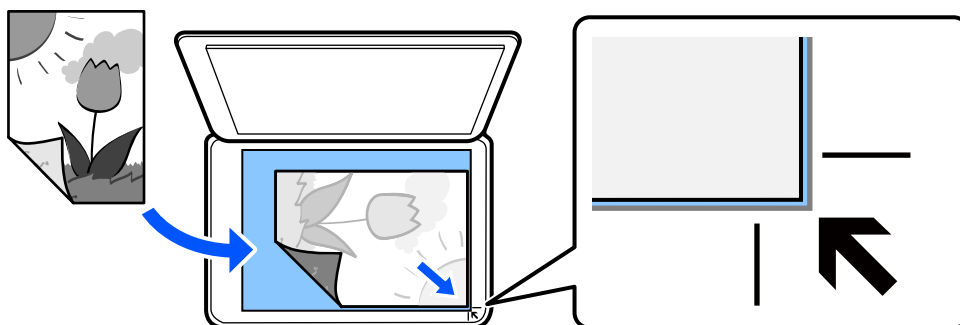

Note:

When originals are placed in the ADF and on the scanner glass, priority is given to the originals in the ADF.

4. Close the cover gently.



Caution:

Be careful not to trap your fingers when closing the document cover. Otherwise you may be injured.



Important:

- When placing bulky originals such as books, prevent exterior light from shining directly onto the scanner glass.*
- Do not apply too much force to the scanner glass or the document cover. Otherwise, they may be damaged.*

5. Remove the originals after scanning.

Note:

If you leave the originals on the scanner glass for a long time, they may stick to the surface of the glass.

Related Information

➔ [“Scanner Specifications” on page 225](#)

Printing

| | |
|---|----|
| Printing Documents. | 40 |
| Printing on Envelopes. | 56 |
| Printing Photos. | 57 |
| Printing Web Pages. | 57 |
| Printing Using a Cloud Service. | 58 |

Printing Documents

Printing from a Computer

This section explains how to print a document from your computer using Windows as an example. On Mac OS, the procedure may be different or some features may not be supported.

Printing Using Easy Settings

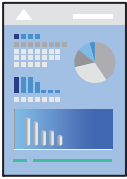

Note:

Operations may differ depending on the application. See the application's help for details.

1. Load paper in the printer.
[“Loading Paper in the Rear Paper Feeder” on page 31](#)
2. Open the file you want to print.
3. Select **Print** or **Print Setup** from the **File** menu.
4. Select your printer.

5. Select **Preferences** or **Properties** to access the printer driver window.

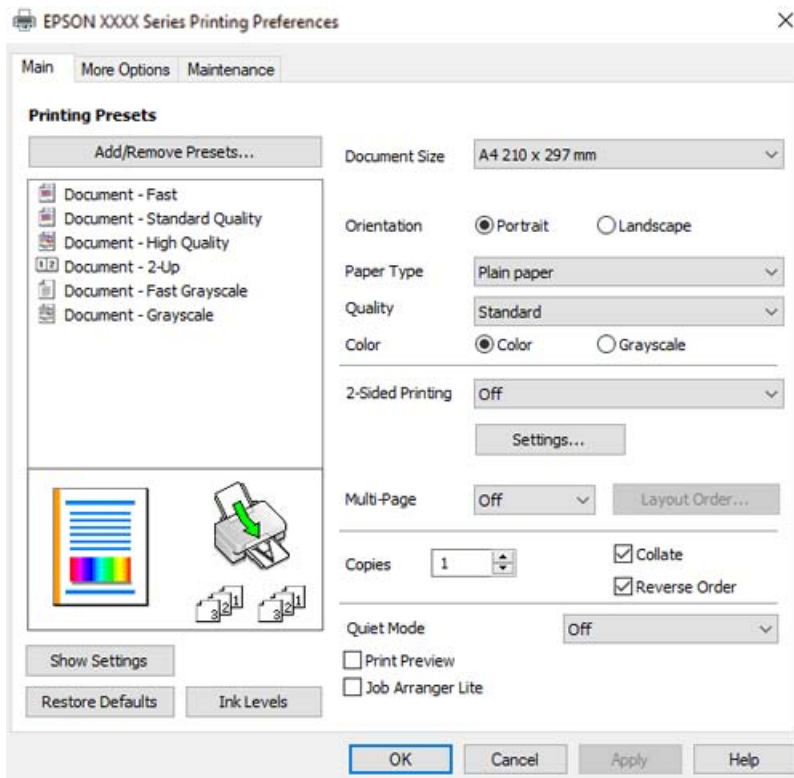

6. Change the settings as necessary.
You can see the online help for explanations of the setting items. Right-clicking an item displays **Help**.
7. Click **OK** to close the printer driver window.
8. Click **Print**.

Related Information

- ➔ [“List of Paper Type” on page 30](#)
- ➔ [“Available Paper and Capacities” on page 203](#)

Adding Printing Presets for Easy Printing

If you create your own preset of frequently used print settings on the printer driver, you can print easily by selecting the preset from the list.

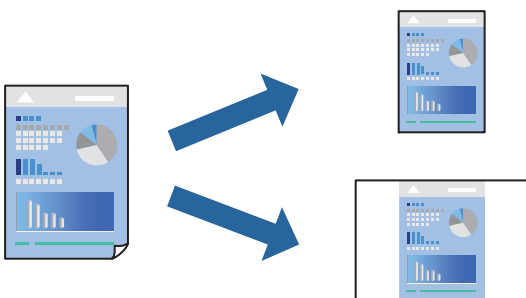

1. On the printer driver's **Main** or **More Options** tab, set each item (such as **Document Size** and **Paper Type**).
2. Click **Add/Remove Presets** in **Printing Presets**.
3. Enter a **Name** and, if necessary, enter a comment.
4. Click **Save**.

Note:

To delete an added preset, click **Add/Remove Presets**, select the preset name you want to delete from the list, and then delete it.

5. Click **Print**.

The next time you want to print using the same settings, select the registered setting name from **Printing Presets**, and click **OK**.

Printing on 2-Sides

The printer driver will automatically print odd pages and even pages separately. When the odd pages have been printed, turn over the paper according to the instructions and print the even pages.

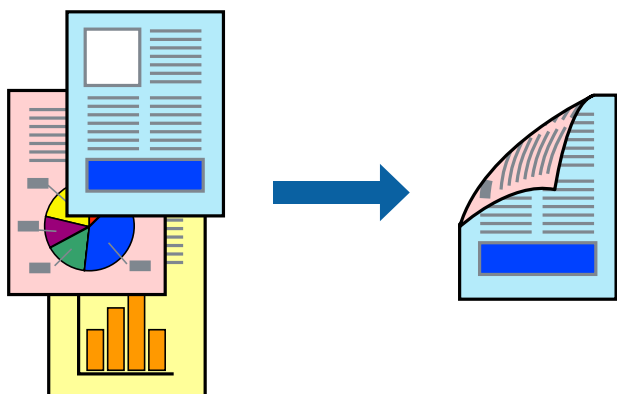

Note:

This feature is not available for borderless printing.

Access the printer driver, and then make the following settings.

Main tab > **2-Sided Printing**

Related Information

- ➔ [“Paper for 2-Sided Printing” on page 205](#)
- ➔ [“Cannot Perform Manual 2-sided Printing \(Windows\)” on page 198](#)

Printing a Booklet

You can also print a booklet that can be created by re-ordering the pages and folding the printout.

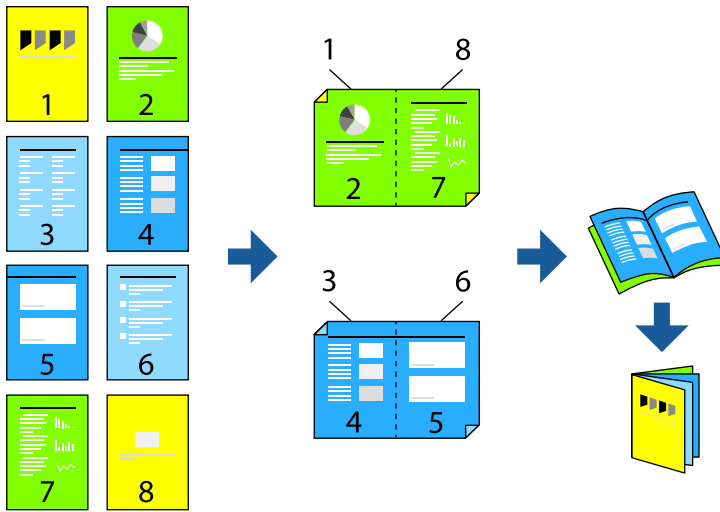

Note:

This feature is not available with borderless printing.

Access the printer driver, and then make the following settings.

On the **Main** tab, select the 2-side printing method from **2-Sided Printing**, and then select **Settings > Booklet**.

Related Information

- ➔ [“Paper for 2-Sided Printing” on page 205](#)
- ➔ [“Cannot Perform Manual 2-sided Printing \(Windows\)” on page 198](#)

Printing Several Pages on One Sheet

You can print several pages of data on a single sheet of paper.

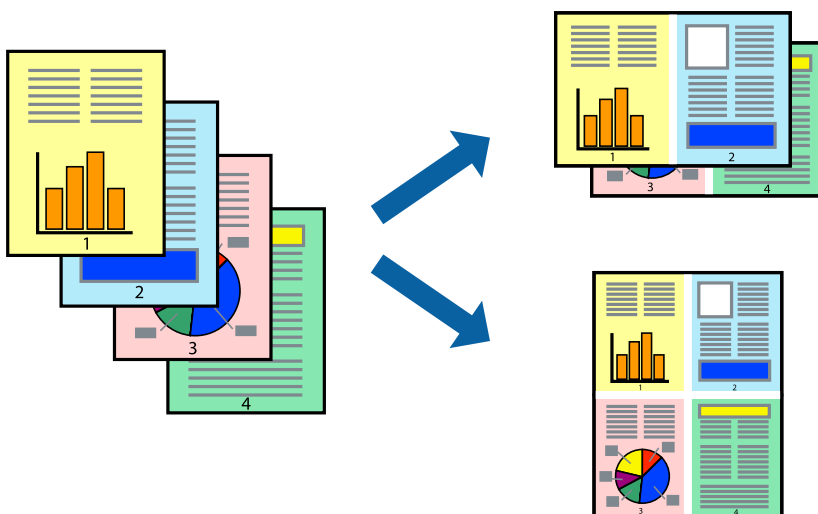

Note:

This feature is not available with borderless printing.

Access the printer driver, and then make the following settings.

Main tab > **Multi-Page** > **2-Up**, etc.

Printing to Fit the Paper Size

You can print to fit the paper size you loaded in the printer.



Note:

This feature is not available with borderless printing.

Access the printer driver, and then make the following settings.

On the **More Options** tab > **Output Paper**, select the size of the loaded paper.

Printing a Reduced or Enlarged Document at any Magnification

You can reduce or enlarge the size of a document by a specific percentage.



Note:

This feature is not available with borderless printing.

1. On the printer driver's **More Options** tab, select the document size from the **Document Size** setting.
2. Select the paper size you want to print on from the **Output Paper** setting.
3. Select **Reduce/Enlarge Document, Zoom to**, and then enter a percentage.

Printing One Image on Multiple Sheets for Enlargement (Creating a Poster)

This feature allows you to print one image on multiple sheets of paper. You can create a larger poster by taping them together.

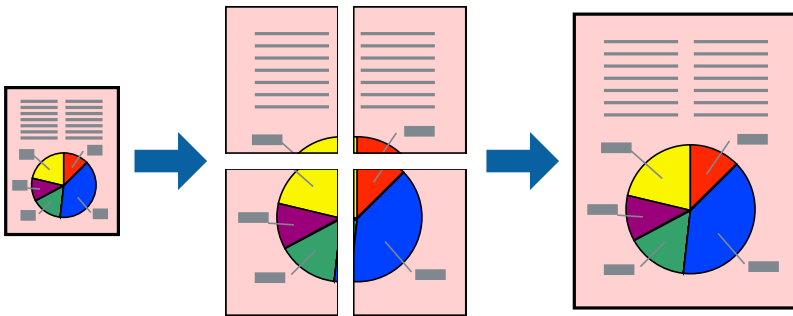

Note:

This feature is not available with 2-sided printing.

Access the printer driver, and then make the following settings.

Main tab > **Multi-Page** > **2x2 Poster**, etc.

Making Posters Using Overlapping Alignment Marks

Here is an example of how to make a poster when **2x2 Poster** is selected, and **Overlapping Alignment Marks** is selected in **Print Cutting Guides**.

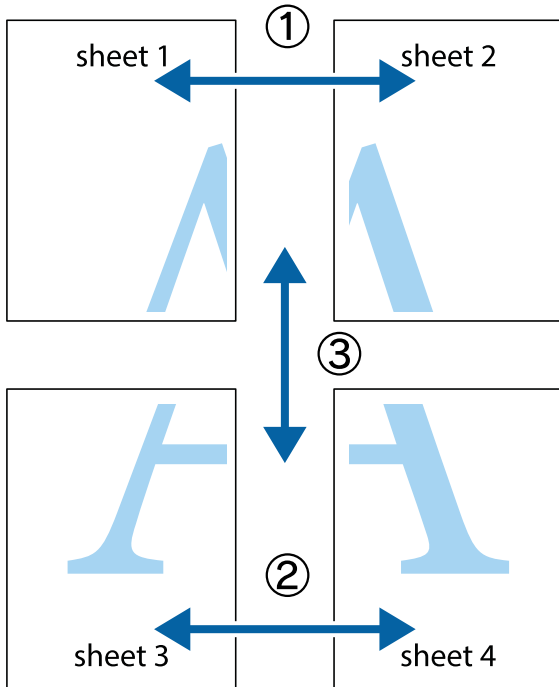

1. Prepare Sheet 1 and Sheet 2. Cut off the margins of Sheet 1 along the vertical blue line through the center of the top and bottom cross marks.

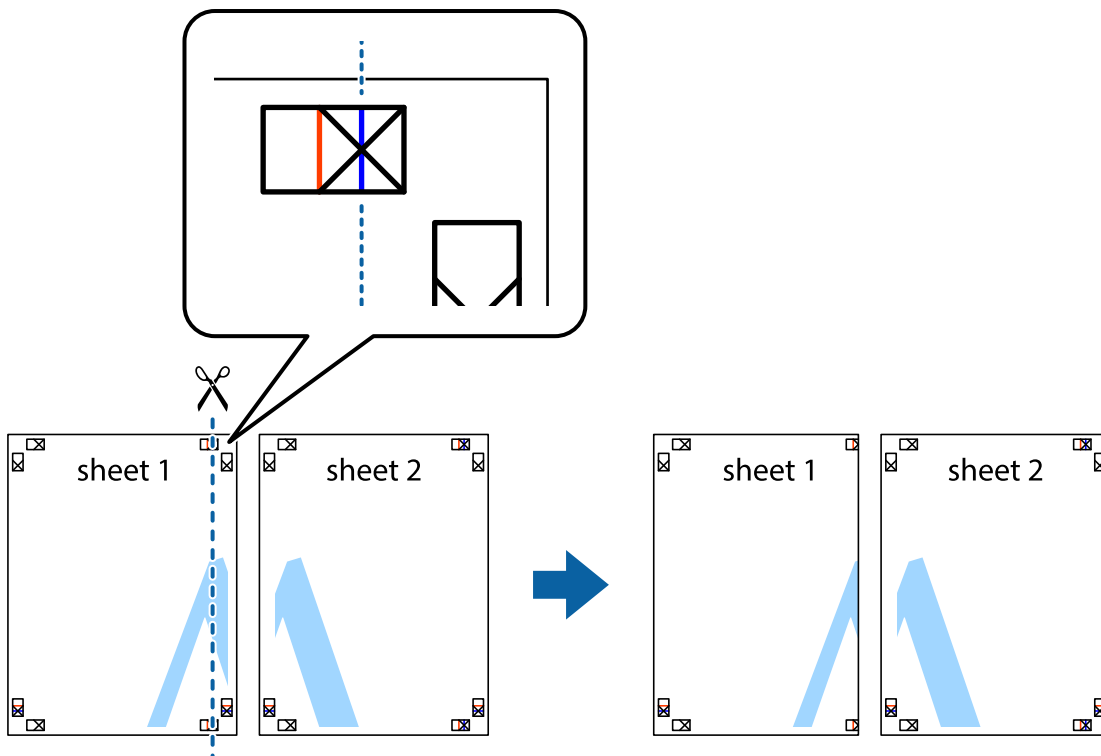

2. Place the edge of Sheet 1 on top of Sheet 2 and align the cross marks, then temporarily tape the two sheets together from the back.

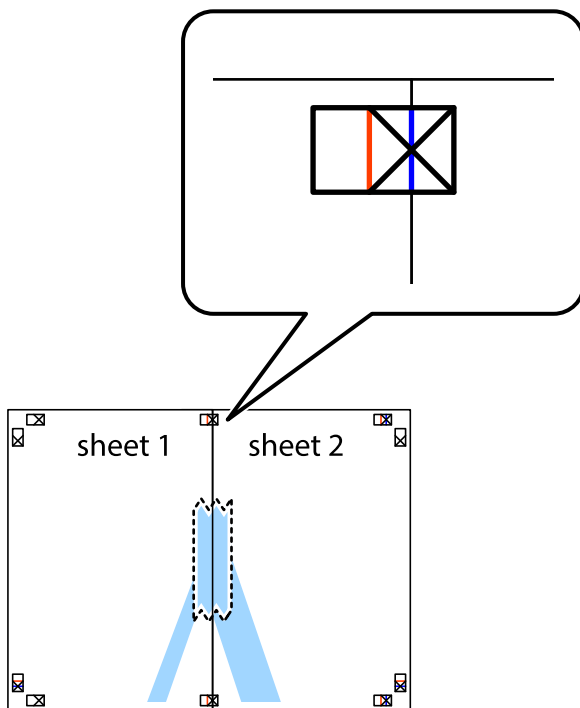

3. Cut the taped sheets in two along the vertical red line through the alignment markers (this time, the line to the left of the cross marks).

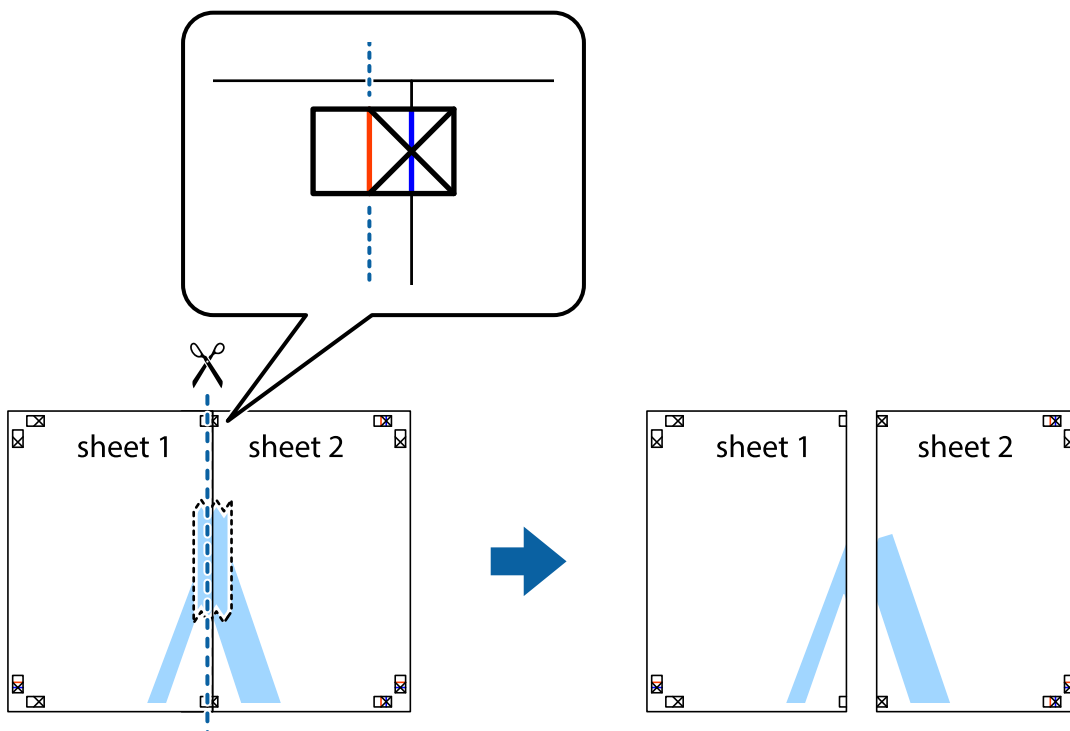

4. Tape the sheets together from the back.

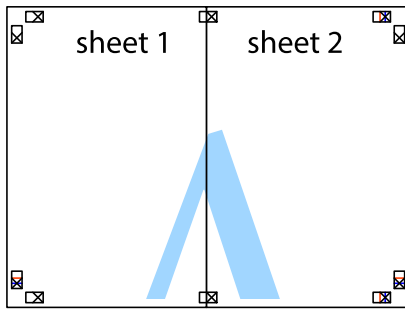

5. Repeat steps 1 to 4 to tape Sheet 3 and Sheet 4 together.
6. Cut off the margins of Sheet 1 and Sheet 2 along the horizontal blue line through the center of the left and right side cross marks.

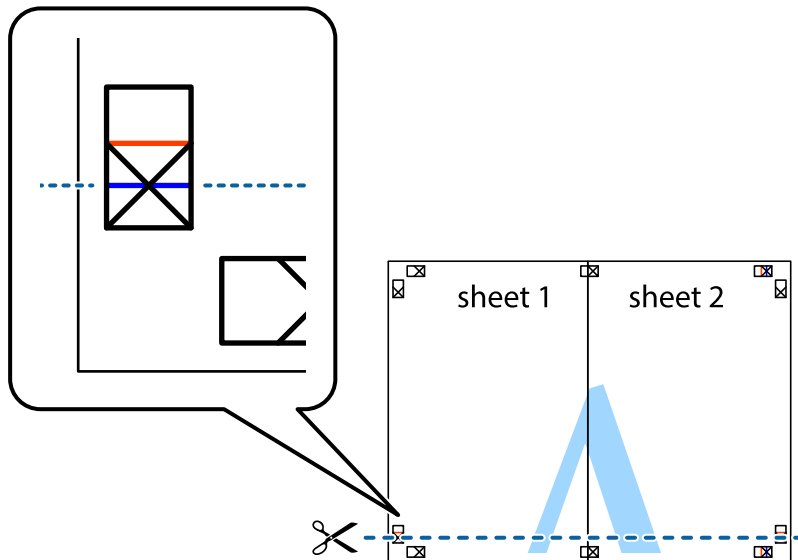

7. Place the edge of Sheet 1 and Sheet 2 on top of Sheet 3 and Sheet 4 and align the cross marks, and then temporarily tape them together from the back.

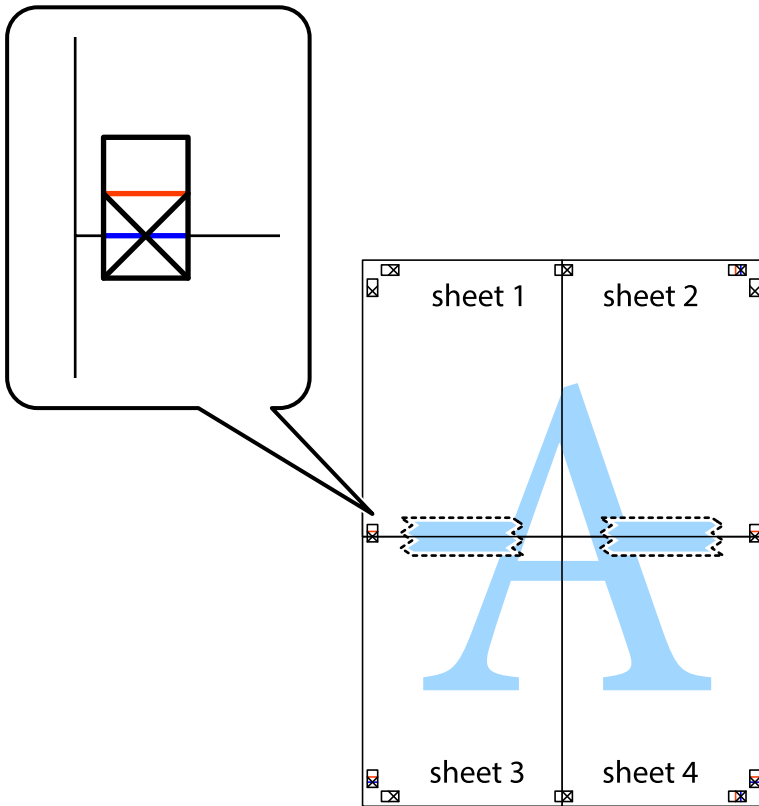

- Cut the taped sheets in two along the horizontal red line through the alignment markers (this time, the line above the cross marks).

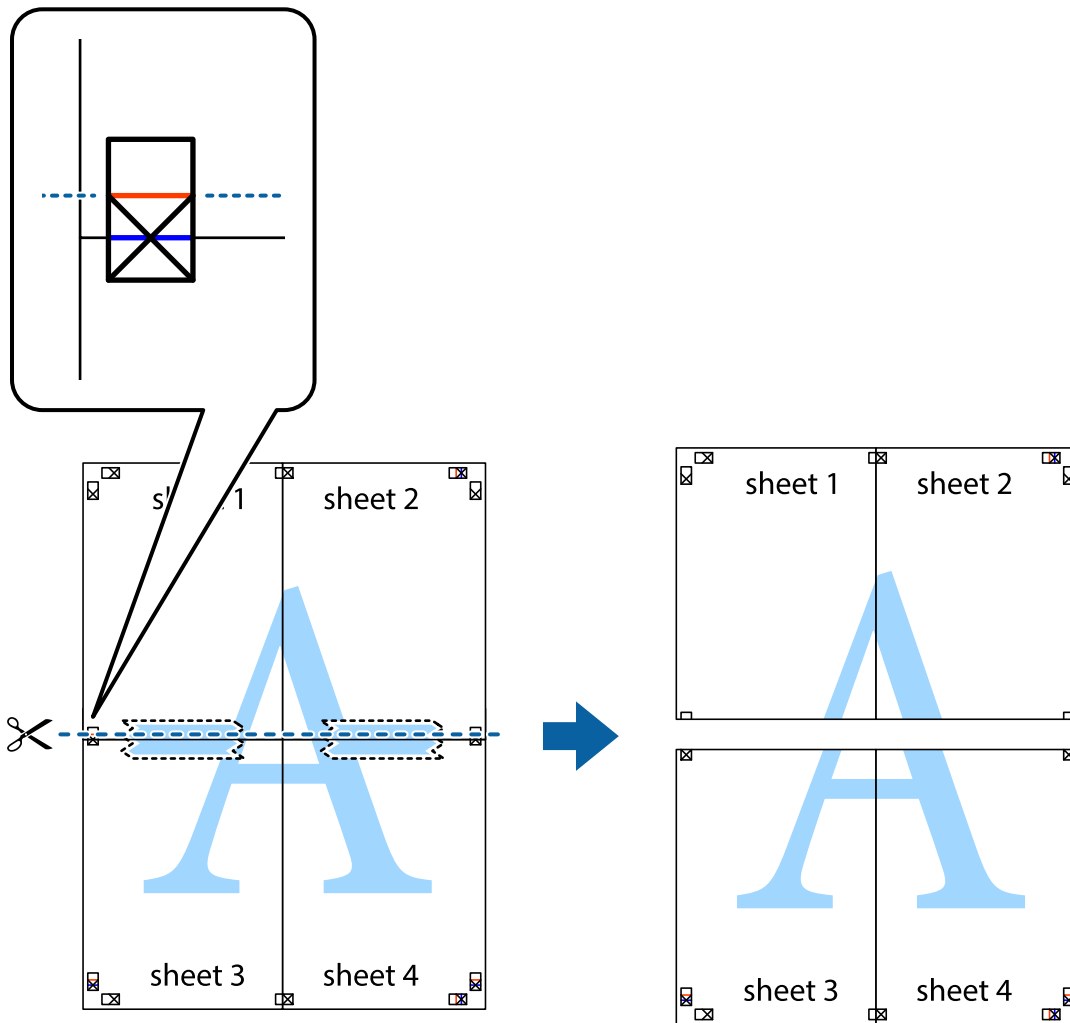

- Tape the sheets together from the back.

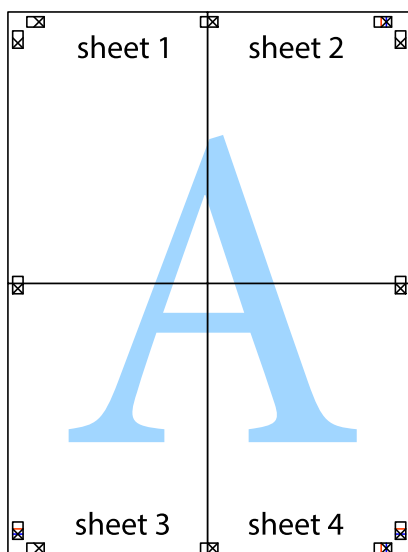

10. Cut off the remaining margins along the outer guide.

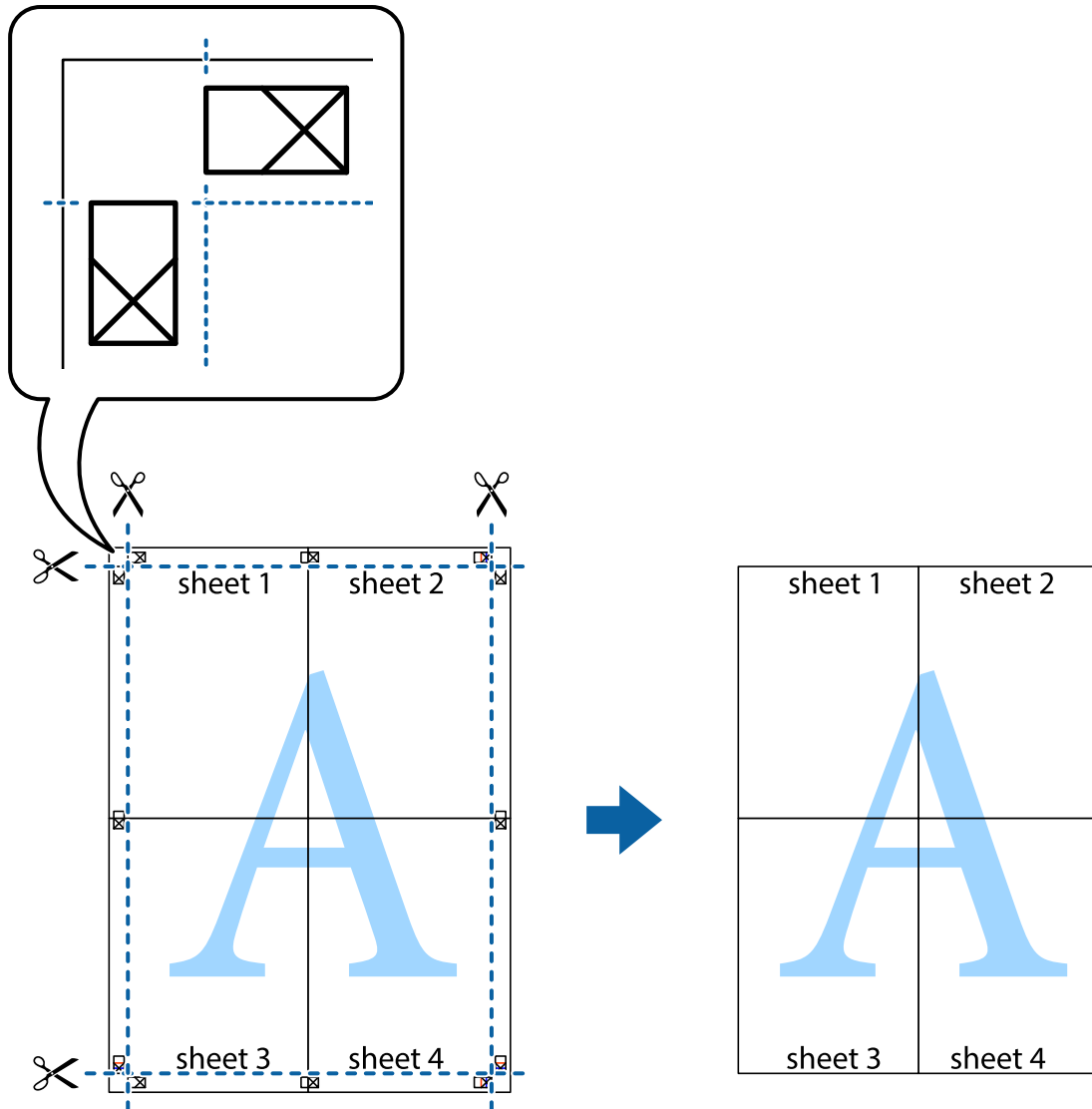

Printing with a Header and Footer

You can print information such as a user name and printing date in headers or footers.

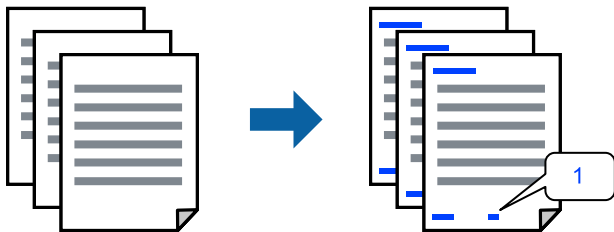

Access the printer driver, and then make the following settings.

More Options tab > **Watermark Features** > **Header/Footer**

Printing an Anti-Copy Pattern

You can print an anti-copy pattern on your printouts. When printing, the letters themselves are not printed and the entire print is screen-toned lightly. The hidden letters appear when photocopied to easily distinguish the original from the copies.



Anti-Copy Pattern is available under the following conditions:

- Paper Type: Plain paper
- Quality: Standard, Standard-Vivid
- Borderless: Not selected
- Color Correction: Automatic

Access the printer driver, and then make the following settings.

More Options tab > **Watermark Features** > **Anti-Copy Pattern**

Printing Multiple Files Together

Job Arranger Lite allows you to combine several files created by different applications and print them as a single print job. You can specify the print settings for combined files, such as multi-page layout, and 2-sided printing.

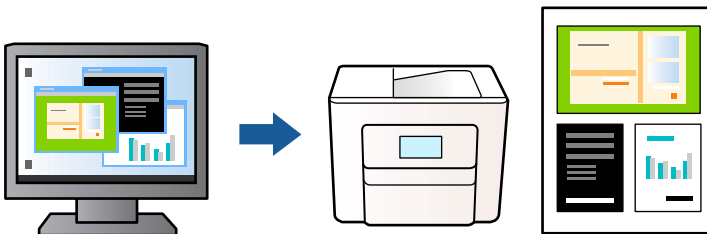

1. On the printer driver's **Main** tab, select **Job Arranger Lite**, and then click **OK**.
2. Click **Print**.
When you start printing, the Job Arranger Lite window is displayed.
3. With the Job Arranger Lite window opened, open the file that you want to combine with the current file, and then repeat the above steps.
4. When you select a print job added to Print Project in the Job Arranger Lite window, you can edit the page layout.

5. Click **Print** from the **File** menu to start printing.

Note:

If you close the Job Arranger Lite window before adding all the print data to the Print Project, the print job you are currently working on is canceled. Click **Save** from the **File** menu to save the current job. The extension of the saved files is ".ecl".

To open a Print Project, click **Job Arranger Lite** on the printer driver's **Maintenance** tab to open the Job Arranger Lite window. Next, select **Open** from the **File** menu to select the file.

Printing Using the Color Universal Print Feature

You can enhance the visibility of texts and images in printouts.

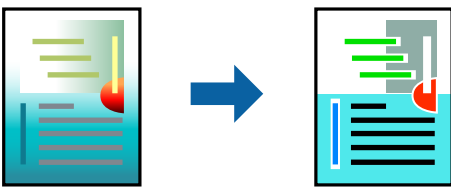

Color Universal Print is only available when the following settings are selected.

- Paper Type: Plain paper
- Quality: Standard or a higher quality
- Color: Color
- Applications: Microsoft® Office 2007 or later
- Text Size: 96 pts or smaller

Access the printer driver, and then make the following settings.

More Options tab > **Color Correction** > **Image Options** > **Color Universal Print**

Adjusting the Print Color

You can adjust the colors used in the print job. These adjustments are not applied to the original data.

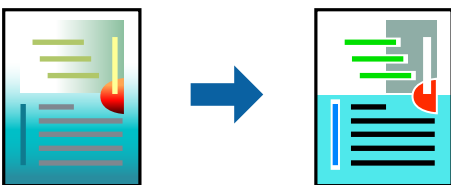

Access the printer driver, and then make the following settings.

More Options tab > **Color Correction** > **Custom** > **Advanced**, etc.

Printing to Emphasize Thin Lines

You can thicken thin lines that are too thin to print.

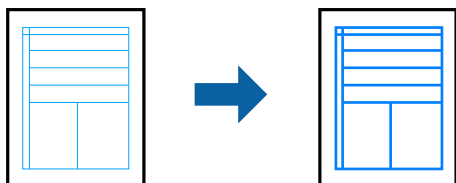

Access the printer driver, and then make the following settings.

More Options tab > **Color Correction** > **Image Options** > **Emphasize Thin Lines**

Printing Clear Bar Codes

If printed bar codes cannot be read correctly, you can print clearly using reduced ink bleeding. Only enable this feature if the bar code you printed cannot be scanned. Deblurring may not always be possible depending on the circumstances.

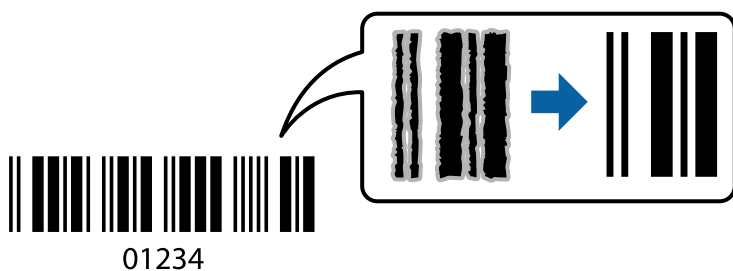

You can use this feature for the following paper types and print quality.

- Plain paper: Standard, Standard-Vivid
- Envelope: Standard

Access the printer driver, and then make the following settings.

Maintenance tab > **Extended Settings** > **Barcode mode**

Printing Documents from Smart Devices

You can print documents from a smart device such as a smartphone or tablet.

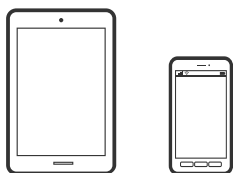

Printing Using Epson Smart Panel

Epson Smart Panel is an application that allows you to perform printer operations easily including printing, copying, or scanning from a smart device such as a smartphone or tablet. You can connect the printer and smart device over a wireless network, check the ink levels and printer status, and check for solutions if an error occurs. You can also copy easily by registering a copy favorite.



Install Epson Smart Panel from the following URL or QR code.

<https://support.epson.net/smpdl/>



Start Epson Smart Panel, and then select the print menu on the home screen.

Printing Documents Using AirPrint

AirPrint enables instant wireless printing from iPhone, iPad, iPod touch, and Mac without the need to install drivers or download software.



Note:

If you disabled paper configuration messages on your printer control panel, you cannot use AirPrint. See the link below to enable the messages, if necessary.

1. Set up your printer for wireless printing. See the link below.
<https://epson.sn>
2. Connect your Apple device to the same wireless network that your printer is using.
3. Print from your device to your printer.

Note:

For details, see the AirPrint page on the Apple website.

Related Information

➔ [“Cannot Print Even Though a Connection has been Established \(iOS\)” on page 144](#)

Printing Using Epson Print Enabler

You can wirelessly print your documents, emails, photos, and web pages right from your Android phone or tablet (Android v4.4 or later). With a few taps, your Android device will discover an Epson printer that is connected to the same wireless network.

Search for and install Epson Print Enabler from Google Play.

Go to **Settings** on your Android device, select **Printing**, and then enable Epson Print Enabler. From an Android application such as Chrome, tap the menu icon and print whatever is on the screen.

Note:

*If you do not see your printer, tap **All Printers** and select your printer.*

Printing Using Mopria Print Service

Mopria Print Service enables instant wireless printing from Android smart phones or tablets.

Install Mopria Print Service from Google Play.



For more details, access the Mopria Web site at <https://mopria.org>.

Printing on Envelopes

Printing on Envelopes from a Computer (Windows)

1. Load envelopes in the printer.
“Loading Envelopes” on page 33
2. Open the file you want to print.
3. Access the printer driver window.
4. Select the envelope size from **Document Size** on the **Main** tab, and then select **Envelope** from **Paper Type**.
5. Set the other items on the **Main** and **More Options** tabs as necessary, and then click **OK**.
6. Click **Print**.

Printing on Envelopes from a Computer (Mac OS)

1. Load envelopes in the printer.
“Loading Envelopes” on page 33

2. Open the file you want to print.
3. Select **Print** from the **File** menu or another command to access the print dialog.
4. Select the size as the **Paper Size** setting.
5. Select **Print Settings** from the pop-up menu.
6. Select **Envelope** as the **Media Type** setting.
7. Set the other items as necessary.
8. Click **Print**.

Printing Photos

Printing Photos from a Computer

Epson Photo+ allows you to print photos easily and finely in various layouts on photo paper or CD/DVD labels (CD/DVD label printing is only supported by some models.). See the application's help for details.

Printing Web Pages

Printing Web Pages from a Computer

Epson Photo+ allows you to display web pages, crop the specified area, and then edit and print them. See the application's help for details.

Printing Web Pages from Smart Devices

Install Epson Smart Panel from the following URL or QR code.

<https://support.epson.net/smpdl/>



Open the web page you want to print in your web browser app. Tap **Share** from the menu of the web browser application, select **Smart Panel**, and then start printing.

Printing Using a Cloud Service

By using Epson Connect service available on the Internet, you can print from your smartphone, tablet PC, or laptop, anytime and practically anywhere. To use this service, you need to register the user and the printer in Epson Connect.

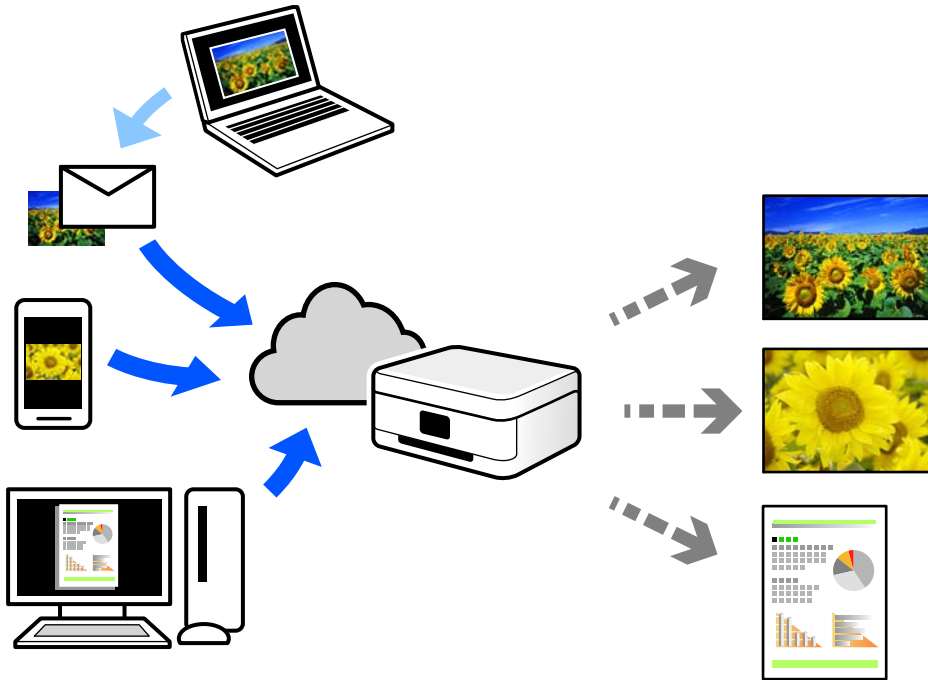

The features available on the Internet are as follows.

Email Print

When you send an email with attachments such as documents or images to an email address assigned to the printer, you can print that email and the attachments from remote locations such as your home or office printer.

Remote Print Driver

This is a shared driver supported by Remote Print Driver. When printing using a printer in a remote location, you can print by changing the printer on the usual applications window.

See the Epson Connect web portal for details on how to setup or print.

<https://www.epsonconnect.com/>

<http://www.epsonconnect.eu> (Europe only)

Copying

| | |
|--|----|
| Copying in Color or Monochrome. | 60 |
| Copying by Enlarging or Reducing. | 61 |
| Copying Multiple Originals onto One Sheet. | 61 |
| Copying ID card. | 63 |
| Copying Without Margins. | 64 |
| More Menu Options for Copying. | 64 |

Copying in Color or Monochrome

This section explains the steps for copying originals in color or monochrome.

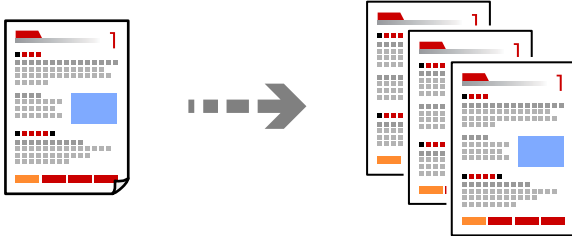

1. Load paper in the printer.
[“Loading Paper in the Rear Paper Feeder” on page 31](#)
2. Place the originals.
[“Placing Originals on the Scanner Glass” on page 37](#)

3. Select **Copy** on the home screen.

To select an item, use the ▲ ▼ ◀ ▶ buttons, and then press the OK button.

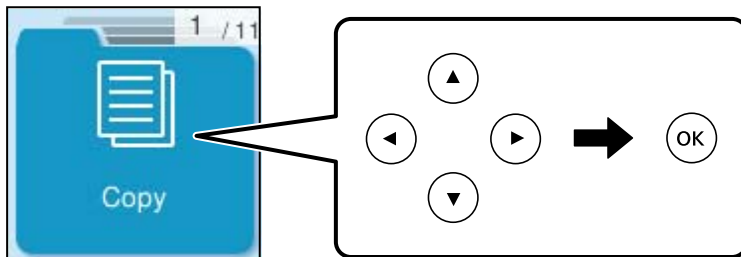

4. Select **Color** or **B&W**.
5. Set the number of copies as necessary.
6. Press the ◊ button.

Note:

The color, size, and border of the copied image are slightly different from the original.

Related Information

- ➔ [“More Menu Options for Copying” on page 64](#)

Copying by Enlarging or Reducing

You can copy originals at a specified magnification.

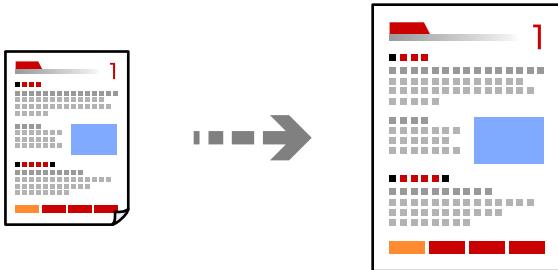

Copy > More > Print Settings > Settings > Reduce/Enlarge

Related Information

➔ [“More Menu Options for Copying” on page 64](#)

Copying Multiple Originals onto One Sheet

You can copy the multiple originals onto a single sheet.

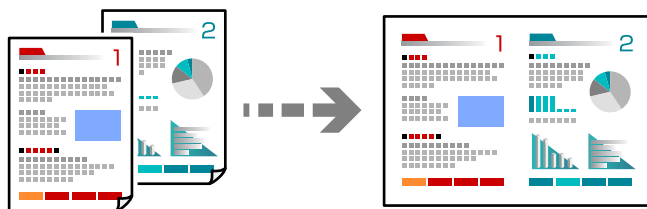

Copy > 2-upColor

When placing originals, place them face-down as shown below.

❑ Copying originals horizontally

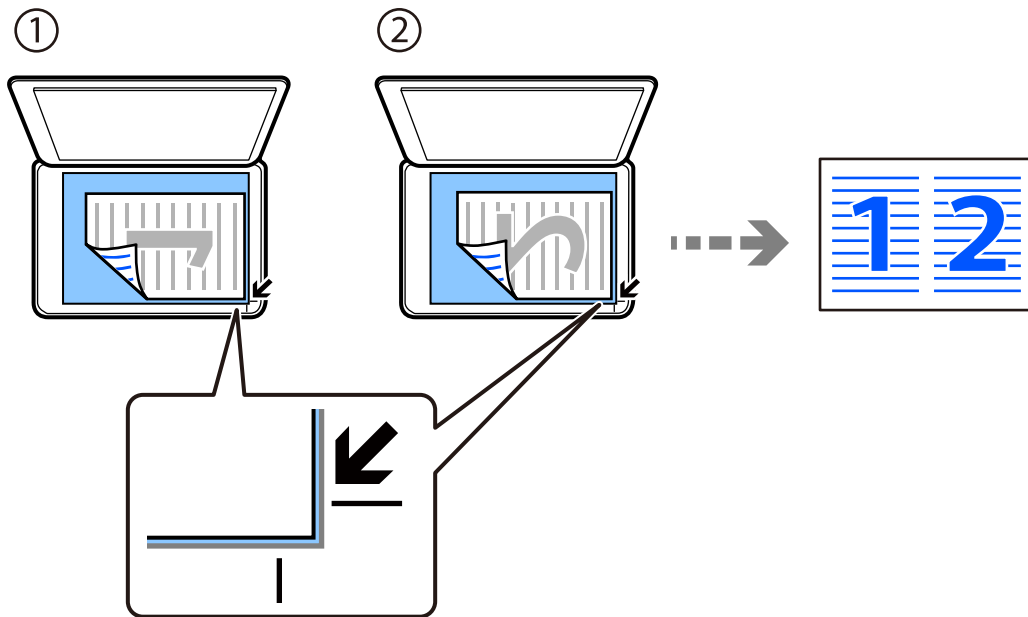

❑ Copying originals vertically

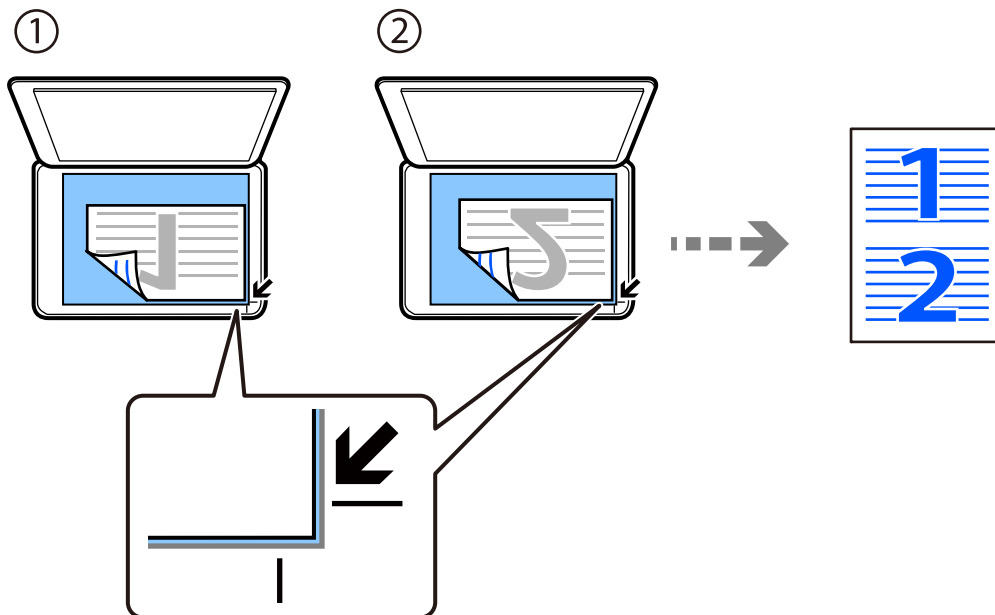

Note:

You can also select **More** to change the settings. See the related information below for explanations of the setting items.

Related Information

➔ [“More Menu Options for Copying” on page 64](#)

Copying ID card

Scans both sides of an ID card and copies onto one side of A4 size paper.

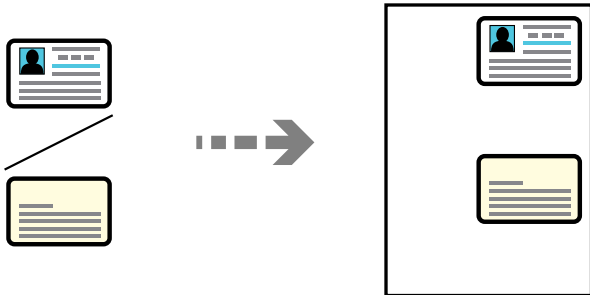

Copy > More > Print Settings > Settings > ID Card Copy

Place the original face-down and slide it to the corner mark. Place an ID card 5 mm away from the corner mark of the scanner glass.

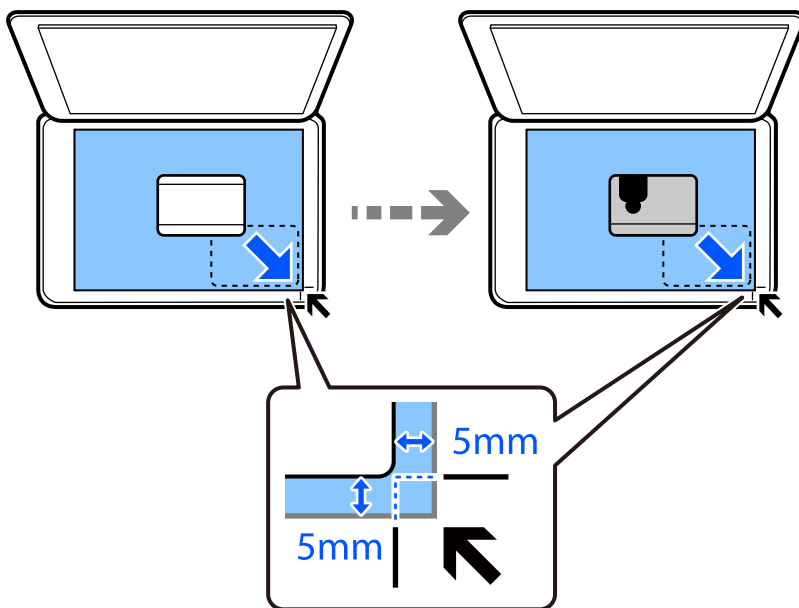

Related Information

➔ [“More Menu Options for Copying” on page 64](#)

Copying Without Margins

Copies without margins around the edges. The image is enlarged a little to remove margins from the edges of the paper.

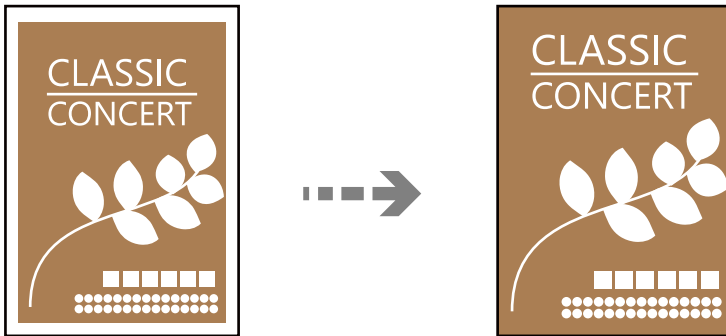

Copy > More > Print Settings > Settings > Borderless Copy

Related Information

➔ [“More Menu Options for Copying” on page 64](#)

More Menu Options for Copying

You can make these settings from **Copy > More** on the home screen.

The number of copies:

Enter the number of copies.

B&W:

Copies the original in black and white (monochrome).

Color:

Copies the original in color.

Print Settings:

The print settings screen is displayed. To change the settings, press the ▼ button.

Density:

Increase the level of density when the copying results are faint. Decrease the level of density when ink smears.

Paper Setting:

Select the paper size and the paper type you loaded.

Reduce/Enlarge:

Configures the magnification ratio for enlargement or reduction. Select the magnification from the menu according to the paper and original you want to print.

Auto Fit :

Detects the scan area and automatically enlarges or reduces the original to fit to the paper size you selected.

Custom Size:

Specifies the magnification used to enlarge or reduce the original within a range of 25 to 400%.

Original Size:

Select the size of your original. When copying non-standard size originals, select the size closest to your original.

Multi-Page:

Select the copy layout.

Single Page

Copies a single-sided original onto a single sheet.

2-up

Copies two single-sided originals onto a single sheet in 2-up layout. Select the layout order and the orientation of your original.

Quality:

Select the quality for copying. Selecting **High** provides higher quality printing, but the printing speed may be slower.

ID Card Copy:

Scans both sides of an ID card and copies onto one side of a paper.

Borderless Copy:

Copies without margins around the edges. The image is enlarged a little to remove margins from the edges of the paper. Select how much to enlarge in the **Expansion** setting.

Scanning

| | |
|---|----|
| Available Scanning Methods. | 67 |
| Scanning Originals to a Computer. | 67 |
| Scanning Using WSD. | 68 |
| Scanning Originals to a Smart Device. | 71 |

Available Scanning Methods

You can use any of the following methods to scan using this printer.

Scanning to a Computer

You can save the scanned image to a computer connected to the printer.

[“Scanning Originals to a Computer” on page 67](#)

Scanning Using WSD

You can save the scanned image to a computer connected to the printer, using WSD feature.

[“Scanning Using WSD” on page 68](#)

Scanning Directly from Smart Devices

You can save scanned images directly to a smart device such as a smart phone or tablet by using the Epson Smart Panel application on the smart device.

[“Scanning Originals to a Smart Device” on page 71](#)

Scanning Originals to a Computer

Note:

To use this feature, make sure the following applications are installed on your computer.

- Epson ScanSmart (Windows 7 or later, or OS X El Capitan (10.11) or later)
- Epson Event Manager (Windows Vista/Windows XP, or OS X Yosemite (10.10)/OS X Mavericks (10.9.5))
- Epson Scan 2 (application required to use the scanner feature)

See the following to check for installed applications.

Windows 11: Click the start button, and then check the **All apps** > **Epson Software** folder > **Epson ScanSmart**, and the **EPSON** folder > **Epson Scan 2**.

Windows 10: Click the start button, and then check the **Epson Software** folder > **Epson ScanSmart**, and the **EPSON** folder > **Epson Scan 2**.

Windows 8.1/Windows 8: Enter the application name in the search charm, and then check the displayed icon.

Windows 7: Click the start button, and then select **All Programs**. Next, check the **Epson Software** folder > **Epson ScanSmart**, and the **EPSON** folder > **Epson Scan 2**.

Windows Vista/Windows XP: Click the start button, and then select **All Programs** or **Programs**. Next, check the **Epson Software** folder > **Epson Event Manager**, and the **EPSON** folder > **Epson Scan 2**.

Mac OS: Select **Go** > **Applications** > **Epson Software**.

1. Place the originals.

[“Placing Originals” on page 35](#)

2. Select **Scan to Computer** on the control panel.

To select an item, use the ▲ ▼ ◀ ▶ buttons, and then press the OK button.

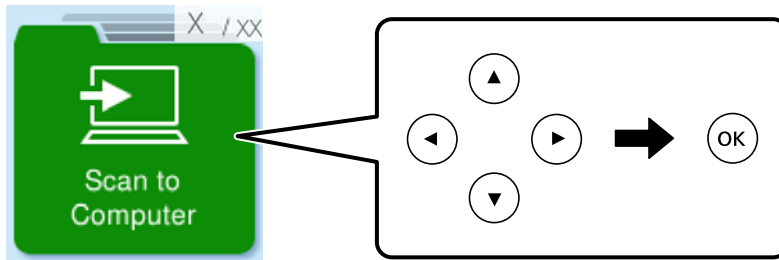

3. Select how to save the scanned image to a computer.
 - Preview on Computer (Windows 7 or later, or OS X El Capitan (10.11) or later): Previews the scanned image on a computer before saving images.
 - Save as JPEG: Saves the scanned image in JPEG format.
 - Save as PDF: Saves the scanned image in PDF format.
4. If the **Select Computer** screen is displayed, select a computer on which to save the scanned images.
5. Press the ◊ button.

When using Windows 7 or later, or OS X El Capitan (10.11) or later: Epson ScanSmart automatically starts on your computer, and scanning starts.

Note:

- See the *Epson ScanSmart help* for detailed operation information for the software. Click **Help** on the Epson ScanSmart screen to open the help.
- You can not only start scanning from the printer but also from your computer by using Epson ScanSmart.

Scanning Using WSD

You can save the scanned image to a computer connected to the printer, using WSD feature.

- This feature is only available for computers running Windows Vista or later.
- If you are using Windows 7/Windows Vista, you need to setup your computer in advance using this feature. [“Setting Up a WSD Port” on page 69](#)

1. Place the originals.
[“Placing Originals on the Scanner Glass” on page 37](#)

2. Select **To WSD** on the control panel.

To select an item, use the ▲ ▼ ◀ ▶ buttons, and then press the OK button.

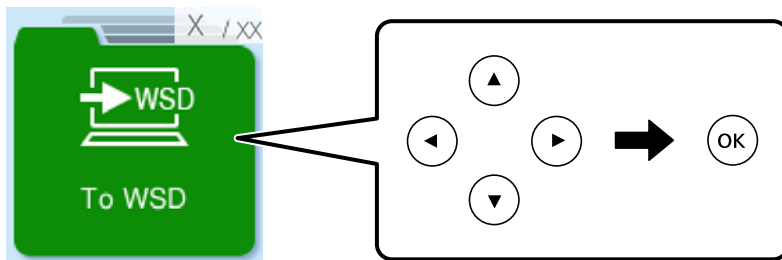

3. Select a computer.
4. Press the ◊ button.

Setting Up a WSD Port

This section explains how to set up a WSD port for Windows 7/Windows Vista.

Note:

For Windows 8 or later, the WSD port is set up automatically.

The following is necessary to set up a WSD port.

- The printer and the computer are connected to the network.
- The printer driver is installed on the computer.

1. Turn the printer on.
2. Click start, and then click **Network** on the computer.
3. Right-click the printer, and then click **Install**.

Click **Continue** when the **User Account Control** screen is displayed.

Click **Uninstall** and start again if the **Uninstall** screen is displayed.

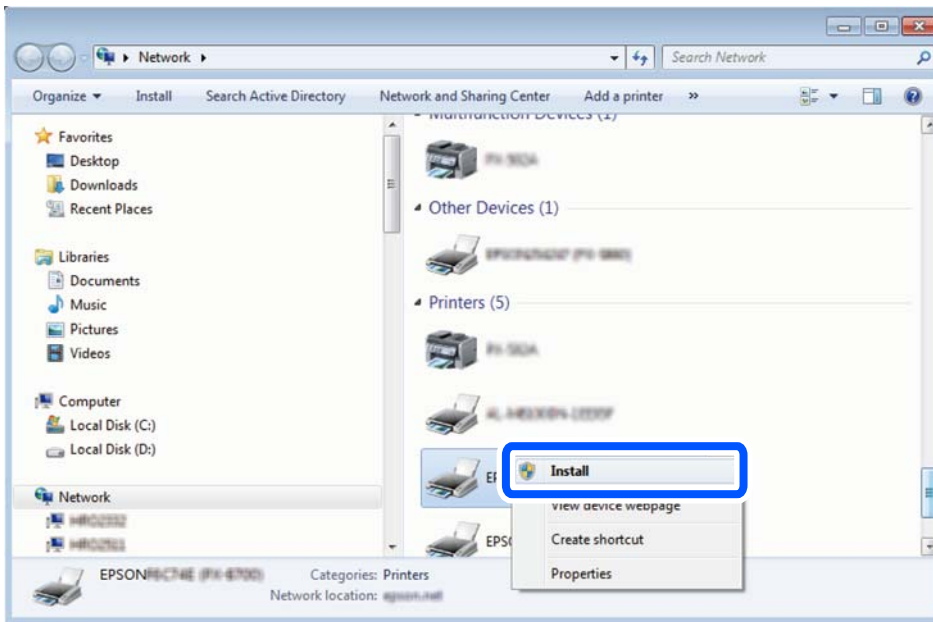

Note:

The printer name you set on the network and model name (EPSON XXXXXX (XX-XXXX)) are displayed on the network screen. You can check the printer's name set on the network from the printer's control panel or by printing a network status sheet.

4. Click **Your device is ready to use**.

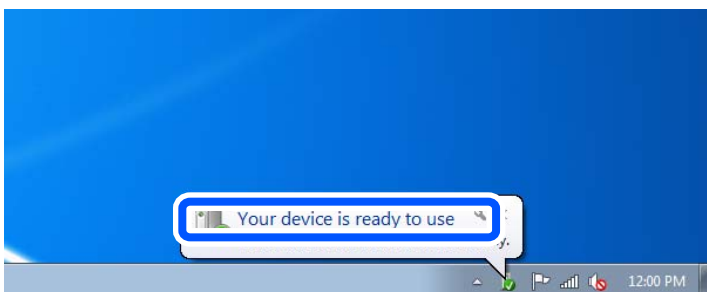

5. Check the message, and then click **Close**.

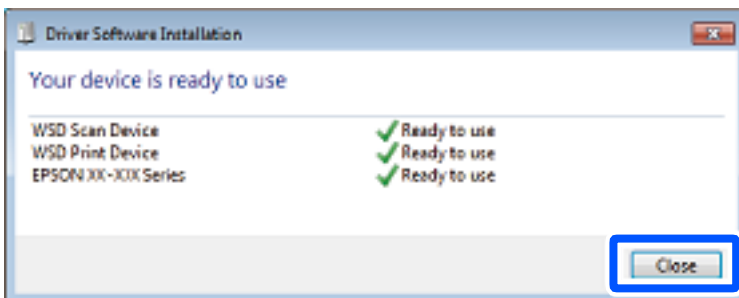

6. Open the **Devices and Printers** screen.

- ❑ Windows 7

Click start > **Control Panel** > **Hardware and Sound** (or **Hardware**) > **Devices and Printers**.

- ❑ Windows Vista

Click start > **Control Panel** > **Hardware and Sound** > **Printers**.

7. Check that an icon with the printer's name on the network is displayed.
Select the printer name when using with WSD.

Scanning Originals to a Smart Device

Note:

Before scanning, install Epson Smart Panel on your smart device.

1. Place the originals.
[“Placing Originals” on page 35](#)
2. Start Epson Smart Panel on your smart device.
3. Select scan menu on the home screen.
4. Follow the on-screen instructions to scan and save the images.

Faxing

| | |
|--|-----|
| Before Using Fax Features. | 73 |
| Overview of this Printer's Fax Features. | 83 |
| Sending Faxes Using the Printer. | 86 |
| Receiving Faxes on the Printer. | 89 |
| Menu Options for Faxing. | 92 |
| Using Other Faxing Features. | 95 |
| Sending a Fax from a Computer. | 95 |
| Receiving Faxes on a Computer. | 100 |

Before Using Fax Features

Faxing feature is available only for ET-4810 Series/L5590 Series.

Check the following before you start using the fax features.

- The printer and the phone line, and (if it is being used) the phone machine are connected correctly
- Fax basic settings (Fax Setting Wizard) is complete
- Other necessary Fax Settings are complete

See "Related Information" below to make settings.

Related Information

- ➔ [“Connecting the Printer to a Phone Line” on page 73](#)
- ➔ [“Making the Printer Ready to Send and Receive Faxes” on page 76](#)
- ➔ [“Making Settings for the Printer's Fax Features According to Use” on page 78](#)
- ➔ [“Fax Settings” on page 217](#)
- ➔ [“Making Contacts Available” on page 81](#)
- ➔ [“User Default Settings Menu” on page 222](#)

Connecting the Printer to a Phone Line

Compatible Telephone Lines

You can use the printer over standard analogue telephone lines (PSTN = Public Switched Telephone Network) and PBX (Private Branch Exchange) telephone systems.

You may not be able to use the printer with the following phone lines or systems.

- VoIP phone line such as DSL or fiber-optic digital service
- Digital phone line (ISDN)
- Some PBX telephone systems
- When adapters such as terminal adapters, VoIP adapters, splitters, or DSL router are connected between the telephone wall jack and the printer

Related Information

- ➔ [“Connecting the Printer to a Phone Line” on page 73](#)

Connecting the Printer to a Phone Line

Connect the printer to a telephone wall jack using an RJ-11 (6P2C) phone cable. When connecting a telephone to the printer, use a second RJ-11 (6P2C) phone cable.

Depending on the area, a phone cable may be included with the printer. If it is included, use that cable.

You may need to connect the phone cable to an adapter provided for your country or region.

Note:

Remove the cap from the EXT. port of the printer only when connecting your telephone to the printer. Do not remove the cap if you are not connecting your telephone.

In areas where lightning strikes occur frequently, we recommend that you use a surge protector.

Connecting to a Standard Phone Line (PSTN) or PBX

Connect a phone cable from the telephone wall jack or PBX port to the LINE port on the back of the printer.

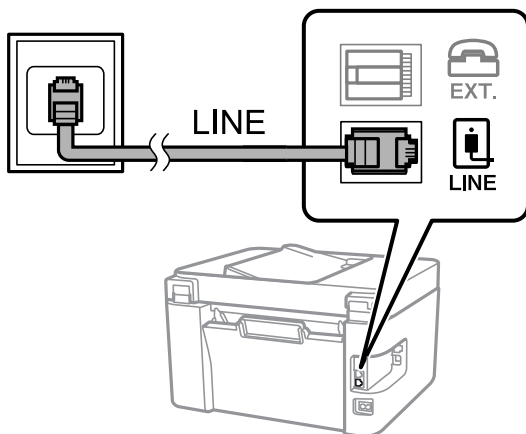

Related Information

➔ [“Connecting Your Phone Device to the Printer” on page 75](#)

Connecting to DSL or ISDN

Connect a phone cable from the DSL modem or the ISDN terminal adapter to the LINE port on the back of the printer. See the documentation provided with the modem or the adapter for more details.

Note:

If your DSL modem is not equipped with a built-in DSL filter, connect a separate DSL filter.

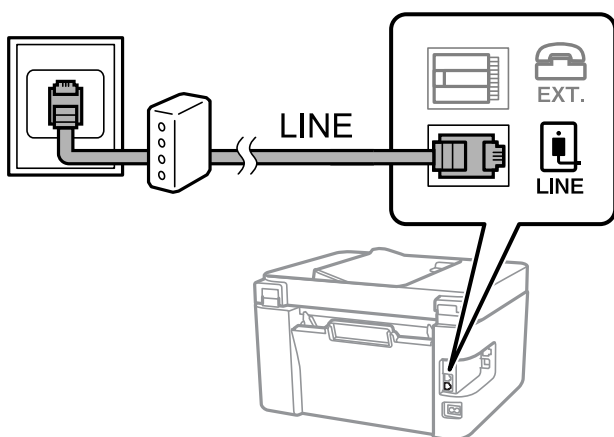

Related Information

➔ [“Connecting Your Phone Device to the Printer” on page 75](#)

Connecting Your Phone Device to the Printer

When using the printer and your telephone on a single phone line, connect the telephone to the printer.

Note:

- ❑ If your phone device has a fax function, disable the fax function before connecting. See the manuals that came with the phone device for details. Depending on the model of the phone device, the fax function cannot be completely disabled, so you may not be able to use it as an external phone.
- ❑ If you connect an answering machine, make sure the printer's **Rings to Answer** setting is set higher than the number of rings your answering machine is set to answer a call.

1. Remove the cap from the EXT. port on the back of the printer.

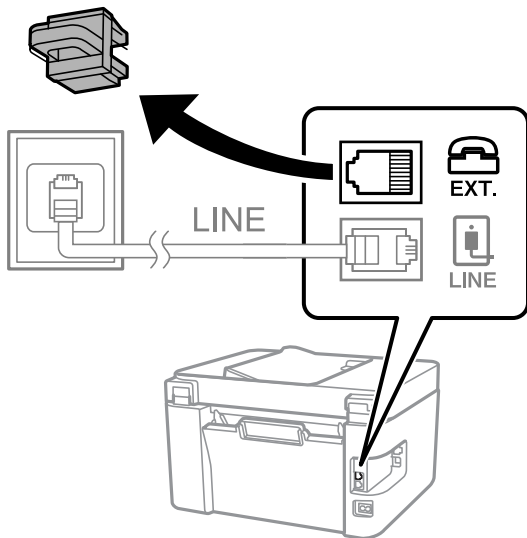

2. Connect the phone device and the EXT. port with a phone cable.

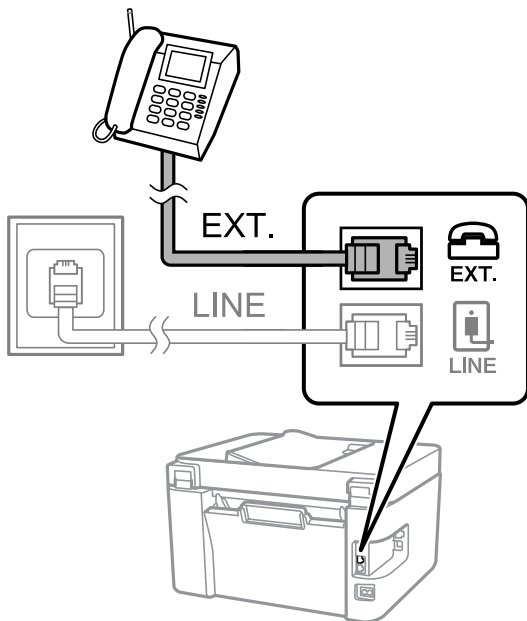

Note:

When sharing a single phone line, make sure you connect the phone device to the EXT. port of the printer. If you split the line to connect the phone device and the printer separately, the phone and the printer do not work correctly.

3. Select **Fax** on the printer's control panel.

To select an item, use the ▲ ▼ ◀ ▶ buttons, and then press the OK button.

4. Pick up the handset.

If a message to start sending or receiving faxes is displayed as shown on the following screen, the connection has been established.



Related Information

- ➔ [“Making the Printer Ready to Send and Receive Faxes” on page 76](#)
- ➔ [“Making Settings to Use an Answering Machine” on page 79](#)
- ➔ [“Making Settings to Receive Faxes Operating Only a Connected Phone \(Remote Receive\)” on page 79](#)
- ➔ [“Receive Mode:” on page 219](#)

Making the Printer Ready to Send and Receive Faxes

Fax Setting Wizard configures the basic fax features to make the printer ready to send and receive faxes.

The Wizard is displayed automatically when the printer is turned on for the first time. You can also display the wizard manually from the printer's control panel. You need to run the wizard again in case the wizard is skipped when the printer is first turned on or when the connection environment has changed.

- The items below are what you can set through the wizard.

- Header (Your Phone Number and Fax Header)**

- Receive Mode (Auto or Manual)**

- DRD Setting**

- The items below are set automatically according to the connection environment.

- Dial Mode (such as Tone or Pulse)**

Fax Setting Wizard may not configure **Dial Mode** automatically when **Line Type** is set to **PBX**. Configure **Dial Mode** manually.

- Other items in **Basic Settings** remain as they are.

Related Information

- ➔ [“Basic Settings Menu” on page 217](#)

Making the Printer Ready to Send and Receive Faxes Using Fax Setting Wizard

1. Select **Settings** on the home screen on the printer's control panel.

To select an item, use the ▲ ▼ ◀ ▶ buttons, and then press the OK button.

2. Select **Fax Settings > Fax Setting Wizard**.

3. Following the on-screen instructions, enter the sender name such as your company name, your fax number.

Note:

Your sender name and your fax number appear as the header for outgoing faxes.

4. Make the distinctive ring detection (DRD) setting.

- If you have subscribed to a distinctive ring service from your telephone company:

Go to the next screen and select the ring pattern to be used for incoming faxes.

When you select any item except **All**, **Receive Mode** is set to **Auto** and you continue to the next screen where you can check the settings you made.

- If you have not subscribed to a distinctive ring service from your telephone company, or you do not need to set this option:

Skip this setting and go to the screen where you can check the settings you made.

Note:

- Distinctive ring services, offered by many telephone companies (the service name differs by company), allows you to have several phone numbers on one phone line. Each number is assigned a different ring pattern. You can use one number for voice calls and another for fax calls. Select the ring pattern assigned to fax calls in **DRD**.*

- Depending on the region, **On** and **Off** are displayed as the **DRD** options. Select **On** to use the distinctive ring feature.*

5. Make the Receive Mode setting.

- If you do not need to connect a phone device to the printer:

Select **No**.

Receive Mode is set to **Auto**.

- If you need to connect a phone device to the printer:

Select **Yes**, and then select whether or not to receive faxes automatically.

6. Check the settings you made on the screen displayed, and then proceed to the next screen.

To correct or change settings, press the ↶ button.

7. Check the fax connection by selecting **Start Checking**, and then select **Print** to print a report that shows the connection status.

Note:

- If there are any errors reported, follow the instructions on the report to solve them.*

- If the **Select Line Type** screen is displayed, select the line type.*

- *When you are connecting the printer to a PBX phone system or terminal adapter, select **PBX**.*

- *When you are connecting the printer to a standard phone line, select **PSTN**. When the message to disable dial tone detection is shown on the screen, press the OK button. However, disabling dial tone detection may cause the printer to skip the first digit of a fax number when dialing and send the fax to the wrong number.*

Related Information

- ➔ [“Connecting the Printer to a Phone Line” on page 73](#)
- ➔ [“Making Settings to Use an Answering Machine” on page 79](#)
- ➔ [“Receive Mode:” on page 219](#)
- ➔ [“Making Settings to Receive Faxes Operating Only a Connected Phone \(Remote Receive\)” on page 79](#)
- ➔ [“Basic Settings Menu” on page 217](#)

Making Settings for the Printer's Fax Features According to Use

You can configure the printer's fax features individually using the printer's control panel according to use. The settings made using **Fax Setting Wizard** can also be changed. For more details, see the descriptions of the **Fax Settings** menu.

[“Fax Settings” on page 217](#)

Related Information

- ➔ [“Receiving Incoming Faxes” on page 90](#)
- ➔ [“Making Settings for a PBX Phone System” on page 78](#)
- ➔ [“Making Settings When You Connect a Phone Device” on page 79](#)
- ➔ [“Making Settings for Blocking Junk Faxes” on page 80](#)
- ➔ [“Making Settings to Send and Receive Faxes on a Computer” on page 80](#)

Making Settings for a PBX Phone System

Make the following settings when using the printer in offices that use extensions and require external access codes, such as 0 and 9, to get an outside line.

1. Select **Settings** on the printer's control panel.

To select an item, use the ▲ ▼ ◀ ▶ buttons, and then press the OK button.

2. Select **Fax Settings** > **Basic Settings**.

3. Select **Line Type**, and then select **PBX**.

4. When sending a fax to an outside fax number using # (hash) instead of the actual external access code, select **Use** as the **Access Code**.

The # entered instead of the actual access code, is replaced with the stored access code when dialing. Using # helps avoid connection problems when connecting to an outside line.

Note:

*You cannot send faxes to recipients in **Contacts** in which an external access code such as 0 or 9 is set.*

*If you have registered recipients in **Contacts** using an external access code such as 0 or 9, set the **Access Code** to **Do Not Use**. Otherwise, you must change the code to # in **Contacts**.*

5. Enter the external access code used for your phone system, and then press the OK button.

6. Press the OK button to apply the settings.

The access code is stored in the printer.

Related Information

➔ [“Basic Settings Menu” on page 217](#)

Making Settings When You Connect a Phone Device

Making Settings to Use an Answering Machine

You need settings to use an answering machine.

1. Select **Settings** on the home screen on the printer's control panel.
To select an item, use the ▲ ▼ ◀▶ buttons, and then press the OK button.
2. Select **Fax Settings** > **Basic Settings**.
3. Set **Receive Mode** to **Auto**.
4. Set the **Rings to Answer** setting of the printer to a higher number than the number of rings for the answering machine.

If **Rings to Answer** is set lower than the number of rings for the answering machine, the answering machine cannot receive voice calls to record voice messages. See the manuals that came with the answering machine for its settings.

The printer's **Rings to Answer** setting may not be displayed, depending on the region.

Related Information

➔ [“Basic Settings Menu” on page 217](#)

Making Settings to Receive Faxes Operating Only a Connected Phone (Remote Receive)

You can start receiving incoming faxes by only picking up the handset and operating the phone, without operating the printer at all.

The **Remote Receive** feature is available for telephones that support tone dialing.

1. Select **Settings** on the home screen on the printer's control panel.
To select an item, use the ▲ ▼ ◀▶ buttons, and then press the OK button.
2. Select **Fax Settings** > **Basic Settings** > **Remote Receive**.
3. Select **On**.
4. Enter a two digit code (you can enter 0 to 9, *, and #) as the start code, and then press the OK button to apply the settings.

Related Information

➔ [“Basic Settings Menu” on page 217](#)

Making Settings for Blocking Junk Faxes

You can block junk faxes.

1. Select **Settings** on the home screen on the printer's control panel.
To select an item, use the ▲ ▼ ◀▶ buttons, and then press the OK button.
2. Select **Fax Settings > Basic Settings > Rejection Fax**.
3. Set the condition to block junk faxes.
Select **Rejection Fax**, and then enable the following options.
 - Rejection Number List: Rejects faxes that are in the Rejection Number List.
 - Fax Header Blank: Rejects faxes that have blank header information.
 - Caller not in Contacts: Rejects faxes that have not been added to the contact list.
4. Press ↶ to return to the **Rejection Fax** screen.
5. If you are using the **Rejection Number List**, select **Edit Blocked Number list**, and then edit the list.

Related Information

➔ [“Basic Settings Menu” on page 217](#)

Making Settings to Send and Receive Faxes on a Computer

To send and receive faxes on a computer, FAX Utility must be installed on the computer connected by network or USB cable .

Making Save to Computer Setting to Receive Faxes

You can receive faxes on a computer by using the FAX Utility. Install FAX Utility on the client computer and make the setting. For details, see Basic Operations in the FAX Utility help (displayed on the main window).

The setting item below on the printer's control panel is set to **Yes**, and the faxes received can be saved on the computer.

Settings > Fax Settings > Receive Settings > Save to Computer

Making Save to Computer Setting to Also Print on the Printer to Receive Faxes

You can make the setting to print received faxes on the printer as well as save them on a computer.

1. Select **Settings** on the home screen on the printer's control panel.
To select an item, use the ▲ ▼ ◀▶ buttons, and then press the OK button.
2. Select **Fax Settings > Receive Settings**.
3. Select **Save to Computer > Yes and Print**.

Making Save to Computer Setting not to Receive Faxes

To set the printer not to save received faxes on the computer, change the settings on the printer.

Note:

You can also change the settings using the FAX Utility. However, if there are any faxes that have been unsaved to the computer, the feature does not work.

1. Select **Settings** on the home screen on the printer's control panel.
To select an item, use the ▲ ▼ ◀▶ buttons, and then press the OK button.
2. Select **Fax Settings > Receive Settings**.
3. Select **Save to Computer > No**.

Making Contacts Available

Registering a contacts list allows you to easily enter destinations. You can register up to 100 entries, and you can use the contacts list when you enter a fax number.

Registering or Editing Contacts

1. Select **Settings** on the home screen.
To select an item, use the ▲ ▼ ◀▶ buttons, and then press the OK button.
2. Select **Contacts Manager**.
3. Do one of the following.
 - To register a new contact, select **Add Entry**, and then select the registry number.
 - To edit a contact, select **Edit**, and then select the target contact .
 - To delete a contact, select **Delete**, select the target contact, and then select **Yes**. No further steps are necessary.
4. Make the necessary settings.

Note:

*When entering a fax number, enter an external access code at the beginning of the fax number if your phone system is PBX and you need the access code to get an outside line. If the access code has been set in the **Line Type** setting, enter a hash (#) instead of the actual access code. To add a pause (pause for three seconds) during dialing, enter a hyphen (-).*

5. Press the OK button to proceed, and then select **Add Entry** to complete registering or editing.

Registering or Editing Grouped Contacts

Adding contacts to a group allows you to send a fax to multiple destinations at the same time.

Note:

You can register up to 100 destinations and groups to the contacts list in total.

1. Select **Settings** on the home screen.
To select an item, use the ▲ ▼ ◀▶ buttons, and then press the OK button.
2. Select **Contacts Manager**.
3. Do one of the following.
 - To register a new group of contacts, select **Add Group**, and then select the registry number.
 - To edit a group of contacts, select **Edit**, and then select the target group.
 - To delete a group of contacts, select **Delete**, select the target group, and then select **Yes**. No further steps are necessary.
4. Enter or edit the **Group Name**, and then press the OK.
5. Enter or edit the **Index Word**, and then press the OK.
6. Select the contacts that you want to register in the group.
Each time you press the ▶ button, the contact is selected and deselected alternatively.
7. Press the OK button to proceed, and then select **Add Entry** to complete registering or editing.

Registering Contacts on a Computer

Using Web Config, you can create a contact list on your computer and import it to the printer.

1. Access Web Config.
2. Click **Log in**, enter the password, and then click **OK**.
3. Select **Contacts**.
4. Select the number that you want to register, and then click **Edit**.
5. Enter **Name**, **Index Word**, **Fax Number**, and **Fax Speed**.
6. Click **Apply**.

Related Information

➔ [“Application for Configuring Printer Operations \(Web Config\)” on page 210](#)

Destination Setting Items

| Items | Settings and Explanation |
|------------|---|
| Name | Enter a name displayed in the contacts in 30 characters or less in Unicode (UTF-8). If you do not specify this, leave it blank. |
| Index Word | Enter words to search in 30 characters or less in Unicode (UTF-8). If you do not specify this, leave it blank. |

| Items | Settings and Explanation |
|------------------------|--|
| Type | This item is fixed as Fax . You cannot change this setting. |
| Assign to Frequent Use | This item is not supported. |
| Fax Number | Enter between 1 and 64 characters using 0-9 - * # and space. |
| Fax Speed | Select a communication speed for a destination. |

Registering Destinations as a Group

1. Access Web Config.
2. Click **Log in**, enter the password, and then click **OK**.
3. Select **Contacts**.
4. Select the number that you want to register, and then click **Edit**.
5. Enter a **Name** and **Index Word**.
6. Select a group from **Type**.
7. Click **Select for Contact(s) for Group**.
The available destinations are displayed.
8. Select the destination that you want to register to the group, and then click **Select**.

Note:

Destinations can be registered to multiple groups.

9. Click **Apply**.

Related Information

➔ [“Application for Configuring Printer Operations \(Web Config\)” on page 210](#)

Overview of this Printer's Fax Features

Feature: Sending Faxes

Sending Methods

- Sending automatically

When you scan an original by pressing the  button to select **Send Fax**, the printer dials the recipients and sends the fax.

[“Sending Faxes Using the Printer” on page 86](#)

Sending manually

When you perform a manual check on the line connection by dialing the recipient, press the  button to select **Send Fax** to start sending a fax directly.

[“Sending Faxes Dialing from the External Phone Device” on page 87](#)

Recipient Designation when Sending a Fax

You can enter recipients using keypad buttons, **Contacts**, and **Recent**.

[“Selecting Recipients” on page 86](#)

[“Making Contacts Available” on page 81](#)

Scan Settings when Sending a Fax

You can select items such as **Resolution** or **Original Size (Glass)** when sending faxes.

[“Scan Settings” on page 92](#)

Using Fax Send Settings when Sending a Fax

You can use **Fax Send Settings** such as **Direct Send** (to send a large document stably) or **Send Fax Later** (to send a fax at a time you specified).

[“Fax Send Settings” on page 93](#)

Feature: Receiving Faxes

Receive Mode

There are two options in **Receive Mode** for receiving incoming faxes.

Manual

Mainly for phoning, but also for faxing

[“Usage of Manual Mode” on page 90](#)

Auto

- Only for faxing (external phone device is not required)

- Mainly for faxing, and sometimes phoning

[“Usage of Auto Mode” on page 90](#)

Receiving Faxes by Operating a Connected Phone

You can receive faxes by only operating an external phone device.

[“Basic Settings Menu” on page 217](#)

[“Making Settings When You Connect a Phone Device” on page 79](#)

Feature: PC-FAX Send/Receive (Windows/Mac OS)

PC-FAX Send

You can send faxes from a computer.

[“Application for Configuring Fax Operations and Sending Faxes \(FAX Utility\)” on page 209](#)

[“Sending a Fax from a Computer” on page 95](#)

PC-FAX Receive

You can receive faxes on a computer.

[“Making Settings to Send and Receive Faxes on a Computer” on page 80](#)

[“Application for Configuring Fax Operations and Sending Faxes \(FAX Utility\)” on page 209](#)

[“Receiving Faxes on a Computer” on page 100](#)

Features: Various Fax Reports

You can check the status of sent and received faxes in a report.

| Date | Time | Type | ID | Duration | Pages | Result |
|-------|---------|---------|--------------|----------|---------|-----------|
| XX.XX | XX:XXPM | Send | XX XXXX XXXX | 00:00 | 000/001 | No Answer |
| XX.XX | XX:XXPM | Receive | | 00:37 | 001 | OK |
| XX.XX | XX:XXAM | Send | XXX XXX XXXX | | | OK |

[“Report Settings Menu” on page 221](#)

[“Fax Send Settings” on page 93](#)

[“Transmission Log:” on page 94](#)

[“Fax Report:” on page 94](#)

Feature: Security when Sending and Receiving Faxes

You can use many security features such as **Direct Dialing Restrictions** to prevent sending to the wrong destination, or **Backup Data Auto Clear** to prevent information leakage.

[“Security Settings Menu” on page 222](#)

Features: Other Useful Features

Blocking Junk Faxes

You can reject junk faxes.

[“Rejection Fax:” on page 219](#)

Receiving Faxes After Dialing

After dialing to another fax machine, you can receive documents from that fax machine.

[“Receiving Faxes by Making a Phone Call” on page 91](#)

[“Polling Receive:” on page 95](#)

Sending Faxes Using the Printer

You can send faxes by entering fax numbers for recipients on the printer's control panel.

1. Place the originals.

You can send up to 100 pages in one transmission; however depending on the remaining amount of memory, you may not be able to send faxes even with less than 100 pages.

[“Placing Originals on the Scanner Glass” on page 37](#)

[“Placing Originals on the ADF” on page 36](#)

2. Select **Fax** on the printer's control panel.

To select an item, use the ▲ ▼ ◀ ▶ buttons, and then press the OK button.

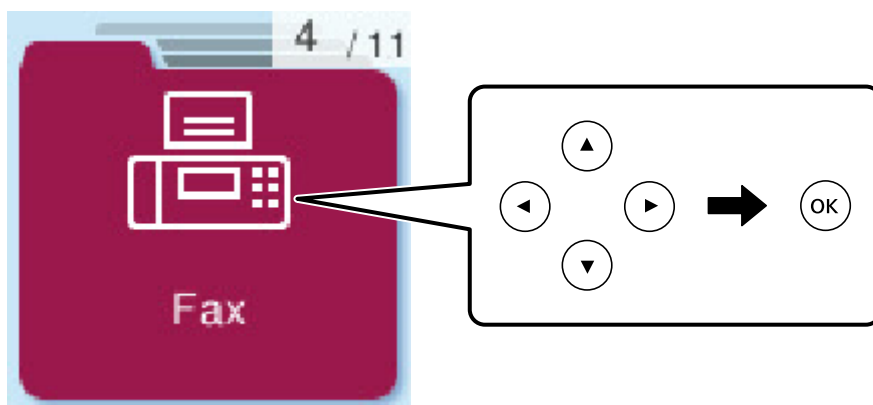

3. Specify the recipient.

[“Selecting Recipients” on page 86](#)

4. Select **Menu** by pressing the OK button, and then select **Scan Settings** or **Fax Send Settings** to make settings as necessary such as the resolution and the sending method.

[“Scan Settings” on page 92](#)

[“Fax Send Settings” on page 93](#)

5. Press the ◊ button to send the fax .

Note:

- ❑ *If the fax number is busy or there are some problems, the printer automatically redials after one minute.*
- ❑ *To cancel sending, press the ⊞ button.*
- ❑ *It takes longer to send a fax in color because the printer performs scanning and sending simultaneously. While the printer is sending a fax in color, you cannot use the other features.*

Selecting Recipients

You can specify recipients to send the fax using the following methods.

Entering Fax Number Manually

Press the fax number with the number buttons, and then press the OK button.

- To add a pause (pause for three seconds during dialing), press the ▼ button.
- If you have set an external access code in **Line Type**, enter "#" (hash) instead of the actual external access code at the beginning of the fax number.

Note:

If you cannot manually enter a fax number, **Direct Dialing Restrictions** in **Security Settings** is set to **On**. Select fax recipients from the contacts list or the sent fax history.

Selecting the recipients from the contacts list

Press the ▲ button and select the recipients you want to send to. If the recipient you want to send to has not been registered in **Contacts**, register it from **Contacts Manager**.

Fax > Menu > Contacts Manager

Selecting the recipients from the sent fax history

Press the ▼ button, and then select a recipient.

Note:

To delete recipients you have entered, press the ► button, move the cursor to the recipient you want to delete by press the ▲ ▼ button, and then deselect the recipient by pressing the OK button. Press the ↶ button to finish and return to the **Fax** screen.

Related Information

➔ [“Making Contacts Available” on page 81](#)

Various Ways of Sending Faxes

Sending Faxes Dialing from the External Phone Device

You can send a fax by dialing using the connected telephone when you want to talk over the phone before sending a fax, or when the recipient's fax machine does not switch to the fax automatically.

1. Place the originals.
You can send up to 100 pages in one transmission.
2. Pick up the handset of the connected telephone, and then dial the recipient's fax number using the phone.

Note:

When the recipient answers the phone, you can talk with the recipient.

3. Select **Fax** on the home screen.

To select an item, use the ▲ ▼ ◀ ▶ buttons, and then press the OK button.

4. Press the OK button, and then select **Scan Settings** or **Fax Send Settings** to make settings such as the resolution and the sending method if necessary.

5. When you hear a fax tone, press the  button, and then hang up the handset.

Note:

When a number is dialed using the connected telephone, it takes longer to send a fax because the printer performs scanning and sending simultaneously. While sending the fax, you cannot use the other features.

6. When sending is complete, remove the originals.

Related Information





- ➔ [“Scan Settings” on page 92](#)
- ➔ [“Fax Send Settings” on page 93](#)

Sending Different Size Documents Using ADF (ADF Continuous Scan)

Sending faxes by placing originals one by one, or by placing originals by size, you can send them as one document at their original sizes.

If you place different sized originals in the ADF, all of the originals are sent at the largest size among them. To send originals at their original sizes, do not place originals with mixed sizes.

1. Place the first batch of originals at the same size.
2. Select **Fax** on the home screen.



To select an item, use the     buttons, and then press the OK button.

3. Specify the recipient.

[“Selecting Recipients” on page 86](#)

4. Press the OK button, and then select **Scan Settings**.
5. Select **ADF Continuous Scan**, and then select **On**.

You can also make settings such as the resolution and the sending method in **Scan Settings** or **Fax Send Settings** if necessary.

6. Press the  button until you are returned to the **Fax** screen, and then press the  button.
7. When scanning the first originals is complete and the message **Send another page?** is displayed on the control panel, select **Yes**, load the next originals, and then press the  button.

Note:

If you leave the printer untouched for 60 seconds after prompted to set the next originals, the printer stops storing and starts sending the document.

8. When sending is complete, remove the originals.

Sending Many Pages of a Monochrome Document (Direct Send)

When sending a fax in monochrome, the scanned document is temporarily stored in the printer's memory. Therefore, sending a lot of pages may cause the printer to run out of memory and stop sending the fax. You can

avoid this by enabling the **Direct Send** feature, however, it takes longer to send the fax because the printer performs scanning and sending simultaneously. You can use this feature when there is only one recipient.

Accessing the Menu

You can find the menu on the printer's control panel below.

Fax > Menu > Fax Send Settings > Direct Send.

Sending Faxes in Monochrome at a Specified Time of the Day (Send Fax Later)

You can set to send a fax at a specified time. Only monochrome faxes can be sent when the time to send is specified.

1. Place the originals.

2. Select **Fax** on the home screen.

To select an item, use the ▲ ▼ ◀ ▶ buttons, and then press the OK button.

3. Specify the recipient.

4. Make settings to send faxes at a specified time.

❶ Press the OK button, and then select **Fax Send Settings**.

❷ Select **Send Fax Later**, and then select **On**.

❸ Enter the time you want to send the fax, and then press the OK button.

You can also make settings such as the resolution and the sending method in **Scan Settings** or **Fax Send Settings** if necessary.

5. Press the ↶ button until return to **Fax** screen, and then press the ◊ button.

6. When sending is complete, remove the originals.

Note:

You can cancel faxing from the **Fax** screen.

Receiving Faxes on the Printer

If the printer is connected to the phone line and basic settings have been completed using the Fax Setting Wizard, you can receive faxes.

Received faxes are printed.

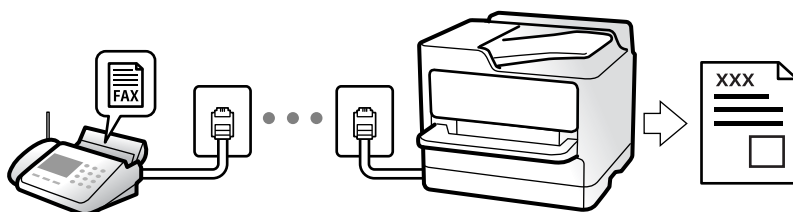

When you want to check the status of the fax settings, print a **Fax Settings List** by selecting **Fax > Menu > More > Fax Report > Fax Settings List**.

Receiving Incoming Faxes

There are two options in **Receive Mode**.

Related Information

- ➔ [“Usage of Manual Mode” on page 90](#)
- ➔ [“Usage of Auto Mode” on page 90](#)
- ➔ [“Receive Mode:” on page 219](#)

Usage of Manual Mode

This mode is mainly for making phone calls, but is also for faxing.

Receiving Faxes

When the telephone rings, you can answer the ringing manually by picking up the handset.

- When you hear a fax signal (baud):

Select **Fax** on the printer's home screen, press the # button to select receiving a fax, and then press the . Next, hang up the handset.

- If the ringing is for a voice call:

You can answer the phone as normal.

Receiving Faxes Using only the Connected Telephone

When **Remote Receive** is set, you can receive faxes by simply entering the start code.

When the telephone rings, pick up the handset. When you hear a fax tone (baud), dial the two digit start code, and then hang up the handset.

Related Information

- ➔ [“Remote Receive:” on page 219](#)

Usage of Auto Mode

This mode allows you to use the line for the following uses.

- Using the line for faxing only (external telephone is not necessary)
- Using the line for faxing mainly, and sometimes phoning

Receiving Faxes Without an External Phone Device

The printer automatically switches to receive faxes when the number of rings you set in **Rings to Answer** is complete.

Receiving Faxes With an External Phone Device

A printer with an external phone device works as follows.

- When the answering machine answers within the number of rings set in **Rings to Answer**:
 - If the ringing is for a fax: The printer automatically switches to receive faxes.
 - If the ringing is for a voice call: The answering machine can receive voice calls and record voice messages.
- When you pick up the handset within the number of rings set in **Rings to Answer**:
 - If the ringing is for a fax: You can receive the fax using the same steps as for **Manual**. Select **Fax** on the printer's home screen, press the # button to select receiving a fax, and then press the ◊ button. Next hang up the handset.
 - If the ringing is for a voice call: You can answer the phone as normal.
- When the ringing stops and the printer automatically switches to receive faxes:
 - If the ringing is for a fax: The printer starts receiving faxes.
 - If the ringing is for a voice call: You cannot answer the phone. Ask the person to call you back.

Note:

Set the number of rings to answer for the answering machine to a lower number than the number set in **Rings to Answer**. Otherwise, the answering machine cannot receive voice calls to record voice messages. For details on setting up the answering machine, see the manual supplied with the answering machine.

Related Information

➔ [“Rings to Answer:” on page 219](#)

Receiving Faxes by Making a Phone Call

You can receive a fax stored on another fax machine by dialing the fax number.

Receiving Faxes by Polling (Polling Receive)

You can receive a fax stored on another fax machine by dialing the fax number. Use this feature to receive a document from a fax information service.

Note:

- If the fax information service has an audio guidance feature that you need to follow to receive a document, you cannot use this feature.
- To receive a document from a fax information service that uses audio guidance, just dial the fax number using the connected telephone, and operate the phone and the printer following the audio guidance.

1. Select **Fax** on the home screen.

To select an item, use the ▲ ▼ ◀▶ buttons, and then press the OK button.

2. Press the OK button, and then select **More**.
3. Select **Polling Receive**, and then select **On**.

4. Specify the recipient.

Note:

If you cannot manually enter a fax number, **Direct Dialing Restrictions in Security Settings** is set to **On**. Select fax recipients from the contacts list or the sent fax history.

5. Press the  button to start **Polling Receive**.

Menu Options for Faxing

Fax

Select the menus in **Fax** from home screen on the control panel.

Contacts:

Select a recipient from the contacts list. You can also add or edit a contact.

Recent:

Select a recipient from the sent fax history. You can also add the recipient to the contacts list.

Menu

You can select the following menus.

- Scan Settings
- Fax Send Settings
- More
- Contacts Manager

See "Related Information" below for more details.

Send Fax

Press the  button to send the fax.

Related Information

➔ ["Selecting Recipients" on page 86](#)

Scan Settings

Select the menus on the control panel as described below:

Fax > Menu > Scan Settings

Resolution:

Select the resolution of the outgoing fax. If you select a higher resolution, the data size becomes larger and it takes time to send the fax.

Density:

Sets the density of the outgoing fax. Press ► to make the density darker, and press ◀ to make it lighter.

ADF Continuous Scan:

Sending faxes by placing originals one by one, or by placing originals by size, you can send them as one document at their original sizes. See the related information below on this topic.

Original Size (Glass):

Select the size and orientation of the original you placed on the scanner glass.

Color Mode:

Select whether to scan in color or in monochrome.

Related Information

➔ [“Sending Different Size Documents Using ADF \(ADF Continuous Scan\)” on page 88](#)

Fax Send Settings

Select the menus on the control panel as described below:

Fax > Menu > Fax Send Settings

Direct Send:

Sends a monochrome fax while scanning the originals. Since scanned originals are not stored temporarily in the printer's memory even when sending a large volume of pages, you can avoid printer errors due to a lack of memory. Note that sending using this feature takes longer than not using this feature. See the related information below on this topic.

You cannot use this feature when sending a fax to multiple recipients.

Send Fax Later:

Sends a fax at a time you specified. Only a monochrome fax is available when using this option. See the related information below on this topic.

Add Sender Info:

Select the position where you want to include the header information (sender name and fax number) in the outgoing fax, or not to include the information.

- Off:** Sends a fax with no header information.
- Outside of Image:** Sends a fax with header information in the top white margin of the fax. This keeps the header from overlapping with the scanned image, however, the fax received by the recipient may be printed across two sheets depending on the size of the originals.
- Inside of Image:** Sends a fax with header information approximately 7 mm lower than the top of the scanned image. The header may overlap with the image, however, the fax received by the recipient will not be split into two documents.

Fax Header:

Select the header for the recipient. To use this feature, you should register multiple headers in advance.

Additional Header Info:

Select the information you want to add. You can select one from **Your Phone Number** and **Destination List**.

Transmission Report:

Prints a transmission report after you send the fax.

Print on Error prints a report only when an error occurs.

When **Attach Fax image to report** has been set in **Settings > Fax Settings > Report Settings**, faxes with errors are also printed with the report.

Related Information

- ➔ [“Sending Many Pages of a Monochrome Document \(Direct Send\)” on page 88](#)
- ➔ [“Sending Faxes in Monochrome at a Specified Time of the Day \(Send Fax Later\)” on page 89](#)

More

Select the menus on the control panel as described below.

Fax > Menu > More

Transmission Log:

You can check the history of sent or received fax jobs.

Fax Report:

Last Transmission:

Prints a report for the previous fax that was sent or received through polling.

Fax Log:

Prints a transmission report. You can set to print this report automatically using the following menu.

Settings > Fax Settings > Report Settings > Fax Log Auto Print

Fax Settings List:

Prints the current fax settings.

Protocol Trace:

Prints a detailed report for the previous fax that was sent or received.

Reprint Faxes:

Reprints the received faxes in the printer.

Polling Receive:

When this is set to **On** and you call the sender's fax number, you can receive documents from the sender's fax machine. See the related information below for details on how to receive faxes using **Polling Receive**.

When you leave the Fax menu, the setting returns to **Off** (default).

Fax Settings:

Accesses **Settings > Fax Settings**.

Related Information

- ➔ [“Receiving Faxes by Polling \(Polling Receive\)” on page 91](#)
- ➔ [“Fax Settings” on page 217](#)

Contacts Manager

Select the menus on the control panel as described below:

Fax > Menu > Contacts Manager

Accesses **Settings > Contacts Manager**.

You can add or edit your contacts.

Using Other Faxing Features

Printing Fax Report Manually

1. Select **Fax** on the home screen.
To select an item, use the ▲ ▼ ◀▶ buttons, and then press the OK button.
2. Press OK button and select **More**.
3. Select **Fax Report**.
4. Select the report you want to print, and then follow the on-screen instructions.

Note:

You can change the report format. From the home screen, select **Settings > Fax Settings > Report Settings**, and then change the **Attach Fax image to report** or **Report Format** settings.

Sending a Fax from a Computer

You can send faxes from the computer by using the FAX Utility and PC-FAX driver.

Note:

- Check if the FAX Utility and the printer's PC-FAX driver has been installed before using this feature.
“Application for Configuring Fax Operations and Sending Faxes (FAX Utility)” on page 209
“Application for Sending Faxes (PC-FAX Driver)” on page 210
- If the FAX Utility is not installed, install the FAX Utility using the EPSON Software Updater (application for updating software).
EPSON Software Updater FY19 “Application for Updating Software and Firmware (Epson Software Updater)” on page 211

Sending Documents Created Using an Application (Windows)

By selecting a printer fax from the **Print** menu of an application like Microsoft Word or Excel, you can directly transmit data such as documents, drawings, and tables you have created, with a cover sheet.

Note:

The following explanation uses Microsoft Word as an example. The actual operation may differ depending on the application you use. For details, see the application's help.

1. Using an application, create a document to transmit by fax.
2. Click **Print** from the **File** menu.
The application's **Print** window appears.
3. Select **XXXXXX (FAX)** (where XXXXXX is your printer name) in **Printer**, and then check the settings for fax sending.
 - Specify **1** in **Number of copies**. Fax may not be transmitted correctly if you specify **2** or more.
 - You can send up to 100 pages in one fax transmission.
4. Click **Printer Properties** or **Properties** if you want to specify **Paper Size, Orientation, Color, Image Quality, or Character Density**.
For details, see the PC-FAX driver help.
5. Click **Print**.

Note:

When Using FAX Utility for the first time, a window for registering your information is displayed. Enter the necessary information, and then click **OK**.

Recipient Settings screen of FAX Utility is displayed.

6. When you want to send other documents in the same fax transmission, select **Add documents to send** checkbox.
The screen for adding documents is displayed when you click **Next** in step 9.
7. Select **Attach a cover sheet** checkbox if necessary.

8. Specify a recipient.

- Selecting a recipient (name, fax number and so on) from **PC-FAX Phone Book**:

If the recipient is saved in the phone book, do the steps below.

- ➊ Click the **PC-FAX Phone Book** tab.
- ➋ Select the recipient from the list and click **Add**.

- Selecting a recipient (name, fax number and so on) from the contacts on the printer:

If the recipient is saved in the contacts on the printer, do the steps below.

- ➊ Click the **Contacts on Printer** tab.
- ➋ Select contacts from the list and click **Add** to proceed to **Add to Recipient** window.
- ➌ Select the contacts from the list displayed, and then click **Edit**.
- ➍ Add the personal data such as **Company/Corp.** and **Title** as necessary, and then click **OK** to return to the **Add to Recipient** window.
- ➎ As necessary, select the checkbox of **Register in the PC-FAX Phone Book** to save the contacts to **PC-FAX Phone Book**.
- ➏ Click **OK**.

- Specifying a recipient (name, fax number and so on) directly:

Do the steps below.

- ➊ Click the **Manual Dial** tab.
- ➋ Enter the necessary information.
- ➌ Click **Add**.

Furthermore, by clicking **Save to Phone Book**, you can save the recipient in the list under the **PC-FAX Phone Book** tab.

Note:

- If your printer's *Line Type* is set to **PBX** and the access code has been set to use # (hash) instead of entering the exact prefix code, enter # (hash). For details, see *Line Type* in *Basic Settings* from related information link below.
- If you have selected **Enter fax number twice** in the **Optional Settings** on the **FAX Utility** main screen, you need to enter the same number again when you click **Add** or **Next**.

The recipient is added to the **Recipient List** displayed in the upper part of the window.

9. Click **Next**.

- When you have selected **Add documents to send** checkbox, follow the steps below to add documents in the **Document Merging** window.

- ➊ Open a document you want to add, and then select the same printer (fax name) in the **Print** window. The document is added to the **Document List to Merge** list.
- ➋ Click **Preview** to check the merged document.
- ➌ Click **Next**.

Note:

The **Image Quality** and **Color** settings you have selected for the first document are applied to other documents.

- When you have selected **Attach a cover sheet** checkbox, specify the content of the cover sheet in the **Cover Sheet Settings** window.
 - ❶ Select a cover sheet from samples in the **Cover Sheet** list. Note that there is no function to create an original cover sheet or to add an original cover sheet to the list.
 - ❷ Enter the **Subject** and **Message**.
 - ❸ Click **Next**.

Note:

Set the following as necessary in **Cover Sheet Settings**.

- Click **Cover Sheet Formatting** if you want to change the order of the items on the cover sheet. You can select the cover sheet size in **Paper Size**. You can also select a cover sheet at a different size to the document being transmitted.
- Click **Font** if you want to change the font used for the text on the cover sheet.
- Click **Sender Settings** if you want to change the sender information.
- Click **Detailed Preview** if you want to check the cover sheet with the subject and the message you entered.

10. Check the transmission content and click **Send**.

Make sure the name and fax number of the recipient are correct before transmitting. Click **Preview** to preview the cover sheet and document to transmit.

Once transmission starts, a window displaying the transmission status appears.

Note:

- To stop transmitting, select the data, and click **Cancel** . You can also cancel using the printer's control panel.
- If an error occurs during transmission, the **Communication error** window appears. Check the error information and retransmit.
- The Fax Status Monitor screen (the screen mentioned above where you can check the transmission status) is not displayed if **Display Fax Status Monitor During Transmission** is not selected in the **Optional Settings** screen of the FAX Utility main screen.

Related Information

➔ [“Basic Settings Menu” on page 217](#)

Sending Documents Created Using an Application (Mac OS)

By selecting a fax-capable printer from the **Print** menu of a commercially available application, you can send data such as documents, drawings, and tables, you have created.

Note:

The following explanation uses *Text Edit*, a standard Mac OS application as an example.

1. Create the document you want to send by fax in an application.
2. Click **Print** from the **File** menu.

The application's **Print** window is displayed.

3. Select your printer (fax name) in **Name**, click ▼ to display the detailed settings, check the print settings, and then click **OK**.

4. Make settings for each item.

- Specify **1** in **Number of copies**. Even if you specify **2** or more, only 1 copy is sent.
- You can send up to 100 pages in one fax transmission.

Note:

The page size of documents you can send is the same as the paper size you can fax from the printer.

5. Select Fax Settings from the popup menu, and then make settings for each item.

See the PC-FAX driver's help for explanations on each setting item.

Click  at the bottom left of the window to open the PC-FAX driver's help.

6. Select the Recipient Settings menu, and then specify the recipient.

- Specifying a recipient (name, fax number, and so on) directly:

Click the **Add** item, enter the necessary information, and then click . The recipient is added to the Recipient List displayed in the upper part of the window.

If you have selected "Enter fax number twice" in the PC-FAX driver settings, you need to enter the same number again when you click .

If your fax connection line requires a prefix code, enter External Access Prefix.

Note:

*If your printer's Line Type is set to **PBX** and the access code has been set to use # (hash) instead of entering the exact prefix code, enter # (hash). For details, see Line Type in Basic Settings from Related Information link below.*

- Selecting a recipient (name, fax number, and so on) from the phone book:

If the recipient is saved in the phone book, click . Select the recipient from the list, and then click **Add** > **OK**.

If your fax connection line requires a prefix code, enter External Access Prefix.

Note:

*If your printer's Line Type is set to **PBX** and the access code has been set to use # (hash) instead of entering the exact prefix code, enter # (hash). For details, see Line Type in Basic Settings from Related Information link below.*

7. Check the recipient settings, and then click **Fax**.

Sending starts.

Make sure the name and fax number of the recipient are correct before transmitting.

Note:

- If you click the printer icon in Dock, the transmission status check screen is displayed. To stop sending, click the data, and then click **Delete**.
- If an error occurs during transmission, the **Sending failed** message is displayed. Check the transmission records on the **Fax Transmission Record** screen.
- Mixed paper size documents may not be sent correctly.

Related Information

➔ ["Basic Settings Menu" on page 217](#)

Receiving Faxes on a Computer

Faxes can be received by a printer and saved in PDF format on a computer connected to the printer. Use the FAX Utility (application) to make settings.

For details on how to operate FAX Utility, see Basic Operations in the FAX Utility help (displayed on the main window). If the password entry screen is displayed on the computer screen while you are making settings, enter the password. If you do not know the password, contact your administrator.

Note:

- Check if the FAX Utility has been installed and the FAX Utility settings have been made before using this feature.
[“Application for Configuring Fax Operations and Sending Faxes \(FAX Utility\)” on page 209](#)
- If the FAX Utility is not installed, install the FAX Utility using the EPSON Software Updater (application for updating software).
[EPSON Software Updater FY19 “Application for Updating Software and Firmware \(Epson Software Updater\)” on page 211](#)

Important:

- To receive faxes on a computer, the **Receive Mode** on the printer's control panel must be set to **Auto**. To make settings on the printer's control panel, select **Settings > Fax Settings > Basic Settings > Receive Mode**.
- The computer set to receive faxes should always be on. Received documents are saved in the printer's memory temporarily before the documents are saved on the computer. If you turn off the computer, the printer's memory might become full as it cannot send the documents to the computer.
- When received faxes have been temporarily saved to the printer's memory, the  light turns on.
- To read the received faxes, you need to install a PDF viewer such as Adobe Reader in the computer.

Related Information

- ➔ [“Making Settings to Send and Receive Faxes on a Computer” on page 80](#)

Checking for New Faxes (Windows)

By setting up a computer to save faxes received by the printer, you can check the processing status of received faxes, and whether or not there are any new faxes using the fax icon on the Windows task bar. By setting up the computer to display a notification when new faxes are received, a notification screen pops up near the Windows system tray, and you can check the new faxes.

Note:

- Received fax data saved to the computer is removed from the printer's memory.
- You need Adobe Reader to view the received faxes because they are saved as PDF files.

Using the Fax Icon on the Task Bar (Windows)

You can check for new faxes and the operation status by using the fax icon displayed on the Windows taskbar.

1. Check the icon.
 -  : Standing by.

: Checking for new faxes.

: Importing new faxes is complete.

2. Right-click the icon, and then click **View Receiving Fax Record**.

The **Receiving Fax Record** screen is displayed.

3. Check the date and the sender in the list, and then open the received file as a PDF.

Note:

Received faxes are automatically renamed using the following naming format.

YYYYMMDDHHMMSS_xxxxxxxxx_nnnnn (Year/Month/Day/Hour/Minute/Second_sender's number)

*You can also open the received fax folder directly when you right-click the icon. For details, see **Optional Settings** in the FAX Utility and its help (displayed on the main window).*

While the fax icon indicates that it is standing by, you can check for new faxes instantly by selecting **Check new faxes now**.

Using the Notification Window (Windows)

When you set to notify you the new faxes exist, a notification window is displayed near the task bar for each the fax.

1. Check the notification screen displayed on your computer screen.

Note:

The notification screen disappears if no operation is performed for a given length of time. You can change the notification settings such as the display time.

2. Click anywhere in the notification screen, except for the  button.

The **Receiving Fax Record** screen is displayed.

3. Check the date and the sender in the list, and then open the received file as a PDF.

Note:

Received faxes are automatically renamed using the following naming format.

YYYYMMDDHHMMSS_xxxxxxxxx_nnnnn (Year/Month/Day/Hour/Minute/Second_sender's number)

*You can also open the received fax folder directly when you right-click the icon. For details, see **Optional Settings** in the FAX Utility and its help (displayed on the main window).*

Checking for New Faxes (Mac OS)

You can check for new faxes using one of the following methods. This is available only on computers set to "Save" (**save faxes on this computer**).

Open the received fax folder (specified in **Received Fax Output Settings**.)

Open the Fax Receive Monitor and click **Check new faxes now**.

Notification that new faxes have been received

Select the **Notify me of new faxes via a dock icon** in the **Fax Receive Monitor > Preferences** in the FAX Utility, the fax receive monitor icon on the Dock jumps to notify you that new faxes have arrived.

Open the Received Fax Folder from Received Fax Monitor (Mac OS)

You can open the save folder from the computer specified to receive faxes when selecting "Save" (save faxes on this computer).

1. Click the received fax monitor icon on the Dock to open **Fax Receive Monitor**.
2. Select the printer and click **Open folder**, or double click the printer name.
3. Check the date and the sender in the file name, and then open the PDF file.

Note:

Received faxes are automatically renamed using the following naming format.

YYYYMMDDHHMMSS_XXXXXXXXXX_nnnnn (Year/Month/Day/Hour/Minute/Second_sender's number)

Information sent from the sender is displayed as the sender's number. This number may not be displayed depending on the sender.

Canceling the Feature that Saves Incoming Faxes to the Computer

You can cancel saving faxes to the computer by using the FAX Utility.

For details, see Basic Operations in the FAX Utility help (displayed on the main window).

Note:

- If there are any faxes that have not been saved to the computer, you cannot cancel the feature that saves faxes on the computer.*
- You can also change the settings on the printer. See "Related Information" below to change settings.*

Related Information

- ➔ ["Making Save to Computer Setting not to Receive Faxes" on page 81](#)

Maintaining the Printer

| | |
|---|-----|
| Checking the Ink Level. | 104 |
| Improving Print, Copy, Scan, and Fax Quality. | 104 |
| Cleaning the Printer. | 111 |
| Cleaning Spilled ink. | 112 |

Checking the Ink Level

To confirm the actual ink remaining, visually check the ink levels in all of the printer's tanks.



Important:

Prolonged use of the printer when the ink level is below the lower line could damage the printer.

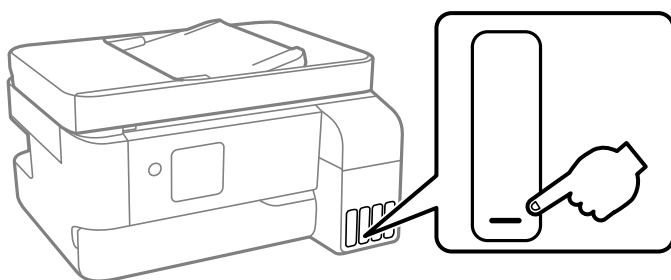

Note:

You can also check the approximate ink levels from the status monitor on the printer driver.

Windows

Click EPSON Status Monitor 3 on the Maintenance tab.

*If EPSON Status Monitor 3 is disabled, click Extended Settings on the Maintenance tab, and then select **Enable EPSON Status Monitor 3**.*

Mac OS

Apple menu > System Preferences > Printers & Scanners (or Print & Scan, Print & Fax) > Epson(XXXX) > Options & Supplies > Utility > Open Printer Utility > EPSON Status Monitor

Related Information

➔ [“Refilling the Ink Tanks” on page 187](#)

Improving Print, Copy, Scan, and Fax Quality

Checking and Cleaning the Print Head





If the nozzles are clogged, the printouts become faint, there is visible banding, or unexpected colors appear. If the nozzles are severely clogged, a blank sheet will be printed. When print quality has declined, first use the nozzle check feature to check if the nozzles are clogged. If the nozzles are clogged, clean the print head.

! **Important:**

- Do not open the inner cover or turn off the printer during head cleaning. If the head cleaning is incomplete, you may not be able to print.
- Head cleaning consumes ink and should not be performed more than necessary.
- When ink is low, you may not be able to clean the print head.
- If print quality has not improved after repeating nozzle check and head cleaning 3 times, wait for at least 12 hours without printing, and then run the nozzle check again and repeat the head cleaning if necessary. We recommend turning off the printer by using the  button. If print quality has still not improved, run Power Cleaning.
- To prevent the print head from drying out, do not unplug the printer while the power is on.

You can check and clean the print head by using the printer's control panel.

1. Select **Maintenance** on the printer's control panel.

To select an item, use the     buttons, and then press the OK button.

2. Select **Nozzle Check**.
3. Follow the on-screen instructions to load paper and print the nozzle check pattern.
4. Check the printed pattern to see if the print head nozzles are clogged.

A) OK

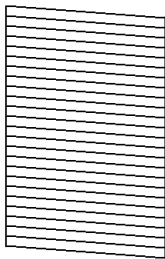

B) NG

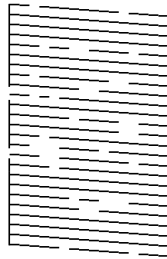

C) NG

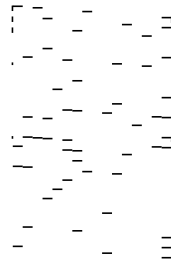

- A:**
All lines are printed. Select **No**. No further steps are needed.
- B or close to B**
Some nozzles are clogged. Select **Yes**, and then follow the on-screen instructions to clean the print head. When cleaning is finished, the nozzle check pattern is printed automatically.
- C or close to C**
If most lines are missing or not printed, this indicates most nozzles are clogged. Select **No** to exit the nozzle check feature, and then run Power Cleaning. For details, see "Related information" below.

5. Repeat cleaning and printing the pattern until all lines are printed completely.

 **Important:**

If print quality has not improved after repeating nozzle check and head cleaning 3 times, wait for at least 12 hours without printing, and then run the nozzle check again and repeat the head cleaning if necessary. We recommend turning off the printer by using the  button. If print quality has still not improved, run Power Cleaning.

Note:

You can also check and clean the print head from the printer driver.

Windows

Click **Print Head Nozzle Check** on the **Maintenance** tab.

Mac OS

Apple menu > **System Preferences** > **Printers & Scanners** (or **Print & Scan, Print & Fax**) > Epson(XXXX) > **Options & Supplies** > **Utility** > **Open Printer Utility** > **Print Head Nozzle Check**

Related Information

➔ [“Running Power Cleaning” on page 106](#)

Running Power Cleaning

The **Power Cleaning** utility allows you to replace all of the ink inside the ink tubes. In the following situations, you may need to use this feature to improve the print quality.

- You printed or performed head cleaning when the ink levels were too low to be seen in the ink tank windows.
- You performed the nozzle check and head cleaning 3 times and then waited for at least 12 hours without printing, but print quality still did not improve.

Before running this feature, read the following instructions.

 **Important:**

Make sure that there is enough ink in the ink tanks.

Visually check all ink tanks are at least a third full. Low ink levels during Power Cleaning could damage the product.

 **Important:**

An interval of 12 hours is required between each Power Cleaning.

Normally, a single Power Cleaning should resolve the print quality issue within 12 hours. Therefore, to avoid unnecessary ink usage, you must wait 12 hours before you try it again.

 **Important:**

Maintenance box replacement may be required.

Ink will be deposited to the maintenance box. If it becomes full, you must prepare and install a replacement maintenance box to continue printing.

Note:

When the ink levels or the free space in the maintenance box are insufficient for Power Cleaning, you cannot run this feature. Even in this case, the levels and the free space for printing may remain.

1. Select **Maintenance** on the printer's control panel.

To select an item, use the ▲ ▼ ◀▶ buttons, and then press the OK button.

2. Select **Power Cleaning**.
3. Follow the on-screen instructions to run the Power Cleaning feature.

Note:

If you cannot run this feature, solve the problems that are displayed on the screen. Next, follow this procedure from step 1 to run this feature again.

4. After running this feature, run the nozzle check to make sure the nozzles are not clogged.

For details on how to run the nozzle check, see the related information link below.



Important:

If print quality has not improved after running Power Cleaning, wait for at least 12 hours without printing, and then print the nozzle check pattern again. Run Head Cleaning or Power Cleaning again depending on the printed pattern. If quality still does not improve, contact Epson support.

Note:

You can also run power cleaning from the printer driver. See the related information link below for details.

Preventing nozzle clogging

Always use the power button when turning the printer on and off.

Check that the power light is off before you disconnect the power cord.

The ink itself can dry out if it is not covered. Just like placing a cap on a fountain pen or an oil pen to prevent it from drying, make sure the print head is capped properly to prevent the ink from drying.

When the power cord is unplugged or a power outage occurs while the printer is in operation, the print head may not be capped properly. If the print head is left as it is, it will dry out causing nozzles (ink outlets) to clog.

In these cases, turn the printer on and off again as soon as possible to cap the print head.

Aligning the Print Head

If you notice a misalignment of vertical lines or blurred images, align the print head.

1. Select **Maintenance** on the printer's control panel.

To select an item, use the ▲ ▼ ◀▶ buttons, and then press the OK button.

2. Select **Print Head Alignment**.

3. Select one of the alignment menus.

Vertical lines look misaligned or the printouts look blurry : Select **Vertical Alignment**.

- ❑ Horizontal banding occurs at regular intervals: Select **Horizontal Alignment**.

4. Follow the on-screen instructions.

Cleaning the Paper Path for Ink Smears

When the printouts are smeared or scuffed, clean the roller inside.



Important:

Do not use tissue paper to clean the inside of the printer. The print head nozzles may be clogged with lint.

1. Select **Maintenance** on the printer's control panel.

To select an item, use the ▲ ▼ ◀ ▶ buttons, and then press the OK button.

2. Select **Paper Guide Cleaning**.

3. Follow the on-screen instructions to load paper and clean the paper path.

4. Repeat this procedure until the paper is not smeared with ink.

Cleaning the Scanner Glass

When the copies or scanned images are smeared, clean the scanner glass.



Caution:

Be careful not to trap your hand or fingers when opening or closing the document cover. Otherwise you may be injured.



Important:

Never use alcohol or thinner to clean the printer. These chemicals can damage the printer.

1. Open the document cover.

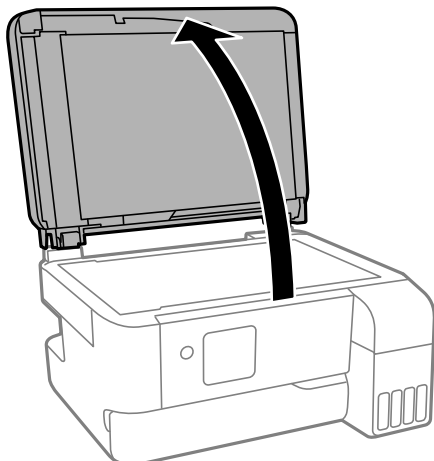

2. Use a soft, dry, clean cloth to clean the surface of the scanner glass.

! *Important:*

- ❑ *If the glass surface is stained with grease or some other hard-to-remove material, use a small amount of glass cleaner and a soft cloth to remove it. Wipe off all remaining liquid.*
- ❑ *Do not press the glass surface too hard.*
- ❑ *Be careful not to scratch or damage the surface of the glass. A damaged glass surface can decrease the scan quality.*

Cleaning the ADF

When the copied or scanned images from the ADF are smeared or the originals do not feed in the ADF correctly, clean the ADF.

! *Important:*

Never use alcohol or thinner to clean the printer. These chemicals can damage the printer.

1. Open the ADF cover.

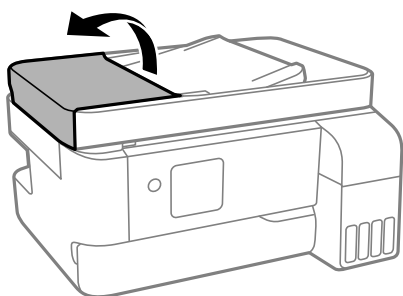

2. Use a soft, moist cloth to clean the roller and the interior of the ADF.

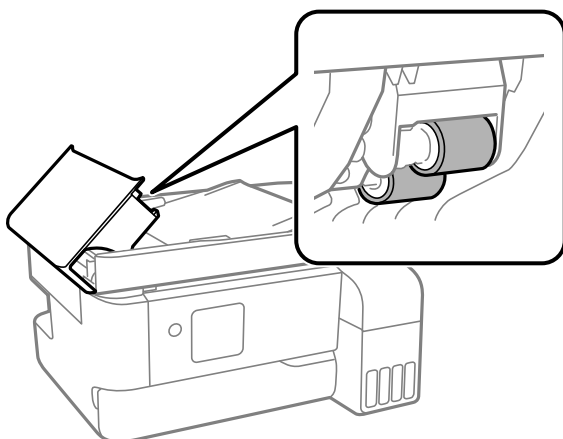

! *Important:*

Using a dry cloth may damage the surface of the roller. Use the ADF after the roller has dried.

3. Close the ADF cover, and then open the document cover.

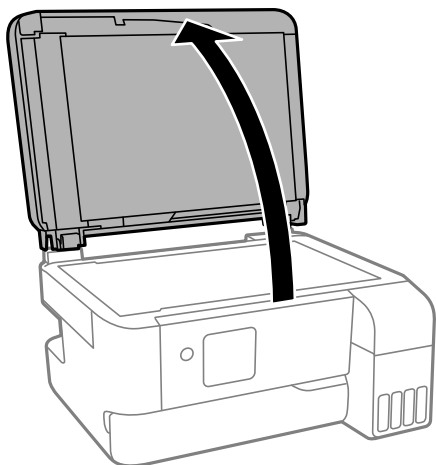

4. Clean the part that is shown in the illustration.

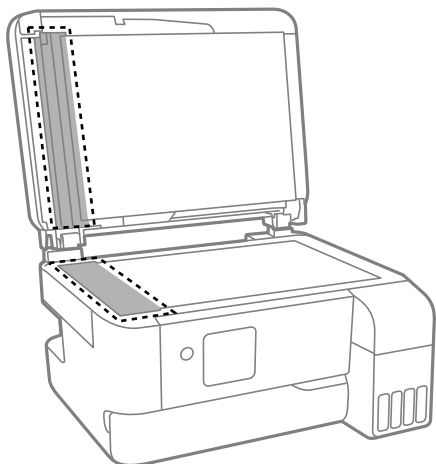

! **Important:**

- If the glass surface is stained with grease or some other hard-to-remove material, use a small amount of glass cleaner and a soft cloth to remove it. Wipe off all remaining liquid.
- Do not press the glass surface too hard.
- Be careful not to scratch or damage the surface of the glass. A damaged glass surface can decrease the scan quality.

5. If the problem cannot be cleared, turn off the printer by pressing the  button, open the ADF cover, and then raise the ADF input tray.

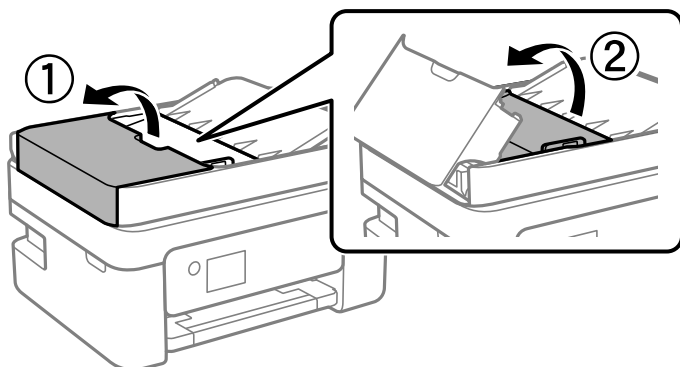

6. Clean the part that is shown in the illustration.

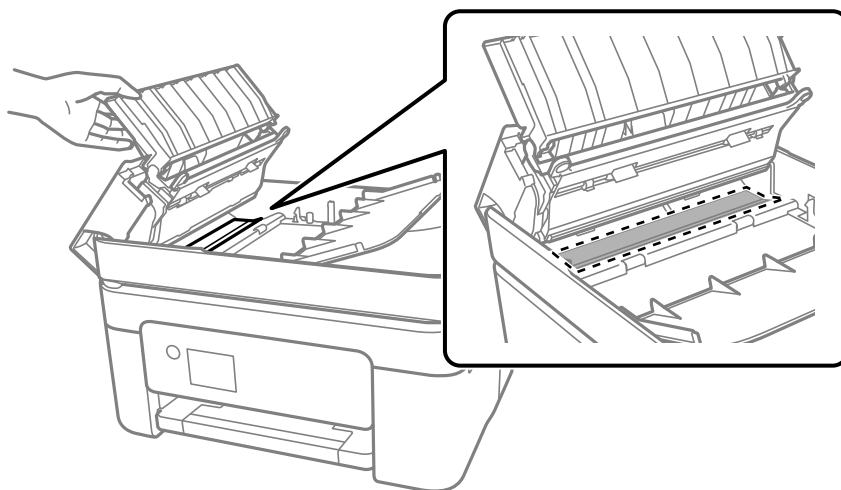

Cleaning the Printer

If the components and the case are dirty or dusty, turn off the printer and clean them using a soft, clean cloth that has been dampened with water. If you cannot remove the dirt, try adding a small amount of mild detergent to the damp cloth.

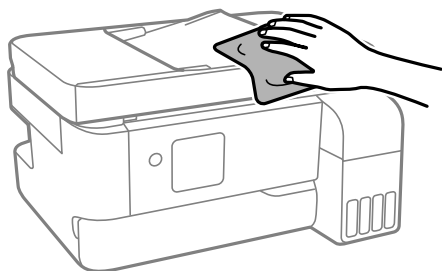

! **Important:**

- ❑ Be careful not to get water onto the printer mechanism or any electrical components. Otherwise, the printer could be damaged.
- ❑ Never use alcohol or paint thinner to clean the components and the case. These chemicals can damage them.
- ❑ Do not touch the parts shown in the following illustration. Doing so may cause a malfunction.

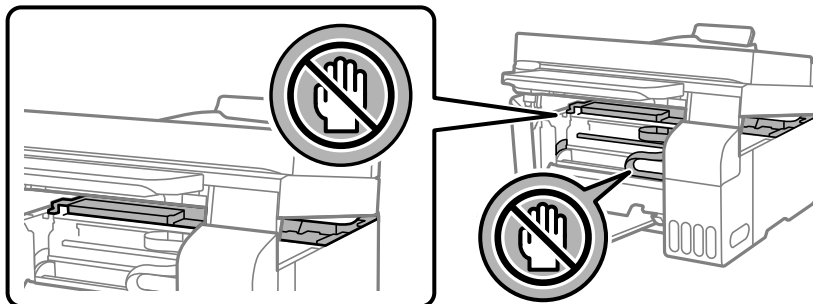

Cleaning Spilled ink

If ink has been spilled, clean it up in the following ways.

- ❑ If ink adheres to the area around the tank, wipe it off using a napless, clean cloth or cotton swab.
- ❑ If ink spills on the desk or floor, wipe it off immediately. When ink is dried, it will be difficult to remove the smear. To prevent the smear from spreading, blot the ink with a dry cloth, and then wipe it with a moist cloth.
- ❑ If ink gets on your hands, wash them with water and soap.

In These Situations

| | |
|--|-----|
| When Replacing a Computer. | 114 |
| Saving Power. | 114 |
| Checking the Total Number of Pages Fed Through the Printer. | 114 |
| Disabling your Wi-Fi Connection. | 115 |
| Installing the Applications Separately. | 115 |
| Re-Setting the Network Connection. | 118 |
| Connecting a Smart Device and Printer Directly (Wi-Fi Direct). | 128 |
| Adding or Changing the Printer's Connection. | 132 |
| Transporting and Storing the Printer. | 136 |

When Replacing a Computer

You need to install the printer driver and other software on the new computer.

Access the following website, and then enter the product name. Go to **Setup**, and then start setting up. Follow the on-screen instructions.

<https://epson.sn>

Saving Power

The printer enters sleep mode or turns off automatically if no operations are performed for a set period. You can adjust the time before power management is applied. Any increase will affect the product's energy efficiency. Please consider the environment before making any change.

1. Select **Settings** on the home screen.

To select an item, use the ▲ ▼ ◀▶ buttons, and then press the OK button.

2. Select **Printer Setup**.

3. Do one of the following.

Select **Sleep Timer** or **Power Off Settings** > **Power Off If Inactive** or **Power Off If Disconnected**.

Select **Sleep Timer** or **Power Off Timer**.

Note:

*Your product may have the **Power Off Settings** or **Power Off Timer** feature depending on the location of purchase.*

4. Select the setting.

Checking the Total Number of Pages Fed Through the Printer

You can check the total number of pages fed through the printer. The information is printed together with the nozzle check pattern.

1. Select **Maintenance** on the printer's control panel.

To select an item, use the ▲ ▼ ◀▶ buttons, and then press the OK button.

2. Select **Nozzle Check**.

3. Follow the on-screen instructions to load paper and print the nozzle check pattern.

Note:

You can also check the total number of pages fed from the printer driver.

❑ *Windows*

Click **Printer and Option Information** on the *Maintenance* tab.

❑ *Mac OS*

Apple menu > **System Preferences** > **Printers & Scanners** (or **Print & Scan, Print & Fax**) > *Epson(XXXX)* > **Options & Supplies** > **Utility** > **Open Printer Utility** > **Printer and Option Information**

Disabling your Wi-Fi Connection

If you used to use Wi-Fi (wireless LAN) but no longer need to do so due to a change in connection mode and so on, you can disable your Wi-Fi connection.

By removing unnecessary Wi-Fi signals, you can also reduce the load on your standby power.

1. Select **Wi-Fi Setup** on the printer's home screen.

To select an item, use the ▲ ▼ ◀▶ buttons, and then press the OK button.

2. Select **Wi-Fi (Recommended)**.

3. Press the OK button.

4. Select **Others** > **Disable Wi-Fi**.

Follow the on-screen instructions.

Installing the Applications Separately

Connect your computer to the network and install the latest version of applications from the website. Log in to your computer as an administrator. Enter the administrator password if the computer prompts you.

Note:

When reinstalling an application, you need to uninstall it first.

1. Make sure the printer and the computer are available for communication, and the printer is connected to the Internet.

2. Start Epson Software Updater.

The screenshot is an example on Windows.

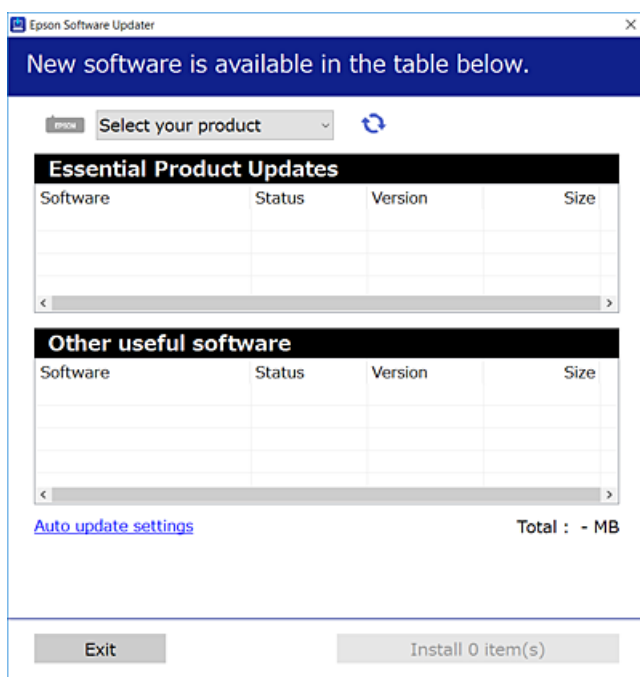

3. For Windows, select your printer, and then click  to check for the latest available applications.
4. Select the items you want to install or update, and then click the install button.



Important:

Do not turn off or unplug the printer until the update is complete. Doing so may result in malfunction of the printer.

Note:

- You can download the latest applications from the Epson website.
<http://www.epson.com>
- If you use Windows Server operating systems, you cannot use Epson Software Updater. Download the latest applications from the Epson website.

Related Information

➔ [“Application for Updating Software and Firmware \(Epson Software Updater\)” on page 211](#)

Checking if a genuine Epson printer driver is installed - Windows

You can check if a genuine Epson printer driver is installed on your computer by using one of the following methods.

Select **Control Panel > View devices and printers (Printers, Printers and Faxes)**, and then do the following to open the print server properties window.

- ❑ Windows 11/Windows 10/Windows 8.1/Windows 8/Windows 7/Windows Server 2022/Windows Server 2019/Windows Server 2016/Windows Server 2012 R2/Windows Server 2012/Windows Server 2008 R2

Click the printer icon, and then click **Print server properties** at the top of the window.

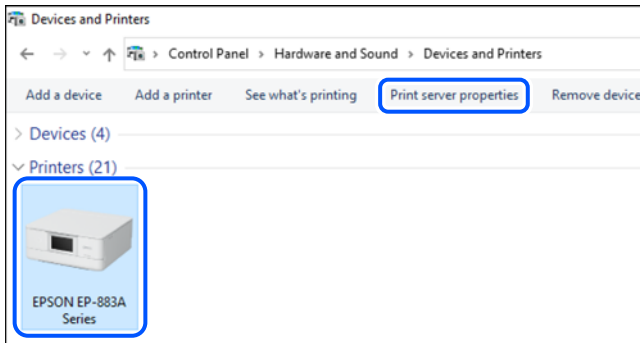

- ❑ Windows Vista/Windows Server 2008

Right-click on the **Printers** folder, and then click **Run as administrator > Server Properties**.

- ❑ Windows XP/Windows Server 2003 R2/Windows Server 2003

From the **File** menu, select **Server Properties**.

Click the **Drivers** tab. If your printer name is displayed in the list, a genuine Epson printer driver is installed on your computer.

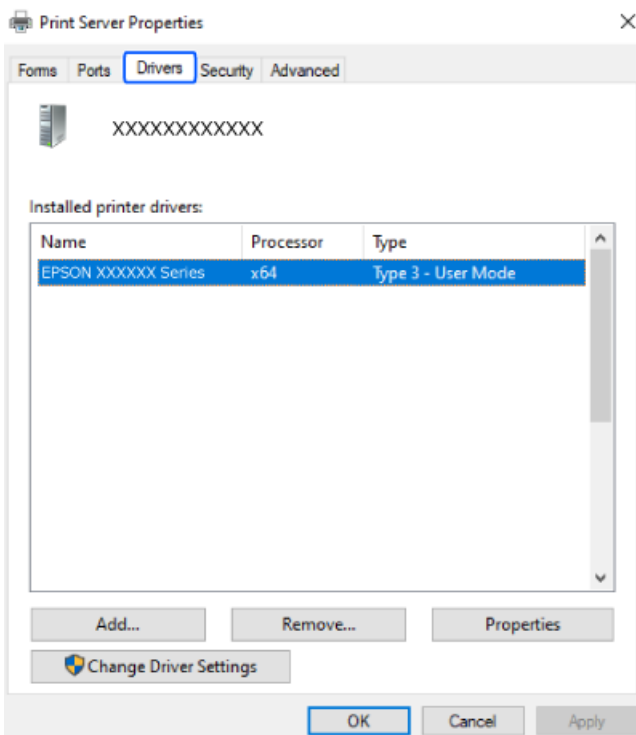

Related Information

- ➔ [“Installing the Applications Separately” on page 115](#)

Checking if a genuine Epson printer driver is installed - Mac OS

You can check if a genuine Epson printer driver is installed on your computer by using one of the following methods.

Select **System Preferences** from the Apple menu > **Printers & Scanners** (or **Print & Scan, Print & Fax**), and then select the printer. Click **Options & Supplies**, and if the **Options** tab and **Utility** tab are displayed on the window, a genuine Epson printer driver is installed on your computer.

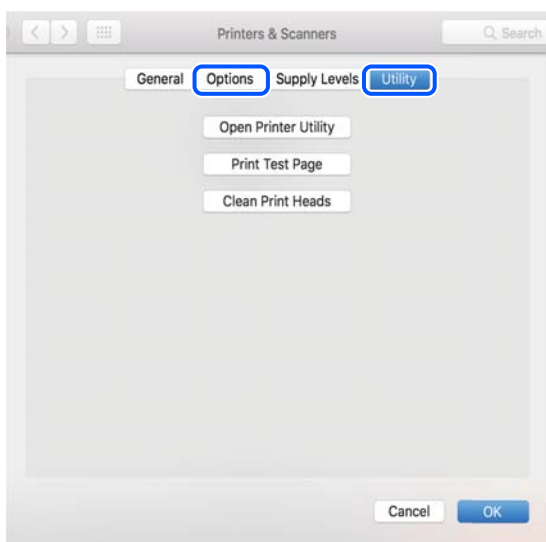

Related Information

➔ [“Installing the Applications Separately” on page 115](#)

Re-Setting the Network Connection

The printer network needs to be configured in the following cases.

- When using a printer with a network connection
- When your network environment has changed
- When replacing the wireless router
- Changing the connection method to the computer

Making Settings for Connecting to the Computer

You can run the installer using one of the following methods.

Setting up from the website

Access the following website, and then enter the product name. Go to **Setup**, and then start setting up.

<https://epson.sn>

 You can also watch the procedure in the Web Movie Manuals. Access the following website.

<https://support.epson.net/publist/vlink.php?code=NPD6870>

Setting up using the software disc

If your printer came with a software disc and you are using a Windows computer with a disc drive, insert the disc into the computer, and then follow the on-screen instructions.

Making Settings for Connecting to the Smart Device

You can use the printer via the wireless router from your smart device when you connect the printer to the same network as the wireless router.

To set up a new connection, access the following website from the smart device that you want to connect to the printer. Enter the product name, go to Setup, and then start the setup.

<https://epson.sn>

 You can watch the procedure in the Web Movie Manuals. Access the following website.

<https://support.epson.net/publist/vlink.php?code=VC00006>

Note:

If you have already set up the connection between your smart device and the printer but need to reconfigure it, you can do so from an app such as Epson Smart Panel.

Making Wi-Fi Settings from the Control Panel

If you are not using a computer or smart device to set up the printer connection, you can do so on the control panel.

You can make network settings from the printer's control panel in several ways. Choose the connection method that matches the environment and conditions that you are using.

If you know the SSID and password for your wireless router, you can set them manually.

Related Information

- ➔ [“Making Wi-Fi Settings by Entering the SSID and Password” on page 119](#)
- ➔ [“Making Wi-Fi Settings by Push Button Setup \(WPS\)” on page 120](#)
- ➔ [“Making Wi-Fi Settings by PIN Code Setup \(WPS\)” on page 121](#)

Making Wi-Fi Settings by Entering the SSID and Password

You can set up a Wi-Fi network by entering the information necessary to connect to a wireless router from the printer's control panel. To set up using this method, you need the SSID and password for a wireless router.

Note:

If you are using an wireless router with its default settings, the SSID and password are on the label. If you do not know the SSID and password, contact the person who set up the wireless router, or see the documentation provided with the wireless router.

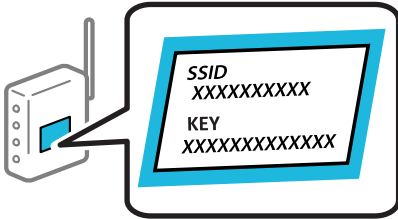

1. Select **Wi-Fi Setup** on the home screen.

To select an item, use the ▲ ▼ ◀ ▶ buttons, and then press the OK button.

2. Select **Wi-Fi (Recommended)**.
3. Press the OK button to proceed.
4. Select **Wi-Fi Setup Wizard**.
5. Select the SSID for the wireless router from printer's control panel, and then press the OK button.

Note:

- If the SSID you want to connect to is not displayed on the printer's control panel, press the ↻ button to update the list. If it is still not displayed, select **Other SSIDs**, and then enter the SSID directly.
- If you do not know the SSID, check if it is written on the label of the wireless router. If you are using the wireless router with its default settings, use the SSID written on the label.

6. Enter the password.

Select whether or not you print a network connection report after finishing the settings.

Note:

- The password is case-sensitive.
- If you do not know the network name (SSID) check if the information is written on the label of the wireless router. If you are using the wireless router with its default settings, use the SSID on the label. If you cannot find any information, see the documentation provided with the wireless router.

7. When you have setup finished, and then press the OK button.

Note:

If you fail to connect, load paper, and then press the ⬇ button to print a network connection report.

Related Information

➔ [“Checking the Printer's Network Connection Status \(Network Connection Report\)” on page 122](#)

Making Wi-Fi Settings by Push Button Setup (WPS)

You can automatically set up a Wi-Fi network by pressing a button on the wireless router. If the following conditions are met, you can set up by using this method.

- ❑ The wireless router is compatible with WPS (Wi-Fi Protected Setup).
- ❑ The current Wi-Fi connection was established by pressing a button on the wireless router.

1. Select **Wi-Fi Setup** on the home screen.

To select an item, use the ▲ ▼ ◀▶ buttons, and then press the OK button.

2. Select **Wi-Fi (Recommended)**.
3. Press the OK button to proceed.
4. Select **Push Button Setup (WPS)**.
5. Hold down the [WPS] button on the wireless router until the security light flashes.

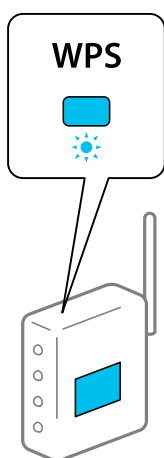

If you do not know where the [WPS] button is, or there are no buttons on the wireless router, see the documentation provided with your wireless router for details.

6. Press the OK button on the printer's control panel. Follow the on-screen instruction hereafter.

Note:

If connection fails, restart the wireless router, move it closer to the printer, and try again. If it still does not work, print a network connection report and check the solution.

Related Information

➔ [“Checking the Printer's Network Connection Status \(Network Connection Report\)” on page 122](#)

Making Wi-Fi Settings by PIN Code Setup (WPS)

You can automatically connect to an wireless router by using a PIN code. You can use this method to set up if an wireless router is capable of WPS (Wi-Fi Protected Setup). Use a computer to enter a PIN code into the wireless router.

1. Select **Wi-Fi Setup** on the home screen.

To select an item, use the ▲ ▼ ◀▶ buttons, and then press the OK button.

2. Select **Wi-Fi (Recommended)**.

3. Press the OK button to proceed.
4. Select **Others**.
5. Select **PIN Code (WPS)**.
6. Use your computer to enter the PIN code (an eight digit number) displayed on the printer's control panel into the wireless router within two minutes.

Note:

See the documentation provided with your wireless router for details on entering a PIN code.

7. Press the OK button on the printer.

Setup is complete when the setup completion message is displayed.

Note:

If connection fails, restart the wireless router, move it closer to the printer, and try again. If it still does not work, print a connection report and check the solution.

Related Information

➔ [“Checking the Printer's Network Connection Status \(Network Connection Report\)” on page 122](#)

Checking the Printer's Network Connection Status (Network Connection Report)

You can print a network connection report to check the status between the printer and the wireless router.

1. Load papers.
2. Select **Settings** on the home screen.

To select an item, use the ▲ ▼ ◀ ▶ buttons, and then press the OK button.

3. Select **Network Settings** > **Connection Check**.

The connection check starts.

4. Follow the instructions on the printer's screen to print the network connection report.

If an error has occurred, check the network connection report, and then follow the printed solutions.

Messages and Solutions on the Network Connection Report

Check the messages and error codes on the network connection report, and then follow the solutions.

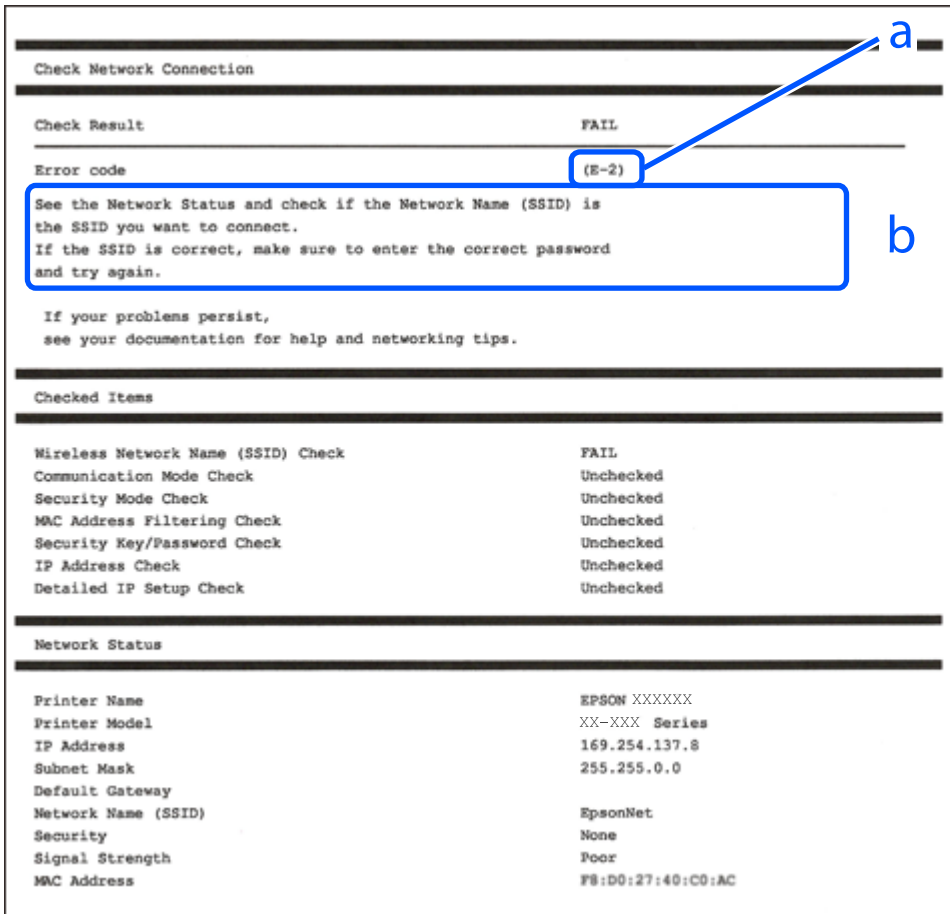

a. Error code

b. Messages on the Network Environment

Related Information

- ➔ “E-1” on page 124
- ➔ “E-2, E-3, E-7” on page 124
- ➔ “E-5” on page 125
- ➔ “E-6” on page 125
- ➔ “E-8” on page 125
- ➔ “E-9” on page 126
- ➔ “E-10” on page 126
- ➔ “E-11” on page 126
- ➔ “E-12” on page 127
- ➔ “E-13” on page 127
- ➔ “Message on the Network Environment” on page 128

E-1

Solutions:

- Make sure the Ethernet cable is securely connected to your printer and to your hub or other network device.
- Make sure your hub or other network device is turned on.
- If you want to connect the printer by Wi-Fi, make Wi-Fi settings for the printer again because it is disabled.

Related Information

➔ [“Making Wi-Fi Settings from the Control Panel” on page 119](#)

E-2, E-3, E-7

Solutions:

- Make sure your wireless router is turned on.
- Confirm that your computer or device is connected correctly to the wireless router.
- Turn off the wireless router. Wait for about 10 seconds, and then turn it on.
- Place the printer closer to your wireless router and remove any obstacles between them.
- If you have entered the SSID manually, check if it is correct. Check the SSID from the **Network Status** part on the network connection report.
- If an wireless router has multiple SSIDs, select the SSID that is displayed. When the SSID is using a non-compliant frequency, the printer does not display them.
- If you are using push button setup to establish a network connection, make sure your wireless router supports WPS. You cannot use push button setup if your wireless router does not support WPS.
- Make sure your SSID uses only ASCII characters (alphanumeric characters and symbols). The printer cannot display an SSID that contains non-ASCII characters.
- Make sure you know your SSID and password before connecting to the wireless router. If you are using a wireless router with its default settings, the SSID and password are located on a label on the wireless router. If you do not know your SSID and password, contact the person who set up the wireless router, or see the documentation provided with the wireless router.
- If you are connecting to an SSID generated from a tethering smart device, check for the SSID and password in the documentation provided with the smart device.
- If your Wi-Fi connection suddenly disconnects, check for the conditions below. If any of these conditions are applicable, reset your network settings by downloading and running the software from the following website.
<https://epson.sn> > **Setup**
 - Another smart device was added to the network using push button setup.
 - The Wi-Fi network was set up using any method other than push button setup.

Related Information

➔ [“Re-Setting the Network Connection” on page 118](#)
➔ [“Making Wi-Fi Settings from the Control Panel” on page 119](#)

E-5

Solutions:

Make sure the wireless router's security type is set to one of the following. If it is not, change the security type on the wireless router, and then reset the printer's network settings.

- WEP-64 bit (40 bit)
- WEP-128 bit (104 bit)
- WPA PSK (TKIP/AES)*
- WPA2 PSK (TKIP/AES)*
- WPA (TKIP/AES)
- WPA2 (TKIP/AES)
- WPA3-SAE (AES)

* WPA PSK is also known as WPA Personal. WPA2 PSK is also known as WPA2 Personal.

E-6

Solutions:

- Check if MAC address filtering is disabled. If it is enabled, register the printer's MAC address so that it is not filtered. See the documentation provided with the wireless router for details. You can check the printer's MAC address from the **Network Status** part on the network connection report.
- If your wireless router is using shared authentication with WEP security, make sure the authentication key and index are correct.
- If the number of connectable devices on the wireless router is less than the number of network devices that you want to connect, make settings on the wireless router to increase the number of connectable devices. See the documentation provided with the wireless router to make settings.

Related Information

➔ [“Making Settings for Connecting to the Computer” on page 118](#)

E-8

Solutions:

- Enable DHCP on the wireless router if the printer's Obtain IP Address setting is set to Auto.
- If the printer's Obtain IP Address setting is set to Manual, the IP address you manually set is invalid due to out of range (for example: 0.0.0.0). Set a valid IP address from the printer's control panel.

Related Information

➔ [“Setting a Static IP Address for the Printer” on page 134](#)

E-9

Solutions:

Check the following.

- Devices are turned on.
- You can access the Internet and other computers or network devices on the same network from the devices you want to connect to the printer.

If still does not connect your printer and network devices after confirming the above, turn off the wireless router. Wait for about 10 seconds, and then turn it on. Then reset your network settings by downloading and running the installer from the following website.

<https://epson.sn> > Setup

Related Information

➔ “Making Settings for Connecting to the Computer” on page 118

E-10

Solutions:

Check the following.

- Other devices on the network are turned on.
- Network addresses (IP address, subnet mask, and default gateway) are correct if you have set the printer's Obtain IP Address to Manual.

Reset the network address if they are incorrect. You can check the IP address, subnet mask, and default gateway from the **Network Status** part on the network connection report.

If DHCP is enabled, change the printer's Obtain IP Address setting to Auto. If you want to set the IP address manually, check the printer's IP address from the **Network Status** part on the network connection report, and then select Manual on the network settings screen. Set the subnet mask to [255.255.255.0].

If still does not connect your printer and network devices, turn off the wireless router. Wait for about 10 seconds, and then turn it on.

Related Information

➔ “Setting a Static IP Address for the Printer” on page 134

E-11

Solutions:

Check the following.

- The default gateway address is correct if you set the printer's TCP/IP Setup setting to Manual.
- The device that is set as the default gateway is turned on.

Set the correct default gateway address. You can check the default gateway address from the **Network Status** part on the network connection report.

Related Information

➔ [“Setting a Static IP Address for the Printer” on page 134](#)

E-12

Solutions:

Check the following.

- Other devices on the network are turned on.
- The network addresses (IP address, subnet mask, and default gateway) are correct if you are entering them manually.
- The network addresses for other devices (subnet mask and default gateway) are the same.
- The IP address does not conflict with other devices.

If it still does not connect your printer and network devices after confirming the above, try the following.

- Turn off the wireless router. Wait for about 10 seconds, and then turn it on.
- Make network settings again using the installer. You can run it from the following website.
<https://epson.sn> > **Setup**
- You can register several passwords on a wireless router that uses WEP security type. If several passwords are registered, check if the first registered password is set on the printer.

Related Information

➔ [“Setting a Static IP Address for the Printer” on page 134](#)

E-13

Solutions:

Check the following.

- Network devices such as a wireless router, hub, and router are turned on.
- The TCP/IP Setup for network devices has not been set up manually. (If the printer's TCP/IP Setup is set automatically while the TCP/IP Setup for other network devices is performed manually, the printer's network may differ from the network for other devices.)

If it still does not work after checking the above, try the following.

- Turn off the wireless router. Wait for about 10 seconds, and then turn it on.
- Make network settings on the computer that is on the same network as the printer using the installer. You can run it from the following website.
<https://epson.sn> > **Setup**
- You can register several passwords on a wireless router that uses the WEP security type. If several passwords are registered, check if the first registered password is set on the printer.

Related Information

➔ [“Making Settings for Connecting to the Computer” on page 118](#)

➔ [“Setting a Static IP Address for the Printer” on page 134](#)

Message on the Network Environment

| Message | Solution |
|--|---|
| The Wi-Fi environment needs to be improved. Turn the wireless router off and then turn it on. If the connection does not improve, see the documentation for the wireless router. | After moving the printer closer to the wireless router and removing any obstacles between them, turn off the wireless router. Wait for about 10 seconds, and then turn it on. If it still does not connect, see the documentation supplied with the wireless router. |
| *No more devices can be connected. Disconnect one of the connected devices if you want to add another one. | Computer and smart devices that can be connected simultaneously are connected in full in the Wi-Fi Direct (Simple AP) connection. To add another computer or smart device, disconnect one of the connected devices or connect it to the other network first. You can confirm the number of wireless devices which can be connected simultaneously and the number of connected devices by checking the network status sheet or the printer's control panel. |
| The same SSID as Wi-Fi Direct exists in the environment. Change the Wi-Fi Direct SSID if you cannot connect a smart device to the printer. | On the printer's control panel, go to Wi-Fi Direct Setup screen and select the menu to change the setting. You can change the network name following after DIRECT-XX-. Enter within 22 characters. |

Connecting a Smart Device and Printer Directly (Wi-Fi Direct)

Wi-Fi Direct (Simple AP) allows you to connect a smart device directly to the printer without a wireless router and print from the smart device.

About Wi-Fi Direct

Use this connection method when you are not using Wi-Fi at home or at the office, or when you want to connect the printer and the computer or smart device directly. In this mode, the printer acts as an wireless router and you can connect the devices to the printer without having to use a standard wireless router. However, devices directly connected to the printer cannot communicate with each other through the printer.

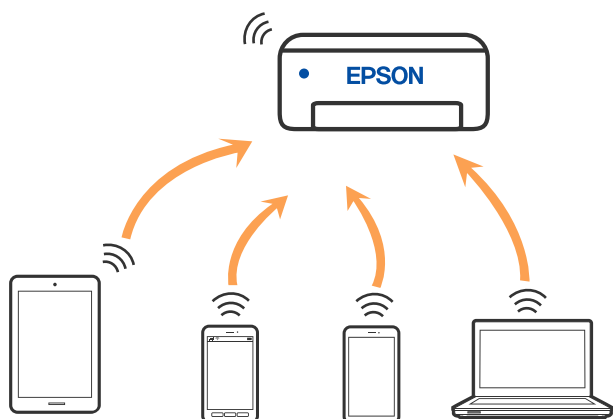

The printer can be connected by Wi-Fi or Ethernet, and Wi-Fi Direct (Simple AP) connection simultaneously. However, if you start a network connection in Wi-Fi Direct (Simple AP) connection when the printer is connected by Wi-Fi, the Wi-Fi is temporarily disconnected.

Connecting to Devices using Wi-Fi Direct

This method allows you to connect the printer directly to smart devices without a wireless router.

Note:

For iOS or Android users, it is convenient to set up from Epson Smart Panel.

You only need to make these settings for the printer and the smart device that you want to connect to once. Unless you disable Wi-Fi Direct or restore the network settings to their defaults, you do not need to make these settings again.

1. Select **Wi-Fi Setup** on the home screen.

To select an item, use the ▲ ▼ ◀▶ buttons, and then press the OK button.

2. Select **Wi-Fi Direct**.
3. Check the message, and then press the OK button to proceed.
4. Check the message, and then press the OK button to proceed.
5. Press the ◀.
6. Select **Other OS Devices**.
7. Scroll the screen with the ▼ button, and check the connection information for Wi-Fi Direct.

- On the smart device's Wi-Fi screen, select the SSID shown on the printer's control panel, and then enter the password.

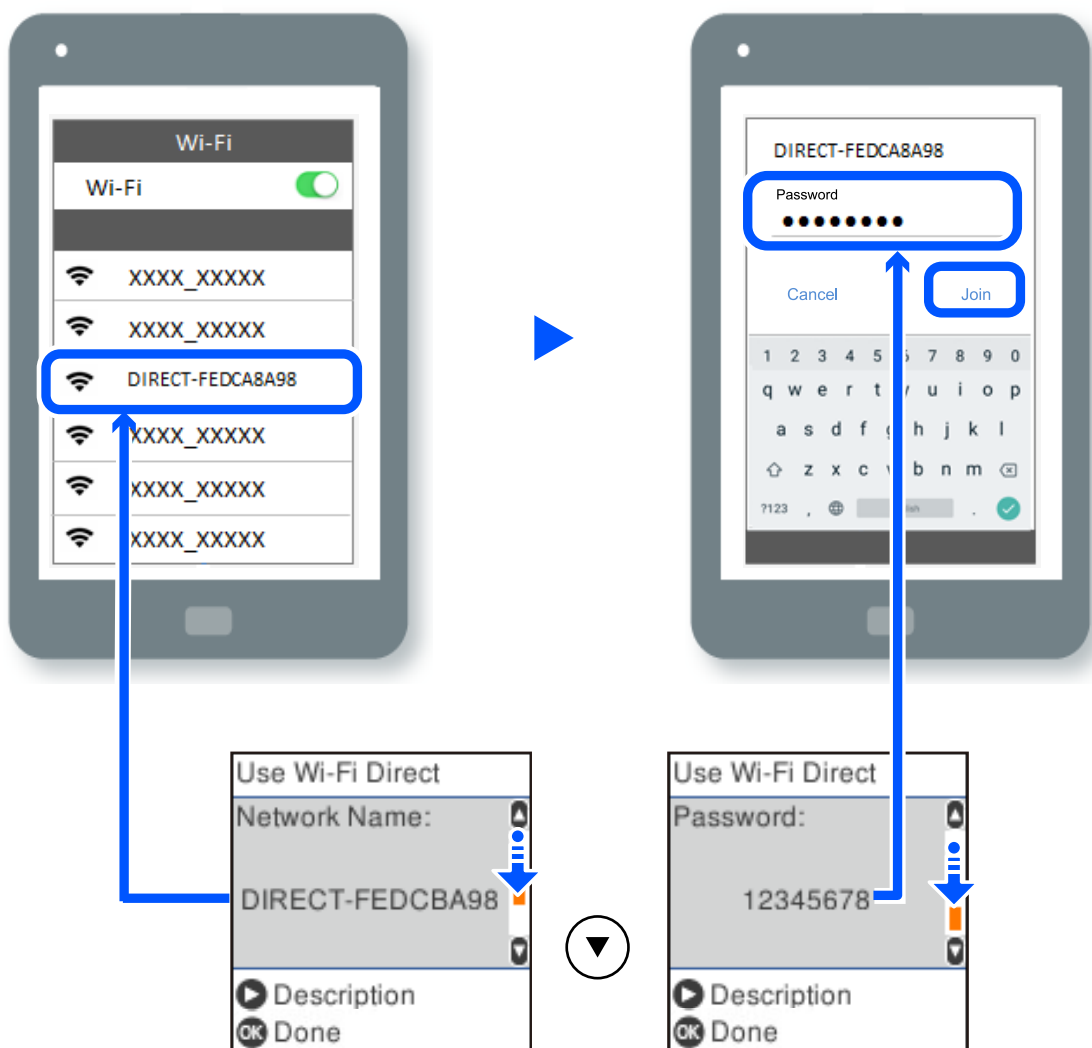

- On the printer's control panel, press the OK button.
 - On the printing app screen for the smart device, select the printer that you want to connect to.
- For smart devices that have been connected to the printer before, select the network name (SSID) on the smart device's Wi-Fi screen to connect them again.

Note:

If you are using an iOS device, you can also connect by scanning the QR code with the standard iOS camera. See the link below <https://epson.sn>.

Disconnecting Wi-Fi Direct (Simple AP) Connection

There are two methods available to disable a Wi-Fi Direct (Simple AP) connection; you can disable all connections by using the printer's control panel, or disable each connection from the computer or the smart device. This section explains how to disable all connections.

 **Important:**

When Wi-Fi Direct (Simple AP) connection disabled, all computers and smart devices connected to the printer in Wi-Fi Direct (Simple AP) connection are disconnected.

Note:

If you want to disconnect a specific device, disconnect from the device instead of the printer. Use one of the following methods to disconnect the Wi-Fi Direct (Simple AP) connection from the device.

- Disconnect the Wi-Fi connection to the printer's network name (SSID).
- Connect to another network name (SSID).

1. Select **Wi-Fi Setup** on the home screen.

To select an item, use the ▲ ▼ ◀▶ buttons, and then press the OK button.

2. Select **Wi-Fi Direct**.
3. Press the OK button to proceed.
4. Press the OK button to proceed.
5. Press the ↺ button to display the setting screen.
6. Select **Disable Wi-Fi Direct**.
7. Check the message, and then press the OK button.

Changing the Wi-Fi Direct (Simple AP) Settings Such as the SSID

When a Wi-Fi Direct (Simple AP) connection is enabled, you can change the Wi-Fi Direct settings such as the network name and the password.

1. Select **Wi-Fi Setup** on the home screen.

To select an item, use the ▲ ▼ ◀▶ buttons, and then press the OK button.

2. Select **Wi-Fi Direct**.
3. Press the OK button to proceed.
4. Press the OK button to proceed.
5. Press the ↺ button to display the setting screen.
6. Select the menu item that you want to change.

You can select the following menu items.

❑ Change Network Name

Change the Wi-Fi Direct (simple AP) network name (SSID) used for connecting to the printer to your arbitrary name. You can set the network name (SSID) in ASCII characters that is displayed on the software keyboard on the control panel.

When changing the network name (SSID), all connected devices are disconnected. Use the new network name (SSID) if you want to re-connect the device.

❑ Change Password

Change the Wi-Fi Direct (simple AP) password for connecting to the printer to your arbitrary value. You can set the password in ASCII characters that is displayed on the software keyboard on the control panel.

When changing the password, all connected devices are disconnected. Use the new password if you want to re-connect the device.

❑ Disable Wi-Fi Direct

Disable Wi-Fi Direct (simple AP) settings of the printer. When disabling it, all devices connected to the printer in Wi-Fi Direct (Simple AP) connection are disconnected.

❑ Restore Default Settings

Restore all Wi-Fi Direct (simple AP) settings to their defaults.

The Wi-Fi Direct (simple AP) connection information of the smart device saved to the printer is deleted.

7. Follow the on-screen instruction.

Adding or Changing the Printer's Connection

To Set Up a Printer on Multiple Computers

Although several computers can be connected to the same wireless router, each computer may be assigned a different SSID.

If the SSIDs assigned by the wireless router are not handled as the same network, then each computer is effectively connected to a different network. When you start setting up the printer from computer A, the printer is added to the same network as computer A allowing computer A to print from it.

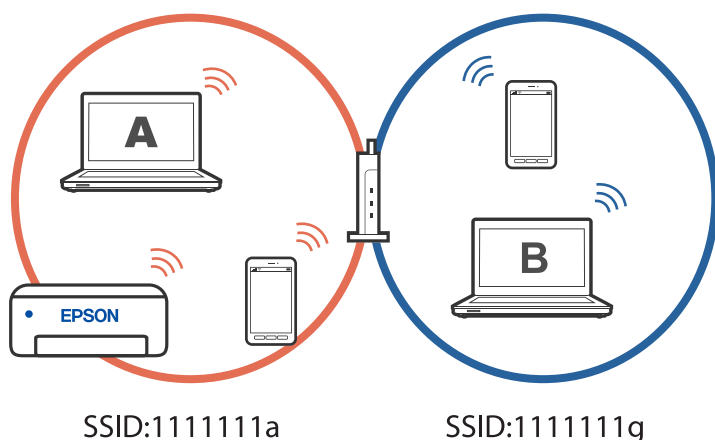

Furthermore, if you start setting up the printer from computer B in the configuration shown above, the printer is set up on computer B's network allowing computer B to print but not computer A.

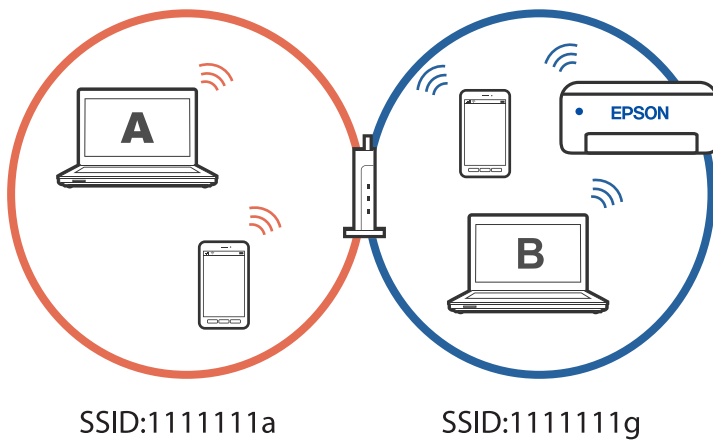

To prevent this from happening, when you want to set up a networked printer from a second computer, start the installer on the computer connected to the same network as the printer. If the printer is found on the same network, the printer will not be reconfigured for the network, and it will set up the printer ready for use.

Changing the Connection from Wi-Fi to USB

Follow the steps below if the Wi-Fi you are using is unstable, or if you want to change to a more stable USB connection.

1. Connect the printer to a computer using a USB cable.
2. Select a printer that is not labeled (XXXXX) when printing using a USB connection.
Your printer name or "Network" is displayed in XXXX depending on the operating system version.

Example of Windows 11

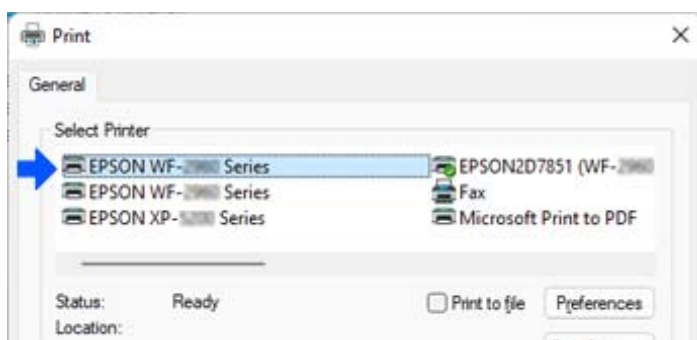

Example of Windows 10

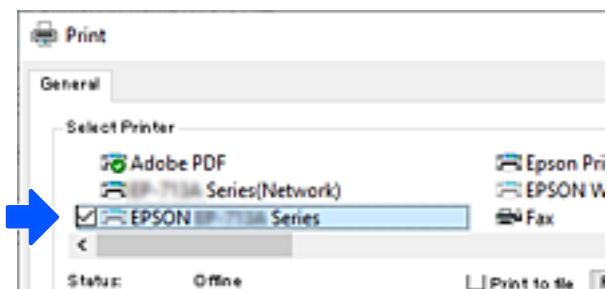

Changing the Network Connection from Wi-Fi to Ethernet

Follow the steps below to change the network connection to Ethernet from Wi-Fi using the control panel.

1. Connect the printer to a router using an Ethernet cable.
2. Disable the Wi-Fi from the printer's control panel.

Setting a Static IP Address for the Printer

You can set up a static IP address for a printer using Web Config.

1. Access Web Config.

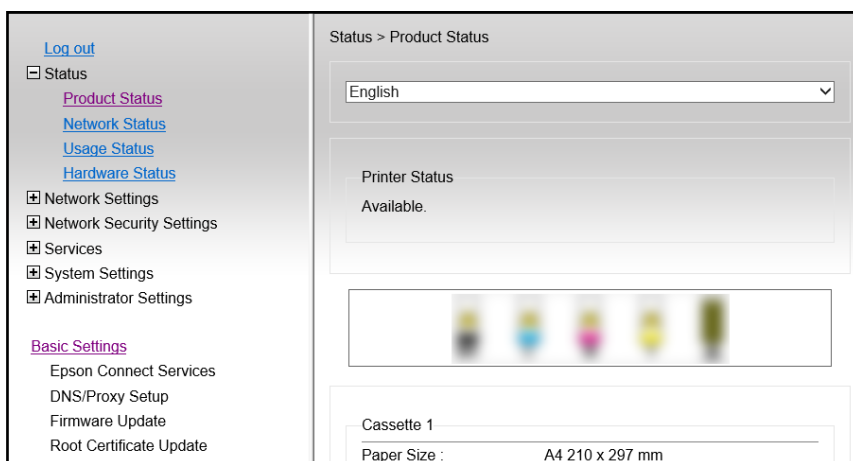

Note:

The display contents and items for Web Config differ depending on the model.

If you see the following, select **Advanced Settings** from the list at the top right of the window.

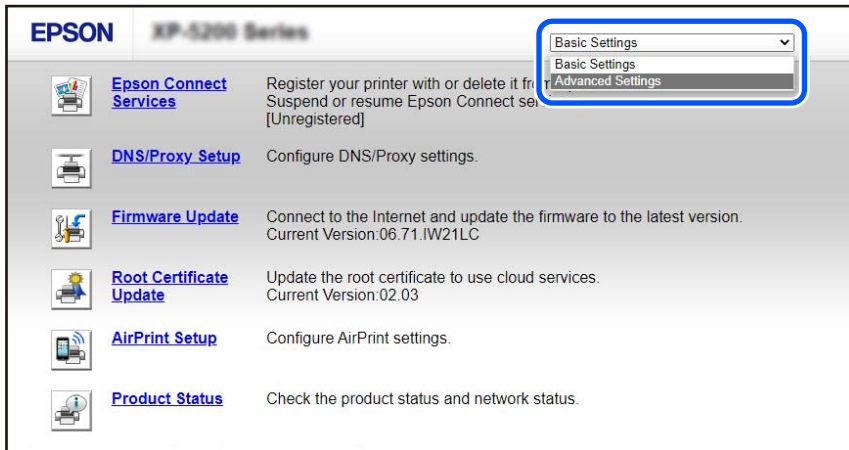

2. Login as an administrator.

Note:

The administrator password is set in advance for the **Advanced Settings** in Web Config. See the link below for details on the administrator password.

3. Select **Network Settings**.

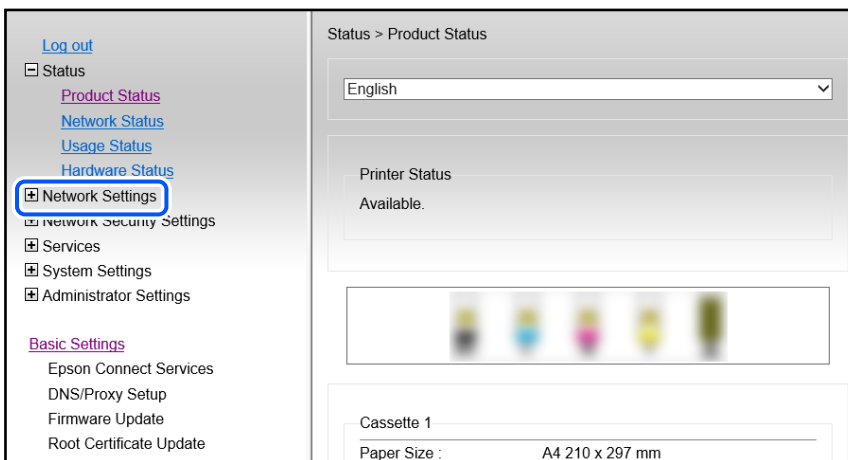

4. Select **Basic**.

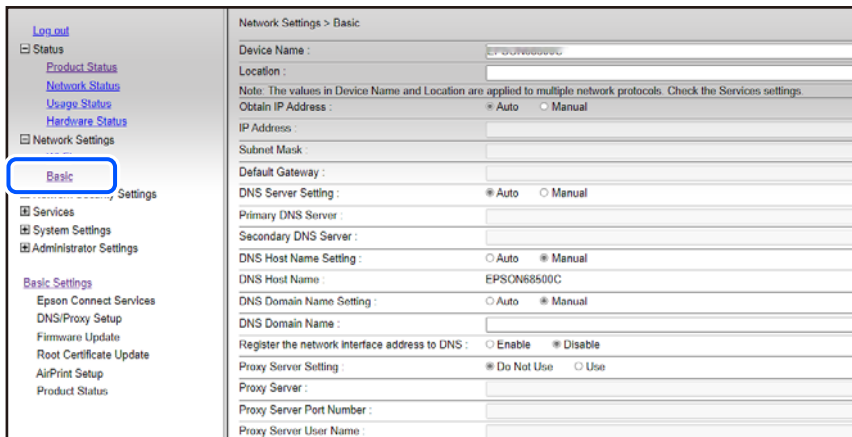

5. Select **Manual** for **Obtain IP Address**.

6. Enter the IP Address you are setting up in **IP Address**.

Set the subnet mask, default gateway, DNS server, and so on. according to your network environment.

7. Click **Next**.

8. Click **OK**.

The settings are applied.

To access Web Config again, specify the IP address you set.

Related Information

➔ [“Application for Configuring Printer Operations \(Web Config\)” on page 210](#)

Transporting and Storing the Printer

When you need to store the printer or transport it when moving or for repairs, follow the steps below to pack the printer.

1. Turn off the printer by pressing the  button.
2. Make sure the power light turns off, and then unplug the power cord.



Important:

Unplug the power cord when the power light is off. Otherwise, the print head does not return to the home position causing the ink to dry, and printing may become impossible.

3. Disconnect all cables such as the power cord and USB cable.
4. Remove all of the paper from the printer.

5. Make sure there are no originals on the printer.



Caution:

Be careful not to trap your hand or fingers when opening or closing the scanner unit. Otherwise you may be injured.

6. Make sure to install the cap onto the ink tank securely.

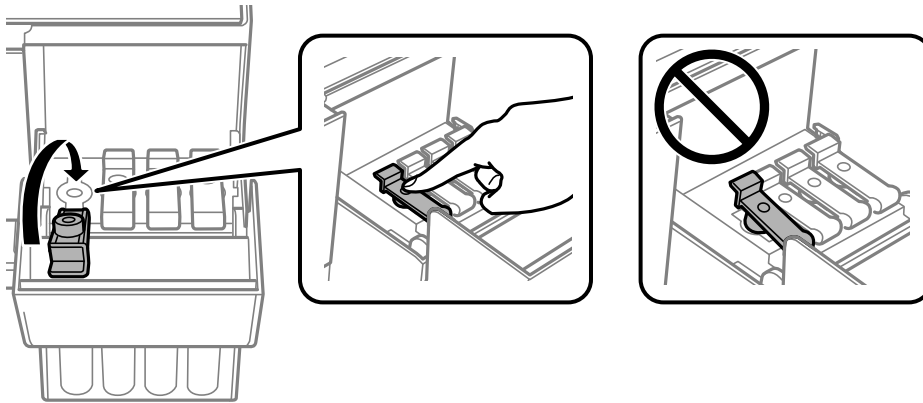

7. Close the ink tank cover securely.

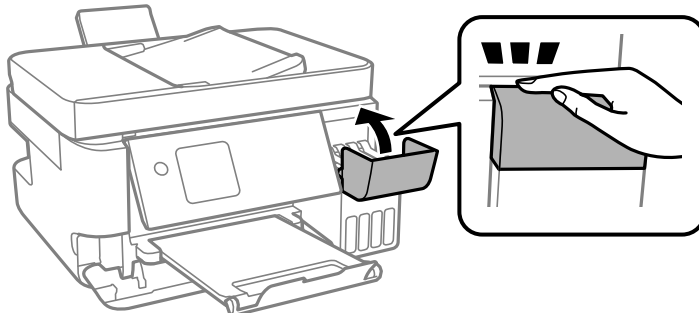

8. Prepare to pack the printer as shown below.

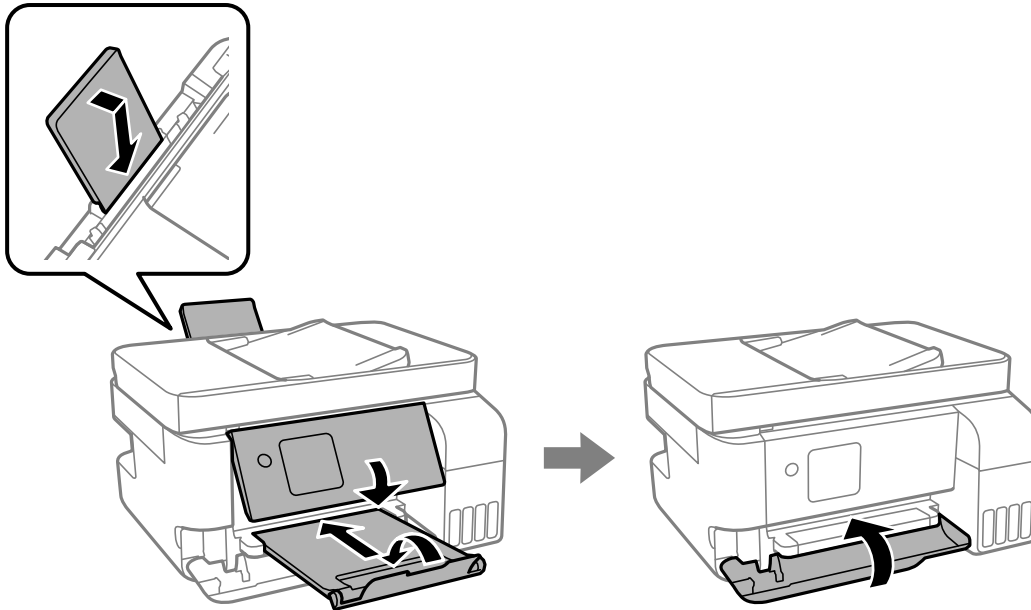

9. Place the printer in the plastic bag and fold it closed.
10. Pack the printer in its box using the protective materials.

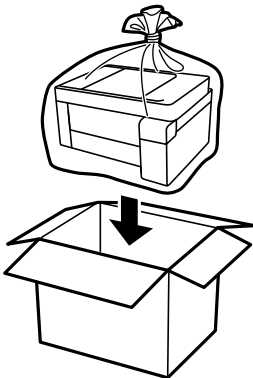

! *Important:*

- ❑ *When storing or transporting the printer, place the printer in the plastic bag and fold it closed. Avoid tilting the printer, placing it vertically, or turning it upside down; otherwise ink may leak.*

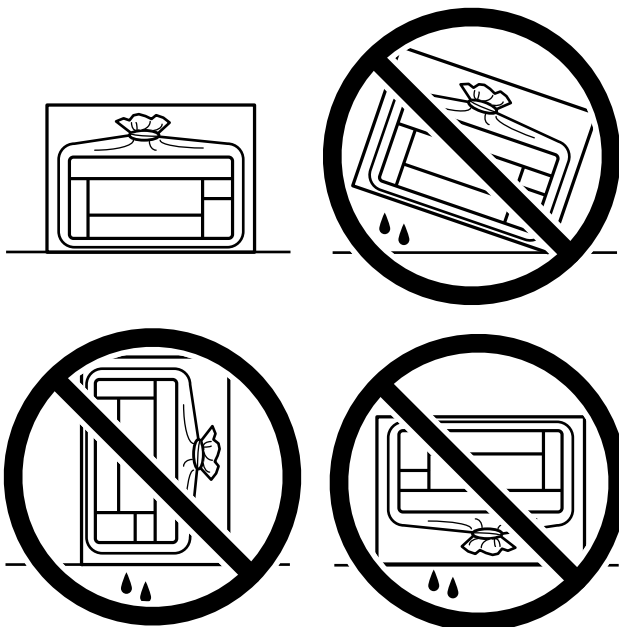

- ❑ *When storing or transporting an ink bottle, do not tilt the bottle and do not subject it to impacts or temperature changes. Otherwise, ink may leak even if the cap on the ink bottle is tightened securely. Be sure to keep the ink bottle upright when tightening the cap, and take precautions to prevent ink from leaking when transporting the bottle, for example, putting the bottle in a bag.*
- ❑ *Do not put opened ink bottles in the box with printer.*



If print quality has declined the next time you print, clean and align the print head.

Related Information

- ➔ [“Checking and Cleaning the Print Head” on page 104](#)
- ➔ [“Aligning the Print Head” on page 107](#)

Solving Problems

| | |
|---|-----|
| Cannot Print, Scan, or Fax. | 141 |
| Printing, Copying, Scanning, and Faxing Quality is Poor. | 158 |
| Cannot Select Paper Type or Paper Source in Printer Driver. | 179 |
| An Error Code is Displayed on the LCD Screen. | 179 |
| Paper Gets Jammed. | 180 |
| It is Time to Refill the Ink. | 186 |
| It is Time to Replace the Maintenance Box. | 191 |
| Cannot Operate the Printer as Expected. | 195 |
| Cannot Solve Problem. | 200 |

Cannot Print, Scan, or Fax

Problem Solving

Read this section if you cannot print, scan, or fax as expected or if there are problems when printing. See the following for solutions to some common problems.

Is the printer turned on?

- Make sure that the printer is turned on.
- Make sure that the power cord is correctly connected.

Related Information

- ➔ [“Power Does Not Turn On” on page 195](#)
- ➔ [“Cannot Solve Problem” on page 200](#)

Is any paper jammed in the printer?

If paper is jammed in the printer, it cannot start printing. Remove the jammed paper from the printer.

Related Information

- ➔ [“Paper Gets Jammed” on page 180](#)

Is the printer itself working properly?

- If an error message is displayed on the LCD screen, check the error.
- Print a status sheet and use it to check if the printer itself can print properly.

Related Information

- ➔ [“An Error Code is Displayed on the LCD Screen” on page 179](#)

Are you having connection problems?

- Make sure that the cables are properly connected for all connections.
- Make sure that the network device and USB hub are operating normally.
- If you have a Wi-Fi connection, make sure that the Wi-Fi connection settings are correct.
- Check the network that your computer and printer are connected to, and make sure that the names of the networks match.

Related Information

- ➔ [“The Printer Cannot Connect to the Network” on page 145](#)

- ➔ [“The Printer Cannot Connect by USB” on page 145](#)
- ➔ [“Checking the Printer’s Network Connection Status \(Network Connection Report\)” on page 122](#)

Has print data been sent correctly?

- Make sure there is no print data standing by from a previous job.
- Check the printer driver to make sure the printer is not offline.

Related Information

- ➔ [“There is still a job waiting to be printed.” on page 143](#)
- ➔ [“The printer is pending or offline.” on page 143](#)

The Application or Printer Driver do not Work Properly

Cannot Print Even Though a Connection has been Established (Windows)

The following causes can be considered.

■ There is a problem with the software or data.

Solutions

- Make sure that a genuine Epson printer driver (EPSON XXXXX) is installed. If a genuine Epson printer driver is not installed, the available functions are limited. We recommend using a genuine Epson printer driver.
 - If you are printing a large data size image, the computer may run out of memory. Print the image at a lower resolution or a smaller size.
 - If you have tried all of the solutions and have not solved the problem, try uninstalling and then reinstalling the printer driver.
 - You may be able to clear the problem by updating the software to the latest version. To check the software status, use the software update tool.
- ➔ [“Checking if a genuine Epson printer driver is installed - Windows” on page 116](#)
 - ➔ [“Checking if a genuine Epson printer driver is installed - Mac OS” on page 118](#)
 - ➔ [“Installing the Applications Separately” on page 115](#)

■ There is a problem with the printer's status.

Solutions

Click **EPSON Status Monitor 3** on the printer driver's **Maintenance** tab, and then check the printer status. If **EPSON Status Monitor 3** is disabled, click **Extended Settings** on the **Maintenance** tab, and then select **Enable EPSON Status Monitor 3**.

There is still a job waiting to be printed.

Solutions

Click **Print Queue** on the printer driver's **Maintenance** tab. If unnecessary data remains, select **Cancel all documents** from the **Printer** menu.

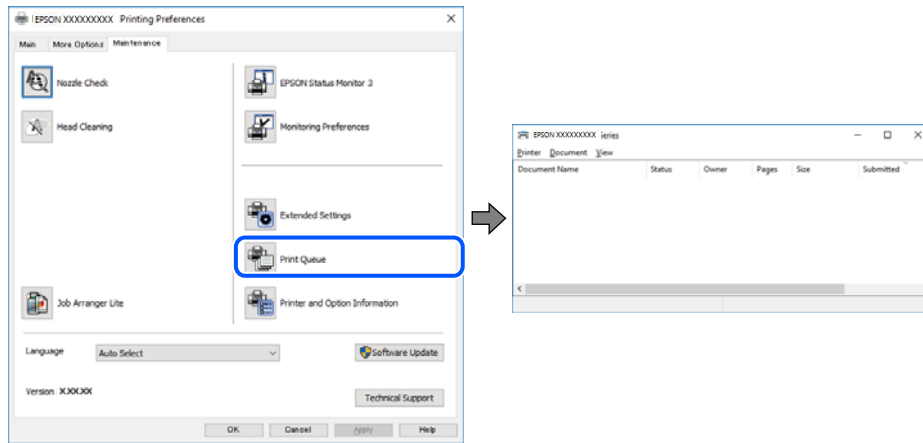

The printer is pending or offline.

Solutions

Click **Print Queue** on the printer driver's **Maintenance** tab.

If the printer is offline or pending, clear the offline or pending setting from the **Printer** menu.

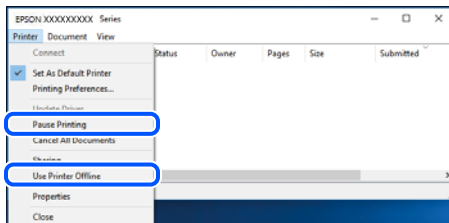

The printer is not selected as the default printer.

Solutions

Right-click the printer icon in **Control Panel > View devices and printers** (or **Printers, Printers and Faxes**) and click **Set as default printer**.

Note:

If there are multiple printer icons, see the following to select the correct printer.

Example)

USB connection: EPSON XXXX Series

Network connection: EPSON XXXX Series (network)

If you install the printer driver multiple times, copies of the printer driver may be created. If copies such as "EPSON XXXX Series (copy 1)" are created, right-click the copied driver icon, and then click **Remove Device**.

The printer port is not set correctly.

Solutions

Click **Print Queue** on the printer driver's **Maintenance** tab.

Make sure the printer port is set correctly as shown below in **Property > Port** from the **Printer** menu.

USB connection: **USBXXX**, Network connection: **EpsonNet Print Port**

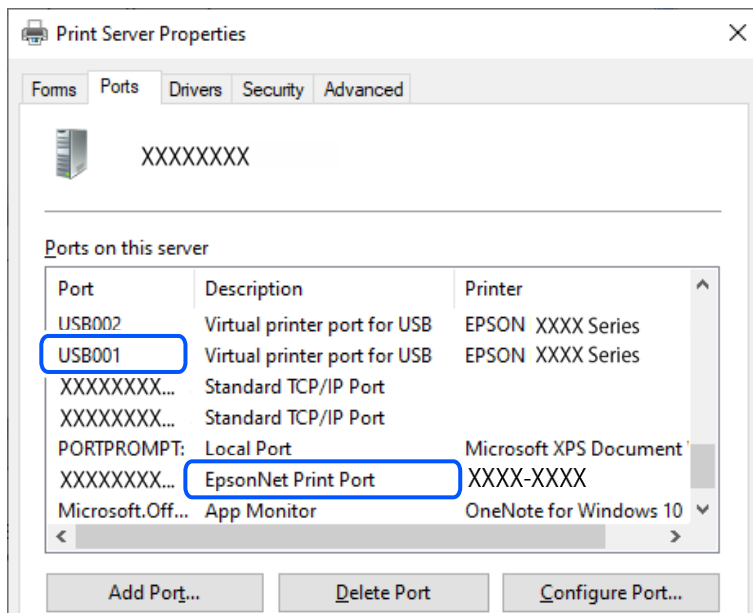

Cannot Print Even Though a Connection has been Established (Mac OS)

The following causes can be considered.

There is a problem with the status of the printer.

Solutions

Make sure the printer status is not **Pause**.

Select **System Preferences** from the **Apple** menu > **Printers & Scanners** (or **Print & Scan, Print & Fax**), and then double-click the printer. If the printer is paused, click **Resume**.

Cannot Print Even Though a Connection has been Established (iOS)

The following causes can be considered.

Paper Setup Auto Display is disabled.

Solutions

Enable **Paper Setup Auto Display** in the following menu.

Settings > Printer Setup > Paper Source Settings > Paper Setup Auto Display

■ **AirPrint is disabled.**

Solutions

Enable the AirPrint setting on Web Config.

➔ [“Application for Configuring Printer Operations \(Web Config\)” on page 210](#)

Cannot Scan Even Though a Connection has been Correctly Established

■ **Scanning at a high resolution over a network.**

Solutions

Try scanning at a lower resolution.

The Printer Cannot Connect by USB

The following causes can be considered.

■ **The USB cable is not plugged into the USB inlet correctly.**

Solutions

Connect the USB cable securely to the printer and the computer.

■ **There is a problem with the USB hub.**

Solutions

If you are using a USB hub, try to connect the printer directly to the computer.

■ **There is a problem with the USB cable or the USB inlet.**

Solutions

If the USB cable cannot be recognized, change the port, or change the USB cable.

The Printer Cannot Connect to the Network

Main causes and solutions for network connection problems

If the Wi-Fi connection fails, check the following to see if there is a problem with the operation or settings for the connected device.

■ **Check the cause of the printer network connection failure.**

Solutions

Print out the network connection check report to see the issue and check the recommended solution.

See the following related information for details on reading the network connection check report.

Note:

If you want to check more information on the network settings, print a network status sheet.

➔ [“Checking the Printer's Network Connection Status \(Network Connection Report\)” on page 122](#)

➔ [“Messages and Solutions on the Network Connection Report” on page 123](#)

Use the Epson Printer Connection Checker to improve the connection to the computer. (Windows)

Solutions

You may be able to solve the problem depending on the results of the check.

1. Double-click the **Epson Printer Connection Checker** icon on the desktop.

Epson Printer Connection Checker starts.

If there is no icon on the desktop, follow the methods below to start Epson Printer Connection Checker.

- Windows 11

Click the start button, and then select **All apps > Epson Software > Epson Printer Connection Checker**.

- Windows 10

Click the start button, and then select **Epson Software > Epson Printer Connection Checker**.

- Windows 8.1/Windows 8

Enter the application name in the search charm, and then select the displayed icon.

- Windows 7

Click the start button, and then select **All Programs > Epson Software > Epson Printer Connection Checker**.

2. Follow the on-screen instructions to check.

Note:

If the printer name is not displayed, install a genuine Epson printer driver.

[“Checking if a genuine Epson printer driver is installed - Windows” on page 116](#)

When you have identified the problem, follow the solution displayed on the screen.

When you cannot solve the problem, check the following according to your situation.

- The printer is not recognized over a network connection

[“Checking the Printer's Network Connection Status \(Network Connection Report\)” on page 122](#)

- The printer is not recognized using a USB connection

[“The Printer Cannot Connect by USB” on page 145](#)

- The printer is recognized, but printing cannot be performed.

[“Cannot Print Even Though a Connection has been Established \(Windows\)” on page 142](#)

Something is wrong with the network devices for Wi-Fi connection.

Solutions

Turn off the devices you want to connect to the network. Wait for about 10 seconds, and then turn on the devices in the following order; wireless router, computer or smart device, and then printer. Move the

printer and computer or smart device closer to the wireless router to help with radio wave communication, and then try to make network settings again.

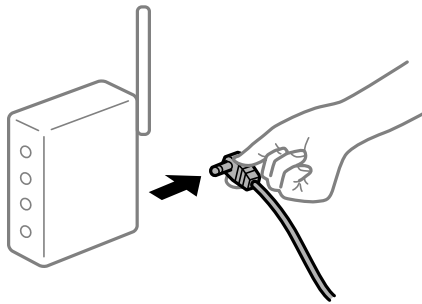

Devices cannot receive signals from the wireless router because they are too far apart.

Solutions

After moving the computer or the smart device and the printer closer to the wireless router, turn off the wireless router, and then turn it back on.

When changing the wireless router, the settings do not match the new router.

Solutions

Make the connection settings again so that they match the new wireless router.

➔ [“Re-Setting the Network Connection” on page 118](#)

The SSIDs connected from the computer or smart device and computer are different.

Solutions

When you are using multiple wireless routers at the same time or the wireless router has multiple SSIDs, you cannot connect to the wireless router.

❑ Example of connecting to different SSIDs

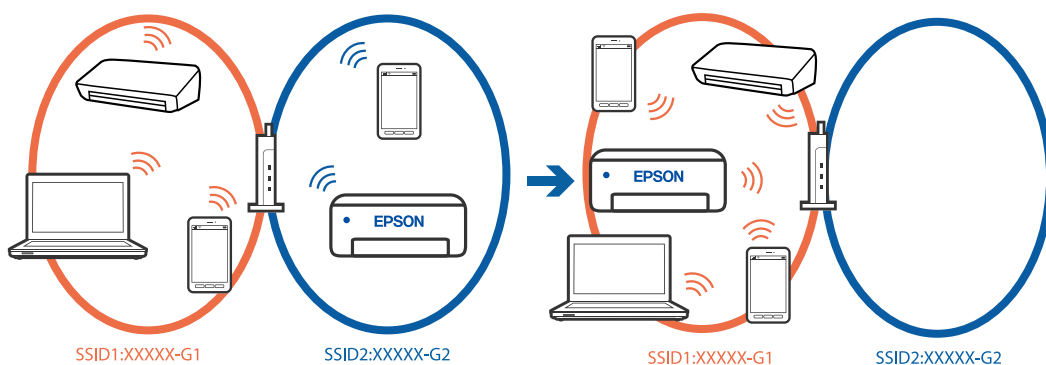

- ❑ Example of connecting to SSIDs with a different frequency range

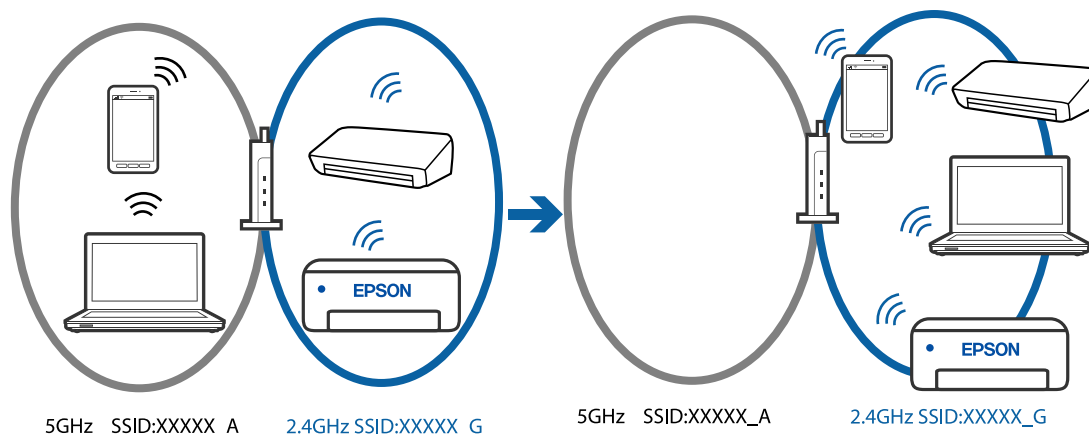

Connect the computer or smart device to the same SSID as the printer.

- ❑ Check the SSID that the printer is connected to by printing out the network connection check report.
- ❑ On all of the computers and smart devices you want to connect to the printer, check the name of the Wi-Fi or network you are connected to.
- ❑ If the printer and your computer or smart device are connected to different networks, reconnect the device to the SSID that the printer is connected to.

■ A privacy separator on the wireless router is available.

Solutions

Most wireless routers have a separator function that blocks communication between devices within the same SSID. If you cannot communicate between the printer and the computer or smart device even if they are connected to the same network, disable the separator function on the wireless router. See the manual provided with the wireless router for details.

■ The IP address is incorrectly assigned.

Solutions

If the IP address assigned to the printer is 169.254.XXX.XXX, and the subnet mask is 255.255.0.0, the IP address may not be assigned correctly.

Print the network connection report, and then check the IP address and the subnet mask assigned to the printer. To print a network connection report, select **Settings > Network Settings > Connection Check**.

Restart the wireless router or reset the network settings for the printer.

➔ [“Setting a Static IP Address for the Printer” on page 134](#)

■ The device connected to the USB 3.0 port causes radio frequency interference.

Solutions

When you connect a device to the USB 3.0 port on a Mac, radio frequency interference may occur. Try the following if you cannot connect to wireless LAN (Wi-Fi) or if operations become unstable.

- ❑ Place the device that is connected to the USB 3.0 port further away from the computer.

There is a problem with the network settings on the computer or smart device.

Solutions

Try accessing any website from your computer or smart device to make sure that your device's network settings are correct. If you cannot access any websites, there is a problem on the computer or smart device.

Check the network connection for the computer or smart device. See the documentation provided with the computer or smart device for details.

The printer has been connected by Ethernet using devices that support IEEE802.3az (Energy Efficient Ethernet).

Solutions

When you connect the printer by Ethernet using devices that support IEEE802.3az (Energy Efficient Ethernet), the following problems may occur depending on the hub or router that you are using.

- Connection becomes unstable, the printer is connected and disconnected again and again.
- Cannot connect to the printer.
- The communication speed becomes slow.

Follow the steps below to disable IEEE802.3az for the printer and then connect.

1. Remove the Ethernet cable connected to the computer and the printer.
2. When IEEE802.3az for the computer is enabled, disable it.
See the documentation provided with the computer for details.
3. Connect the computer and the printer with an Ethernet cable directly.
4. On the printer, print a network connection report.
[“Checking the Printer's Network Connection Status \(Network Connection Report\)” on page 122](#)
5. Check the printer's IP address on the network connection report.
6. On the computer, access Web Config.
7. Select **Log in** and enter the administrator password.
Launch a Web browser, and then enter the printer's IP address.
[“Application for Configuring Printer Operations \(Web Config\)” on page 210](#)
8. Select **Network Settings > Wired LAN**.
9. Select **OFF** for **IEEE 802.3az**.
10. Click **Next**.
11. Click **OK**.
12. Remove the Ethernet cable connected to the computer and the printer.
13. If you disabled IEEE802.3az for the computer in step 2, enable it.

14. Connect the Ethernet cables that you removed in step 1 to the computer and the printer.
If the problem still occurs, devices other than the printer may be causing the problem.

Cannot Send or Receive Faxes

Cannot Send or Receive Faxes

The following causes can be considered.

■ There are some problems in telephone wall jack.

Solutions

Check that the telephone wall jack works by connecting a phone to it and testing it. If you cannot make or receive calls, contact your telecommunication company.

■ There are some problems in connecting to the telephone line.

Solutions

Select **Settings > Fax Settings > Check Fax Connection** on the printer's control panel to run the automatic fax connection check. Try the solutions printed on the report.

■ Communication error occurs.

Solutions

Select **Slow(9,600bps)** in **Settings > Fax Settings > Basic Settings > Fax Speed** on the printer's control panel.

■ Connected to a DSL phone line without DSL filter.

Solutions

To connect to a DSL phone line, you need to use a DSL modem equipped with a built-in DSL filter, or install a separate DSL filter to the line. Contact your DSL provider.

[“Connecting to DSL or ISDN” on page 74](#)

■ There are some problems in the DSL filter when you connect to a DSL phone line.

Solutions

If you can not send or receive fax, connect the printer directly to a telephone wall jack to see if the printer can send a fax. If it works, the problem may be caused by the DSL filter. Contact your DSL provider.

Cannot Send Faxes

The following causes can be considered.

■ The connection line is set to PSTN in a facility where a private branch exchange (PBX) is being used.

Solutions

Select **PBX** in **Settings > Fax Settings > Basic Settings > Line Type** on the printer's control panel.

Sending faxes without entering an access code in an environment in which a PBX is installed.

Solutions

If your phone system requires an external access code to get an outside line, register the access code to the printer, and enter # (hash) at the beginning of a fax number when sending.

The recipient's fax number is wrong.

Solutions

Check that the recipient's number registered in your contacts list or that you entered directly using the keypad is correct. Or, check with the recipient that the fax number is correct.

The recipient's fax machine is not ready to receive faxes.

Solutions

Ask the recipient if the recipient's fax machine is ready to receive a fax.

The data being sent is too large.

Solutions

You can send faxes at a smaller data size using one of the following methods.

- When you send the fax in monochrome, enable **Direct Send** in **Fax > Fax Settings > Fax Send Settings**.
[“Sending Many Pages of a Monochrome Document \(Direct Send\)” on page 88](#)
- Using the connected phone
[“Sending Faxes Dialing from the External Phone Device” on page 87](#)
- Separating the originals

The header information for outgoing faxes is not registered.

Solutions

Select **Settings > Fax Settings > Basic Settings > Header** and set up the header information. Some fax machines automatically reject incoming faxes that do not include header information.

Your caller ID is blocked.

Solutions

Contact your telecommunication company to unblock your caller ID. Some phones or fax machines automatically reject anonymous calls.

Cannot Receive Faxes

The following causes can be considered.

The Receive Mode is set to Manual while an external phone device is connected to the printer.

Solutions

If an external phone device is connected to the printer and is sharing a phone line with the printer, select **Settings > Fax Settings > Basic Settings**, and then set **Receive Mode** to **Auto**.

■ The computer that will save the received faxes is not turned on.

Solutions

When you have made settings to save received faxes to a computer, turn on the computer. The received fax is deleted once it has been saved to the computer.

■ The sender has sent the fax without header information.

Solutions

Ask the sender if header information is setup on their fax machine. Or, disable **Fax Header Blank** in **Settings > Fax Settings > Basic Settings > Rejection Fax > Rejection Fax**. Faxes that do not include header information are blocked when this setting is enabled.

■ The sender's fax number has not been registered in the contacts list.

Solutions

Register the sender's fax number to contact list. Or disable **Caller not in Contacts** in **Settings > Fax Settings > Basic Settings > Rejection Fax > Rejection Fax**. Faxes sent from numbers that have not been registered to this list are blocked.

■ The sender's fax number has been registered to the Rejection Number List.

Solutions

Make sure that the sender's number can be deleted from the **Rejection Number List** before deleting it. Delete it from **Settings > Fax Settings > Basic Settings > Rejection Fax > Edit Blocked Number list**. Or disable the **Rejection Number List** in **Settings > Fax Settings > Basic Settings > Rejection Fax > Rejection Fax**. Faxes sent from numbers that have not been registered to this list are blocked when this setting is enabled.

■ Subscribing to a call forwarding service.

Solutions

If you have subscribed to a call forwarding service, the printer may not be able to receive faxes. Contact the service provider.

Cannot Send Faxes to a Specific Recipient

The following causes can be considered.

■ The recipient's machine takes a long time to answer.

Solutions

If the recipient machine does not pick up your call within 50 seconds after the printer has finished dialing, the call ends with an error. Dial using a connected telephone to check how long it takes before you hear a fax tone. If it takes more than 50 seconds, add pauses after the fax number to send the fax. The  is used to enter pauses. A hyphen is entered as the pause mark. One pause is about three seconds. Add multiple pauses as needed.

■ **The Fax Speed setting registered in the contact list is wrong.**

Solutions

Select **Settings > Contacts Manager > Edit**, and then select the recipient from the contact list. Follow the on-screen instructions, and then set **Communication Mode** to **Slow(9,600bps)**.

Cannot Send Faxes at a Specified Time

■ **The printer's date and time is wrong.**

Solutions

Select **Settings > Basic Settings > Date/Time Settings**, and then set the correct date and time.

Faxes Are Sent at the Wrong Size

The following causes can be considered.

■ **The originals are not placed correctly.**

Solutions

- Make sure the original is placed correctly against the alignment marks.
- If the edge of the scanned image is missing, move the original slightly away from the edge of the scanner glass.

➔ [“Placing Originals” on page 35](#)

■ **There is dust or dirt on the originals or the scanner glass.**

Solutions

Remove any dust or dirt that adheres to the originals, and clean the scanner glass.

➔ [“Cleaning the Scanner Glass” on page 108](#)

Received Faxes Are Not Printed

The following causes can be considered.

■ **An error has occurred in the printer such as a paper jam.**

Solutions

Clear the printer error, and then ask the sender to resend the fax.

■ **Printing received faxes is disabled under the current settings.**

Solutions

If **Save to Computer** is set to **Yes**, change the setting to **Yes and Print**, or disable **Save to Computer**.

You can find **Save to Computer** in **Settings > Fax Settings > Receive Settings**.

Cannot Send or Receive Faxes Even Though a Connection has been Correctly Established (Windows)

The following causes can be considered.

■ The software is not installed.

Solutions

Make sure that the PC-FAX driver have been installed on the computer. The PC-FAX driver is installed with FAX Utility. Follow the steps below to check if it is installed.

Make sure the printer (fax) is displayed in **Devices and Printers, Printer, or Printers and Other Hardware**. The printer (fax) is displayed as "EPSON XXXXX (FAX)". If the printer (fax) is not displayed, uninstall and then re-install the FAX Utility. See the following to access **Devices and Printers, Printer, or Printers and Other Hardware**.

Windows 11

Click on the start button, and then select **All Apps > Windows Tools > Control Panel > View devices and printers in Hardware and Sound**.

Windows 10

Click on the start button, and then select **Windows System > Control Panel > View devices and printers in Hardware and Sound**.

Windows 8.1/Windows 8

Select **Desktop > Settings > Control Panel > View devices and printers in Hardware and Sound or Hardware**.

Windows 7

Click the start button, and select **Control Panel > View devices and printers in Hardware and Sound or Hardware**.

Windows Vista

Click the start button, and select **Control Panel > Printers in Hardware and Sound**.

Windows XP

Click the start button, and select **Settings > Control Panel > Printers and Other Hardware > Printers and Faxes**.

■ User authentication failed when a fax is sent from a computer.

Solutions

Set the user name and password in the printer driver. When sending a fax from a computer when the security function that restrict users from using the printer's fax function is set, user authentication is performed with the user name and password set in the printer driver.

■ There are some problems with fax connection and fax settings.

Solutions

Try the resolutions for fax connection and fax settings.

Cannot Send or Receive Even Though a Connection has been Correctly Established (Mac OS)

The following causes can be considered.

■ **The software is not installed.**

Solutions

Make sure that the PC-FAX driver have been installed on the computer. The PC-FAX driver is installed with FAX Utility. Follow the steps below to check if it is installed.

Select **System Preferences** from the Apple menu > **Printers & Scanners** (or **Print & Scan, Print & Fax**), and then make sure the printer (fax) is displayed. The printer (fax) is displayed as "FAX XXXX (USB)" or "FAX XXXX (IP)". If the printer (fax) is not displayed, click [+] and then register the printer (fax).

■ **PC-FAX driver is paused.**

Solutions

Select **System Preferences** from the Apple menu > **Printers & Scanners** (or **Print & Scan, Print & Fax**), and then double-click the printer (fax). If the printer is paused, click **Resume** (or **Resume Printer**).

■ **User authentication failed when a fax is sent from a computer.**

Solutions

Set the user name and password in the printer driver. When sending a fax from a computer when the security function that restrict users from using the printer's fax function is set, user authentication is performed with the user name and password set in the printer driver.

■ **There are some problems with fax connection and fax settings.**

Solutions

Try the resolutions for fax connection and fax settings.

Paper Does Not Feed Properly

Points to Check

Check the following items, and then try the solutions according to the problems.

■ **The installation location is inappropriate.**

Solutions

Place the printer on a flat surface and operate in the recommended environmental conditions.

➔ [“Environmental Specifications” on page 231](#)

■ **Unsupported paper is being used.**

Solutions

Use paper supported by this printer.

➔ [“Available Paper and Capacities” on page 203](#)

➔ [“Unavailable Paper Types” on page 205](#)

■ **Paper handling is inappropriate.**

Solutions

Follow paper handling precautions.

➔ [“Paper Handling Precautions” on page 29](#)

■ **Too many sheets are loaded in the printer.**

Solutions

Do not load more than the maximum number of sheets specified for the paper. For plain paper, do not load above the line indicated by the triangle symbol on the edge guide.

➔ [“Available Paper and Capacities” on page 203](#)

■ **The paper settings on the printer are incorrect.**

Solutions

Make sure the paper size and paper type settings match the actual paper size and paper type loaded in the printer.

➔ [“Paper Size and Type Settings” on page 30](#)

Paper Feeds at a Slant

The following causes can be considered.

■ **The paper is loaded incorrectly.**

Solutions

Load paper in the correct direction, and slide the edge guide against the edge of the paper.

➔ [“Loading Paper in the Rear Paper Feeder” on page 31](#)

Several Sheets of Paper are Fed at a Time

The following causes can be considered.

■ **The paper is moist or damp.**

Solutions

Load new paper.

■ **Static electricity is causing sheets of paper to stick to each other.**

Solutions

Fan the paper before loading. If the paper still does not feed, load one sheet of paper at a time.

■ **Multiple sheets of paper feed at the same time during manual 2-sided printing.**

Solutions

Remove any paper that is loaded in the paper source before you reload the paper.

Paper Out Error Occurs

■ Paper is not loaded in the center of the rear paper feeder.

Solutions

When a paper out error occurs although paper is loaded in the rear paper feeder, reload paper in the center of the rear paper feeder.

Original Does Not Feed in the ADF

The following causes can be considered.

■ Originals that are not supported by the ADF are being used.

Solutions

Use originals supported by the ADF.

➔ [“ADF Specifications” on page 226](#)

■ The originals are loaded incorrectly.

Solutions

Load originals in the correct direction, and slide the ADF edge guide against the edge of the originals.

■ Too many originals are loaded in the ADF.

Solutions

Do not load originals above the line indicated by the triangle symbol on the ADF.

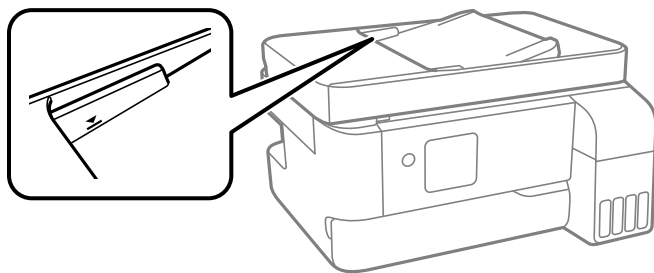

■ The original slips when paper dust adheres to the roller.

Solutions

Clean the inside of the ADF.

➔ [“Cleaning the ADF” on page 109](#)

Printing, Copying, Scanning, and Faxing Quality is Poor

Print Quality is Poor

Color Missing, Banding, or Unexpected Colors Appear in Printout



■ The print head nozzles may be clogged.

Solutions

- ❑ Perform a nozzle check to see if the print head nozzles are clogged. Perform a nozzle check, and then clean the print head if any of the print head nozzles are clogged. If you have not used the printer for a long time, the print head nozzles may be clogged and ink drops may not be discharged.
 - ❑ If you printed when the ink levels were too low to be seen in the ink tank windows, refill the ink tanks to the upper lines and then use the **Power Cleaning** utility to replace the ink inside the ink tubes. After you use the utility, perform a nozzle check to see if print quality has improved.
- ➔ [“Checking and Cleaning the Print Head” on page 104](#)
- ➔ [“Running Power Cleaning” on page 106](#)

Print Quality is Poor with Black Ink

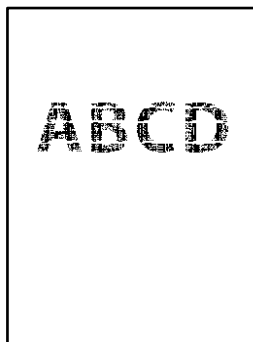

■ The print head nozzles may be clogged.

Solutions

- ❑ Perform a nozzle check to see if the print head nozzles are clogged. Perform a nozzle check, and then clean the print head if any of the print head nozzles are clogged. If you have not used the printer for a long time, the print head nozzles may be clogged and ink drops may not be discharged.
- [“Checking and Cleaning the Print Head” on page 104](#)

- If you cannot solve the problem using head cleaning, you can print immediately with a mixture of color inks to create composite black by changing the following settings in Windows.

Click **Extended Settings** on the printer driver's **Maintenance** tab. If you select **Use a Mixture of Color Inks to Create Black**, you can print at **Standard** print quality when the **Paper Type** is **Plain paper** or **Envelope**.

Note that this feature cannot solve nozzle clogging. To solve nozzle clogging, we recommend contacting Epson support for repairs.

Colored Banding Appears at Intervals of Approximately 3.3 cm

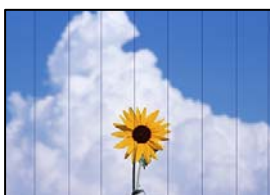

The following causes can be considered.

■ The paper type setting does not match the paper loaded.

Solutions

Select the appropriate paper type setting for the type of paper loaded in the printer.

➔ [“List of Paper Type” on page 30](#)

■ The print quality is set to low.

Solutions

When printing on plain paper, print using a higher quality setting.

- Windows

Select **High** from **Quality** on the printer driver's **Main** tab.

- Mac OS

Select **Fine** as **Print Quality** from the print dialog's **Print Settings** menu.

■ The print head position is out of alignment.

Solutions

Select the **Maintenance > Print Head Alignment > Horizontal Alignment** menu on the control panel to align the print head.

Blurry Prints, Vertical Banding, or Misalignment



enthalten alle
Aufdruck. W
5008 "Regel

The following causes can be considered. Check the causes and follow the solutions in order from the top.

■ The print head position is out of alignment.

Solutions

Select the **Maintenance > Print Head Alignment > Vertical Alignment** menu on the control panel to align the print head.

■ The bidirectional printing setting is enabled.

Solutions

If print quality does not improve even after aligning the print head, disable the bidirectional setting.

During bidirectional (or high speed) printing, the print head prints while moving in both directions, and vertical lines may be misaligned. Disabling this setting may slow down printing speed but improve print quality.

Windows

Clear **Bidirectional Printing** on the printer driver's **More Options** tab.

Mac OS

Select **System Preferences** from the Apple menu > **Printers & Scanners** (or **Print & Scan, Print & Fax**), and then select the printer. Click **Options & Supplies > Options** (or **Driver**). Select **Off** as the **Bidirectional Printing** setting.

Printout Comes Out as a Blank Sheet

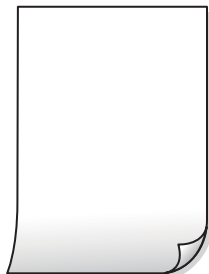

■ The print head nozzles may be clogged.

Solutions

Perform the nozzle check, and then try Power Cleaning if the print head nozzles are clogged.

➔ [“Checking and Cleaning the Print Head” on page 104](#)

➔ [“Running Power Cleaning” on page 106](#)

■ **The print settings and the paper size loaded in the printer are different.**

Solutions

Change the print settings according to the paper size loaded in the printer. Load paper in the printer that matches the print settings.

■ **Multiple sheets of paper are fed into the printer at the same time.**

Solutions

See the following to prevent multiple sheets of paper being fed into the printer at the same time.

➔ [“Several Sheets of Paper are Fed at a Time” on page 156](#)

Paper Is Smearred or Scuffed



The following causes can be considered.

■ **Paper is loaded incorrectly.**

Solutions

When horizontal banding (perpendicular to the printing direction) appears, or the top or bottom of the paper is smeared, load paper in the correct direction and slide the edge guides to the edges of the paper.

➔ [“Loading Paper in the Rear Paper Feeder” on page 31](#)

■ **The paper path is smeared.**

Solutions

When vertical banding (horizontal to the printing direction) appears, or the paper is smeared, clean the paper path.

➔ [“Cleaning the Paper Path for Ink Smears” on page 108](#)

■ **The paper is curled.**

Solutions

Place the paper on a flat surface to check if it is curled. If it is, flatten it.

■ **The print head is rubbing the surface of the paper.**

Solutions

When printing on thick paper, the print head is close to the printing surface and the paper may be scuffed. In this case, enable the reduce scuff setting. If you enable this setting, print quality may decline or printing may slow down.

Windows

Click **Extended Settings** on the printer driver's **Maintenance** tab, and then select **Short Grain Paper**.

■ **The back of the paper was printed before the side that had already been printed was dry.**

Solutions

When performing manual 2-sided printing, make sure that the ink is completely dry before reloading the paper.

Printed Photos are Sticky



■ **The print was made on the wrong side of the photo paper.**

Solutions

Make sure you are printing on the printable side. When printing on the wrong side of the photo paper, you need to clean the paper path.

➔ [“Cleaning the Paper Path for Ink Smears” on page 108](#)

Images or Photos are Printed in Unexpected Colors



The following causes can be considered.

■ **The print head nozzles may be clogged.**

Solutions

Perform a nozzle check to see if the print head nozzles are clogged. Perform a nozzle check, and then clean the print head if any of the print head nozzles are clogged. If you have not used the printer for a long time, the print head nozzles may be clogged and ink drops may not be discharged.

➔ [“Checking and Cleaning the Print Head” on page 104](#)

■ Color correction has been applied.

Solutions

When printing from the Windows printer driver, the Epson auto photo adjustment setting is applied by default depending on the paper type. Try change the setting.

On the **More Options** tab, select **Custom** in **Color Correction**, and then click **Advanced**. Change the **Scene Correction** setting from **Automatic** to any other option. If changing the setting does not work, use any color correction method other than **PhotoEnhance** in **Color Management**.

➔ [“Adjusting the Print Color” on page 53](#)

■ Colors in the Printout Differ from Those on the Display



■ The color properties for the display device you are using have not been adjusted correctly.

Solutions

Display devices such as computer screens have their own display properties. If the display is unbalanced, the images are not displayed with proper brightness and colors. Adjust the properties of the device. If you are using Mac OS, also perform the following operation.

Access the print dialog. Select **Color Matching** from the pop-up menu, and then select **ColorSync**.

■ The display device is reflecting external light.

Solutions

Avoid direct sunlight and confirm the image where an appropriate illuminance is assured.

■ The display device has a high resolution.

Solutions

Colors may differ from what you see on smart devices such as smart phones or tablets with high-resolution displays.

■ The display device and the printer have a different process of producing colors.

Solutions

Colors on a display are not quite identical to those on paper because the display device and the printer have a different process of producing colors. Adjust the color properties so that the colors are identical.

Cannot Print Without Margins



■ **Borderless is not set in the print settings.**

Solutions

Make borderless setting in the print settings. If you select a paper type that does not support borderless printing, you cannot select **Borderless**. Select a paper type that supports borderless printing.

Windows

Select **Borderless** on the printer driver's **Main** tab.

Mac OS

Select a borderless paper size from **Paper Size**.

➔ [“Paper for Borderless Printing” on page 204](#)

Edges of the Image are Cropped During Borderless Printing



■ **Because the image is slightly enlarged, the protruding area is cropped.**

Solutions

Select a smaller enlargement setting.

Windows

Click **Settings** next to the **Borderless** checkbox on the printer driver's **Main** tab, and then change the settings.

Mac OS

Change the **Expansion** setting from the print dialog's **Print Settings** menu.

■ **Aspect ratio of the image data and the paper size is different.**

Solutions

If the aspect ratio of the image data and the paper size is different, the long side of the image is cropped if it extends beyond the long side of the paper.

The computer has been manually put into the Hibernate mode or the Sleep mode while printing.

Solutions

Do not put the computer manually into the **Hibernate** mode or the **Sleep** mode while printing. Pages of garbled text may be printed next time you start the computer.

You are using the printer driver for a different printer.

Solutions

Make sure that the printer driver you are using is for this printer. Check the printer name on the top of the printer driver window.

The Printed Image Is Inverted

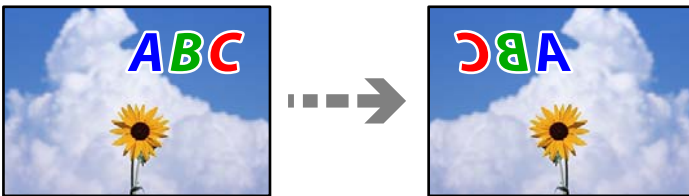

The image is set to invert horizontally in the print settings.

Solutions

Clear any mirror image settings in the printer driver or the application.

Windows

Clear **Mirror Image** on the printer driver's **More Options** tab.

Mac OS

Clear **Mirror Image** from the print dialog's **Print Settings** menu.

Mosaic-Like Patterns in the Prints



Images or photos with a low resolution were printed.

Solutions

When printing images or photos, print using high-resolution data. Images on web sites are often low resolution although they look good enough on the display, and so print quality may decline.

Copy Quality is Poor

Color Missing, Banding, or Unexpected Colors Appear in Copies

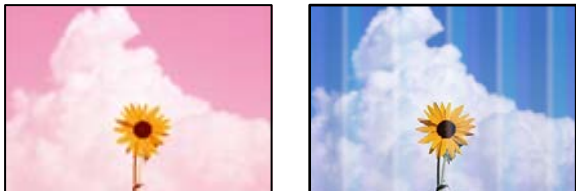

■ The print head nozzles may be clogged.

Solutions

- ❑ Perform a nozzle check to see if the print head nozzles are clogged. Perform a nozzle check, and then clean the print head if any of the print head nozzles are clogged. If you have not used the printer for a long time, the print head nozzles may be clogged and ink drops may not be discharged.
- ❑ If you printed when the ink levels were too low to be seen in the ink tank windows, refill the ink tanks to the upper lines and then use the **Power Cleaning** utility to replace the ink inside the ink tubes. After you use the utility, perform a nozzle check to see if print quality has improved.

➔ [“Checking and Cleaning the Print Head” on page 104](#)

➔ [“Running Power Cleaning” on page 106](#)

Colored Banding Appears at Intervals of Approximately 3.3 cm



The following causes can be considered.

■ The paper type setting does not match the paper loaded.

Solutions

Select the appropriate paper type setting for the type of paper loaded in the printer.

➔ [“List of Paper Type” on page 30](#)

■ The print quality is set to low.

Solutions

When printing on plain paper, print using a higher quality setting.

Select **High** in **Quality**.

➔ [“Quality:” on page 65](#)

■ **The print head position is out of alignment.**

Solutions

Select the **Maintenance > Print Head Alignment > Horizontal Alignment** menu on the control panel to align the print head.

Blurry Copies, Vertical Banding, or Misalignment



enthalten alle
Aufdruck. W
5008 "Regel

The following causes can be considered.

■ **The print head position is out of alignment.**

Solutions

Select the **Maintenance > Print Head Alignment > Vertical Alignment** menu on the control panel to align the print head.

Printout Comes Out as a Blank Sheet

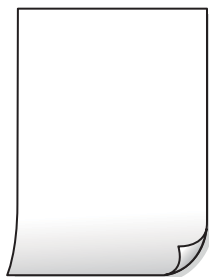

■ **The print head nozzles may be clogged.**

Solutions

Perform the nozzle check, and then try Power Cleaning if the print head nozzles are clogged.

➔ [“Checking and Cleaning the Print Head” on page 104](#)

➔ [“Running Power Cleaning” on page 106](#)

■ **The print settings and the paper size loaded in the printer are different.**

Solutions

Change the print settings according to the paper size loaded in the printer. Load paper in the printer that matches the print settings.

■ **Multiple sheets of paper are fed into the printer at the same time.**

Solutions

See the following to prevent multiple sheets of paper being fed into the printer at the same time.

➔ [“Several Sheets of Paper are Fed at a Time” on page 156](#)

Paper Is Smearred or Scuffed



The following causes can be considered.

■ **Paper is loaded incorrectly.**

Solutions

When horizontal banding (perpendicular to the printing direction) appears, or the top or bottom of the paper is smearred, load paper in the correct direction and slide the edge guides to the edges of the paper.

➔ [“Loading Paper in the Rear Paper Feeder” on page 31](#)

■ **The paper path is smearred.**

Solutions

When vertical banding (horizontal to the printing direction) appears, or the paper is smearred, clean the paper path.

➔ [“Cleaning the Paper Path for Ink Smears” on page 108](#)

■ **The paper is curled.**

Solutions

Place the paper on a flat surface to check if it is curled. If it is, flatten it.

Cannot Copy Without Margins



■ **Borderless is not set in the print settings.**

Solutions

Select **Copy > More > Print Settings > Settings > Borderless Copy** on the control panel. If you select a paper that does not support borderless printing, you cannot enable borderless settings. Select a paper type that supports borderless printing.

➔ [“Paper for Borderless Printing” on page 204](#)

Edges of the Image are Cropped During Borderless Copying



■ **Because the image is slightly enlarged, the protruding area is cropped.**

Solutions

Select a smaller enlargement setting.

Select **Copy > More > Print Settings > Settings > Borderless Copy**, and change the **Expansion** setting.

The Position, Size, or Margins of the Copies are Incorrect

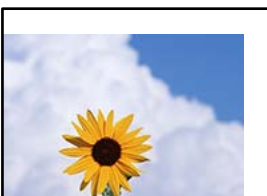

The following causes can be considered.

■ **The paper is loaded incorrectly.**

Solutions

Load paper in the correct direction, and slide the edge guide against the edge of the paper.

➔ [“Loading Paper in the Rear Paper Feeder” on page 31](#)

■ **The originals are not placed correctly.**

Solutions

Make sure the original is placed correctly against the alignment marks.

- ❑ If the edge of the scanned image is missing, move the original slightly away from the edge of the scanner glass.

➔ [“Placing Originals” on page 35](#)

■ **There is dust or dirt on the scanner glass.**

Solutions

When placing the originals on the scanner glass, remove any dust or dirt that has stuck to the originals, and clean the scanner glass. If there is dust or stains on the glass, the copy area may extend to include the dust or stains, resulting in the wrong copying position or small images.

■ **The size of the paper is set incorrectly.**

Solutions

Select the appropriate paper size setting.

Uneven Colors, Smears, Dots, or Straight Lines Appear in the Copied Image

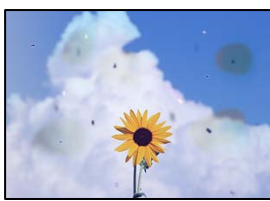

The following causes can be considered.

■ **The paper path is dirty.**

Solutions

Load and eject paper without printing to clean the paper path.

➔ [“Cleaning the Paper Path for Ink Smears” on page 108](#)

■ **There is dust or dirt on the originals or the scanner glass.**

Solutions

Remove any dust or dirt that adheres to the originals, and clean the scanner glass.

➔ [“Cleaning the Scanner Glass” on page 108](#)

■ **There is dust or dirt on the ADF or originals.**

Solutions

Clean the ADF, and remove any dust or dirt that adheres to the originals.

➔ [“Cleaning the ADF” on page 109](#)

■ **The original was pressed with too much force.**

Solutions

If you press with too much force, blurring, smudges, and spots may occur.

Do not press with too much force on the original or the document cover.

■ **The copy density setting is too high.**

Solutions

Lower the copy density setting.

➔ [“More Menu Options for Copying” on page 64](#)

Moiré (Cross-Hatch) Patterns Appear in the Copied Image

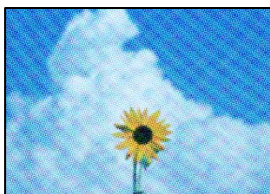

■ **If the original is a printed document such as a magazine or a catalog, a dotted moiré pattern appears.**

Solutions

Change the reduce and enlarge setting. If a moiré pattern still appears, place the original at a slightly different angle.

➔ [“More Menu Options for Copying” on page 64](#)

An Image of the Reverse Side of the Original Appears in the Copied Image



The following causes can be considered.

■ **When scanning thin originals, images on the back may be scanned at the same time.**

Solutions

Place the original on the scanner glass and then place a piece of black paper over it.

➔ [“Placing Originals on the Scanner Glass” on page 37](#)

■ **The copy density setting is too high.**

Solutions

Lower the copy density setting.

➔ [“More Menu Options for Copying” on page 64](#)

The Text or Image Copied from the ADF is Squeezed or Stretched

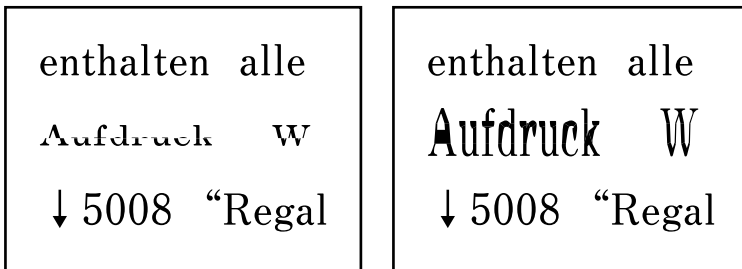

■ **Some originals may not be scanned properly from the ADF.**

Solutions

Place originals on the scanner glass.

➔ [“Placing Originals on the Scanner Glass” on page 37](#)

Scanned Image Problems

Uneven Colors, Dirt, Spots, and so on Appear when Scanning from the Scanner Glass



■ **There is dust or dirt on the originals or the scanner glass.**

Solutions

Remove any dust or dirt that adheres to the originals, and clean the scanner glass.

➔ [“Cleaning the Scanner Glass” on page 108](#)

■ **The original was pressed with too much force.**

Solutions

If you press with too much force, blurring, smudges, and spots may occur.

Do not press with too much force on the original or the document cover.

Straight Lines Appear when Scanning from ADF

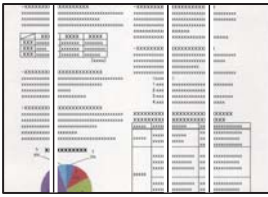

■ **There is dust or dirt on the ADF or originals.**

Solutions

Clean the ADF, and remove any dust or dirt that adheres to the originals.

➔ [“Cleaning the ADF” on page 109](#)

Offset Appears in the Background of Scanned Images



■ **When scanning thin originals, images on the back may be scanned at the same time.**

Solutions

When scanning from the scanner glass, place black paper or a desk pad over the original.

Cannot Scan the Correct Area on the Scanner Glass

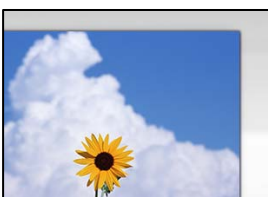

■ **The originals are not placed correctly.**

Solutions

- Make sure the original is placed correctly against the alignment marks.
- If the edge of the scanned image is missing, move the original slightly away from the edge of the scanner glass.

➔ [“Placing Originals” on page 35](#)

■ There is dust or dirt on the scanner glass.

Solutions

Remove any trash or dirt from the scanner glass and document cover. If there is any trash or dirt around the original, the scanning range expands to include it.

➔ [“Cleaning the Scanner Glass” on page 108](#)

Cannot Solve Problems in the Scanned Image

Check the following if you have tried all of the solutions and have not solved the problem.

■ There are problems with the scanning software settings.

Solutions

Use Epson Scan 2 Utility to initialize the settings for the scanner software.

Note:

Epson Scan 2 Utility is an application supplied with the scanner software.

1. Start the Epson Scan 2 Utility.
 - Windows 11
Click the start button, and then select **All apps > EPSON > Epson Scan 2 Utility**.
 - Windows 10
Click the start button, and then select **EPSON > Epson Scan 2 Utility**.
 - Windows 8.1/Windows 8
Enter the application name in the search charm, and then select the displayed icon.
 - Windows 7/Windows Vista/Windows XP
Click the start button, and then select **All Programs or Programs > EPSON > Epson Scan 2 > Epson Scan 2 Utility**.
 - Mac OS
Select **Go > Applications > Epson Software > Epson Scan 2 Utility**.
2. Select the **Other** tab.
3. Click **Reset**.

If initialization does not solve the problem, uninstall and re-install the scanner software.

➔ [“Installing the Applications Separately” on page 115](#)

The Text or Image Scanned from the ADF is Squeezed or Stretched

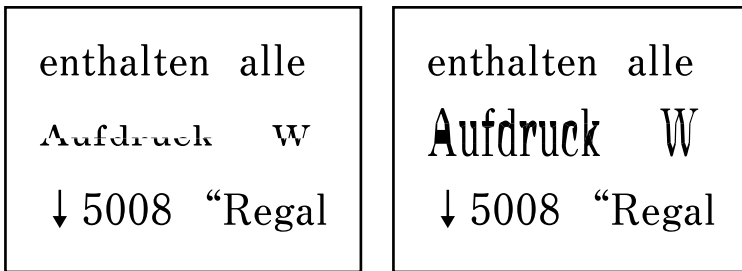

■ Some originals may not be scanned properly from the ADF.

Solutions

Place originals on the scanner glass.

Select , and then select **How To** > **Place Originals** > **Scanner glass**. Select **Finish** to close the animation screen.

The Quality of the Sent Fax is Poor

Quality of the Sent Fax is Poor



The following causes can be considered.

■ There is dust or dirt on the originals or the scanner glass.

Solutions

Remove any dust or dirt that adheres to the originals, and clean the scanner glass.

➔ [“Cleaning the Scanner Glass” on page 108](#)

■ The original was pressed with too much force.

Solutions

If you press with too much force, blurring, smudges, and spots may occur.

Do not press with too much force on the original or the document cover.

Straight Lines Appear when Sending Faxes from the ADF

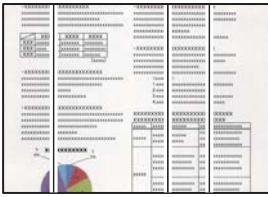

There is dust or dirt on the ADF or originals.

Solutions

Clean the ADF, and remove any dust or dirt that adheres to the originals.

➔ [“Cleaning the ADF” on page 109](#)

The Image Quality of the Sent Fax is Poor

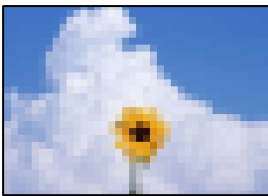

The following causes can be considered.

The resolution is set to low.

Solutions

If you do not know the performance of the sender's fax machine, set the following before sending a fax.

- Select **Fax > Menu > Scan Settings** and then make the **Resolution** setting to set the highest quality image.
- Select **Fax > Menu > Fax Send Settings** and then enable **Direct Send**.

Note that if you set **Resolution** to **Photo** but you send the fax without enabling **Direct Send**, the fax may be sent at a lower resolution.

ECM setting is disabled.

Solutions

Select **Settings > Fax Settings > Basic Settings** and enable the **ECM** setting on the printer's control panel. This may clear errors that occur due to connection problems. Note that the speed of sending and receiving faxes may be slower than when **ECM** is disabled.

An Image of the Reverse Side of the Original Appears in the Sent Fax

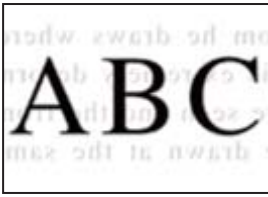

The following causes can be considered.

■ When scanning thin originals, images on the back may be scanned at the same time.

Solutions

Place the original on the scanner glass and then place a piece of black paper over it.

➔ [“Placing Originals on the Scanner Glass” on page 37](#)

■ The density setting is high when sending faxes.

Solutions

Select **Fax > Menu > Scan Settings > Density**, and then lower the setting.

Received Fax Quality is Poor

■ The Image Quality of Received Faxes is Poor

Solutions

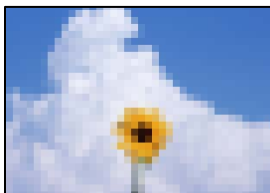

The following causes can be considered.

■ ECM setting is disabled.

Solutions

Select **Settings > Fax Settings > Basic Settings** and enable the **ECM** setting on the printer's control panel. This may clear errors that occur due to connection problems. Note that the speed of sending and receiving faxes may be slower than when **ECM** is disabled.

■ The image quality setting is low on the sender's fax machine.

Solutions

Ask the sender to send faxes at a higher quality.

Cannot Select Paper Type or Paper Source in Printer Driver

■ A genuine Epson printer driver has not been installed.

Solutions

If a genuine Epson printer driver (EPSON XXXXX) has not been installed, the available functions are limited. We recommend using a genuine Epson printer driver.

An Error Code is Displayed on the LCD Screen

A code is displayed on the LCD screen if there is an error or information that requires your attention. If a code is displayed, follow the solutions below to solve the problem.

| Code | Situation | Solutions |
|------|---|--|
| E-01 | A printer error has occurred. | Open the inner cover and the scanner unit, and then remove any paper or protective material inside the printer. Turn the power off and on again. |
| E-02 | A scanner error has occurred. | Turn the power off and on again. |
| E-12 | A borderless printing ink pad needs to be replaced. | Contact Epson or an authorised Epson service provider to replace the borderless printing ink pad*. It is not a user-serviceable part. Borderless printing is not available, but printing with a border is available. |
| W-01 | A paper jam has occurred. | Remove the paper from the printer and press the button displayed on the bottom of the LCD screen to clear the error. In some cases, you need to turn the power off and on again. |
| W-14 | A borderless printing ink pad is nearing the end of its service life. | Contact Epson or an authorised Epson service provider to replace the borderless printing ink pad*. It is not a user-serviceable part. The message will be displayed until the ink pad is replaced. Press the ◊ button to resume printing. |
| I-22 | Set Wi-Fi from the Push Button (WPS) . | Push the access point button. If there is no button on the access point, open the access point setting window, and then click the button displayed in the software. |
| I-23 | Set Wi-Fi from the PIN Code (WPS) . | Enter the PIN code displayed on the LCD screen into the access point or computer within two minutes. |
| I-31 | Set Wi-Fi from the Wi-Fi Auto Connect . | Install the software on your computer, and then press the OK button when Wi-Fi setup starts. |
| I-41 | Paper Setup Auto Display is disabled. Some functions cannot be used. | If Paper Setup Auto Display is disabled, you cannot use AirPrint. |
| I-60 | Your computer may not support WSD (Web Services for Devices). | The scan to computer (WSD) feature is only available for computers running English versions of Windows 10, Windows 8.1, Windows 8, Windows 7 or Windows Vista. Make sure that the printer is correctly connected to the computer. |

| Code | Situation | Solutions |
|---------------|--|---|
| - | Turn the power off and on again. If the problem persists, contact XX. | <p>Try the following solutions.</p> <ol style="list-style-type: none"> 1. Turn the printer off and on again. 2. If you are using a Wi-Fi connection, turn the wireless router off and on again. <p>If the error message is still displayed, make a note of the error code, and then contact Epson support.</p> |
| - | The Ink Pad has reached the end of its service life. Please contact Epson Support. | <p>The ink pad needs to be replaced. Contact Epson or an authorized Epson service provider to replace the ink pad. It is not a user-serviceable part.</p> <p>If the ink pad has reached the end of its service life, you can no longer perform cleaning. Printing can be performed but the quality of the printouts cannot be guaranteed.</p> |
| Recovery Mode | The printer has started in recovery mode because the firmware update failed. | <p>Follow the steps below to try to update the firmware again.</p> <ol style="list-style-type: none"> 1. Connect the computer and the printer with a USB cable. (During recovery mode, you cannot update the firmware over a network connection.) 2. Visit your local Epson website for further instructions. |

* In some print cycles a very small amount of surplus ink may be collected in the borderless printing ink pad. To prevent ink leakage from the pad, the product is designed to stop borderless printing when the pad has reached its limit. Whether and how often this is required will vary according to the number of pages you print using the borderless print option. The need for replacement of the pad does not mean that your printer has ceased to operate in accordance with its specifications. The printer will advise you when the pad requires replacing and this can only be performed by an authorised Epson Service provider. The Epson warranty does not cover the cost of this replacement.

Paper Gets Jammed

Check the error displayed on the control panel and follow the instructions to remove the jammed paper including any torn pieces. Next, clear the error.

Important:

- Remove the jammed paper carefully. Removing the paper vigorously may cause damage to the printer.
- When removing jammed paper, avoid tilting the printer, placing it vertically, or turning it upside down; otherwise ink may leak.

Removing Jammed Paper

 You can also watch the procedure in the Web Movie Manuals. Access the following website.

<https://support.epson.net/publist/vlink.php?code=NPD7019>

Caution:

Never touch the buttons on the control panel while your hand is inside the printer. If the printer starts operating, it could cause an injury. Be careful not to touch the protruding parts to avoid injury.

1. Remove the jammed paper.

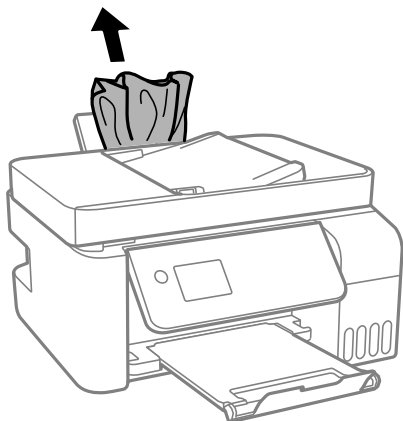

2. Raise the control panel.

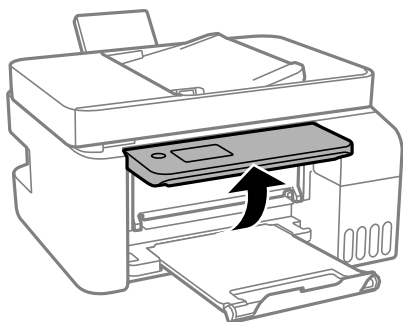

3. Open the inner cover.

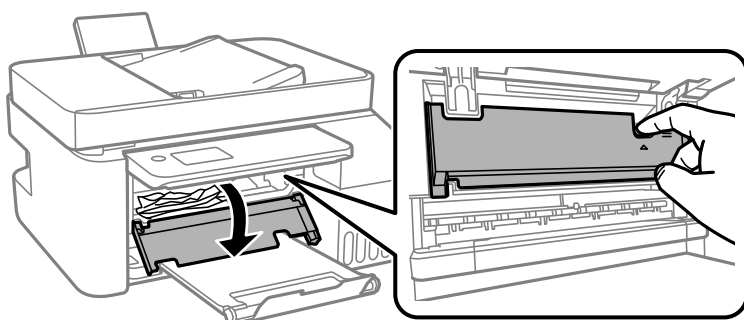

4. Open the scanner unit until it clicks.

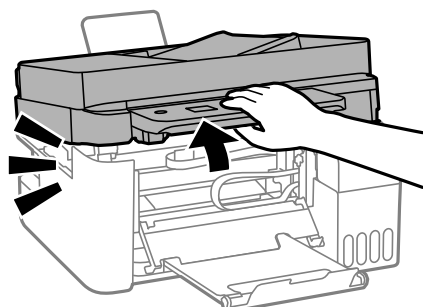

 **Caution:**

Be careful not to trap your hand or fingers when opening or closing the scanner unit. Otherwise you may be injured.

 **Important:**

Do not touch the parts shown in the illustration inside the printer. Doing so may cause a malfunction.

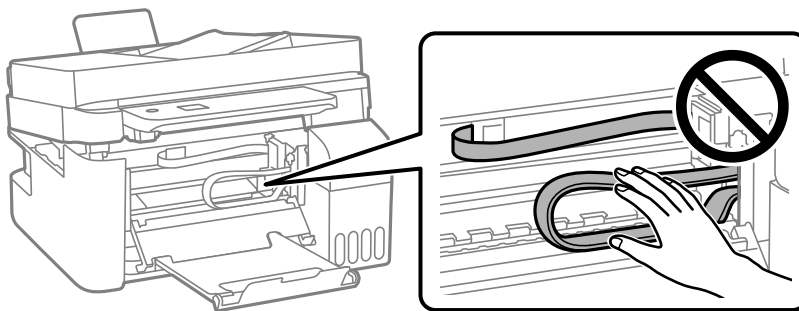

5. Remove the jammed paper.

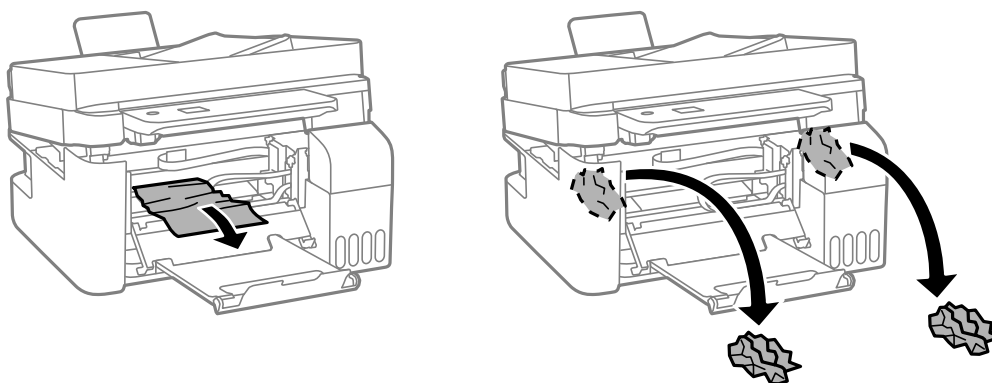

! **Important:**

Do not touch the parts shown in the illustration inside the printer. Doing so may cause a malfunction.

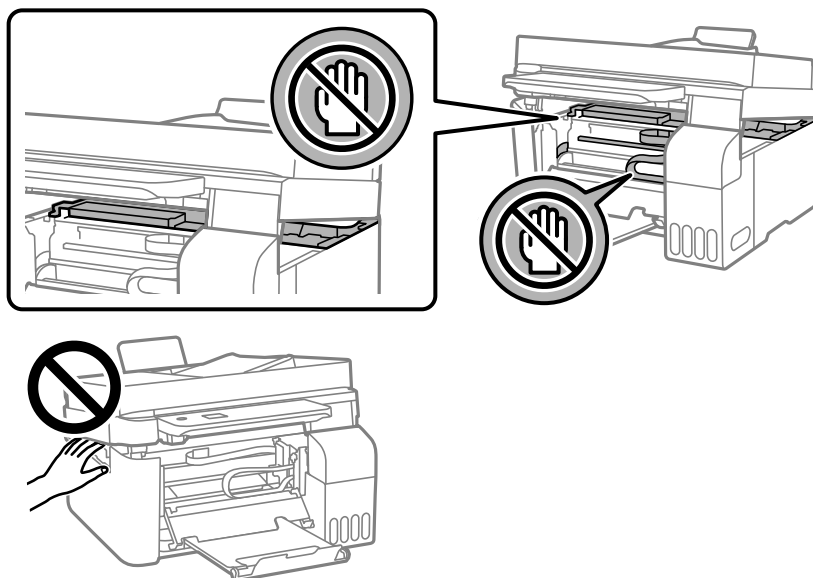

6. Close the scanner unit.

For safety, the scanner unit is closed in two steps.

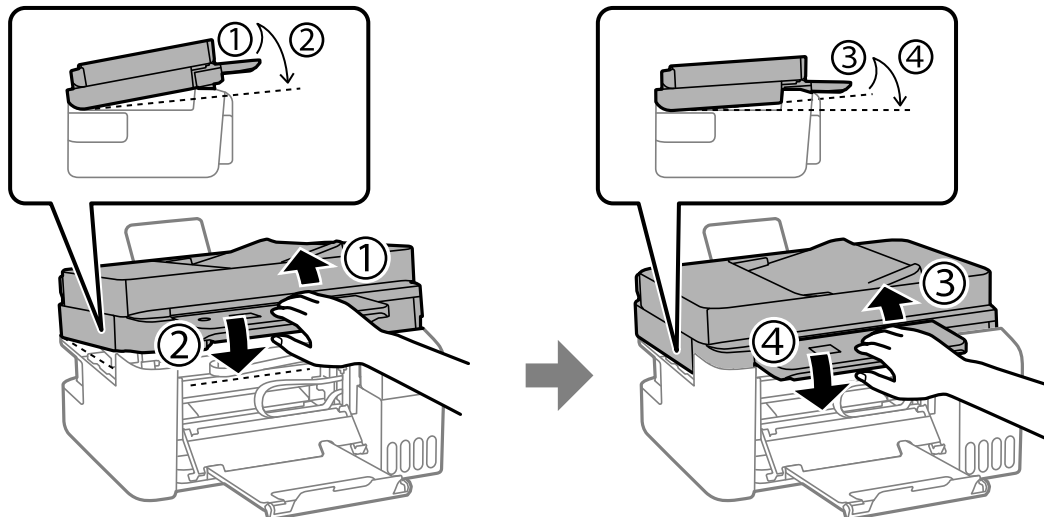

Note:

The scanner unit must be closed completely before it can be opened again.

7. Close the inner cover.

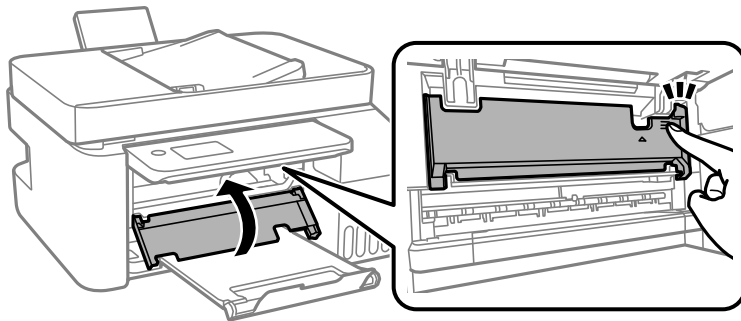

8. Close the control panel.

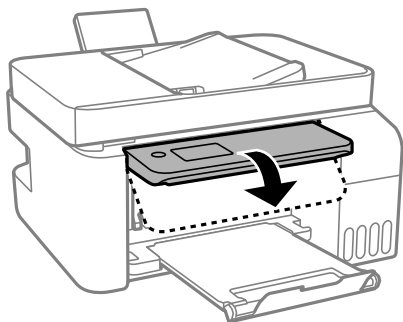

Removing Jammed Paper from the ADF

1. Open the ADF cover.

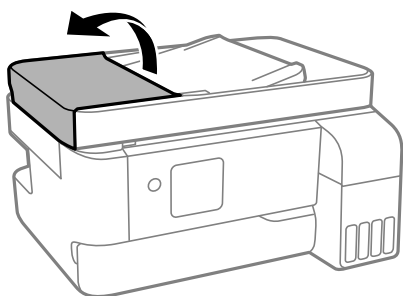

2. Remove the jammed paper.

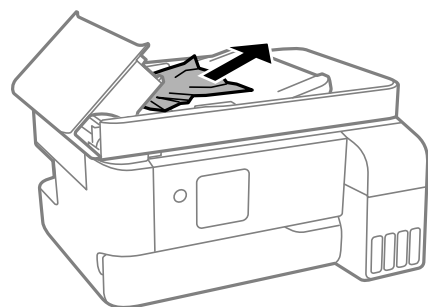

3. Raise the ADF input tray.

! **Important:**

Make sure that you open the ADF cover before raising the ADF input tray. Otherwise, the ADF may be damaged.

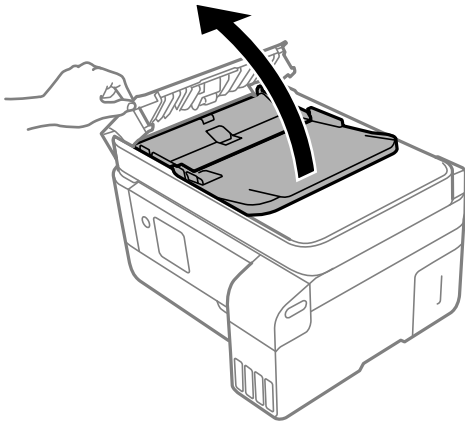

4. Remove the jammed paper.



5. Lower the ADF input tray.

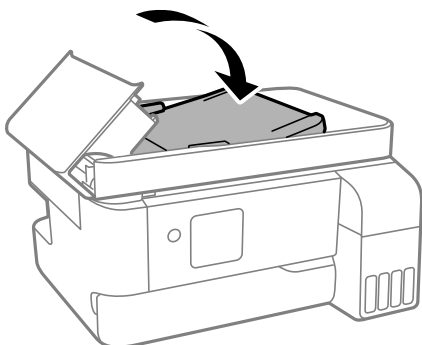

6. Close the ADF cover until it clicks.

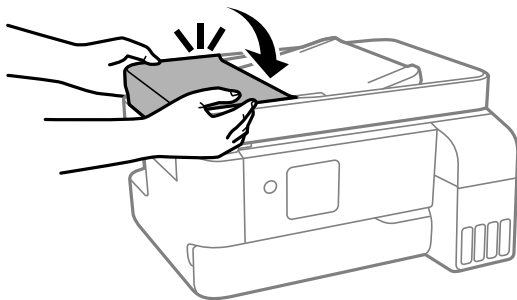

Preventing Paper Jams

Check the following if paper jams occur frequently.

- Place the printer on a flat surface and operate in the recommended environmental conditions.
[“Environmental Specifications” on page 231](#)
- Use the paper supported by this printer.
[“Available Paper and Capacities” on page 203](#)
- Follow paper handling precautions.
[“Paper Handling Precautions” on page 29](#)
- Load paper in the correct direction, and slide the edge guide against the edge of the paper.
[“Loading Paper in the Rear Paper Feeder” on page 31](#)
- Do not load more than the maximum number of sheets specified for paper.
- Load one sheet of paper at a time if you have loaded several sheets of paper.
- Make sure the paper size and paper type settings match the actual paper size and paper type loaded in the printer.
[“List of Paper Type” on page 30](#)

It is Time to Refill the Ink

Ink Bottle Handling Precautions

Read the following instructions before refilling ink.

Storing precautions for ink

- Keep the ink bottles out of direct sunlight.
- Do not store the ink bottles in high or freezing temperatures.
- Epson recommends using the ink bottle before the date printed on the package.
- When storing or transporting an ink bottle, do not tilt the bottle and do not subject it to impacts or temperature changes. Otherwise, ink may leak even if the cap on the ink bottle is tightened securely. Be sure to keep the ink bottle upright when tightening the cap, and take precautions to prevent ink from leaking when transporting the bottle, for example, putting the bottle in a bag.

- After bringing an ink bottle inside from a cold storage site, allow it to warm up at room temperature for at least three hours before using it.
- Do not open the ink bottle package until you are ready to fill the ink tank. The ink bottle is vacuum packed to maintain its reliability. If you leave an ink bottle unpacked for a long time before using it, normal printing may not be possible.
- Once you open an ink bottle, we recommend using it as soon as possible.

Handling precautions for refilling ink

- To ensure you receive premium print quality and to help protect your print head, a variable ink safety reserve remains in the ink tank when your printer indicates to refill ink. The yields quoted for you do not include this reserve.
- For optimum print results do not maintain low ink levels for extended periods of time.
- Use ink bottles with the correct part code for this printer.
- The ink for this printer must be handled carefully. Ink may splatter when the ink tanks are being filled or refilled with ink. If ink gets on your clothes or belongings, it may not come off.
- Do not shake too vigorously or squeeze the ink bottles.
- Prolonged use of the printer when the ink level is below the lower line could damage the printer. Fill the ink tank to the upper line while the printer is not operating. To display the correct ink level estimates, reset the ink level after filling the tank.

Ink consumption

- To maintain optimum print head performance, some ink is consumed from all ink tanks during maintenance operations such as print head cleaning. Ink may also be consumed when you turn the printer on.
- When printing in monochrome or grayscale, color inks instead of black ink may be used depending on the paper type or print quality settings. This is because a mixture of color inks is used to create black.
- The ink in the ink bottles supplied with your printer is partly used during initial setup. In order to produce high quality printouts, the print head in your printer will be fully charged with ink. This one-off process consumes a quantity of ink and therefore these bottles may print fewer pages compared to subsequent ink bottles.
- Quoted yields may vary depending on the images that you are printing, the paper type that you are using, the frequency of your prints and environmental conditions such as temperature.
- Visually check ink levels in the actual ink tanks. Prolonged use of the printer when the ink is expended could damage the printer. Epson recommends filling the ink tank to the upper line when the printer is not operating to reset the ink level.

Refilling the Ink Tanks

1. Select **Maintenance** on the home screen.

To select an item, use the ▲ ▼ ◀ ▶ buttons, and then press the OK button.

2. Select **Fill Ink**.

3. Press the ▼ button to read all the safety and usage precautions for filling ink, and then press the OK button to continue.

4. Open the ink tank cover.

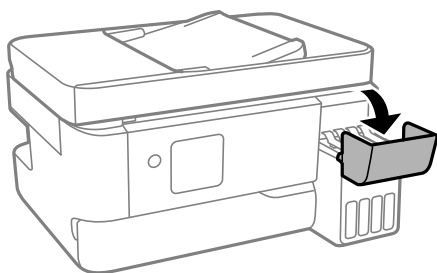

5. Open the ink tank cap.

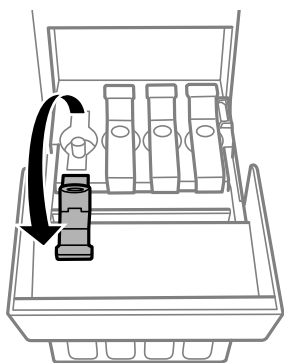

Important:

Make sure that the color of the ink tank matches the ink color that you want to refill.

6. While holding the ink bottle upright, turn the cap slowly to remove it.

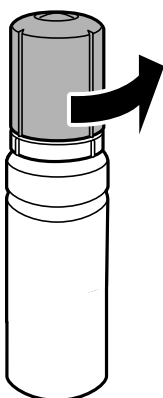

Important:

- Epson recommends the use of genuine Epson ink bottles.
- Be careful not to spill any ink.

7. Check the upper line (a) in the ink tank.

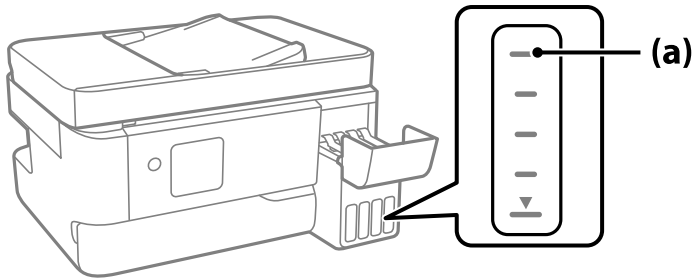

8. Align the top of the ink bottle with the filling port, and then insert it straight into the port to fill ink until it stops automatically at the upper line.

When you insert the ink bottle into the filling port for the correct color, ink starts pouring and the flow stops automatically when the ink reaches the upper line.

If the ink does not start flowing into the tank, remove the ink bottle and reinsert it. However, do not remove and reinsert the ink bottle when the ink has reached the upper line; otherwise ink may leak.

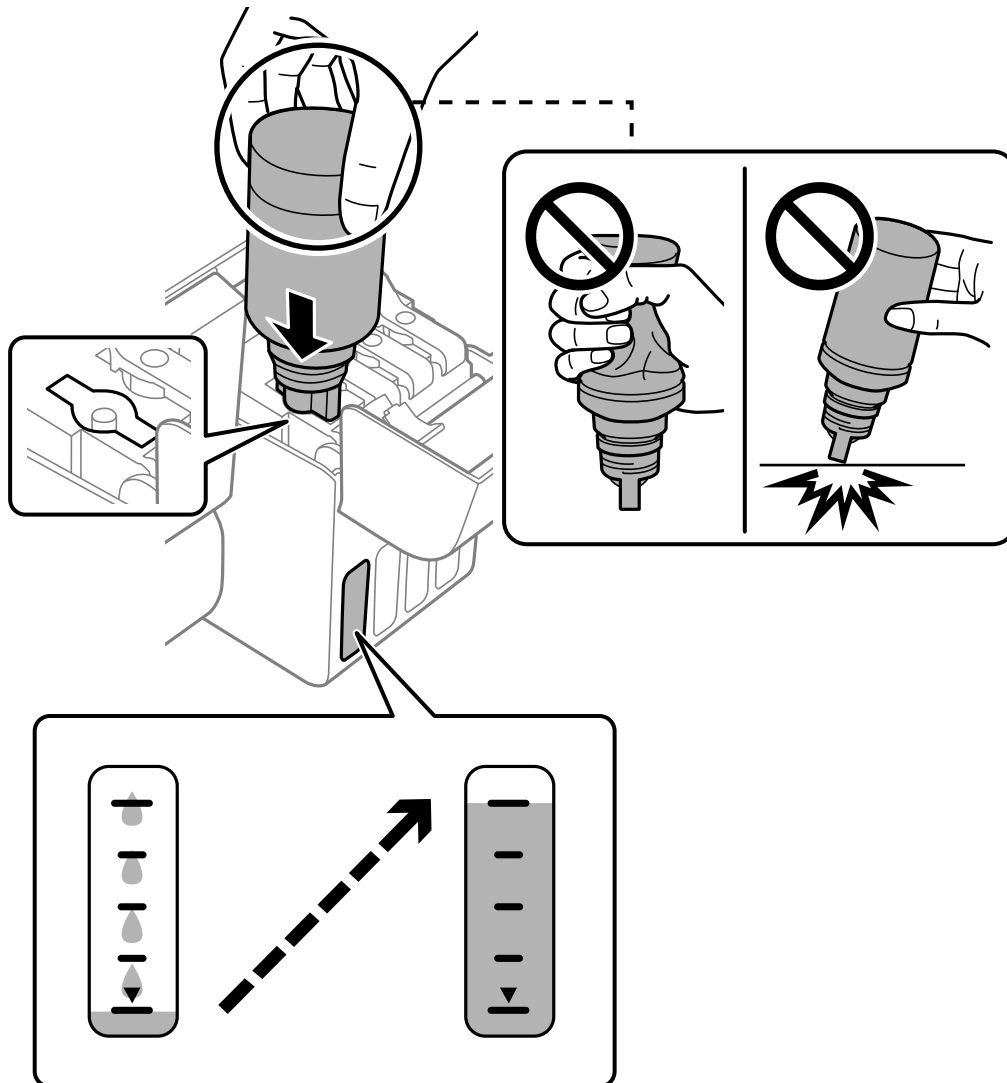

9. When you have finished filling the ink, remove the ink bottle.

! *Important:*

Do not leave the ink bottle inserted; otherwise the bottle may be damaged or ink may leak.

Note:

If any ink remains in the ink bottle, tighten the cap and store the bottle upright for later use.



10. Close the ink tank cap securely.

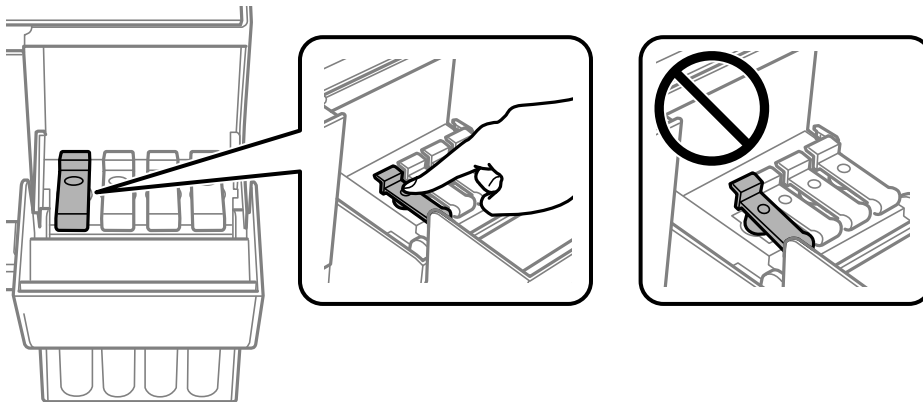

11. Close the ink tank cover firmly.

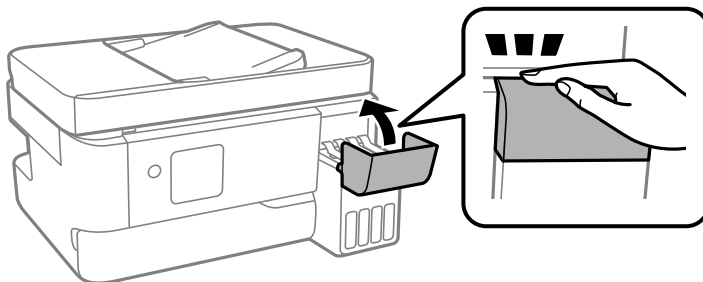

12. Press the  button, and then follow the on-screen instructions to set the ink level.

 **Important:**

Even if you do not refill ink up to the upper line on the ink tank, you can continue using the printer. To keep your printer operating at its best, however, fill ink tank up to the upper line and reset the ink level immediately.

Related Information

- ➔ [“Ink Bottle Handling Precautions” on page 186](#)
- ➔ [“Ink Bottle Codes” on page 205](#)

Notes on Resetting the Ink Level

Be sure to reset the ink level after refilling the ink.

If you refilled two or more colors, you need to select all of the colors that you refilled and reset the ink level.

Unless you reset the ink level, the ink level displayed does not change even after refilling the ink.

It is Time to Replace the Maintenance Box

Maintenance Box Handling Precautions

Read the following instructions before replacing the maintenance box.

- Do not touch the sections shown in the illustration. Doing so may prevent normal operation and you may get smeared with ink.

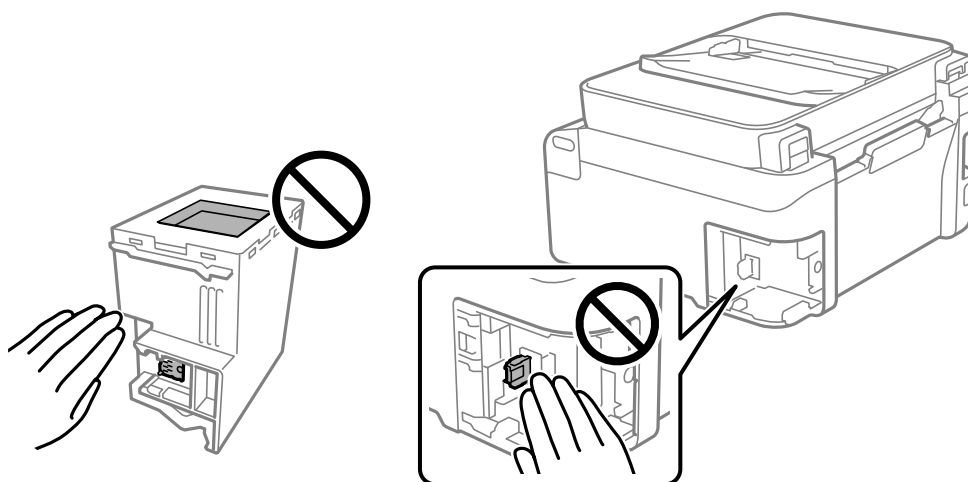

- Do not drop the maintenance box or subject it to strong shocks.
- Do not replace the maintenance box during printing; otherwise, ink may leak.
- Do not remove the maintenance box and its cover except when replacing the maintenance box; otherwise ink may leak.

- When the cover cannot be reattached, the maintenance box may not be installed correctly. Remove the maintenance box, and re-install it.
- Do not tilt the used maintenance box until after it is sealed in the plastic bag; otherwise ink may leak.
- Do not touch the openings in the maintenance box as you may get smeared with ink.
- Do not reuse a maintenance box which has been removed and left detached for a long period. Ink inside the box will have solidified and no more ink can be absorbed.
- Keep the maintenance box out of direct sunlight.
- Do not store the maintenance box in high or freezing temperatures.

Replacing a Maintenance Box

In some print cycles a very small amount of surplus ink may be collected in the maintenance box. To prevent ink leakage from the maintenance box, the printer is designed to stop printing when the absorbing capacity of the maintenance box has reached its limit. Whether and how often this is required will vary according to the number of pages you print, the type of material that you print and the number of cleaning cycles that the printer performs. Replace the maintenance box when you are promoted to do so. The Epson Status Monitor, your LCD, or lights on the control panel will advise you when this part needs replacing. The need for replacement of the box does not mean that your printer has ceased to operate in accordance with its specifications. The Epson warranty does not cover the cost of this replacement. It is a user-serviceable part.

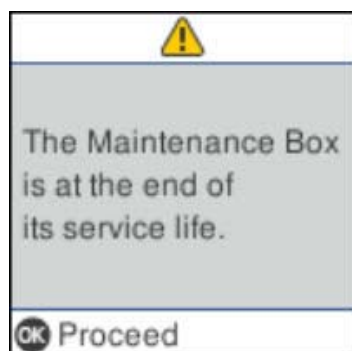

Note:

- When the maintenance box is full, you cannot print and clean the print head until it is replaced to avoid ink leakage. However, you can perform operations that do not use ink such as scanning.
- When the following screen is displayed, the part cannot be replaced by users. Contact Epson support. Borderless printing is not available, but printing with a border is available.

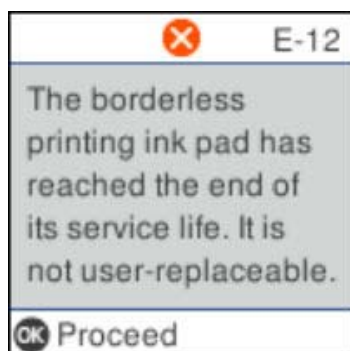

1. Remove the new maintenance box from its package.

! **Important:**

Do not touch the green chip on the side of the maintenance box. Doing so may prevent normal operation and printing.

Note:

A transparent bag for the used maintenance box is provided with the new maintenance box.

2. Loosen the screw with a flat-head screwdriver, and then remove the cover.

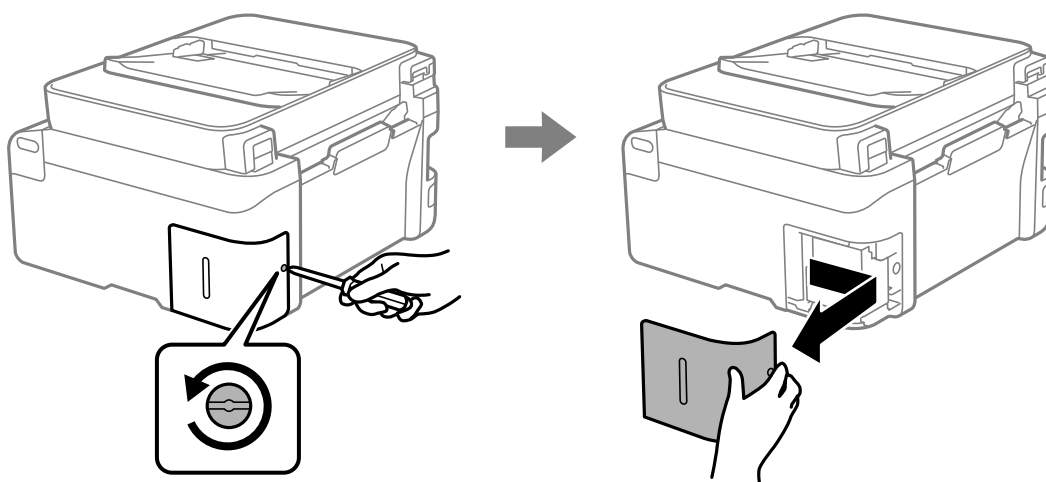

3. Remove the used maintenance box.

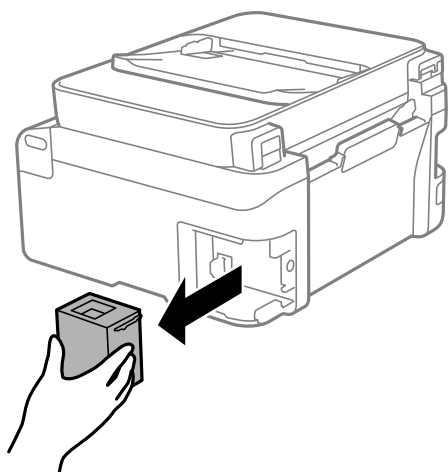

! **Important:**

Do not touch the sections shown in the illustration. Doing so may prevent normal operation and you may get smeared with ink.

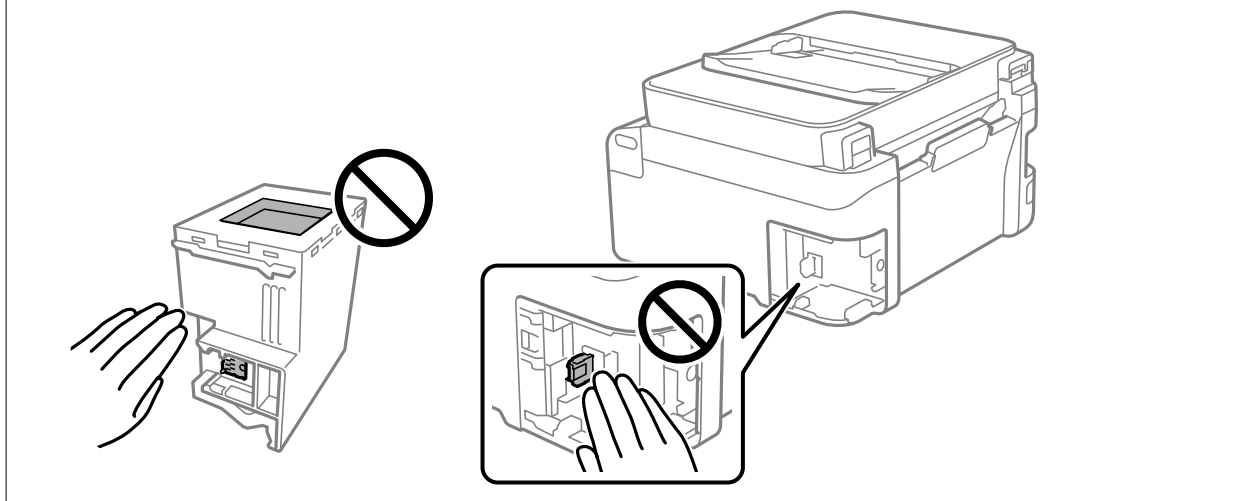

4. Put the used maintenance box in the transparent bag that came with the new maintenance box and seal the bag shut.

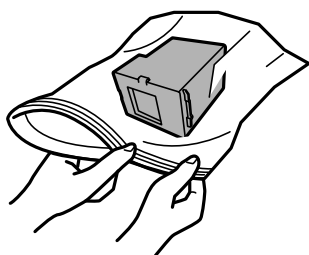

5. Insert the new maintenance box all the way into the printer. Make sure you insert the box in the correct direction.

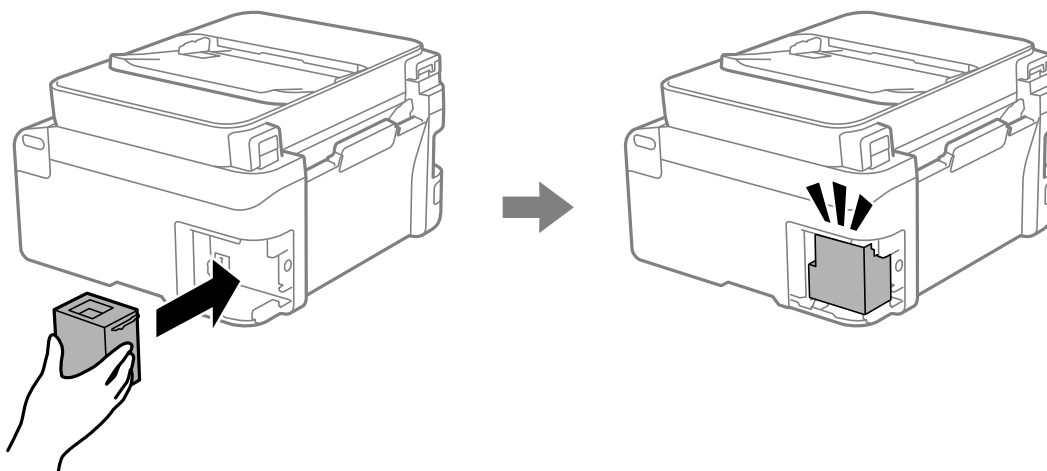

6. Reattach the cover.

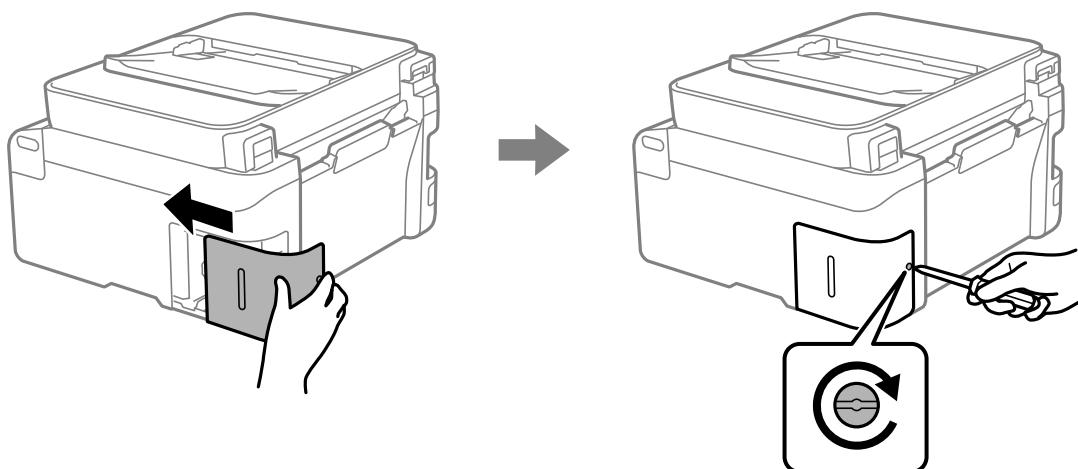

7. Check the message, and then press the OK button.

Related Information

- ➔ [“Maintenance Box Handling Precautions” on page 191](#)
- ➔ [“Maintenance Box Code” on page 206](#)

Cannot Operate the Printer as Expected

The Printer Does Not Turn On or Off

Power Does Not Turn On

The following causes can be considered.

- **The power cord is not plugged in properly to the electrical outlet.**

Solutions

Make sure the power cord is securely plugged in.

- **The  button was not pressed for long enough.**



Solutions

Hold down the  button for a little longer.

Power Does Not Turn Off

■ The  button was not pressed for long enough.

Solutions

Hold down the  button for a little longer. If you still cannot turn off the printer, unplug the power cord. To prevent the print head from drying out, turn the printer back on and turn it off by pressing the  button.

Power Turns Off Automatically

■ The Power Off Settings or Power Off Timer feature is enabled.

Solutions

- Select **Settings > Printer Setup > Power Off Settings**, and then disable the **Power Off If Inactive** and **Power Off If Disconnected** settings.
- Select **Settings > Printer Setup**, and then disable the **Power Off Timer** Setting.

Note:

*Your product may have the **Power Off Settings** or **Power Off Timer** feature depending on the location of purchase.*

Operations are Slow

Printing Is Too Slow

The following causes can be considered.

■ **Unnecessary applications are running.**

Solutions

Close any unnecessary applications on your computer or smart device.

■ **The print quality is set to high.**

Solutions

Lower the quality setting.

■ **Bidirectional printing is disabled.**

Solutions

Enable the bidirectional (or high speed) setting. When this setting is enabled, the print head prints while moving in both directions, and the printing speed increases.

- Windows

Select **Bidirectional Printing** on the printer driver's **More Options** tab.

Mac OS

Select **System Preferences** from the Apple menu > **Printers & Scanners** (or **Print & Scan, Print & Fax**), and then select the printer. Click **Options & Supplies > Options** (or **Driver**). Select **On** as the **Bidirectional Printing** setting.

Quiet Mode is enabled.

Solutions

Disable **Quiet Mode**. The printing speed slows down when the printer is running in **Quiet Mode**.

Control panel

Select  on the home screen, and then select **Off**.

Windows

Select **Off** as the **Quiet Mode** setting on the printer driver's **Main** tab.

Mac OS

Select **System Preferences** from the Apple menu > **Printers & Scanners** (or **Print & Scan, Print & Fax**), and then select the printer. Click **Options & Supplies > Options** (or **Driver**). Select **Off** as the **Quiet Mode** setting.

There may be network connection problems with the wireless router.

Solutions

Reboot the wireless router while taking into consideration other users connected to the network. If this does not solve the problem, place the printer closer to your wireless router or see the documentation provided with the access point.

The printer is printing high density data such as photos on plain paper.

Solutions

If you are printing high-density data such as photos on plain paper, printing may take some time to maintain print quality. This is not a malfunction.

Printing Slows Down Dramatically During Continuous Printing

The function that prevents the printer mechanism from overheating and being damaged is operating.

Solutions

You can continue printing. To return to normal printing speed, leave the printer idle for at least 30 minutes. Printing speed does not return to normal if the power is off.

Scanning Speed Is Slow

Scanning at a high resolution.

Solutions

Try scanning at a lower resolution.

LCD Screen Gets Dark

■ The printer is in sleep mode.

Solutions

Press any button on the control panel to return the LCD screen to its former state.

Operation Sounds Are Loud

■ Quiet Mode is disabled on the printer.

Solutions

If operations sounds are too loud, enable **Quiet Mode**. Enabling this feature may reduce printing speed.

Control panel

Select  on the home screen, and then enable **Quiet Mode**.

Windows

Enable **Quiet Mode** on the printer driver's **Main** tab.

Mac OS

Select **System Preferences** from the Apple menu > **Printers & Scanners** (or **Print & Scan**, **Print & Fax**), and then select the printer. Click **Options & Supplies** > **Options** (or **Driver**). Enable the **Quiet Mode** setting.

The Date and Time Are Incorrect

■ Error occurred in power supply.

Solutions

After a power failure caused by a lightning strike or if the power is left off for a long time, the clock may show the wrong time. Set the date and the time correctly in **Settings** > **Printer Setup** > **Date/Time Settings** on the control panel.

The Root Certificate Needs to be Updated

■ The root certificate has expired.

Solutions

Run Web Config, and then update the root certificate.

➔ [“Application for Configuring Printer Operations \(Web Config\)”](#) on page 210

Cannot Perform Manual 2-sided Printing (Windows)

■ EPSON Status Monitor 3 is disabled.

Solutions

On the printer driver's **Maintenance** tab, click **Extended Settings**, and then select **Enable EPSON Status Monitor 3**.

However, it may not be available when the printer is accessed over a network or is used as a shared printer.

The Print Settings Menu is Not Displayed (Mac OS)

■ The Epson Printer Driver has Not been Installed Correctly.

Solutions

If the **Print Settings** menu is not displayed on macOS Catalina (10.15) or later, macOS High Sierra (10.13), macOS Sierra (10.12), OS X El Capitan (10.11), OS X Yosemite (10.10), OS X Mavericks (10.9), the Epson printer driver has not been installed correctly. Enable it from the following menu.

Select **System Preferences** from the Apple menu > **Printers & Scanners** (or **Print & Scan**, **Print & Fax**), remove the printer, and then add the printer again.

macOS Mojave (10.14) cannot access **Print Settings** in applications made by Apple such as TextEdit.

A Message Prompting You to Reset the Ink Level is Displayed Even After Refilling the Ink

■ Ink level was not reset.

Solutions

After refilling the ink, follow the on-screen instructions to reset the ink level.

The Ink Level Display does not Change Even After Refilling the Ink

■ Ink level was not reset.

Solutions

After refilling the ink, follow the on-screen instructions to reset the ink level.

Cannot Make Calls on the Connected Telephone

The phone cable is not connected correctly.

Connect the telephone to the EXT. port on the printer, and pick up the receiver. If you cannot hear a dial tone through the receiver, connect the phone cable correctly.

Sender's Fax Number Not Displayed

The sender's fax number is not set to the sender's machine.

The sender may not have set the fax number. Contact the sender.

Sender's Fax Number Displayed on Received Faxes is Wrong

The sender's fax number set to the sender's machine is wrong.

The sender may have set the fax number incorrectly. Contact the sender.

Answering Machine Cannot Answer Voice Calls

The printer's Rings to Answer setting is set to less than the number of rings for your answering machine.

Select **Settings > Fax Settings > Basic Settings > Rings to Answer**, and then set a number higher than the number of rings for your answering machine.

A Lot of Junk Faxes Have Been Received

The printer's feature to block junk faxes has not been set up.

Make **Rejection Fax** settings in **Settings > Fax Settings > Basic Settings**.

[“Making Settings for Blocking Junk Faxes” on page 80](#)

Cannot Solve Problem

If you cannot solve the problem after trying all of the solutions, contact Epson support.

If you cannot solve printing or copying problems, see the following related information.

Related Information

➔ [“Cannot Solve Printing or Copying Problems” on page 200](#)

Cannot Solve Printing or Copying Problems

Try the following problems in order starting at the top until you solve the problem.

- Make sure you match the paper type loaded in the printer and the paper type set on the printer to the paper type settings in the printer driver.
[“Paper Size and Type Settings” on page 30](#)
- Use a higher quality setting on the control panel or the printer driver.
- To check the actual ink remaining, visually check the ink levels in the printer's tanks. Refill the ink tanks if the ink levels are below the lower lines.

- ❑ Align the print head.

[“Aligning the Print Head” on page 107](#)

- ❑ Run a nozzle check to see if the print head nozzles are clogged.

If there are missing segments in the nozzle check pattern, the nozzles may be clogged. Repeat head cleaning and the nozzle check alternately 3 times and check if the clogging has cleared.

Note that print head cleaning uses some ink.

[“Checking and Cleaning the Print Head” on page 104](#)

- ❑ Turn off the printer, wait for at least 12 hours, and then check if the clogging has cleared.

If the problem is clogging, leaving the printer for a while without printing may solve the problem.

You can check the following items while the printer is off.

- ❑ Check that you are using genuine Epson ink bottles.

Try to use genuine Epson ink bottles. This product is designed to adjust colors based on the use of genuine Epson ink bottles. The use of non-genuine ink bottles may cause print quality to decline.

- ❑ Make sure that there are no paper fragments left inside the printer.

When you remove the paper, do not touch the translucent film with your hand or the paper.

- ❑ Check the paper.

Check if the paper is curled or loaded with the printable side facing up.

[“Paper Handling Precautions” on page 29](#)

[“Available Paper and Capacities” on page 203](#)

[“Unavailable Paper Types” on page 205](#)

- ❑ If you turn off the printer, wait for at least 12 hours, and if print quality has still not improved, run Power Cleaning.

[“Running Power Cleaning” on page 106](#)

If you cannot solve the problem by checking the solutions above, you may need to request repairs. Contact Epson support.

Related Information

➔ [“Before Contacting Epson” on page 236](#)

➔ [“Contacting Epson Support” on page 236](#)

Product Information

| | |
|--|-----|
| Paper Information. | 203 |
| Consumable Products Information. | 205 |
| Software Information. | 207 |
| Settings Menu List. | 212 |
| Product Specifications. | 224 |
| Regulatory Information. | 232 |

Paper Information

Available Paper and Capacities

Genuine Epson Paper

Epson recommends using genuine Epson paper to ensure high-quality printouts.

Note:

- ❑ The availability of paper varies by location. For the latest information on paper available in your area, contact Epson support.
- ❑ See the following for information on available paper types for borderless and 2-sided printing.
 - “Paper for Borderless Printing” on page 204
 - “Paper for 2-Sided Printing” on page 205

Paper suitable for printing documents

| Media Name | Size | Loading Capacity (Sheets) |
|----------------------------------|------|---------------------------|
| Epson Bright White Ink Jet Paper | A4 | 100 |

Paper suitable for printing documents and photos

| Media Name | Size | Loading Capacity (Sheets) |
|--|------|---------------------------|
| Epson Photo Quality Ink Jet Paper | A4 | 80 |
| Epson Double-sided Photo Quality Ink Jet Paper | A4 | 80 |
| Epson Matte Paper-Heavyweight | A4 | 20 |
| Epson Double-Sided Matte Paper | A4 | 1 |

Paper suitable for printing photos

| Media Name | Size | Loading Capacity (Sheets) |
|-------------------------------------|---|---------------------------|
| Epson Ultra Glossy Photo Paper | A4, 13x18 cm (5x7 in.), 10x15 cm (4x6 in.) | 20* |
| Epson Premium Glossy Photo Paper | A4, 13x18 cm (5x7 in.), 10x15 cm (4x6 in.), 16:9 wide (4x7.11 in.), 9x13 cm (3.5x5 in.) | 20* |
| Epson Premium Semigloss Photo Paper | A4, 10x15 cm (4x6 in.) | 20* |
| Epson Photo Paper Glossy | A4, 13x18 cm (5x7 in.), 10x15 cm (4x6 in.) | 20* |

* Load one sheet of paper at a time if the paper does not feed correctly or if the printout has uneven colors or smears.

Various other paper types

| Media Name | Size | Loading Capacity (Sheets) |
|--|------|---------------------------|
| Epson Photo Quality Self Adhesive Sheets | A4 | 1 |

Commercially Available Paper

Note:

See the following for information on available paper types for borderless and 2-sided printing.

[“Paper for Borderless Printing” on page 204](#)

[“Paper for 2-Sided Printing” on page 205](#)

Plain papers

Plain paper includes copy paper.

| Size | Loading Capacity (Sheets) |
|---|---------------------------|
| A4, B5, A5, A6, B6, Letter | 100*1 |
| Legal, 8.5×13 in., Indian-Legal | 1 |
| User Defined*2(mm) 54x86 to 215.9x1200 | 1 |

*1 Load one sheet of paper at a time if the paper does not feed correctly or if the printout has uneven colors or smears.

*2 Copying or printing from the control panel is not available.

Envelope

| Size | Loading Capacity (Envelopes) |
|--|------------------------------|
| Envelope #10, Envelope DL, Envelope C6 | 10 |

Paper for Borderless Printing

Genuine Epson Paper

- Epson Ultra Glossy Photo Paper (10x15 cm (4x6 in.))
- Epson Premium Glossy Photo Paper (10x15 cm (4x6 in.), 9x13 cm (3.5x5 in))
- Epson Premium Semigloss Photo Paper (10x15 cm (4x6 in.))
- Epson Photo Paper Glossy (10x15 cm (4x6 in.))

Related Information

➔ [“Available Paper and Capacities” on page 203](#)

Paper for 2-Sided Printing

Genuine Epson Paper

- Epson Bright White Ink Jet Paper
- Epson Double-Sided Matte Paper

Related Information

➔ [“Available Paper and Capacities” on page 203](#)

Commercially Available Paper

- Plain paper, Copy paper

Related Information

➔ [“Available Paper and Capacities” on page 203](#)

Unavailable Paper Types

Do not use the following papers. Using these types of paper causes paper jams and smears on the printout.

- Papers that are wavy
- Papers that are torn or cut
- Papers that are folded
- Papers that are damp
- Papers that are too thick or too thin
- Papers that have stickers

Do not use the following envelopes. Using these types of envelope causes paper jams and smears on the printout.

- Envelopes that are curled or folded
- Envelopes with adhesive surfaces on the flaps or window envelopes
- Envelopes that are too thin
They may curl during printing.

Consumable Products Information

Ink Bottle Codes

Epson recommends the use of genuine Epson ink bottles.
The following are the codes for genuine Epson ink bottles.

! **Important:**

- ❑ Epson warranty does not cover damage caused by inks other than those specified, including any genuine Epson ink not designed for this printer or any third party ink.
- ❑ Other products not manufactured by Epson may cause damage that is not covered by Epson's warranties, and under certain circumstances, may cause erratic printer behavior.

Note:

- ❑ Ink bottle codes may vary by location. For the correct codes in your area, contact Epson support.
- ❑ Although the ink bottles may contain recycled materials, this does not affect printer function or performance.
- ❑ Specifications and appearance of the ink bottle are subject to change without prior notice for improvement.

For Europe

| Product | BK: Black | C: Cyan | M: Magenta | Y: Yellow |
|-----------------------------------|-----------|---------|------------|-----------|
| ET-4810 Series/ ET-2840 Series | 104 | 104 | 104 | 104 |
| L5590 Series/L3560 Series | 103 | 103 | 103 | 103 |

Note:

Visit the following website for information on Epson's ink bottle yields.

<http://www.epson.eu/pageyield>

For Australia and New Zealand

| BK: Black | C: Cyan | M: Magenta | Y: Yellow |
|-----------|---------|------------|-----------|
| 522 | 522 | 522 | 522 |

For Asia

| BK: Black | C: Cyan | M: Magenta | Y: Yellow |
|-----------|---------|------------|-----------|
| 003 | 003 | 003 | 003 |

Maintenance Box Code

Epson recommends the use of a genuine Epson maintenance box.

Maintenance box code: C9344

! **Important:**

Once a maintenance box has been installed in a printer it cannot be used with other printers.

Software Information

This section introduces some of the applications available for your printer. For a list of supported software, see the following Epson website or launch Epson Software Updater for confirmation. You can download the latest applications.

<http://www.epson.com>

Related Information

➔ [“Application for Updating Software and Firmware \(Epson Software Updater\)” on page 211](#)

Application for Printing from a Computer (Windows Printer Driver)

The printer driver controls the printer according to the commands from an application. Making settings on the printer driver provides the best printing results. You can also check the status of the printer or keep it in top operating condition using the printer driver utility.

Note:

*You can change the language of the printer driver. Select the language you want to use from the **Language** setting on the **Maintenance** tab.*

Accessing the printer driver from applications

To make settings that apply only to the application you are using, access from that application.

Select **Print** or **Print Setup** from the **File** menu. Select your printer, and then click **Preferences** or **Properties**.

Note:

Operations differ depending on the application. See the application's help for details.

Accessing the printer driver from the control panel

To make settings that apply to all of the applications, access from the control panel.

Windows 11

Click on the start button, and then select **All apps > Windows Tools > Control Panel > View devices and printers in Hardware and Sound**. Right-click on your printer, or press and hold it and then select **Printing preferences**.

Windows 10/Windows Server 2022/Windows Server 2019/Windows Server 2016

Click on the start button, and then select **Windows System > Control Panel > View devices and printers in Hardware and Sound**. Right-click on your printer, or press and hold it and then select **Printing preferences**.

Windows 8.1/Windows 8/Windows Server 2012 R2/Windows Server 2012

Select **Desktop > Settings > Control Panel > View devices and printers in Hardware and Sound**. Right-click on your printer, or press and hold it and then select **Printing preferences**.

Windows 7/Windows Server 2008 R2

Click the start button, and select **Control Panel > View devices and printers in Hardware and Sound**. Right-click on your printer and select **Printing preferences**.

Windows Vista/Windows Server 2008

Click the start button, and select **Control Panel > Printers in Hardware and Sound**. Right-click on your printer and select **Printing preferences**.

- ❑ Windows XP/Windows Server 2003 R2/Windows Server 2003

Click the start button, and select **Control Panel > Printers and Other Hardware > Printers and Faxes**. Right-click on your printer and select **Printing preferences**.

Accessing the printer driver from the printer icon on the task bar

The printer icon on the desktop task bar is a shortcut icon allowing you to quickly access the printer driver.

If you click the printer icon and select **Printer Settings**, you can access the same printer settings window as the one displayed from the control panel. If you double-click this icon, you can check the status of the printer.

Note:

*If the printer icon is not displayed on the task bar, access the printer driver window, click **Monitoring Preferences** on the **Maintenance** tab, and then select **Register the shortcut icon to the taskbar**.*

Starting the utility

Access the printer driver window. Click the **Maintenance** tab.

Application for Printing from a Computer (Mac OS Printer Driver)

The printer driver controls the printer according to the commands from an application. Making settings on the printer driver provides the best printing results. You can also check the status of the printer or keep it in top operating condition using the printer driver utility.

Accessing the printer driver from applications

Click **Page Setup** or **Print** on the **File** menu of your application. If necessary, click **Show Details** (or ▼) to expand the print window.

Note:

*Depending on the application being used, **Page Setup** may not be displayed in the **File** menu, and the operations for displaying the print screen may differ. See the application's help for details.*

Starting the utility

Select **System Preferences** from the Apple menu > **Printers & Scanners** (or **Print & Scan, Print & Fax**), and then select the printer. Click **Options & Supplies > Utility > Open Printer Utility**.

Application for Controlling the Scanner (Epson Scan 2)

Epson Scan 2 is a scanner driver that allows you to control the scanner. You can adjust the size, resolution, brightness, contrast, and quality of the scanned image. You can also start this application from a TWAIN-compliant scanning application. See the software help for details on using the features.

Starting on Windows

Note:

*For Windows Server operating systems, make sure the **Desktop Experience** feature is installed.*

- ❑ Windows 11

Click the start button, and then select **All apps > EPSON > Epson Scan 2**.

- ❑ Windows 10/Windows Server 2022/Windows Server 2019/Windows Server 2016
Click the start button, and then select **EPSON > Epson Scan 2**.
- ❑ Windows 8.1/Windows 8/Windows Server 2012 R2/Windows Server 2012
Enter the application name in the search charm, and then select the displayed icon.
- ❑ Windows 7/Windows Vista/Windows XP/Windows Server 2008 R2/Windows Server 2008/Windows Server 2003 R2/Windows Server 2003
Click the start button, and then select **All Programs** or **Programs > EPSON > Epson Scan 2**.

Starting on Mac OS

Select **Go > Applications > Epson Software > Epson Scan 2**.

Application for Configuring Fax Operations and Sending Faxes (FAX Utility)

FAX Utility is an application that allows you to configure various settings for sending faxes from a computer. You can create or edit the contacts list to be used when sending a fax, configure to save received faxes in PDF format on the computer, and so on. See the application's help for details.

Note:

- ❑ *Windows Server operating systems are not supported.*
- ❑ *Make sure you have installed the printer driver before installing FAX Utility.*
- ❑ *Make sure the FAX Utility has been installed. See "Starting on Windows" or "Starting on Mac OS" below to check if the application has been installed.*

Starting on Windows

- ❑ Windows 11
Click the start button, and select **All Apps > Epson Software > FAX Utility**.
- ❑ Windows 10
Click the start button, and select **Epson Software > FAX Utility**.
- ❑ Windows 8.1/Windows 8
Enter the application name in the search charm, and then select the displayed icon.
- ❑ Windows 7/Windows Vista/Windows XP
Click the start button, and select **All Programs** (or **Programs**) > **Epson Software > FAX Utility**.

Starting on Mac OS

Select **System Preferences** from the Apple menu > **Printers & Scanners** (or **Print & Scan, Print & Fax**), and then select the printer (FAX). Click **Options & Supplies > Utility > Open Printer Utility**.

Related Information

- ➔ ["Sending a Fax from a Computer" on page 95](#)
- ➔ ["Receiving Faxes on a Computer" on page 100](#)

Application for Sending Faxes (PC-FAX Driver)

PC-FAX driver is an application that allows you to send a document created on a separate application as a fax directly from the computer. PC-FAX driver is installed when you install FAX Utility. See the application's help for details.

Note:

- ❑ *Windows Server operating systems are not supported.*
- ❑ *Check if PC-FAX driver has been installed. See "Accessing from Windows" or "Accessing from Mac OS" below.*
- ❑ *The operation differs depending on the application you used to create the document. See the application's help for details.*

Accessing from Windows

In the application, select **Print** or **Print Setup** from the **File** menu. Select your printer (FAX), and then click **Preferences** or **Properties**.

Accessing from Mac OS

In the application, select **Print** from the **File** menu. Select your printer (FAX) as the **Printer** setting, and then select **Fax Settings** or **Recipient Settings** from the pop-up menu.

Related Information

- ➔ ["Sending a Fax from a Computer" on page 95](#)
- ➔ ["Application for Configuring Fax Operations and Sending Faxes \(FAX Utility\)" on page 209](#)

Application for Configuring Printer Operations (Web Config)

Web Config is an application that runs in a web browser, such as Microsoft Edge and Safari, on a computer or smart device. You can confirm the printer status or change the network service and printer settings. To use the Web Config, connect the printer and the computer or device to the same network.

The following browsers are supported. Use the latest version.

Microsoft Edge, Internet Explorer, Firefox, Chrome, Safari

Note:

You may be asked to enter the administrator password while operating Web Config. See the related information below for more details.

Related Information

- ➔ ["Default Value of the Administrator Password" on page 16](#)

Running Web Config on a Web Browser

1. Check the printer's IP address.

Select **Settings** > **Network Settings** > **Connection Check** from the control panel to start the connection check.

Press the  button or the OK button to print the network connection report. Check the printer's IP address on the printed network connection report.

2. Launch a Web browser from a computer or smart device, and then enter the printer's IP address.

Format:

IPv4: http://the printer's IP address/

IPv6: http://[the printer's IP address]/

Examples:

IPv4: http://192.168.100.201/

IPv6: http://[2001:db8::1000:1]/

Note:

Using the smart device, you can also run Web Config from the product information screen of the Epson Smart Panel.

Since the printer uses a self-signed certificate when accessing HTTPS, a warning is displayed on the browser when you start Web Config; this does not indicate a problem and can be safely ignored.

Application for Updating Software and Firmware (Epson Software Updater)

Epson Software Updater is an application that installs new software, and updates firmware over the Internet. If you want to check for update information regularly, you can set the interval for checking for updates in Epson Software Updater's Auto Update Settings.

Note:

Windows Server operating systems are not supported.

Starting on Windows

- Windows 11

Click the start button, and then select **All apps > EPSON Software > Epson Software Updater**.

- Windows 10

Click the start button, and then select **EPSON Software > Epson Software Updater**.

- Windows 8.1/Windows 8

Enter the application name in the search charm, and then select the displayed icon.

- Windows 7/Windows Vista/Windows XP

Click the start button, and then select **All Programs (or Programs) > EPSON Software > Epson Software Updater**.

Note:

You can also start Epson Software Updater by clicking the printer icon on the task bar on the desktop, and then selecting Software Update.

Starting on Mac OS

Select **Go > Applications > Epson Software > Epson Software Updater**.

Related Information

➔ [“Installing the Applications Separately” on page 115](#)

Settings Menu List

Select **Settings** on the home screen of the printer to make various settings.

Maintenance

Select the menus on the control panel as described below.

Settings > Maintenance

Nozzle Check:

Select this feature to check if the print head nozzles are clogged. The printer prints a nozzle check pattern.

Head Cleaning:

Select this feature to clean clogged nozzles in the print head.

Power Cleaning:

Select this feature to perform power cleaning if the print head is severely clogged or is still clogged after repeating standard cleaning. More ink is consumed than in usual cleaning.

Print Head Alignment:

Vertical Alignment:

Select this feature if your printouts look blurry or text and lines are misaligned.



Horizontal Alignment:

Select this feature if horizontal banding appears at regular intervals in your printouts.

Fill Ink:

Select this feature to reset the ink level to 100% when filling the ink tank.

Maintenance Box Service Life:

Displays the approximate service life of the maintenance box. When  is displayed, the maintenance box is nearly full. When  is displayed, the maintenance box is full.

Paper Guide Cleaning:

Select this feature if there are ink stains on the internal rollers. The printer feeds paper to clean the internal rollers.

Related Information

- ➔ [“Checking and Cleaning the Print Head” on page 104](#)
- ➔ [“Running Power Cleaning” on page 106](#)
- ➔ [“Refilling the Ink Tanks” on page 187](#)
- ➔ [“Cleaning the Paper Path for Ink Smears” on page 108](#)

Printer Setup

Select the menus on the control panel as described below.

Settings > Printer Setup

Paper Source Settings:

Paper Setting:

Select the paper size and paper type you loaded in the paper source.

A4/Letter Auto Switching:

Select **On** to feed paper from the paper source set as A4 size when there is no paper source set as Letter, or feed from the paper source set as Letter size when there is no paper source set as A4.

Error Notice:

Select **On** to display an error message when the selected paper size or type does not match the loaded paper.

Paper Setup Auto Display:

Select **On** to display the **Paper Setting** screen when loading paper in the paper source. If you disable this feature, you cannot print from an iPhone, iPad, or iPod touch using AirPrint.

Sound:

Mute:

Select **On** to mute sounds such as those emitted by **Button Press**.

Normal Mode:

Select the volume such as **Button Press**.

Quiet Mode:

Select the volume such as **Button Press** in **Quiet Mode**.

Quiet Mode:

Select **On** to reduce noise during printing, however, this may lower the print speed. Depending on the paper type and print quality settings you selected, there may be no difference in the printer's noise level. Select **On** to prioritize reducing operation noise. To prioritize printing speed, select **On (Low Level)**.

Power Off Timer:

Your product may have this feature or the **Power Off Settings** feature depending on the location of purchase.

Select this setting to turn the printer off automatically when it is not used for a specified period of time. You can adjust the time before power management is applied. Any increase will affect the product's energy efficiency. Please consider the environment before making any change.

Power Off Settings:

Your product may have this feature or the **Power Off Timer** feature depending on the location of purchase.

Power Off If Inactive:

Select this setting to turn the printer off automatically if it is not used for a specified period of time. Any increase will affect the product's energy efficiency. Please consider the environment before making any change.

Power Off If Disconnected:

Select this setting to turn the printer off after a specified period of time when all ports including the LINE port are disconnected. This feature may not be available depending on your region.

See the following website for the specified period of time.

<https://www.epson.eu/energy-consumption>

Date/Time Settings:

Date/Time:

Enter the current date and time.

Daylight Saving Time:

Select the summer time setting that applies to your area.

Time Difference:

Enter the time difference between your local time and UTC (Coordinated Universal Time).

Country/Region:

Select the country or region in which you are using your printer. If you change the country or region, your fax settings return to their defaults and you must select them again.

Language:

Select the language used on the LCD screen.

Keyboard:

Change the layout of the keyboard on the LCD screen.

Sleep Timer:

Adjust the time period to enter a sleep mode (energy saving mode) when the printer has not performed any operations. The LCD screen turns black when the setting time passes.

PC Connection via USB:

Select **Enable** to allow a computer to access the printer when connected by USB. When **Disable** is selected, printing and scanning that is not sent over a network connection is restricted.

Related Information

➔ [“Saving Power” on page 114](#)

Network Settings

Select the menus on the control panel as described below.

Settings > Network Settings

Print Status Sheet:

Prints a network status sheet.

The information for Ethernet, Wi-Fi, Wi-Fi Direct, and so on is printed on two or more pages.

Wi-Fi Setup:

Set up or change wireless network settings. Choose the connection method from following and then follow the instructions on the control panel.

Connect via Wi-Fi:

Set up or change wireless network settings. Choose the connection method from following and then follow the instructions on the control panel.

Wi-Fi Setup Wizard:

Makes Wi-Fi settings by entering the SSID and password.

Push Button (WPS):

Makes Wi-Fi settings by Push Button (WPS).

Others:

PIN Code (WPS):

Makes Wi-Fi settings by PIN Code (WPS).

Wi-Fi Auto Connect:

Makes Wi-Fi settings by using the Wi-Fi information on the computer or smart device.

Disable Wi-Fi:

Disables Wi-Fi. Infrastructure connections will be disconnected.

Wi-Fi Direct:

Other Methods:

iOS:

Reads the QR code from your iPhone, iPad, or iPod touch to connect using Wi-Fi Direct.

Other OS Devices:

Makes Wi-Fi Direct settings by entering the SSID and password.

Modify:

Change Network Name:

Changes the Wi-Fi Direct SSID (network name).

Change Password:

Changes the password for the Wi-Fi Direct connection.

Disable Wi-Fi Direct:

Disables the Wi-Fi Direct function.

Restore Default Settings:

Restores the Wi-Fi Direct settings.

Connection Check:

Checks the current network connection and prints a report. If there are any problems with the connection, see the report to solve the problem.

Epson Connect Services:

Select the menus on the control panel as described below.

Settings > Epson Connect Services

Register/Delete:

Register or delete the printer to or from the Epson Connect services.

For usage guides, see the following portal website.

<https://www.epsonconnect.com/>

<http://www.epsonconnect.eu> (Europe only)

Suspend/Resume:

Select whether to suspend or resume Epson Connect services.

Email Address:

Check the printer's email address that is registered to the Epson Connect services.

Status:

Check whether or not the printer is registered and connected to the Epson Connect services.

Contacts Manager

Select the menus on the control panel as described below.

Settings > Contacts Manager

Add Entry:

Register the entry to be used for faxes in contacts.

Add Group:

Register the entry for group faxes in contacts.

Edit:

Edit the entries and groups registered in contacts.

Delete:

Delete the entry or group registered in contacts.

Print Contacts:

Print the entry information and group information for the contacts in the list.

Related Information

➔ [“Making Contacts Available” on page 81](#)

Fax Settings

Selecting **Settings** > **Fax Settings** from the printer's control panel displays this menu.

Check Fax Connection

You can find the menu on the printer's control panel below:

Settings > **Fax Settings** > **Check Fax Connection**

Selecting **Check Fax Connection** checks that the printer is connected to the phone line and ready for fax transmission. You can print the check result on A4 size plain paper.

Fax Setting Wizard

You can find the menu on the printer's control panel below:

Settings > **Fax Settings** > **Fax Setting Wizard**

Selecting **Fax Setting Wizard** makes basic fax settings. Follow the on-screen instructions.

Related Information

➔ [“Basic Settings Menu” on page 217](#)

➔ [“Making the Printer Ready to Send and Receive Faxes” on page 76](#)

Basic Settings Menu

You can find the menu on the printer's control panel below:

Settings > **Fax Settings** > **Basic Settings**

Fax Speed:

Select the fax transmission speed. We recommend selecting **Slow(9,600bps)** when a communication error occurs frequently, when sending/receiving a fax to/from abroad, or when you are using an IP (VoIP) phone service.

ECM:

Automatically corrects errors in the fax transmission (Error Correction Mode), mostly caused by telephone line noise. If this is disabled, you cannot send or receive documents in color.

Dial Tone Detection:

Detects a dial tone before starting to dial. If the printer is connected to a PBX (Private Branch Exchange) or digital phone line, the printer may fail to start dialing. In this situation, change the **Line Type** setting to **PBX**. If this does not work, disable this feature. However, disabling this feature may drop the first digit of a fax number and send the fax to the wrong number.

Dial Mode:

Select the type of phone system to which you have connected the printer. When set to **Pulse**, you can temporarily switch the dialing mode from pulse to tone by pressing * ("T" is entered) while entering numbers on the fax top screen. This setting may not be displayed depending on your region or country.

Line Type:

Select the line type to which you have connected the printer.

PSTN:

Select **PSTN** when the printer is connected to a public switched telephone network.

PBX:

Select **PBX** when using the printer in an environment that uses extensions and requires an external access code, such as 0 and 9, to get an outside line. For an environment that uses a DSL modem or terminal adapter, setting to **PBX** is also recommended.

Access Code:

Select **Use**, and then register an external access code such as 0 or 9. Then, when sending a fax to an outside fax number, enter # (hash) instead of the real code. # (hash) must also be used in **Contacts** as an external access code. If an external access code such as 0 or 9 is set in a contact, you cannot send faxes to the contact. In this case, set **Access Code** to **Do Not Use**, otherwise you must change the code in **Contacts** to #.

Header:

Enter your sender name and fax number. These appear as a header on outgoing faxes.

Your Phone Number:

You can enter up to 20 characters using 0-9 + or space.

Fax Header:

You can register up to 21 sender names as necessary. You can enter up to 40 characters for each sender name. For Web Config, enter the header in Unicode (UTF-8).

Receive Mode:

Select the receive mode.

[“Receiving Incoming Faxes” on page 90](#)

DRD:

If you have subscribed to a distinctive ring service from your telephone company, select the ring pattern to be used for incoming faxes. The distinctive ring service, offered by many telephone companies (the service name differs by company), allows you to have several phone numbers on one phone line. Each number is assigned different ring pattern. You can use one number for voice calls and another for fax calls. Depending on the region, this option may be **On** or **Off**.

Rings to Answer:

Select the number of rings that must occur before the printer automatically receives a fax.

Remote Receive:

When you answer an incoming fax call on a phone connected to the printer, you can start receiving the fax by entering the code using the phone.

Enter Start Code:

Set the start code of **Remote Receive**. Enter two characters using 0-9, *, #.

Rejection Fax:

Rejection Fax:

Select options to reject receiving junk faxes.

Rejection Number List:

If the other party's phone number is in the rejection number list, set whether to reject the incoming faxes.

Fax Header Blank:

If the other party's phone number is blocked, set whether to reject receiving the faxes.

Caller not in Contacts:

If the other party's phone number is not in the contacts, set whether to reject receiving the faxes.

Edit Blocked Number list:

You can register up to 30 fax numbers to reject the faxes and calls. Enter up to 20 characters using 0-9, *, #, or space.

Related Information

- ➔ [“Making the Printer Ready to Send and Receive Faxes” on page 76](#)
- ➔ [“Making Settings for a PBX Phone System” on page 78](#)
- ➔ [“Receiving Incoming Faxes” on page 90](#)
- ➔ [“Making Settings for Blocking Junk Faxes” on page 80](#)

Receive Settings Menu

You can find the menu on the printer's control panel below:

Settings > Fax Settings > Receive Settings

Save to Computer:

Saves received faxes as PDF files on a computer connected to the printer. You can only set this to **Yes** by using the FAX Utility (application). You cannot enable this from printer's control panel. Install the FAX Utility on the computer in advance. After setting this to **Yes**, you can change this to **Yes and Print** from the printer's control panel.

Auto Reduction:

Prints received faxes with large-size documents reduced to fit on the paper in the paper source. Reducing may not always be possible depending on the received data. If this is turned off, large documents are printed at their original size on multiple sheets, or a blank second page may be ejected.

Split Page Settings:

Prints received faxes with the page split when the size of the received documents is larger than the size of the paper loaded in the printer. If the amount that exceeds the paper length is less than the value set in **Delete Print Data After Split > Threshold**, the excess is discarded. If the amount that exceeds the paper length is over the set value, the excess is printed on another paper.

Delete Print Data After Split:

Select the area of the document to delete when the amount that exceeds the paper length is less than the value set in **Threshold**.

Threshold:

If the amount that exceeds the paper length is less than or equal to this value, the excess is discarded and is not printed.

Overlap When Split:

When this is set to **On** and the data is divided and printed because the amount exceeds the **Delete Print Data After Split > Threshold**, the divided data is printed using the overlapping length specified in **Overlapping Width**.

Overlapping Width:

Data that exceeds this value is printed over.

Auto Rotation:

Rotates faxes received as landscape-oriented A5 size documents so that they are printed on A5 size paper. This setting is applied when the paper size setting for at least one paper source used for printing faxes is set to A5.

By selecting **Off**, faxes received as landscape-oriented A5 size, which are the same width as A4 portrait documents, are assumed to be A4 size faxes and printed as such.

Check the paper size setting in **Settings > Printer Setup > Paper Source Settings**.

Add Reception Information:

Prints reception information on the received fax, even if the sender does not set the header information. The reception information includes the received date and time, sender's ID, and page number (such as "P1"). When **Split Page Settings** is enabled, the split page number is also included.

Print Start Timing:

Select options to start printing the faxes to receive.

- All Pages Received:** Printing starts after receiving all of the pages. To start printing from the first page or last page depends on the setting of **Collation Stack** feature. See the explanation for **Collation Stack**.
- First Page Received:** Starts printing when the first page is received, and then prints in order as the pages are received. If the printer cannot start printing, such as when it is printing other jobs, the printer starts printing received pages as a batch when it is available.

Collation Stack:

Since the first page is printed last (output to the top), the printed documents are stacked in the correct page order. When the printer is running low on memory, this feature may not be available.

Print Suspend Time:

During the time period you specified from **Stop** through **Restart** you specified, the printer saves documents received in the printer's memory without printing them. This feature can be used for noise prevention at night or to prevent confidential documents from being disclosed while you are away. Before using this feature, make sure there is enough free memory. When you set this to **Off**, you can print the received documents even before the restart time.

Quiet Mode:

Reduces the noise the printer makes when printing faxes, however, print speed may be reduced.

Report Settings Menu

You can find the menu on the printer's control panel below:

Settings > Fax Settings > Report Settings

Fax Log Auto Print:

Prints the fax log automatically. Select **On(Every 30)** to print a log every time 30 fax jobs are completed. Select **On(Time)** to print the log at a specified time. However, if the number of fax jobs exceeds 30, the log is printed before the specified time.

Attach Fax image to report:

Prints a **Transmission Report** with an image of the first page of the sent document. Select **On(Large Image)** to print the upper part of the page without reducing. Select **On(Small Image)** to print the entire page reducing it to fit onto the report.

Report Format:

Selects a format for fax reports in **Fax > Menu > More > Fax Report** other than **Protocol Trace**. Select **Detail** to print with error codes.

Security Settings Menu

You can find the menu on the printer's control panel below:

Settings > Fax Settings > Security Settings

Direct Dialing Restrictions:

Selecting **On** disables manual entry of the recipient's fax numbers allowing the operator to select recipients only from the contacts list or sent history.

Selecting **Enter Twice** requires the operator to enter the fax number again when the number was manually entered.

Selecting **Off** enables manual entry of the recipient's fax numbers.

Broadcasting Restrictions:

Selecting **On** allows only one fax number to be entered as the Recipient.

Confirm Address List:

Displays a recipient confirmation screen before starting the transmission.

You can select the recipients from **All** or **Only for Broadcasting**.

Backup Data Auto Clear:

Backup copies of sent and received documents are usually temporarily stored in the printer's memory to prepare for an unexpected power failure due to an electricity failure or incorrect operations.

Selecting **On** automatically erases the backups when sending or receiving a document completes successfully and the backups become unnecessary.

Clear Backup Data:

Erases all backup copies temporarily stored in the printer's memory. Run this before you give the printer to someone else or dispose of it.

User Default Settings Menu

You can find the menu on the printer's control panel below:

Settings > Fax Settings > User Default Settings

The settings made in this menu become your default settings for in the **Fax > Menu**. For details, see the related information below.

Related Information

➔ [“Scan Settings” on page 92](#)

➔ [“Fax Send Settings” on page 93](#)

Print Status Sheet

Select the menus on the control panel as described below.

Settings > Print Status Sheet

Configuration Status Sheet:

Print information sheets showing the current printer status and settings.

Supply Status Sheet:

Print information sheets showing the status of consumables.

Usage History Sheet:

Print information sheets showing the usage history of the printer.

Print Counter

Select the menus on the control panel as described below.

Settings > Print Counter

Displays the total number of prints, B&W prints, and color prints including items such as the status sheet from the time you purchased the printer.

Select **Print Sheet** when you want to print the result. The printed sheet also includes the number of scanned pages. The information included in the sheet is the same when you print from other functions on the **Usage History Sheet**.

Customer Research

Select the menus on the control panel as described below.

Settings > Customer Research

Provides product usage information, such as the number of prints, to Seiko Epson Corporation. Select **Settings - Approve**, and then follow the on-screen instructions.

Restore Default Settings

Select the menus on the control panel as described below.

Settings > Restore Default Settings

Network Settings:

Resets the network settings to the default.

Copy Settings:

Resets the copy settings to the default.

Scan Settings:

Resets the scan settings to the default.

Fax Settings:

Resets the fax settings to the default.

Clear All Data and Settings:

Clears all the personal information stored in the printer's memory and resets all settings to the default.

Firmware Update

Select the menus on the control panel as described below.

Settings > Firmware Update

Update:

Check if the latest version of the firmware has been uploaded to the network server. If an update is available, you can select whether or not to start updating.

Current Version:

Displays the current firmware version of your printer.

Notification:

Select **On** to receive a notification if a firmware update is available.

Product Specifications

Printer Specifications

| | | |
|-----------------------------|-------------|---|
| Print Head Nozzle Placement | | Black ink nozzles: 400 Color ink nozzles: 128 for each color |
| Weight of Paper* | Plain Paper | 64 to 90 g/m ² |
| | Envelopes | 75 to 100 g/m ² |

* Even when the paper thickness is within this range, the paper may not feed in the printer or the print quality may decline depending on the paper properties or quality.

Printable Area

Printable Area for Single Sheets

Print quality may decline in the shaded areas due to the printer's mechanism.

Printing with borders

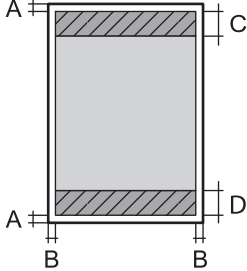
| | | |
|---|---|--------------------|
|  | A | 3.0 mm (0.12 in.) |
| | B | 3.0 mm (0.12 in.) |
| | C | 41.0 mm (1.61 in.) |
| | D | 37.0 mm (1.46 in.) |

Borderless printing

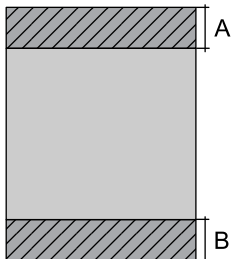
| | | |
|---|---|--------------------|
|  | A | 44.0 mm (1.73 in.) |
| | B | 40.0 mm (1.57 in.) |

Printable Area for Envelopes

Print quality may decline in the shaded areas due to the printer's mechanism.

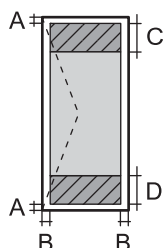
| | | |
|---|---|--------------------|
|  | A | 3.0 mm (0.12 in.) |
| | B | 3.0 mm (0.12 in.) |
| | C | 18.0 mm (0.71 in.) |
| | D | 41.0 mm (1.61 in.) |

Scanner Specifications

| | |
|-----------------------|---|
| Scanner Type | Flatbed |
| Photoelectric Device | CIS |
| Effective Pixels | 10200×14040 pixels (1200 dpi) |
| Maximum Document Size | 216×297 mm (8.5×11.7 in.) A4, Letter |
| Scanning Resolution | 1200 dpi (main scan) 2400 dpi (sub scan) |
| Output Resolution | 50 to 9600 dpi in 1 dpi increments |

| | |
|--------------|--|
| Color Depth | <p>Color</p> <ul style="list-style-type: none"> <input type="checkbox"/> 48 bits per pixel internal (16 bits per pixel per color internal) <input type="checkbox"/> 24 bits per pixel external (8 bits per pixel per color external) <p>Grayscale</p> <ul style="list-style-type: none"> <input type="checkbox"/> 16 bits per pixel internal <input type="checkbox"/> 8 bits per pixel external <p>Black and white</p> <ul style="list-style-type: none"> <input type="checkbox"/> 16 bits per pixel internal <input type="checkbox"/> 1 bits per pixel external |
| Light Source | LED |

ADF Specifications

ET-4810 Series/L5590 Series Only

| | |
|-----------------------|---|
| Available Paper Sizes | A4, Letter, 8.5×13 in., Legal, Indian-Legal |
| Paper Type | Plain Paper |
| Weight of Paper | 64 to 95 g/m ² |
| Loading Capacity | A4, Letter: 30 sheets or 3.3 mm 8.5×13 in., Legal, Indian-Legal: 10 sheets |
| Auto duplex scanning | Not supported |

Even when the original meets the specifications for media that can be placed in the ADF, it may not feed from the ADF or the scan quality may decline depending on the paper properties or quality.

Fax Specifications

| | | |
|--------------------|--|---|
| Fax Type | Walk-up black and white and color fax capability (ITU-T Super Group 3) | |
| Supported Lines | Standard analogue telephone lines, PBX (Private Branch Exchange) telephone systems | |
| Resolution | Monochrome | <ul style="list-style-type: none"> <input type="checkbox"/> Standard: 8 pel/mm×3.85 line/mm (203 pel/in.×98 line/in.) <input type="checkbox"/> Fine: 8 pel/mm×7.7 line/mm (203 pel/in.×196 line/in.) <input type="checkbox"/> Photo: 8 pel/mm×7.7 line/mm (203 pel/in.×196 line/in.) |
| | Color | 200×200 dpi |
| Speed | Up to 33.6 kbps | |
| Compression Method | Monochrome | MH/MR/MMR |
| | Color | JPEG |

| | | |
|----------------------------------|----------------------------|--|
| Communication Standards | | G3, SuperG3 |
| Sending Paper Size | Scanner Glass | Letter, A4 |
| | ADF | A4, Letter, 8.5×13 in., Legal, Indian-Legal |
| Recording Paper Size | | Letter, A4, Legal |
| Transmission Speed* ¹ | | Approx. 3 sec. (A4 ITU-T chart No.1 Standard MMR 33.6 kbps) |
| Page Memory* ² | | Up to 100 pages (when an ITU-T No.1 chart is received in monochrome standard mode) |
| Contacts | Number of Contacts | Up to 100 |
| | Number of Grouped Contacts | Up to 99 |
| Redial* ³ | | 2 times (with 1 minute intervals) |
| Interface | | RJ-11 Phone Line, RJ-11 Telephone set connection |

*1 The actual speed depends on the document, recipient's device, and the status of the phone line.

*2 Retained even during a power outage.

*3 The specifications may differ by country or region.

Interface Specifications

| | |
|--------------|---------------|
| For Computer | Hi-Speed USB* |
|--------------|---------------|

* USB 3.0 cables are not supported.

Network Specifications

Wi-Fi Specifications

| | |
|-----------------------------------|--|
| Standards | IEEE802.11b/g/n* ¹ |
| Frequency Range | 2.4 GHz |
| Coordination Modes | Infrastructure, Wi-Fi Direct (Simple AP)* ^{2*3} |
| Wireless Securities* ⁴ | WEP (64/128bit), WPA2-PSK (AES)* ⁵ , WPA3-SAE (AES) |

*1 IEEE802.11n is only available for the HT20.

*2 Not supported for IEEE 802.11b.

*3 Simple AP mode is compatible with a Wi-Fi connection (infrastructure) or an Ethernet connection.

*4 Wi-Fi Direct supports WPA2-PSK (AES) only.

*5 Complies with WPA2 standards with support for WPA/WPA2 Personal.

Ethernet Specifications

| | |
|--------------------|---|
| Standards | IEEE802.3i (10BASE-T)* ¹ IEEE802.3u (100BASE-TX) IEEE802.3az (Energy Efficient Ethernet)* ² |
| Communication Mode | Auto, 10Mbps Full duplex, 10Mbps Half duplex, 100Mbps Full duplex, 100Mbps Half duplex |
| Connector | RJ-45 |

*1 Use a category 5e or higher STP (Shielded twisted pair) cable to prevent risk of radio interference.

*2 The connected device should comply with IEEE802.3az standards.

Network Functions and IPv4/IPv6

| Functions | | | Supported | Remarks |
|------------------|---|------------|-----------|--|
| Network Printing | EpsonNet Print (Windows) | IPv4 | ✓ | - |
| | Standard TCP/IP (Windows) | IPv4, IPv6 | ✓ | - |
| | WSD Printing (Windows) | IPv4, IPv6 | ✓ | Windows Vista or later |
| | Bonjour Printing (Mac OS) | IPv4, IPv6 | ✓ | - |
| | IPP Printing (Windows, Mac OS) | IPv4, IPv6 | ✓ | - |
| | PictBridge Printing (Wi-Fi) | IPv4 | - | Digital camera |
| | Epson Connect (Email Print, Remote Print) | IPv4 | ✓ | - |
| | AirPrint (iOS, Mac OS) | IPv4, IPv6 | ✓ | iOS 5 or later, OS X Mavericks (10.9.5) or later* |
| Network Scanning | Epson Scan 2 | IPv4, IPv6 | ✓ | - |
| | Epson ScanSmart | IPv4 | ✓ | Windows 7 or later, or OS X El Capitan (10.11) or later |
| | Event Manager | IPv4 | ✓ | Windows Vista/Windows XP, or OS X Yosemite (10.10)/OS X Mavericks (10.9.5) |
| | Epson Connect (Scan to Cloud) | IPv4 | - | - |
| | AirPrint (Scan) | IPv4, IPv6 | ✓ | OS X Mavericks (10.9.5) or later* |

| Functions | | | Supported | Remarks |
|-----------|-------------------|------------|-----------|-----------------------------------|
| Fax | Send a fax | IPv4 | ✓ | - |
| | Receive a fax | IPv4 | ✓ | - |
| | AirPrint (Faxout) | IPv4, IPv6 | ✓ | OS X Mavericks (10.9.5) or later* |

* We recommend using the latest version of iOS or Mac OS.

Security Protocol

| | |
|---------|---------------------------|
| SSL/TLS | HTTPS Server/Client, IPPS |
| SNMPv3 | |

Supported Third Party Services

| Services | | Supported | Remarks |
|----------|-------|-----------|--|
| AirPrint | Print | ✓ | iOS 5 or later/OS X Mavericks (10.9.5) or later* |
| | Scan | ✓ | OS X Mavericks (10.9.5) or later* |
| | Fax | ✓ | OS X Mavericks (10.9.5) or later* |

* We recommend using the latest version of iOS or Mac OS.

Dimensions

ET-4810 Series/L5590 Series

| | |
|------------|---|
| Dimensions | <p>Storage</p> <ul style="list-style-type: none"> <input type="checkbox"/> Width: 375 mm (14.8 in.) <input type="checkbox"/> Depth: 347 mm (13.7 in.) <input type="checkbox"/> Height: 237 mm (9.3 in.) <p>Printing</p> <ul style="list-style-type: none"> <input type="checkbox"/> Width: 375 mm (14.8 in.) <input type="checkbox"/> Depth: 578 mm (22.8 in.) <input type="checkbox"/> Height: 253 mm (10.0 in.) |
| Weight* | Approx. 5.2 kg (11.5 lb) |

* Without the ink and the power cord.

ET-2840 Series/L3560 Series

| | |
|------------|---|
| Dimensions | <p>Storage</p> <ul style="list-style-type: none"> <input type="checkbox"/> Width: 375 mm (14.8 in.) <input type="checkbox"/> Depth: 347 mm (13.7 in.) <input type="checkbox"/> Height: 179 mm (7.0 in.) <p>Printing</p> <ul style="list-style-type: none"> <input type="checkbox"/> Width: 375 mm (14.8 in.) <input type="checkbox"/> Depth: 578 mm (22.8 in.) <input type="checkbox"/> Height: 253 mm (10.0 in.) |
| Weight* | Approx. 4.3 kg (9.5 lb) |

* Without the ink and the power cord.

Electrical Specifications

ET-4810 Series/L5590 Series

| | | |
|---|--|--|
| Power Supply Rating | AC 100-240 V | AC 220-240 V |
| Rated Frequency Range | 50-60 Hz | 50-60 Hz |
| Rated Current | 0.4-0.2 A | 0.2 A |
| Power Consumption (with USB Connection) | <p>Standalone copying: Approx. 12.0 W (ISO/IEC24712)</p> <p>Ready mode: Approx. 7.1 W</p> <p>Sleep mode: Approx. 0.9 W</p> <p>Power off: Approx. 0.2 W</p> | <p>Standalone copying: Approx. 12.0 W (ISO/IEC24712)</p> <p>Ready mode: Approx. 7.1 W</p> <p>Sleep mode: Approx. 0.9 W</p> <p>Power off: Approx. 0.2 W</p> |

Note:

- Check the label on the printer for its voltage.
- For European users, see the following Website for details on power consumption.
<http://www.epson.eu/energy-consumption>

ET-2840 Series/L3560 Series

| | | |
|-----------------------|--------------|--------------|
| Power Supply Rating | AC 100-240 V | AC 220-240 V |
| Rated Frequency Range | 50-60 Hz | 50-60 Hz |
| Rated Current | 0.4-0.2 A | 0.2 A |

| | | |
|---|---|---|
| Power Consumption (with USB Connection) | Standalone copying: Approx. 12.0 W (ISO/IEC24712) Ready mode: Approx. 7.1 W Sleep mode: Approx. 0.8 W Power off: Approx. 0.2 W | Standalone copying: Approx. 12.0 W (ISO/IEC24712) Ready mode: Approx. 7.1 W Sleep mode: Approx. 0.8 W Power off: Approx. 0.2 W |
|---|---|---|

Note:

- Check the label on the printer for its voltage.
- For European users, see the following Website for details on power consumption.
<http://www.epson.eu/energy-consumption>

Environmental Specifications

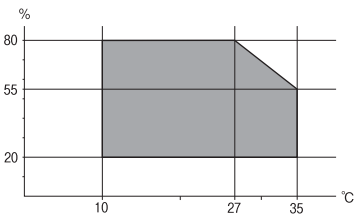
| | |
|-----------|--|
| Operation | Use the printer within the range shown in the following graph.  <p>Temperature: 10 to 35°C (50 to 95°F) Humidity: 20 to 80% RH (without condensation)</p> |
| Storage | Temperature after initial ink charging: -15 to 40°C (-5 to 104°F)* Temperature before initial ink charging: -20 to 40°C (-4 to 104°F)* Humidity: 5 to 85% RH (without condensation) |

* You can store for one month at 40°C (104°F).

Environmental Specifications for Ink Bottles

| | |
|----------------------|--|
| Storage Temperature | -20 to 40 °C (-4 to 104 °F)* |
| Freezing Temperature | -15 °C (5 °F) Ink thaws and is usable after approximately 2 hours at 25 °C (77 °F). |

* You can store for one month at 40 °C (104 °F).

System Requirements

Windows

Windows Vista, Windows 7, Windows 8/8.1, Windows 10, Windows 11 or later

Windows XP SP3 (32-bit)

Windows XP Professional x64 Edition SP2

Windows Server 2003 (SP2) or later

Mac OS

Mac OS X 10.9.5 or later, macOS 11 or later

Note:

Mac OS may not support some applications and features.

The UNIX File System (UFS) for Mac OS is not supported.

Regulatory Information

Standards and Approvals

Standards and Approvals for U.S. Model

| | |
|--------|---|
| Safety | UL60950-1 CAN/CSA-C22.2 No.60950-1 |
| EMC | FCC Part 15 Subpart B Class B CAN ICES-3 (B)/NMB-3 (B) |

This equipment contains the following wireless module.

Manufacturer: Seiko Epson Corporation

Type: J26H006

This product conforms to Part 15 of the FCC Rules and RSS-210 of the IC Rules. Epson cannot accept responsibility for any failure to satisfy the protection requirements resulting from a non-recommended modification of the product. Operation is subject to the following two conditions: (1) this device may not cause harmful interference, and (2) this device must accept any interference received, including interference that may cause undesired operation of the device.

To prevent radio interference to the licensed service, this device is intended to be operated indoors and away from windows to provide maximum shielding. Equipment (or its transmit antenna) that is installed outdoors is subject to licensing.

This equipment complies with FCC/IC radiation exposure limits set forth for an uncontrolled environment and meets the FCC radio frequency (RF) Exposure Guidelines in Supplement C to OET65 and RSS-102 of the IC radio frequency (RF) Exposure rules. This equipment should be installed and operated so that the radiator is kept at least 7.9 inches (20 cm) or more away from a person's body (excluding extremities: hands, wrists, feet and ankles).

Standards and Approvals for European Model

For European users

Hereby, Seiko Epson Corporation declares that the following radio equipment model is in compliance with Directive 2014/53/EU. The full text of the EU declaration of conformity is available at the following website.

<http://www.epson.eu/conformity>

C622C,C634K

For use only in Ireland, UK, Austria, Germany, Liechtenstein, Switzerland, France, Belgium, Luxemburg, Netherlands, Italy, Portugal, Spain, Denmark, Finland, Norway, Sweden, Iceland, Croatia, Cyprus, Greece, Slovenia, Malta, Bulgaria, Czechia, Estonia, Hungary, Latvia, Lithuania, Poland, Romania, and Slovakia.

Epson cannot accept responsibility for any failure to satisfy the protection requirements resulting from a non-recommended modification of the products.

| Frequency | Maximum Radio-Frequency Power Transmitted |
|-----------------|---|
| 2400-2483.5 MHz | 20 dBm (EIRP) |



Standards and Approvals for Australian Model

| | |
|-----|------------------------|
| EMC | AS/NZS CISPR32 Class B |
|-----|------------------------|

Epson hereby declares that the following equipment Models are in compliance with the essential requirements and other relevant provisions of AS/NZS4268:

C662C

Epson cannot accept responsibility for any failure to satisfy the protection requirements resulting from a non-recommended modification of the products.

Standards and Approvals for New Zealand Model

General Warning

The grant of a Telepermit for any item of terminal equipment indicates only that Telecom has accepted that the item complies with minimum conditions for connection to its network. It indicates no endorsement of the product by Telecom, nor does it provide any sort of warranty. Above all, it provides no assurance that any item will work correctly in all respects with another item of Telepermitted equipment of a different make or model, nor does it imply that any product is compatible with all of Telecom's network services.

Telepermitted equipment only may be connected to the EXT telephone port. This port is not specifically designed for 3-wire-connected equipment. 3-wire-connected equipment might not respond to incoming ringing when attached to this port.

Important Notice

Under power failure conditions, this telephone may not operate. Please ensure that a separate telephone, not dependent on local power, is available for emergency use.

This equipment is not capable, under all operating conditions, of correct operation at the higher speeds for which it is designed. Telecom will accept no responsibility should difficulties arise in such circumstances.

This equipment shall not be set up to make automatic calls to the Telecom '111' Emergency Service.

ZICTA Type Approval for Users in Zambia

See the following website to check the information for ZICTA Type Approval.

<https://support.epson.net/zicta/>

Restrictions on Copying

Observe the following restrictions to ensure the responsible and legal use of the printer.

Copying of the following items is prohibited by law:

- Bank bills, coins, government-issued marketable securities, government bond securities, and municipal securities
- Unused postage stamps, pre-stamped postcards, and other official postal items bearing valid postage
- Government-issued revenue stamps, and securities issued according to legal procedure

Exercise caution when copying the following items:

- Private marketable securities (stock certificates, negotiable notes, checks, etc.), monthly passes, concession tickets, etc.
- Passports, driver's licenses, warrants of fitness, road passes, food stamps, tickets, etc.

Note:

Copying these items may also be prohibited by law.

Responsible use of copyrighted materials:

Printers can be misused by improperly copying copyrighted materials. Unless acting on the advice of a knowledgeable attorney, be responsible and respectful by obtaining the permission of the copyright holder before copying published material.

Where to Get Help

| | |
|-------------------------------------|-----|
| Technical Support Web Site. | 236 |
| Contacting Epson Support. | 236 |

Technical Support Web Site

If you need further help, visit the Epson support website shown below. Select your country or region and go to the support section of your local Epson website. The latest drivers, FAQs, manuals, or other downloadables are also available from the site.

<http://support.epson.net/>

<http://www.epson.eu/support> (Europe)

If your Epson product is not operating properly and you cannot solve the problem, contact Epson support services for assistance.

Contacting Epson Support

Before Contacting Epson

If your Epson product is not operating properly and you cannot solve the problem using the troubleshooting information in your product manuals, contact Epson support services for assistance.

The following Epson support list is based on the country of sale. Some products may not be sold in your current location, so be sure to contact Epson support for the area in which you purchased your product.

If Epson support for your area is not listed below, contact the dealer where you purchased your product.

Epson support will be able to help you much more quickly if you give them the following information:

- Product serial number

(The label attachment position depends on the product; it may be on the back, the open side of the cover, or the bottom.)

- Product model

- Product software version

(Click **About**, **Version Info**, or a similar button in the product software.)

- Brand and model of your computer

- Your computer operating system name and version

- Names and versions of the software applications you normally use with your product

Note:

Depending on the product, the dial list data for fax and/or network settings may be stored in the product's memory. Due to breakdown or repair of a product, data and/or settings may be lost. Epson shall not be responsible for the loss of any data, for backing up or recovering data and/or settings even during a warranty period. We recommend that you make your own backup data or take notes.

Help for Users in Europe

Check your Pan-European Warranty Document for information on how to contact Epson support.

Help for Users in Taiwan

Contacts for information, support, and services are:

World Wide Web

<http://www.epson.com.tw>

Information on product specifications, drivers for download, and products enquiry are available.

Epson HelpDesk

Phone: +886-2-2165-3138

Our HelpDesk team can help you with the following over the phone:

- Sales enquiries and product information
- Product usage questions or problems
- Enquiries on repair service and warranty

Repair service center:

<http://www.tekcare.com.tw/branchMap.page>

TekCare corporation is an authorized service center for Epson Taiwan Technology & Trading Ltd.

Help for Users in Australia

Epson Australia wishes to provide you with a high level of customer service. In addition to your product manuals, we provide the following sources for obtaining information:

Internet URL

<http://www.epson.com.au>

Access the Epson Australia World Wide Web pages. Worth taking your modem here for the occasional surf! The site provides a download area for drivers, Epson contact points, new product information and technical support (e-mail).

Epson Helpdesk

Phone: 1300-361-054

Epson Helpdesk is provided as a final backup to make sure our clients have access to advice. Operators on the Helpdesk can aid you in installing, configuring and operating your Epson product. Our Pre-sales Helpdesk staff can provide literature on new Epson products and advise where the nearest dealer or service agent is located. Many types of queries are answered here.

We encourage you to have all the relevant information on hand when you ring. The more information you prepare, the faster we can help solve the problem. This information includes your Epson product manuals, type of computer, operating system, application programs, and any information you feel is required.

Transportation of Product

Epson recommends retaining product packaging for future transportation. Securing the ink tank with tape and keeping the product upright is also recommended.

Help for Users in New Zealand

Epson New Zealand wishes to provide you with a high level of customer service. In addition to your product documentation, we provide the following sources for obtaining information:

Internet URL

<http://www.epson.co.nz>

Access the Epson New Zealand World Wide Web pages. Worth taking your modem here for the occasional surf! The site provides a download area for drivers, Epson contact points, new product information and technical support (e-mail).

Epson Helpdesk

Phone: 0800 237 766

Epson Helpdesk is provided as a final backup to make sure our clients have access to advice. Operators on the Helpdesk can aid you in installing, configuring and operating your Epson product. Our Pre-sales Helpdesk staff can provide literature on new Epson products and advise where the nearest dealer or service agent is located. Many types of queries are answered here.

We encourage you to have all the relevant information on hand when you ring. The more information you prepare, the faster we can help solve the problem. This information includes your Epson product documentation, type of computer, operating system, application programs, and any information you feel is required.

Transportation of Product

Epson recommends retaining product packaging for future transportation. Securing the ink tank with tape and keeping the product upright is also recommended.

Help for Users in Singapore

Sources of information, support, and services available from Epson Singapore are:

World Wide Web

<http://www.epson.com.sg>

Information on product specifications, drivers for download, Frequently Asked Questions (FAQ), Sales Enquiries, and Technical Support via e-mail are available.

Epson HelpDesk

Toll Free: 800-120-5564

Our HelpDesk team can help you with the following over the phone:

- Sales enquiries and product information
- Product usage questions or problem troubleshooting
- Enquiries on repair service and warranty

Help for Users in Thailand

Contacts for information, support, and services are:

World Wide Web

<http://www.epson.co.th>

Information on product specifications, drivers for download, Frequently Asked Questions (FAQ), and e-mail are available.

Epson Call Centre

Phone: 66-2460-9699

Email: support@eth.epson.co.th

Our Call Centre team can help you with the following over the phone:

- Sales enquiries and product information
- Product usage questions or problems
- Enquiries on repair service and warranty

Help for Users in Vietnam

Contacts for information, support, and services are:

Epson Service Center

65 Truong Dinh Street, District 1, Ho Chi Minh City, Vietnam.

Phone(Ho Chi Minh City): 84-8-3823-9239, 84-8-3825-6234

29 Tue Tinh, Quan Hai Ba Trung, Hanoi City, Vietnam

Phone(Hanoi City): 84-4-3978-4785, 84-4-3978-4775

Help for Users in Indonesia

Contacts for information, support, and services are:

World Wide Web

<http://www.epson.co.id>

- Information on product specifications, drivers for download
- Frequently Asked Questions (FAQ), Sales Enquiries, questions through e-mail

Epson Hotline

Phone: +62-1500-766

Fax: +62-21-808-66-799

Our Hotline team can help you with the following over the phone or fax:

- Sales enquiries and product information
- Technical support

Epson Service Center

| Province | Company Name | Address | Phone E-mail |
|-----------|--|--|---|
| JAKARTA | Epson Sales and Service Jakarta (SUDIRMAN) | Wisma Keiai Lt. 1 Jl. Jenderal Sudirman Kav. 3 Jakarta Pusat - DKI JAKARTA 10220 | 021-5724335 ess@epson-indonesia.co.id ess.support@epson-indonesia.co.id |
| SERPONG | Epson Sales and Service Serpong | Ruko Melati Mas Square Blok A2 No.17 Serpong-Banten | 082120090084 / 082120090085 esstag@epson-indonesia.co.id esstag.support@epson-indonesia.co.id |
| SEMARANG | Epson Sales and Service Semarang | Komplek Ruko Metro Plaza Block C20 Jl. MT Haryono No. 970 Semarang -JAWA TENGAH | 024 8313807 / 024 8417935 esssmg@epson-indonesia.co.id esssmg.support@epson-indonesia.co.id |
| JAKARTA | Epson Sales and Service Jakarta (MANGGA DUA) | Ruko Mall Mangga Dua No. 48 Jl. Arteri Mangga Dua, Jakarta Utara - DKI JAKARTA | 021 623 01104 jkt-technical1@epson-indonesia.co.id jkt-admin@epson-indonesia.co.id |
| BANDUNG | Epson Sales and Service Bandung | Jl. Cihampelas No. 48 A Bandung Jawa Barat 40116 | 022 420 7033 bdg-technical@epson-indonesia.co.id bdg-admin@epson-indonesia.co.id |
| MAKASSAR | Epson Sales and Service Makassar | Jl. Cendrawasih NO. 3A, kunjung mae, mariso, MAKASSAR - SULSEL 90125 | 0411- 8911071 mksr-technical@epson-indonesia.co.id mksr-admin@epson-indonesia.co.id |
| MEDAN | Epson Service Center Medan | Jl. Bambu 2 Komplek Graha Niaga Nomor A-4, Medan - SUMUT | 061- 42066090 / 42066091 mdn-technical@epson-indonesia.co.id mdn-adm@epson-indonesia.co.id |
| PALEMBANG | Epson Service Center Palembang | Jl. H.M Rasyid Nawawi No. 249 Kelurahan 9 Ilir Palembang Sumatera Selatan | 0711 311 330 escplg@epson-indonesia.co.id escplg.support@epson-indonesia.co.id |
| PEKANBARU | Epson Service Center Pekanbaru | Jl. Tuanku Tambusai No. 459 A Kel. Tangkerang barat Kec Marpoyan damai Pekanbaru - Riau 28282 | 0761- 8524695 pkb-technical@epson-indonesia.co.id pkb-admin@epson-indonesia.co.id |
| PONTIANAK | Epson Service Center Pontianak | Komp. A yani Sentra Bisnis G33, Jl. Ahmad Yani - Pontianak Kalimantan Barat | 0561- 735507 / 767049 pontianak-technical@epson-indonesia.co.id pontianak-admin@epson-indonesia.co.id |
| SAMARINDA | Epson Service Center Samarinda | Jl. KH. Wahid Hasyim (M. Yamin) Kelurahan Sempaja Selatan Kecamatan Samarinda UTARA - SAMARINDA - KALTIM | 0541 7272 904 escsmd@epson-indonesia.co.id escsmd.support@epson-indonesia.co.id |

| Province | Company Name | Address | Phone E-mail |
|------------|--|--|--|
| SURABAYA | Epson Sales & Service Surabaya (barat) | Jl. Haji Abdul Wahab Saimin, Ruko Villa Bukit Mas RM-11, Kec. Dukuh Pakis, Surabaya - 60225 | 031- 5120994 sby-technical@epson-indonesia.co.id sby-admin@epson-indonesia.co.id |
| YOGYAKARTA | Epson Service Center Yogyakarta | YAP Square, Block A No. 6 Jl. C Simanjutak Yogyakarta - DIY | 0274 581 065 ygy-technical@epson-indonesia.co.id ygy-admin@epson-indonesia.co.id |
| JEMBER | Epson Service Center Jember | JL. Panglima Besar Sudirman Ruko no.1D Jember-Jawa Timur (Depan Balai Penelitian & Pengolahan Kakao) | 0331- 488373 / 486468 jmr-admin@epson-indonesia.co.id jmr-technical@epson-indonesia.co.id |
| MANADO | EPSON SALES AND SERVICE Manado | Jl. Piere Tendean Blok D No 4 Kawasan Mega Mas Boulevard - Manado 95111 | 0431- 8805896 MND-ADMIN@EPSON-INDONESIA.CO.ID MND-TECHNICAL@EPSON-INDONESIA.CO.ID |
| CIREBON | EPSON SERVICE CENTER Cirebon | Jl. Tuparev No. 04 (Depan Hotel Apita) Cirebon, JAWA BARAT | 0231– 8800846 cbn-technical@epson-indonesia.co.id |
| CIKARANG | EPSON SALES AND SERVICE CIKARANG | Ruko Metro Boulevard B1 Jababeka cikarang - Jawa Barat, | 021- 89844301 / 29082424 ckg-admin@epson-indonesia.co.id ckg-technical@epson-indonesia.co.id |
| MADIUN | EPSON SERVICE CENTER MADIUN | Jl. Diponegoro No.56, MADIUN - JAWA TIMUR | 0351- 4770248 mun-admin@epson-indonesia.co.id mun-technical@epson-indonesia.co.id |
| PURWOKERTO | EPSON SALES AND SERVICE Purwokerto | Jl. Jendral Sudirman No. 4 Kranji Purwokerto - JAWA TENGAH | 0281- 6512213 pwt-admin@epson-indonesia.co.id pwt-technical@epson-indonesia.co.id |
| BOGOR | EPSON SALES AND SERVICE Bogor | Jl.Pajajaran No 15B Kel Bantarjati Kec Bogor Utara - JAWA BARAT 16153 | 0251- 8310026 bgr-admin@epson-indonesia.co.id bgr-technical@epson-indonesia.co.id |
| SERANG | EPSON SERVICE CENTER Serang | Jl. Ahmad Yani No.45C, SERANG - BANTEN | 0254- 7912503 srg-admin@epson-indonesia.co.id srg-technical@epson-indonesia.co.id |
| PALU | EPSON SALES AND SERVICE Palu | Jl. Juanda No. 58, Palu - Sulteng | 0451- 4012 881 plw-admin@epson-indonesia.co.id plw-technical@epson-indonesia.co.id |

| Province | Company Name | Address | Phone E-mail |
|-------------|---|--|---|
| BANJARMASIN | EPSON SERVICE CENTER BANJARMASIN | Jl. Gatot Soebroto NO. 153 BANJARMASIN - KALSEL 70235 | 0511- 6744135 (TEKNISI) / 3266321(ADMIN) bdj-admin@epson-indonesia.co.id bdj-technical@epson-indonesia.co.id |
| DENPASAR | EPSON SALES AND SERVICE Denpasar | JL. MAHENDRADATA NO. 18, DENPASAR - BALI | 0361- 3446699 / 9348428 dps-admin@epson-indonesia.co.id dps-technical@epson-indonesia.co.id |
| JAKARTA | EPSON SALES AND SERVICE CILANDAK | CIBIS Business Park Tower 9 LT. MEZZANINE, Jalan TB Simatupang No.2, Jakarta Selatan - DKI JAKARTA 12560 | 021- 80866777 esscibis.support1@epson-indonesia.co.id esscibis.support2@epson-indonesia.co.id esscibis.admin@epson-indonesia.co.id esscibis.sales@epson-indonesia.co.id |
| SURABAYA | EPSON SALES AND SERVICE SURABAYA (GUBENG) | JL. RAYA GUBENG NO. 62, SURABAYA - JAWA TIMUR | 031- 99444940 / 99446299 / 99446377 esssby@epson-indonesia.co.id esssby.support@epson-indonesia.co.id |
| AMBON | EPSON SERVICE CENTER AMBON | Jl. Diponegoro No.37 (Samping Bank Mandiri Syariah) Kel.Ahusen, Kec.Sirimau - Ambon 97127 | - |

For other cities not listed here, call the Hot Line: 08071137766.

Help for Users in Hong Kong

To obtain technical support as well as other after-sales services, users are welcome to contact Epson Hong Kong Limited.

Internet Home Page

<http://www.epson.com.hk>

Epson Hong Kong has established a local home page in both Chinese and English on the Internet to provide users with the following information:

- Product information
- Answers to Frequently Asked Questions (FAQs)
- Latest versions of Epson product drivers

Technical Support Hotline

You can also contact our technical staff at the following telephone and fax numbers:

Phone: 852-2827-8911

Fax: 852-2827-4383

Help for Users in Malaysia

Contacts for information, support, and services are:

World Wide Web

<http://www.epson.com.my>

- Information on product specifications, drivers for download
- Frequently Asked Questions (FAQ), Sales Enquiries, questions through e-mail

Epson Call Centre

Phone: 1800-81-7349 (Toll Free)

Email: websupport@emsb.epson.com.my

- Sales enquiries and product information
- Product usage questions or problems
- Enquiries on repair services and warranty

Head Office

Phone: 603-56288288

Fax: 603-5628 8388/603-5621 2088

Help for Users in India

Contacts for information, support, and services are:

World Wide Web

<http://www.epson.co.in>

Information on product specifications, drivers for download, and products enquiry are available.

Helpline

- Service, product information, and ordering consumables (BSNL Lines)
 - Toll-free number: 18004250011
 - Accessible 9am to 6pm, Monday through Saturday (Except public holidays)
- Service (CDMA & Mobile Users)
 - Toll-free number: 186030001600
 - Accessible 9am to 6pm, Monday through Saturday (Except public holidays)

Help for Users in the Philippines

To obtain technical support as well as other after sales services, users are welcome to contact the Epson Philippines Corporation at the telephone, fax numbers and e-mail address below:

World Wide Web

<http://www.epson.com.ph>

Information on product specifications, drivers for download, Frequently Asked Questions (FAQ), and E-mail Enquiries are available.

Epson Philippines Customer Care

Toll Free: (PLDT) 1-800-1069-37766

Toll Free: (Digital) 1-800-3-0037766

Metro Manila: (632) 8441 9030

Web Site: <https://www.epson.com.ph/contact>

E-mail: customercare@epc.epson.com.ph

Accessible 9am to 6pm, Monday through Saturday (Except public holidays)

Our Customer Care team can help you with the following over the phone:

- Sales enquiries and product information
- Product usage questions or problems
- Enquiries on repair service and warranty

Epson Philippines Corporation

Trunk Line: +632-706-2609

Fax: +632-706-2663