



by Schneider Electric

I N S T A L L A T I O N

Next Gen Sarix® Enhanced IME Series Mini Dome Cameras



**Installation Manual
C1338M 12/16**

Contents

Important Notices.....	3
Legal Notice	3
Regulatory Notices	3
Korean Class A EMC	3
Warranty Statement.....	3
Introduction	4
Models	5
Recommended Mounts.....	5
Optional Accessories	5
Getting Started.....	6
Surface Mount Models.....	7
Supplied Parts List.....	7
User-Supplied Parts List.....	7
Product Overview	8
Installation.....	9
Installing the Mount.....	9
In-Ceiling: Indoor and Environmental	9
Pendant: Indoor and Environmental	12
Surface Mount: Indoor and Environmental	15
Wall Mount: Indoor.....	17
Cable Terminations	22
Ethernet Wiring Requirement for PoE	22
Alarm/Relay/Audio Port	23
IP Address Settings	24
Logging On to the Camera	24

Important Notices

For more information about Pelco's product-specific important notices and thereto related information, refer to www.pelco.com/legal.

Regulatory Notices

This device complies with Part 15 of the FCC Rules. Operation is subject to the following two conditions: (1) this device may not cause harmful interference, and (2) this device must accept any interference received, including interference that may cause undesired operation.

Radio and Television Interference

This equipment has been tested and found to comply with the limits of a Class A digital device, pursuant to Part 15 of the FCC rules. These limits are designed to provide reasonable protection against harmful interference when the equipment is operated in a commercial environment. This equipment generates, uses, and can radiate radio frequency energy and, if not installed and used in accordance with the instruction manual, may cause harmful interference to radio communications. Operation of this equipment in a residential area is likely to cause harmful interference in which case the user will be required to correct the interference at his own expense.

Changes and modifications not expressly approved by the manufacturer or registrant of this equipment can void your authority to operate this equipment under Federal Communications Commission's rules.

CAN ICES-3(A)/NMB-3(A).

Korean Class A EMC

이 기기는 업무용 (A 급) 전자파 적합기기로서 판매자 또는 사용자는 이 점을 주의하시길 바라며, 가정 외의 지역에서 사용하는 것을 목적으로 합니다.

Warranty Statement

For information about Pelco's product warranty and thereto related information, refer to www.pelco.com/warranty.

UL Safety Notices

This product is intended to be supplied by a Listed Power Unit marked "L.P.S." (or "Limited Power Source") and rate output 24Vac, 50/60Hz, 1.28 minimum or 48 Vdc, 0.35A minimum.

The product shall be installed by a qualified service person and the installation shall conform to local codes.

Introduction

The Next Gen Sarix® IME Series IP cameras feature SureVision 3.0 technology that seamlessly deliver advanced low-light performance with Pelco's Wide Dynamic Range (WDR) and anti-bloom technologies that operate simultaneously. They are part of Pelco's Enhanced (E) range of cameras, providing industry-leading image quality and performance.

The Next Gen IME Series Mini Dome Camera is easy to install, offers flexible mounting options, and uses a standard Web browser for easy remote setup and administration.

The Next Gen IME Series Mini Dome Camera easily connects to Pelco IP and hybrid systems such as VideoXpert™, Endura® version 2.0 (or later), and Digital Sentry® version 7.3 (or later). The camera is also conformant with ONVIF Profile S, Profile G, and Profile Q for connection with third-party software. Pelco offers an Application Programming Interface (API) and Software Developer's Kit (SDK) for interfacing with Pelco's IP cameras.

This document describes the installation and initial setup procedures to begin operating the camera. For more information about operating your camera, refer to the operation manual specific to the product.

NOTE: For additional information about product documentation in English and other languages, go to www.pelco.com/sarix and navigate to the Next Gen IME Series Mini Dome Camera website.

Models

IME129-1IS	Indoor, 3 ~ 9 mm focal range, surface mount, 1MPx, white
IME229-1IS	Indoor, 3 ~ 9 mm focal range, surface mount, 2MPx, white
IME329-1IS	Indoor, 3 ~ 9 mm focal range, surface mount, 3MPx, white
IME129-1ES	Environmental, 3 ~ 9 mm focal range, surface mount, 1MPx, light gray
IME229-1ES	Environmental, 3 ~ 9 mm focal range, surface mount, 2MPx, light gray
IME329-1ES	Environmental, 3 ~ 9 mm focal range, surface mount, 3MPx, light gray
IME129-1RS	Environmental, 3 ~ 9 mm focal range, surface mount, 1MPx, light gray, IR LED
IME229-1RS	Environmental, 3 ~ 9 mm focal range, surface mount, 2MPx, light gray, IR LED
IME329-1RS	Environmental, 3 ~ 9 mm focal range, surface mount, 3MPx, light gray, IR LED

Recommended Mounts

WMVE-SR	Pendant mount arm, 1.5in., NPT, environmental, light gray
WMVE-SW	Pendant mount arm, 1.5in., NPT, indoor, white
IMEICM-E	Environmental in-ceiling mount, light gray
IMEICM-I	Indoor in-ceiling mount, white
IMEPMB-I	Wall mount bracket, light duty, indoor, white

Optional Accessories

PA101	Pole adapter for use with WMVE-SR wall mount
IMEPM-E	1.5-inch NPT environmental pendant adapter, light gray
IMEPM-I	1.5-inch NPT indoor pendant adapter, white
IMEEBAP-E	Environmental 4S electrical box and Type 4X adapter
IMEEBAP-I	Indoor 4S electrical box adapter

- Contact Pelco Product Support for more information about the use of the Pelco IP camera tester with cameras

Getting Started

Before installing your device, thoroughly familiarize yourself with the information in the installation section of this manual.

NOTES:

- Pelco recommends connecting the device to a network that uses a Dynamic Host Configuration Protocol (DHCP) server to address devices.
- Do not use a network hub when configuring the network settings for the device.
- To ensure secure access, place the device behind a firewall when it is connected to a network.

To ensure secure access, place the device behind a firewall when it is connected to a network.

Surface Mount Models

Supplied Parts List

Qty	Description
1	Camera
1	Mounting plate (Type 4X for environmental models only)
1	IME Series Mini Dome IP Camera Installation manual
1	Important Safety Instructions
1	Resource sheet

User-Supplied Parts List

Qty	Description
1	Pipe/conduit (if applicable)
1	Conduit adapters (if applicable)
1	RJ-45 connector to terminate wires
1	Cat5 (or higher) cable
1	#2 Philips screwdriver
1	SD card, up to a 128 GB SanDisk Extreme® PLUS SDHC™ UHS-I MicroSD card, or with adapter to standard SD card size.

Product Overview

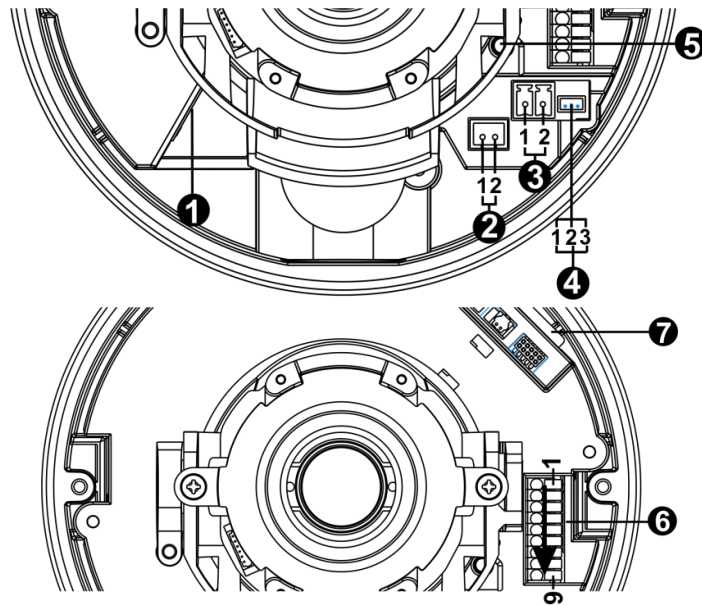

- (1) **RJ-45 Network Port:** Connects the camera to the IP network. Also supplies power to the camera (PoE), through the same connector.
 - I. To purchase power adaptor, please contact Pelco for further information.
- (2) **BNC Connector:** A two-pin connector for analog video output. Pin 1 is BNC; pin 2 is GND. Please contact the manufacturer for the compatible BNC cable.
- (3) **Power Connector:** A two-pin connector for 12VDC and 24VAC. Pin 1 is 12VDC or 24VAC 1; Pin 2 is GND or 24VAC 2.
 - I. The ITE is to be connected only to PoE networks without routing to the outside plant or equivalent description.
- (4) **RS-485:** A three-pin connector for RS-485 connection. Pin 1 is D+; pin 2 is D-; pin 3 is GND.
- (5) **Reset Button:** Reboots the camera or restores the camera's factory default settings. This button is recessed. Using a small tool, such as a paper clip, press and release the reset button once to reboot the camera. Press and hold the reset button for 10 seconds to restore the camera to the factory default settings.
- (6) **Alarm/Relay/Audio Port:** Connects to alarms, relays, and audio in/out.
- (7) **SD Card:** Install the SD card into the card slot to store videos and snapshots. Do not remove the SD card when the camera is powered on. With regards to SD card installation, please note information listed below:
 - I. The SD card slot is located at the base of the camera module. To install the SD card, dome cover must be taken off from the camera. Take off the camera module and put SD card into SD card slot.
 - II. This camera supports a Micro SD card, in SD card adaptor.

NOTE: The Next Gen IME Series Mini Dome Camera includes adaptive IR illumination up to 30 meters. There are LED lights in a circle along the outer edge of the camera. The Next Gen IME Series Mini Dome Camera also includes a Camera Status LED which appears red at power on, changes to flashing green through boot up, and then it turns off when the camera is in normal operation.

Installation

Installing the Mount

You can install the IME Series mini domes using one of the following mounting methods:

- Installation in a suspended ceiling or a fixed ceiling. Refer to [In-Ceiling: Indoor and Environmental with IMEICM-I or IMEICM-E](#)
- Installation using a pendant mount. Refer to [Pendant: Indoor and Environmental with WMVE-SR or WMVE-SW and IMEPM-I or IMEPM-E](#).
- Surface mount or installation on an electrical box. Refer to [Surface Mount: Indoor and Environmental](#), [Wall Mount: Indoor with IMEPMB-I](#), or [Electrical Box: Indoor and Environmental with IMEEBAP-I or IMEEBAP-E \(Type 4X\)](#)

In-Ceiling: Indoor and Environmental with IMEICM-I or IMEICM-E

Supplied Parts List

Qty	Description
1	In-Ceiling mount
1	Ceiling sticker
2	M4 mechanical screws
1	Trim ring

Installation Guide

1. Optional: Remove the camera dome from camera housing by removing the anti-drop chain. Or, leave the protective film on the dome and use care.



2. Secure the back box on the mounting bracket.

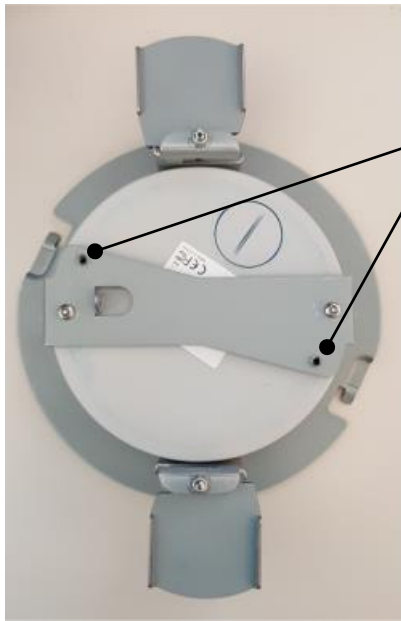

INSTALL SCREWS HERE IF
WATERTIGHT SEAL IS NEEDED

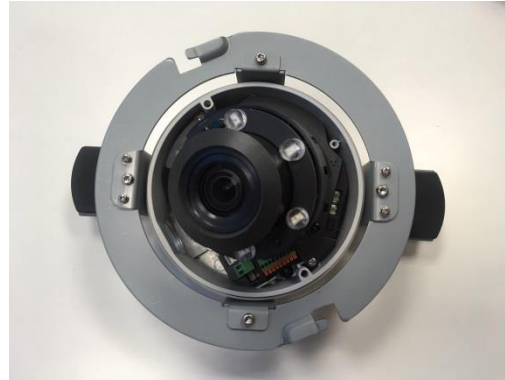

3. Determine the mounting location in the ceiling.
4. Use the template to mark the hole on the wall, ceiling, or ceiling tile.
5. Cut the hole for the camera.
6. Pull the wiring through the hole.
7. Move the conduit plug to side or top where needed to use the other hole for wire entry. Tighten the plug.
8. Install the back box as follows:
 - a. Attach and seal the conduit as needed.
 - b. If using conduit (not supplied): Feed wires into the back box, and plug camera in.
 - c. Fold the rubber holders inside to clear the hole.
 - d. Push the back box through the hole.
 - e. Rotate the screws clockwise to secure the bracket on the ceiling.



9. Adjust the angle of lens by pan and tilt. Grasp the base of the lens assembly to adjust. Adjust the lens rotation.



10. Tighten the locking screw to secure the camera module position.



11. Secure the anti-drop chain, put on the dome cover, and tighten the dome cover.

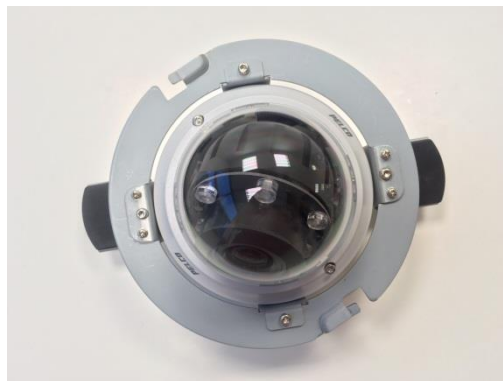

12. Put on the trim ring and rotate it clockwise to secure the trim ring on the bracket.



Pendant: Indoor and Environmental with IMEPM-I or IMEPM-E and WMVE-SR or WMVE-SW

Supplied Parts List

Qty	Description
1	Pendant cap
2	M4x8 mechanical screws

Installation Guide

1. Optional: Remove the camera dome from camera housing by removing the anti-drop chain.



2. Put the conduit plug on the side of the camera box.
3. Apply grease or Teflon tape to the pendant threads.
4. Put the wiring through the hole on the top of the pendant cap into the camera.
5. Screw on the pendant to the pipe or support arm.
6. Add the support arm if purchased. Refer to the WMVE-SR and WMVE-SW installation manual on pelco.com for installing the wall mount arm.

WMVE-SR AND WMVE-SW WALL MOUNT ARM

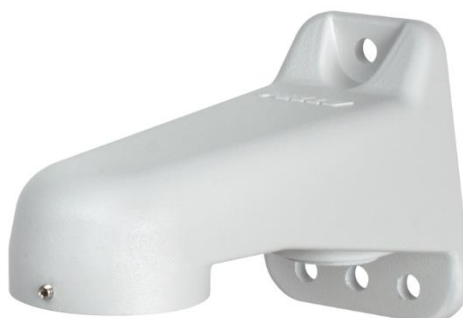

7. Place the camera back box or full camera into the pendant cap and adjust the camera back box by using the self-positioning pillars in the pendant cap. Twist until it snaps fully in. Secure the 2 M4 screws.



8. Replace the camera on the back box (if removed for installation ease).



9. Adjust the angle of lens by pan and tilt by grasping the base. Adjust the lens rotation.

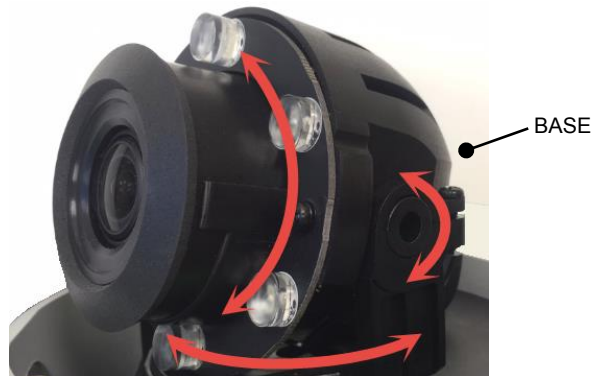

10. Tighten the locking screw to secure the camera module position.



11. Secure the anti-drop chain, put on the dome cover, and tighten the dome cover.



Electrical Box: Indoor and Environmental with IMEEBAP-I or IMEEBAP-E (Type 4X)

Installation Guide

NOTE: The environmental camera is weather tight, rated IP66 if installed directly to a surface. So, this mounting plate is optional. However, to comply with Type 4X outdoor rating, one must install the Type 4X mounting plate. (The Type 4X plate has a dual function to mount to junction boxes, so you can ignore the additional holes if not installing to a junction box.)

1. Install the Type 4X Electrical Adapter Plate (plate) on the surface or Type 4X electrical box and secure the screws.
2. Prepare the wire entry holes through the plate and camera box as follows:
 - a. Remove the conduit plug if required and move to the hole not used.

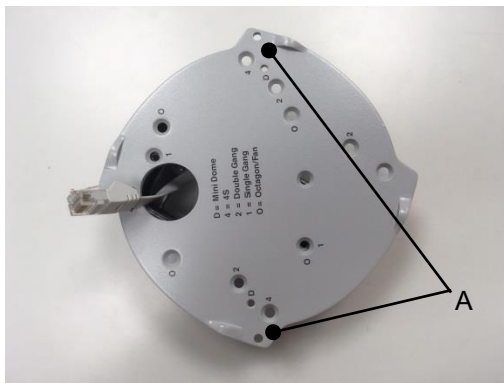

3. Remove the dome cover from the camera (optional).
4. Install the camera to the plate.
5. Pull the wire through the conduit hole into the camera.
6. Mount the plate/camera to the surface using the holes marked "A" in the illustration above.
7. Connect and seal the conduit.
8. Adjust the angle of lens by pan and tilt by grasping the base. Adjust the lens rotation.

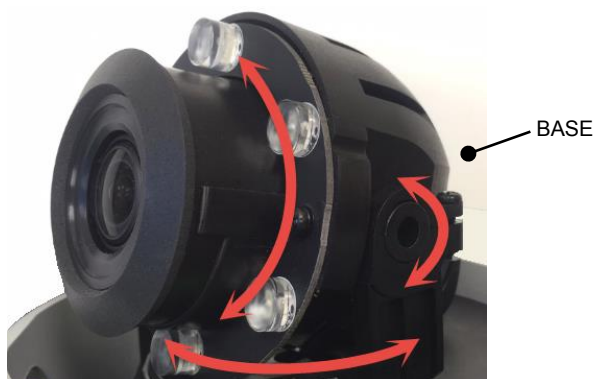

9. Tighten the locking screw to secure the camera module position.



10. Install the dome lanyard if removed and then the dome cover and tighten the dome cover screws.



Surface Mount: Indoor and Environmental

Installation Guide

1. Prepare the wire entry holes through the plate and camera box as follows:
 - a. Remove the conduit plug if required and move to the hole not used.

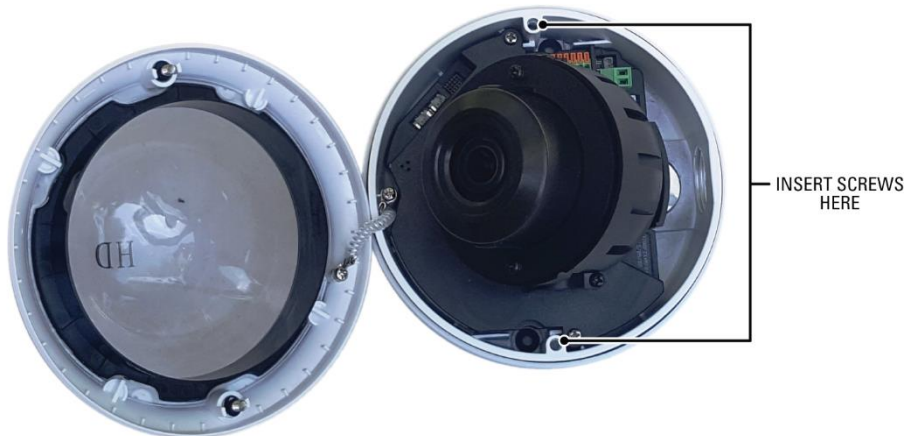

2. Remove the dome cover from the camera (optional).
3. Pull the wire through the conduit hole into the camera.
4. Mount the plate/camera to the surface.
5. Adjust the angle of lens by pan and tilt by grasping the base. Adjust the lens rotation.

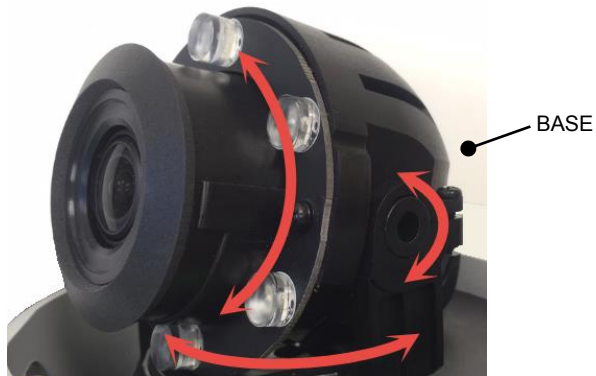

6. Tighten the locking screw to secure the camera module position.



7. Install the dome lanyard if removed and then the dome cover and tighten the dome cover screws.



Wall Mount: Indoor with IMEPMB-I

Supplied Parts List

Qty	Description
1	Wall mount bracket
2	Plastic screw anchors
2	M4x25 self-tapping screws
2	M4x8 mechanical screws

Installation Guide

1. Place the wall mount bracket at the installation location.



2. Prepare the wire entry holes through the wall mount bracket and camera box. Move the plug if necessary.
3. Install the camera to the wall mount bracket using 2 M4 screws.
4. Adjust the angle of lens by pan and tilt by grasping the base. Adjust the lens rotation.

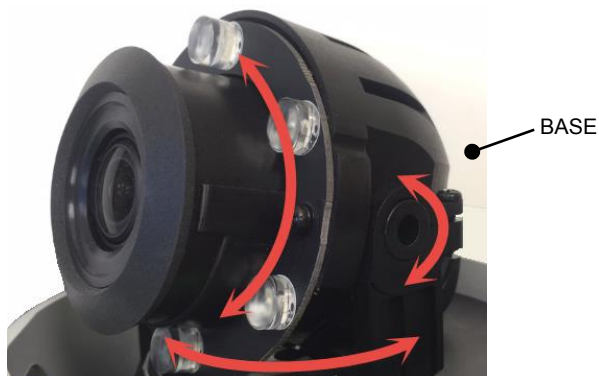

5. Tighten the locking screw to secure the camera module position.



6. Install the dome cover and tighten the dome cover.

Positioning the Camera

- **Pan (A) and Tilt (B):** Pan and tilt the lens base until you are satisfied with the view.
- **Rotation (C):** Rotate the camera lens to your desired angle. The arrow indicates the top of the view.
- **NOTE:** Limitation for the three axes position: Pan range: 355°, Rotate range: 180°, Tilt range: 75°



Cable Terminations

Ethernet Wiring Requirement for PoE

Connect a Cat5 cable or higher (Cat5e, Cat6) cable (not supplied) to the RJ-45 network connector. The 8-pin port includes video over Ethernet, and PoE for the camera. PoE injects power over the same cabling that carries the network data, eliminating the need for a separate power supply. This simplifies the installation and operation of the camera without affecting network performance.

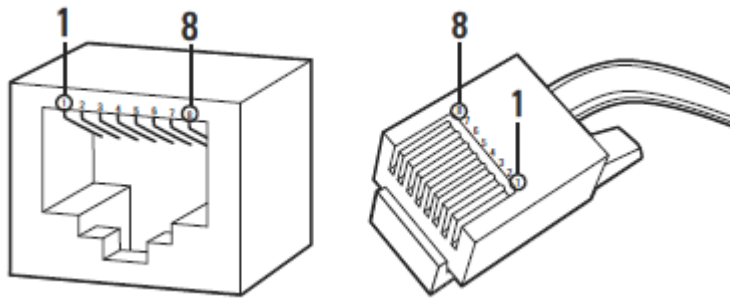

Table 1 Pin Definition

PoE Mode A			PoE Mode B		
Pin	Function		Pin	Function	
1	TxRx A +	DC +	1	TxRx A +	
2	TxRx A -	DC +	2	TxRX A -	
3	TxRx B +	DC -	3	TxRx B +	
4	TxRx C +		4	TxRx C +	DC +
5	TxRx C -		5	TxRx C -	DC +
6	TxRx B -	DC -	6	TxRx B -	
7	TxRx D +		7	TxRx D +	DC -
8	TxRx D -		8	TxRx D -	DC -

Alarm/Relay/Audio Port

The 9-pin Alarm/Relay/Audio port has the following pins and pin assignments

Table 2 Pin Descriptions for Alarm/Relay/Audio Port

No.	Connector	Pin	Definition	Remarks
1	Alarm & Audio I/O	1	GND	
		2	Audio In	Audio In
		3	GND	
		4	Audio Out L	Audio Out
		5	Audio Out R	
		6	Alarm Out +	Alarm connection
		7	Alarm Out -	
		8	Alarm In +	
		9	Alarm In -	

IP Address Settings

If the camera is connected to a Dynamic Host Configuration Protocol (DHCP) network and DHCP is set to On, the server automatically assigns an IP address to the camera. The default setting for the camera is DHCP On. To set the camera's IP address manually, set DHCP to Off.

NOTE: When DHCP is on, but a DHCP server cannot be found:

- Next Gen Sarix Enhanced cameras will simultaneously support two IP addressing schemes: 169.254.x.x and 192.168.0.x (starting from 192.168.0.20).
 - The default IP address on subnet mask 255.255.0.0 is automatically assigned as 169.254.x.y where x and y will take a value from 0 to 255 randomly. Please note cameras on the same subnet will not be assigned the same IP address to avoid IP conflicts.
 - The device defaults to an address of 192.168.0.20 on a 255.255.255.0 subnet. If 192.168.0.20 is already in use on the network, the Sarix device will increment the address by one until it finds an unused address (for example, 192.169.0.21 if 192.168.0.20 is in use).

Logging On to the Camera

After logging on to the camera, you can view video from the Web user interface.

1. Open the Web browser.
2. Type the camera's IP address in the browser address bar, and then press Enter.

NOTE: If you do not know the camera's IP address, you can locate it using the Pelco Device Utility software.

3. To access the device in its initial out-of-the-box state, you will be able to set the initial administrator account password.

NOTE: The initial out-of-the-box state is also called "Factory Default Status."

Factory Default State:

The ONVIF Profile Q specification requires that the camera accept any commands without authentication when in a Factory Default State. In this initial state there are no users defined and accessing the camera through the web interface will result in a prompt to set the initial administrator account.

Once the initial administrator account is created, the camera should immediately request login credentials and should begin requiring credentials for ONVIF API requests.

Clicking the **Cancel** button when setting the initial administrator account prompt will cause the initial login process to be temporarily bypassed, allowing you to continue to configure the camera without credentials. When the session becomes inactive (e.g. times out) or another session is started, the camera will once again prompt you to set up the initial administrator account.

4. Click Log In.

Pelco Troubleshooting Contact Information

If the instructions provided fail to solve your problem, contact Pelco Product Support at 1-800-289-9100 (USA and Canada) or +1-559-292-1981 (international) for assistance. Be sure to have the serial number and model number available when calling.

Do not try to repair the unit yourself. Leave maintenance and repairs to qualified technical personnel only.



Pelco by Schneider Electric
3500 Pelco Way Clovis, California 93612 USA
(800) 289-9100 Tel (800) 289-9150 Fax
+1 (559) 292-1981 International Tel
+1 (559) 348-1120 International Fax
www.pelco.com

Pelco, the Pelco logo, and other trademarks associated with Pelco products referred to in this publication are trademarks of Pelco, Inc. or its affiliates. ONVIF and the ONVIF logo are trademarks of ONVIF Inc. All other product names and services are the property of their respective companies. Product specifications and availability are subject to change without notice.

© Copyright 2015, Pelco, Inc.
All rights reserved.