

# Acer LCD Monitor

## User Guide

Copyright © 2022. Acer Incorporated.  
All Rights Reserved.

Acer LCD Monitor User Guide  
Original Issue: 12/2022

Changes may be made periodically to the information in this publication without obligation to notify any person of such revisions or changes. Such changes will be incorporated in new editions of this manual or supplementary documents and publications. This company makes no representations or warranties, either expressed or implied, with respect to the contents hereof and specifically disclaims the implied warranties of merchantability or fitness for a particular purpose.

Record the model number, serial number, purchase date and place of purchase information in the space provided below. The serial number and model number are recorded on the label affixed to your computer. All correspondence concerning your unit should include the serial number, model number and purchase information.

No part of this publication may be reproduced, stored in a retrieval system, or transmitted, in any form or by any means, electronically, mechanically, by photocopy, recording or otherwise, without the prior written permission of Acer Incorporated.

#### Acer LCD Monitor User Guide

Model number: \_\_\_\_\_

Serial number: \_\_\_\_\_

Date of purchase: \_\_\_\_\_

Place of purchase: \_\_\_\_\_

Acer and the Acer logo are registered trademarks of Acer Incorporated. Other companies' product names or trademarks are used herein for identification purposes only and belong to their respective companies.

# Information for your safety and comfort

## Safety instructions

Read these instructions carefully. Keep this document for future reference. Follow all warnings and instructions marked on the product.

## Special notes on LCD monitors

The following are normal with the LCD monitor and do not indicate a problem.

- Due to the nature of the fluorescent light, the screen may flicker during initial use. Turn off the power switch and then turn it on again to make sure the flicker disappears.
- You may find slightly uneven brightness on the screen depending on the desktop pattern you use.
- The LCD screen has 99.99% or more effective pixels. It may include blemishes of 0.01% or less such as a missing pixel or pixel lit all the time.
- Due to the nature of the LCD screen, an afterimage of the previous screen may remain after switching the image, when the same image is displayed for hours. In this case, the screen is recovered slowly by changing the image or turning off the power switch for a few hours.

## Cleaning your monitor

Please carefully follow these guidelines when cleaning the monitor:

- Always unplug the monitor before cleaning.
- Use a soft cloth to wipe the screen and cabinet front and sides.

## Recycling Information for the United States of America

Acer encourages information technology (IT) equipment owners to responsibly recycle their equipment when it is no longer needed. Acer offers programs and services to assist equipment owners with this process.

For more information on recycling IT equipment, please go to:

<https://www.acer.com/ac/en/US/content/recycling>

## Accessibility

Make sure that the power outlet is close to the device operator and convenient for plugging and pulling of the power adapter (power cord). Make sure to unplug the power adapter (power cord) from the power outlet when disconnection of power is necessary.

## Safe listening

To protect your hearing, follow these instructions.

- Gradually increase the volume until you can hear it clearly and comfortably and without distortion.
- After setting the volume level, do not increase it after your ears have adjusted.
- Limit the amount of time listening to music at high volume.
- Avoid turning up the volume to block out noisy surroundings.
- Turn the volume down if you can't hear people speaking near you.

## Warnings

- Do not use this product near water.
- Do not place this product on an unstable cart, stand or table. If the product falls, it could be seriously damaged.
- Slots and openings are provided for ventilation to ensure reliable operation of the product and to protect it from overheating. These openings must not be blocked or covered. The openings should never be blocked by placing the product on a bed, sofa, rug or other similar surface. This product should never be placed near or over a radiator or heat register, or in a built-in installation unless proper ventilation is provided.
- Never push objects of any kind into this product through cabinet slots as they may touch dangerous voltage points or short-out parts that could result in a fire or electric shock. Never spill liquid of any kind onto or into the product.
- To avoid damage of internal components and to prevent battery leakage, do not place the product on a vibrating surface.
- Never use it under sporting, exercising, or any vibrating environment which will probably cause unexpected short current or damage internal devices.

## Using electrical power

- This product should be operated from the type of power indicated on the marking label. If you are not sure of the type of power available, consult your dealer or local power company.
- Avoid placing anything on the power adapter (power cord), or placing the device in any position where the power adapter (power cord) will be stepped on.

- If an extension cord is used with this product, make sure that the total ampere rating of the equipment plugged into the extension cord does not exceed the extension cord ampere rating. Also, make sure that the total rating of all products plugged into the wall outlet does not exceed the fuse rating. (For monitors with power cords)
- Do not overload a power outlet, strip or receptacle by plugging in too many devices. The overall system load must not exceed 80% of the branch circuit rating. If power strips are used, the load should not exceed 80% of the power strip's input rating.
- A two-wire grounding plug is supplied for the power cord of the device, which shall only be plugged into a grounded power outlet. Make sure that the power outlet is properly grounded before plugging in. Do not plug into any ungrounded power outlet. Please contact an electrician for details (For monitors with power cords).



.....

**Warning!** The grounding pin is a safety feature. Using a power outlet that is not properly grounded may result in electric shock and/or injury.



.....

**Note:** The grounding pin also provides good protection from unexpected noise produced by other nearby electrical devices that may interfere with the performance of this product.

- Always use the power adapter (power cord) kit supplied.

## Product servicing

Do not attempt to service this product yourself, as opening or removing covers may expose you to dangerous voltage points or other risks. Refer all servicing to qualified service personnel.

Pull out the power adapter (power cord) of the device in any of the following cases, and contact qualified service personnel for maintenance:

- Damaged or worn plug of the power adapter (power cord)
- liquid was spilled into the product
- the product was exposed to rain or water
- the product has been dropped or the case has been damaged
- the product exhibits a distinct change in performance, indicating a need for service
- the product does not operate normally after following the operating instructions



.....

**Note:** Adjust only those controls that are covered by the operating instructions, since improper adjustment of other controls may result in damage and will often require extensive work by a qualified technician to restore the product to normal condition.

## Potentially explosive environments

Switch off your device in any area with a potentially explosive atmosphere and obey all signs and instructions. Potentially explosive atmospheres include areas where you would normally be advised to turn off your vehicle engine. Sparks in such areas could cause an explosion or fire resulting in bodily injury or even death. Switch off the device near gas pumps at service stations. Observe restrictions on the use of radio equipment in fuel depots, storage and distribution areas; chemical plants; or where blasting operations are in progress. Areas with a potentially explosive atmosphere are often, but not always, marked. They include below deck on boats, chemical transfer or storage facilities, vehicles using liquefied petroleum gas (such as propane or butane), and areas where the air contains chemicals or particles such as grain, dust or metal powders.

## Additional safety information

Your device and its enhancements may contain small parts. Keep them out of the reach of small children.

## IT Equipment Recycling Information

Acer is strongly committed to environmental protection and views recycling, in the form of salvaging and disposal of used equipment, as one of the company's top priorities in minimizing the burden placed on the environment.

We at Acer are very conscious of the environmental effects of our business and strive to identify and provide the best working procedures to reduce the environmental impact of our products.

For more information and help when recycling, please go to this website:

<https://www.acer-group.com/sustainability/en/our-products-environment.html>

Visit [www.acer-group.com](http://www.acer-group.com) for further information on the features and benefits of our other products.

## Disposal instructions



Do not throw this electronic device into the trash when discarding. To minimize pollution and ensure utmost protection of the global environment, please recycle. For more information on the Waste from Electrical and Electronics Equipment (WEEE) regulations, visit <https://www.acer-group.com/sustainability/en/our-products-environment.html>

Acer monitor is purposed for video and visual display of information obtained from electronic devices.

## LCD pixel statement

The LCD unit is produced with high-precision manufacturing techniques. Nevertheless, some pixels may occasionally misfire or appear as black or red dots. This has no effect on the recorded image and does not constitute a malfunction.

Built-in power management of the device:

- The LCD monitor enters "sleep" mode if there is no signal in 10 seconds.

## Tips and information for comfortable use

Computer users may complain of eyestrain and headaches after prolonged use. Users are also at risk of physical injury after long hours of working in front of a computer work periods, bad posture, poor work habits, stress, inadequate working conditions, personal health and other factors greatly increase the risk of physical injury

Incorrect computer usage may lead to carpal tunnel syndrome, tendonitis, tenosynovitis or other musculoskeletal disorders. The following symptoms may appear in the hands, wrists, arms, shoulders, neck or back:

- numbness, or a burning or tingling sensation
- aching, soreness or tenderness
- pain, swelling or throbbing
- stiffness or tightness
- coldness or weakness

If you have these symptoms, or any other recurring or persistent discomfort and/or pain related to computer use, consult a physician immediately and inform your company's health and safety department.

The following section provides tips for more comfortable computer use.

## Finding your comfort zone

Find your comfort zone by adjusting the viewing angle of the monitor or raising your sitting height to achieve maximum comfort. Observe the following tips:

- refrain from staying too long in one fixed posture
- avoid slouching forward and/or leaning backward
- stand up and walk around regularly to remove the strain on your leg muscles

## Taking care of your vision

Long viewing hours, wearing incorrect glasses or contact lenses, glare, excessive room lighting, poorly focused screens, very small typefaces and low-contrast displays could stress your eyes. The following sections provide suggestions on how to reduce eyestrain.

### Eyes

- Rest your eyes frequently.
- Give your eyes regular breaks by looking away from the monitor and focusing on a distant point.
- Blink frequently to keep your eyes from drying out.

### Display

- Keep your display clean.
- Keep your head at a higher level than the top edge of the display so your eyes point downward when looking at the middle of the display.
- Adjust the display brightness and/or contrast to a comfortable level for enhanced text readability and graphics clarity.
- Eliminate glare and reflections by:
  - placing your display in such a way that the side faces the window or any light source
  - minimizing room light by using drapes, shades or blinds
  - using a task light
  - changing the display's viewing angle
  - using a glare-reduction filter
  - using a display visor, such as a piece of cardboard extended from the display's top front edge
- Avoid adjusting your display to an awkward viewing angle.
- Avoid looking at bright light sources, such as open windows, for extended periods of time.

## Developing good work habits

Develop the following work habits to make your computer use more relaxing and productive:

- Take short breaks regularly and often.
- Perform some stretching exercises.
- Breathe fresh air as often as possible.
- Exercise regularly and maintain a healthy body.





## EU Declaration of Conformity

We,  
**Acer Incorporated**  
8F, 88, Sec. 1, Xintai 5th Rd., Xizhi, New Taipei City 221

And,  
**Acer Italy s.r.l.**  
Viale delle Industrie 1/A, 20044 Arese (MI), Italy  
Tel: +39-02-939-921 ,Fax: +39-02 9399-2913  
www.acer.it

**Product:** LCD Monitor  
**Trade Name:** ACER  
**Model Number:** XV275U  
**SKU Number:** XV275U xxxxxxxxx  
("x" = 0~9, a~z, A~Z, or blank)

We, Acer Incorporated, hereby declare under our sole responsibility that the product described above is in conformity with the relevant Union harmonization legislations as below Directive and following harmonized standards and/or other relevant standards have been applied:

**EMC Directive: 2014/30/EU**

<input checked="" type="checkbox"/> EN55032:2015+AC:2020 Class B	<input checked="" type="checkbox"/> EN 55035:2017+A11: 2020
<input checked="" type="checkbox"/> EN IEC 61000-3-2:2019 Class D	<input checked="" type="checkbox"/> EN61000-3-3:2013+A1: 2019

**LVD Directive: 2014/35/EU**

EN 62368-1: 2014+ A11:2017

**RoHS Directive: 2011/65/EU**

EN IEC 63000:2018

**ErP Directive: 2009/125/EC**

(EU) 2019/ 2021; EN 50564:2011

Year to begin affixing CE marking: 2022.

**RU Jan / Sr. Manager**  
**Acer Incorporated (New Taipei City)**

**Aug. 8, 2022**  
**Date**



**Acer America Corporation**  
333 West San Carlos St., San Jose  
Suite 1500  
CA 95110, U. S. A.  
Tel : 254-298-4000  
Fax : 254-298-4147  
www.acer.com



## Federal Communications Commission Declaration of Conformity

This device complies with Part 15 of the FCC Rules. Operation is subject to the following two conditions:  
(1) this device may not cause harmful interference, and (2) this device must accept any interference received,  
including interference that may cause undesired operation.

The following local Manufacturer /Importer is responsible for this declaration:

<b>Product:</b>	<b>LCD Monitor</b>
<b>Model Number:</b>	XV275U
<b>SKU Number:</b>	XV275U xxxxxx ("x" = 0~9, a~z, A~Z, or blank)
<b>Name of Responsible Party:</b>	<b>Acer America Corporation</b>
<b>Address of Responsible Party:</b>	<b>333 West San Carlos St. Suite 1500 San Jose, CA 95110 U. S. A.</b>
<b>Contact Person:</b>	<b>Acer Representative</b>
<b>Phone No.:</b>	<b>254-298-4000</b>
<b>Fax No.:</b>	<b>254-298-4147</b>

# Contents

Special notes on LCD monitors	iii
Information for your safety and comfort	iii
Safety instructions	iii
Cleaning your monitor	iii
Connecting/disconnecting the device	iii
Accessibility	iv
Safe listening	iv
Warnings	iv
Using electrical power	iv
Product servicing	v
Potentially explosive environments	vi
Additional safety information	vi
IT Equipment Recycling Information	vi
Disposal instructions	vi
LCD pixel statement	vii
Tips and information for comfortable use	vii
Finding your comfort zone	vii
Taking care of your vision	viii
Developing good work habits	viii
Federal Communications Commission	
Declaration of Conformity	x
<b>Unpacking</b>	<b>1</b>
Installation instructions	2
Screen position adjustment	3
Connect power adapter (power cord)	3
Power saving	3
Display Data Channel (DDC)	4
Connector pin assignment	4
20-pin color display signal cable	4
19-pin color display signal cable	4
<b>Standard timing table</b>	<b>5</b>
<b>Installation</b>	<b>6</b>
<b>Users controls</b>	<b>7</b>
External controls	7
Using the Shortcut Menu	8
The Function page	9
<b>Troubleshooting</b>	<b>18</b>
HDMI/DP Mode (Optional)	18

# Unpacking

Please check that the following items are present when you unpack the box, and save the packing materials in case you need to ship or transport the monitor in the future.

LCD monitor

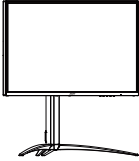

Power cord

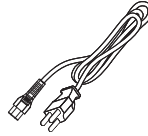

Power adapter



HDMI cable  
(Optional)

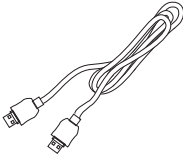

DP cable  
(Optional)

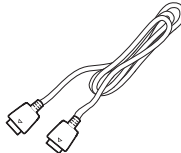

Quick start guide

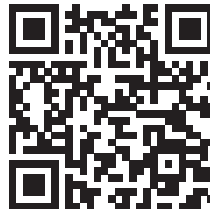

Product Information for EU Energy Label

# Installation instructions

1

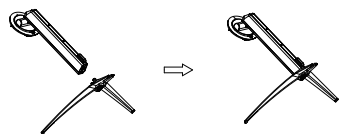

Turn the hand screws clockwise to fix the base and column.

2

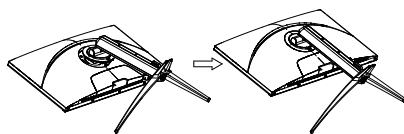

Insert the support hook into the corresponding hole on the back of the monitor to complete the installation.

## Disassembly

1

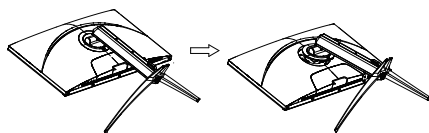

Push the key in the direction of the arrow to remove the support.

2

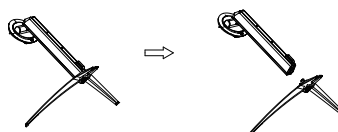

Turn the hand screw counterclockwise to separate the base from the column.

## Screen position adjustment

To optimize the viewing position, you can adjust the monitor tilt, using both of your hands to hold the edges of the monitor. The screen can be adjusted by inclining with both hands to optimize the view as shown below. Generally, it can be adjusted up to 25 degrees backward and up to 5 degrees forward.

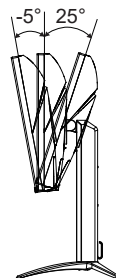

## Connect power adapter (power cord)

The power adapter (power cord) applies universal power supply. AC 100-240v50/60Hz voltage range is applicable without user adjustment.

## Power saving

The monitor will be switched to "power saving" mode by the control signal from the display controller, as indicated by the white light.

Mode	LED light
On	Lighting
Standby/Power saving	flicker

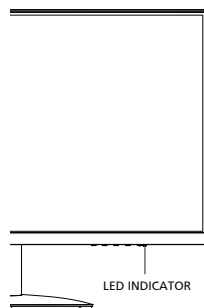

The power-saving state is maintained until the control signal is detected or the keyboard or mouse is used. It takes about 3-4 seconds to recover from the active "sleep" mode to "power on".

## Display Data Channel (DDC)

To make installation easier, so long as your system supports the DDC protocol, the monitor is able to plug-and-play. The DDC is a communication protocol through which the monitor automatically informs the host system about its capabilities; for example, supported resolutions and corresponding timing. The monitor supports the DDC2B standard.

## Connector pin assignment

### 20-pin color display signal cable

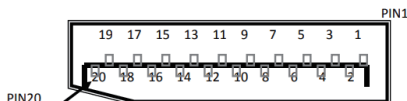

PIN No.	Description	PIN No.	Description
1	ML_LANE3_N	2	GND
3	ML_LANE3_P	4	ML_LANE2_N
5	GND	6	ML_LANE2_P
7	ML_LANE1_N	8	GND
9	ML_LANE1_P	10	ML_LANE0_N
11	GND	12	ML_LANE0_P
13	GND	14	GND
15	AUX_CH_P	16	GND
17	AUX_CH_N	18	HPD
19	RETURN(GND)	20	DP_PWR(3.3V, 500mA)

### 19-pin color display signal cable

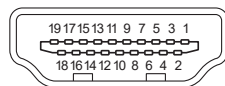

PIN No.	Description	PIN No.	Description
1	TMDS Data2+	2	TMDS Data2 Shield
3	TMDS Data2-	4	TMDS Data1+
5	TMDS Data1 Shield	6	TMDS Data1-
7	TMDS Data0+	8	TMDS Data0 Shield
9	TMDS Data0-	10	TMDS Clock+
11	TMDS Clock Shield	12	TMDS Clock-
13	CEC	14	Reserved (N.C. on device)
15	SCL	16	SDA
17	DDC/CEC Ground	18	+5V Power
19	Hot Plug Detect		

# Standard timing table

Mode	Resolution	
VGA	640x480	60Hz
	640x480	72Hz
	640x480	75Hz
MAC	640x480	66.66Hz
VESA	720x400	70Hz
SVGA	800x600	56Hz
	800x600	60Hz
	800x600	72Hz
	800x600	75Hz
MAC	832x624	74.55Hz
XGA	1024x768	60Hz
	1024x768	70Hz
	1024x768	75Hz
MAC	1152x870	75Hz
VESA	1152x864	75Hz
	1280x960	60Hz
SXGA	1280x1024	60Hz
	1280x1024	75Hz
VESA	1280x720	60Hz
WXGA+	1440x900	60Hz
WSXGA+	1680x1050	60Hz
FHD	1920x1080	60Hz
	1920x1080	120Hz
	1920x1080	144Hz
QHD	2560x1440	60Hz
	2560x1440	75Hz
	2560x1440	85Hz
	2560x1440	100Hz
	2560x1440	120Hz
	2560x1440	144Hz
	2560x1440	165Hz
	2560x1440	170Hz



# Connect the LCD monitor to PC

1. Power off the monitor and unplug the power source of the PC.
2. Connect the VGA cable:
  - a. Make sure the monitor and PC are powered off;
  - b. Connect the VGA cable to the PC.
3. Connect one end of the power adapter into the DC port of the monitor.
4. Connect the power adapter of the PC and the monitor into a power outlet nearby.

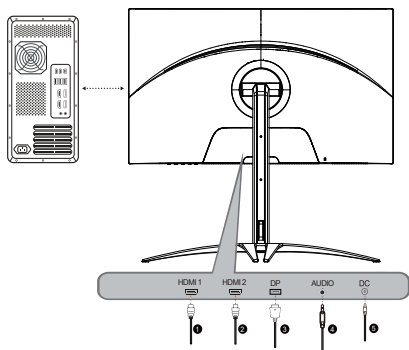

Overview of monitor IN ports



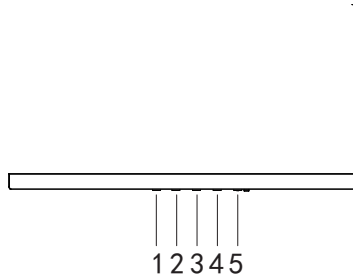

1	HDMI port	4	AUDIO port
2	HDMI port	5	DC port
3	DP port		

Notice: Specific interfaces and signal lines are based on actual conditions.

# Users controls



## External Controls

No.	Icon	Item	Description
1		Mode/Exit	a. Press to view Main page. Press again to enter mode select function. b. When the Function Menu is active. Press to return previous Menu or exit current Menu.
2		Brightness/Enter	a. Press to view Main page. Press again to enter brightness adjustment function. b. When the Function Menu is active, this button will enter a selection in the OSD.
3		Input/Up	a. Press to view Main page. Press again to enter Input select function. b. When the Function Menu is active, press this button selected or move to the previous function.
4		Menu/Down	a. Press to view Main page. Press again to enter next function in the Function Menu. b. When the Function Menu is active, press this key selected or move to the next function.
5	POWER	Power button	Power on/off the monitor. It indicates power on if the light remains on. It indicates stand-by/power-saving mode if the light flashes.

## Using the Shortcut Menu



**Note:** The following content is for general reference only. Actual product specifications may vary.

The OSD (On Screen Display) can be used to adjust the settings of your LCD monitor. Press the MENU key to open the OSD. You can use the OSD to adjust the picture quality, OSD position and general settings. For advanced settings, please refer to following page:

### Main page

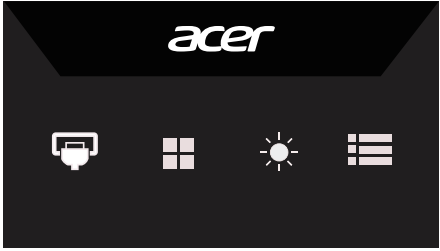
	<ol style="list-style-type: none"><li>1. Hot Key1 Modes, Brightness, Volume, Gamma, Contrast, Low Blue Light, Over Drive</li><li>2. Hot Key2 Modes, Brightness, Contrast, Volume, Gamma, Low Blue Light, Over Drive</li><li>3. Hot Key3 Input Switch Hot Key</li><li>4. Main Menu</li></ol>
---	---

### Hot key1 (default: Standard mode)

To choose game mode(G1, G2, G3) which user-defined profile to use or scenario mode (User, Standard, ECO, Graphics, HDR)

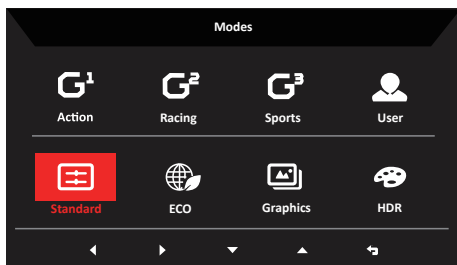

### Hot key2 (default: Brightness)

Open the Brightness control and select your preferred brightness setting . When you are done, press the joystick to quit current page and store.







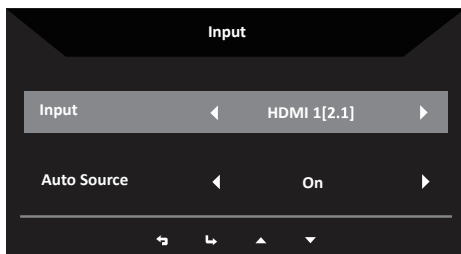



## Selecting the input

Open the Input control and select HDMI1, HDMI2, DP or Auto Source. When you are done, press the  to exit current page and store.



## Main menu

1. Press the MENU key to open the OSD.
2. Toggle the button to the up  or down  to select Picture from the OSD. The toggle to the right to navigate to the element you wish to adjust and press the joystick to enter it.
3. Toggle the joystick  to the left  or right  to adjust the sliding scales.  
 Information Hot Key  : Show Monitor Information and Reset control function.  
 Modes Hot Key  : To change Modes Hot Key menu.  
 Exit Hot Key  : To exit current page and store.

## Picture

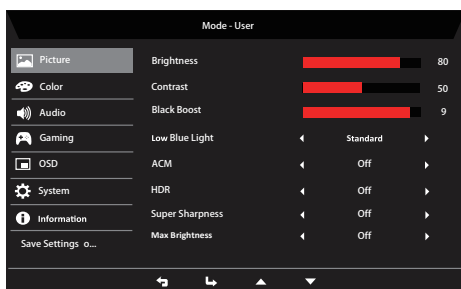

1. Press the MENU key to open the OSD.
2. Toggle the button to the up or down to select Picture from the OSD. Then toggle to the right to navigate to the element you wish to adjust and press the joystick to enter it.
3. Toggle to the left or right to adjust the sliding scales.
4. The Picture menu can be used to adjust the Brightness, Contrast, Black Boost, Low Blue Light, ACM, Super Sharpness.
5. Brightness: Adjust the brightness from 0 to 100.



**Note:** Adjusts the balance between light and dark shades.

6. Contrast: Adjust the contrast from 0 to 100.



**Note:** Sets the degree of difference between light and dark areas.

7. Black Boost: Adjust the black level from 0 to 10. Enhances shadows by increasing the brightness without changing lighter shades.

8. Low Blue Light: Filters out blue light to protect your eyes by adjusting how much blue light is shown -- Level 1, Level 2, Level 3, or Level 4.



**Note:** A lower level allows more blue light to pass through, so in order to achieve the best protection, please select a higher level, of which Level 4 is in the best state.

9. ACM: Turn ACM on or off.



**Note:** Set to "On", will be based on the current screen to dynamic contrast adjustment.

10. Super Sharpness: Turn the Super Sharpness On or Off. Super Sharpness technology can simulate high-resolution images by boosting the pixel density of the original source to make images sharper and clearer..

11. Max Brightness: Default is off.



**Note:** Due to environmental considerations, the default brightness of the monitor will be low. It can be adjusted to your preference with the following steps:

Step 1: Go to OSD menu > Picture> Max Brightness, and turn Off to On to increase the brightness.

Step 2: When Max Brightness is turned on, adjust Brightness value between 0 and 100 to your preference.

## HDR function

- Hot Key of Mode:

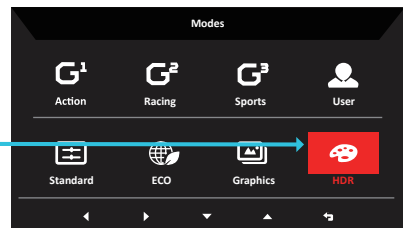

- Main Menu of HDR:

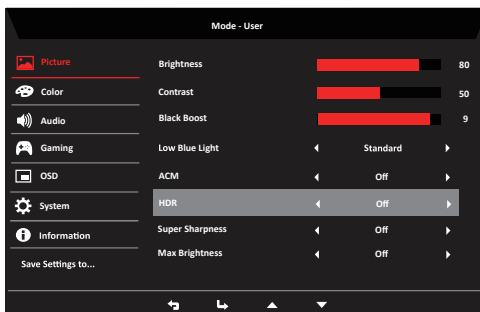

• **HDR Status:**

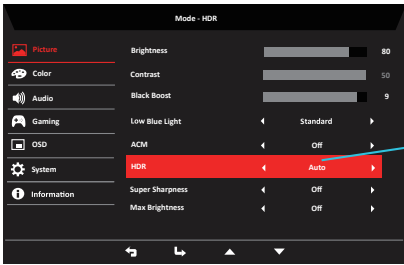

HDR = (Auto or HDR)

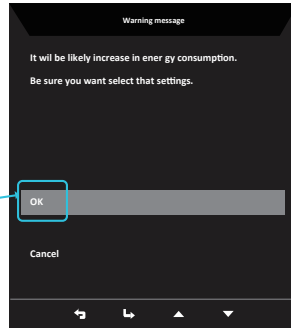

Warning message Page

• **HDR function and Effect:**

Optional	Behavior
Auto	Auto checked input source status
Off (Default)	No support HDR effect



**Note:**

1. HDR = (Auto), The source signal content is SDR , the brightness can to adjustment, but content is HDR the brightness is fixed at 100 and gray out
2. HDR = (Auto), features: (ACM/Gamma/Contrast/Low BlueLight/ColorTemp/Black Boost/6-axis Hue & Saturate) is gray out and unavailable,defaultparameter please refer to "Modes".
3. HDR = (Auto), Color Page only shows the adjustable function, othefunctions (Gamma and Color Temp are hidden).

# Color

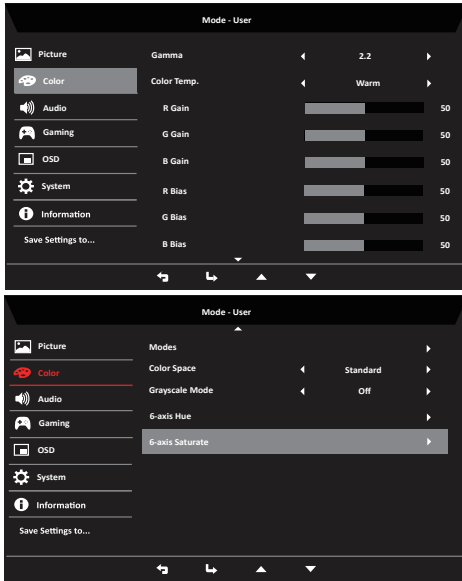

1. Press the MENU key to open the OSD.
2. Toggle the button to the up or down to select Color from the OSD. Then toggle to the right to navigate to the element you wish to adjust and press the button to enter it.
3. Toggle to the left or right to adjust the sliding scales.
4. Gamma mode allows you to adjust the luminance tone. The default value is 2.2 (standard value for Windows).
5. Color temperature: Default is Warm. You can choose Cool, Normal, Warm, Bluelight or User.
6. Modes: To choose scenario mode.
7. Color Space: You can choose sRGB, Rec.709, EBU, DCI, SMPTE-C and Standard.



**Note:** Color Space = HDR to correspond Modes is HDR, Other Color Space the Modes=Standard.

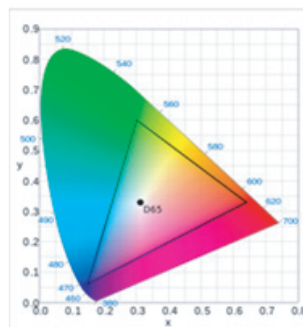
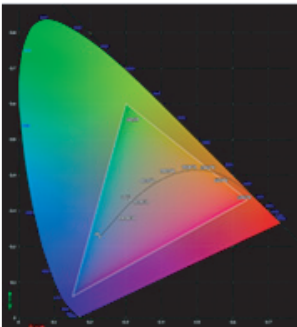

- CIE 1931 positive and negative error of 0.05, ("HDR" according to current Panel to fine-tune)
  - Color Space = HDR, the Modes = HDR, Picture page HDR = Auto.
  - The signal content is SDR, the brightness can to adjustment, but content is HDR the brightness is fixed at 100 and gray out unavailable
  - Modes = (Action/Racing/Sports/User/Standard/ECO/Graphic) is selected; the color space is auto set to "Standard" .
  - Color space = (sRGB/Rec.709/EBU/DCI/SMPT-E-C), The Modes = Standard, and parameters can be adjusted and saved as shareable values.
  - Color Space = (sRGB/Rec.709/HDR/EBU/DCI/SMPT-E-C), If to adjust the parameter the Modes will not jump to User mode, but except Color Space = Standard.
  - Color Space = (sRGB/Rec.709/HDR/EBU/DCI/SMPT-E-C), 6-Axis Hue & Saturate is gray out and unavailable.
  - Color Space = (sRGB/Rec.709/HDR/EBU/DCI/SMPT-E-C), Grayscale Mode is gray out and unavailable.
8. Grayscale Mode: To choose Grayscale mode.
  9. 6-axis Hue: Adjust the red, green, blue, yellow, magenta and cyan hue.
  10. 6-axis Saturate: Adjust the red, green, blue, yellow, magenta and cyan saturation.

## Audio

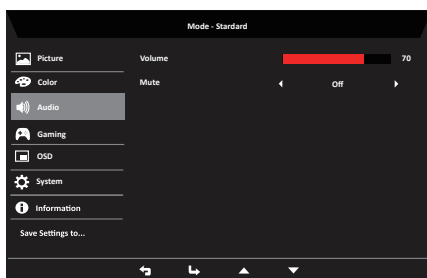

1. Press the MENU key to open the OSD.
2. Toggle the button to the up or down to select Audio from the OSD. Then toggle to the right to navigate to the element you wish to adjust and press the button to enter it.
3. Toggle to the left or right to adjust the sliding scales.
4. Volume: Adjust the volume
5. Mute: To choose mute on/off .



## Gaming

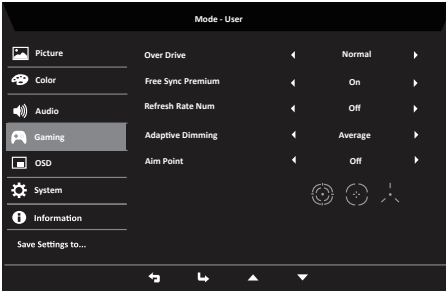

1. Press the MENU key to open the OSD.
2. Toggle the button to the up or down to select Gaming from the OSD. Then toggle to the right to navigate to the element you wish to adjust and press the button to enter it.
3. Toggle to the left or right to adjust the sliding scales.
4. Over Drive: Select Off, Normal, or Extreme.
5. FreeSync Premium: To control support FreeSync Premium or not, default is On.



**Note:**

1. If FreeSync Premium is "ON", then the Over Drive selection is set to "Normal" automatically.
2. If FreeSync Premium is "OFF", then the user can set Over Drive to either one of the three settings including: (a) Extreme (b) Normal (c) Off.

6. Refresh rate num: Display the panel's current refresh rate on the screen.



**Note:** If FreeSync Premium set "On" you can see the V Frequency to changes in the OSD.

7. Adaptive Dimming : You can choose Average, fast, off, Low.
8. Aim point: Show an Aim point on the screen for shooting games.

## OSD

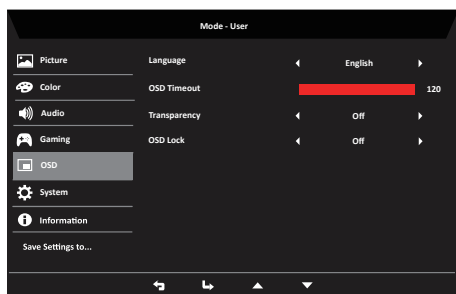

1. Press the MENU key to open the OSD.
2. Toggle the button to the up or down to select OSD from the OSD. Then toggle to the right to navigate to the element you wish to adjust and press the joystick to enter it.
3. Toggle to the left or right to adjust the sliding scales.
4. Language: Set the OSD menu language.
5. OSD timeout: Adjust the delay before turning off the OSD menu.
6. Transparency: Select the transparency when using gaming mode. The transparency can be 0% (OFF), 20%, 40%, 60%, or 80%.
7. OSD Lock: To choose OSD lock on/off.

### **Note:**

#### OSD Locked:

- Set the OSD Lock to "On" by the OSD option and press "Enter" to execute the All Key lock function.
- The "OSD Locked" message will be displayed in the middle of the screen.
- LED lights will be changed from white light to extinguished state.
- Press any Key screen to prompt "OSD Locked" message.

#### OSD Unlocked:

- In normal display condition to press the "Navi Key" in the middle of more than 3 seconds to trigger "OSD Unlock".
- The "OSD Unlock" message will be displayed in the middle of the screen.
- LED lights will be restored to white light.

## System

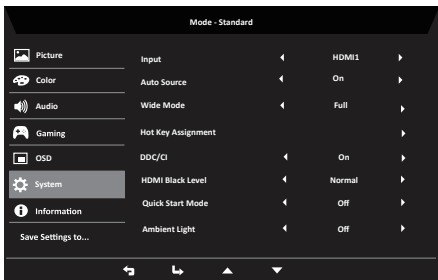

1. Press the MENU key to open the OSD.
2. Toggle the button to the up or down to select System from the OSD. Then toggle to the right to navigate to the element you wish to adjust and press the button to enter it.
3. Toggle to the left or right to control functions.
4. Input: Select the source from HDMI1, HDMI2, DP.
5. Auto Source: The default is "On", which can support auto search for signal source in order.



**Note:** Surround application must set Auto Source is "Off".

6. Wide mode: You can select which screen aspect you are using. The options are Aspect and Full.
7. Hot Key Assignment: Select the function of shortcut key 1 (Modes, Volume, Brightness, Gamma, Contrast, Low Blue Light, Over Drive) and shortcut keys 2 (Modes, Volume, Brightness, Gamma, Contrast, Low Blue Light, Over Drive).
8. DDC/CI: Allows the monitor settings to be set through the software on the PC.



**Note:** DDC/CI, short for Display Data Channel/Command Interface, which allows monitor controls to be sent via software.

9. HDMI Black level: Select to set HDMI black level.
10. Quick start mode: Select Off or On. Turn on to speed up boot speed.
11. Ambient Light: Select Off or Running Light/Flashing/Breathing/Blue/Red.

## Information

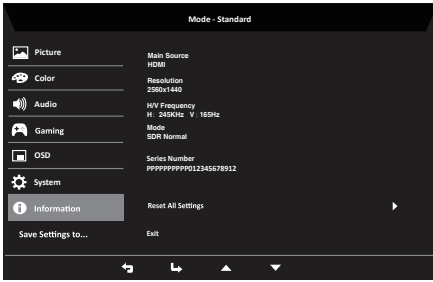

1. Press the **MENU** key to open the OSD.
2. Using the **▲/▼** keys, select Information to view the basic information for your monitor and current input.
3. Reset all settings: Reset the custom color settings to factory defaults.
4. Exit: Exit OSD menu.

## Save Setting to...(User mode only)

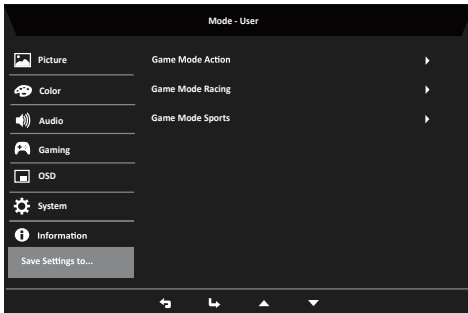

1. Press the MENU key to open the OSD.
2. Toggle the button to the up or down to select "Save Setting to..." from the OSD. Then toggle to the right to navigate to the element you wish to adjust and press the button to enter it.
3. Save Setting to Game mode: There are three user-defined profiles available. When you have decided what settings suit you, save them and system will be able to recall the settings in the future when you turn on gaming mode.

# Troubleshooting

Before sending your LCD monitor for servicing, please check the troubleshooting list below to see if you can self-diagnose the problem.

## HDMI/DP Mode (Optional)

Problem	LED status	Remedy
No picture visible	Remain on	Using the OSD menu, adjust brightness and contrast to maximum or reset to their default settings.
	Light off	Check the power switch.  Check if the power cord is properly connected to the monitor.
	flicker	Check if the video signal cable is properly connected at the back of monitor.  Check if the computer system is switched on and in power saving/standby mode.

---

**Note:** Acer monitor is purposed for video and visual display of information obtained from electronic devices.