



SL-D800 Series

Operation Guide

CMP0182-01 EN

Copyrights and Trademarks

Copyrights and Trademarks

No part of this publication may be reproduced, stored in a retrieval system, or transmitted in any form or by any means, electronic, mechanical, photocopying, recording, or otherwise, without the prior written permission of Seiko Epson Corporation. The information contained herein is designed only for use with this Epson printer. Epson is not responsible for any use of this information as applied to other printers.

Neither Seiko Epson Corporation nor its affiliates shall be liable to the purchaser of this product or third parties for damages, losses, costs, or expenses incurred by the purchaser or third parties as a result of accident, misuse, or abuse of this product or unauthorized modifications, repairs, or alterations to this product, or (excluding the U.S.) failure to strictly comply with Seiko Epson Corporation's operating and maintenance instructions.

Seiko Epson Corporation shall not be liable for any damages or problems arising from the use of any options or any consumable products other than those designated as Original Epson Products or Epson Approved Products by Seiko Epson Corporation.

Seiko Epson Corporation shall not be held liable for any damage resulting from electromagnetic interference that occurs from the use of any interface cables other than those designated as Epson Approved Products by Seiko Epson Corporation.

EPSON®, EPSON EXCEED YOUR VISION, EXCEED YOUR VISION and their logos are registered trademarks or trademarks of Seiko Epson Corporation.

Microsoft® and Windows® are registered trademarks of Microsoft Corporation.

Apple®, Macintosh®, Mac OS®, and OS X® are registered trademarks of Apple Inc.

General Notice: Other product names used herein are for identification purposes only and may be trademarks of their respective owners. Epson disclaims any and all rights in those marks.

© 2019 Seiko Epson Corporation. All rights reserved.

Contents

Copyrights and Trademarks

Before Use

| | |
|---|----|
| Meaning of Symbols. | 5 |
| Screen Shots In the Guide. | 5 |
| Printer Parts. | 6 |
| Front. | 6 |
| Rear. | 9 |
| Feeding Unit. | 10 |
| Print head unit. | 11 |
| Spindle unit. | 11 |
| Lights. | 12 |
| Safety Instructions. | 14 |
| Meaning of Symbols and Marks. | 14 |
| Notes on Installation. | 15 |
| Notes on Handling. | 15 |
| Notes on the Power Supply. | 17 |
| Notes on Consumables. | 18 |
| Other Notes. | 18 |
| Notes on Usage. | 19 |
| Notes when Handling the Main Unit. | 19 |
| Notes on the Paper. | 19 |
| Notes on Ink Cartridges. | 21 |
| Disposing of Used Ink Cartridges and Maintenance Cartridges. | 22 |
| Introducing the Software. | 22 |

Printing Methods

| | |
|---------------------------------|----|
| Basic Printing Methods. | 23 |
|---------------------------------|----|

Replacing Paper

| | |
|-------------------------------------|----|
| How to replace. | 25 |
| Preparing to Replace Paper. | 25 |
| Recording paper level. | 27 |
| Removing the Spindle Unit. | 29 |
| Removing the Roll Paper. | 31 |
| Attaching the Roll Paper. | 32 |
| Attaching the Spindle Unit. | 33 |
| Changing Paper Settings. | 38 |

Ejecting Paper

| | |
|--------------------------------------|----|
| Print tray (optional). | 42 |
| Rigid print tray (optional). | 43 |

| | |
|--|----|
| Attaching and Removing the Print Tray (Optional). | 44 |
| Attaching and Removing the Rigid Print Tray (Optional). | 46 |

Replacing Ink Cartridges

| | |
|-------------------------------------|----|
| Checking Ink Levels. | 48 |
| Checking from the Printer. | 48 |
| Checking from the Computer. | 49 |
| Replacement Procedure. | 52 |

Replacing the Maintenance Cartridge

| | |
|--|----|
| Checking the Free Space in the Maintenance Cartridge. | 56 |
| Checking from the Printer. | 56 |
| Checking from the Computer. | 57 |
| Replacement Procedure. | 59 |

Emptying the Scrap Paper Box

Cleaning the Platen

Maintenance

| | |
|------------------------------|----|
| Maintenance Tool. | 66 |
| Checking Items List. | 67 |
| Scrap paper box. | 67 |
| Airflow vent. | 67 |

Troubleshooting

| | |
|---|----|
| When an Error Occurs. | 68 |
| Warning Buzzer and Light Indicators. | 68 |
| Error Messages (Windows). | 71 |
| Error Messages (Mac). | 71 |
| Errors and Solutions (Windows). | 72 |
| Errors and Solutions (Mac). | 77 |
| Cannot Clear the Displayed Error. | 82 |
| Paper Jams. | 84 |
| Deleting Print Jobs. | 85 |
| Paper is Jammed in the Roll Paper Feeder. | 86 |
| Paper is Jammed in the Internal Paper Feeder | 92 |
| Problems with Print Results. | 98 |
| Problems when Cutting Paper. | 99 |

Contents

When a Problem Cannot be Cleared. 99

Appendix

Consumables and Optional Items. 100

Notes on Moving the Printer. 101

 Preparing to Move. 102

 After Moving. 102

Printer Specifications. 103

 Standards and Approvals. 104

 Necessary space. 105

Notes. 106

 FCC Compliance Statement. 106

 For European customers only. 106



 For Turkish customers only. 107

 For Ukraine customers only. 107

Before Use

Before Use

Meaning of Symbols

| | |
|---|---|
|  Warning: | Warnings must be followed to avoid serious bodily injury. |
|  Caution: | Cautions must be followed to avoid damage to this product or bodily injury. |
|  Important: | Important must be followed to avoid damage to this product. |
| Note: | Notes contain important information on the operation of this product. |

Screen Shots In the Guide

- Screen shots used in this manual may differ to the actual screens. Also, the screens may differ depending on the operating system used and the usage environment.
- Unless otherwise noted, screen shots in this manual are from Windows 7 and Mac OS X v10.7.

Before Use

Printer Parts

Front

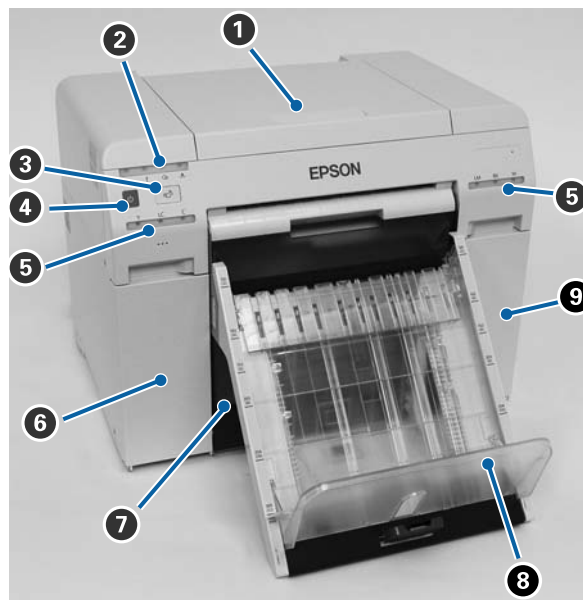

1 Top cover

Open when a paper jam occurs or to perform maintenance.

2 Status display light

This light indicates when the printer's status is normal or if an error has occurred.



 [“Lights” on page 12](#)

3  switch

Press to replace the roll paper. The roll paper is wound back to the replacement position.

 [“Replacing Paper” on page 25](#)

4 Power switch

This is normally ON (the  light is lit). If an emergency occurs, or when it is not going to be used for extended periods of time, press the switch to turn off the printer (the  light turns off).

5 Ink light (orange)

 [“Lights” on page 12](#)

6 Cartridge cover (left)

Open when replacing ink cartridges.

 [“Replacing Ink Cartridges” on page 48](#)

Before Use

7 Scrap paper box

Holds waste paper that is cut off during printing. Empty the scrap paper box when you replace the paper. Needs to be removed when loading or removing paper.

☞ “Emptying the Scrap Paper Box” on page 61

8 Print tray (optional)/Rigid print tray (optional)

Holds the ejected print outs.

☞ “Attaching and Removing the Print Tray (Optional)” on page 44

☞ “Attaching and Removing the Rigid Print Tray (Optional)” on page 46

9 Cartridge cover (right)

Open when replacing ink cartridges or the maintenance cartridge.

☞ “Replacing Ink Cartridges” on page 48

☞ “Replacing the Maintenance Cartridge” on page 56

When the scrap paper box is removed and the cartridge cover is open

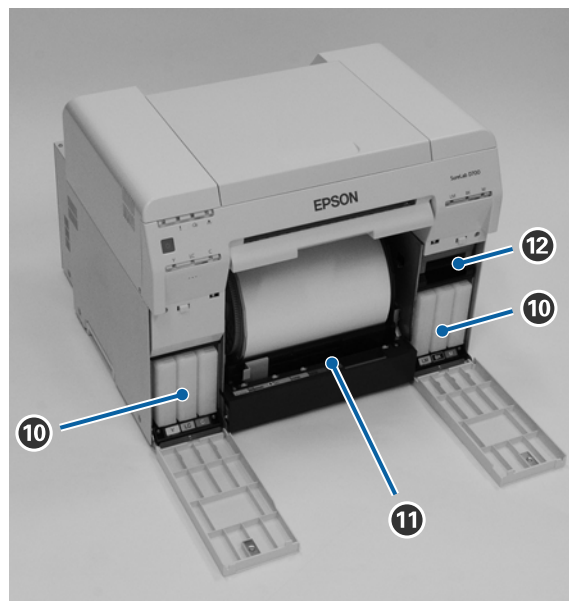

10 Ink cartridges

Install six color ink cartridges.

11 Roll paper feeder

Pull it to the front when removing the spindle unit.

12 Maintenance Cartridge

Before Use

Container that holds the waste ink fluid.

 [“Replacing the Maintenance Cartridge” on page 56](#)

Before Use

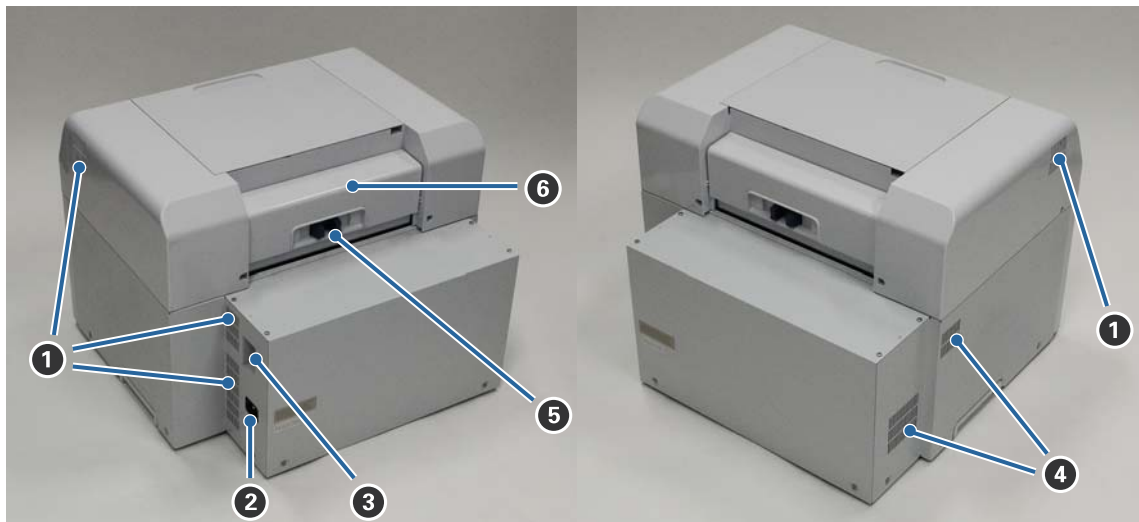
Rear

- 1 Exhaust vent**
Exhausts air used to cool the printer internally.
- 2 AC inlet**
Connects the power cord to the printer.
- 3 USB port**
Connect the USB cable here.
- 4 Airflow vent**
Takes in air to cool the printer internally.
- 5 Lock lever**
Releases the lock for the rear cover.
- 6 Rear cover**
Open when a paper jam occurs or to perform maintenance.

Before Use

Feeding Unit

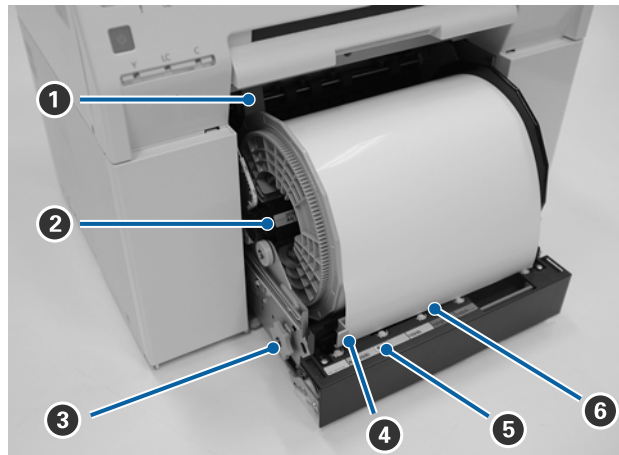
**1 Inner edge guide**

Matches the width of the roll paper.

2 Spindle unit

Loads the roll paper.

3 Handle

Turn this to rewind roll paper onto the spindle unit.

4 Front edge guide

This guide allows you to insert paper into the paper slot. Match the guides to the width of the paper.

5 Paper light (blue)

Indicates the paper insertion status for the roll paper feeder.

On: Paper has been inserted into the roll paper feeder correctly.

Off: Paper has not been loaded.

6 Paper slot

Insert the leading edge of the roll paper here when loading.

Before Use

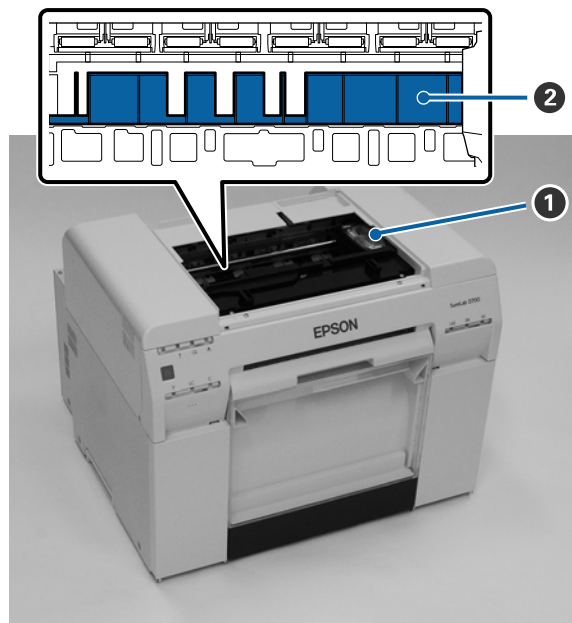
Print head unit
**1 Print head unit**

Fires ink while moving left and right to print. Do not move the print head unit manually with too much force. Otherwise, it may breakdown.

2 Platen

Clean the platen if the back of the printed paper is dirty.

 [“Cleaning the Platen” on page 63](#)

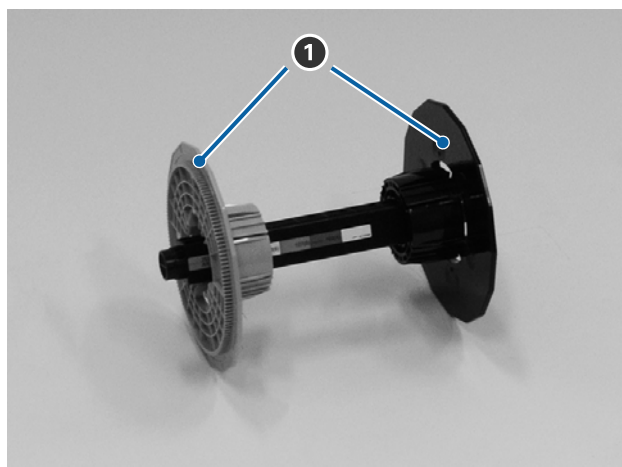
Spindle unit
**1 Flange**

Insert into the ends of the roll paper's roll core on the left and right to secure it.

Before Use

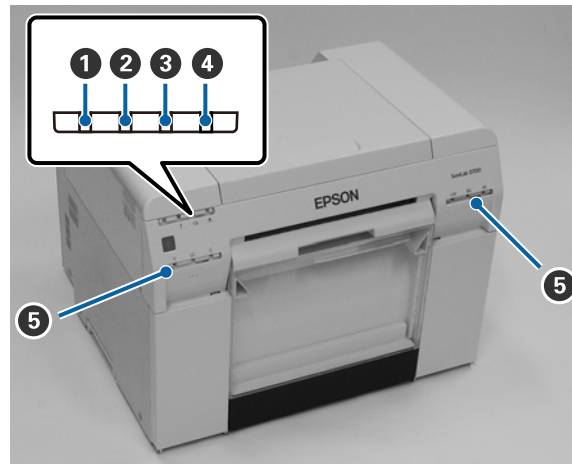
Lights

1  **light (blue)**

The printer's operational status is indicated by a lit or flashing light.

On: The printer is ready to print.

Flashing: The printer is printing, initializing, performing maintenance, and so on.

Off: The printer is not on, or printer operations have stopped due to an error.

2  **light (orange)**

The printer's error status is indicated by a lit light.

On: An error has occurred, the printer is performing error recovery operations, or a printer system error has occurred.

Off: No error.

3  **light (orange)**

Indicates the status of the roll paper feeder.

On: Paper has not been loaded in the roll paper feeder, or the paper is out.

Flashing: A paper jam has occurred.

Off: No error.

4  **light (orange)**

Indicates the status of the maintenance cartridge.

On: Printing cannot be performed because there is not enough free space in the maintenance cartridge, or an error has occurred because the maintenance cartridge was not recognized correctly.

 [“Replacing the Maintenance Cartridge” on page 56](#)

Before Use

Off: No error.

5 Ink light (orange)

Indicates the status of the ink cartridges.

On: Printing cannot be performed because the light is on indicating that there is not enough ink in the ink cartridge, or an error has occurred because the ink cartridge was not recognized correctly.

 [“Replacing Ink Cartridges” on page 48](#)

Off: No error.

Before Use

Safety Instructions

To use this printer safely, be sure to read the manual supplied with the printer before use. Not handling this printer as described in the supplied manual could cause a breakdown of the printer or an accident. To resolve any unclear points regarding the printer, keep this manual on hand at all times.

Meaning of Symbols and Marks

The symbols on this Epson product are used in order to ensure safety and proper use of the product and to prevent danger to customers and other persons, and property damage.











The symbols indicate the meaning below. Be sure that you completely understand the meaning of symbols on this product before using it.

 **Warning:**

This symbol indicates information that, if ignored, could possibly result in serious injury or even death due to incorrect handling.



 **Caution:**







This symbol indicates information that, if ignored, could possibly result in bodily injury or damage to property due to incorrect handling.

| | | | |
|---|---|---|---|
|  | Indicates that your hand could get trapped. |  | Indicates that the printer must not get wet. |
|  | Indicates prohibited (do not do) actions. |  | Indicates items (instructions/operations) that must be performed. |
|  | Indicates that disassembly is prohibited. |  | Indicates that the power plug must be unplugged. |
|  | Indicates that you must not touch the printer with wet hands. |  | Indicates that the printer must be earthed. |
|  | Indicates that specific parts must not be touched. |  | Stand-by |
|  | Alternating Current | | |





Before Use

Notes on Installation







|  Warning | |
|--|---|
|  | <p>Do not block the printer's airflow vents.</p> <p>If the airflow vents are blocked, the internal temperature rises and could cause a fire.</p> <p>Do not cover with a cloth or other materials and do not install in an area with poor ventilation.</p> <p>Also, be sure to secure the installation space indicated in the manual.</p> <p> "Necessary space" on page 105</p> |









|  Caution | |
|--|--|
|  | <p>Do not install or store in a location that is unstable or subject to vibrations from other equipment.</p> <p>If it falls, an injury could occur.</p> |
|  | <p>Do not install it in smoky or dusty locations, humid locations, or locations where it is likely to get wet.</p> <p>Electric shock or fire could occur.</p> |
|  | <p>When lifting this printer, make sure you use the correct posture.</p> <p>If you do not use the correct posture, an injury could occur.</p> |
|  | <p>When lifting the printer, hold it in the areas indicated in the manual.</p> <p>The printer may fall if you lift it by holding other areas, and your fingers could be caught which may cause an injury.</p> <p>See the following for more information on lifting the printer.</p> <p> Setup Guide</p> |
|  | <p>If you place the printer on a stand with casters (wheels), make sure you secure the casters to prevent them from moving before starting operations.</p> <p>If the stand moves unexpectedly during operations, an injury could occur.</p> |

Notes on Handling

|  Warning | |
|--|---|
|  | <p>Do not use in locations with volatile substances such as alcohol and thinner, or in locations with fires.</p> <p>Electric shock or fire could occur.</p> |
|  | <p>Do not use the printer if you notice smoke, strange odors, or sounds.</p> <p>Electric shock or fire could occur.</p> <p>If an abnormality occurs, turn off the printer immediately, unplug it from the electrical outlet, and contact your local dealer.</p> |
|  | <p>Do not use this printer if foreign materials, water, or other liquids have entered the printer.</p> <p>Electric shock or fire could occur.</p> <p>Turn off the printer immediately, unplug it from the electrical outlet, and contact your local dealer.</p> |

Before Use









|  Warning | |
|--|--|
|  | Except as instructed in the manual, do not disassemble the printer. |
|  | Making repairs yourself is extremely dangerous and must not be attempted. |
|  | Do not use the printer in locations where inflammable or explosive gas and so on may be present in the atmosphere. Also, do not use sprays containing inflammable gas inside or around this printer. A fire could ignite. |
|  | Except as instructed in the manual, do not perform any other wiring. A fire could ignite. Other connected equipment could also be damaged. |
|  | Except as instructed in the manual, do not touch any other parts inside this printer. Electric shock, burns, or injury could occur. |
|  | Do not insert or drop any metallic or flammable objects into this printer through the openings. Electric shock or fire could occur. |

|  Caution | |
|--|---|
|  | Do not climb on the printer and do not place any heavy objects on the printer. If it falls or breaks an injury could occur. |
|  | When connecting cables or optional accessories, make sure they are installed in the correct direction and that you follow the procedures exactly. A fire or an injury could occur. Connect the cables or optional accessories correctly by following the instructions in the manual. |
|  | When moving the printer, turn it off, unplug the power cable from the electrical outlet, and make sure that all cables have been disconnected. If cables and so on are damaged, electric shock or fire could occur. |
|  | Do not put your fingers near the paper roller section when the printer is on or when it is printing. If your fingers are caught in the paper roller, an injury could occur. Only handle the paper after it has been ejected completely. |
|  | When storing or transporting this printer, do not tilt it, stand it on its side, or hold it upside down. Ink could leak out. |
|  | When opening and closing the covers, do not place your hands near the points where the main unit and the cover join. If your fingers or hands are trapped, an injury could occur. |
|  | When moving the roll paper feeder in or out, grip the handle. If you place your hands into any other sections, either side of your hand or fingers could be injured. |

Before Use

Notes on the Power Supply

⚠ Warning

| | |
|---|---|
|  | Use only the type of the power supply indicated on the label. Electric shock or fire could occur. |
|  | Do not use the power plug if any foreign materials such as dust are stuck to it. Electric shock or fire could occur. |
|  | Make sure the blades of the power plug are fully inserted into the electrical outlet. Electric shock or fire could occur. |
|  | Do not use the power cable if it is damaged. Electric shock or fire could occur. Contact your local dealer if the power cable is damaged. Note the following points to avoid damaging the power cable. <ul style="list-style-type: none"> <input type="checkbox"/> Do not modify the power cable <input type="checkbox"/> Do not put heavy objects on the power cable <input type="checkbox"/> Do not bend, twist, or pull <input type="checkbox"/> Do not place it near heating appliances |
|  | Do not plug in or unplug the power cable with wet hands. Electric shock could occur. |
|  | Do not perform daisy-chain wiring for the power cable. It could overheat and cause a fire. Take power directly from a residential electrical outlet. |
|  | Unplug the power cable periodically and clean between the blades and the base of the blades. If the power cable is left plugged in for an extended period of time, dust could accumulate around the edge of the plug which could cause a short-circuit and a fire. |
|  | When unplugging the power cable from the electrical outlet, grasp the plug itself and not the cable. The cable could be damaged or the plug could be deformed and an electric shock or fire could occur. |
|  | Make sure the printer is earthed to prevent accidental short circuits. If the printer is used without being earthed, an electric shock or fire could occur. Attach the earth wire for the power cable to one of the following points. <ul style="list-style-type: none"> <input type="checkbox"/> The earth terminal on the electrical outlet <input type="checkbox"/> Copper wire and so on that has been buried at least 65 cm underground. <input type="checkbox"/> An earth terminal for which grounding has been performed When attaching or removing the earth wire, the power plug must be removed from the electrical outlet. Check the earthing for the electrical outlet being used. If you cannot perform earthing, contact your local dealer. |

Before Use

⚠ Warning





| | |
|---|---|
|  | <p>Do not connect the earth wire to the following points.</p> <ul style="list-style-type: none"> <input type="checkbox"/> Gas pipes (they could ignite and cause an explosion) <input type="checkbox"/> Earth wires for telephone wires or lightning rods (this is dangerous as a lightning strike causes a huge surge in electricity) <input type="checkbox"/> Water pipes or faucets (earthing is not performed if there is any plastic piping in the pipes) |
|---|---|

⚠ Caution

| | |
|---|--|
|  | <p>For safety reasons, when the printer is not used for an extended period of time, unplug the power cable from the electrical outlet.</p> |
|---|--|

Notes on Consumables

⚠ Caution

| | |
|---|--|
|  | <p>If ink gets in the eyes or mouth, or stains the skin, treat the area as follows.</p> <ul style="list-style-type: none"> <input type="checkbox"/> If ink adheres to your skin, immediately wash it off using soapy water. <input type="checkbox"/> If ink enters your eyes, rinse immediately with water. Failure to observe this precaution could result in bloodshot eyes or mild inflammation. If you notice any abnormalities, consult a physician immediately. <input type="checkbox"/> If ink enters your mouth, consult a physician immediately. |
|  | <p>Do not disassemble ink cartridges and the maintenance cartridge. If it is disassembled, ink could get in your eyes or adhere to your skin.</p> |
|  | <p>Do not shake the ink cartridges too hard. Ink may leak from the cartridge if you shake it too hard.</p> |
|  | <p>Do not rub the edges of the printing paper with your hand. The edges of the paper are thin and sharp and could cause an injury.</p> |
|  | <p>Do not store ink cartridges and the maintenance cartridge within the reach of children.</p> |

Other Notes

- Be sure your power cable meets relevant safety standards of the area where you plan to use it.
- Connect all equipment to properly grounded power outlets.
- Do not put your hand inside this product or touch the printer head during printing.
- Do not put your hand inside this product or touch the white flat cable during printing.

Before Use

Notes on Usage

Notes when Handling the Main Unit

- Do not suddenly change the temperature in the room where this printer is installed. If the temperature changes suddenly, drops of water (condensation) could occur inside the printer which may have an adverse effect on operations.
- Use the printer in an environment with a temperature of 10 to 35°C, and a humidity of 20 to 80%. When the printer is placed on a system rack, make sure the environment of the rack is within these ranges.
- Do not place any containers containing water, such as vases or cups, on the printer. If water enters the printer, it may breakdown. Also, do not put any heavy objects on the printer.
- The printer is equipped with several airflow vents. The airflow vents allow air to go in and out of the printer. Do not block these airflow vents by placing any objects near them, or by covering them with film sheets or paper.
- Do not use accessories designed for this printer with any other products.
- If the printer's covers are opened during printing, a safety device is activated and printing is stopped automatically. Do not turn off the printer in this condition. This could cause the print head nozzles to dry and print quality to decline.
- Depending on the performance of the computer being used, the printer stops printing temporarily; however, this is not a malfunction.
- If the printer is not used for an extended period of time, make sure you leave the ink cartridges and maintenance cartridge installed.
- Do not leave the printer for more than three days in a state in which the power was turned off due to a power outage and so on. Paper may curl which could cause a decline in printer performance.
- Contact our service support when transporting the printer.

Notes on the Paper

Notes on Handling

Use paper recommended by our company.

Note the following points when handling the paper.

- Do not bend the paper or scratch the surface of the printable side.
- Do not touch the printable side of the paper. Moisture and oil from hands can have an adverse effect on the print quality.
- Handle the paper by the edges. We recommend wearing cotton gloves.
- Do not throw away the paper packaging as you can use it for storing the paper.
- Do not wet the paper.

Before Use

- ❑ Do not use paper that is wrinkled, scuffed, torn, or dirty.
- ❑ If the printer is left with paper loaded for some time, the leading edge of the paper may curl and print quality may decline. We recommend removing paper from the printer when it is not in use.

Before Use

Notes on storage

Before and after opening the paper, store it in an environment that is not subject to direct sunlight and meets the following conditions. If paper is not being used after it has been opened, remove it from the spindle unit and wind it up before storing.

Notes on printing

Make sure that the leading edge of the paper is perpendicular to the long side and cut completely straight.

Storing and displaying print outs

- Make sure you do not rub or scratch the printed side.
- Avoid locations that are subject to high temperature, humidity, and direct sunlight, and store in a dark place.
- Avoid displaying print outs outdoors or in direct sunlight. This may accelerate the fading.
- When displaying print outs indoors, we recommend placing them in glass frames and so on. This allows you to display your print outs for a long time without them fading.

Notes on Ink Cartridges

- If you move the ink cartridges from a cold place to a warm place, leave them at room temperature for more than four hours before use.
- We recommend that ink cartridges be stored in a cool location and used before the expiry date printed on the packaging. Also, the ink cartridges should be used within six months of opening.
- Do not touch the ink supply port on the ink cartridge or its surrounding area. Ink may leak from it.
- The ink level and other data are stored in the IC chip, allowing ink cartridges to be used after being removed and replaced.
- To avoid getting dirt on the ink supply port, store the removed ink cartridge properly. The ink supply port has a valve in it so it does not need to be capped.
- Removed ink cartridges may have ink around the ink supply port, so be careful not to get any ink on the surrounding area when removing the cartridges.
- Do not touch the green section (IC chip) on the ink cartridge. Doing so may affect normal operation and printing.
- Do not drop or knock ink cartridges against hard objects; otherwise, the ink may leak.
- Even while nothing is printed, the printer uses ink from all cartridges during head cleaning and other maintenance operations to keep the print head in good condition.
- Although the ink cartridges may contain recycled materials, this does not effect printer function or performance.
- Do not leave the printer without ink cartridges installed. The inks inside the printer may dry and you may not be able to print. When you are not using the printer, make sure there is an ink cartridge installed in each slot.
- Install ink cartridges into each slot. You cannot print if any of the slots are empty.

Before Use

- ❑ To maintain the quality of the head, the printer stops printing before ink cartridges are completely expended; therefore, some ink is left in used cartridges.
- ❑ Do not dismantle or remodel ink cartridges. You may not be able to print properly.

Disposing of Used Ink Cartridges and Maintenance Cartridges

Dispose of consumables and optional parts in accordance with your local laws and statutes, such as by entrusting them to an industrial waste disposal company.

Introducing the Software

You need to install the printer driver on your computer to use the printer.

| Software Name | Summary |
|------------------|--|
| Printer Driver | This software allows you to print using the printing instructions from another application. 🔗 "Printer Driver Operation Guide" |
| Maintenance Tool | This software allows you to perform adjustment and maintenance operations such as checking the printer's status, making settings, performing head cleaning and so on. This is installed with the printer driver. 🔗 "Maintenance Tool Operation Guide" |

Printing Methods

Basic Printing Methods

Open the printer driver screen on the connected computer, and then make settings such as the Paper Type and Paper Size.

See the "Printer Driver Operation Guide" for more details on the printer driver.

- 1** Load paper into the printer.
 ["Replacing Paper" on page 25](#)
- 2** Display the print screen for the application you are using.
Click **Print** (or **Print...** and so on) from the **File** menu.
Operations may differ depending on the application software being used. See the manual supplied with the application for more details.
- 3** Display the printer driver's screen from the application's print screen.
In Windows, select this printer, and then click **Print Settings** (or **Detailed Settings** or **Properties**).
On Mac, select this printer, and then select **Print Settings** from the list. You cannot select this from the macOS Sierra standard software.

Printing Methods

4 Make the necessary settings.

Paper Type: Set the paper being used.

Image Quality (print quality): Normally set **Standard**. If you want to print using high image quality, set **High Image Quality**. If you want to print quickly, set **High Speed**.

Paper Size: Set the size of the paper used for printing.

Windows:

Mac:

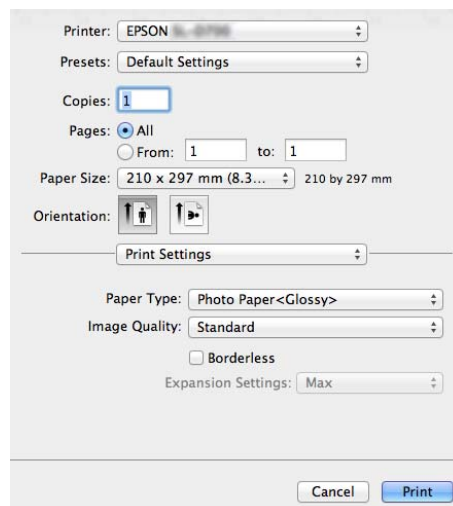
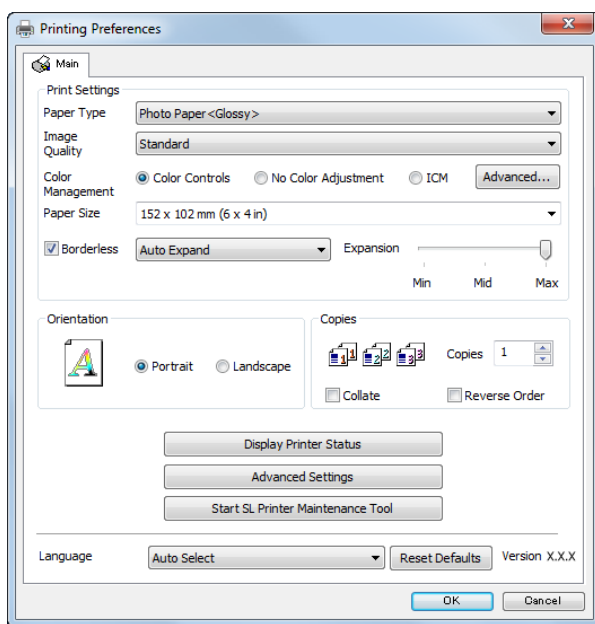

See the "Printer Driver Operation Guide" for an explanation of each setting item.

5 When you have finished making settings, click **OK**.

6 On the application's print screen, click **Print** (or **Print...** and so on) to start printing.

Replacing Paper

Replacing Paper

This section explains how to remove paper from the roll paper feeder, and load new paper.

Important:

Make sure the Paper Type setting in the Maintenance Tool matches the paper being loaded. Change the Paper Type setting straight after replacing paper.

 [“Changing Paper Settings” on page 38](#)

Note:

If the leading edge of the paper is ragged, cut it in a straight line with a pair of scissors and so on, and then load.

See the following for supported paper types.

 [“Printer Specifications” on page 103](#)

The following conditions are necessary when replacing paper with the same paper width and type.

Before replacing, note the current paper level.

When replacing paper, the paper level after replacement is set with the Maintenance Tool.

If the Paper Level is not set correctly, the level displayed may not be correct.

 [“Changing Paper Settings” on page 38](#)

You can load paper with a width of 102 to 210 mm in the roll paper feeder.

How to replace

Preparing to Replace Paper

Prepare the following items.

| Item Prepared | Explanation |
|-----------------------|---|
| New paper for loading | - |
| Cloth or vinyl rug | Spread it out where the spindle unit will be loaded/removed so that the paper does not become soiled. |
| Soft cloth | Clean the edges of the paper before installing. |
| Gloves | Wear when handling paper so that the paper does not become soiled. |

Replace paper in the following order. Follow the steps for each procedure.

[“Recording paper level” on page 27](#)

[“Removing the Spindle Unit” on page 29](#)

[“Removing the Roll Paper” on page 31](#)

Replacing Paper

- ❑ [“Attaching the Roll Paper” on page 32](#)
- ❑ [“Attaching the Spindle Unit” on page 33](#)
- ❑ [“Changing Paper Settings” on page 38](#)

Replacing Paper

Recording paper level

If necessary, make a note of the paper level before replacing the paper.

Windows

- 1 Display the printer driver's Main screen.
[“Basic Printing Methods” on page 23](#)

- 2 Click **Display Printer Status**.

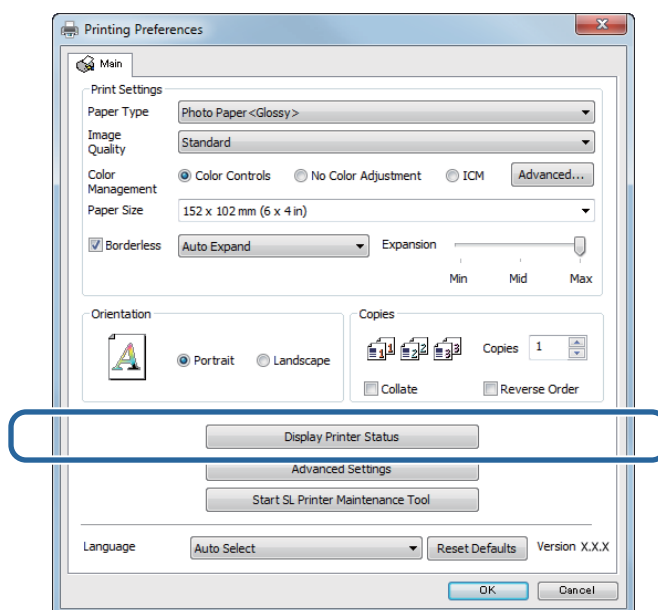

- 3 Make a note of the Paper Level from Paper Setup from Printer.

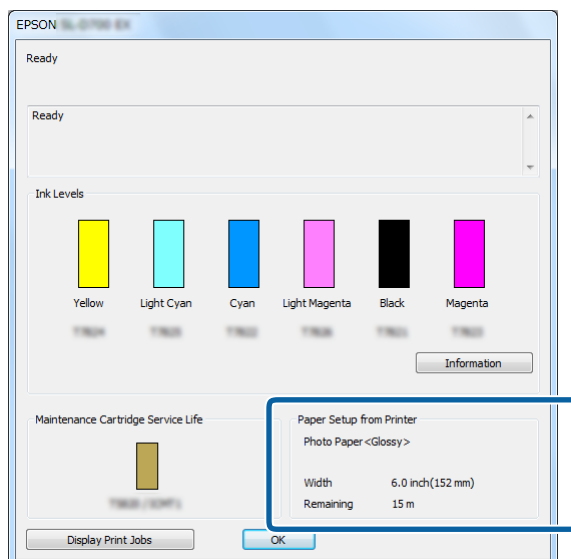

Replacing Paper

Mac

- 1 Start the Maintenance Tool.
See the following for information on starting the Maintenance Tool.
[🔗 “Error Messages \(Mac\)” on page 71](#)

- 2 Click **Printer Window** on the main screen.

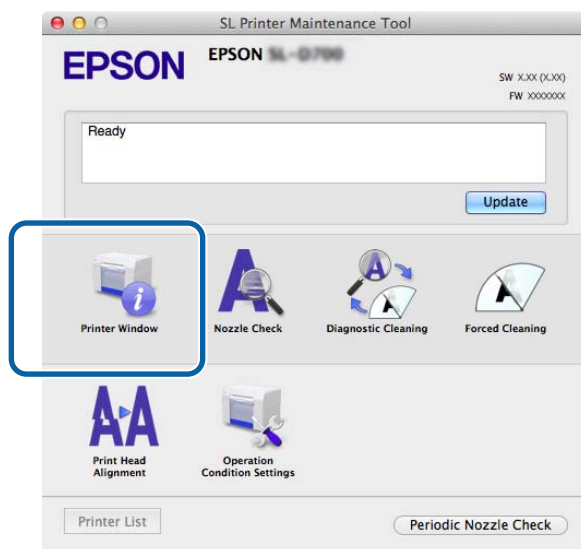

The **Printer Window** screen is displayed.

- 3 Make a note of the Paper Level from Paper Setup from Printer.

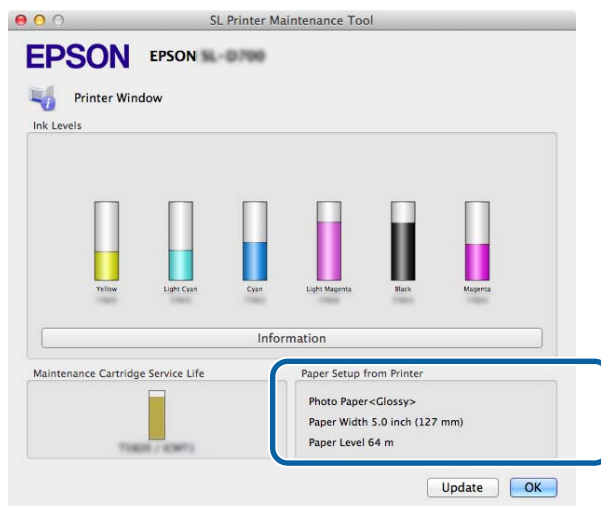

Replacing Paper

Removing the Spindle Unit

! **Important:**

When the  light is lit and paper is ejected from the eject slot, there is no remaining paper. Pull out the paper from the eject slot.



1



Check that the printer's  light is on.

If the  light is flashing, the printer is operating. Wait until all operations have stopped.

! **Important:**

Make sure the power is on before replacing paper.

2

Press the  switch and wait until the  light turns on.

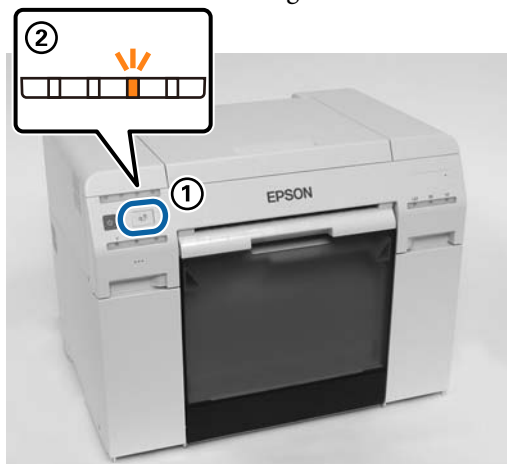

3

Remove the Scrap paper box and empty out the scrap paper.

 [“Emptying the Scrap Paper Box” on page 61](#)

Replacing Paper

- 4 Grip the handle to release the lock, and then pull out the roll paper feeder.

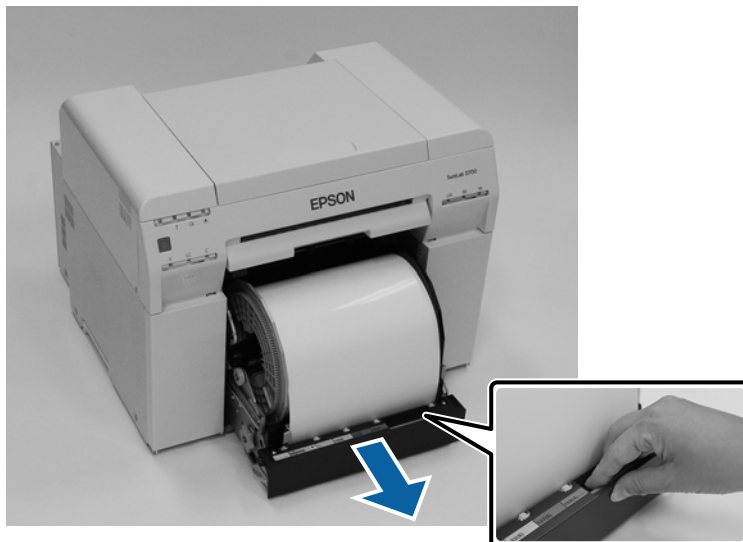

! **Important:**

If you cannot remove the roll paper feeder for some reason, do not try to pull it out by force. Paper may be jammed inside. When you can access the top and rear of the printer, remove the paper by following the procedure in "Paper is Jammed in the Internal Paper Feeder".

☞ "Paper is Jammed in the Internal Paper Feeder" on page 92

Contact your local dealer if you cannot access the top or rear of the printer.

- 5 Remove the spindle unit.

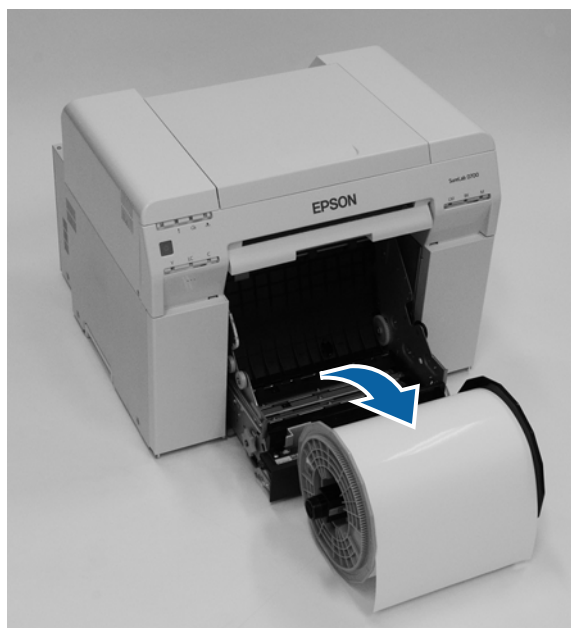

Replacing Paper

Removing the Roll Paper

- 1 Stand the spindle unit on a flat surface and remove the upper flange.

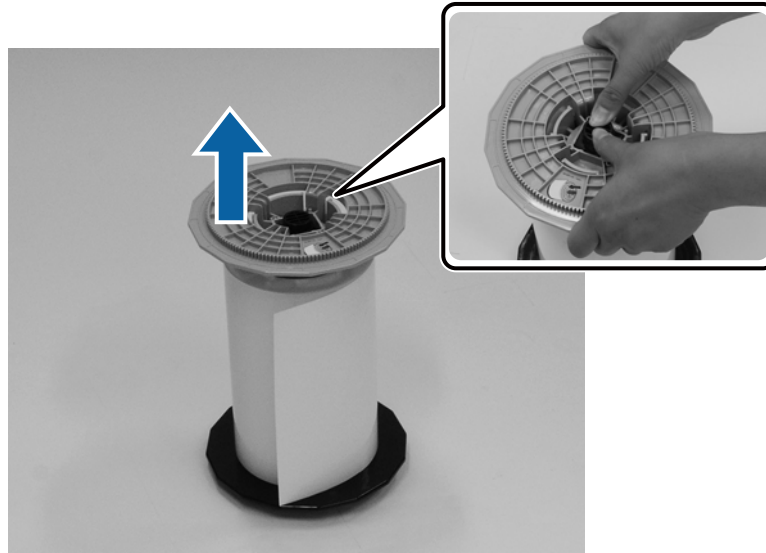

- 2 Remove the paper.

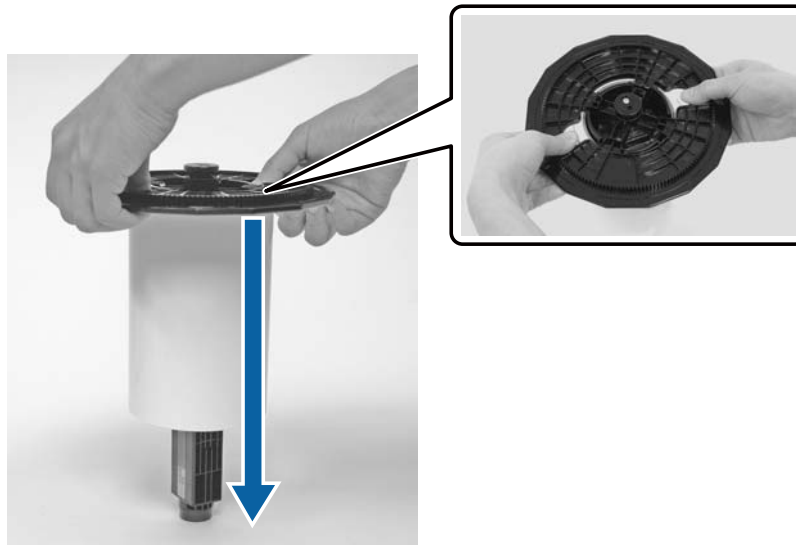

Note:

After carefully rewinding the paper, store it in the Paper Case (optional) or wrap it in the original packaging bag and store it in a box.

Replacing Paper

Attaching the Roll Paper

- 1 Remove the new paper from its packaging, and stand it on a flat surface. Wipe the edge of the paper with a soft cloth several times to remove any dirt such as paper powder.

Stand the paper so that the winding direction of the paper counter-clockwise when viewed from above.



- 2 Turn the paper upside down, and then place it on the spindle unit.

Place the core over the spindle unit so that the winding direction of the paper is clockwise when viewed from above.

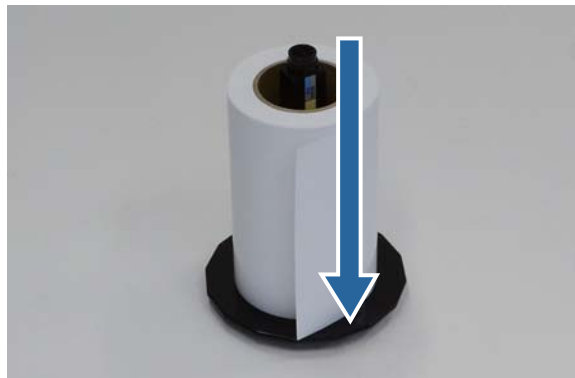

- 3 Wipe the edge of the paper with a soft cloth several times to remove any dirt such as paper powder.



Replacing Paper

- 4 Insert the flange into the shaft of the spindle unit so that the core of the roll paper is held securely between the top and bottom flanges.

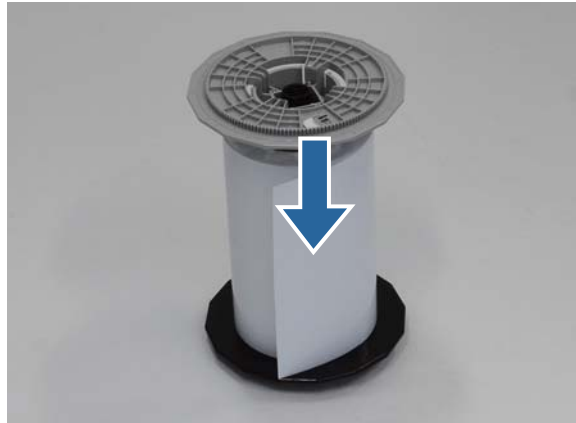

Attaching the Spindle Unit

- 1 Adjust the inner edge guide of the roll paper feeder to the width of the paper.
To adjust the position of the inner edge guide, lift it towards you slightly and move it to the left or right. Match the triangle mark on the inner edge guide to the scale. The scale is in millimeters (inches in parenthesis).

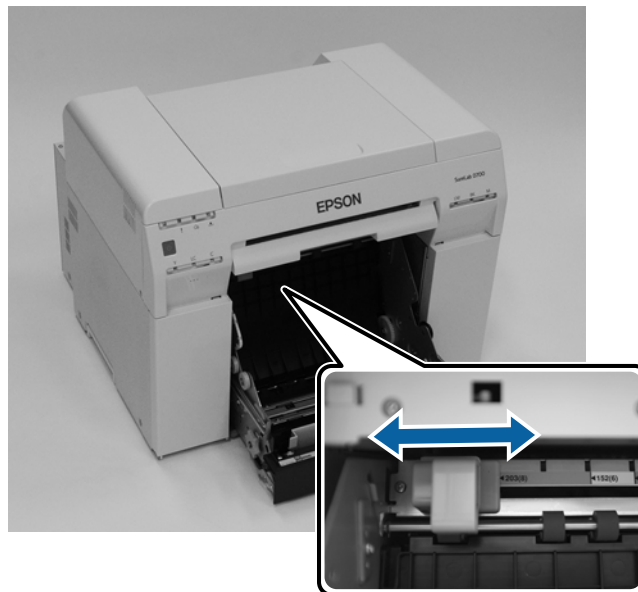

Replacing Paper

- 2** Hold the spindle unit in the orientation shown below, and then place it in front of the roll paper feeder. Remove any tape or protective sheets from the paper. If the leading edge of the paper is ragged, cut it in a straight line with a pair of scissors and so on.



- 3** Load the spindle unit in the roll paper feeder. Check that the shaft of the spindle unit fits into the bearing.

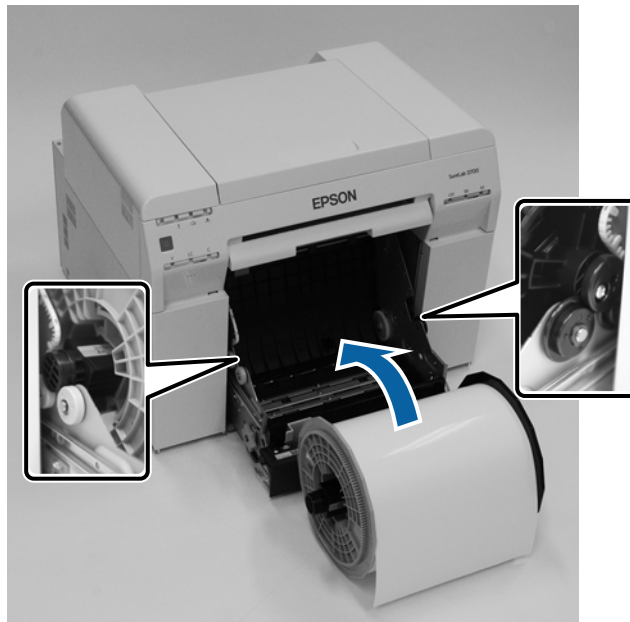

Replacing Paper

- 4** Match the front edge guide to the width of the paper.

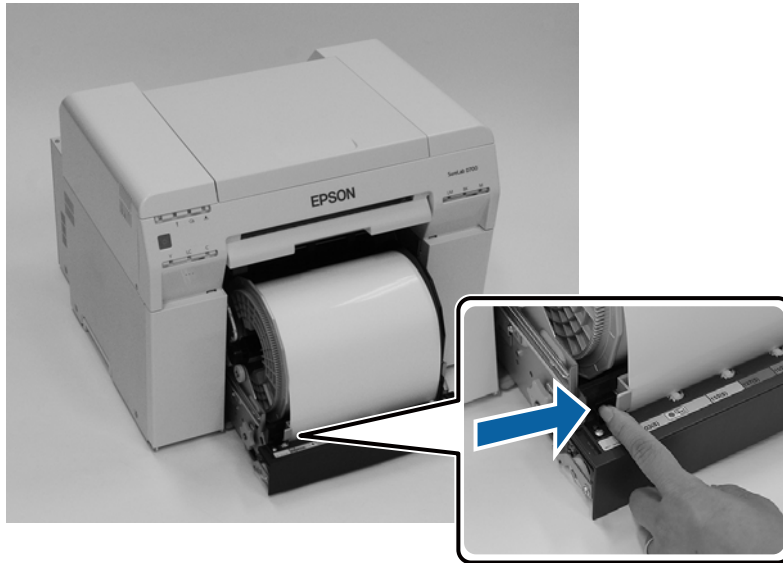

- 5** Insert the leading edge of the paper into the paper feed slot.
Insert the paper until the paper light turns on.

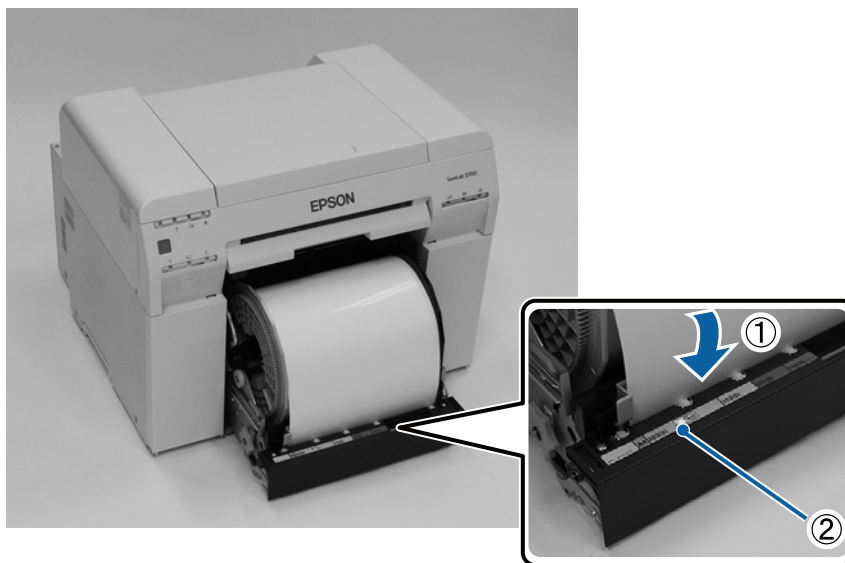

Replacing Paper

Note:

If the paper light does not turn on, turn the handle on the left of the roll paper feeder in the direction indicated by the arrow to remove the paper, and then insert it again.

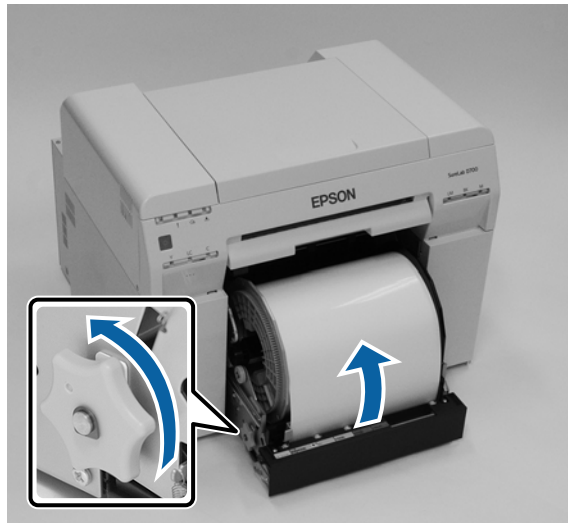

- 6** Push the roll paper feeder all the way into the printer.



- 7** Carefully roll the paper into the printer to take up any slack.



Replacing Paper

! **Important:**

If printing is performed while the paper is slack, print quality may decline, and paper jams could occur. Make sure you take the slack out of the paper.

8

Attach the scrap paper box.

Insert the bottom section of the scrap paper box, and then push the top section into place.

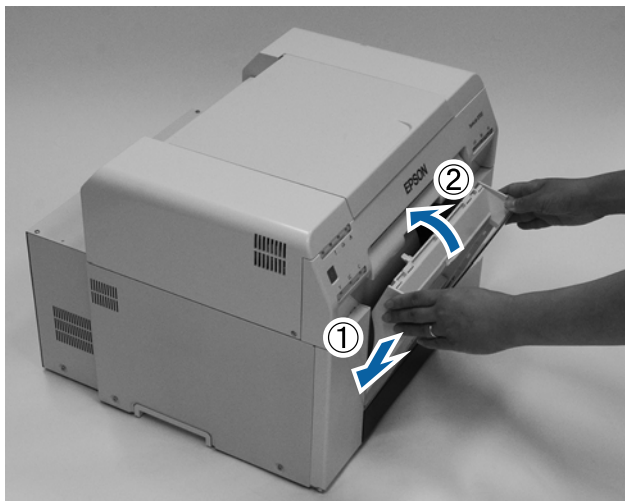

Check that the printer's  light is off.

! **Important:**

If the printer is left with paper loaded for some time, the leading edge of the paper may curl and print quality may decline. We recommend removing paper from the printer when it is not in use.

This completes this section.

Replacing Paper

Changing Paper Settings

After replacing paper, set the Paper Type and the Paper Level in the Maintenance Tool.

See the "Maintenance Tool Operation Guide" for more details on the Maintenance Tool.

Update the paper information as necessary. See the "Maintenance Tool Operation Guide" for more details on updating the information.

Windows

Set the **Paper Type** and **Paper Level** in **Paper Settings - Current media** on the main screen of the maintenance tool, and then click **Set**.

The paper width set in **Paper Width** is displayed.

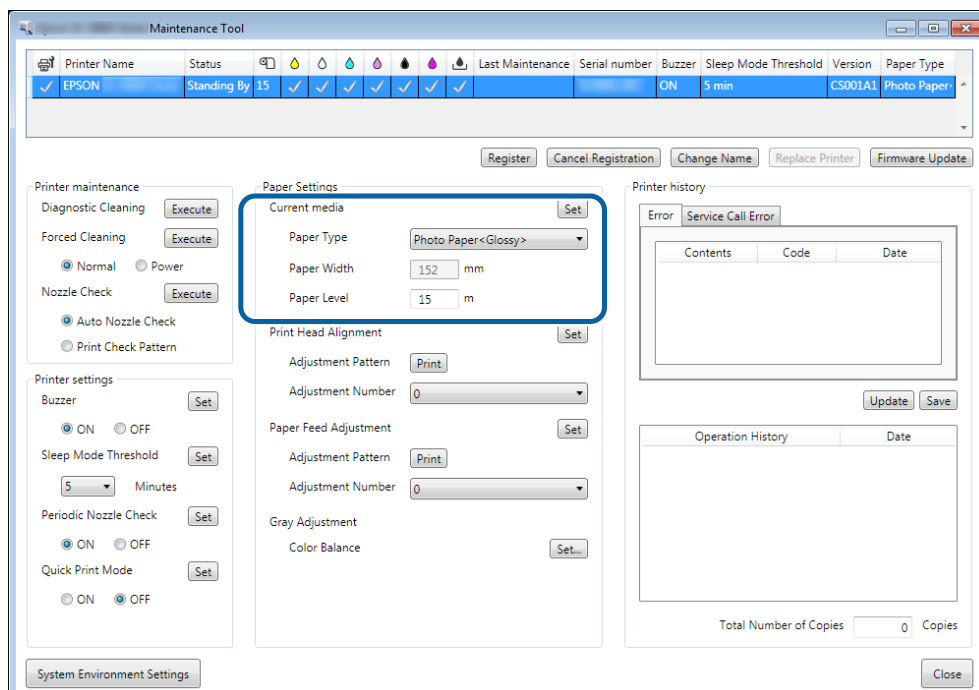

Replacing Paper

Mac

- 1 Click **Operation Condition Settings** on the Maintenance Tool's main screen.

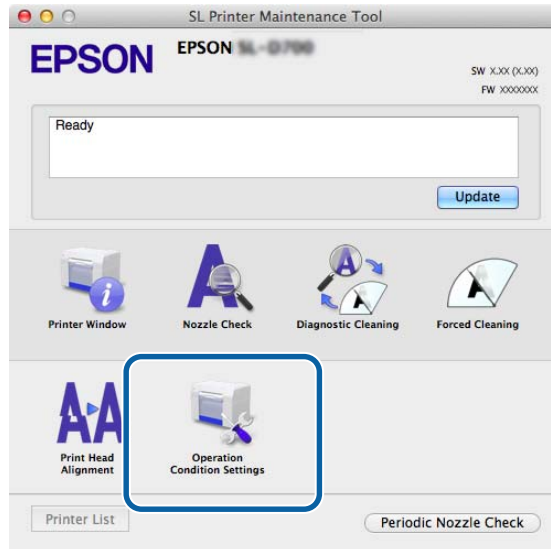

- 2 Select **Change the paper type and the paper remaining**.
When this is selected, you can change the **Paper Type** and **Paper Level**.

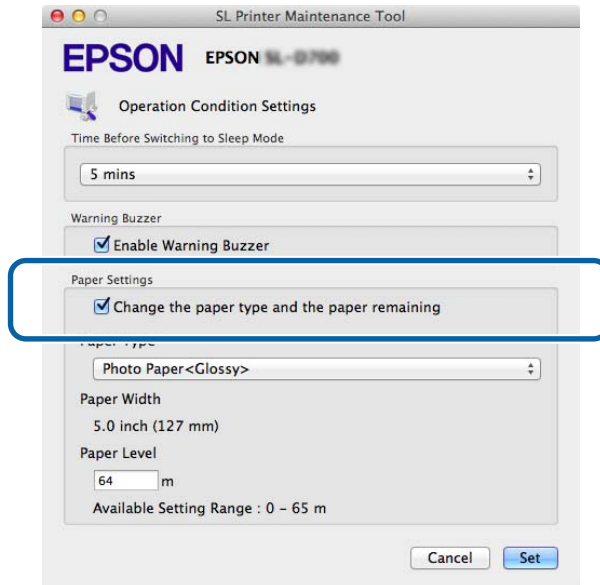

Replacing Paper

- 3 Set the **Paper Type** and the **Paper Level**, and then click **Set**.
The paper width set in **Paper Width** is displayed.

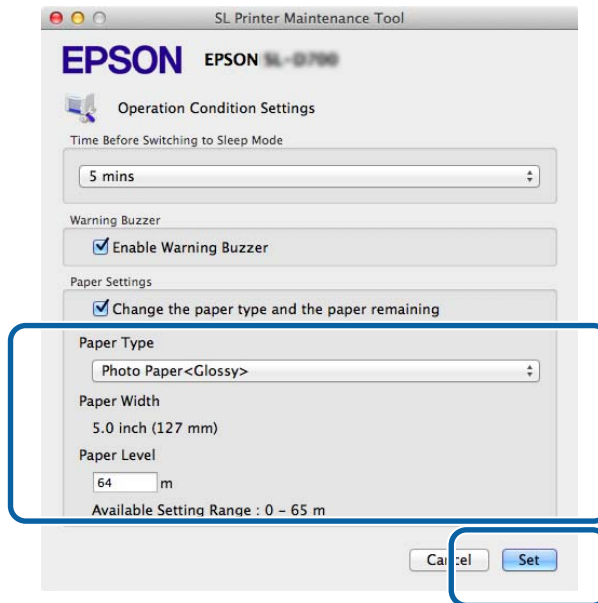

This completes this section.

Ejecting Paper

Ejecting Paper

Printed paper is ejected from the front of the printer. By attaching the optional print tray, you can collect multiple print outs. See the following for more details.

| Print Size | | Capacity | |
|----------------------|--------------|------------------------|-----------|
| Length ^{*1} | Width | Glossy/Luster | Matte |
| 89 to 102 mm | 50 to 203 mm | 20 copies | 20 copies |
| 102 to 203 mm | | 20 copies | 10 copies |
| 203 to 305 mm | | 5 copies ^{*2} | 1 copies |

*1 For prints longer than 305 mm, remove the print tray, and then eject one copy at a time from the front of the printer.

*2 One copy if the paper warps after printing 30 mm or more.



Ejecting Paper

! **Important:**

- Do not pull paper that is being ejected.
- When paper is being ejected from the front, do not pull it or raise it higher than the eject slot. Otherwise, print quality may decline.



Note:

When removing the scrap paper box, make sure you remove the print tray first.

Print tray (optional)

After printing, the paper is cut to the specified size and ejected to the print tray.



Ejecting Paper

Rigid print tray (optional)

After printing, the paper is cut to the specified size and ejected to the rigid print tray.



Ejecting Paper

Attaching and Removing the Print Tray (Optional)



Attaching

- 1 Tilt to insert the hooks, and then lower to hook it in place.

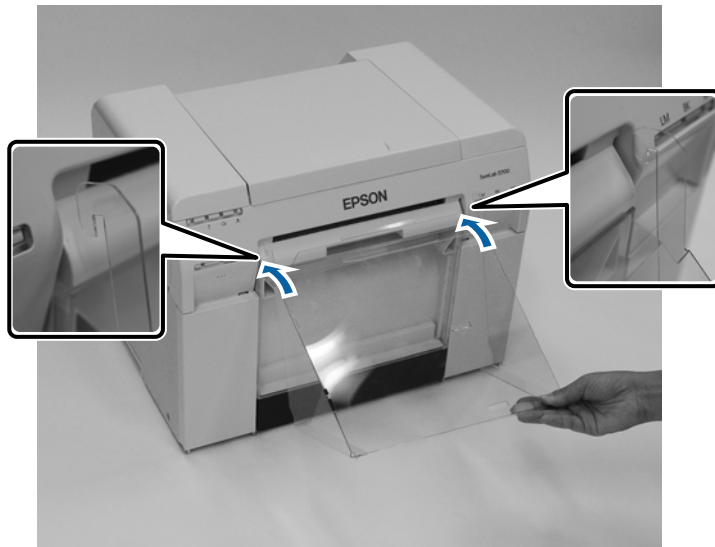

Ejecting Paper

- 2 When the length of the print size is 89 to 102 mm, place the hooks into the top holes.
When the length of the print size is 102 to 203 mm, place the hooks into the bottom holes.

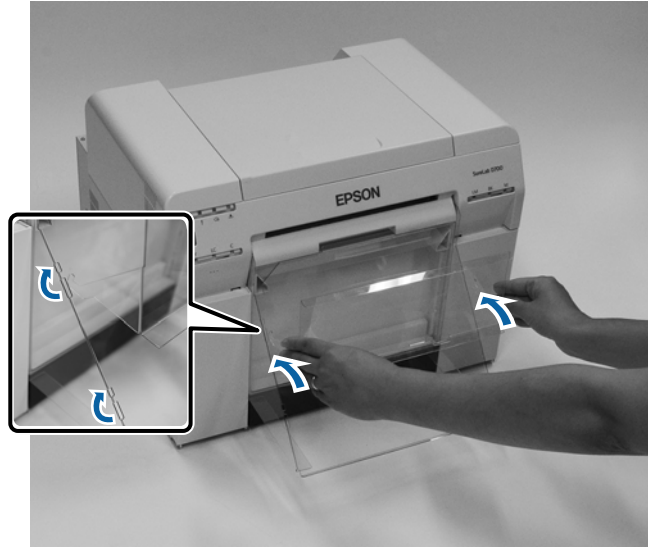

Removing

Perform operations in reverse order from attaching the parts.

Ejecting Paper

Attaching and Removing the Rigid Print Tray (Optional)



Attaching

- 1 Tilt to insert the hooks, and then lower to hook it in place.

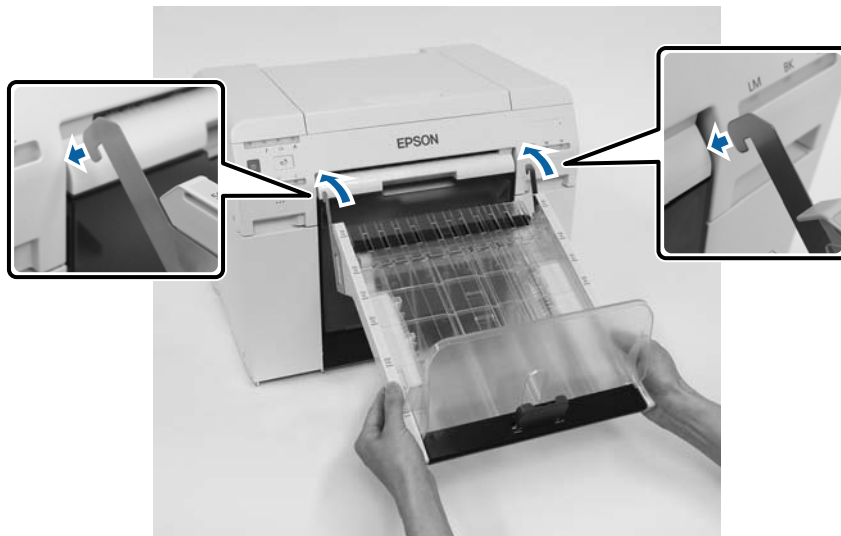

Ejecting Paper

- 2 Pinch the handle and move it to match the length of the printer size.



Removing

Perform operations in reverse order from attaching the parts.

Replacing Ink Cartridges

**Caution:**

- Do not disassemble ink cartridges.
If it is disassembled, ink could get in your eyes or adhere to your skin.
- Do not shake the ink cartridges too hard.
Ink may leak from the cartridge if you shake it too hard.
- Do not store ink cartridges within the reach of children.
- If ink gets in the eyes or mouth, or stains the skin, treat the area as follows.
 - If ink adheres to your skin, immediately wash it off using soapy water.
 - If ink enters your eyes, rinse immediately with water. Failure to observe this precaution could result in bloodshot eyes or mild inflammation. If you notice any abnormalities, consult a physician immediately.
 - If ink enters your mouth, consult a physician immediately.

**Important:**

- See the following points when working with ink cartridges.
[☞ “Notes on Ink Cartridges” on page 21](#)
- If you do not have a new ink cartridge for installation, leave the expended ink cartridge in the printer until the new one is ready. If the printer is left without the ink cartridges, it may malfunction.
- When the ink remaining falls below the minimum value, replace it with a new ink cartridge as soon as possible.
- Do not leave the printer without ink cartridges installed. The inks inside the printer may dry and you may not be able to print. When you are not using the printer, make sure there is an ink cartridge installed in each slot.

Checking Ink Levels

Checking from the Printer

When the ink remaining falls below the minimum value, the ink light on the front of the printer turns on.

[☞ “Front” on page 6](#)

Ink light

Replacing Ink Cartridges

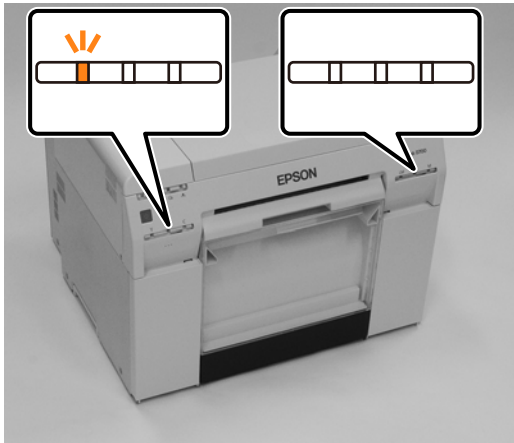

Checking from the Computer

Windows

- 1 Click **Display Printer Status** in the printer driver .

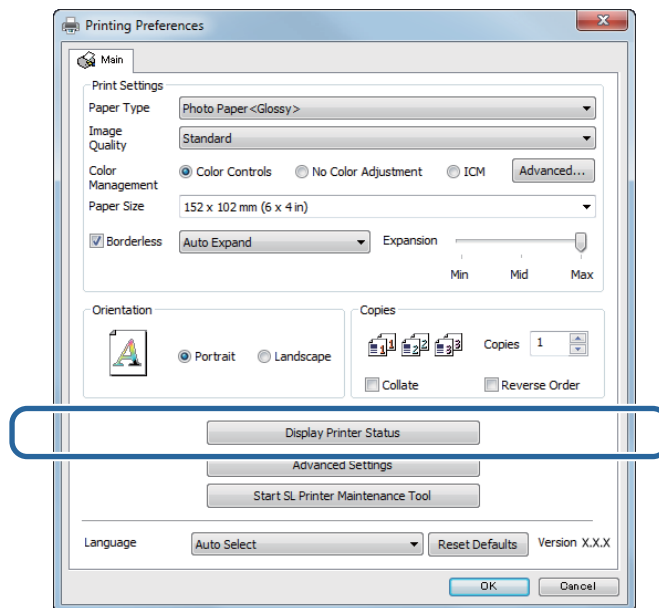

Replacing Ink Cartridges

- 2 Check how much ink remains.

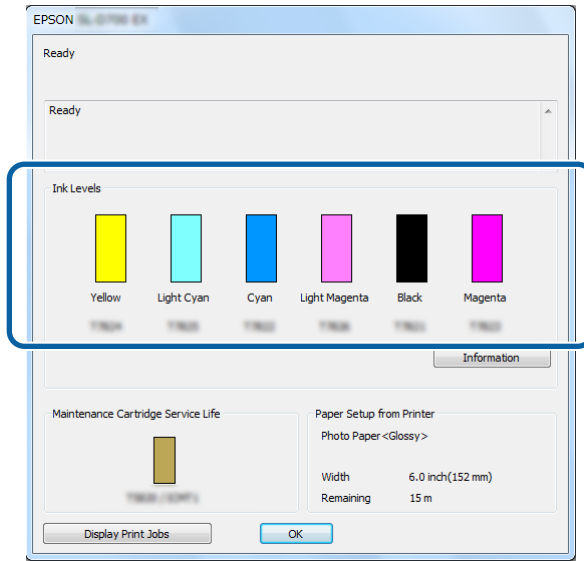

When you have finished checking, click **OK**.

Replacing Ink Cartridges

Mac

- 1 Start the Maintenance Tool.
See the following for information on starting the Maintenance Tool.
[“Error Messages \(Mac\)” on page 71](#)

- 2 Click **Printer Window** on the main screen.

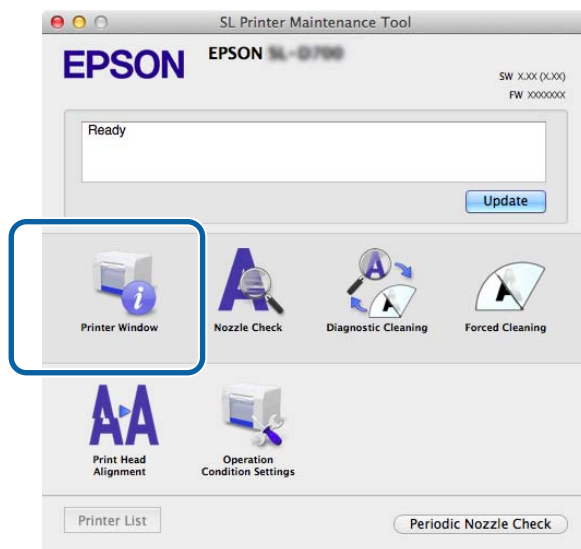

The **Printer Window** screen is displayed.

- 3 Check how much ink remains.

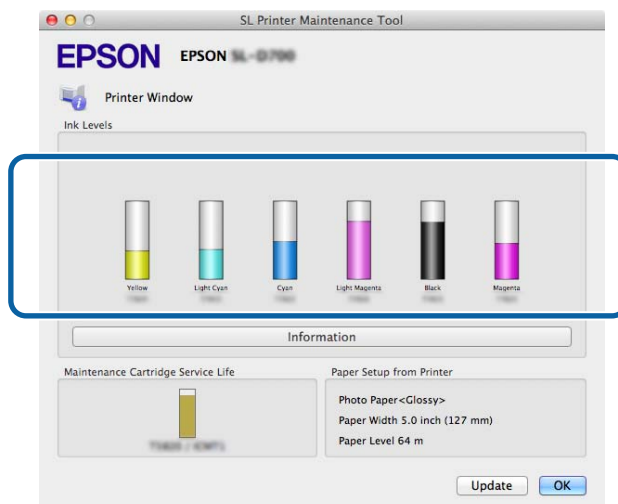



When you have finished checking, click **OK**.

Replacing Ink Cartridges

Replacement Procedure

! *Important:*

- ❑ *Install ink cartridges into each slot. You cannot print if any of the slots are empty.*

- 1 Check that the printer's  light is on.
If the  light is flashing, the printer is operating. Wait until all operations have stopped.
- 2 The ink light indicates if it is necessary to replace the ink cartridges.
In this example we are replacing the Y (yellow) cartridge. The procedure is the same for the other colors.

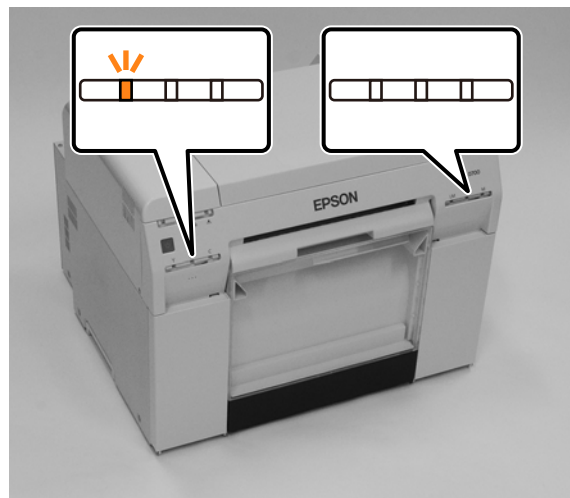

Replacing Ink Cartridges

- 3** Open the cartridge cover on the side that needs to be replaced.
A warning buzzer sounds when you open the cover.



- 4** Press the empty Ink cartridge gently so that it pops out a little, and then remove.
See the following for more information on disposing of ink cartridges.

 [“Disposing of Used Ink Cartridges and Maintenance Cartridges” on page 22](#)

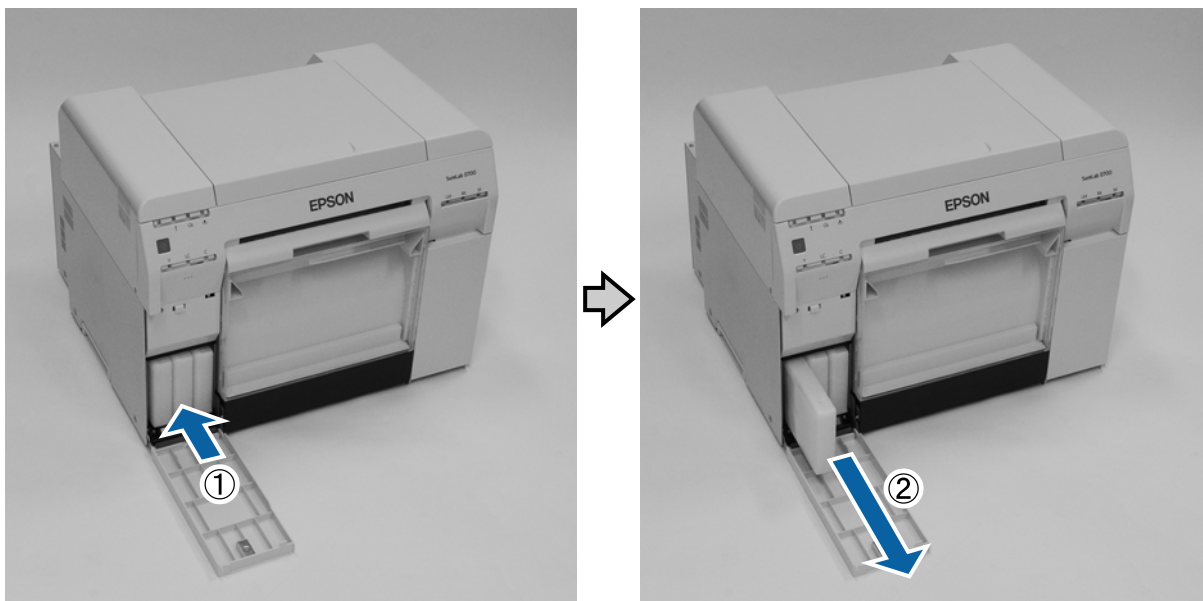

Replacing Ink Cartridges

! **Important:**

Removed ink cartridges may have ink around the ink supply port, so be careful not to get any ink on the surrounding area when removing the cartridges.

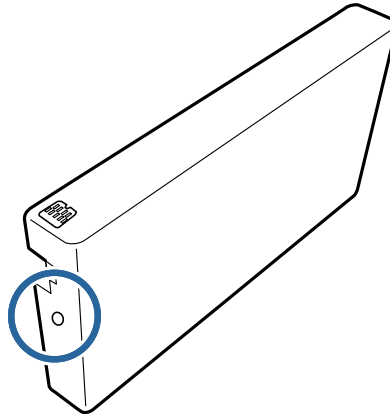

5

Remove the new ink cartridge from the box.

! **Important:**

- Do not touch the chip (A) on the ink cartridge. Doing so may affect normal operation and printing.
- Do not touch the ink supply port (B) on the ink cartridge. Ink could leak out.

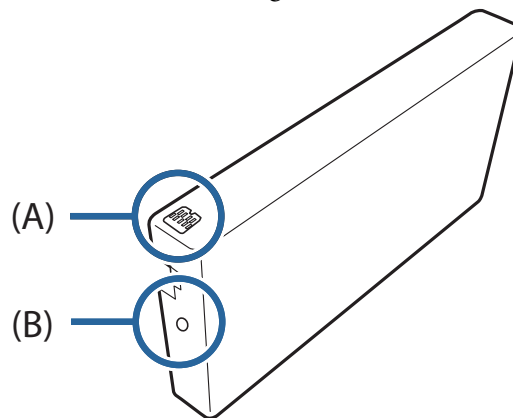

Replacing Ink Cartridges

- 6** Slide the ink cartridge all the way into the printer.



- 7** Close the cartridge cover.



- 8** Check that the printer's  light is on.

This completes this section.

Replacing the Maintenance Cartridge

Replacing the Maintenance Cartridge

The maintenance cartridge absorbs ink consumed during head cleaning.

This section explains how to replace used maintenance cartridges.

 **Important:**

After removing the maintenance cartridge, do not leave the cartridge cover open, install a new cartridge immediately.

Checking the Free Space in the Maintenance Cartridge

Checking from the Printer

When it is time to replace the maintenance cartridge, the printer's  light turns on.

 [“Lights” on page 12](#)

 light



Replacing the Maintenance Cartridge

Checking from the Computer

Windows

- 1 Click **Display Printer Status** in the printer driver.

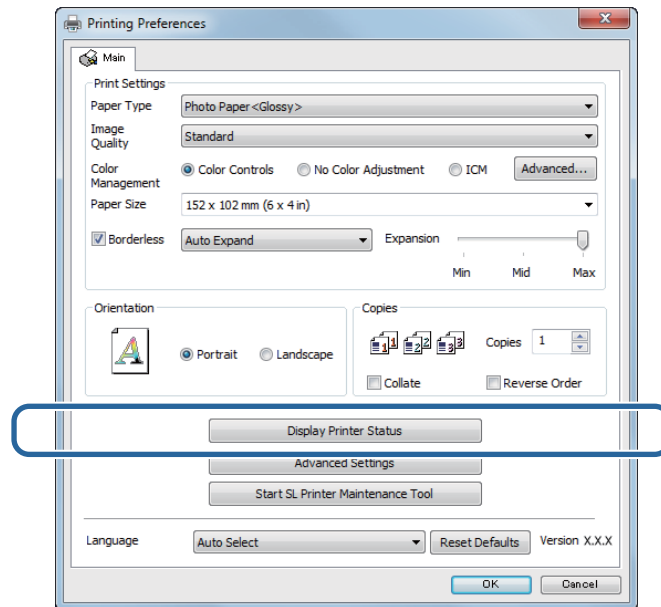

- 2 Check the free space in the maintenance cartridge.

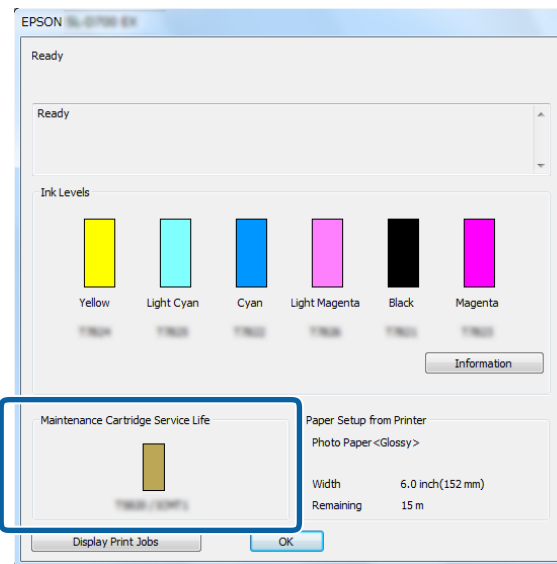

When you have finished checking, click **OK**.

Replacing the Maintenance Cartridge

Mac

- 1 Start the Maintenance Tool.
See the following for information on starting the Maintenance Tool.
[“Error Messages \(Mac\)” on page 71](#)

- 2 Click **Printer Window** on the main screen.

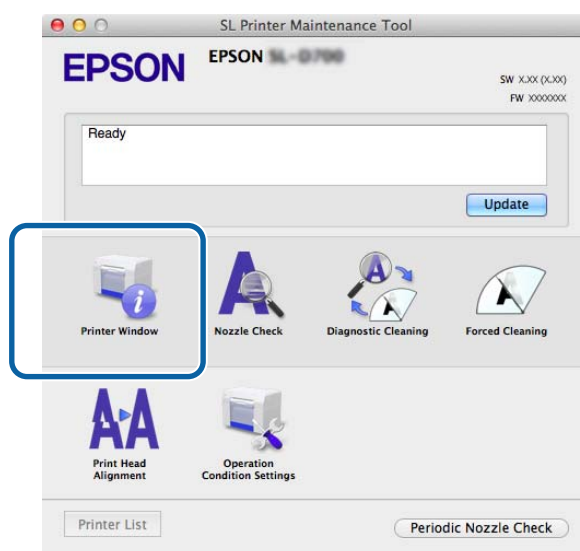

The **Printer Window** screen is displayed.

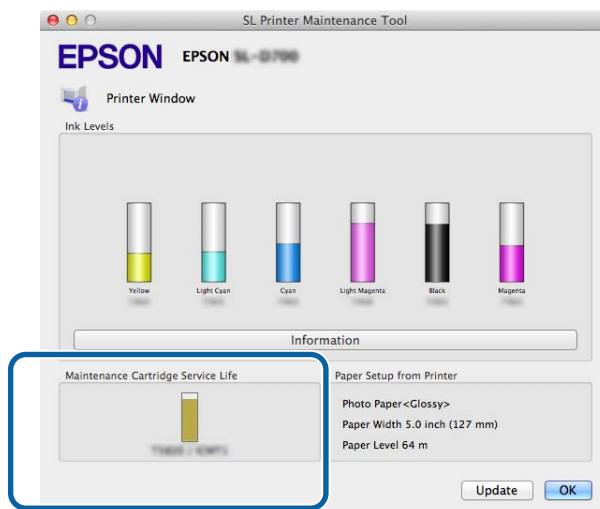

- 3 Check the free space in the maintenance cartridge.



When you have finished checking, click **OK**.

Replacing the Maintenance Cartridge

Replacement Procedure

- 1 Check that the printer's  light is on.
If the  light is flashing, the printer is operating. Wait until all operations have stopped.
- 2 Open the cartridge cover on the right.
A warning buzzer sounds when you open the cover.



- 3 Be careful not to tilt the maintenance cartridge, and remove it carefully.
Push up, and then pull it out.
See the following for more information on disposing of maintenance cartridges.
 [“Disposing of Used Ink Cartridges and Maintenance Cartridges” on page 22](#)



Replacing the Maintenance Cartridge

- 4 Prepare a new maintenance cartridge.

! **Important:**

Do not touch the chip on the maintenance cartridge. Doing so may affect normal operation and printing.

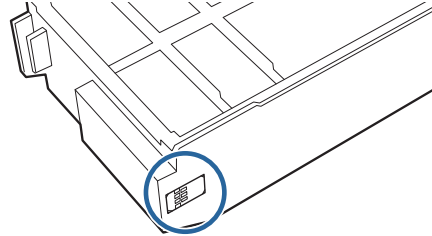

- 5 Insert the new maintenance cartridge.



- 6 Close the cartridge cover.



- 7 Check that the printer's  light is on.



This completes this section.

Emptying the Scrap Paper Box

Emptying the Scrap Paper Box

Scraps of paper cut during printing accumulate in the scrap paper box. You need to empty out the paper scraps before the box is full.

Check visually how much scrap paper has accumulated in the box. Empty the scrap paper box when you replace the paper.

- 1 Check that the printer's  light is on.
If the  light is flashing, the printer is operating. Wait until all operations have stopped.
- 2 Remove the scrap paper box.
Pull the top section forward and then lift out the bottom section.

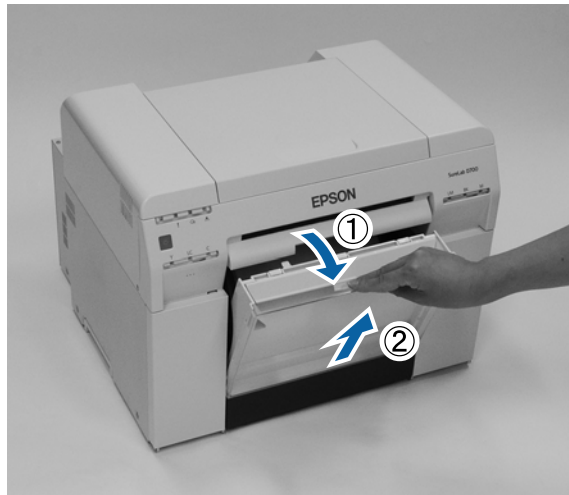

- 3 Empty out the scrap paper.

 Important:

After emptying the scrap paper, check that the flap for the scrap paper box is in the correct position as shown in the following photo.



Emptying the Scrap Paper Box

- 4 Attach the scrap paper box.
Insert the bottom section, and then push the top section into place.

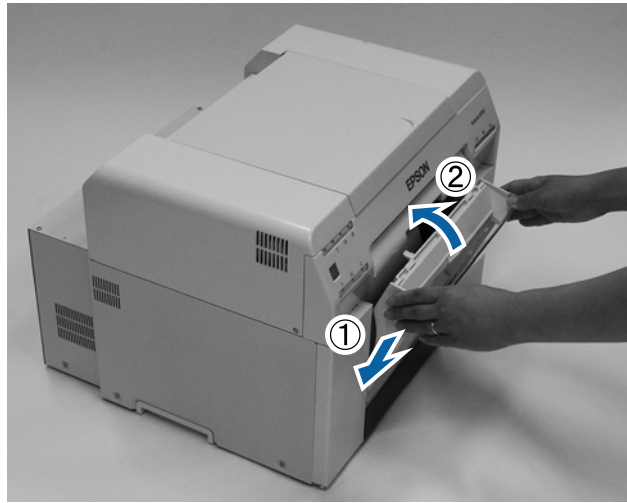



- 5 Check that the printer's  light is on.

This completes this section.

Cleaning the Platen

When the back of print outs is dirty, paper powder has accumulated on the platen. Follow the steps below to clean the platen. Perform cleaning with the power on.

- 1 Press the  switch and wait until the  light turns on.

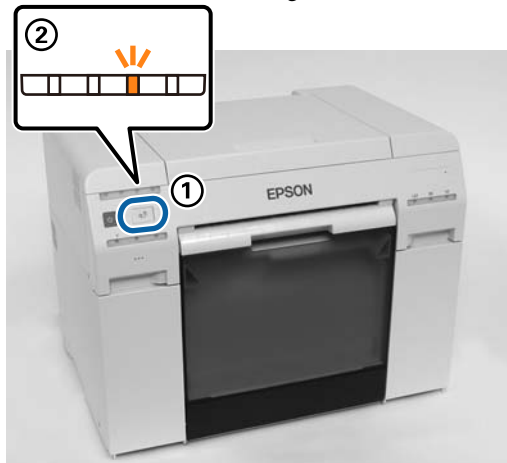

- 2 Open the top cover.



 **Important:**

- Do not move the print head unit manually with too much force.
- Do not touch the rollers inside the printer. This could cause print outs to be soiled and so on.
- Do not touch the ink tubes inside the printer. Otherwise, it may breakdown.

Cleaning the Platen

- 3 Wipe off any paper powder (this is normally white powder) on the platen (the blue sections in the following figure) with a commercially available cotton swab.

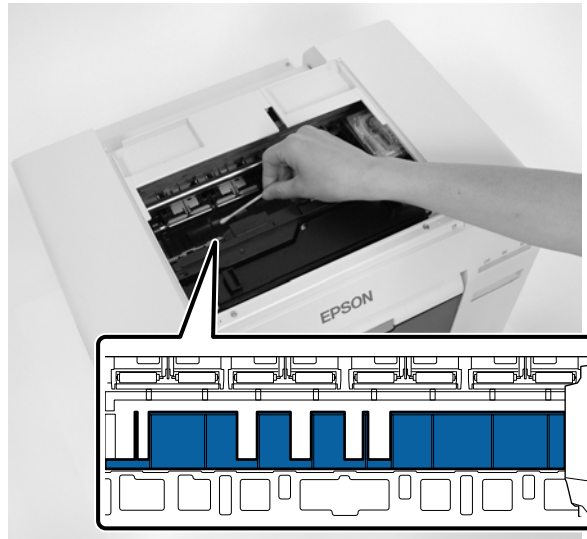

! *Important:*

Do not use a dirty swab when cleaning the platen.

- 4 Wipe off any paper powder that has accumulated in the borderless absorbent areas (the blue sections in the following figure) with a commercially available cotton swab.



Cleaning the Platen

- 5** If there is no paper powder on the right side of the platen, go to step 7.
If there is paper powder on the right side of the platen, press the  switch for three seconds.
The print head unit moves to the left.



- 6** Perform steps three and four to wipe off any paper powder.

- 7** Press the  switch for three seconds.
The print head unit moves to the right.

- 8** Close the top cover.



This completes this section.

Maintenance

Maintenance

Maintenance Tool

By using the Maintenance Tool from your computer you can perform adjustment and maintenance operations such as checking the printer's status, making settings, performing head cleaning and so on.

Windows

In operator mode, you can only use **Current media** for **Printer maintenance** and **Paper Settings**.

| Items of the Main Screen | Settings |
|--------------------------|--|
| Printer maintenance | Perform print head maintenance functions such as Diagnostic Cleaning, Forced Cleaning, and Nozzle Check . |
| Paper Settings | Set the Paper Type and the Paper Level . Make these settings when replacing the paper. You can also perform printer adjustment functions such as Print Head Alignment, Paper Feed Adjustment, and Gray Adjustment . |
| Printer settings | You can execute various printer settings such as the Buzzer, Sleep Mode Threshold, Periodic Nozzle Check, and Quick Print Mode . |
| Printer history | Check the Operation History , and save log files in Collect Logs . |
| Printer Management | You can execute printer management operations such as Register, Cancel Registration, and Replace Printer . |

Mac



| Main Screen Menu | Settings |
|------------------------------|--|
| Message | Displays the printer's status. |
| Printer Window | Allows you to check the amount of ink remaining, the free space in the maintenance cartridge, and so on. |
| Nozzle Check | Allows you to print a check pattern and visually check for clogged nozzles. |
| Diagnostic Cleaning | Detects clogged nozzles and automatically performs cleaning. |
| Forced Cleaning | Performs manual cleaning. |
| Print Head Alignment | Corrects the print misalignment. |
| Operation Condition Settings | Allows you to make various printer settings such as Time Before Switching to Sleep Mode, Warning Buzzer, Quick Print Mode, and Paper Settings . |
| Printer List | Displays a list of available printers allowing you to select the printer you want to configure. |
| Periodic Nozzle Check | Allows you to set whether or not to automatically perform a nozzle check. |

See the "Maintenance Tool Operation Guide" for more details.

Maintenance

Checking Items List

See the following table for details on inspections and cleaning.

| Check Part | Contents | Checking Time | Reference |
|-----------------|--|----------------------|--|
| Scrap paper box | Empty out the scrap paper. | When replacing paper |  "Scrap paper box" on page 67 |
| Airflow vent | Clean the airflow vent filter with a vacuum cleaner. | Every three months |  "Airflow vent" on page 67 |

Scrap paper box

Remove the scrap paper box and empty out the scrap paper.

 ["Emptying the Scrap Paper Box" on page 61](#)

Airflow vent

Clean the airflow vent filter with a vacuum cleaner.



Troubleshooting

Note:

See the "Printer Driver Operation Guide" for more details on troubleshooting the printer driver.

 "Printer Driver Operation Guide" - "Troubleshooting"

When an Error Occurs

Warning Buzzer and Light Indicators

When the warning buzzer sounds or the lights turn on or flash, check the solutions in the following table and take the recommended steps.

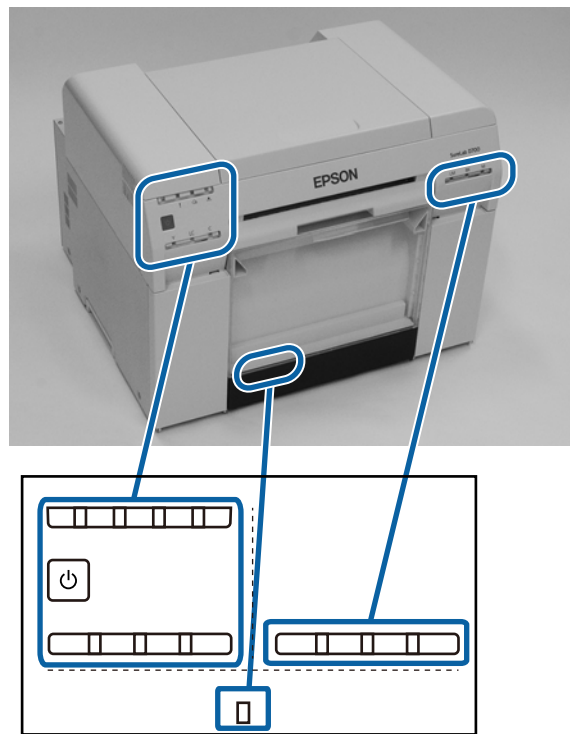

Troubleshooting

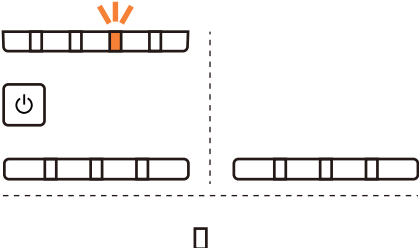
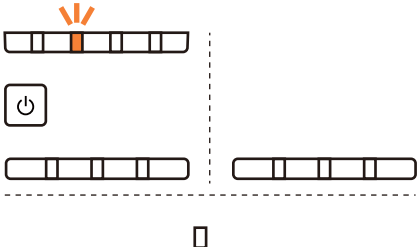
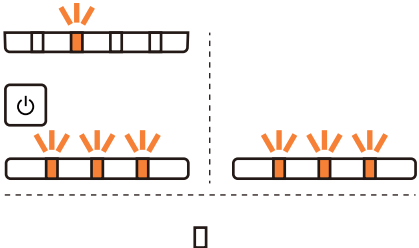
| Light Indicator | Warning Buzzer* | Problems and Solutions |
|--|---|--|
| <p>☐ light on Paper light off</p>  <p>The diagram shows a horizontal bar with seven segments. The second segment from the left is lit orange. Below the bar is a power button icon. A dashed vertical line separates this from a second identical bar on the right, which has no segments lit.</p> | <p>None</p> | <p>There is no paper loaded in the roll paper feeder. Load the paper.</p> <p>☞ "Replacing Paper" on page 25</p> |
| <p>! light on</p>  <p>The diagram shows a horizontal bar with seven segments. The second segment from the left is lit orange. Below the bar is a power button icon. A dashed vertical line separates this from a second identical bar on the right, which has no segments lit.</p> | <p>The warning buzzer continues to sound intermittently until you remove the scrap paper box.</p> | <p>Operations have stopped because an error has occurred, the printer is performing error recovery operations, or a printer system error has occurred.</p> <ul style="list-style-type: none"> ☐ Check the code on the computer's screen. See the following to solve the problem. <ul style="list-style-type: none"> ☞ "Errors and Solutions (Mac)" on page 77 ☐ Contact your local dealer if a printer system error has occurred. |
| <p>! light on</p>  <p>The diagram shows a horizontal bar with seven segments. The second, third, and fourth segments from the left are lit orange. Below the bar is a power button icon. A dashed vertical line separates this from a second identical bar on the right, which has no segments lit.</p> | | <p>The ink cartridge indicated by the ink light is expended, or an error has occurred. Replace the ink cartridges.</p> <p>☞ "Replacing Ink Cartridges" on page 48</p> |

Troubleshooting

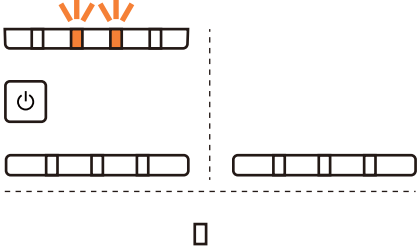
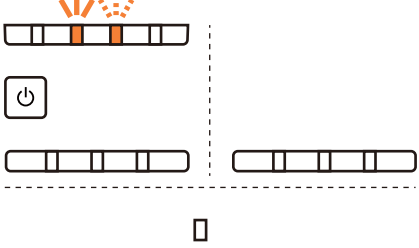
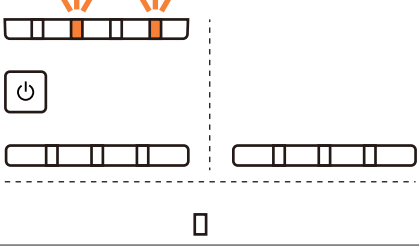
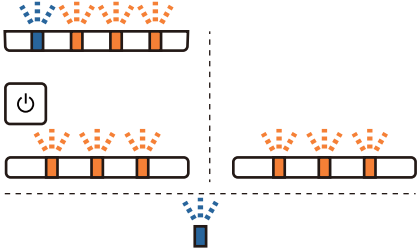
| Light Indicator | Warning Buzzer* | Problems and Solutions |
|--|---|---|
| <p>! light on ☐ light on Paper light off</p>  | <p>The warning buzzer continues to sound intermittently until you remove the scrap paper box.</p> | <p>There is no paper loaded in the roll paper feeder, or the paper has run out. Load the paper. ↗ "Replacing Paper" on page 25</p> |
| <p>! light on ☐ light flashing</p>  | | <p>Paper is jammed or the paper has not been fed correctly. Clear the paper jam, or feed the paper again. ↗ "Paper Jams" on page 84</p> |
| <p>! light on 🔥 light on</p>  | | <p>The ink remaining in the cartridge indicated by the ink light has fallen below the minimum value, or an error has occurred. Replace the maintenance cartridge(XXXX). ↗ "Replacing the Maintenance Cartridge" on page 56</p> |
| <p>All lights flashing</p>  | <p>Continues sounding until the power switch is turned off.</p> | <p>A fatal error has occurred.</p> <ul style="list-style-type: none"> ☐ Restart the printer. ☐ Contact your local dealer if the error continues to occur. |

* You can turn the warning buzzer on and off in the Maintenance Tool.

Troubleshooting

Error Messages (Windows)

Error messages are displayed when an error occurs in the printer while printing.

The code, error details, solutions, and so on are displayed on the screen.

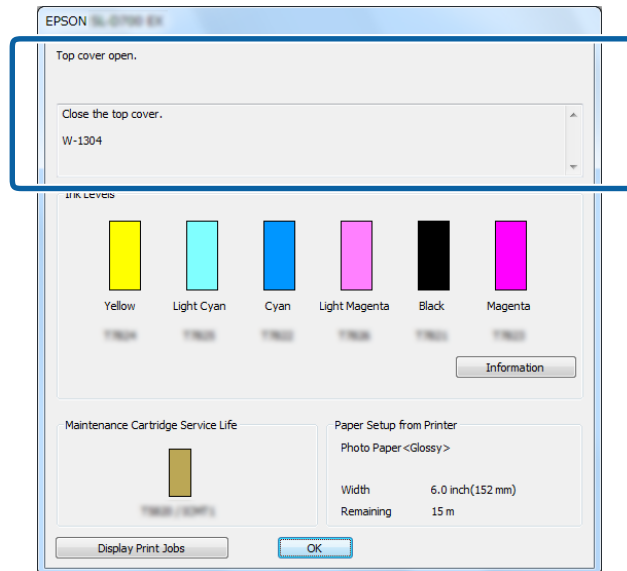

Error Messages (Mac)

When errors occur in the printer while printing, you can check the content of the error and solutions with the Maintenance Tool. Click **Printer Window** to display a detailed error message.

See the "Maintenance Tool Operation Guide" for more details on the Maintenance Tool.

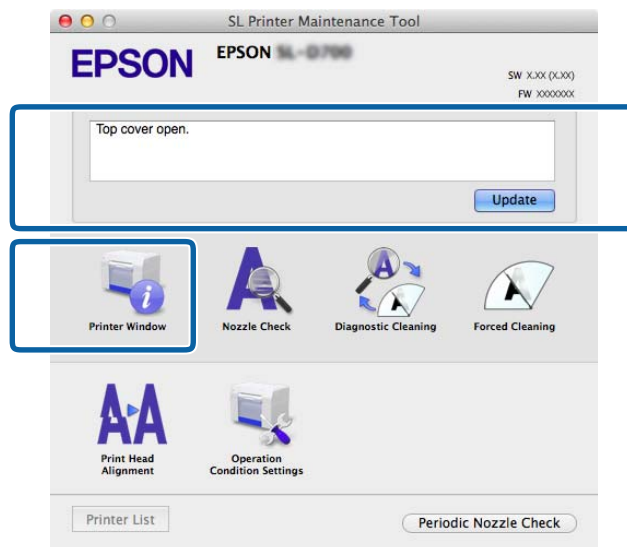

Use one of the following methods to start the Maintenance Tool.

1

Select **System Preferences > Print & Scan** (or **Print & Fax**) from the **Apple** menu.

Troubleshooting

2

Select the printer and click **Options & Supplies > Utility > Open Printer Utility**.

Errors and Solutions (Windows)

Check the details of the error displayed, and then take the necessary measures.

| Code | Message | What to do |
|--------------------------------------|--|--|
| W-2301 to W-2303 W-2305 to W-2306 | Cannot perform [Detect Clogging] correctly. Start [Maintenance tool], select [Printer maintenance] and perform [Diagnostic Cleaning]. Contact service support if the error continues to occur. | Perform Diagnostic Cleaning in the Maintenance Tool. See the "Maintenance Tool Operation Guide" for more details on the Maintenance Tool. If "Auto nozzle check failed." is displayed on the Windows screen, contact service support. |
| I-2307 | Cannot perform [Detect Clogging] correctly. Room temperature may not be within the guaranteed operating range. Check the room temperature. | Check the room temperature. Use within the recommended operating temperature range. |
| W-2311 | Clogged nozzle(s) detected. Start [Maintenance tool], select [Printer maintenance] and perform [Diagnostic Cleaning]. | Perform Diagnostic Cleaning in the Maintenance Tool. See the "Maintenance Tool Operation Guide" for more details on the Maintenance Tool. |
| I-2401 | Replace the maintenance cartridge soon. Prepare a new maintenance cartridge(XXXX). You can continue printing until replacement is required. | Check the message, and then click OK . Prepare a new maintenance cartridge with the model number displayed in XXXX. 🔗 "Replacing the Maintenance Cartridge" on page 56 |
| I-2201 | Ink Low (XXXX) Prepare a new ink cartridge. You can continue printing until replacement is required. Epson recommends the genuine Epson cartridges listed above. | Check the message, and then click OK . Prepare a new ink cartridge for replacement. 🔗 "Replacing Ink Cartridges" on page 48 |
| I-2101 to I-2104 | It is nearly time to replace parts. XXXXXX Contact a technical representative. You cannot print if parts have reached the end of their service life. | Contact service support and request replacement for the part displayed in XXXXXX. |
| W-1301 | The scrap paper box has come off. Install the scrap paper box correctly. | Attach the scrap paper box. If a message is displayed, check the details. |



Troubleshooting

| Code | Message | What to do |
|--------|---|---|
| W-1302 | Cartridge cover (right) open. When replacing a cartridge, check the location and the cartridge type. Close the cartridge cover. | Close the cartridge cover (right). If a message is displayed, check the details. |
| W-1303 | Cartridge cover (left) open. When replacing a cartridge, check the location and the cartridge type. Close the cartridge cover. | Close the cartridge cover (left). If a message is displayed, check the details. |
| W-1304 | Top cover open. Close the top cover. | Close the top cover. If a message is displayed, check the details. |
| W-1305 | Rear cover open. Close the rear cover. | Close the rear cover. If a message is displayed, check the details. |
| I-1311 | Check the scrap paper box. Empty the box if it is full. | Check the scrap paper box. Check the scrap paper box, and empty it if it is full. 🔗 "Emptying the Scrap Paper Box" on page 61 |
| W-1101 | A paper jam has occurred. Remove any paper remaining from the roll paper feeder, and then reload the paper. | Remove the paper from the roll paper feeder, and then reload the paper. 🔗 "Paper Jams" on page 84 |
| W-1102 | A paper jam has occurred. Open the rear cover and the top cover, remove any paper remaining, and then reload the paper. | Remove the paper from the internal paper feeder, and then reload the paper. If the printer is setup so that you cannot access the rear of the printer to perform maintenance, contact service support. 🔗 "Paper Jams" on page 84 |
| W-1103 | An error has occurred in the paper feeding unit. Reload the paper in the same way as when replacing paper. | Check that there is no paper inside the printer, and then reload the paper. If a message is displayed, check the details. 🔗 "Replacing Paper" on page 25 |
| W-1104 | Paper is not loaded correctly. Check the positions of the edge guides, and then reload the paper. | Check that there is no paper inside the printer, and then reload the paper. When loading the paper, match the inner edge guide and the front edge guide to the width of the paper. If a message is displayed, check the details. 🔗 "Replacing Paper" on page 25 |
| W-1105 | Paper is out. Load paper. | Check that there is no paper inside the printer, and then reload the paper. If a message is displayed, check the details. 🔗 "Replacing Paper" on page 25 |
| W-1106 | Paper is out or not loaded correctly. Load paper. | |

Troubleshooting

| Code | Message | What to do |
|------------------|--|--|
| W-1108 | The width of the loaded paper is not supported. Load supported paper. | Load the appropriate paper. ↗ "Replacing Paper" on page 25 |
| W-1109 | Cannot recognize the paper type. Update the paper information. | Update the paper information. See the "Maintenance Tool Operation Guide" for more details on updating the information. |
| W-2101 to W-2104 | Parts have reached the end of their service life. xxxxxx Do you want to continue using the printer or replace parts? If you continue to use the printer, ink could leak or a malfunction could occur. Do you want to continue? | Contact service support and request replacement for the part displayed in xxxxxx. |
| W-2401 | Maintenance cartridge not installed Install the maintenance cartridge(xxxx). | Correctly reinstall the maintenance cartridge for the model number displayed in xxxx. ↗ "Replacing the Maintenance Cartridge" on page 56 |
| W-2402 | Maintenance cartridge usage exceeded the application limit. Replace the maintenance cartridge(xxxx). | Replace the maintenance cartridge with the model number displayed in xxxx. ↗ "Replacing the Maintenance Cartridge" on page 56 |
| W-2201 | Ink cartridge error (xxxx) Please install correct cartridge. Epson recommends the genuine Epson cartridges listed above. | Check the ink cartridge with the color displayed in xxxx, and then replace the cartridge. If a message is displayed, check the details. ↗ "Replacing Ink Cartridges" on page 48 |
| W-2202 | Replace Cartridge (xxxx) Epson recommends the genuine Epson cartridges listed above. | Check the ink cartridge with the color displayed in xxxx, and then replace the cartridge. If a message is displayed, check the details. ↗ "Replacing Ink Cartridges" on page 48 |
| W-2203 | Ink cartridge error (xxxx) Remove and reinstall them correctly or replace them. Epson recommends the genuine Epson cartridges listed above. | Check the ink cartridge with the color and model number displayed in xxxx, and then replace the cartridge or reinstall it correctly. If a message is displayed, check the details. ↗ "Replacing Ink Cartridges" on page 48 |

Troubleshooting

| Code | Message | What to do |
|------------------|--|---|
| W-2204 | <p>Ink cartridge error (xxxx)</p> <p>Please install correct cartridge.</p> <p>Epson recommends the genuine Epson cartridges listed above.</p> | <p>Check the ink cartridge with the color and model number displayed in xxxx, and then replace the cartridge.</p> <p>If a message is displayed, check the details.</p> <p> "Replacing Ink Cartridges" on page 48</p> |
| W-2205 | <p>Insufficient ink left to perform head cleaning or initial charge.</p> <p>Replace the ink cartridge indicated by the ink light that is turned on.</p> <p>The cartridge being used can be installed again for printing.</p> | <p>Replace the ink cartridge indicated by the ink light that is turned on.</p> <p>If a message is displayed, check the details.</p> <p> "Replacing Ink Cartridges" on page 48</p> |
| W-2403 | <p>Maintenance cartridge cannot be recognized</p> <p>Install the maintenance cartridge correctly.</p> | <p>Replace or correctly reinstall the maintenance cartridge with the model number displayed in xxxx.</p> <p>If a message is displayed, check the details.</p> <p> "Replacing the Maintenance Cartridge" on page 56</p> |
| W-2404 | <p>Insufficient free space in the maintenance cartridge.</p> <p>Replace the maintenance cartridge(xxxx), and then perform head cleaning or initial charge.</p> <p>The cartridge being used can be reinstalled for printing.</p> | <p>Replace the maintenance cartridge with the model number displayed in xxxx.</p> <p>If a message is displayed, check the details.</p> <p> "Replacing the Maintenance Cartridge" on page 56</p> |
| E-5101 | <p>The printer is disconnected.</p> <p>Check that the cable is connected, and then turn the printer back on.</p> <p>Contact service support if the error continues to occur.</p> <p>Please order the prints again if there are image files that have not been printed.</p> <p>Code:xxxx</p> | <p>Check that the cables are connected correctly, and then restart the printer.</p> <p>If the error persists, contact service support.</p> |
| E-2101 to E-2104 | <p>Parts have reached the end of their service life.</p> <p>xxxxxx</p> <p>Contact a technical representative.</p> | <p>Contact service support and request replacement for the part displayed in xxxxxx.</p> |
| E-9901, E-9902 | <p>A printer system error occurred.</p> <p>Turn the printer off. Check if there is any paper remaining inside the printer, and then turn the printer back on.</p> <p>Contact service support if the error continues to occur.</p> <p>Please order the prints again if there are image files that have not been printed.</p> <p>Code:xxxx</p> | <p>Turn off the printer, and then start it again.</p> <p>If the error persists, a malfunction may have occurred. Contact service support.</p> |

Troubleshooting

| Code | Message | What to do |
|----------------|--|--|
| W-5201 | <p>The paper set in Print Settings and the paper loaded in the printer differ.</p> <p>After replacing the paper, click [OK]. If printing is currently being performed, when printing has stopped, replace the paper, and then click [OK].</p> <p>To continue printing using the current settings, click [Print].</p> | <p>Load the appropriate paper. After replacing the paper, set the Paper Type and the Paper Level in the Maintenance Tool.</p> <p> "Replacing Paper" on page 25</p> <p>To continue printing with the current settings, click Print.</p> |
| W-2206 | <p>You have not installed genuine Epson ink cartridges.</p> <p>Information about ink levels may not be displayed, and use of non-genuine ink is recorded for possible use in service support.</p> <p>For optimum quality and reliability Epson recommends using genuine Epson ink.</p> <p>Do you want to continue?</p> <p>Please call Epson user service hot-line 400-810-9977 for genuine I/C purchase.</p> | <p>This printer is developed for use with genuine ink cartridges. If you use non-genuine cartridges, the print result may be faint, or the ink remaining may not be detected normally. We recommend using genuine Epson products.</p> |
| E-5201 | <p>Failed to acquire printing calibration data.</p> <p>Check that the cable is connected, and then turn the printer back on.</p> <p>Contact service support if the error continues to occur.</p> | <p>Turn off the printer, and then start it again.</p> <p>If the error persists, contact service support.</p> |
| I-5201, W-5202 | <p>Amount of data in print jobs sent to printer nearly at maximum limit.</p> <p>Stop sending the current print job and send the remaining pages as another print job.</p> | <p>The print job is too large.</p> <p>After deleting all of the print jobs, split up the data, and then try printing again.</p> |



Troubleshooting

Errors and Solutions (Mac)





Check the details of the error displayed, and then take the necessary measures.

| Code | Message | What to do |
|--|---|--|
| W-2301 to W-2303 W-2305 to W-2306 | Cannot perform [Detect Clogging] correctly. Delete all print jobs remaining in the operating system's print queue. Perform [Diagnostic Cleaning]. Contact service support if the error continues to occur. | After deleting all of the print jobs, perform Diagnostic Cleaning in the Maintenance Tool. See the "Maintenance Tool Operation Guide" for more details on the Maintenance Tool. If "Auto nozzle check failed." is displayed on the screen, contact service support. |
| I-2307 | Cannot perform [Detect Clogging] correctly. Room temperature may not be within the guaranteed operating range. Check the room temperature. | Check the room temperature. Use within the recommended operating temperature range. |
| W-2311 | Clogged nozzle(s) detected. Delete all print jobs remaining in the operating system's print queue. Perform [Diagnostic Cleaning]. | After deleting all of the print jobs, perform Diagnostic Cleaning in the Maintenance Tool. See the "Maintenance Tool Operation Guide" for more details on the Maintenance Tool. |
| I-2401 | Replace the maintenance cartridge soon Prepare a new maintenance cartridge(XXXX). You may continue printing until replacement of the maintenance cartridge is required. | Check the message, and then click OK . Prepare a new maintenance cartridge with the model number displayed in XXXX.  "Replacing the Maintenance Cartridge" on page 56 |
| I-2201 | Ink Low (XXXX) Prepare a new ink cartridge. You may continue printing until replacement of the ink cartridge is required. Epson recommends the genuine Epson cartridges listed above. | Check the message, and then click OK . Prepare a new ink cartridge for the color and model number displayed in XXXX, and then get ready to replace the cartridge.  "Replacing Ink Cartridges" on page 48 |
| I-2101 to I-2104 | It is nearly time to replace parts. XXXXXX Contact a technical representative. You cannot print if parts have reached the end of their service life. | Contact service support and request replacement for the part displayed in XXXXXX. |
| W-1301 | The scrap paper box has come off. Delete all print jobs remaining in the operating system's print queue. Install the scrap paper box correctly. | After deleting all of the print jobs, attach the scrap paper box. If a message is displayed, check the details. |

Troubleshooting

| Code | Message | What to do |
|--------|--|---|
| W-1302 | <p>Cartridge cover (right) open.</p> <p>Delete all print jobs remaining in the operating system's print queue.</p> <p>When replacing a cartridge, check the location and the cartridge type.</p> <p>Close the cartridge cover.</p> | <p>After deleting all of the print jobs, close the cartridge cover (right). If a message is displayed, check the details.</p> |
| W-1303 | <p>Cartridge cover (left) open.</p> <p>Delete all print jobs remaining in the operating system's print queue.</p> <p>When replacing a cartridge, check the location and the cartridge type.</p> <p>Close the cartridge cover.</p> | <p>After deleting all of the print jobs, close the cartridge cover (left). If a message is displayed, check the details.</p> |
| W-1304 | <p>Top cover open.</p> <p>Delete all print jobs remaining in the operating system's print queue.</p> <p>Close the top cover.</p> | <p>After deleting all of the print jobs, close the top cover. If a message is displayed, check the details.</p> |
| W-1305 | <p>Rear cover open.</p> <p>Delete all print jobs remaining in the operating system's print queue.</p> <p>Close the rear cover.</p> | <p>After deleting all of the print jobs, close the rear cover. If a message is displayed, check the details.</p> |
| I-1311 | <p>Check the scrap paper box.</p> <p>Empty the box if it is full.</p> | <p>Check the scrap paper box. Check the scrap paper box, and empty it if it is full.</p> <p> "Emptying the Scrap Paper Box" on page 61</p> |
| W-1101 | <p>A paper jam has occurred.</p> <p>Delete all print jobs remaining in the operating system's print queue.</p> <p>Remove any paper remaining from the roll paper feeder, and then reload the paper.</p> | <p>After deleting all of the print jobs, remove the paper from the roll paper feeder, and then reload the paper.</p> <p> "Paper Jams" on page 84</p> |
| W-1102 | <p>A paper jam has occurred.</p> <p>Delete all print jobs remaining in the operating system's print queue.</p> <p>Open the rear cover and the top cover, remove any paper remaining, and then reload the paper.</p> | <p>After deleting all of the print jobs, remove the paper from the internal paper feeder, and then reload the paper.</p> <p>If the printer is setup so that you cannot access the rear of the printer to perform maintenance, contact service support.</p> <p> "Paper Jams" on page 84</p> |
| W-1103 | <p>An error has occurred in the paper feeding unit.</p> <p>Delete all print jobs remaining in the operating system's print queue.</p> <p>Reload the paper in the same way as when replacing paper.</p> | <p>After deleting all of the print jobs, check that there is no paper inside the printer, and then reload the paper. If a message is displayed, check the details.</p> <p> "Replacing Paper" on page 25</p> |

Troubleshooting

| Code | Message | What to do |
|------------------|---|--|
| W-1104 | <p>Paper is not loaded correctly.</p> <p>Delete all print jobs remaining in the operating system's print queue.</p> <p>Check the positions of the edge guides, and then reload the paper.</p> | <p>After deleting all of the print jobs, check that there is no paper inside the printer, and then reload the paper.</p> <p>When loading the paper, match the inner edge guide and the front edge guide to the width of the paper. If a message is displayed, check the details.</p> <p> "Replacing Paper" on page 25</p> |
| W-1105 | <p>Paper is out.</p> <p>Delete all print jobs remaining in the operating system's print queue.</p> <p>Load paper.</p> | <p>After deleting all of the print jobs, check that there is no paper inside the printer, and then reload the paper. If a message is displayed, check the details.</p> |
| W-1106 | <p>Paper is out or not loaded correctly.</p> <p>Delete all print jobs remaining in the operating system's print queue.</p> <p>Load paper.</p> | <p> "Replacing Paper" on page 25</p> |
| W-1108 | <p>The width of the loaded paper is not supported.</p> <p>Delete all print jobs remaining in the operating system's print queue.</p> <p>Load supported paper.</p> | <p>After deleting all of the print jobs, load the appropriate paper.</p> <p> "Replacing Paper" on page 25</p> |
| W-1109 | <p>Cannot recognize the paper type.</p> <p>Delete all print jobs remaining in the operating system's print queue.</p> <p>Update the paper information.</p> | <p>Update the paper information. See the "Maintenance Tool Operation Guide" for more details on updating the information.</p> |
| W-2101 to W-2104 | <p>Parts have reached the end of their service life.</p> <p>xxxxxx</p> <p>Do you want to continue using the printer or replace parts?</p> <p>Delete all print jobs remaining in the operating system's print queue.</p> <p>If you continue to use the printer, ink could leak or a malfunction could occur.</p> <p>Do you want to continue?</p> | <p>Contact service support and request replacement for the part displayed in xxxxxx.</p> |
| W-2401 | <p>Maintenance cartridge not installed</p> <p>Delete all print jobs remaining in the operating system's print queue.</p> <p>Install the maintenance cartridge.</p> | <p>After deleting all of the print jobs, install the maintenance cartridge correctly.</p> <p> "Replacing the Maintenance Cartridge" on page 56</p> |
| W-2402 | <p>Maintenance cartridge usage exceeded the application limit.</p> <p>Delete all print jobs remaining in the operating system's print queue.</p> <p>Replace the maintenance cartridge(xxxx).</p> | <p>After deleting all of the print jobs, replace the maintenance cartridge with the model number displayed in xxxx.</p> <p> "Replacing the Maintenance Cartridge" on page 56</p> |

Troubleshooting

| Code | Message | What to do |
|--------|---|---|
| W-2201 | <p>Ink cartridge error (xxxx)</p> <p>Delete all print jobs remaining in the operating system's print queue. Please install correct cartridge.</p> <p>Epson recommends the genuine Epson cartridges listed above.</p> | <p>After deleting all of the print jobs, check the ink cartridge with the color displayed in xxxx, and then replace the cartridge.</p> <p>If a message is displayed, check the details.</p> <p> "Replacing Ink Cartridges" on page 48</p> |
| W-2202 | <p>Replace Cartridge (xxxx)</p> <p>Delete all print jobs remaining in the operating system's print queue. Epson recommends the genuine Epson cartridges listed above.</p> | <p>After deleting all of the print jobs, check the ink cartridge with the color and model number displayed in xxxx, and then replace the cartridge.</p> <p>If a message is displayed, check the details.</p> <p> "Replacing Ink Cartridges" on page 48</p> |
| W-2203 | <p>Ink cartridge error (xxxx)</p> <p>Delete all print jobs remaining in the operating system's print queue. Remove and reinstall them correctly or replace them. Epson recommends the genuine Epson cartridges listed above.</p> | <p>After deleting all of the print jobs, check the ink cartridge with the color and model number displayed in xxxx, and then replace the cartridge or reinstall it correctly.</p> <p>If a message is displayed, check the details.</p> <p> "Replacing Ink Cartridges" on page 48</p> |
| W-2204 | <p>Ink cartridge error (xxxx)</p> <p>Delete all print jobs remaining in the operating system's print queue. Please install correct cartridge.</p> <p>Epson recommends the genuine Epson cartridges listed above.</p> | <p>After deleting all of the print jobs, check the ink cartridge with the color and model number displayed in xxxx, and then replace the cartridge.</p> <p>If a message is displayed, check the details.</p> <p> "Replacing Ink Cartridges" on page 48</p> |
| W-2205 | <p>Insufficient ink left to perform head cleaning or initial charge. Replace the ink cartridge indicated by the ink light that is turned on. Delete all print jobs remaining in the operating system's print queue. The cartridge being used can be installed again for printing.</p> | <p>Replace the ink cartridge for which the ink light is on, and then delete all print jobs.</p> <p>If a message is displayed, check the details.</p> <p> "Replacing Ink Cartridges" on page 48</p> |
| W-2403 | <p>Maintenance cartridge cannot be recognized Delete all print jobs remaining in the operating system's print queue. Install the maintenance cartridge correctly.</p> | <p>After deleting all of the print jobs, replace the maintenance cartridge or reinstall it correctly.</p> <p>If a message is displayed, check the details.</p> <p> "Replacing the Maintenance Cartridge" on page 56</p> |

Troubleshooting

| Code | Message | What to do |
|---------------------------------|---|--|
| W-2404 | <p>Insufficient free space in the maintenance cartridge.</p> <p>Delete all print jobs remaining in the operating system's print queue.</p> <p>Replace the maintenance cartridge (xxxx), and then perform head cleaning or initial charge.</p> | <p>After deleting all of the print jobs, replace the maintenance cartridge.</p> <p>If a message is displayed, check the details.</p> <p> "Replacing the Maintenance Cartridge" on page 56</p> |
| E-5101 | <p>The printer is disconnected.</p> <p>Delete all print jobs remaining in the operating system's print queue.</p> <p>Check that the cable is connected, and then turn the printer back on.</p> <p>Contact service support if the error continues to occur.</p> | <p>After deleting all of the print jobs, check that the cables are connected correctly, and then restart the printer.</p> <p>If the error persists, contact service support.</p> |
| E-2101 to E-2104 | <p>Parts have reached the end of their service life.</p> <p>xxxxxx</p> <p>Contact a technical representative.</p> <p>Delete all print jobs remaining in the operating system's print queue.</p> | <p>After deleting all of the print jobs, contact service support and request replacement for the part displayed in xxxxxx.</p> |
| E-9901 (xxxx), E-9902 (xxxx) | <p>A printer system error occurred.</p> <p>Delete all print jobs remaining in the operating system's print queue.</p> <p>Turn the printer off. Check if there is any paper remaining inside the printer, and then turn the printer back on.</p> <p>Contact service support if the error continues to occur.</p> | <p>After deleting all of the print jobs, restart the printer.</p> <p>If the error persists, a malfunction may have occurred. Contact service support.</p> |
| I-5201 | <p>Amount of data in print jobs sent to printer nearly at maximum limit.</p> <p>Stop sending the current print job and send the remaining pages as another print job.</p> | <p>The print job is too large.</p> <p>After deleting all of the print jobs, split up the data, and then try printing again.</p> |
| W-2206 | <p>You have not installed genuine Epson ink cartridges.</p> <p>xxxx</p> <p>Information about ink levels may not be displayed, and use of non-genuine ink is recorded for possible use in service support.</p> <p>For optimum quality and reliability Epson recommends using genuine Epson ink.</p> | <p>This printer is developed for use with genuine ink cartridges. If you use non-genuine cartridges, the print result may be faint, or the ink remaining may not be detected normally. We recommend using genuine Epson products.</p> |
| W-2207 | <p>A non-genuine or refilled cartridge has been detected. Ink levels may not be shown because of unknown ink volume.</p> | |
| W-2208 | <p>A non-genuine or refilled cartridge has been detected. Ink levels may not be shown because of unknown ink volume.</p> | |

Troubleshooting

Cannot Clear the Displayed Error

If an error is displayed that cannot be cleared, follow the steps below to restart the printer.

- 1 Check that the printer's  light is on. Turn off the power switch (the light turns off).



If you cannot turn off the power using the switch, unplug the power cable.



- 2 Reconnect the power cable, and then turn on the power switch (the light turns on).
The  light turns on.



Troubleshooting

Note:

If the error persists even after restarting, contact service support.

This completes this section.

Troubleshooting

Paper Jams

This section explains how to clear paper jammed in the printer.



When a paper jam occurs, the **!** light on the front of the printer turns on, and the  light flashes.

 [“Lights” on page 12](#)

 light



The procedure differs for the roll paper feeder and the internal paper feeder. Check the error message to determine which procedure to use.

- ❑ W-1101 When the message "A paper jam has occurred. Delete all print jobs remaining in the operating system's print queue. Remove any paper remaining from the roll paper feeder, and then reload the paper." is displayed, check for paper jams in the roll paper feeder.
 [“Paper is Jammed in the Roll Paper Feeder” on page 86](#)
- ❑ W-1102 When the message "A paper jam has occurred. Delete all print jobs remaining in the operating system's print queue. Open the rear cover and the top cover, remove any paper remaining, and then reload the paper." is displayed, check for paper jams in the internal paper feeder.
 [“Paper is Jammed in the Internal Paper Feeder” on page 92](#)

Important:

- ❑ *Do not leave the printer with a paper jam. Fire could ignite or smoke could be emitted.*
- ❑ *When a printer system error occurs, if the error persists after restarting the printer, check if a paper jam has occurred.*
- ❑ *Do not remove the paper forcibly when clearing paper jams. Otherwise, the printer could be damaged.*

Troubleshooting

Deleting Print Jobs

Before starting operations on Mac, delete all jobs from the print queue.

Mac

- 1 Click the printer icon in the Dock.



- 2 Select the job you want to cancel, and then click [×] (or **Delete**).

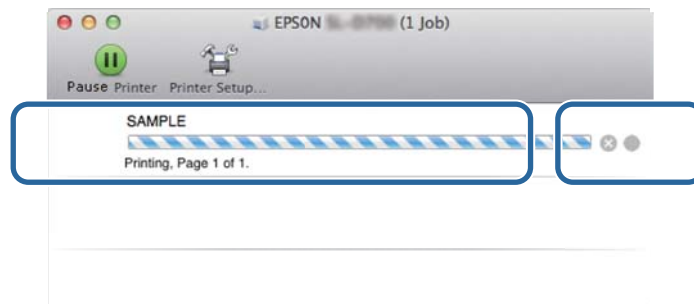

Troubleshooting

Paper is Jammed in the Roll Paper Feeder

Error message W-1101 - When the message "Remove any paper remaining from the roll paper feeder, and then reload the paper." is displayed, follow the steps below.

- 1 On Mac, delete all jobs from the Print Queue.
 ["Deleting Print Jobs" on page 85](#)
- 2 Remove the scrap paper box.
Pull the top section forward and then lift out the bottom section.

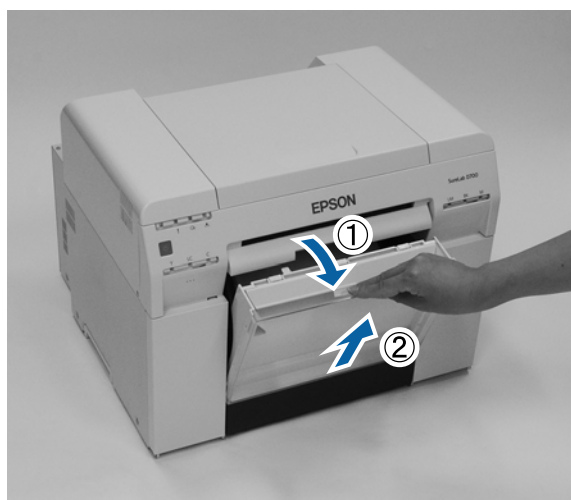

- 3 Grip the handle to release the lock, and then pull out the roll paper feeder.

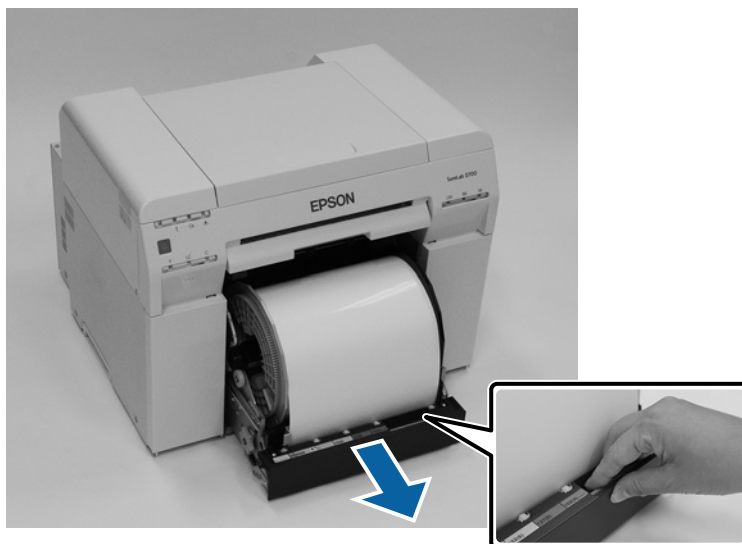

Troubleshooting

! **Important:**

If you cannot remove the roll paper feeder for some reason, do not try to pull it out by force. Paper may be jammed inside. When you can access the top and rear of the printer, remove the paper by following the procedure in the next section "Paper is Jammed in the Internal Paper Feeder".

☞ "Paper is Jammed in the Internal Paper Feeder" on page 92

Contact your local dealer if you cannot access the top or rear of the printer.

- 4** Turn the handle on the left of the roll paper feeder in the direction indicated by the arrow to rewind the paper. Rewind the paper until the leading edge comes out of the paper feed slot.

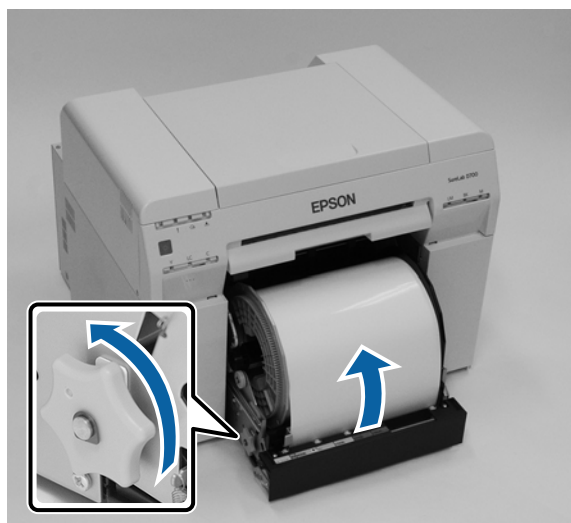

- 5** If the leading edge of the paper is ragged, cut it in a straight line with a pair of scissors and so on. Cut the paper as straight as possible.



Troubleshooting

- 6** Remove the spindle unit.

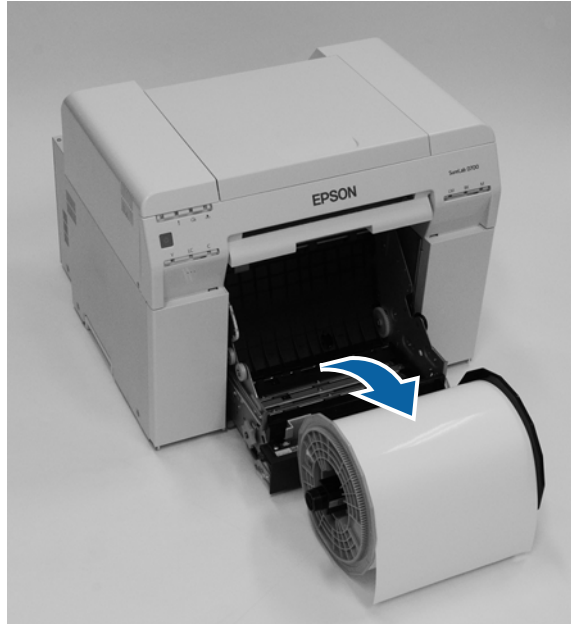

- 7** Open the internal rear plate.
Place your finger in the hole at the bottom and lift to open.

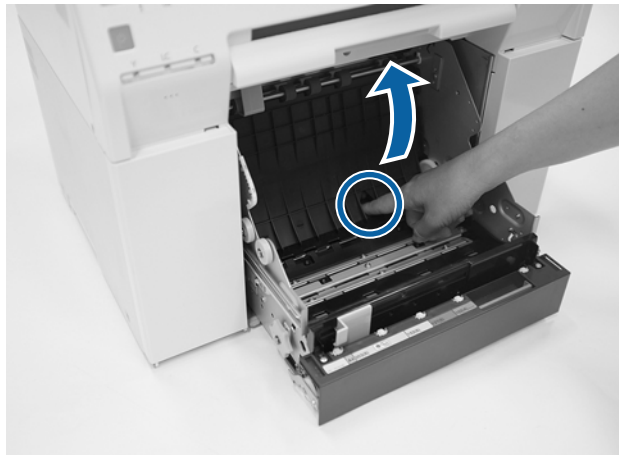

Troubleshooting

- 8** Check that there is no paper or foreign material at the back of the inside of the printer.
If there is a jam, remove the paper slowly.

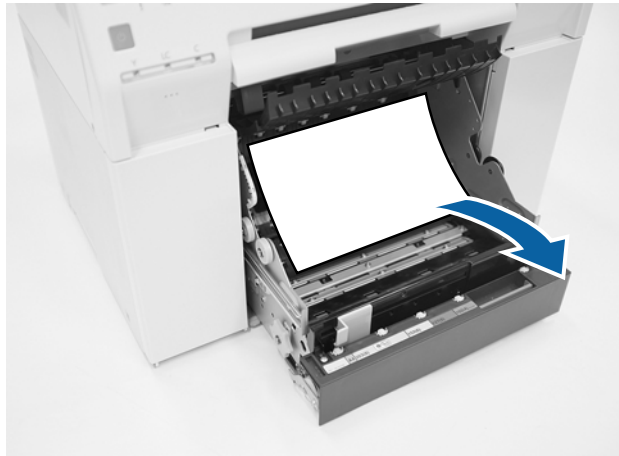

- 9** Open the front plate.
Place your finger in the hole at the bottom and lift to open.



- 10** Check that there is no paper, foreign material, or scrap paper at the back of the printer.
If there is a jam, remove the paper slowly.



Troubleshooting

- 11** Replace the front plate and the rear plate.
 Replace the front plate first.
 Press down until you hear it click into place.

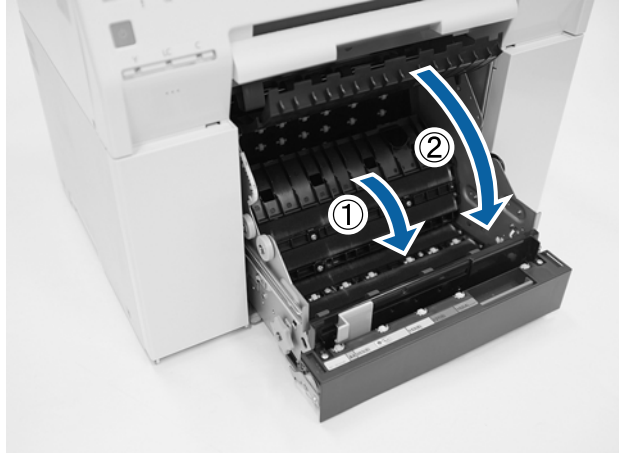

- 12** Reload the paper.
 See the following for more details on loading the paper.
 📖 [“Replacing Paper” on page 25](#)

- 13** If an error message is still displayed on a Windows computer's screen, click **OK** to close the screen.

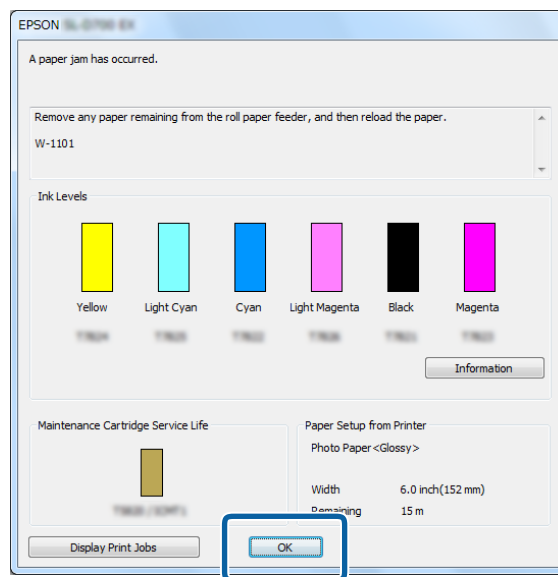

Troubleshooting

- 14 Check that the ! light turns off, and the ⏻ light turns on.



This completes this section.

Troubleshooting

Paper is Jammed in the Internal Paper Feeder

Error message W-1102 - When the message "Open the rear cover and the top cover, remove any paper remaining, and then reload the paper." is displayed, follow the steps below.

If you have cleared a paper jam from the roll paper feeder but the error is still not cleared, or you cannot pull out the roll paper feeder, there may be a jam inside the printer.

! **Important:**

Contact your local dealer if you cannot access the top or rear of the printer.

- 1 On Mac, delete all jobs from the Print Queue.

[🔗 "Deleting Print Jobs" on page 85](#)

- 2 Remove the scrap paper box.

Pull the top section forward and then lift out the bottom section.

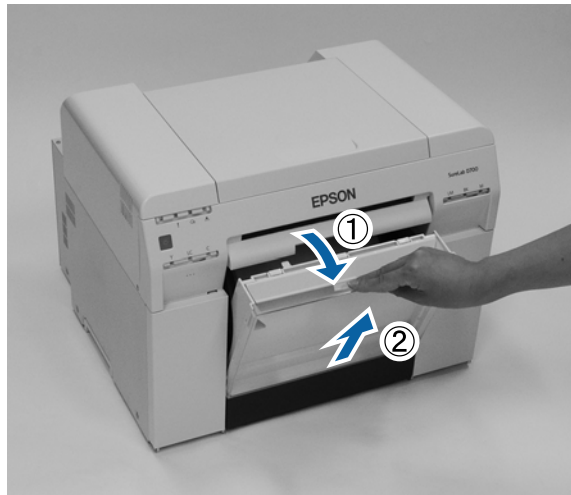

- 3 Squeeze the lock lever on the back to release the lock, and then open the rear cover.

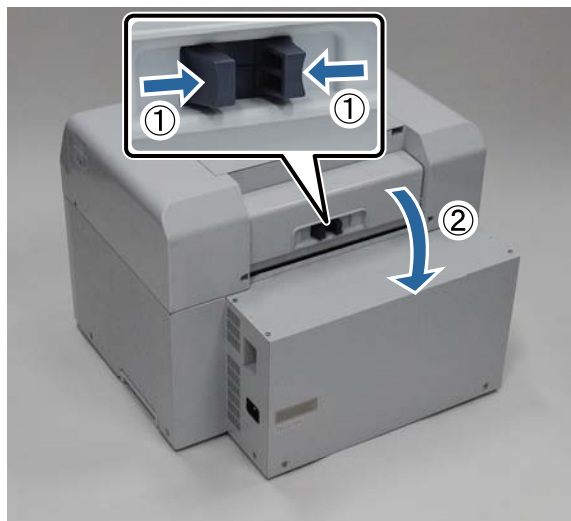

Troubleshooting

- 4 Open the top cover.
Check the point where the jam occurred.



- 5 If a lot of paper has been ejected from the front of the printer, cut the paper in front of the jam with a pair of scissors and so on.

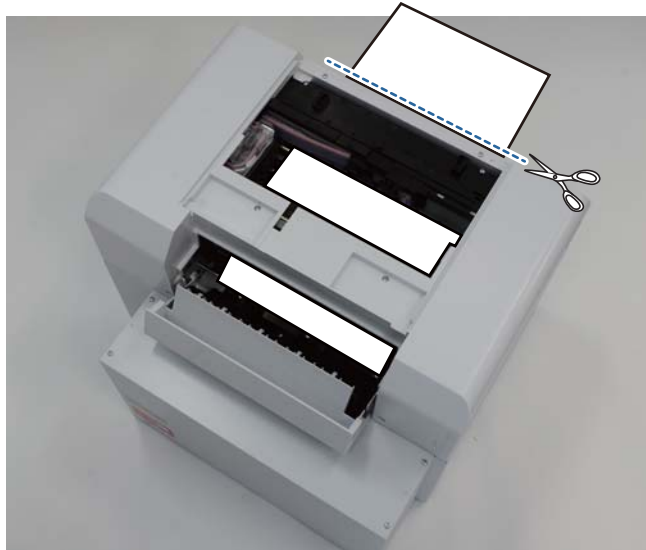

Troubleshooting

6 Slowly pull the remaining paper jammed inside the printer.

If you have pulled out the paper, go to step 8.

If the paper is under the print head and cannot be easily removed, go to the next step.

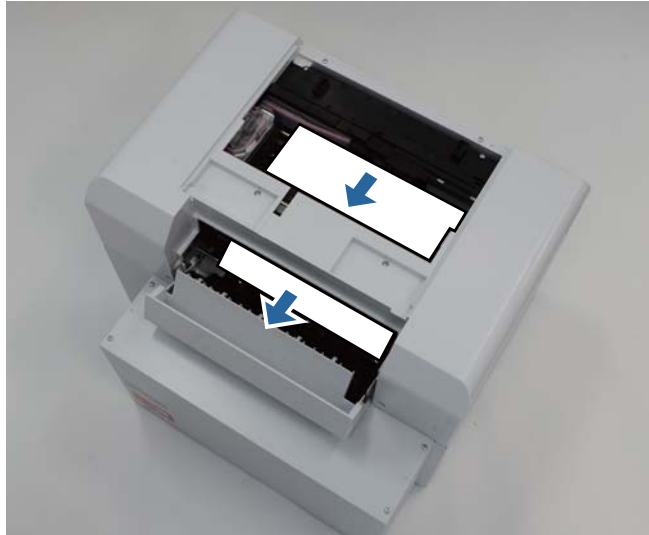

7 Move the print head unit manually, and remove the paper from the rear.

If the paper is on the right, move the print head unit to the left.

If the paper is on the left, move the print head unit to the right.



Troubleshooting

! *Important:*

- ❑ *If you cannot move the print head unit, do not try to force it to move, contact service support. Otherwise, the print head unit could be damaged.*
- ❑ *When removing the paper, do not touch the ink absorbing areas. Otherwise, the paper stand is soiled which could also soil the back of the paper.*

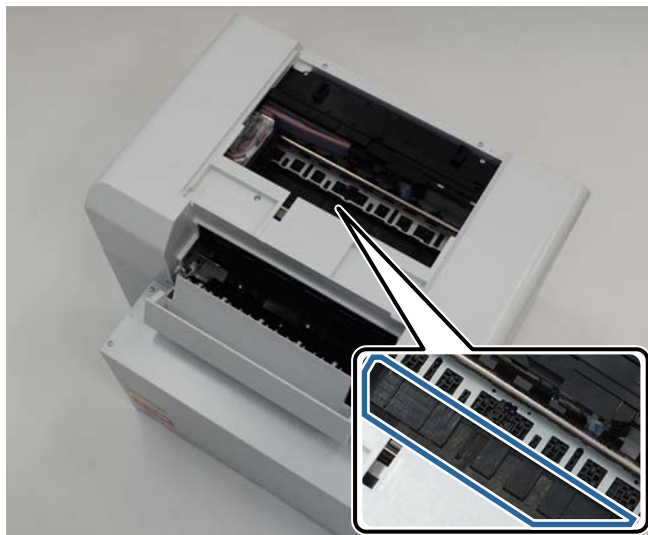

8

Cut the paper you have pulled out with scissors and so on.

Remove the cut section.



! *Important:*

After cutting the paper, do not pull the paper inside the printer to the upper section. Remove the paper inside the printer by following the procedure for removing roll paper.

Troubleshooting

- 9 Close the top cover.



- 10 Check if there is a paper jam in the roll paper feeder.
Perform steps 2 to 11 in "Paper is Jammed in the Roll Paper Feeder".
[🔗 "Paper is Jammed in the Roll Paper Feeder" on page 86](#)

- 11 Close the rear cover.



- 12 Reload the paper.
See the following for more details on loading the paper.
[🔗 "Replacing Paper" on page 25](#)

Troubleshooting

- 13 If an error message is still displayed on a Windows computer's screen, click **OK** to close the screen.

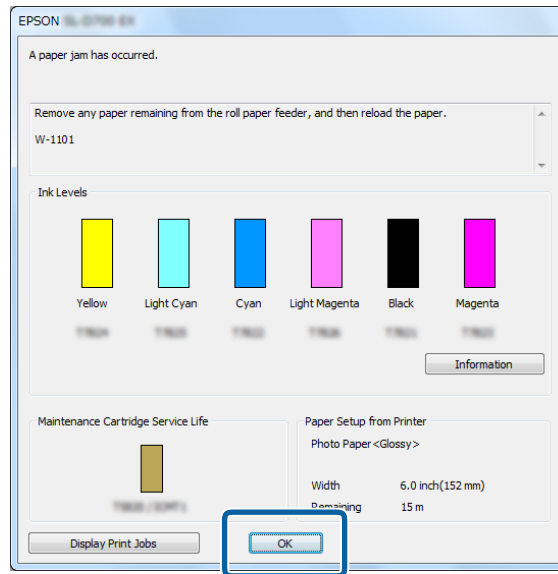

- 14 Check that the ! light turns off, and the power light turns on.





This completes this section.

Troubleshooting

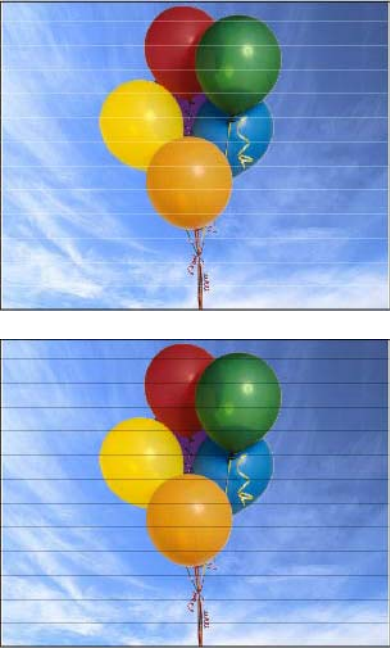
Problems with Print Results

| Cause | What to do |
|--|---|
| <p>Stripes appear at regular intervals in the print outs.</p>  | <p>Are the print head unit nozzles clogged? If the print head unit is clogged, stripes appear at regular intervals, and print quality declines. Check the nozzle status in the Maintenance Tool, and then try cleaning. See the "Maintenance Tool Operation Guide" for more details on the Maintenance Tool.</p> |
| <p>Print quality is poor, uneven, too light, or too dark.</p> | <p>Are the print head unit nozzles clogged? If the nozzles in the print head unit are clogged, specific nozzles do not fire ink and the print quality declines. Check the nozzle status in the Maintenance Tool, and then try cleaning. See the "Maintenance Tool Operation Guide" for more details on the Maintenance Tool.</p> <p>Are you using a genuine ink cartridge? This printer is developed for use with genuine ink cartridges. If you use non-genuine ink cartridges, the prints may smear, or the color of the printed image may be changed because the remaining ink level is not correctly detected. Be sure to use the correct ink cartridge.</p> <p>Are you using an old ink cartridge? The print quality declines when an old ink cartridge is used. Replace the old ink cartridge with a new one. We recommend using all the ink in the ink cartridge before the expiry date printed on the package (within six months of installation). 🔗 "Replacing Ink Cartridges" on page 48</p> <p>Do the settings in the Maintenance Tool and the settings in the printer driver match the paper loaded in the printer? If the loaded paper type and the set Paper Type differ, print quality may decline. Check the settings. 🔗 "Changing Paper Settings" on page 38</p> <p>Have you compared the print result with the image on the display monitor? Since monitors and printers produce colors differently, printed colors will not always match on-screen colors perfectly.</p> |

Troubleshooting

| Cause | What to do |
|---|---|
| The printed surface is scuffed or soiled. | <p>Is the paper too thick or too thin? Check that the paper can be used with this printer.</p> <p> "Printer Specifications" on page 103</p> |
| The back of the printed paper is dirty. | <p>Is there paper powder on the platen? Clean the platen.</p> <p> "Cleaning the Platen" on page 63</p> |
| The paper is creased. | <p>Are you using the printer at normal room temperature? The printer should be used at normal room temperature (temperature: 15 to 25 °C, humidity: 40 to 60 %). For information about paper such as thin paper from other manufacturers that requires special handling, see the documentation supplied with the paper</p> |

Problems when Cutting Paper

| Cause | What to do |
|---|---|
| The cut is crooked, the cut edge is frayed or turned up, or the coating is cracked. | <p>The cutter needs to be replaced. Contact service support to request cutter replacement.</p> |

When a Problem Cannot be Cleared

If you cannot resolve a problem after taking the measures described in the "Troubleshooting" section, contact service support.

Appendix

Consumables and Optional Items

The following consumable products and optional items are available for use with your printer. (As of April, 2019)

Ink cartridges

This printer is developed for use with genuine ink cartridges.



If you use non-genuine cartridges, the print result may be faint, or the ink remaining may not be detected normally.

| Model name | Ink color | Product number |
|------------|---------------|----------------|
| SL-D800 | Black | T43U1 |
| | Cyan | T43U2 |
| | Magenta | T43U3 |
| | Yellow | T43U4 |
| | Light Cyan | T43U5 |
| | Light Magenta | T43U6 |
| SL-D830 | Black | T43Y1 |
| | Cyan | T43Y2 |
| | Magenta | T43Y3 |
| | Yellow | T43Y4 |
| | Light Cyan | T43Y5 |
| | Light Magenta | T43Y6 |
| SL-D860 | Black | T43X1 |
| | Cyan | T43X2 |
| | Magenta | T43X3 |
| | Yellow | T43X4 |
| | Light Cyan | T43X5 |
| | Light Magenta | T43X6 |

Appendix

| Model name | Ink color | Product number |
|------------|---------------|----------------|
| SL-D880 | Black | T43W1 |
| | Cyan | T43W2 |
| | Magenta | T43W3 |
| | Yellow | T43W4 |
| | Light Cyan | T43W5 |
| | Light Magenta | T43W6 |

Others

| Product name | Product number | Explanation |
|-----------------------|----------------|--|
| MAINTENANCE CARTRIDGE | T5820 | Absorbs ink consumed during head cleaning.  "Replacing the Maintenance Cartridge" on page 56 |
| SPINDLE UNIT | C12C934881 | The same as the spindle unit supplied with the printer. Remove the tape before use. |
| PAPER CASE | C12C890861 | A case for storing paper to prevent the paper from being damaged.  "Notes on storage" on page 21 |
| PRINT TRAY | C12C891171 | This tray holds print outs that are 102 mm or less. |
| RIGID PRINT TRAY | C12C934781 | This tray holds print outs. |

Notes on Moving the Printer

Perform the following operations when moving the printer.

**Caution:**

- When lifting this printer, make sure you use the correct posture.
- When lifting the printer, hold it in the areas indicated in the manual.
The printer may fall if you lift it by holding other areas, and your fingers could be caught which may cause an injury.

Appendix

Place your hands at the points indicated in the photo, and then lift.

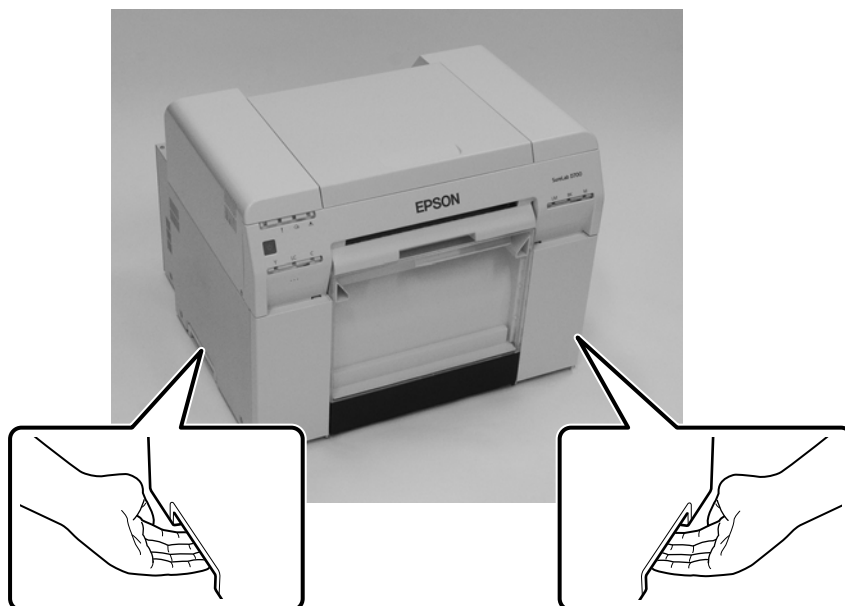

Important:

- Only hold the required area. Otherwise, it may breakdown.
- Move the printer with ink cartridges installed. Do not remove the ink cartridges; otherwise, the nozzles may be clogged and make it impossible to print, or ink may leak.
- When moving the printer, do not tilt it. Ink could leak out.

Preparing to Move

Make the following preparations in advance before moving the printer.

- Turn off the printer and remove all cables.
- Remove any trays if they are installed.
- Remove any paper.

After Moving

After moving, make sure that the print head is not clogged before use.

 "Maintenance Tool Operation Guide"

Appendix

Printer Specifications

| Basic specifications | |
|----------------------|--|
| Printing method | On-demand ink jet |
| Nozzle configuration | 180 nozzles for each color |
| Print direction | Bidirectional printing |
| Highest resolution | 1440 x 720 dpi |
| Paper feed method | Friction feed |
| Interface | Universal Serial Bus Specifications Revision 2.0 |

 **Important:**

Use this printer at an altitude of up to 2000 m.

| Electrical Specifications | | |
|---------------------------|---|---|
| Rated voltage | AC 100 to 120 V | AC 220 to 240 V |
| Rated frequency range | 50/60 Hz | 50/60 Hz |
| Rated current | 3.0 A | 1.5 A |
| Power consumption | Operating: Approximately 140 W When standing by: Approximately 60 W Sleep mode: Approximately 6 W Power off: Less than 0.5 W | Operating: Approximately 140 W When standing by: Approximately 60 W Sleep mode: Approximately 6 W Power off: Less than 0.5 W |

| Paper Feeder Specifications | |
|-----------------------------|---|
| Paper core size | Roll paper feeder (3 inch core diameter): Outer diameter less than 170 mm/One can be loaded |
| Paper length | 50 to 1000 mm |
| Paper width | 89 mm (3.5 inches), 102 mm (4 inches), 127 mm (5 inches), 152 mm (6 inches), 203 mm (8 inches), 210 mm (A4) |

| Ink Specifications | |
|---------------------|---|
| Type | Ink cartridges |
| Ink type | Six color water-based dye |
| Use by date | Three years after manufacture |
| Storage temperature | In the packaging: -20 to 40 °C (within one month at 40 °C) Installed in printer: -20 to 40 °C (within one month at 40 °C) Transporting: -20 to 60 °C (within one month at 40 °C, 72 hours at 60 °C) |
| Capacity | 200 ml |

Appendix

Ink Specifications

| | |
|----------------------|-------------------------------|
| Cartridge dimensions | 25 (W) x 200 (D) x 100 (H) mm |
|----------------------|-------------------------------|

 **Important:**

- The ink freezes if left at below -15 °C for a long time. If it does freeze, leave it at room temperature (25 °C) for at least four hours until it has defrosted (without condensation).
- Do not disassemble the ink cartridges or refill the ink.

Maintenance Cartridge Specifications

| | |
|--------------------------|--|
| Type | Maintenance cartridge for waste ink |
| Number installed | 1 |
| Environmental conditions | In the packaging: -20 to 40 °C (temperature), 20 to 85% (humidity) Installed in printer: Conforms to the general specifications below Transporting: -20 to 60 °C (temperature) 5 to 85% (humidity) (within one month at 40 °C, 120 hours at 60 °C) |
| Cartridge dimensions | 78.8 (W) x 254.5 (D) x 38.5 (H) mm |

General Specifications

| | |
|-------------|---|
| Temperature | Operating: 10 to 35 °C Storage (before unpacking): -20 to 60 °C (within 120 hours at 60 °C, one month at 40 °C) Storage (after unpacking): -20 to 40 °C (within one month at 40 °C) |
| Humidity | Operating: 20 to 80% (without condensation) Storage (before unpacking): 5 to 85% (without condensation) Storage (after unpacking): 5 to 85% (without condensation) |
| Weight | Approx. 23 kg (printer only) |
| Dimensions | 460 (W) x 430 (D) x 354 (H) mm  "Necessary space" on page 105 |

Standards and Approvals

| | | |
|--------|----------------------------------|------------|
| Safety | UL 60950-1 | |
| | CAN/CSA No. 60950-1 | |
| | Low Voltage Directive 2014/35/EU | EN 62368-1 |

Appendix

| | | |
|-----|-------------------------------|-----------------|
| EMC | FCC part 15 subpart B class A | |
| | ICES-003 Class A | |
| | AS/NZS CISPR 32 Class A | |
| | EMC Directive 2014/30/EU | EN55032 Class A |
| | | EN 55024 |
| | | EN 61000-3-2 |
| | | EN 61000-3-3 |

Warning:

This is a class A product. In a domestic environment this product may cause radio interference in which case the user may be required to take adequate measures.

Necessary space

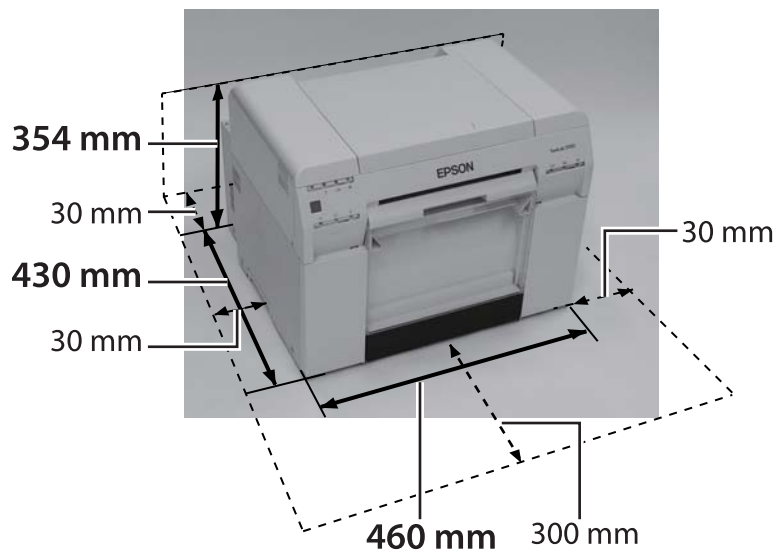

Appendix

Notes

- ❑ Unauthorized reproduction of a part or all of this manual is strictly prohibited.
- ❑ The contents of this manual are subject to change without prior notice.
- ❑ Contact our company if you have any questions, find a mistake, encounter a missing description, and so on in the contents of this manual.
- ❑ Regardless of the previous point, we will under no conditions be liable for any damages or losses resulting from operation of this product.
- ❑ We will under no conditions be liable for any damages or losses resulting from operation of this product in any way other than described in this manual, inappropriate use of this product, or repairs or modifications performed by a third party other than our company or our suppliers.
- ❑ We are unable to accept responsibility for any problems resulting from the use of options or consumable products other than our genuine products, or products that we recommend, even if the problem occurs within the warranty period. In this case, a fee will be required for any necessary repairs.

FCC Compliance Statement

For United States Users

NOTE: This equipment has been tested and found to comply with the limits for a Class A digital device, pursuant to Part 15 of the FCC Rules. These limits are designed to provide reasonable protection against harmful interference when the equipment is operated in a commercial environment. This equipment generates, uses, and can radiate radio frequency energy and, if not installed and used in accordance with the instruction manual, may cause harmful interference to radio communications. Operation of this equipment in a residential area is likely to cause harmful interference in which case the user will be required to correct the interference at his own expense.

For European customers only

The crossed out wheeled bin label that can be found on your product indicates that this product should not be disposed of via the normal household waste stream. To prevent possible harm to the environment or human health please separate this product from other waste streams to ensure that it can be recycled in an environmentally sound manner. For more details on available collection facilities please contact your local government office or the retailer where you purchased this product.

This information only applies to customers in the European Union, according to Directive 2002/96/EC OF THE EUROPEAN PARLIAMENT AND OF THE COUNCIL OF 27 January 2003 on waste electrical and electronic equipment (WEEE) and legislation transposing and implementing it into the various national legal systems.

For other countries, please contact your local government to investigate the possibility of recycling your product.



Appendix

Indication of the manufacturer and the importer in accordance with requirements of directive 2011/65/EU (RoHS)

Manufacturer: SEIKO EPSON CORPORATION
Address: 3-5, Owa 3-chome, Suwa-shi, Nagano-ken 392-8502 Japan
Telephone: 81-266-52-3131

Importer: EPSON EUROPE B.V.
Address: Azie building, Atlas ArenA, Hoogoorddreef 5, 1101 BA Amsterdam Zuidoost The Netherlands
Telephone: 31-20-314-5000

CE Marking

Information of EU declaration of conformity: The full text of the EU declaration of conformity of this equipment is available at the following internet address. <https://www.epson.eu/conformity>

For Turkish customers only

AEEE Yönetmeliğine Uygundur.

For Ukraine customers only

Обладнання відповідає вимогам Технічного регламенту обмеження використання деяких небезпечних речовин в електричному та електронному обладнанні.