

acer

T10



Liquid Z6 E

USER'S MANUAL

© 2016 All Rights Reserved
Acer Liquid Z6 E User's Manual
Model: T10
This revision: December 2016

Sign up for an Acer ID and enjoy great benefits

Open the *Acer Portal* app from the *Apps list* to sign up for an Acer ID or sign in if you already have an Acer ID.

There are three great reasons for you to get an Acer ID:

- Create your own connected world.
- Get the latest offers and product information.
- Register your device for quick, personalized customer support.

For more information, please visit the AcerCloud website:

www.acer.com/byoc-start



Important

This manual contains proprietary information that is protected by copyright laws. The information contained in this manual is subject to change without notice. Images provided herein are for reference only and may contain information or features that do not apply to your computer. Acer Group shall not be liable for technical or editorial errors or omissions contained in this manual.

Acer Liquid Z6 E smartphone

Model number: _____

Serial number: _____

Date of purchase: _____

Place of purchase: _____

TABLE OF CONTENTS

Setting up	5	Going online	31
Unpacking your phone.....	5	Browsing the internet	31
Getting to know your phone.....	5	Using the browser.....	31
Views	5	Setting up email	31
Charging the battery	6	Google services	32
Setting up for the first time.....	7	Setting up your Google email	32
Inserting the SIM cards and microSD		Voice search	33
card	7	Play Store	33
SIM card lock	8	Google Hangouts.....	35
Using your phone	9	Maps, Navigation and Places	35
Turning on for the first time.....	9	Using the camera and video recorder	36
Sign in to or create a Google account	9	Camera/video icons and indicators.....	36
Entering your PIN.....	9	Taking a photo	37
Activating a new SIM card	9	Recording a video.....	37
Locking your phone	10	Viewing photos and videos	37
Waking your phone	10	Camera and video options.....	38
Navigating through menus and options	10	Mode.....	38
Using the touchscreen.....	11	Settings.....	38
Onscreen keyboards	12	Supported formats	39
Touchpal keyboard	12	Advanced settings	40
Changing the text input method	13	Putting your phone in Airplane mode.....	40
The Home screen	14	Restarting your phone	40
Search.....	14	Adjusting settings.....	40
The extended Home screen.....	15	Wireless & networks (managing	
Personalizing the Home screen	15	connections)	40
The Apps list	19	Phone network settings	42
Notification and status area	19	Phone settings	44
Multitasking	20	Adjusting the volume	44
Access requests.....	20	Display	44
Managing contacts	21	Setting the date and time.....	44
Managing your contacts	21	Setting alarms	44
Adding a contact	21	Changing language and text options	45
Making calls	23	Connecting to a PC.....	45
Before making a call	23	Synchronization	46
Making a call.....	23	Apps (applications)	46
Dialing a number from Call History	24	Uninstalling an app	46
Viewing missed calls.....	24	Restoring to factory settings	47
Making a call to one of your contacts.....	24	Accessories and tips	48
Dialing an international number	24	Using the headset.....	48
Direct dial widget.....	25	Using a Bluetooth headset.....	48
The voice call screen.....	25	Creating a new access point.....	48
Answering or declining a call	25	Managing your SIM cards	49
Conference calls	26	SIM Management	49
Text and multimedia messages	27	Appendix	51
Creating a new message.....	27	FAQ and troubleshooting.....	51
Replying to a message	28	Audio.....	51
Multimedia messages.....	29	Multimedia files	51
Sending a multimedia message	29	Google Play Store.....	52
Receiving multimedia messages	29	System information and performance.....	52
		Power.....	52

RAM / ROM.....	52
Internal storage.....	53
Security.....	53
Temperature.....	53
Other sources of help.....	53
Warnings and precautions	54
Medical devices.....	55
Vehicles.....	56
Potentially explosive environments.....	56
Emergency calls.....	57
Taking care of your phone.....	57

Specifications	59
Performance.....	59
Display.....	59
Dimensions.....	59
SIM support.....	59
Connectivity.....	59
Expansion.....	60
Camera.....	60
Power.....	60
Multimedia.....	61
End User License Agreement	62

SETTING UP

Unpacking your phone

Your new phone comes packed in a protective box. Carefully unpack the box and remove the contents. If any of the following items is missing or damaged, contact your dealer immediately:

- Your new Acer smartphone
- USB cable
- AC adapter
- Headset



Note

In-box content varies depending on country and region.

Getting to know your phone

Views

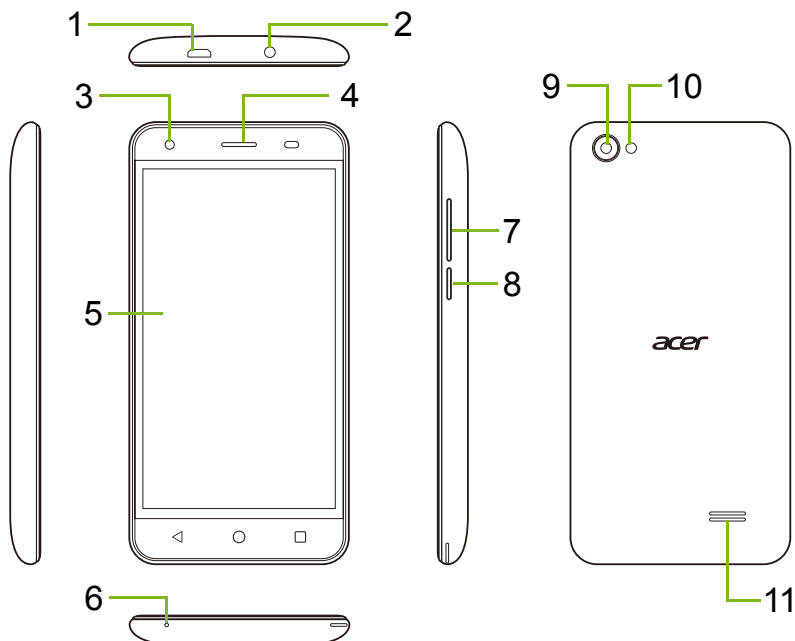

No.	Item	Description
1	Micro USB port	For connecting to a PC or a charger.
2	3.5 mm headphone jack	Connects to stereo headphones.
3	Front-facing camera	For video calls or taking selfies.
4	Phone speaker	Emits audio from your phone; suitable for holding to your ear.
5	Touchscreen	For viewing content from your phone or entering data.
6	Microphone	For picking up audio while making a phone calls.
7	Volume up/down buttons	Increase or decrease the audio volume.
8	Power button	Turns the phone on or off.
9	Camera	A camera for taking high-resolution images.
10	Flash	LED flash for camera.
11	Handsfree speaker	Emits audio from your phone; suitable for making handsfree calls.

Charging the battery

For initial use, you need to charge your phone for eight hours. After that you can recharge the battery as needed.

Connect the AC adapter cord to the USB connector on your phone.

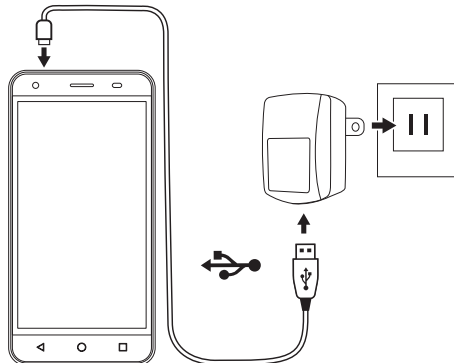

Setting up for the first time

Inserting the SIM cards and microSD card

1. Turn off the phone by pressing and holding the power button.
2. Insert your fingernail into the notch located at the bottom of the phone and remove the cover.

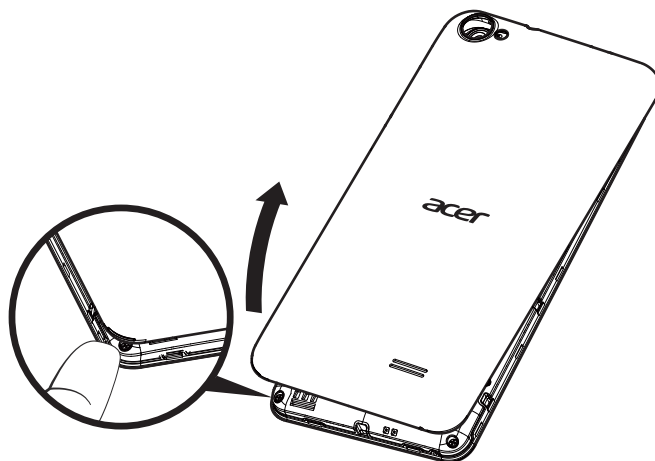

3. Insert the SIM and microSD cards as shown.

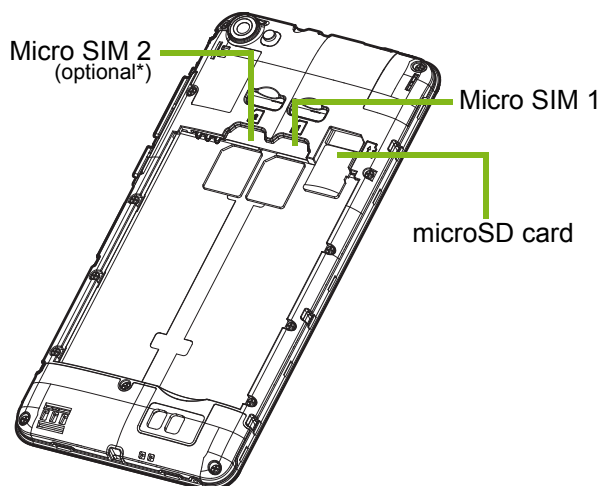

* Your phone may be equipped with one or two SIM slots depending on model.

4. Replace the battery by aligning the gold-colored connectors at the top of the battery with the connectors at the top of the phone.

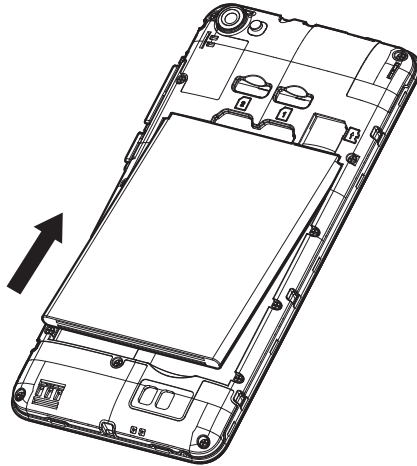

5. Replace the cover by aligning the tabs on the cover into the slots on the phone. Gently press the cover until it snaps in place.



SIM card lock

Your phone may come with a SIM card lock, i.e., you will only be able to use the SIM card provided by your network operator.

To cancel the SIM lock, contact your network provider.

USING YOUR PHONE

Turning on for the first time

To turn on your phone for the first time, press and hold the power button until the screen turns on. You will then be asked to configure some settings before you can use your phone.

Follow the onscreen instructions to complete setup.

Sign in to or create a Google account

If you have internet access, your phone allows you to synchronize information with a Google account.

You may create or sign in to an existing Google account, which will be used to synchronize your contact list, email, calendar and other information. Open the *Apps list* and then tap **Settings > Accounts > Add account**. Tap the type of account you want to add (for example Google or Acer BYOC). You will need internet access to complete the synchronization process. You can create and easily access multiple accounts from your phone, including multiple Google accounts.

Entering your PIN

When you install a SIM card for the first time, you may need to enter a PIN using the onscreen number pad.



Important

Depending on your settings, you may be required to enter your PIN each time you switch on the phone function.

Activating a new SIM card

If you are using your SIM card for the first time, it may require activation. Contact your network operator for details on how to do this.

Locking your phone

If you will not use your phone for a while, briefly press the power button to lock access. This saves power and ensures your phone does not unintentionally use any services. Your phone will lock automatically if it is not used for one minute.

Waking your phone

If the screen is off and the phone does not react to any taps on the screen, then it has been locked and is in sleep mode.

Press the power button to wake your phone. Unlock your phone by sliding your finger upwards across the screen.

There are three icons at the bottom of the lock screen (from left to right): Voice search, lock, and camera. Place your finger on an icon and swipe upwards to unlock the screen and launch the associated app (if applicable) directly.

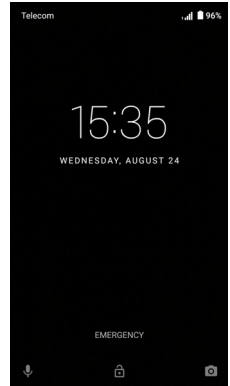

If there are notifications displayed on the lock screen, you can swipe downwards to view the notifications.

For additional security, you may set an unlock PIN, password or pattern, a set of dots that must be touched in the correct order to access the phone. Open the *Apps list* and then tap **Settings** > **Security** > **Screen lock**. If you forget your unlock pattern, please refer to [Security on page 53](#).

Navigating through menus and options

To navigate through menus and options, there are three touch-sensitive buttons beneath the screen.



Back

Tap this button to go to the previous page, or to go up one level in a menu.

Home

Tap this button to go directly to the *Home screen*. Tap and hold this button to open *Google Now* or *Search*.

Overview

Tap this button to see recently opened apps in your phone's *Overview* screen. Tap an app to open it. Tap anywhere on the screen to return to the *Home screen*. **See Multitasking on page 20.**

Using the touchscreen

Your phone uses a touchscreen for selecting items and entering information. Use your finger to tap the screen.

Tap: Touch the screen once to open items and select options.

Swipe: Quickly swipe your finger across the screen to switch screens or open lists of options or information.

Drag: Hold your finger on the screen and drag across the screen to select text and images.

Tap and hold: Tap and hold an item to see a list of actions available for that item. On the pop-up menu that appears, tap the action you want to perform.

Scroll: To scroll up or down the screen, simply drag your finger up or down the screen in the direction that you want to scroll.

Onscreen keyboards



Note

The keyboard layout varies slightly, depending on the application and information that is required.

Touchpal keyboard

The *Touchpal* keyboard allows you to type with one continuous motion across the screen keyboard.

Put your finger on the first letter of the word and draw a path from letter to letter, lifting up only after the last letter. The keyboard will insert spaces where necessary.

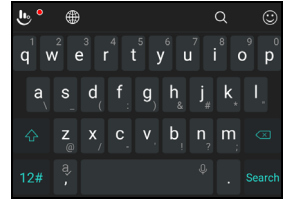

Predictive text

A selection of words are displayed above the keyboard that match the sequence of keys on the path, or are a close match allowing for errors. If the word you want is not entered automatically, tap an alternative in the *candidate bar* (immediately above the keyboard) or tap delete and try again.

You may tap keys one at a time to enter names or words that are not recognized. Tap and hold a key to select alternative characters, such as symbols (shown in the bottom-right of the key), or letters with accents.

Tap the **12#** key to see numbers and special characters; tap the **1/2** key to see a second page of alternatives.

Settings and languages

To change keyboard settings, tap the *Touchpal* icon  in the candidate bar, then swipe left and select **Settings**.

To set up more than one language, tap the world icon  in the candidate bar. Use this key to download new languages, quickly toggle between multiple input languages. The keyboard layout changes according to the selected language.

Changing the text input method

You can change the keyboard or language from *Settings* as follows.

1. Open the *Apps list*.
2. Tap **Settings** > **Language & input** then under *Keyboards & input methods* tap **Current Keyboard** and then either select a keyboard from the list.
 - Tap **CHOOSE KEYBOARDS** to turn input methods or keyboards on or off.

Google keyboard

The Google keyboard is also available with various features that assist you to enter correct text. In the *Apps list*, tap **Settings** > **Language & input**. Then tap **Google Keyboard** to see a list of settings you can adjust.

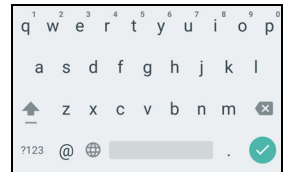

Adding an extra language

You can add languages to the Google keyboard.

1. Tap **Settings** > **Language & input** > **Google Keyboard**.
2. Tap the toggle switch next to *Use system language* to turn it off.
3. Scroll through the list of available languages to select those that you wish to add to the keyboard by tapping the toggle switch to turn the languages on or off.

The Home screen

The *Home screen* gives you quick access to information and simple controls with widgets or shortcuts. These display information such as the time and weather, or provide additional controls and direct access to apps and other frequently used features of your phone.

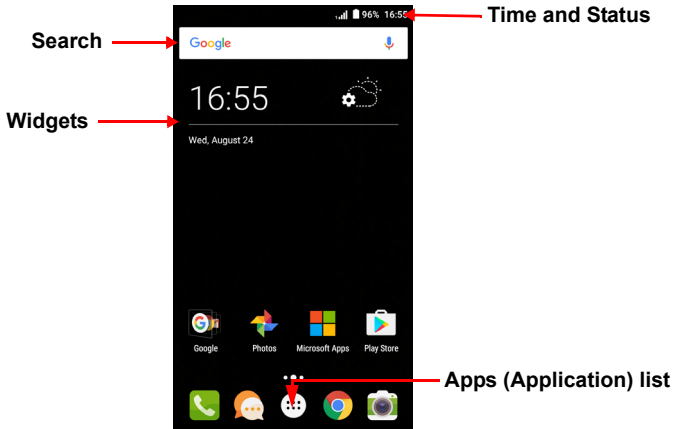

At the bottom of the screen is the *Favorites tray* which displays default apps. Tap an icon to open the app. Tap the *Apps list* icon in the middle of the *Favorites tray* to view your apps. To change apps, [see Changing Favorites tray icons on page 17](#).

Search

To search for apps, files or for information on the internet, tap the **Google** icon. Simply enter the text you want to find and tap **Q** or tap one of the suggestions, apps or files shown in the list.

In order to search or browse the internet, you must be connected to a cellular data (if available) or wireless network. [See Going online on page 31](#).

Voice search

If voice search is available, tap the microphone  and speak your search request. [See Voice search on page 33](#).

The old *Home screen*

The *Home screen* extends to either side of the screen, giving you more room to add icons, widgets or features. To view the extended screen, slide your finger to the left or right.

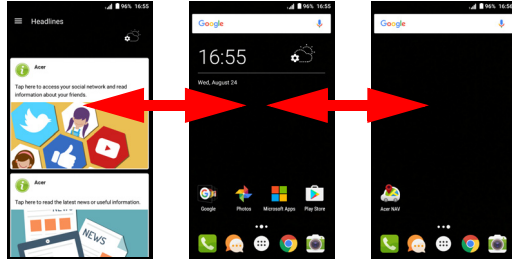

Note

The *Left Page* can be configured to show social media updates and additional news and features. For additional *Left Page* settings press and hold an empty area of the screen, then tap **Settings**.

Extended screens to the right are only available if you have added content to the right of the *Home screen*.

Personalizing the *Home screen*

You may personalize your *Home screen* by adding or removing app shortcuts or widgets, and by changing the wallpaper.

Adding shortcuts to the Home screen

To add app shortcuts to the *Home screen*, tap the *Apps list* icon in the bottom-center of the *Home screen*. Tap and hold the icon for the selected app. The *Apps list* will close and the *Home screen* will appear. Move the icon to the desired position on the *Home screen* and remove your finger.

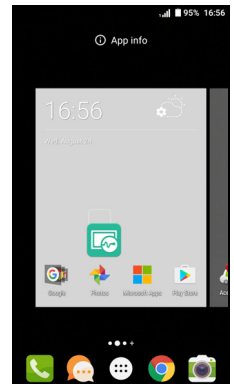

Adding Widgets to the Home screen

Tap and hold any area of the *Home screen* that does not have an icon or Widget already. Tap **WIDGETS** to see small apps and links (such as custom shortcuts, contacts or bookmarks) that you can add to a *Home screen*. Widgets are small apps that display constantly-updated information or quick shortcuts to apps or special functions.

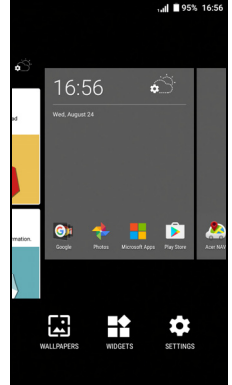

To move an app or widget to the *Home screen*, tap and hold an item until it is selected. The *Home screen* will open. Drag the item to any free area on the screen. To view information about the app or widget, drag it to the icon at the top of the screen.

To move the item to a different *Home screen*, drag it to the side of the screen, the *Home screen* will switch to the screen in that direction. Release the item when it is positioned correctly.

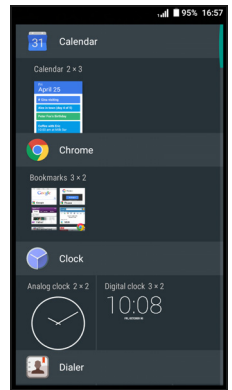

Removing Widgets or shortcuts from the Home screen

To remove a shortcut or widget from the *Home screen*, tap and drag it to **Remove** at the top of the screen.

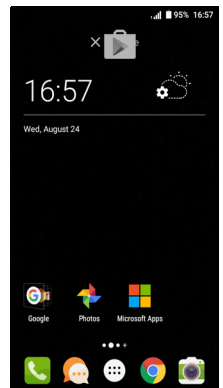

Resizing widgets

Some widgets can be resized. As soon as you place a widget on the *Home screen*, you can resize it by dragging the corners.

To resize a widget that is already on the *Home screen*, tap and hold the widget. Once the Remove icon appears, release the widget. If the widget is resizable, you will be able to drag the sides of the widget to resize it.

Adding or removing folders

You can also add folders to your *Home screen*. To create a new folder drag and drop an app icon onto another app icon in the *Home screen*. This will create an *Unnamed Folder*. Tap the folder icon and then tap the name of the folder to rename it.

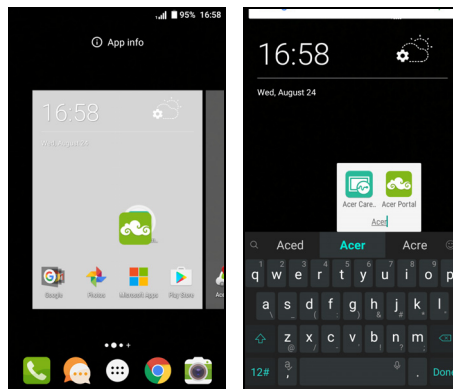

To delete an app shortcut from a folder, tap on the folder icon to display the apps inside and then tap and hold the app icon that you want to remove. Drag and drop the icon on **Remove** that will appear at the top of the screen.

To delete a folder, tap and hold on the folder and then drag and drop the folder on **Remove** that will appear at the top of the screen.

Changing Favorites tray icons

You can set icons for installed apps in the *Favorites tray*. Open the *Apps list* and find the app you want to add. Tap and hold the icon, then drag it to any open position in the *Favorites tray*. Dragging the new app to an existing *Favorites tray* icon will create a folder for both icons.

To remove an icon from the *Favorites tray*, tap and hold the icon to select it. Either drag the icon to a different location outside the *Favorites tray* or to **Remove** at the top of the screen.

Changing the wallpaper

Tap and hold any area of the *Home screen* that does not have an icon or Widget already, tap **WALLPAPERS**.

A selection of wallpapers are shown in a bar at the bottom of the screen; drag the bar left or right to see more options. If you wish to use a wallpaper other than those shown, tap **My Photos** in the lower-left corner and select an image from *Gallery* or *Photos*.

Tap on the thumbnail to select the wallpaper you wish to use, then tap **Set wallpaper**.

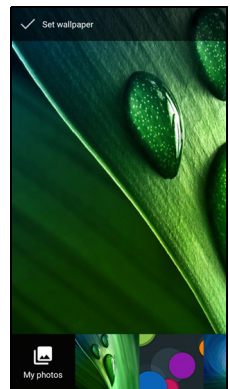
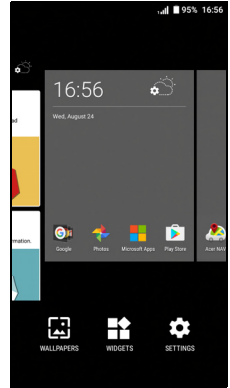

The Apps list

To access the *Apps list*, on the *Home screen* tap  in the center of the *Favorites tray*.

Apps are displayed in alphabetical order, with the four most-recently used apps at the top of the menu. Swipe up or down to see the complete list of apps.

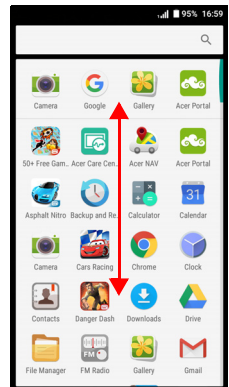

Notification and status area

Notification and status icons are shown at the top of the screen. The top-right area displays a variety of status information, such as Wi-Fi connectivity, signal strength, battery status, and time. The top-left area displays event icons, such as a new message.

- Single-SIM models:



- Dual-SIM models:



Swipe down from the *Notification bar* to display any notifications.

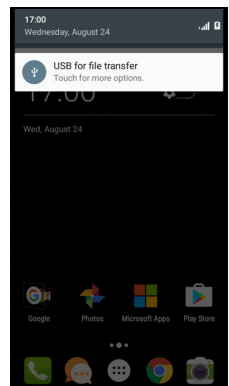

Swipe down twice or once with two fingers to open *Quick Settings*, which allows you to quickly adjust selected settings or turn features on or off.

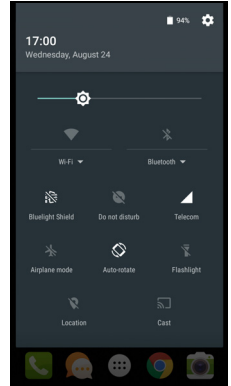

Multitasking

You can have multiple apps open at the same time. To open a new app, tap the home icon to return to the *Home screen*, then start the new app. Tap the *Overview* icon to quickly navigate back and forth between previously-opened apps.

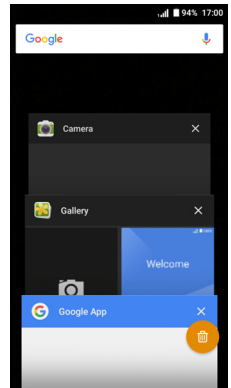

Access requests

When first opening certain apps, or using certain functions, your phone will ask for permission to access some features.

To allow the app to fully function tap **Allow**, but if you do not want to share some information you can choose to **Cancel** or **Deny** access; however this may cause some apps to function incorrectly. To change permissions later, open the app info in **Settings > Apps > Add account**, then tap **Permissions** to turn permissions on or off.

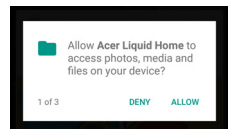



MANAGING CONTACTS

Managing your contacts

Your phone features an address book that allows you to save contacts to either the internal memory or onto your SIM card.

Tap the **Contacts** app from the *Apps list* or tap the *All contacts* icon from the *Dialer* to view your contacts.

If you don't have any contacts stored on your phone, you can import your Google account contacts, add a new contact or import contacts from your SIM or SD card. Open the **People** app from the *Apps list* and then tap  to add a contact,  to search for a contact, or tap the *Menu* icon  to open the menu.

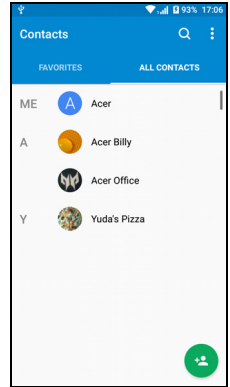

Adding a contact

Tap  to add a new contact. You may also scan a person's profile barcode to add the person to your contact list or group.

To create a contact, first choose where you want to store the contact's information. You will then be asked to enter the contact's information, such as name, phone number, and email.

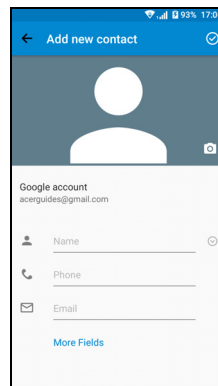
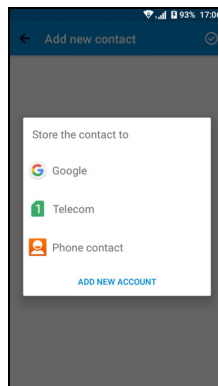



You may scroll down the page and tap **More fields** to add things such as:

- IM addresses.
- Add any personal notes about the contact.
- Phonetic name
- Link a website

To assign an image to your contact, tap the silhouette and select whether to take a photo or select an image from your phone's picture gallery.

When done, click the *Done* icon at the top of the screen.

Tapping on the contacts name will bring up their profile. Tap  while viewing a contact's profile to delete, share, or create a shortcut on the *Home screen* for the contact. Tap  to edit the contact's details; tap  again for more options, where you may set a ringtone for the contact, send all incoming calls to voicemail, or merge with a duplicate contact entry.

You may also create a contact from an already dialed or received number, **see [Saving a dialed number to contacts on page 26](#)**.

MAKING CALLS

This chapter shows you how to make phone calls, and the various options available to you during your call.

Before making a call

Check that the phone function is on before you make a call. You can confirm the phone status from the Notification area.



Note

You will see an indicator icon for each SIM card inserted.

Icon	Description
	Connected to the network: You may make a call.
	Airplane mode: Wireless connectivity disconnected (Wi-Fi, Bluetooth, and cellular). Please disable airplane mode before trying to make a call.

Making a call



Note

If you have multiple SIMs inserted in the phone, you may be asked which SIM to use before the call is connected. To select a SIM, just tap the name of the carrier. See [SIM Management on page 49](#).

1. From the *Home* screen tap **Phone** then to open the onscreen number pad.
2. Enter the number you wish to dial.
3. Tap to make the call.
4. To end the call, tap .

If the contact you need is displayed, simply tap the contact name to make a call.

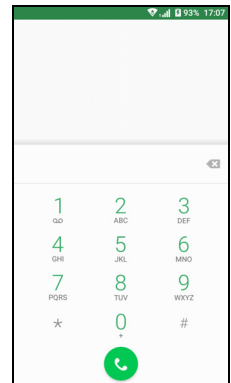

Dialing a number from Call History

Your call history can be viewed by tapping the *Call History*  icon. It displays recent received, dialed, and missed calls.

Tap the phone icon to redial. To view call details and other options, tap the number or contact's name.

Viewing missed calls

Missed call notifications are displayed in the following three areas:

1. The Notification area with the missed call  icon. Open the **Notification** area and tap the missed call notification to display the missed call details.
2. By the Phone icon (the number in the box is the number of missed calls). Tap **Phone** from either the *Home screen* or the *Apps list* to directly display the missed call details.
3. On your phone's lock screen. Double-tap the notification to display the missed call details.

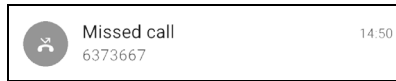

Making a call to one of your contacts

Calling a contact from the Contacts tab

1. Tap the **All contacts** to view your contacts.
2. Tap on a contact to call them.

Calling a contact from the Contacts app

1. Tap the **People** icon the *Apps list* to view your contacts.
2. Tap on a contact to open their profile.
3. Tap on the contact's phone number to call them.

Dialing an international number

When dialing international numbers, there is no need to enter the international direct dialing prefix ('00' etc.) before the country code.

Simply tap and hold 0+ on the onscreen number pad until + appears onscreen.



Important

International call rates can vary greatly depending on the country you are calling and your network provider. We suggest you check all call rates with your network provider, to avoid excessive phone bills. If you are using your phone abroad, roaming charges will apply. Consult your network provider for roaming rates specific to the country you are visiting before you leave.

Direct dial widget

You may add a direct dial widget for a contact on your *Home* screen. Open the *Apps list*, then tap the **Widgets** tab. Tap and hold **Direct dial** and you will be able to place the widget on your *Home* screen. Once placed, you will be able to select a contact to associate with that particular widget on your *Home* screen.

The voice call screen

Answering or declining a call



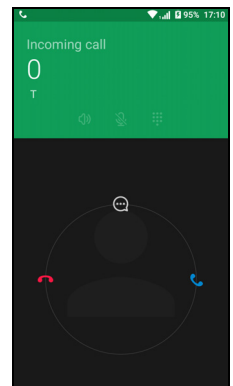

When you have an incoming call, the number will be shown on the screen. To accept or decline the call, tap and hold the phone icon in the middle of the screen, then slide your finger across the screen towards one of the three icons that appear.



Ending a call

To end a call, tap  from the voice call screen.

Voice call options



Icon	Description
	Place the call on hold.
	Mute a call.
	Speakerphone.
	Access the keypad while a call is in progress.
	One option: <ul style="list-style-type: none"> • Add a second call

Saving a dialed number to contacts

You can save a number you have dialed to your contacts for future use. From the *Call History* , tap the number and then tap **Create new contact** and enter the information. **See Adding a contact on page 21**. Alternatively you can tap **Add to a contact** to update an existing contact's information.

Conference calls

If you have one call on hold and another on line, you can combine both calls to create a conference call.

After the first call is established, tap  to add a second call. Tap  to start the conference call.

TEXT AND MULTIMEDIA MESSAGES

This chapter shows you how to set up and use the *Messaging* app on your phone to send text (SMS) messages.

All SMS and MMS messages are accessed via *Messaging*. *Messaging* automatically arranges received and sent messages into threads.

To access *Messaging*, open the *Apps list* or tap **Messaging** on the *Home screen*.





Note

If you have multiple SIMs inserted in the phone, you will need to decide which SIM to use before sending the message. You will be able to see which SIM is the current SIM from the compose text box. To change SIM, tap and hold the send icon.

See SIM Management on page 49 for more information.

Creating a new message

You can use your phone to compose text (SMS) and multimedia (MMS) messages.

1. Tap  to compose a new message.
2. Tap  to add contacts from your contacts list, or tap the **Type name or number** field to enter the recipient's phone number or name directly. Suggested contacts will be displayed in a drop-down list below the text field. To select a suggested contact, tap the contact's name.

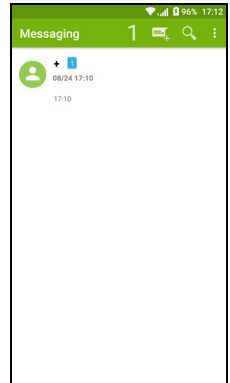

3. Enter your message in the text box labeled **Type text message**.



Note

Text messages may be up to 160 characters long. If your message is longer than 160 characters, it will be sent as multiple linked messages. Most phones will automatically join the linked messages to present the recipient with a single long message, however, some older phones do not have this ability.

Tap the menu button to see what options are available when creating a new message. The options change depending on the status of the message.

Option	Description
Add subject	Add a subject to the message.
Discard	Discard the message.
Settings	Additional settings for messages.

4. Tap the *Send* icon ➤ to send the message.

Replying to a message

When a new text message arrives a message icon appears in the Notification area and the message icon at the bottom of the phone displays the number of unread text messages.

Tap **Messaging** from the *Apps list* to view the message list or open the **Notification** area to see a summary of the message. Tap the summary to open the message list.

To reply to an SMS or MMS message, open the message from the message list. Enter your text in the text box labeled **Type message**. Tap the *Menu* button to see more options.

Option	Description
Add subject	Add a subject to the message.
Send	Send a reply to the message.
Delete thread	Delete the message.
Add to Contacts	Add the sender to your contacts list.
Chat settings	Additional settings for messages.

Multimedia messages

Multimedia messages are similar to text messages but also allow you to attach files such as pictures, audio or video clips. Each message can be up to 300 kB in size.





Note

You need to set up an MMS profile before you can send MMS messages. Normally, your phone will set up the profile automatically. Ask your network provider for the necessary information if you need to manually set up the MMS profile.

Sending a multimedia message

Follow the instructions in **Creating a new message on page 27** to start a new message or reply to an existing SMS as described in **Replying to a message on page 28**.

1. To convert an SMS to a multimedia message, tap the *Add attachment* icon  at the top of the screen.
2. This opens a list of attachment options. Select one to either find a file on your phone or create a new attachment.
3. Tap the *Send* icon  to send the message.

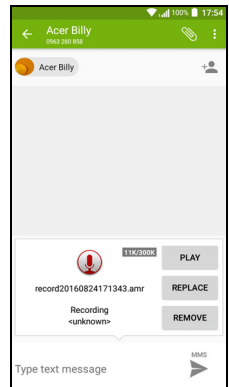

Receiving multimedia messages

When a new multimedia message arrives, a message icon appears at the top of the screen and a notification message is displayed.

1. The notification message displays a summary of the message. Tap **View** to view a summary of the message.
2. Tap **Download** to download the message content. Downloads can take a long time, depending on your connection quality. If you reply or open another app, the download will be stopped.



Important

You may be charged to download message content, especially if you are roaming. Please contact your provider if you have any questions.

3. Tap the message to view the content.
4. To reply to the message, enter your text in the text box labeled **Type message** and tap the Send icon ➤. Simple text replies will be sent as SMS messages. If you wish to attach a file, tap ⋮. You will be presented with a menu of options.
5. Tap the *Send* icon ➤ to send the message.

GOING ONLINE

Browsing the internet

In order to browse the internet with your phone, you must be connected to a data or wireless network.

Using the browser

To start browsing, tap the **Chrome** icon in the *Favorites tray* or the *Apps list*.



Note

Reference images use the Chrome browser.

To open a new website, tap the address box at the top of the page. Enter the address using the keyboard and tap **Go** →. You can zoom in or out of pages by pinching or reverse pinching.

To navigate forward and backward in your browser's history, view your bookmarks, adjust browser settings, and perform other tasks, tap the *Menu* icon **:**.

Chrome enables you to open multiple pages. By default, tabs are visible in the phone's *Overview* screen. Tap *Overview*

button  to display all of your open tabs (tap again to close). Tap a tab from the list to open it. To open a new tab, tap the *Menu* icon **:** > **New tab**.

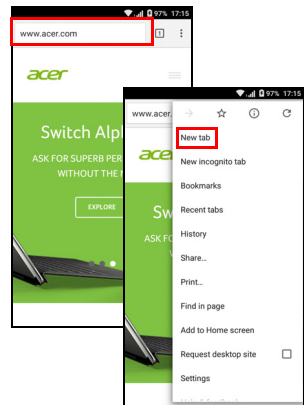

Setting up email

Your phone enables you to access your email through the *Gmail* app. If you sign in for the first time using a Gmail account, your information will automatically be used to create your Inbox on your phone.

To add another account, open **Settings** from the *Apps list*, then tap **Accounts > Add account > [account type]**.

Enter the email address for the new account. If you have selected the wrong account type, you will be asked to confirm which account type to use.

Enter the password for the account and, if necessary, grant the *Gmail* app permission to access your account.

Most popular ISPs can be set up in just a few steps. If you are unable to set up the account automatically, enter your email address and tap **Manual setup** to enter the parameters manually. Tap **Next** to finish the setup process.

Google services



Note

Apps may not be available in all countries and regions.

You must activate a Google account before using Google services. The first time you access Google services, you must read and accept the Terms of Service.

Setting up your Google email

1. Make sure your phone is connected to a data or Wi-Fi connection.
2. From the *Apps list* tap **Gmail**.

If you did not enter your Gmail account address and password when you first started your phone, follow the onscreen instructions.

Composing an email

1. Make sure your phone is connected to a data or Wi-Fi connection.
2. From the *Apps list* tap **Gmail**.
3. Tap .
4. Enter the recipient's email address, the subject and message.
5. When you are finished composing your message, tap **➤**.

Voice search

With voice actions, you can send text messages, place calls, send emails, find directions of establishments, automatically call establishments, search the internet and even send a note to yourself using your voice. Tap **Voice Search** from the *Apps list*, or tap the *microphone icon*  on the *Home screen*.

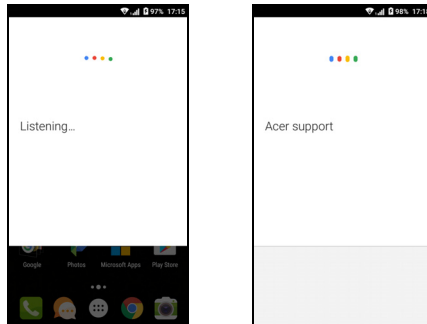

Play Store



Important

For connection issues with Play Store, see [FAQ and troubleshooting](#) on page 51.

Tap **Play Store** from the *Apps list* to open the *Google Play* app. Here you can obtain a variety of apps to enhance your phone.

The contents and design of *Google Play* varies by region. For example, in some regions, you can also browse for and purchase movies, books, magazines, or music. Updates may add new categories or change how to navigate *Google Play* at any time.

You can browse the store by category or tap the search icon to search for a specific app.

Once you have selected an app, tap **Install** to download and install the app. You will be told which services the app requires access in order to function correctly (e.g. contact information, wireless

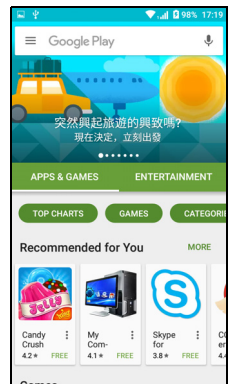

access, GPS). If none of these services seem unusual, tap **Accept & download** to proceed with the installation.

You may keep track of the download progress from both the app's page and the notification area.

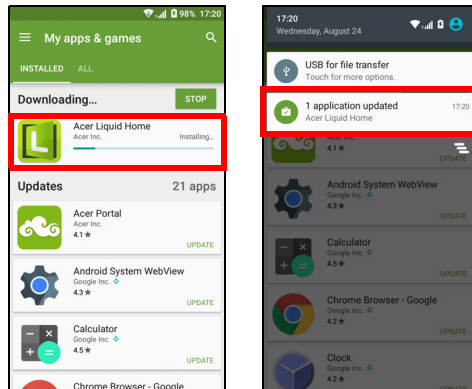

Important

Some apps may require payment before you can download them. You will need to have a Google Wallet account in order to pay for these apps, or a credit card number associated with your Google account.

Using downloaded apps

Once you've downloaded and installed an app, you may find it in the *Apps list* or *Widgets* list.

Certain apps provide both an App and widget, or only provide a widget (with no app icon). See [Personalizing the Home screen on page 15](#).

Uninstalling downloaded apps

Once you've downloaded and installed an app, you may uninstall the app by opening the *Apps list* and tapping **Settings > Apps**. Scroll through the list of apps and select the the app you wish to uninstall. Tap **UNINSTALL**.



Note

Deleting an app icon from the Home screen only deletes the shortcut.

Google Hangouts

Tap **Hangouts** from the *Apps list* to open *Google Hangouts*. Here you can see a list of your contacts connected to *Google Hangouts* services. Tap on a contact to open a chat session. After you have connected, you can open a video chat session.

Maps, Navigation and Places

Get easy-to-follow directions using *Google Maps*, view real-time traffic condition and navigate by using spoken, turn-by-turn driving instructions. Also, view where your friends are, places of interest, and local businesses.



Note

*Maps does not have information about every location.
Some locations may not have all zoom levels.*

Using the map

Tap the **Maps** icon in the *Apps list*. Drag the map with your finger to move the map around.

To zoom in or out:

1. Double-tap a location on the map to zoom in on the location, and tap once to zoom out, or
2. Touch an area with two fingers at once and spread them apart to zoom in, and pinch them together to zoom out.

USING THE CAMERA AND VIDEO RECORDER

Your phone features two cameras (front- and rear-facing). This section will take you through all the steps in taking photos and videos. To open the camera or video recorder, tap **Camera** from the *Apps list* or the *Favorites tray* (⋮).



Note

You can only save photos and videos to internal memory.

Camera/video icons and indicators

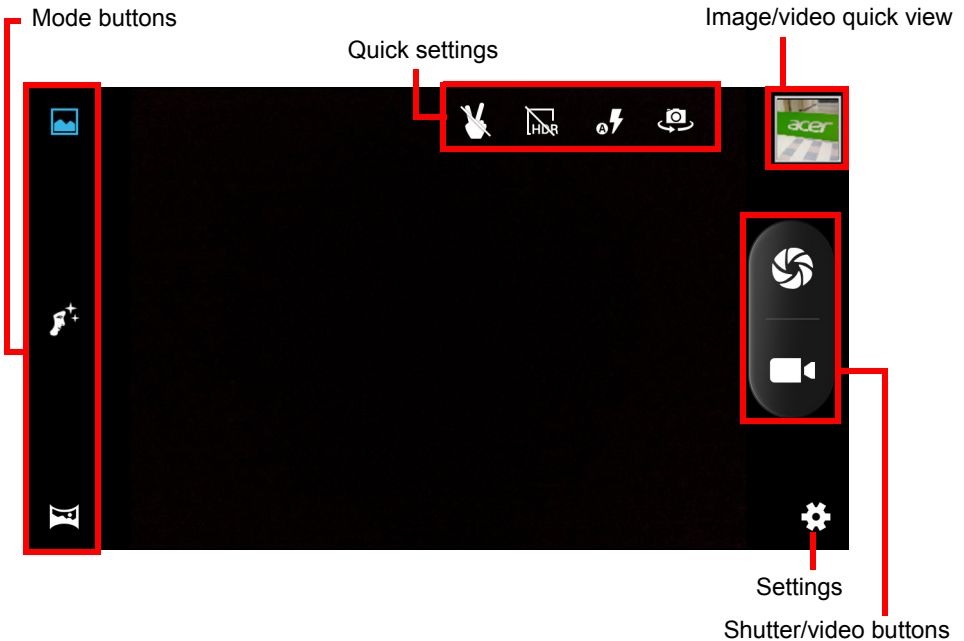

Mode buttons: In the camera window, if they are not visible, swipe in from the left to display the mode buttons: *Normal*, *Face beauty*, and *Panorama*.

Quick Settings: Tap an icon to turn *Gesture detection* or *HDR* on or off, to set the flash mode, or to switch between the front and rear cameras.

Settings: Tap the *Settings* icon to change general, camera, and video settings.

Shutter/Image buttons: Tap the shutter button to take a photo. Tap the *camera* button to begin recording. While recording, camera/video settings cannot be changed. Tap the camera again to stop filming.

Zoom: To zoom in, reverse pinch the screen. To zoom out, pinch the screen.

Focus and light levels: To set the focal point, tap the desired area on the screen.

For more information about modes, settings and options, [see Camera and video options on page 38](#).

Taking a photo

1. Ensure the options are set to your preferences.
2. Frame your subject and steady your phone.
3. Zoom in or out as needed.





Note

When zooming, the image on the screen does not represent the quality of the final image.

4. Tap  to take the photo.



Recording a video

1. Ensure the options described above are set to your preferences.
2. Frame your subject and steady your phone and zoom in or out as needed.
3. Tap  to begin recording.
4. Tap  to stop recording.

Viewing photos and videos

After you have taken your photo or video, it is automatically saved to internal memory. You can quickly view it by tapping the thumbnail in the corner of the screen. Alternatively, open the *Apps List* and tap

Gallery, then **Camera**. Tap the photo or video you want to view (videos are marked with a small play symbol).

You can share and edit your images. Tap  to see sharing options available for the file or tap  to display image editing options.

Camera and video options

Mode

Change the way your camera takes pictures:

Mode	Description
Normal	Take a single picture.
Face beauty	Add skin smoothing effects (see <i>Camera</i> under <i>Settings</i>).
Panorama	Take a series of images that will be combined to make a single extra-wide picture.

Settings

Settings are divided into three sections: *General*, *Camera* and *Video*.

General

Adjust general image settings with these options:

Setting	Options
Store location	Set if the location (from GPS) is stored in the image information. Certain apps can use this to show where the photo was taken
Exposure	-3 to +3
Color effect	None / Mono / Sepia / Negative / Aqua / Blackboard / Whiteboard
Scene mode	Auto / Night / Sunset / Party / Portrait / Landscape / Night portrait / Theatre / Beach / Snow / Steady photo / Fireworks / Sports / Candle light
White balance	Auto / Incandescent / Daylight / Florescent / Cloudy / Twilight / Shade / Warm florescent

Setting	Options
Image properties	Sharpness / Hue / Saturation / Brightness / Contrast
Anti-flicker	Auto / Disabled / 50 Hz / 60 Hz

Camera

Adjust camera image settings with these options:

Setting	Options
Zero shutter delay	On / off
Face detection	On / off
Smile shot	On / off
Auto scene detection	On / off
Self timer	Off / 2 seconds / 10 seconds
Capture number	40 shots / 99 shots (for <i>Continuous shot</i>)
Picture size	Up to 5 MP
Preview size	Full screen / Standard (4:3)
ISO	Auto / 100 / 200 / 400 / 800 / 1600
Face beauty	Wrinkle removal / Whiten / Shape

Video

Adjust video settings with these options:

Setting	Options
EIS	On / off
Microphone	On / off
Audio mode	Normal / Meeting
Time lapse interval	Off / 1 / 1.5 / 2 / 2.5 / 3 / 5 / 10 seconds
Video quality	Low / Medium / High / Fine

Supported formats

To see supported image, video, and audio formats, see [Connectivity on page 59](#).

ADVANCED SETTINGS

Putting your phone in Airplane mode

You can enable Airplane mode (also known as flight mode) to turn off cellular, Wi-Fi and Bluetooth functions and use your phone as a handheld device during a flight. Check with your airline to make sure this is permitted onboard.

Switch your phone off during takeoff and landing as it may interfere with aircraft electronic systems.

To turn Airplane mode on or off, open *Quick Settings* and tap  .

Airplane mode

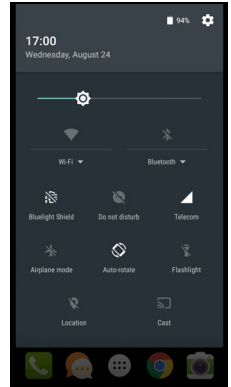

Restarting your phone

You can restart ('reboot') your phone if you find apps are not responding.

1. Press and hold the power button until you get the phone options menu.
2. Tap **Restart**.

Adjusting settings

Wireless & networks (managing connections)

Open the *Apps list* and tap **Settings** to manage your connection settings.

Item	Description
Wi-Fi	Turn the Wi-Fi function on or off.
Bluetooth	Turn the Bluetooth function on or off.
SIM cards	Set a default SIM for particular functions (such as voice calling or messaging), turn the data connection on or off, set roaming preferences and associate contacts with a SIM.

Item	Description
Data usage	View an estimate of the mobile data used for each SIM.
Call Settings	Change various settings related to making and receiving calls.
More...	<p>Access additional connection settings:</p> <p>Airplane mode: Disable all wireless connections so you can safely use this device onboard an aircraft.</p> <p>Tethering & portable hotspot: Share your phone's mobile data connection via USB or as a portable Wi-Fi hotspot.</p> <p>VPN: Set up and manage Virtual Private Networks.</p> <p>Cellular/Mobile networks: Set your options for connecting to cellular networks.</p>

If your phone is in Airplane mode, the option to turn Bluetooth on will be disabled. Please refer to **Putting your phone in Airplane mode on page 40** for instructions on turning Airplane mode on or off.

Adjusting Bluetooth settings

You can use Bluetooth to exchange information between your phone and other mobile devices.

Bluetooth connections

For all Bluetooth settings, open the *Apps list* and tap **Settings > Bluetooth**. Tap the toggle switch next to turn Bluetooth on or off. When you turn Bluetooth on, your phone will automatically search for any nearby devices that are discoverable. Your phone will be discoverable as long as you have the Bluetooth settings open.

To connect to a device, tap the device in the list of available devices. You may be asked to enter a PIN on both devices to establish the connection.

To simply turn on or off Bluetooth, open the **Notification** area and tap the **Bluetooth** icon.

Internet sharing

Tethering via USB

If you wish to share your mobile internet connection with a computer, you can connect your phone to a PC using the supplied USB cable.

1. Plug the USB sync cable into the USB connector on your phone.
2. Plug the USB client connector into an available USB port on your computer.
3. Open **Settings** > **More..** > **Tethering & portable hotspot** > **USB tethering** to turn USB internet sharing on or off.

Wi-Fi hotspot

You can turn your phone into a portable Wi-Fi hotspot to share your mobile internet connection with up to eight clients.

1. Open **Settings** > **More...** > **Tethering & portable hotspot** > **Wi-Fi hotspot**.
2. Tap **Set up Wi-Fi hotspot**, and change the *Network name*, security, and password as necessary. Tap **SAVE** to finish.



Note

When your phone is serving as a Wi-Fi hotspot, you can only access the internet via your phone's data connection, and you may incur data charges.

Phone network settings

In the *Apps list* tap **Settings** > **More...** > **Cellular networks** to adjust your network settings. You can turn data connection on or off when roaming, choose a preferred network type, specify a network operator and define access point names.

Selecting a network

Your phone will automatically detect your carrier/network settings when you insert a new SIM card. However, you may prefer to manually select a network when roaming.



Note

When you are traveling, manually selecting a network may help to reduce your roaming charges. Check with your home service provider for the network offering the most competitive rates at your destination.

1. Open the *Apps list* and tap **Settings** > **More...** > **Cellular networks** > **Network operators** > **Search networks**.
2. Your phone will search for available networks.
3. Select your preferred network from the list generated. Your phone will attempt to register on the selected network.
4. Tap **Select automatically** to connect to the available network with the strongest signal. This may lead to your phone jumping between networks when you move around.



Note

Contact your service provider should you have any problems obtaining voice mail and the text message service center numbers.

Data usage control settings

Data usage controls let you monitor total usage by network type and app and then set limits if needed.

Ensure Wi-Fi or mobile data is enabled before setting a limit. Access data usage settings from the *Apps list* by tapping **Settings** > **Data usage**. Tap **Set cellular data limit** to set a threshold at which your data connection will automatically be disabled.



Important

Your phone and your cellular carrier may calculate data usage using different criteria. Your carrier will charge you according to their methods: Please consider setting a conservative limit.

Phone settings

Many phone settings are automatically configured by your phone when you insert a SIM card. The device will communicate with your provider and automatically obtain all necessary settings, such as network name, voice mail and text message center numbers.

You can also view and modify these settings manually through the Call settings screen.

Open **Settings** > **Call settings**.

Adjusting the volume

Adjust the volume of your phone using the volume button on the side of the phone. Alternatively, you can set the Ringtone and Alarms volume by opening **Settings** > **Sound & notification** and then tapping the settings icon next to the *General* profile.

Display

To adjust your phone's display settings, in the *Apps list* tap **Settings** > **Display**.

You can also adjust the screen brightness, turn casting or screen rotation on or off from *Quick Settings*.

Setting the date and time

To set the date and time, open **Settings** > **Date & time**.

If you travel frequently or live in an area that uses daylight saving time, tap **Automatic date & time** and **Automatic time zone** to turn them both on. This will enable your phone to set the date and time based on information it receives from the network.

Setting alarms

There are two predefined alarms on your phone by default. Open **Clock** from the *Apps list*, and then tap  to view the alarms. Tap and hold an alarm to change its settings. You may:

- Turn the alarm on or off.

- Set the alarm time.
- Set which days to repeat the alarm.
- Set a ringtone.
- Enable or disable vibrate.
- Give it a label.

Changing language and text options

Set your location and language input preferences by opening **Settings > Language & input**.

Connecting to a PC

If you wish to transfer information between your device and your computer (either the microSD card in your device or the device's internal memory), you can connect your device to a PC using the supplied USB cable.

1. Plug the USB sync cable into the USB connector on your phone.
2. Plug the USB client connector into an available USB port on your computer.
3. Open the notification area and tap **USB for charging** then choose **File transfers**.

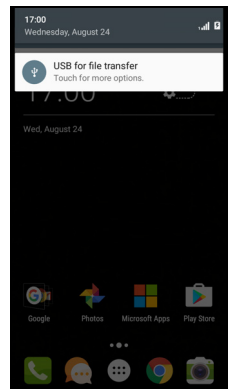

Your device will now be available as a drive in your computer's file explorer.



Note

After turning on USB storage, you will not be able to access the files in the microSD card or apps such as Gallery or Music.

Synchronization

You can sync your calendar, email and contacts on your phone and never worry about losing them again. Sync in real time or adjust it as you please. Open **Settings** > **Accounts** > [account name] to access the synchronization settings.

To add a new account, tap **Add account**. Select the type of account and then follow the onscreen instructions.

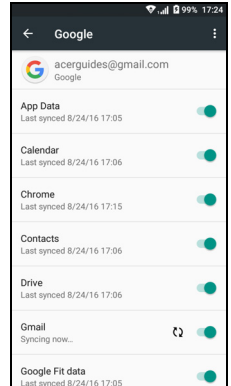

Google Sync

In Google, you can set synchronization for Google services. In your Google account's synchronization settings menu, tap the item you would like to have auto-sync. Tap again for manual synchronization.

To manually synchronize an item, make sure toggle switch next to the item is turned on, tap the **Menu** icon and then tap **Sync now**.



Note

You need a Google account to sync your calendar and appointments.

Apps (applications)

Uninstalling an app

You can remove programs installed on your phone to free up extra storage memory. From the Apps list, tap and hold the app you wish to uninstall, and then drag it to "Uninstall" at the top of the screen. You will be asked to confirm the uninstall; tap **OK**.



Important

Can only uninstall apps that you have downloaded from Play Store.

Restoring to factory settings

You may perform a clean boot to restore your phone to the factory settings. Before performing a clean boot, ensure that your phone is not locked. Press any button or tap the screen to see if the phone responds.



Important

You should only perform a clean boot when all other options have failed to restore your phone to an operational state.

This will erase all your personal information, any contacts stored on your phone and any programs you installed.

If your phone is responding to screen input, then open **Settings** from the *Apps list*. Tap **Backup & reset > Factory data reset > Reset phone** and then **Erase everything** to format your phone.

ACCESSORIES AND TIPS

This chapter shows you how to use accessories with your phone, as well as provide useful tips for when you are using your phone.

Using the headset

Your phone is compatible with headsets with built-in microphone for handsfree use when making calls.

To use the headset, plug it into the 3.5 mm headphone jack at the top of the phone.

When the headset is plugged in, all audio is routed to the headset, and the speakers are turned off.



- To answer an incoming call, press the button on the microphone.
- Adjust the volume using the volume up/down button on the phone.
- End the call by pressing the button again.

Using a Bluetooth headset

Your phone's Bluetooth functions make it fully compatible with all Bluetooth headsets. This allows you to use the unit handsfree when making calls, without the inconvenience of wires.

Creating a new access point

When you need to add another cellular connection on your phone, obtain the access point name and settings (including username and password if required) from your wireless service provider.

1. Open the *Apps list* and tap **Settings** > **More...** > **Cellular networks** > **Access Point Names**, and select an operator.
2. Tap the *Add* icon  and then enter the APN settings. Tap an item to adjust it.
3. When you have finished tap the *Menu* icon  and then tap **Save**.

MANAGING YOUR SIM CARDS



Note

This chapter is for models with more than one SIM card.

SIM Management

Open the *Apps list* and tap **Settings** > **SIM cards**.
From this screen, you can:

1. Enable or disable each SIM.
2. Configure each SIM's name, phone number, display numbers, and assign a color to each SIM (allowing you to quickly and easily recognize which SIM is active).
3. Set the default SIM for *voice calls*, *data connection*, and *cellular service*.
4. General settings for each SIM.

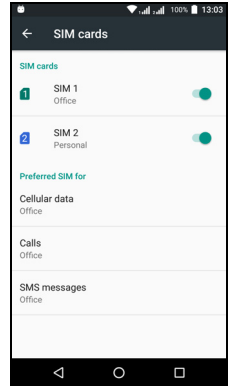

Selecting which SIM to use when making a call

If you have set *Voice call* to **Always ask**, you will be asked which SIM to use each time you make call. Enter the number, then tap . A dialog opens; tap the SIM to use and the call will be connected.

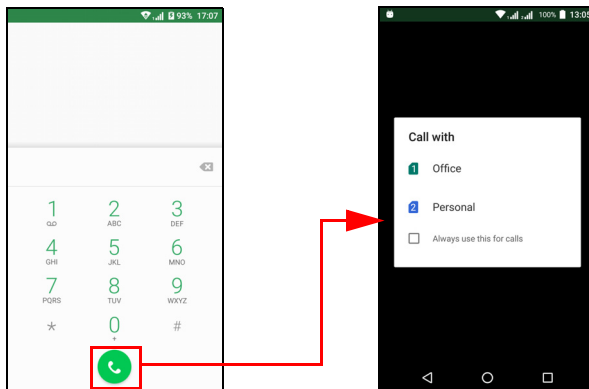

Identifying calls

Whenever you receive a call, the caller's number will be shown using the color defined for the SIM that the call is being received on. You will also be shown the name of the SIM receiving the call.

In the call log, the name of the SIM will be shown beneath the number of the call -- whether the call was missed, answered or was an outgoing call -- in the color you defined for that SIM.

Limitations when using multiple SIMs

When a SIM is:	Other SIM cannot:
In a call	Dial out
Ringing	Receive a call (caller will get a "number not available" message)
Sending or receiving a message	Send or receive a message
Using a data connection	Use a data connection



Note

If you are using data on one SIM and you make or receive a call, or send or receive a text message on another SIM, the first SIM's data connection will be temporarily halted.

APPENDIX

FAQ and troubleshooting

This section lists frequently asked questions that may arise during the use of your phone, and gives easy answers and solutions to these questions.

Audio

Question	Suggestions
Why is there no sound coming from the device?	<p>If the headset is plugged into the device, the speaker is automatically shut off. Disconnect the headset.</p> <p>Check that the device volume setting is not muted.</p> <p>Check that the volume control is not at its lowest setting.</p>

Multimedia files

Question	Suggestions
Why can't I view my picture files?	You may be trying to view an image that is not supported. See Connectivity on page 59.
Why can't I view my video files?	You may be trying to view a video that is not supported. See Connectivity on page 59.
Why can't I play my music files?	You may be trying to play a file that is not supported. See Connectivity on page 59.

Google Play Store

Question	Suggestions
Why can't I connect to the Play Store?	<ol style="list-style-type: none"> 1. First check that you have a Wi-Fi or data connection (some Wi-Fi "hotspots" require you to log in before accessing the internet) and then try again. 2. If you still cannot connect, try adjusting your date/time settings. Open Settings > Date & time and turn Automatic date & time off. 3. Manually adjust the time and then try to reconnect to the Play Store.

System information and performance

Question	Suggestions
How do I check the OS version of my device?	Tap Settings > About phone to check the OS version (Build number) and other hardware and software information.

Power

Question	Suggestions
I can't turn on the device.	The battery power may be depleted. Recharge the device. See Charging the battery on page 6 for more information.

RAM / ROM

Question	Suggestions
How do I check the RAM and ROM memory status?	<p>To check the RAM status, tap Settings > Memory.</p> <p>To check the ROM status, tap Settings > Storage & USB.</p>

Internal storage

Question	Suggestions
My device's available internal storage is full or almost full.	Uninstall apps to increase available storage. See Uninstalling an app on page 46.

Security

Question	Suggestions
I forgot my unlock pattern.	After a certain number of wrong entries, you will be presented with an option to reset your pattern. Tap Forgot pattern? and enter your Google account username and password. <i>You must have an active Google account on the phone.</i> Alternatively, you restore your phone to factory settings. See Restoring to factory settings on page 47.

Temperature

Question	Suggestions
The phone heats up when charging or making long duration calls.	It is normal for the phone to heat up when charging. When charging is complete, it will return to its normal temperature. It is also normal for the phone to heat up during long periods of use, such as watching a video or a long phone conversation.

Other sources of help

For information on	Refer to ...
Up-to-date information regarding your phone	www.acer.com mobile.acer.com
Service enquiries	www.acer.com/support

WARNINGS AND PRECAUTIONS

- Do not use this product near water.
- Do not place this product on an unstable cart, stand or table. If the product falls, it could be seriously damaged.
- Slots and openings are provided for ventilation to ensure reliable operation of the product and to protect it from overheating. These openings must not be blocked or covered. The openings should never be blocked by placing the product on a bed, sofa, rug or other similar surface. This product should never be placed near or over a radiator or heat register, or in a built-in installation unless proper ventilation is provided.
- Never push objects of any kind into this product through cabinet slots as they may touch dangerous voltage points or short-out parts that could result in a fire or electric shock. Never spill liquid of any kind onto or into the product.
- To avoid damage of internal components and to prevent battery leakage, do not place the product on a vibrating surface.
- Never use this product when engaging in sporting activities, exercising, or in any vibrating environment which may cause a short circuit or damage, and even a risk of explosion from the battery pack.

Protecting your hearing

To protect your hearing, follow these instructions.

- Increase the volume gradually until you can hear clearly and comfortably.
- Do not increase the volume level after your ears have adjusted.
- Do not listen to music at high volumes for extended periods.
- Do not increase the volume to block out noisy surroundings.
- Decrease the volume if you can't hear people speaking near you.

Additional safety information

Your device and its enhancements may contain small parts. Keep them out of the reach of small children.

Operating environment



Important

For safety reasons, turn off all wireless or radio transmitting devices when using your phone device under the following conditions. These devices may include, but are not limited to: Wireless LAN (WLAN), Bluetooth and/or cellular.

Remember to follow any special regulations in force in any area, and always switch off your device when its use is prohibited or when it may cause interference or danger. Use the device only in its normal operating positions. To successfully transmit data files or messages, this device requires a good quality connection to the network. In some cases, transmission of data files or messages may be delayed until such a connection is available. Ensure that the above separation distance instructions are followed until the transmission is completed. Parts of the device are magnetic. Metallic materials may be attracted to the device, and persons with hearing aids should not hold the device to the ear with the hearing aid. Do not place credit cards or other magnetic storage media near the device, because information stored on them may be erased.

Medical devices

Operation of any radio transmitting equipment, including wireless phones, may interfere with the functionality of inadequately protected medical devices. Consult a physician or the manufacturer of the medical device to determine if they are adequately shielded from external RF energy or if you have any questions. Switch off your device in health care facilities when any regulations posted in these areas instruct you to do so. Hospitals or health care facilities may be using equipment that could be sensitive to external RF transmissions.

Pacemakers. Pacemaker manufacturers recommend that a minimum separation of 15.3 cm (6") be maintained between wireless devices and a pacemaker to avoid potential interference with the pacemaker. These recommendations are consistent with the independent research by and recommendations of Wireless Technology Research. Persons with pacemakers should do the following:

- Always keep the device more than 15.3 cm (6") from the pacemaker.

- Not carry the device near your pacemaker when the device is switched on. If you suspect interference, switch off your device, and move it.

Hearing aids. Some digital wireless devices may interfere with some hearing aids. If interference occurs, consult your service provider.

Vehicles

RF signals may affect improperly installed or inadequately shielded electronic systems in motor vehicles such as electronic fuel injection systems, electronic anti-skid (anti-lock) braking systems, electronic speed control systems, and air bag systems. For more information, check with the manufacturer, or its representative, of your vehicle or any equipment that has been added. Only qualified personnel should service the device, or install the device in a vehicle. Faulty installation or service may be dangerous and may invalidate any warranty that may apply to the device. Check regularly that all wireless equipment in your vehicle is mounted and operating properly. Do not store or carry flammable liquids, gases, or explosive materials in the same compartment as the device, its parts, or enhancements. For vehicles equipped with an air bag, remember that air bags inflate with great force. Do not place objects, including installed or portable wireless equipment in the area over the air bag or in the air bag deployment area. If in-vehicle wireless equipment is improperly installed, and the air bag inflates, serious injury could result. Using your device while flying in aircraft is prohibited. Switch off your device before boarding an aircraft. The use of wireless teledevices in an aircraft may be dangerous to the operation of the aircraft, disrupt the wireless telephone network, and may be illegal.

Potentially explosive environments

Switch off your device when in any area with a potentially explosive atmosphere and obey all signs and instructions. Potentially explosive atmospheres include areas where you would normally be advised to turn off your vehicle engine. Sparks in such areas could cause an explosion or fire resulting in bodily injury or even death. Switch off the device at refueling points such as near gas pumps at service stations. Observe restrictions on the use of radio equipment in fuel depots,

storage, and distribution areas; chemical plants; or where blasting operations are in progress. Areas with a potentially explosive atmospheres are often, but not always, clearly marked. They include below deck on boats, chemical transfer or storage facilities, vehicles using liquefied petroleum gas (such as propane or butane), and areas where the air contains chemicals or particles such as grain, dust or metal powders.

Follow any restrictions. Do not use the device where blasting is in progress.

Emergency calls



Important

Wireless phones, including this device, operate using radio signals, wireless networks, landline networks, and user-programmed functions. Because of this, connections in all conditions cannot be guaranteed. You should never rely solely on any wireless device for essential communications like medical emergencies.

If certain features are in use, you may first need to turn those features off before you can make an emergency call. Consult this guide or your service provider for more information.

When making an emergency call, give all the necessary information as accurately as possible. Your wireless device may be the only means of communication at the scene of an accident. Do not end the call until given permission to do so.

Taking care of your phone

1. **DO** take care not to scratch the screen of your phone. Keep the screen clean. When working with your phone, use your finger or fingernail. Never use an actual pen or pencil or other sharp object on the screen surface.
2. **DO NOT** expose your phone to rain or moisture. Do not let water enter the circuitry. In general, treat your phone as you would any other small electronic device.
3. **DO** be careful not to drop your phone or subject it to any strong impact. Do not place your phone in your back pocket.

4. **DO NOT** expose your phone to extreme temperatures. For example, do not leave your phone on the dashboard of a car on a hot day or when temperatures are below freezing point. Also, keep it away from heaters and other sources of heat.
5. **DO NOT** use or store your phone in any location that is dusty, damp or wet.
6. **DO** use a soft, damp cloth to clean your phone. If the surface of the screen becomes soiled, clean it with a soft cloth moistened with diluted window-cleaning solution.
7. **DO NOT** press down on the screen with force, otherwise you may crack the screen.

SPECIFICATIONS



Note

Specifications may vary depending on region and configuration.

Performance

- Quad-core processor (MT6580 1.3 GHz)
- System memory:
 - 1 GB RAM
 - 8 GB eMMC
- Android operating system

Display

- 5" IPS LCD, capacitive touchscreen
- 720 x 1280 HD resolution

Dimensions

Height	145 mm
Width	72 mm
Thickness	9.8 mm
Weight	165 g (with battery)

SIM support

- Two slots (2x micro-SIM)

Connectivity



Note

Frequencies and bands supported vary depending on model.

- Bluetooth 4.0 + LE

- IEEE 802.11b/g/n
- 3G (HSPA+/WCDMA):
 - EU, AAP models: 2100 (Band 1) / 900 (Band 8)
- 2G (GSM/GPRS/EDGE):
 - 1900 MHz / 1800 MHz / 900 MHz / 850 MHz
- HSDPA up to 21 Mbps, HSUPA up to 5.76 Mbps
- GPRS Class 12 / EDGE Class 12
- GPS, with aGPS support and SUPL

Expansion

- microSD memory card slot (up to 32 GB; SDHC 2.0 compatible)
- Micro USB connector (with OTG)

Camera

- 5 MP rear camera
 - Auto-focus
 - LED flash
- 2 MP front camera
 - Fixed-focus

Power

- Adapter
 - AC input: 100 to 240 V, 50 or 60 Hz
 - DC output: 5 V, 1 A
 - Micro USB connector
- 2000 mAh nominal-rated Lithium-ion battery (user-replaceable)



Note

Length of battery operation will depend on power consumption which is based on system resource use. For example, constantly using the backlight or using power-demanding apps will shorten battery life between charges.

Multimedia

Formats supported:

Type	Formats
Image	JPEG, GIF, PNG, BMP
Audio playback	MP3, AMR, AAC LC, AAC+, eAAC+, Vorbis, FLAC, MIDI, WAVE
Ringtone	MP3, AMR, AAC LC, AAC+, eAAC+, Vorbis, FLAC, MIDI, WAVE
Video recording	H.263, H.264, MPEG4
Video playback	H.263, H.264, MPEG4, VP8

END USER LICENSE AGREEMENT

IMPORTANT-READ CAREFULLY: THIS END USER LICENSE AGREEMENT ("AGREEMENT") IS A LEGAL AGREEMENT BETWEEN YOU (EITHER AN INDIVIDUAL OR A SINGLE ENTITY), AND ACER INC. INCLUDING ITS SUBSIDIARIES ("ACER") FOR THE SOFTWARE (WHETHER PROVIDED BY ACER OR BY ACER'S LICENSORS OR SUPPLIERS) THAT ACCOMPANIES THIS AGREEMENT, INCLUDING ANY ASSOCIATED MEDIA, PRINTED MATERIALS AND RELATED USER ELECTRONIC DOCUMENTATION WHICH MAY BE BRANDED "ACER" ("SOFTWARE"). AGREEMENTS RELATING TO ANY OTHER PRODUCT OR TOPIC ARE NEITHER INTENDED NOR SHOULD THEY BE IMPLIED. BY INSTALLING THE ACCOMPANYING SOFTWARE OR ANY PORTION THEREOF, YOU AGREE TO BE BOUND BY THE TERMS AND CONDITIONS OF THIS AGREEMENT. IF YOU DO NOT AGREE TO ALL OF THE TERMS AND CONDITIONS OF THIS AGREEMENT, DO NOT CONTINUE THE INSTALLATION PROCESS AND IMMEDIATELY DELETE ALL INSTALLED FILES, IF ANY, OF THE ACCOMPANYING SOFTWARE FROM YOUR PHONE.

IF YOU DO NOT HAVE A VALIDLY-LICENSED COPY OF THE APPLICABLE SOFTWARE, YOU ARE NOT AUTHORIZED TO INSTALL, COPY OR OTHERWISE USE THE SOFTWARE, AND HAVE NO RIGHTS UNDER THIS AGREEMENT.

The Software is protected by U.S. and international copyright laws and conventions as well as other intellectual property laws and treaties. The Software is licensed, not sold.

GRANT OF LICENSE

Acer grants to you the following non-exclusive and non-transferable rights with respect to the Software. Under this Agreement, you may:

1. Install and use the Software only on a single designated phone. A separate license is required for each phone on which the Software will be used;
2. Make one copy of the Software solely for backup or archival purposes;
3. Make one hardcopy of any electronic documents included in the Software, provided that you receive the documents electronically.

RESTRICTIONS

You may NOT:

1. Use or copy the Software except as provided in this Agreement;
2. Rent or lease the Software to any third party;
3. Modify, adapt, or translate the Software in whole or in part;
4. Reverse engineer, decompile, or disassemble the Software or create derivative works based upon the Software;
5. Merge the Software with any other program or modify the Software, except for your personal use; and
6. Sublicense or otherwise make the Software available to third parties, except that you may, after prior written notification to Acer, transfer the Software as a whole to a third party so long as you do not retain any copies of the Software and such third party accepts the terms of this Agreement.
7. Transfer your rights under this Agreement to any third parties.
8. Export the Software in contravention of applicable export laws and regulations, or (i) sell, export, re-export, transfer, divert, disclose technical data, or dispose of, any Software to any prohibited person, entity, or destination including, without limitation, Cuba, Iran, North Korea,

Sudan and Syria; or (ii) use any Software for any use prohibited by the laws or regulations of the United States.

SUPPORT SERVICES

Acer is not obligated to provide technical or other support for the Software.

ACER LIVE UPDATE

Certain of the software contains elements that enable the use of the Acer Live Update service, which allows for updates for such software to be automatically downloaded and installed on your phone. By installing the software, you hereby agree and consent that Acer (or its licensors) may automatically check the version of such software that you are using on your phone and may provide upgrades to such software that may be automatically downloaded on to your phone.

OWNERSHIP AND COPYRIGHT

Title, ownership rights and intellectual property rights in and to the Software and all copies thereof shall remain with Acer or Acer's licensors or suppliers (as applicable). You do not have or shall not gain any proprietary interest in the Software (including any modifications or copies made by or for you) or any related intellectual property rights. Title and related rights in the content accessed through the Software is the property of the applicable content owner and may be protected by applicable law. This license gives you no rights to such contents. You hereby agree

1. Not to remove any copyright or other proprietary notices from the Software;
2. To reproduce all such notices on any authorized copies you make; and
3. To use best efforts to prevent any unauthorized copying of the Software.

TRADEMARKS

This Agreement does not grant to you any rights in connection with any trademarks or service marks of Acer or of Acer's licensors or suppliers.

DISCLAIMER OF WARRANTIES

TO THE MAXIMUM EXTENT PERMITTED BY APPLICABLE LAW, ACER, ITS SUPPLIERS, AND ITS LICENSORS, PROVIDE THE SOFTWARE "AS IS" AND WITH ALL FAULTS, AND HEREBY DISCLAIM ALL OTHER WARRANTIES AND CONDITIONS, EITHER EXPRESS, IMPLIED OR STATUTORY, INCLUDING, BUT NOT LIMITED TO, ANY IMPLIED WARRANTIES, DUTIES OR CONDITIONS OF MERCHANTABILITY, OF FITNESS FOR A PARTICULAR PURPOSE, OF ACCURACY OR COMPLETENESS OF RESPONSES, OF RESULTS, OF WORKMANLIKE EFFORT, OF LACK OF VIRUSES, AND OF LACK OF NEGLIGENCE, ALL WITH REGARD TO THE SOFTWARE AND THE PROVISION OF OR FAILURE TO PROVIDE SUPPORT SERVICES. ALSO, THERE IS NO WARRANTY OR CONDITION OF TITLE, QUIET ENJOYMENT, QUIET POSSESSION, CORRESPONDENCE TO DESCRIPTION OR NON-INFRINGEMENT WITH REGARD TO THE SOFTWARE.

EXCLUSION OF INCIDENTAL, CONSEQUENTIAL AND CERTAIN OTHER DAMAGES

TO THE MAXIMUM EXTENT PERMITTED BY APPLICABLE LAW, IN NO EVENT SHALL ACER, ACER'S SUPPLIERS, OR ACER'S LICENSORS, BE LIABLE FOR ANY SPECIAL, INCIDENTAL, INDIRECT, PUNITIVE, OR CONSEQUENTIAL DAMAGES WHATSOEVER (INCLUDING, BUT NOT LIMITED TO, DAMAGES FOR LOSS OF PROFITS OR CONFIDENTIAL OR OTHER INFORMATION, FOR BUSINESS INTERRUPTION, FOR PERSONAL INJURY, FOR LOSS OF PRIVACY, FOR FAILURE TO MEET ANY DUTY INCLUDING OF GOOD FAITH OR OF REASONABLE CARE, FOR NEGLIGENCE, AND FOR ANY OTHER PECUNIARY OR OTHER LOSS WHATSOEVER) ARISING OUT OF OR IN ANY WAY RELATED TO THE USE OF OR INABILITY TO USE THE SOFTWARE, THE PROVISION OF OR FAILURE TO PROVIDE SUPPORT SERVICES, OR OTHERWISE UNDER OR IN CONNECTION WITH ANY PROVISION OF THIS AGREEMENT, EVEN IN THE EVENT OF THE FAULT, TORT (INCLUDING

NEGLIGENCE), STRICT LIABILITY, BREACH OF CONTRACT OR BREACH OF WARRANTY OF ACER OR ITS SUPPLIERS OR LICENSORS, AND EVEN IF ACER AND ITS SUPPLIERS AND LICENSORS HAVE BEEN ADVISED OF THE POSSIBILITY OF SUCH DAMAGES.

LIMITATION OF LIABILITY AND REMEDIES

NOTWITHSTANDING ANY DAMAGES THAT YOU MIGHT INCUR FOR ANY REASON WHATSOEVER (INCLUDING, WITHOUT LIMITATION, ALL DAMAGES REFERENCED ABOVE AND ALL DIRECT OR GENERAL DAMAGES), THE ENTIRE LIABILITY OF ACER, ITS SUPPLIERS, AND ITS LICENSORS, UNDER ANY PROVISION OF THIS AGREEMENT, AND YOUR EXCLUSIVE REMEDY FOR ALL OF THE FOREGOING, SHALL BE LIMITED TO THE AGGREGATE AMOUNT PAID BY YOU FOR THE SOFTWARE. THE FOREGOING LIMITATIONS, EXCLUSIONS AND DISCLAIMERS (INCLUDING DISCLAIMER OF WARRANTIES AND EXCLUSION OF INCIDENTAL, CONSEQUENTIAL AND CERTAIN OTHER DAMAGES ABOVE) SHALL APPLY TO THE MAXIMUM EXTENT PERMITTED BY APPLICABLE LAW, EVEN IF ANY REMEDY FAILS ITS ESSENTIAL PURPOSE; PROVIDED, HOWEVER, THAT BECAUSE SOME JURISDICTIONS DO NOT ALLOW THE EXCLUSION OR LIMITATION OR LIABILITY FOR CONSEQUENTIAL OR INCIDENTAL DAMAGES, THE ABOVE LIMITATION MAY NOT APPLY TO YOU.

TERMINATION

Without prejudice to any other rights, Acer may immediately terminate this Agreement without notice if you fail to comply with any terms and conditions of this Agreement.

In such event, you must:

1. Cease all use of the Software;
2. Destroy or return to Acer the original and all copies of the Software; and
3. Delete the Software from all phones on which it was resident.

All disclaimers of warranties and limitation of liability set forth in this Agreement shall survive termination of this Agreement.

GENERAL

This Agreement represents the complete agreement between you and Acer relating to this license for the Software and supersedes all prior agreements, communications, proposals and representations between the parties and prevails over any conflicting or additional terms of any quote, order, acknowledgement or similar communication. This Agreement may only be modified by a written document signed by both parties. If any provision of this Agreement is held by a court of competent jurisdiction to be contrary to law that provision will be enforced to the maximum extent permissible and the remaining provisions of this Agreement will remain in full force and effect.

ADDITIONAL PROVISIONS APPLICABLE TO THIRD PARTY SOFTWARE AND SERVICES

Software provided hereunder by Acer's licensors or suppliers ("Third Party Software") is made available to you for your personal, non-commercial use only. You may not use the Third Party Software in any manner that could damage, disable, overburden, or impair the services provided by Acer's licensors or suppliers hereunder ("Third Party Services"). Furthermore, you may not use the Third Party Software in any manner that could interfere with any other party's use and enjoyment of the Third Party Services, or the services and products of Acer's licensors' or suppliers' third party licensors. Your use of the Third Party Software and Third Party Services is also subject to additional terms and conditions and policies which can be accessed through our global website.

Privacy policy

During registration you will be asked to submit some information to Acer. Please refer to Acer's privacy policy at www.acer.com or your local Acer website.