



LINEAR PCM RECORDER

LS-P5

Linear PCM Recorder
USER MANUAL

Getting started

1

Recording

2

Playback

3

Menu

4

Bluetooth® function

5

Use with a computer

6

Other information

7

Safety precautions

8

- Thank you for your purchase of our company's voice recorder. Consult this manual while operating the recorder to ensure that you are using the product safely and correctly.
- Be sure you have read and understood the contents of **"8. Safety precautions"**, before using this product. Keep these instructions available for future reference.
- Read this manual thoroughly before using the product and record test audio to confirm that it is functioning normally before making important recordings.
- The screen and product illustrations shown in this manual were produced during the development stages and may differ from the actual product.
- If there are additions and/or modifications of functions due to firmware update for the recorder, the contents will differ. For the latest information, please visit our website.

Table of contents

Names of parts.....	6
Recorder.....	6
Display.....	7

1 Getting started

Setup.....	11
Inserting batteries.....	12
Charging batteries.....	13
Setting the time/date.....	15
Charging the batteries.....	16
Charging the Batteries from a Computer via USB... ..	16
Charging the batteries by connecting to an AC adapter with a USB connection (model F-5AC; optional).....	18
Batteries.....	20
Inserting/removing a microSD card.....	22
Inserting a microSD card.....	22
Removing a microSD card.....	24
Turning the power ON/OFF.....	26
Turning the power ON.....	26
Turning the power OFF.....	26
Preventing accidental operation.....	27
Setting HOLD mode.....	27
Releasing HOLD mode.....	27
[Home] screen operations.....	28
Selecting the mode.....	28
Folders.....	29
Folders for Audio Recordings.....	29
Music Folders.....	32
Selecting folders and files.....	33

2 Recording

Recording.....	35
Basic recording procedure.....	35
Adjusting Recording Levels Automatically Before Recording ([SMART] Mode).....	38
Adjusting Recording Levels Manually Before Recording.....	41
Pausing/resuming recording.....	43
Quickly checking a recording.....	43
Monitoring while recording.....	45
Using Earphones Connected to the Earphone Jack to Monitor Sound During Recording.....	45
Monitoring Recording Using Earphones Connected via Bluetooth®.....	46
Selecting the automatic recording setting [Rec Scene].....	47
Changing the recording scene.....	47
Creating Custom Recording Scenes.....	51
Recording Using External Mics or Other Input Devices Connected to the Recorder [External Input].....	53
Choosing an Input Device.....	53
Recording Using External Mics and Other Input Devices.....	55
Recording audio from another device with this recorder.....	56
Recording audio from this recorder with another device.....	57

Table of contents

3 Playback

Playback	58
Basic playback procedure.....	58
Fast-forwarding.....	60
Rewinding.....	60
Skipping to the beginning of a file.....	61
Playback Using the Earphones Connected to the Earphone Jack.....	63
Playback Using Earphones Connected via Bluetooth®.....	64
Changing the playback speed	66
ABC repeat playback	67
Index marks/temp marks	70
Writing an index mark/temp mark.....	70
Erasing an index mark/temp mark.....	71
Calendar Search function	73
Erasing files/folders	74
Erasing files.....	74
Erasing a folder.....	75

4 Menu

Setting menu items	77
Basic operation.....	77
File menu [File Menu]	80
Extracting the speaking portions of files of spoken-word content [Voice Detect].....	80
Preventing accidental file erasure [File Lock].....	80
Sorting files [Sort by].....	80
Moving/copying files [Move/Copy].....	81
Dividing files [File Divide].....	81
Partially erasing files [Partial Erase].....	81
Trimming a file [Trimming].....	81
Increasing the overall volume level of a file [Normalize].....	81
Fading in/out audio at the beginning/end of a file [Fade in/out].....	82
Adding Prefixes to File Names [Rename File].....	82
Displaying file or folder information [Property].....	82

Recording menu [Rec Menu]	84
Selecting the recording level [Rec Level].....	84
Reducing clipping [Limiter].....	85
Setting the recording mode [Rec Mode].....	85
Selecting microphone directivity [Zoom Mic].....	86
Reducing noise during recording [Low Cut Filter]....	87
Recording clear audio [Bright Sound].....	87
Selecting the automatic recording setting [Rec Scene].....	88
Disabling output during recording [Rec Monitor].....	88
Recording Using External Mics or Other Input Devices Connected to the Recorder [External Input].....	88
Starting recording at a set time [Timer Rec].....	88
Placing the recorder on standby before recording [Rec Standby].....	89
Choosing a recording method [Fn Rec].....	89
Choosing the Voice Sync Time [V-Sync. Time].....	93
Recording a Reference Tone for Use When Synchronizing Audio and Video [Slate Tone].....	93
Adjusting Sound Level for Output to the Camera [Test Tone].....	93
Playback menu [Play Menu]	94
Skipping non-voice portions during playback [Voice Playback].....	94
Reducing noise during playback [Noise Cancel].....	94
Adjusting low volume portions during playback [Voice Balancer].....	95
Selecting playback modes [Play Mode].....	95
Changing music sound quality [Equalizer].....	96
Setting a skip space [Skip Space].....	97
LCD/Sound menu [LCD/Sound Menu]	98
Setting the backlight [Backlight].....	98
Adjusting the contrast [Contrast].....	98
Setting the LED indicator light [LED].....	98
Turning beeping sound on/off [Beep].....	98
Changing the display language [Language].....	98
Playing the beginning of files automatically [Intro Play].....	99
Selecting the speaker output [Speaker].....	99

Table of contents

Device menu [Device Menu]	100
Connecting a Bluetooth® device [Bluetooth]	100
Selecting the recording media [Memory Select]	100
Setting power save mode [Power Save].....	100
Choosing the type of battery in use [Battery].....	100
Setting the time/date [Time & Date].....	101
Setting the USB connection [USB Settings]	102
Restoring the default settings [Reset Settings].....	102
Formatting a recording media [Format]	103
Checking recording media information [Memory Info.].....	103
Checking voice recorder information [System Info.].....	103
Viewing Certification Marks [Certification]	104
Extracting the speaking portions of files of spoken-word content [Voice Detect]	105
Moving/copying files [Move/Copy]	108
Dividing files [File Divide]	111
Partially erasing files [Partial Erase]	113
Trimming a file [Trimming]	115
Fading in/out audio at the beginning/end of a file [Fade in/out]	117
Starting Recording at a Set Time [Timer Rec]	118
Choosing a Recording Method [Fn Rec]	121
Starting Recording Before You Press Record [Pre-Recording].....	123
Using Overdubbing [Over Dubbing].....	125
Recording a Reference Tone for Use When Synchronizing Audio and Video [Slate Tone]	126
Adjusting Sound Level for Output to the Camera [Test Tone]	129
Setting the USB connection [USB Settings]	131
USB Connection Settings	131
USB Class	132
Formatting recording media [Format]	133

5 Bluetooth® function

Before using the Bluetooth® function	135
Connecting/disconnecting a Bluetooth® device ... 137	
Connecting a Bluetooth® device	137
Disconnecting the connection with a Bluetooth® device	141
Connecting to Smartphones via Bluetooth®	142
About DVR.Remote	142
Enabling or Disabling Bluetooth®	144
Enabling Bluetooth® and Connecting Automatically to Paired Devices.....	144

6 Use with a computer

Computer connection/disconnection	146
Connecting the voice recorder to a computer.....	146
Disconnecting the voice recorder from a computer.....	147

7 Other information

Alarm message list	148
Troubleshooting	150
Accessories (optional)	154
Recorder care	156
Copyright and trademark information	157
Specifications	159

8 Safety precautions

Indications used in this manual

NOTE

Describes precautions and operations that should be absolutely avoided in using the voice recorder.

TIP

Describes useful information and hints that will help you getting the most out of your voice recorder.



Indicates reference pages describing details or related information.

Names of parts

Recorder

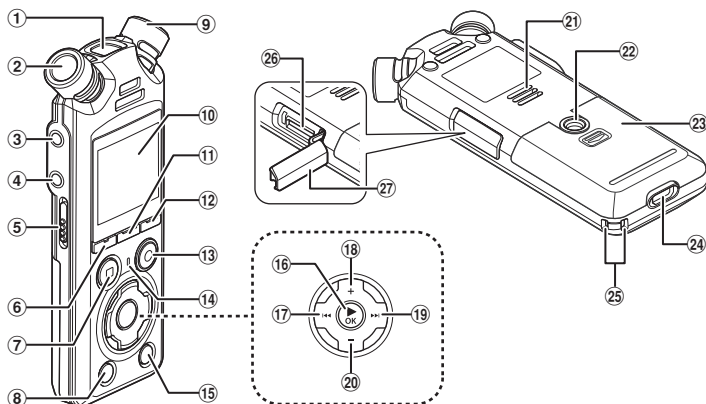

- | | |
|--|---------------------------|
| ① Built-in center microphone | ⑮ LIST button |
| ② Built-in stereo microphone (L) | ⑯ ► OK button |
| ③ Microphone/Line jack (🎧) | ⑰ ◀◀ button |
| ④ Earphone jack (🎧) | ⑱ ▶▶ button |
| ⑤ POWER/HOLD switch | ⑲ ▶▶ button |
| ⑥ F1 button | ⑳ - button |
| ⑦ STOP (■) button | ㉑ Built-in speaker |
| ⑧ ERASE button | ㉒ Tripod socket |
| ⑨ Built-in stereo microphone (R) | ㉓ Battery cover |
| ⑩ Display | ㉔ USB connector |
| ⑪ MENU/SCENE button | ㉕ Strap hole |
| ⑫ F2 button | ㉖ microSD card slot |
| ⑬ REC (record) (●) button/
Recording indicator light | ㉗ microSD card slot cover |
| ⑭ PEAK indicator light/
LED indicator light | |

Display

■ [Home] screen

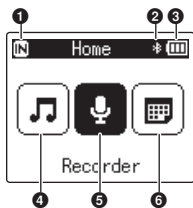

- 1** Recording media indicator
[IN]: Internal memory
[P]: microSD card
- 2** Bluetooth® indicator
- 3** Battery indicator
- 4** [Music] mode (P.9)
- 5** [Recorder] mode (P.8)
- 6** [Calendar Search] mode (P.7)

■ [Calendar Search] mode



- 1** Recording media indicator
[IN]: Internal memory
[P]: microSD card
- 2** Number of files saved (recorded) on selected date
- 3** Bluetooth® indicator
- 4** Battery indicator
- 5** Today's date
- 6** Selected date
- 7** Date file was recorded

■ [Recorder] mode

Folder list display

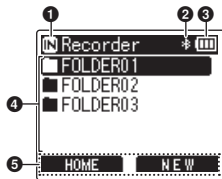

File list display

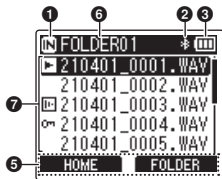

File display

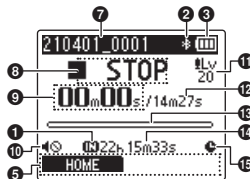

1 Recording media indicator

[IN]: Internal memory

[SD]: microSD card

2 Bluetooth® indicator

3 Battery indicator

4 Folder name

5 Function button guide display

6 Current folder name

7 File name

[▶]: Playback indicator

[□]: Voice Detect indicator

[🔒]: File Lock indicator

8 Voice recorder status indicator

[○]: Recording indicator

[□□]: Recording pause indicator

[■]: Stop indicator

[▶]: Playback indicator

[▶▶]: Fast playback indicator

[▶▶]: Slow playback indicator

[▶▶]: Fast-forward indicator

[◀◀]: Fast-rewind indicator

9 Elapsed recording time (during recording mode), playback time (during playback mode)

10 Speaker muting indicator (🔇)

11 Recording level indicator

12 File length

13 Level meter (during recording mode), playback position indicator (during playback mode)

14 Possible recording time remaining

15 Timer recording indicator

■ [Music] mode

List display ①

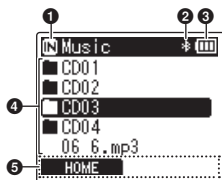

When folder contains files and folders

List display ②

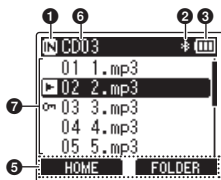

When folder contains only files

File display

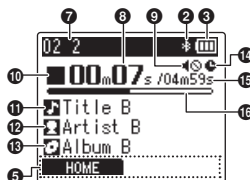

① Recording media indicator

[IN]: Internal memory

[μ]: microSD card

② Bluetooth® indicator

③ Battery indicator

④ Folder name or file name

⑤ Function button guide display

⑥ Current folder name

⑦ File name

[▶]: Playback indicator

[🔒]: File Lock indicator

⑧ Elapsed playback time

⑨ Speaker muting indicator (🔇)

⑩ Voice recorder status indicator

[■]: Stop indicator

[▶]: Playback indicator

[▶]: Fast playback indicator

[▶]: Slow playback indicator

[▶▶]: Fast-forward indicator

[◀◀]: Fast-rewind indicator

⑪ Music title

⑫ Artist name

⑬ Album name

⑭ Timer recording indicator

⑮ File length

⑯ Playback position bar indicator

TIP

- To view [Time & Date] (P.101) and [Remain] (remaining recording time available), press the **STOP** (■) button in the [Home] screen or list display or while recording and playback is paused. Additional information can be viewed by pressing the **+** or **-** button to cycle the display. The information displayed changes each time either button is pressed. To exit, press the **STOP** (■) button a second time.

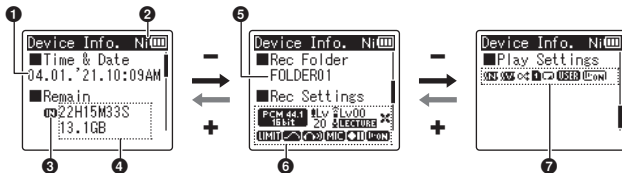

1 Current time & date

2 Battery indicator

[Ni]: Ni-MH
[Al]: Alkaline

3 Recording media indicator

4 Remaining memory available

Remaining recording time available
Remaining memory available on storage device

5 Recording folder

6 Recording menu

[PCM 44.1 16V 20 2]: Recording Mode indicator
[LW]: Recording Level indicator
[MIC]: Zoom Microphone indicator
[LECTURE]: Recording Scene indicator
[X]: Low Cut Filter indicator
[LIMIT]: Limiter indicator
[LW]: Bright Sound indicator
[MON]: Recording Monitor indicator
[MIC]: External Input indicator
[ON]: Recording Standby indicator
[ON]: Voice Detect indicator

7 Play menu

[NC]: Noise Cancel indicator
[VB]: Voice Balancer indicator
[R]: Random indicator
[PR]: Playback Range indicator
[R]: Repeat indicator
[EQ]: Equalizer indicator
[VP]: Voice Playback indicator

Getting started

Setup

After unpacking the voice recorder, follow the steps below to have it ready for use.

Getting started **1**

Inserting batteries



Getting started **2**

Charging batteries



Getting started **3**

Setting the time/date

Set the voice recorder's clock for use with file management.

1

Getting started

Inserting batteries

1

Before using the voice recorder, insert supplied batteries (BR404) in the battery compartment of the voice recorder.

Getting started

1 Slide the battery cover to open.

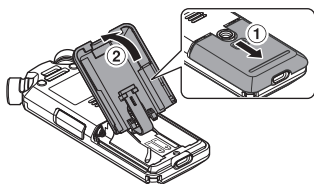

3 Slide the battery cover completely closed.

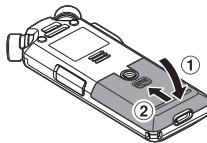

2 Insert the batteries, making sure their positive and negative terminals are placed correctly.

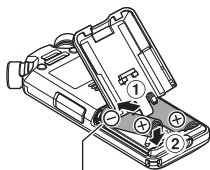

Insert batteries' negative terminals first.

Charging batteries

The supplied batteries can be charged by connecting the recorder to a computer via the supplied USB cable.

The recorder can be used with the supplied Ni-MH (BR404) batteries or with third-party alkaline batteries. When using alkaline batteries, choose **[Alkaline]** for **[Battery]** (P.100).

NOTE

- Never attempt to charge an alkaline battery, lithium battery or other primary cell battery. Fluid leakage or overheating may cause the recorder to malfunction.

- 1 Start the computer.
- 2 Connect the voice recorder to a computer via the supplied USB cable.

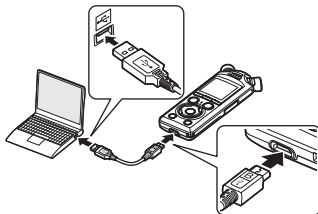

- The recorder will display a **[Battery]** dialog.

- 3 Press the **+** or **-** button to select **[Ni-MH]**.

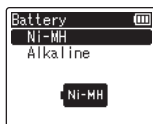

- 4 Press the **▶OK** button.
- 5 Press the **+** or **-** button to select **[OK]**.

6 Press the ►OK button to finalize the setting.

- The recorder will display a [Charging] dialog and start charging the batteries. The LED indicator light will turn on.

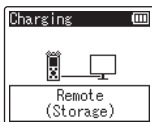

- Charging has finished when the battery indicator changes to .

Battery indicator

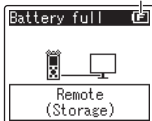

Charging time: About 3 hours*

- * Approximate time needed to fully charge completely flat batteries at room temperature. Battery charging time will depend on the amount of remaining power and the state of the batteries.

7 Disconnect the USB cable from the voice recorder and computer.

- You will be prompted to set the time/ date.

Setting the time/date

- 1** Press the **▶▶** or **◀◀** button to select the item to set.

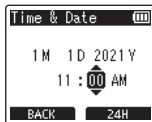
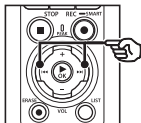

- 2** Press the **+** or **-** button to change the number.

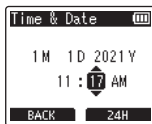
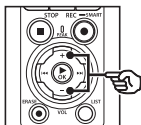

- To change the setting of another item, press the **▶▶** or **◀◀** button to move the blinking cursor, then press the **+** or **-** button to change the number.

- 3** Press the **▶OK** button to finalize the setting.

TIP

- You can press the **▶OK** button during the setting procedure to set the items entered so far and start the clock.
- You can change the clock display format. See “**Setting the time/date [Time & Date]**” (P.101) for the procedure.

Charging the batteries

The supplied rechargeable batteries can be charged either by connecting the recorder to a computer via the supplied USB cable or using an optional AC adapter that connects via USB.

1

Getting started

Charging the Batteries from a Computer via USB

The supplied rechargeable batteries can be charged by connecting the recorder to a computer via USB. Be sure the batteries are correctly inserted in the recorder before proceeding (see P.12).

NOTE

- Before charging the batteries, insert the rechargeable batteries provided and set **[Battery]** to **[Ni-MH]** (see P.12, P.100).
- Never attempt to charge an alkaline battery, lithium battery or other primary cell battery. Fluid leakage or overheating may cause the recorder to malfunction.

- 1 Start the computer.**
- 2 After confirming that the recorder is stopped or off, connect it to the computer using the USB cable.**

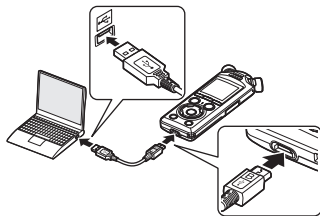

- The recorder will display a **[Charging]** dialog and start charging the batteries. The LED indicator light will turn on.

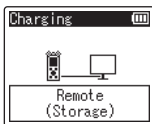

- Charging has finished when the battery indicator changes to **[Full]**.



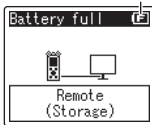

Battery indicator



Charging time: About 3 hours*

- * Approximate time needed to fully charge completely flat batteries at room temperature. Battery charging time will depend on the amount of remaining power and the state of the batteries.

NOTE

- The computer to which the recorder is connected via USB must be on for the batteries to charge. You cannot charge the batteries when the power of the computer is OFF, or the computer is in standby, sleep or auto power OFF mode.
- Do not use a USB hub when charging the batteries by connecting to the computer.
- You cannot charge the batteries if []*1 or []*2 is blinking. Charge the batteries in an ambient temperature of between 5 and 35°C (41 and 95°F).
 - *1 [] Ambient temperature is too low.
 - *2 [] Ambient temperature is too high.
- If battery life has become noticeably short on a full charge, replace the batteries with new ones.
- Insert the USB connector securely all the way. Operation will not be normal if the connection is not made properly.
- Use the supplied USB cable only. Never use a third-party cable, as this could damage the product. The supplied cable should similarly never be used for connections between third-party devices.
- If charging does not start, select **[Storage Class]** for **[USB Settings]** > **[USB Class]** (P.132).
- No audio will be recorded if the batteries run out during recording. Before starting recording, check that the batteries are charged (P.20).

Charging the batteries by connecting to an AC adapter with a USB connection (model F-5AC; optional)

The supplied batteries can be charged by connecting the recorder to an optional F-5AC USB AC adapter using a USB cable. Be sure the batteries are correctly inserted in the recorder before proceeding (P.12).

NOTE

- Before charging the batteries, insert the rechargeable batteries provided and set **[Battery]** to **[Ni-MH]** (P.12, P.100).
- Use only the supplied model of USB-connecting AC adapter (F-5AC).
- Never attempt to charge an alkaline battery, lithium battery or other primary cell battery. Fluid leakage or overheating may cause the recorder to malfunction.

- 1 Select [AC Adapter] for the USB connection setting (P.131).**

- 2 Using the supplied USB cable, connect the recorder to the AC adapter.**

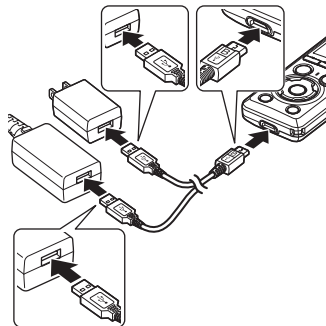

- 3** After confirming that the recorder is stopped or off, plug the AC adapter into an AC power outlet.

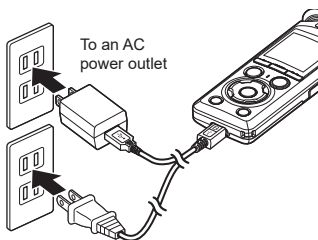

- The recorder will display a **[Charging]** dialog and start charging the batteries. The LED indicator light will turn on.



- Charging is finished when **[Battery full]** appears.

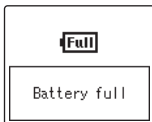

TIP

- Choosing **[Optional]** for **[USB Connection]** when **[Composite]** is selected for **[USB Class]** gives you the option of enabling charging by choosing **[AC Adapter]** when connecting (☞ P.131).

NOTE

- You cannot charge the batteries if **[L]***1 or **[H]***2 is blinking. Charge the batteries in an ambient temperature of between 5 and 35°C (41 and 95°F).

*1 **[L]** Ambient temperature is too low.

*2 **[H]** Ambient temperature is too high.

- If battery life has become noticeably short on a full charge, replace the batteries with new ones.
- Insert the USB connector securely all the way. Operation will not be normal if the connection is not made properly.
- Use the supplied USB cable only. Never use a third-party cable, as this could damage the product. The supplied cable should similarly never be used for connections between third-party devices.
- No audio will be recorded if the batteries run out during recording. Before starting recording, check that the batteries are charged (☞ P.20).

Batteries



1

Getting started

Battery indicator

As the batteries lose their remaining charge, the battery indicator on the display changes as follows:



- [] indicates there is little remaining battery charge. Charge the batteries or replace them with fresh ones. When the batteries have run out, [] and [**Battery low**] appear, and operation stops.

Rechargeable batteries

Read the information below carefully when using nickel-metal hydride rechargeable batteries (model BR404).

■ Discharging

Rechargeable batteries discharge naturally when not in use. Be sure to charge the batteries before use.

■ Operating temperature

Rechargeable batteries are chemical-based products. Their performance can vary even when used within the recommended operating temperature range. This variation is normal.

■ Recommended temperature ranges

When powering voice recorder: 0 to 42°C (32 to 107.6°F)

When being charged: 5 to 35°C (41 to 95°F)

During long-term storage: -20 to 30°C (-4 to 86°F)

Use of rechargeable batteries outside the temperature ranges above may result in drops in battery performance or life. When not using the voice recorder for an extended period, remove the rechargeable batteries before storage to prevent fluid leakage or rust.

■ Disposal

Always dispose rechargeable batteries in the legally prescribed manner. Before disposing rechargeable batteries that are not fully discharged, take steps to prevent shorting such as insulating their terminals with tape.

NOTE

- Due to the nature of nickel-metal hydride rechargeable batteries, new batteries and batteries not used for an extended period (one month or more) may not charge completely. The batteries should become fully charged after charging and discharging the batteries up to three times.
- When buying rechargeable batteries, always select model BR404 nickel-metal hydride rechargeable batteries. Operation is not guaranteed if batteries from another manufacturer are used.
- The continuous battery usage time of a nickel-metal hydride rechargeable battery that has been used repeatedly will be reduced due to battery degradation (see P.161).

Battery precautions

- The voice recorder does not support manganese batteries.
- Always turn power OFF before replacing the batteries. Files may be damaged if the batteries are removed while the voice recorder is recording or performing an operation such as erasing a file.
- Battery type options and the time/date will be reset if the batteries are removed for too long or are quickly removed and reinserted. For information on what to do if you are prompted to choose a battery type or set the time/date, see “**Charging batteries**” (P.13) or “**Setting the time/date [Time & Date]**” (P.101).
- When not using the voice recorder for an extended period, always remove the batteries before storage.
- When replacing the batteries, use AAA alkaline dry-cell batteries or BR404 nickel-metal hydride rechargeable batteries.
- Even if the battery indicator is , playback with the built-in speaker at some volumes may result in a drop in battery output voltage, causing the voice recorder to reset. Lower the volume in this case.
- Some microSD cards may reduce battery endurance (P.161).
- The continuous battery usage time will vary depending on the performance of the batteries in use (P.161).
- The **[Battery]** screen appears automatically after you have replaced the batteries. You can also use a menu operation to display this screen and choose the battery type (P.100).

For users in Germany

Our company has an agreement with the GRS (Joint Battery Disposal Association) in Germany to ensure environmentally-friendly battery disposal.

Inserting/removing a microSD card

The voice recorder has its own internal memory, and also supports standard microSD cards (microSD, microSDHC, microSDXC) sold separately.

1

Getting started

Inserting a microSD card

- 1 While the voice recorder is in stop mode, open the microSD card slot cover.

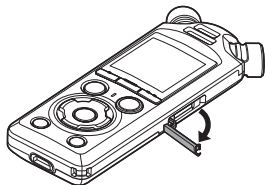

- 2 Insert a microSD card, making sure it is placed correctly as shown.

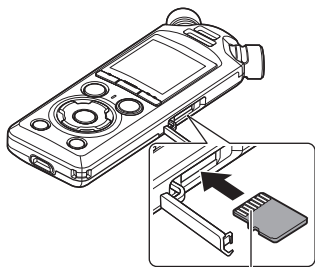

Connectors

- Insert the microSD card straight, avoiding crooked insertion.

- Inserting a microSD card the wrong way or crookedly could damage its contact surface or cause it to jam in the slot.
- A microSD card not inserted fully (until it clicks into place) might not record data.

- 3 Close the microSD card slot cover.

- The recording media selection screen appears after a microSD card has been inserted.

- 4 To record onto the microSD card, press the + or - button and select [Yes].

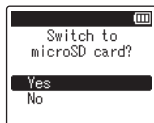
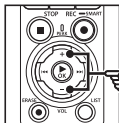

- 5 Press the ►OK button to finalize the setting.

- The [Home] screen (P.7) will be displayed.

TIP

- You can also select the internal memory as the recording media (☞ P.100).

NOTE

- The voice recorder may not be able to recognize a microSD card formatted (initialized) for a computer or other device. Before using a microSD card, always initialize it on the voice recorder (☞ P.133).

Removing a microSD card

1

Getting started

- 1 While the voice recorder is in stop mode, open the microSD card slot cover.

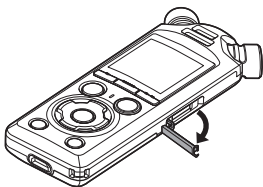

- 2 Release the microSD card by pressing it inward, then letting it slowly return.

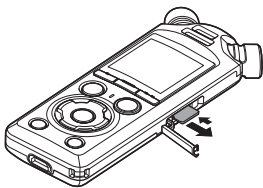

- The microSD card moves outward and stops. Pull the microSD card out with your fingertips.
- **[Internal memory selected]** is displayed after removing a microSD card if **[Memory Select]** was set to **[microSD card]**.

- 3 Close the microSD card slot cover.

NOTE

- microSD cards may pop out forcefully on removal if you flick or release your finger too quickly after pressing the card in.
- Depending on the card's manufacturer and type, some microSD, microSDHC and microSDXC cards may not be fully compatible with the voice recorder and not be recognized properly.
- For microSD card compatibility, please visit our website's customer support page.

Note that our customer support will provide information on microSD card manufacturers and card types for which we have verified operation, but will not guarantee their performance. Also note that some cards may no longer be recognized correctly by the voice recorder in case card manufacturer changes card specifications.

- Read the operating instructions provided with the card when using a microSD card.
- If a microSD card is not recognized by the voice recorder, try removing and reinserting the card to have the voice recorder attempt recognition again.

- Processing speed may be low for some microSD card types. Processing performance may also be reduced by writing or deleting data repeatedly from a microSD card. In this case, reinitialize the card (P.133).

Turning the power ON/OFF

Turning the power ON

To turn the recorder on, slide the **POWER/HOLD** switch in the direction shown.

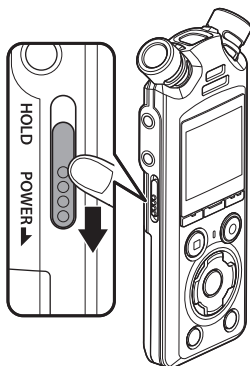

Turning the power OFF

To turn the recorder off, keep the **POWER/HOLD** switch in the position shown for at least 0.5 seconds.

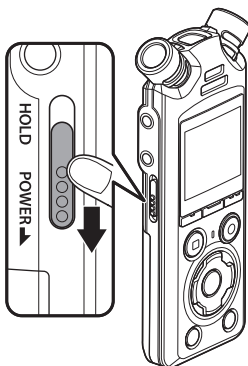

- Turning the recorder off has no effect on the time/date reported by the recorder or on the current playback position, saved audio, recorder settings or the like.

TIP

- Turning the power OFF whenever the voice recorder is not in use minimizes battery consumption.

Power Save mode

When the voice recorder has been stopped for at least 10 minutes (default setting) after power ON, the display disappears and the voice recorder automatically enters power save mode (see P.100).

- Pressing any button releases power save mode.

Preventing accidental operation

Setting the voice recorder to HOLD mode maintains the current operation and disables button operations. HOLD mode is a handy feature for preventing unintentional operation from accidental button presses when the voice recorder is carried in a bag or pocket. It is also useful for preventing the voice recorder being accidentally stopped during recording.

Setting HOLD mode

To select HOLD mode, slide the **POWER/HOLD** switch to **HOLD** and confirm that **[Hold]** appears in the display.

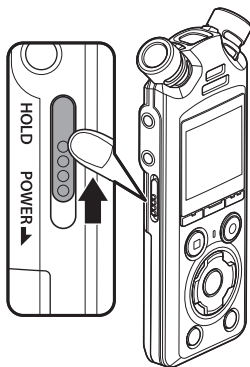

Releasing HOLD mode

To exit HOLD mode, slide the **POWER/HOLD** switch to **(A)**.

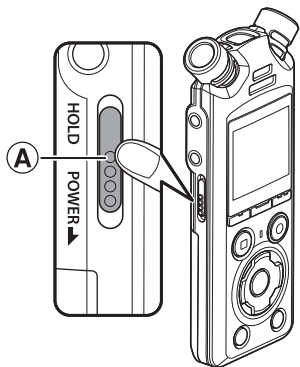

NOTE

- When any button is pressed during HOLD mode, **[Hold]** appears in the display for 2 seconds. No other operation is performed.
- Setting HOLD mode during voice recorder playback (or recording) continues the playback (or recording) operation and prevents any other operation from being performed. (The voice recorder stops when playback ends or when recording ends because, for example, there is no remaining memory space.)

[Home] screen operations

Selecting the mode

1

Getting started

In addition to its recording function, the voice recorder also provides music player functions. Choose the application you want by selecting one of the voice recorder's modes.

- 1 While the voice recorder is in stop mode, press the **F1 (HOME)** button to display the **[Home]** screen.

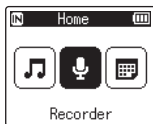
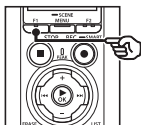

- 2 Press the **▶▶** or **◀◀** button to select the desired mode.

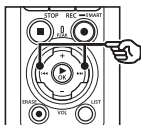

- 3 Press the **▶ OK** button.

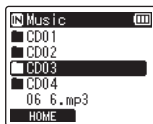
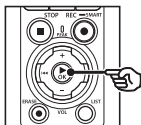

When **[Recorder]** is selected:



The voice recorder enters **[Recorder]** mode. Audio can be recorded with the built-in microphone. Files recorded with the built-in microphone can also be played back (☞ P.35, P.58).

When **[Music]** is selected:

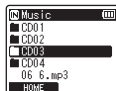

The voice recorder enters **[Music]** mode. In this mode you can play music files transferred to the voice recorder (☞ P.58).

When **[Calendar Search]** is selected:



The voice recorder enters **[Calendar Search]** mode. In this mode you can search for files by specifying the recording date (☞ P.73).

Folders

The recorder creates **[Recorder]** and **[Music]** folders both in internal memory and on microSD cards, the former for audio recordings and the latter as a handy location to store music files downloaded from computers.

Folders for Audio Recordings

Audio recordings are stored in sub-folders directly under the **[Recorder]** folder. Up to 99 such folders can be created (see P.30). Choose a folder before recording.

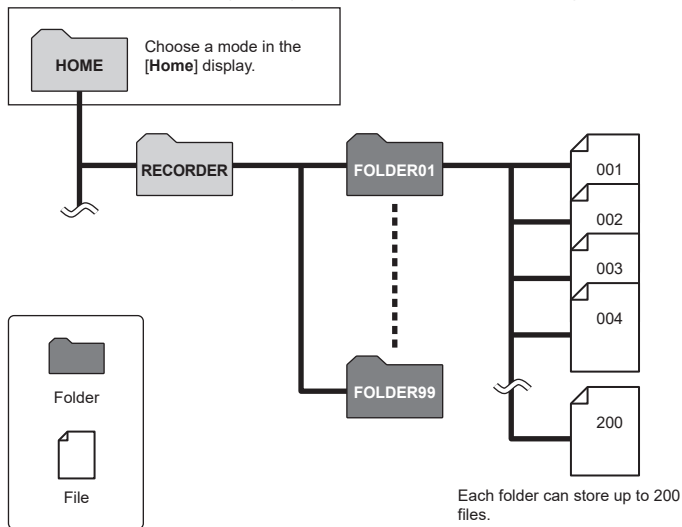

Creating Folders

Create folders directly under the [Recorder] folder. Folders can be named according to the type of audio recorded.

- 1 Press the ►►► or ◀◀◀ button in the [Home] screen and select [Recorder] (P.28).

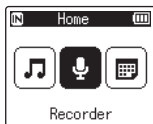
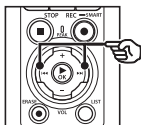

- 2 Press the ►OK button.

- 3 Press the F2 (NEW) button.

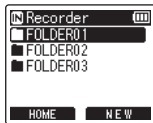
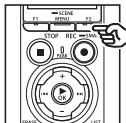

- 4 Press the + or - button to select the desired folder prefix.

Folder prefixes

Conference	Podcast
Meeting	Recital
Interview	Concert
Dictation	Outdoors
Lecture	Schedule
Class	To Do
Language Study	Notes
Music	FOLDER
Video	

- 5 Press the ►OK button.

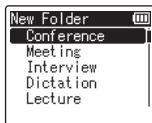
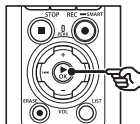

- [Please wait] will flash in the display. [Folder created] will be displayed when the operation is complete.
- Folders are named using the chosen prefix followed by a two-digit folder number.



NOTE

- The message **[Recorder Folder Full]** indicates that no additional folders can be created. Delete unwanted folders (☞ P.75).
- Each of the folders directly under the **[Recorder]** folder can store up to 200 files. If you make additional recordings or divide files (☞ P.111) after reaching this limit, a new folder will be created to hold the additional files.

Music Folders

1

Getting started

Music files downloaded from computers are stored in the **[Music]** folder. The **[Music]** folder can have up to two levels of sub-folders.

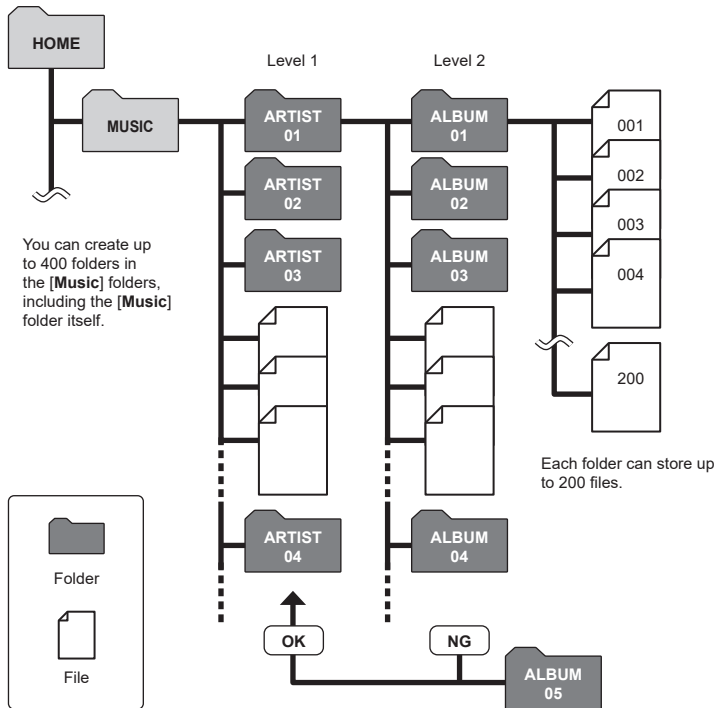

The recorder will not detect files in folders copied from a computer to the second level of folders.

Selecting folders and files

You can select a different folder while the voice recorder is in stopped or playing a file. See “**Folders**” (P.29) for a description of the voice recorder’s hierarchical folder structure.

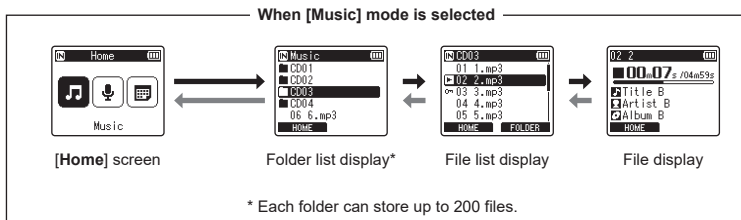
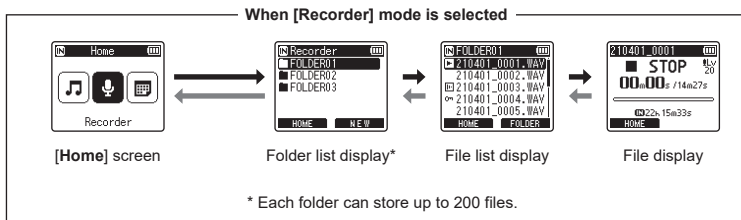

→ Forward: ►OK button

Each press on the ►OK button opens the currently selected folder or file in the list, moving forward to the next (lower) level in the folder hierarchy. When a list is displayed, you can perform the same function by pressing the ►► button.

← Back: LIST button

Each press on the LIST button moves back to the previous (higher) level in the folder hierarchy. When a list is displayed, you can perform the same function by pressing the ◀◀ button.

TIP

- When navigating through a folder hierarchy, you can press and hold the LIST button to return to the file display.

+ or – button

Used to select a folder or file.

[Home] screen

Used to select the voice recorder mode (see P.28).

List display

Displays the folders and files recorded in the voice recorder. Pressing the **F2** (**FOLDER**) button changes the display to the list display of the next folder.

File display

Displays the information of the selected file.

Recording

Recording

Audio recordings are stored in sub-folders directly under the [Recorder] folder (P.29). Up to 99 such folders can be created (P.30).

Basic recording procedure

To begin recording, simply select the destination folder and press the **REC** (●) button.

NOTE

- If [On] is selected for [Rec standby], choose [Off] instead (P.89).

- 1 Press the ►► or ◀◀ button in the [Home] screen and select [Recorder] (P.28).

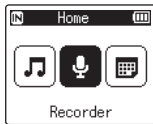
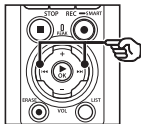

- 2 Press the ► OK button.

- 3 Press the + or - button to select the folder to save the recording in.

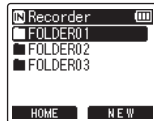
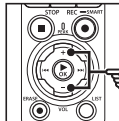

- Each new voice recording file is saved in the selected folder.

- 4 Point the built-in microphone in the direction of the sound to record.

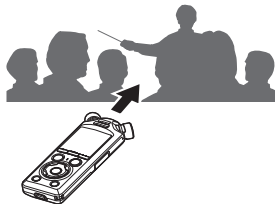

- 5 Press the **REC** (●) button to start recording.

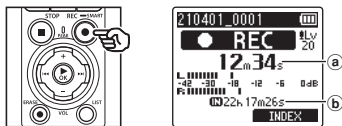

- a Elapsed recording time
b Remaining possible recording time

- The recording indicator light lights.
- If you record simple recording content at the beginning, it will be convenient for searching later using the **[Intro Play]** function (☞ P.99).
- To adjust the recording level, press the ►► or ◀◀ button.

NOTE

- Adjust the recording level so that it does not exceed the peak of the level meter while checking the meter. If the peak of the level meter is exceeded, the **PEAK** indicator light will light and the recorded audio may be distorted.
- If you wish to adjust the recording level, you must first select **[Manual]** for **[Rec Level]** (☞ P.84).

- 6 Press the **STOP** (■) button when you want to stop recording.

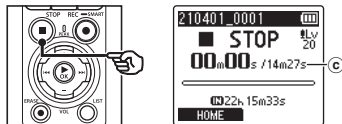

- c File length

TIP

- **[Rec Mode]** can be used to adjust recording quality or choose the file type while the recorder is stopped (☞ P.85).
- Pressing the **REC** (●) button starts recording even when **[Recorder]** mode is not selected, letting you record audio at a moment's notice. The resulting recordings are stored in the first sub-folder (the top sub-folder in the folder list) under the **[Recorder]** folder.

NOTE

- To prevent the beginning of the recording being cut off, start recording after the recording indicator light has lit or mode indicator has appeared in the display.
- When the remaining possible recording time is 60 seconds, the LED indicator light starts flashing. It flashes more rapidly as the remaining time decreases (at the 30- and 10-second points).
- When **[Folder full]** appears, no more recording can be done. To record more, you will need to select a different folder or delete unneeded files (☞ P.74).
- If **[Memory full]** appears, the voice recorder has no more available memory space. You will need to delete unneeded files to record more (☞ P.74).
- When using a microSD card in the voice recorder, be sure the desired recording media setting (**[Internal memory]** or **[microSD card]**) has been selected (☞ P.100).
- Processing performance may be reduced when data has been repeatedly written to or deleted from the recording media. Please initialize the recording media in this case (☞ P.133).

Sound files recorded with the voice recorder are automatically given a file name in the format below. You can add a prefix to the file name using **[File Menu] > [Rename File]** (☞ P.82).

210101_0001.MP3

①

②

③

① **Date recorded**

Indicates the year, month and day the recording was made.

② **File number**

Appended file numbers are consecutive regardless of whether the recording media has been switched.

③ **Extension**

A file extension indicating the recording format the file was recorded in by the voice recorder.

- Linear PCM format: “.WAV”
- FLAC format: “.FLAC”
- MP3 format: “.MP3”

Adjusting Recording Levels Automatically Before Recording ([SMART] Mode)

Start recording after automatically adjusting the recording level to suit the input volume.

2

Recording

- 1 Press the **▶▶** or **◀◀** button in the [Home] screen and select [Recorder] (P.28).

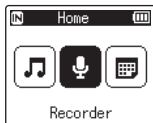
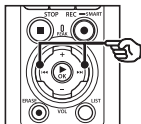

- 2 Press the **▶** OK button.

- 3 Press the **+** or **-** button to select the folder to save the recording in.

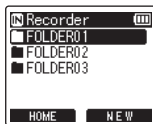
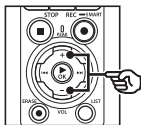

- Each new voice recording file is saved in the selected folder.

TIP

- To start automatic recording level adjustment even when [Recorder] mode is not selected, press and hold the **REC (●)** button. The recordings are stored in the first sub-folder (the top sub-folder in the folder list) under the [Recorder] folder.

- 4 Press and hold the **REC (●)** button.

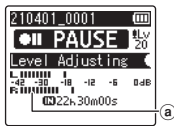
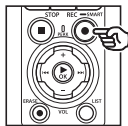

- a Level meter (changes in response to recording level and mode)

NOTE

- [Manual] is selected for [Rec Level] > [Internal Mic] or [External Mic] (P.84).
- [Rec Scene] cannot be used (P.47).
- If the recording level meter goes off the scale during recording, the **PEAK** indicator light will turn on and distortion may be audible in the sound recorded. Enabling [Limiter] can prevent sound distortion from input in excess of peak levels (P.85).

- 5** Point the built-in microphone in the direction of the sound to record.

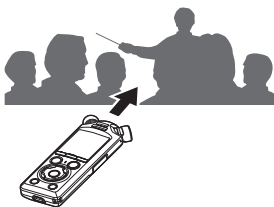

- The recording level will be adjusted according to the maximum volume detected.

- 6** Press the **STOP** (■) button to end automatic recording level adjustment.

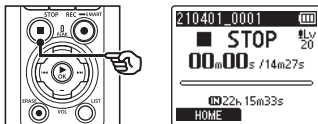

- Automatic recording level adjustment will end and the recorder exit to file view.

TIP

- If you press **REC** (●) without first pressing the **STOP** (■) button, automatic recording level adjustment will end and recording will begin at the selected level.
- To prevent sounds produced by operating recorder controls influencing the recording level, the recorder will ignore any changes to input volume immediately after automatic recording adjustment begins and before it ends.

- 7** Press the **REC** (●) button to start recording.

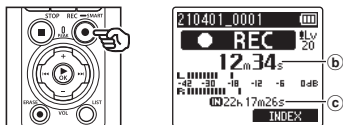

- b Elapsed recording time
c Remaining possible recording time

- The recording indicator light will turn on.
- If you record simple recording content at the beginning, it will be convenient for searching later using the [Intro Play] function (see P.99).

- 8** Press the **STOP** (■) button when you want to stop recording.

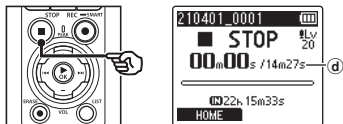

- d File length

- Unless recording levels are re-adjusted in the interim, the adjusted level will also be used for subsequent recordings.

Adjusting Recording Levels Manually Before Recording

Start recording after manually adjusting the recording level to suit the input volume.

1 Select **[On]** for **[Rec Standby]** (P.89).

2 Press the **▶▶** or **◀◀** button in the **[Home]** screen and select **[Recorder]** (P.28).

3 Press the **▶OK** button.

4 Press the **+** or **-** button to select the folder to save the recording in.

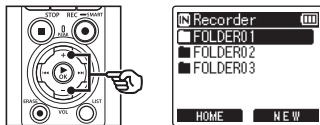

- Each new voice recording file is saved in the selected folder.

5 Press the **REC (●)** button to enable recording standby mode.

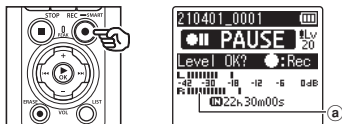

a Level meter (changes in response to recording level and mode)

- The recording indicator light will turn on.

6 Point the built-in microphone in the direction of the sound to record.

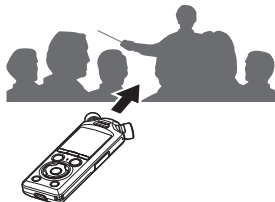

7 Press the **▶▶** or **◀◀** button to adjust the recording level.

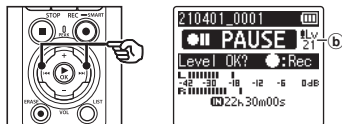

b Recording level

NOTE

- If the recording level meter goes off the scale, the **PEAK** indicator light will turn on and distortion may be audible in the sound recorded. Adjust the recording level so that the meter does not go off the scale.
- If you wish to adjust the recording level, you must first select **[Manual]** for **[Rec Level]** (P.84).

- 8 Press the **REC** (●) button to start recording.

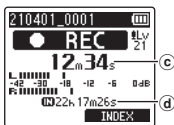
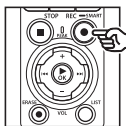

- c Elapsed recording time
- d Remaining possible recording time

- The recording indicator light will turn on.
- If you record simple recording content at the beginning, it will be convenient for searching later using the [Intro Play] function (see P.99).

- 9 Press the **STOP** (■) button when you want to stop recording.

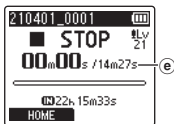
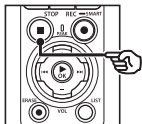

- e File length

Recording linear PCM format files of over 2 GB

When recording a linear PCM format file, recording will continue even after the file size exceeds 2 GB.

- The data is divided and saved in separate files of up to 2 GB. The files are processed as multiple files during playback.
- If the 200th file exceeds 2 GB, a new folder will be created to store the files containing the remainder of the recording. If the limit of 99 folders has already been reached, recording will end without a new folder being created.

Recording FLAC or MP3 Files with Sizes over 4 GB

Recording in FLAC and MP3 formats will end automatically once the file reaches the maximum size (roughly 4 GB).

Recording FLAC format files

FLAC format adopts "variable bit rate" that changes the bitrate of a file, so the remaining recordable time indication may differ from the actual recordable time. Confirm that the remaining memory capacity is sufficient before recording.

Pausing/resuming recording

- 1 Press the **REC (●)** button during recording.

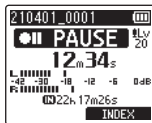
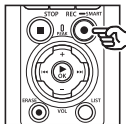

- Recording pauses, and the blinking message [● PAUSE] appears in the display.
- Recording is stopped automatically after being paused for at least 60 minutes.

- 2 Press the **REC (●)** button again while recording is paused.

- Recording resumes from the position it was paused at.

Quickly checking a recording

Pressing the **▶OK** button during recording ends recording and starts playback.

Recording menu

Various recording settings are available, letting you tailor recording to different recording conditions.

[Rec Level] (P.84)	Sets the recording level.
[Limiter] (P.85)	Choose whether the recorder automatically limits distortion if the maximum input level is exceeded during recording.
[Rec Mode] (P.85)	Sets the recording sound quality.
[Zoom Mic] (P.86)	Sets the built-in stereo microphone's directivity.
[Low Cut Filter] (P.87)	Reduces humming sounds from equipment such as air-conditioners or projectors.
[Bright Sound] (P.87)	Create recordings with bright, clear sound.
[Rec Scene] (P.47)	Choose from several combinations of settings suited to particular surroundings or conditions.
[Rec Monitor] (P.88)	Disable output of the recording monitor sound.
[External Input] (P.53)	Choose the type of connector connected to the microphone/line jack.
[Timer Rec] (P.118)	Adjust timed recording settings.
[Rec Standby] (P.89)	Choose whether pressing the REC (●) button switches the recorder to standby mode so that the recording level can be adjusted.
[Fn Rec] (P.121)	Choose the recording option assigned to the F2 button.
[V-Sync. Time] (P.93)	Choose how long recording continues after the input volume falls below the level selected for [V-Sync. Rec] (P.89).
[Slate Tone] (P.126)	Emit and record a slate tone for use as a reference during movie recording.
[Test Tone] (P.129)	Preview volume settings by emitting a test tone at a selected volume.

Monitoring while recording

Sound can be monitored during recording using either earphones or other audio equipment connected via the earphone jack (🔌) or **Bluetooth®** devices connected via **Bluetooth®**.

Using Earphones Connected to the Earphone Jack to Monitor Sound During Recording

You can monitor the recording as you are making it by listening on the earphones plugged into the voice recorder's earphone jack (🔌). Use the **+** or **-** button to adjust the recording monitor volume.

- The earphones are optional.
- Speakers and other devices that can be connected via the earphone jack can be used instead of earphones.

NOTE

- Confirm that **[On]** is selected for **[Rec Monitor]** (☞ P.88). Sound will not be output to earphones when **[Off]** is selected.

1 Connect the earphones to the voice recorder's earphone jack (🔌).

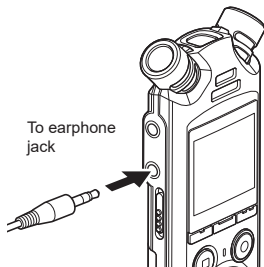

2 Adjust the volume using the **+** or **-** button.

- Adjust volume while listening to the sound currently being recorded.
- Changing the volume will not affect the recording level.

NOTE

- To avoid unpleasantly loud sound, set the volume to **[00]** before plugging in the earphone.
- To prevent feedback, do not place the earphone near the microphone while recording.

Monitoring Recording Using Earphones Connected via Bluetooth®

Recording can be monitored using earphones connected to the recorder via **Bluetooth®**.

- The earphones are optional.
- Other devices can also be connected via **Bluetooth®**. For information on supported profiles, see “**Bluetooth® Specification**” (☞ P.159).

1 Connect the recorder and earphones via Bluetooth®.



Recorder

Earphones

- For information on **Bluetooth®** connections, see “**Connecting a Bluetooth® device**” (☞ P.137).
- Adjustments to volume have no effect on recording level.

2 Adjust the volume using the + or – button.

- Adjust volume while monitoring the sound currently being recorded.

NOTE

- Sound will not be output to **Bluetooth®** earphones if a 24-bit [PCM] or [FLAC] option is selected for [Rec Menu] > [Rec Mode]. Choose a non-24-bit option (☞ P.85).
- To avoid aural over-stimulation, set volume to [00] before putting the earphones on.
- To prevent feedback, keep the earphones away from the microphone during recording.









TIP

- If during recording sound is not output to speakers or other devices connected to the recorder via **Bluetooth®**, select [Off] for [Rec Monitor] (☞ P.88).

Selecting the automatic recording setting [Rec Scene]

Changing the recording scene

The voice recorder has preregistered templates of optimum settings tailored to various recording applications such as lectures and dictation. When selecting one of these templates you can enter several settings recommended for your recording application all in a single operation.

[Lecture]	 LECTURE	Suitable for recording with the microphone pointed in a specific direction such as at a large venue where the speaker is far away.
[Conference]	 CONF	Suitable for recording conferences in a large space and other sounds over a wide area.
[Meeting]	 MEETING	Suitable for recording meetings held in a small space and other sounds that are fairly close.
[Dictation]	 DICT	Suitable for recording your own voice and other sounds that are extremely close.
[Noisy Situation]	 NOISY	Suitable for recording your own voice and other sounds that are extremely close while reducing surrounding noise.
[Music]	 MUSIC	Suitable for recording realistic audio with exceptional clarity such as live recording of a musical instrument performance or out in the open air.
[DNS]	 DNS	Suitable for Speech Recognition Software.
[User 1]	 USER1	Save custom [Rec Level], [Rec Mode], [Zoom Mic], [Low Cut Filter], and [External Input] settings in either of the [User 1] and [User 2] custom recording-scene banks. For information on creating custom recording scenes, see "Creating Custom Recording Scenes" (see P.51).
[User 2]	 USER2	

- 1 While the voice recorder is in stop mode, press and hold the **MENU/SCENE** button.

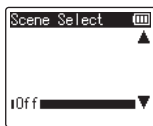
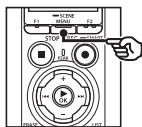

- 2 Press the **+** or **-** button to select the desired recording application.

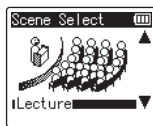
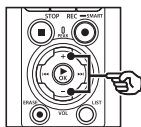

TIP

- Press the ►► button to display the settings of the selected template. Press the ◀◀ button to return to the [Scene Select] screen.

3 Press the ►OK button to finalize the setting.

- To view an icon indicating the selected recording scene while the recorder is stopped, press the **STOP** (■) button and then cycle the display by pressing the + or - button.



NOTE

- The following features cannot be used while [Rec Scene] is in effect:
 - [Voice Detect] > [While recording] (P.105)
 - [Fn Rec] > [Pre-Recording] (P.123)
 - [Fn Rec] > [Over Dubbing] (P.125)

Preregistered [Rec Scene] settings

[Lecture]

[Rec Level]	[Auto]
[Rec Mode]	[MP3 128 kbps]
[Zoom Mic]	[20]
[Low Cut Filter]	[On]
[External Input]	[Microphone]

[Conference]

[Rec Level]	[Auto]
[Rec Mode]	[MP3 128 kbps]
[Zoom Mic]	[0]
[Low Cut Filter]	[On]
[External Input]	[Microphone]

[Meeting]

[Rec Level]	[High]
[Rec Mode]	[MP3 128 kbps]
[Zoom Mic]	[0]
[Low Cut Filter]	[Off]
[External Input]	[Microphone]

Selecting the automatic recording setting [Rec Scene]

[Dictation]

[Rec Level]	[Middle]
[Rec Mode]	[MP3 128 kbps]
[Zoom Mic]	[0]
[Low Cut Filter]	[On]
[External Input]	[Microphone]

[DNS]

[Rec Level]	[Middle]
[Rec Mode]	[MP3 128 kbps]
[Zoom Mic]	[0]
[Low Cut Filter]	[Off]
[External Input]	[Microphone]

[NoisySituation]

[Rec Level]	[Middle]
[Rec Mode]	[MP3 64 kbps mono] (sampling frequency 16 kHz)
[Zoom Mic]	[0]
[Low Cut Filter]	[On]
[External Input]	[Microphone]

[Music]

[Rec Level]	[Middle]
[Rec Mode]	[PCM 44.1 kHz/16 bit]
[Zoom Mic]	[0]
[Low Cut Filter]	[Off]
[External Input]	[Microphone]

NOTE

- For recording when **[NoisySituation]** is set, point the built-in microphone on the top left or top right of the voice recorder toward the speaker and place it in an upright position as close as approximately 3 cm from the speaker's mouth.

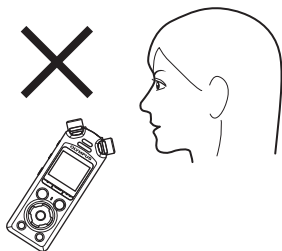
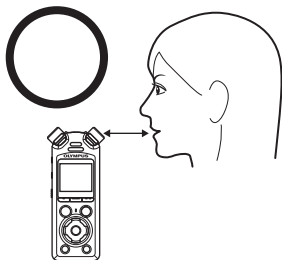

Creating Custom Recording Scenes

Save [Rec Level] (P.84), [Rec Mode] (P.85), [Zoom Mic] (P.86), [Low Cut Filter] (P.87), and [External Input] (P.53) settings to custom recording-scene banks.

NOTE

- Custom recording-scene banks cannot be created when an option other than [Off] is selected for [Rec Scene]. Select [Off] for [Rec Scene].

- 1 During recording or while the voice recorder is in stop mode, press the **MENU/SCENE** button.

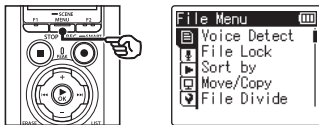

- 2 Press the **+ or -** button to select the [Rec Menu] tab.

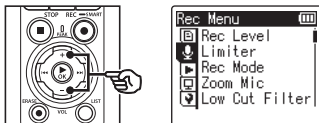

- 3 Press the **▶OK** button to move the cursor into the list of setting items.

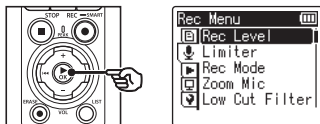

- 4 Press the **+ or -** button to select [Rec Scene].

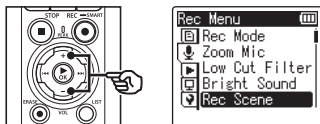

- 5 Press the **▶OK** button.

- 6 Press the **+ or -** button to select [Scene Save].

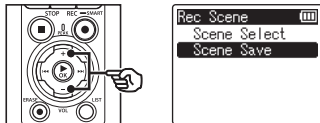

- 7 Press the **▶OK** button.

- 8** Press the **+** or **-** button to select [User 1] or [User 2].

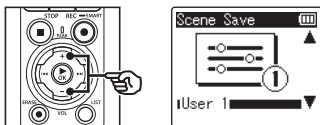

- 9** Press the **▶OK** button to finalize the setting.

- Current settings are saved to [User 1] or [User 2].

- 10** Press the **STOP (■)** button to exit the menu screen.

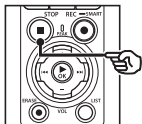

Recording Using External Mics or Other Input Devices Connected to the Recorder [External Input]

Record sound from an external microphone or audio device connected via the voice recorder's microphone/line jack (🎤).

Choosing an Input Device

Select **[Microphone]** for input devices with microphone connectors, **[Line In]** for audio devices or other equipment with line-in connectors.

NOTE

- If the microphone/line-in setting does not match the type of plug used to connect the device, sound may be recorded at a volume that is too high or too low.

- 1** During recording or while the voice recorder is in stop mode, press the **MENU/SCENE** button.

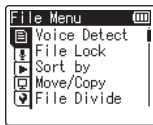
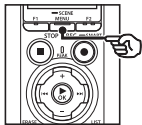

- 2** Press the **+ or -** button to select the **[Rec Menu]** tab.

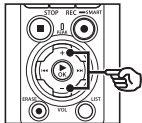

- 3** Press the **▶OK** button to move the cursor into the list of setting items.

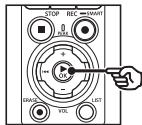

- 4** Press the **+ or -** button to select **[External Input]**.

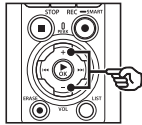

- 5** Press the **▶OK** button.

- 6** Press the **+ or -** button to select **[Microphone]** or **[Line In]**.

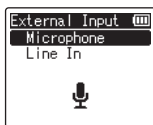
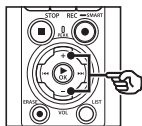

- 7 Press the ► **OK** button to finalize the setting.
- 8 Press the **STOP** (■) button to exit the menu screen.

- To view an icon showing the option selected for external input, press the **STOP** (■) button while the recorder is stopped and then cycle the display by pressing the + or - button.



External Input

NOTE

- Enabling [External Input] selects [Off] for [Rec Scene]. [External Input] settings cannot be adjusted when an option other than [Off] is selected for [Rec Scene].

Recording Using External Mics and Other Input Devices

The recorder can record audio input from external microphones and the like.
See “**Accessories (optional)**” (P.154) for the compatible external microphones.

NOTE

- Confirm that the device is equipped with a microphone connector and select [**Microphone**] for [**External Input**]. For information on choosing an input device, see “**Choosing an Input Device**” (P.53).

- 1 **Connect an external microphone to the voice recorder’s microphone/line jack (🔊).**

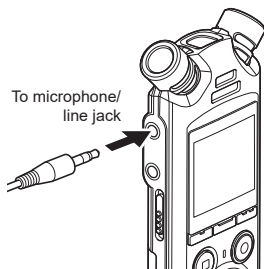

- 2 **Start recording.**

- See “**Recording**” (P.35) for descriptions of recording operations.

NOTE

- Do not plug devices into or disconnect devices from the jack during recording.
- Microphones with plug-in power supplies can be used.
- When [**Rec Mode**] is set to stereo, recording with an external mono microphone records on the left channel only (P.85).
- When [**Rec Mode**] is set to mono, only the input from the left channel microphone is recorded when using an external stereo microphone (P.85).

Recording audio from another device with this recorder

The recorder can record audio playback from music players and other audio devices via line-in input.

2

Recording

NOTE

- Confirm that the device and connecting cable are equipped with line-in connectors and select **[Line In]** for **[External Input]**. For information on choosing an input device, see “**Choosing an Input Device**” (P.53).

NOTE

- Do not connect cables to or disconnect cables from the jack during recording.
- When recording from a connected external device, perform a test recording and adjust the output level of the connected device as needed.

1 Connect the music player to the recorder's microphone/line jack (🎧).

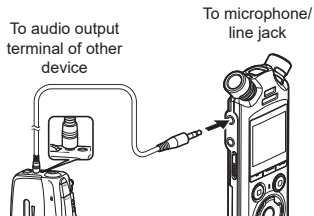

TIP

- Audio can be recorded when you have connected the audio output terminal (earphone jack) of another device and the microphone/line jack (🎧) of the recorder by using the connecting cord KA333 (optional) for duplication.

2 Start recording.

- See “**Recording**” (P.35) for descriptions of recording operations.

Recording audio from this recorder with another device

Record audio from music players or other audio devices connected via the recorder's earphone jack (🎧).

- 1 Connect an other device to the voice recorder's earphone jack (🎧).**

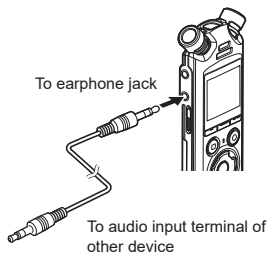

- 2 Start recording.**

- See **“Recording”** (📖 P.35) for descriptions of recording operations.

NOTE

- Do not connect cables to or disconnect cables from the jack during recording.
- Adjusting playback sound quality settings on the voice recorder affects the audio output signals output from the earphones jack (📖 P.94 to P.96).

TIP

- Audio from this recorder can be recorded to another device by connecting the audio input terminal (microphone/line jack) of the other device and the earphones jack of this recorder using the connecting cord KA333 (optional).

Playback

Playback

In addition to files recorded by the voice recorder, you can also play WAV, FLAC or MP3 format files transferred from a computer.

Basic playback procedure

3

Playback

- 1 Select the file to play from the folder containing it (☞ P.33).

TIP

- Files are saved in the locations below.

Files recorded with the built-in microphone:

Stored in folders directly under the **[Recorder]** folder (☞ P.29)

Music files transferred from a computer:

Stored in folders directly under the **[Music]** folder (☞ P.32)

- 2 Press the **▶OK** button to start playback.

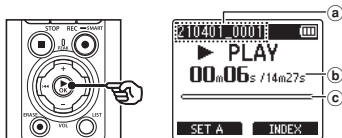

- File name
- Elapsed playback time / File length
- Playback position bar indicator

- Audio plays back over the recorder's built-in speaker (☞ P.32).

- 3 Press the **+** or **-** button to adjust the volume to the desired level.

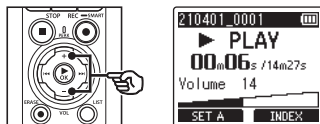

- The volume can be adjusted to a setting between **[00]** to **[30]**. The higher the number, the louder the volume.
- If the volume is set too loud, a warning screen may appear.



4 Press the **STOP** (■) button to stop playback.

- Playback ends automatically when the end of the file is reached.
- The resume feature saves the current playback position when the recorder is turned off. The next time the power is turned on, playback can be resumed from the stop position stored in the memory.

Fast-forwarding

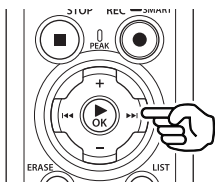

Fast-forwarding while the voice recorder is in stop mode

With the voice recorder stopped, press and hold the ►► button.

- Fast-forwarding stops when you release the ►► button. Press the ►OK button to start playback from the current position.

Fast-forwarding during playback

Press and hold the ►► button during playback.

- Playback starts from the current position when you release the ►► button.
- If an index mark or temp mark in the file is reached, fast-forwarding stops at the mark (P.70).
- Fast-forwarding stops when the end of the file is reached. Press and hold the ►► button again to fast-forward from the beginning of the next file.

Rewinding

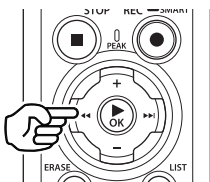

Rewinding while the voice recorder is in stop mode

With the voice recorder stopped, press and hold the ◀◀ button.

- Rewinding stops when you release the ◀◀ button. Press the ►OK button to start playback from the current position.

Rewinding during playback

Press and hold the ◀◀ button during playback.

- Playback starts from the current position when you release the ◀◀ button.
- If an index mark or temp mark in the file is reached, rewinding stops at the mark (P.70).
- Rewinding stops when the beginning of the file is reached. Press and hold the ◀◀ button again to rewind from the end of the previous file.

Skipping to the beginning of a file

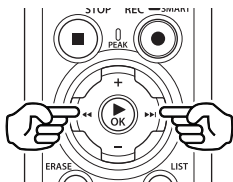

Skipping to the beginning of the next file

Press the ►► button while the voice recorder is in stop mode, or during playback.

Skipping to the beginning of the current file

Press the ◀◀ button while the voice recorder is in stop mode, or during playback.

Skipping to the beginning of the previous file

Press the ◀◀ button when the playback position is the beginning of the file.

- To skip to the beginning of the previous file during playback, press the ◀◀ button twice consecutively.

NOTE

- If an index mark or temp mark is reached when skipping to the beginning of a file during playback, playback starts from the position of the mark. When skipping to the beginning of a file while the voice recorder is in stop mode, the mark is ignored (P.70).
- If a setting other than [File Skip] is set for [Skip Space], playback starts after the set amount of time has been skipped backwards or forwards. Playback does not skip to the beginning of the file.

Playback menu

You can select various file playback methods tailored to different applications and tastes.

[Voice Playback]*1 (F3 P.94)	Only plays voice portions of a recorded audio file.
[Noise Cancel]*1 (F3 P.94)	A setting that makes recorded voices more discernable when muffled by projector noise or similar sounds.
[Voice Balancer]*1 (F3 P.95)	Compensates low-volume portions of recorded audio files during playback.
[Play Mode] (F3 P.95)	Choose the playback range. Loop and random playback are available in music mode.
[Equalizer]*2 (F3 P.96)	Adjusts the quality of sound as desired.
[Skip Space] (F3 P.97)	A handy function for quickly moving the playback position, and playing short segments repeatedly.

*1 Function active only in **[Recorder]** mode.

*2 Function active only in **[Music]** mode.

Playback Using the Earphones Connected to the Earphone Jack

You can connect the earphones to the voice recorder's earphone jack (🎧) and listen to playback through them.

- The earphones are optional.
- Speakers and other devices that can be connected via the earphone jack can be used instead of earphones.

NOTE

- There will be no sound from the speaker when the earphones are connected.

1 Connect the earphones to the voice recorder's earphone jack (🎧).

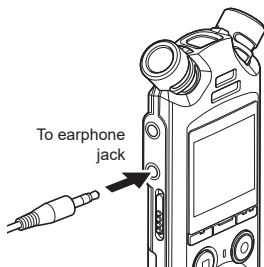

NOTE

- To avoid aural over-stimulation, set volume to [00] before putting the earphones on.
- Avoid excessive volume when listening to playback through the earphones. It may cause hearing damage or loss.
- If the volume is set too loud, a warning screen may appear.



2 Press the ►OK button to start playback.

3 Adjust the volume using the + or - button.

- Adjust volume while listening to the sound being played back.

Playback Using Earphones Connected via Bluetooth®

Audio can be played back over earphones connected via **Bluetooth®**.

- The earphones are optional.
- Other devices can also be connected via **Bluetooth®**.

1 Connect the recorder and earphones via Bluetooth®.



- For information on **Bluetooth®** connections, see "**Connecting a Bluetooth® device**" (P.137).

2 Adjust the volume using the + or - button.

NOTE

- To avoid aural over-stimulation, set volume to [00] before putting the earphones on.
- To prevent feedback, keep the earphones away from the microphone during recording.

Music files

Use the **[Music]** folder to store music files downloaded from computers (see P.32). If a music file transferred to the voice recorder is unplayable, check that its sampling rate, bit count and bit rate values are within the supported ranges. The sampling rate, bit count and bit rate combinations supported for music file playback by the voice recorder are shown below.

File format	Sampling rate	Bit count/bit rate
WAV format, FLAC format	44.1 kHz, 48.0 kHz, 88.2 kHz, 96.0 kHz	16 bits, 24 bits
MP3 format	MPEG 1 Layer 3: 32 kHz, 44.1 kHz, 48 kHz MPEG 2 Layer 3: 16 kHz, 22.05 kHz, 24 kHz	8 to 320 kbps

- MP3 files with variable bit rates (bit rates converted variably in a single file) may not play normally.
- Linear PCM-format WAV files are the only WAV files the voice recorder can play. Playback of other WAV files is not supported.
- Even if the file formats is compatible for playback on this recorder, the recorder does not support every encoder.

Changing the playback speed

Changing the playback speed is handy for speeding up conference presentations, or for slowing down parts difficult to discern when learning a language.

- 1 Press the ►OK button during playback.

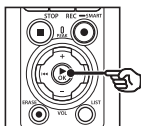

- 2 Press the + or - button.

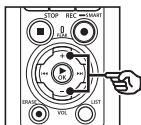

- The playback speed can be adjusted between [x0.5 Play] and [x3.5 Play] in 0.1 increments.
- The playback speed increases when the + button is pressed, and decreases when the - button is pressed.
- To return to the normal playback speed, set the setting to [x1.0 Play].

- 3 Press the ►OK button to finalize the setting.

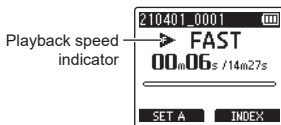

TIP

- When changing the playback speed, playback operations such as stopping playback, skipping to the beginning of a file, and writing index marks/temp marks are the same as during standard playback.

NOTE

- Altered playback speed settings are retained even after power OFF.
- Changing the playback speed will make the batteries deplete more quickly.

Fast playback restrictions

Depending on their sampling frequency and bit rate, some files may not play normally. In this case, you will need to reduce the playback speed.

ABC repeat playback

The voice recorder has a function with which you can repeat the playback of a portion (segment) of the file being played. In addition to the A-B repeat function available from previous models, the segment to repeat can be changed during repeat playback.

ABC repeat playback

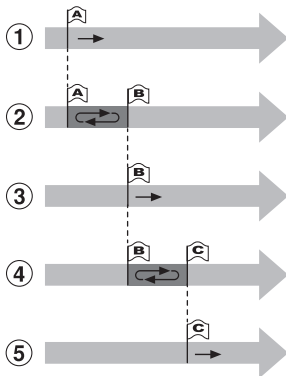

- ① Select the starting point for repeat playback (A) during playback.
- ② When the ending point (B) is selected, repeat playback starts.
- ③ When the starting point for repeat playback (A) is canceled during repeat playback, the ending point of the segment (B) becomes the new starting point and playback continues.
- ④ When the ending point (C) is selected, repeat playback starts again.
- ⑤ These steps can be repeated to re-specify a new segment to be played back repeatedly up to the end of the file.

- 1 Select a file for ABC repeat playback, and start playback.
- 2 Press the **F1 (SET A)** button when playback reaches the desired start position for ABC repeat playback.

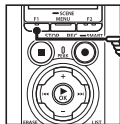

TIP

- You can change the playback speed (P.66), and fast-forward/rewind (P.60) when the **[A]** indicator is blinking.
- If playback reaches the end of the file when the **[A]** indicator is blinking, the end of the file is treated as the segment end position, and repeat playback starts.

- 3 Press the F1 (SET B) button again when playback reaches the desired end position for ABC repeat playback.**

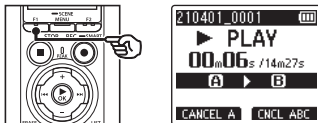

- Segment A-B is set, and ABC repeat playback starts.

Stopping ABC repeat playback:

☞ Go to Step **6**

Specifying new starting/ending points: ☞ Go to Step **4**

Specifying new starting/ending points

- 4 Press the F1 (CANCEL A) button during ABC repeat playback.**

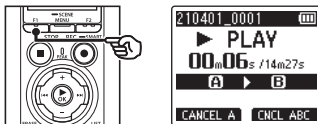

- Segment A-B is canceled. **[B]** becomes the new start position, and playback continues.
- You can change the playback speed (☞ P.66), and fast-forward/rewind (☞ P.60).

- 5 Press the F1 (SET C) button at the desired end position for ABC repeat playback.**

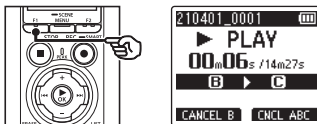

- Segment B-C is set, and ABC repeat playback starts.

TIP

- You can repeat Steps **4** and **5** as needed to change the repeat segment as desired.

- 6 Press the STOP (■) button.**

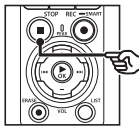

- Playback stops. The playback segment specified for this function is retained.

NOTE

- You cannot change the end position of a repeat playback segment to a position before the start position.
- You cannot write index marks or temp marks during ABC repeat playback (€3 P.70).

Canceling ABC repeat playback

Press the **F2 (CNCL ABC)** button.

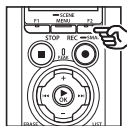

- If pressed when ABC repeat playback is stopped, cancels ABC repeat playback.
- If pressed during ABC repeat playback, cancels the playback segment setting for the function, and continues standard playback.

NOTE

- If you change the file or switch to different display screen, ABC repeat playback is canceled.

Index marks/temp marks

Writing an index mark or temp mark in a file enables you to quickly access desired position in the file with the same operations used for fast-forwarding, rewinding or skipping to the start of a file. You can write index marks in files created with this recorder. For files created with devices other than this company's voice recorders and files in which index marks cannot be written, you can write temp marks in a file being played, for temporarily remembering desired positions.

3

Playback

Writing an index mark/temp mark

- 1 Start playback after selecting the file to which you want to add index mark or temp mark.
- 2 When the desired position has been reached press the **F2 (INDEX)** button to write an index mark or temp mark.

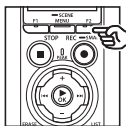

NOTE

- Temp marks are temporary markings. They are automatically erased when you select a different file, transfer the file to a computer, or move the file on a computer.
- If files created with this recorder are played on a computer, index marks may become unable to be written in the files.
- You can write up to 99 index marks/temp marks in a single file. The message **[Further marking not possible]** appears if you attempt to write more than 99 marks.
- You cannot write or erase index marks/temp marks in files that have been locked by the file lock function (P.80).
- You cannot write index marks in FLAC format files.

TIP

- Index marks can also be added during recording.

Erasing an index mark/temp mark

Deleting selected index/temp marks

Delete selected index/temp marks.

- 1 Select a file that contains index mark/temp mark you want to erase and start playback.
- 2 Use the **▶▶** or **◀◀** button to select the index mark/temp mark you want to erase.

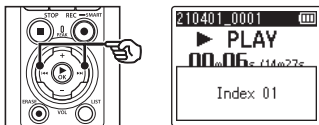

- 3 When the number of the index mark/temp mark to erase is being shown (for about 2 seconds) in the display, press the **ERASE** button.
 - Any subsequent index marks/temp marks in the file are automatically renumbered.

Erasing all index marks at once

You can erase all index marks in a file at once.

- 1 Select a file that contains index/temp marks you want to erase (see P.33).
- 2 When the file display screen appears, press the **ERASE** button while the voice recorder is in stop mode.

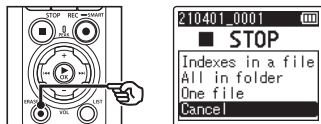

- The recorder will return to stop mode when the **◀◀** button is pressed or if no operations are performed for 8 seconds.
- 3 Press the **+** or **-** button to select [Indexes in a file].

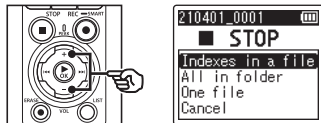

4 Press the ►OK button.

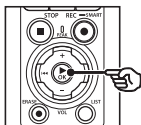

5 Press the + button to select [Start].

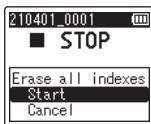
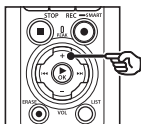

6 Press the ►OK button.

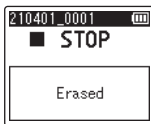
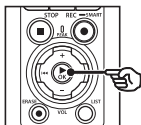

- **[Erasing!]** appears in the display, and the erasing process starts. **[Erased]** appears when the process has finished.

Calendar Search function

You can search for voice files by specifying a recording date. If you have forgotten in which folder a file has been saved, with this feature you can access it quickly by entering its recording date.

- You can only search for files saved in [Recorder] folder.

1 While the voice recorder is in stop mode, press the **F1 (HOME)** button to display the [Home] screen.

2 Press the **▶▶▶** or **◀◀◀** button to select [Calendar Search].

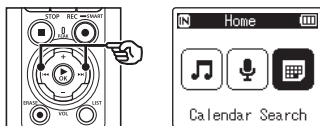

3 Press the **▶OK** button.

4 Press the **+**, **-**, **▶▶▶** or **◀◀◀** button to select the desired date.

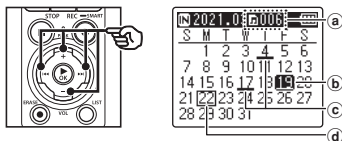

- a Number of files saved (recorded) on selected date
- b Selected date
- c Date file was recorded
- d Today's date

- Dates on which files were saved are underlined.

▶▶▶ / **◀◀◀** button:

Move to the next/previous date.
Press and hold to skip to the next date on which a file was recorded.

+ / **-** button:

Move to the previous/next week.

F1 / **F2** button:

Move to the previous/next month.

- Press the **STOP** (■) button to cancel the setting and return to the [Home] screen.

5 Press the **▶OK** button.

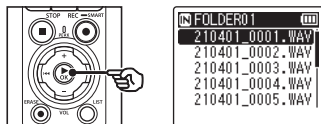

6 Press the **+** or **-** button to select the desired file.

7 Press the **▶OK** button to start playback.

Erasing files/folders

This section describes how to erase a single unneeded file from a folder, erase all the files in the current folder at once, or erase a selected folder.

Erasing files

- 1 Select the file you want to erase (P.33).
- 2 When the file display screen appears, press the **ERASE** button while the voice recorder is in stop mode.

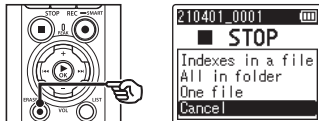

- The recorder will return to stop mode when the **◀◀** button is pressed or if no operations are performed for 8 seconds.

- 3 Press the **+** or **-** button to select **[All in folder]** or **[One file]**.

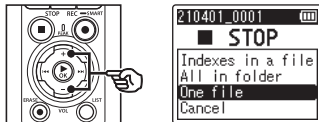

[All in folder]:

Erases all the files saved in the same folder as the selected file.

[One file]:

Erases only the selected file.

- 4 Press the **▶OK** button.

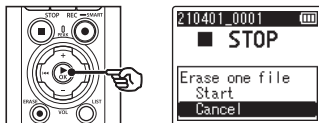

- 5 Press the **+** button to select **[Start]**.

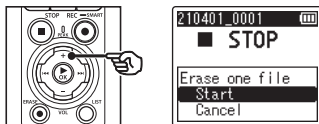

- 6 Press the **▶OK** button.

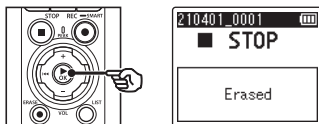

- **[Erasing!]** appears in the display, and the erasing process starts. **[Erased]** appears when the process has finished.

Erasing a folder

- 1 Select the folder you want to erase (see P.33).
- 2 In the folder display screen, press the **ERASE** button while the voice recorder is in stop mode.

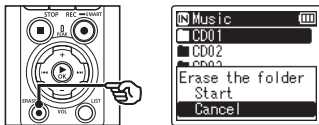

- The recorder will return to stop mode when the **◀◀** button is pressed or if no operations are performed for 8 seconds.

- 3 Press the **+** button to select **[Start]**.

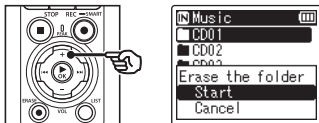

- 4 Press the **▶** **OK** button.

- **[Erasing!]** appears in the display, and the erasing process starts. **[Erased]** appears when the process has finished.

NOTE

- Files cannot be restored after being erased, so please check carefully before erasing a file.
- When there is a microSD in the voice recorder, be sure to check whether the recording media being erased is on the **[Internal memory]** or **[microSD card]** (see P.100).
- Locked files and read-only files cannot be erased (see P.80).
- The voice recorder's default **[Recorder]** folders and **[Music]** folder cannot be erased. Deleting all sub-folders from the **[Recorder]** folder creates a new sub-folder named **[FOLDER01]**.
- **[Music]** folder subfolders other than the **[Music]** can be erased.
- Files unrecognizable to the voice recorder will not be erased, nor will folders containing these files. The voice recorder must be connected to a computer to erase these files and folders.

- Before erasing a file or folder, charge or replace the batteries to ensure they will not run out before the process has finished. Erasing processes can take over 10 seconds to complete. To prevent the risk of damage to data, never attempt to perform any of the following processes before an erasing process has finished:
 - Disconnecting the AC adapter
 - Removing the batteries
 - Removing the microSD card (if the recording media has been set to **[microSD card]**).

Menu

Setting menu items

Basic operation

Menu items are arranged by tabs, with which you can quickly set desired items by selecting a tab and then moving to the desired item within the tab. Follow the steps below to set a menu item.

- 1 During recording/playback or while the voice recorder is in stop mode, press the **MENU/SCENE** button.

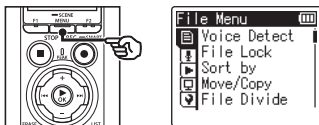

TIP

- Some menus contain items that can be set during recording/playback (see P.79).

- 2 Press the **+** or **-** button to select the tab containing the item you want to set.

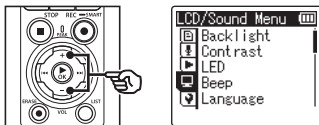

- Moving the cursor from one tab to another switches the displayed menu screen.

- 3 Press the **▶OK** button to move the cursor to the desired setting item.

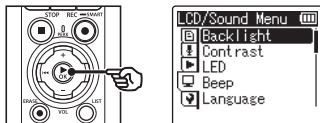

- You can also use the **▶▶** button to perform this operation.

- 4 Press the **+** or **-** button to select the desired setting item.

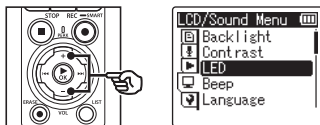

5 Press the ►OK button.

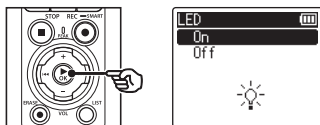

- The setting of the selected item is displayed.
- You can also use the ►►| button to perform this operation.

6 Press the + or – button to change the setting.

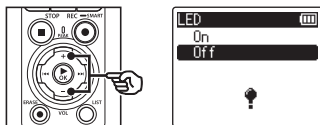

7 Press the ►OK button to finalize the setting.

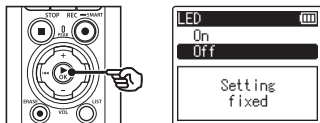

- A message indicating the setting has been entered appears.
- You can cancel the setting and return to the previous screen by pressing the I◀◀ button instead of the ►OK button.

8 Press the STOP (■) button to exit the menu screen.

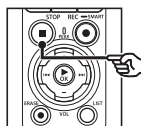

- When the menu screen is displayed during recording or playback, press the **MENU/SCENE** button to return to the previous screen without ending recording/playback.

NOTE

- For menu settings done while the voice recorder is in stop mode, the voice recorder exits the menu and returns to the stopped mode if no operation is performed for 3 minutes. The selected setting item is not changed in this case.
- For menu settings done during recording/playback, the voice recorder exits the menu if no operation is performed for 8 seconds.

■ Menu items that can be set during recording

- Rec Level
- Zoom Mic
- Low Cut Filter
- Bright Sound
- Rec Monitor
- External Input
- Backlight
- LED

■ Menu items that can be set during Playback

- Property
- Noise Cancel*¹
- Voice Balancer*¹
- Play Mode
- Equalizer*²
- Skip Space
- Backlight
- LED

*¹ Function active only in **[Recorder]** mode.

*² Function active only in **[Music]** mode.

File menu [File Menu]

4

Menu

Extracting the speaking portions of files of spoken-word content [Voice Detect]

The function extracts the speech portions of a voice file or a file being recorded by the voice recorder.

See "Extracting the speaking portions of files of spoken-word content [Voice Detect]" (P.105) for more information.

Preventing accidental file erasure [File Lock]

With the file lock feature you can lock important files to prevent them being accidentally erased. Once locked, a file is not erased even if the operation for erasing all the files in its folder is performed (P.74).

1 Select the file you want to lock (P.33).

[Lock]:

File is locked.

[Unlock]:

File lock is canceled.

Sorting files [Sort by]

You can change the playback order of the files in a folder.

1 Press the + or – button to select [File name], [Date ascending] or [Date descending].

[File name]:

Automatically sorts the files by file name.

[Date ascending]:

Automatically sorts the files by date (recording time/date) from oldest to newest files.

[Date descending]:

Automatically sorts the files by date (recording time/date) from newest to oldest files.

NOTE

- When [File name] is selected, files are listed in order of file name based on the first 20 characters of each name.

2 Press the + or – button to select [Recorder] or [Music].

[Recorder]:

Sorts all the files in the [Recorder] folder.

[Music]:

Sorts all the files in the [Music] folder.

Moving/copying files [Move/Copy]

Files saved in the internal memory or on a microSD card can be moved or copied within memory.

See "**Moving/copying files [Move/Copy]**" (☞ P.108) for the procedure.

Dividing files [File Divide]

Large files or files with long recording times can be divided for easier management and editing.

See "**Dividing files [File Divide]**" (☞ P.111) for the procedure.

Partially erasing files [Partial Erase]

You can erase unneeded parts of a file.

See "**Partially erasing files [Partial Erase]**" (☞ P.113) for the procedure.

Trimming a file [Trimming]

A file can be trimmed down to just the required portion and then re-saved.

See "**Trimming a file [Trimming]**" (☞ P.115) for the procedure.

Increasing the overall volume level of a file [Normalize]

Increase the overall volume level until the highest volume level of the recorded file becomes the no clipping (no distortion) threshold value and then save as a new file.

1 Press the + button to select [Start].

TIP

- The file is given the name "**File name_1**" after editing.
- If the current folder contains 200 files, a new folder will be created to hold the additional files.

NOTE

- Only PCM or MP3 format files recorded on the voice recorder can be edited.
- The normalize effect may not be achieved for files such as the following.
 - Files originally recorded at a high volume level.
 - Files in which sudden loud sounds are recorded.
 - Files containing a large variation of volume levels.

Fading in/out audio at the beginning/end of a file [Fade in/out]

You can apply fade in/out effect to the beginning/end of a file for approximately 1 second respectively and save the file as another file.

See “Fading in/out audio at the beginning/end of a file [Fade in/out]” (P.117) for the procedure.

Adding Prefixes to File Names [Rename File]

Add prefixes to file names.

- 1 Before performing the rename operation, first select the folder containing the file you want to rename (P.33).
- 2 Press the **MENU/SCENE** button while the voice recorder is in stop mode.
- 3 Press the **▶OK** button to move the cursor into the list of setting items.
- 4 Press the **+ or –** button to select [Rename File].
- 5 Press the **▶OK** button.
- 6 Press the **+ or –** button to choose a prefix to add to the file name.

Available Prefixes

Important	[2]	[A]	[E]
OK	[3]	[B]	
Keep	[4]	[C]	
[1]	[5]	[D]	

7 Press the **▶OK** button.

- The selected prefix will be added to the file name.

TIP

- [Rename File] is available in [Recorder] mode only.
- Locked files (P.80) cannot be renamed.

Displaying file or folder information [Property]

You can display the information of a file or folder from a menu screen.

File information

- 1 Press the **+ or –** button to switch the screen.
 - Information is displayed for the items [Name], [Date], [Size], [Bit Rate]¹, [Artist]² and [Album]².
- *1 If you selected a linear PCM or FLAC format file, the [Bit Rate] item displays the sampling frequency and bit count.
- *2 If the file has no tag information, [UNKNOWN_ARTIST] and [UNKNOWN_ALBUM] are displayed.

Folder information

- 2** Press the + or – button to switch the screen.
- Information is displayed for the items **[Name]**, **[File]** (the number of files) and **[Folder]** (the number of folders).
 - The **[Folder]** item is not displayed in **[Recorder]** mode.
 - Displayed numbers of files do not include files in formats that are unrecognizable to the voice recorder.

Recording menu [Rec Menu]

Selecting the recording level [Rec Level]

You can change the recording level (sensitivity) as needed for your recording application.

[High]:

The highest recording sensitivity. Suited to recording lectures, large conferences and other applications with distant or quiet sound sources.

[Middle]:

Suited to recording discussions and small-group meetings.

[Low]:

The lowest recording sensitivity. Suited to recording dictation.

[Manual]:

Lets you set the recording sensitivity manually, to any of 40 levels.

[Auto]:

The recording level always automatically changes according to the volume of the input sound. Suited to recording all sounds.

TIP

- To record the speaker's voice clearly, set [Rec Level] to [Middle], and place the voice recorder's built-in microphone near the speaker's mouth (5 to 10 cm away).

NOTE

- When [Rec Level] is set to other than [Manual], the recording level is adjusted automatically but noise may be generated if an excessively loud sound is input.
- The [Rec Scene] setting automatically changes to [Off] when [Rec Level] is set.

Adjusting the recording level

- Adjust the recording level by pressing the **▶▶** or **◀◀** button during recording or when recording is paused.

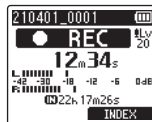
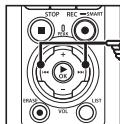

- Increasing the [Rec Level] number increases the recording level and extends the level meter indicator position.

NOTE

- If [OV] is displayed, the recorded audio will be distorted. Adjust the recording level so that [OV] is not displayed.
- [Rec Level] cannot be set during recording when [Rec Scene] is set.

Reducing clipping [Limiter]

Automatically reduce clipping caused by the input of excessively loud sounds during recording.

[Music]:

Select this setting for clarity of sound volume. This setting is suitable for music recordings.

[Voice]:

Select this setting to equalize the sound volume. The sound can be recorded at a predetermined volume to produce equalized recordings. This setting is suitable for voice recordings.

[Off]:

Use this position when adjusting the input levels without using the correction function.

NOTE

- This function is only available when [Rec Level] is set to [Manual] (P.84).
- If the sound input is too loud, noise may occur even if you set to [Music] or [Voice]. Also, in certain cases the **PEAK** indicator light, which indicates loud input, may not lit. To ensure successful recording, we recommend that you test the record function and volume before use.

Setting the recording mode [Rec Mode]

You can prioritize sound quality or recording time. Select the recording mode that best matches your recording application.

1 Press the + or – button to select the recording format.**[PCM]:**

This is an uncompressed audio format which is used for music CDs etc.

[FLAC]:

This is a losslessly compressed audio format. File size in this format is smaller than in the PCM format.

[MP3]:

This is a common lossy compressed audio format. File size in this format is the smallest.

2 Press the + or – button to select the recording rate.

[96.0kHz/24bit]	[PCM] [FLAC]
[88.2kHz/24bit]	[PCM] [FLAC]
[48.0kHz/24bit]	[PCM] [FLAC]
[48.0kHz/16bit]	[PCM] [FLAC]
[44.1kHz/24bit]	[PCM] [FLAC]
[44.1kHz/16bit]	[PCM] [FLAC]
[44.1kHz mono]*	[PCM] [FLAC]
[320kbps]	[MP3]
[128kbps]	[MP3]
[64kbps mono]*	[MP3]

* Mono recording

TIP

- Sound quality increases as the recording rate value increases.
- Setting a higher recording rate increases file size. Check that you have enough remaining memory before recording.
- To record conferences and presentations clearly, it is recommended to set [Rec Mode] to other than [mono].

NOTE

- When [Rec Mode] is set to stereo, recording with a connected mono microphone records on the left channel only.
- Adjusting [Rec Mode] settings selects [Off] for [Rec Scene] and [Fn Rec] > [Over Dubbing].
- Selecting [PCM] or [FLAC] selects [Off] for [Voice Detect] > [While Recording] and [Fn Rec] > [Pre-Recording].
- Seconds of the remaining recordable time is not displayed when [FLAC] is set.

Selecting microphone directivity [Zoom Mic]

The voice recorder's built-in stereo microphone provides directivity ranging from broad-coverage stereo recording to highly directional recording.

- 1 Press the **+** or **-** button to adjust the built-in stereo microphone's directivity.

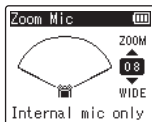
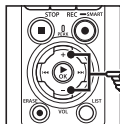

- The setting can be adjusted to between [00] and [20].
- The **+** button increases directivity.
- The **-** button enables recordings with broader-coverage stereo.
- Reducing directivity and broadening the sound pickup range gives recordings more of a stereo effect.

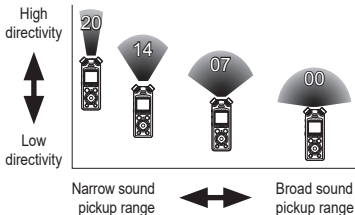

NOTE

- The **[Rec Scene]** setting automatically changes to **[Off]** when **[Zoom Mic]** is set. **[Zoom Mic]** cannot be set during recording when **[Rec Scene]** is set.

Reducing noise during recording [Low Cut Filter]

The voice recorder's low cut filter function lets you make recordings that reduce humming sounds from air-conditioners or low-frequency sounds from equipment such as projectors.

[On]:

Turns the low cut filter On.

[Off]:

Turns the low cut filter Off.

NOTE

- The **[Rec Scene]** setting automatically changes to **[Off]** when **[Low Cut Filter]** is set. **[Low Cut Filter]** cannot be set during recording when **[Rec Scene]** is set.

Recording clear audio [Bright Sound]

Create recordings with bright, clear sound.

[On]:

Create recordings with bright, clear sound.

[Off]:

Record audio that is faithful to the source.

NOTE

- **[Bright Sound]** is available only with the built-in microphone.

Selecting the automatic recording setting [Rec Scene]

The voice recorder has preregistered templates of optimum settings tailored to various recording applications such as lectures and dictation. When selecting one of these templates you can enter several settings recommended for your recording application all in a single operation.

See “**Selecting the automatic recording setting [Rec Scene]**” (☞ P.47) for the procedure.

Disabling output during recording [Rec Monitor]

Configure the recorder to disable output to external speakers and other connected devices during recording.

[On]:

Sound is output to connected devices during recording.

[Off]:

Sound is not output to connected devices during recording.

NOTE

- Sound will not be output to **Bluetooth**® earphones if a 24-bit [PCM] or [FLAC] option is selected for [Rec Menu] > [Rec Mode]. Choose a non-24-bit option (☞ P.85).

Recording Using External Mics or Other Input Devices Connected to the Recorder [External Input]

Record sound from an external microphone or audio device connected via the voice recorder's microphone/line jack (🎤).

See “**Recording Using External Mics or Other Input Devices Connected to the Recorder [External Input]**” (☞ P.53) for the procedure.

Starting recording at a set time [Timer Rec]

Start and end recording at specified times. See “**Starting Recording at a Set Time [Timer Rec]**” (☞ P.118) for the procedure.

Placing the recorder on standby before recording [Rec Standby]

The recorder can be configured so that pressing the **REC (●)** button once initiates standby rather than immediately starting recording. You can adjust the recording level while the recorder is on standby and then press the **REC (●)** button again to start recording.

[On]:

Pressing the **REC (●)** button switches the recorder to standby mode so that the recording level can be adjusted. Press the **REC (●)** button again to start recording.

[Off]:

Recording begins as soon as the **REC (●)** button is pressed. The recorder will not enter standby mode.

TIP

- For information on making recordings using [Rec Standby], see “Adjusting Recording Levels Manually Before Recording” (P.41).

Choosing a recording method [Fn Rec]

A variety of recording options can be assigned to the **F2** button for quick recall. See “Choosing a Recording Method [Fn Rec]” (P.121) for the procedure.

Starting recording before you press record [Pre-Recording]

With pre-recording, recording starts approximately two seconds before you press the **REC (●)** button. If, for example, you were recording bird song and pressed the **REC (●)** button the moment you heard the first note, the recording would actually begin slightly before the bird started singing.

See “Starting Recording Before You Press Record [Pre-Recording]” (P.123) for the procedure.

Voice sync recording function [V-Sync. Rec]

The voice sync recording function automatically starts recording when a sound louder than a preset voice sync recording level (detection level) is detected, and automatically stops recording when the sound volume level decreases. When copying music from another device connected to the voice recorder, use the voice sync recording function to detect the silent intervals between music tracks and save each track as a separate file.

■ Adjusting the voice sync level for voice sync recording

- 1 Press the **F2 (SYNC)** button to prepare for recording.
- 2 Press the **▶▶|** or **|◀◀** button to adjust the voice sync level.

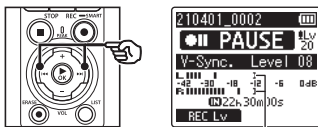

Voice sync level (moves left/right to match set level)

- The voice sync level can be adjusted to a setting between [01] and [20].
- Increasing the setting number increases the activation sensitivity, enabling quieter sounds to activate the start of recording.

TIP

- To change the recording level (P.84) during voice sync level adjustment in [Manual], press the **F1** button. The voice recorder changes to recording level adjustment mode. Press the **F1** button again to return to voice sync level adjustment mode.

3 Press the **REC (●)** button.

- The blinking message [Standby] appears in the display, and the recording indicator light blinks.
- Recording starts automatically if the input is louder than the voice sync level.

TIP

- The voice recorder automatically ends recording and returns to recording standby mode if the input sound remains below the voice sync level for longer than the time selected for [V-Sync. Time] (P.93). Each time the voice recorder enters standby mode, the current file is closed. Recording continues in a new file the next time sound is detected.
- Press the **STOP (■)** button to end a voice sync recording session.

Using overdubbing [Over Dubbing]

You can overdub a file while listening to its playback sound. The overdubbed file is saved with a different name. This function is useful for composing music or practicing musical instruments.

See "**Using Overdubbing [Over Dubbing]**" (P.125) for the procedure.

Voice-activated recording function [VCVA]

The voice-activated recording function (VCVA) automatically starts recording when a sound louder than a preset voice activation level is detected, and automatically pauses recording when the sound volume level falls. Use this function to automatically omit unneeded quiet segments when recording (such as long silences during conferences), saving memory.

■ Adjusting the voice activation level for voice-activated recording

- 1** Press the **F2 (VCVA)** button to prepare for recording.

- 2** Press the **▶▶** or **◀◀** button to adjust the voice activation level.

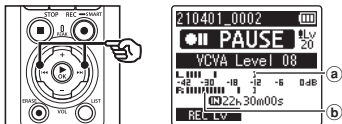

- a Voice activation level (moves left/right to match set level)
- b Level meter (changes in proportion to recording sound volume)
- The setting can be adjusted to between **[01]** and **[20]**.

- 3** Press the **REC (●)** button to start recording.

- Recording pauses automatically about 1 second after the input sound becomes quieter than the set activation sensitivity. The blinking message **[Standby]** appears in the display. The recording indicator light becomes lit when recording is activated and flashes when recording is paused.

TIP

- Increasing the setting number increases the VCVA activation sensitivity, enabling quieter sounds to activate the start of recording.
- Adjust the VCVA voice activation level to suit the recording conditions (to cope with high levels of surrounding noise or the like).
- To avoid recording mistake, it's recommended to perform a test recording beforehand to adjust the voice activation level.
- To change the recording level (see P.84) during VCVA recording in **[Manual]**, press the **F1** button. The voice recorder changes to recording level adjustment mode. Press the **F1** button again to return to voice activation level adjustment mode.

Choosing the Voice Sync Time [V-Sync. Time]

Choose how long the voice recorder continues to record after the input volume falls below the level selected for [V-Sync. Rec] (☞ P.89).

- 1 Press the **MENU/SCENE** button while the voice recorder is in stop mode.
- 2 Press the **+** or **-** button to select the [Rec Menu] tab.
- 3 Press the **▶OK** button to move the cursor into the list of setting items.
- 4 Press the **+** or **-** button to select [V-Sync. Time].
- 5 Press the **▶OK** button.
- 6 Press the **+** or **-** button to change the setting.
[1 sec.], [2 sec.], [3 sec.], [5 sec.]:
Set the detection time. The voice recorder enters standby mode when the input (recording level) is below the preset level for at least the set detection time.
- 7 Press the **▶OK** button to finalize the setting.
- 8 Press the **STOP (■)** button to exit the menu screen.

Recording a Reference Tone for Use When Synchronizing Audio and Video [Slate Tone]

Reference tones, otherwise known as "slate tones", can be recorded for use during editing to help synchronize audio and video when audio from the voice recorder is substituted for sound recorded by the camera (☞ P.128).

See "Recording a Reference Tone for Use When Synchronizing Audio and Video [Slate Tone]" (☞ P.126) for the procedure.

Adjusting Sound Level for Output to the Camera [Test Tone]

Using a test tone to match output volume to the optimal camera recording level before beginning recording helps prevent crackling and distortion.

See "Adjusting Sound Level for Output to the Camera [Test Tone]" (☞ P.129) for the procedure.

Playback menu [Play Menu]

Skipping non-voice portions during playback [Voice Playback]

With the [Voice Playback] function you can only play the speaking portions of a recorded file of spoken-word content.

NOTE

- The speaking portions of the file must be extracted beforehand (see P.105).
- The [Voice Playback] function is only enabled in [Recorder] mode.

[On]:

Automatically skips the non-voice portions of the file and plays only the speaking portions.

[Off]:

The voice playback function is disabled.

Reducing noise during playback [Noise Cancel]

Use the [Noise Cancel] function to reduce noise when a recorded voice is difficult to discern.

[High][Low]:

Reduces surrounding noise, producing higher sound-quality playback.

[Off]:

The noise reduction function is disabled.

NOTE

- [Noise Cancel] is only enabled in [Recorder] mode.
- Using the [Noise Cancel] function will make the batteries deplete more quickly.

Adjusting low volume portions during playback [Voice Balancer]

Cuts low- and high-frequency components and compensates low-volume portions during playback.

Use it to make quiet parts of conversations or other recorded audio louder and clearer.

[On]:

Adjusts low-volume portions of audio files during playback, making them louder.

[Off]:

The voice balancer function is disabled.

NOTE

- [Voice Balancer] is only enabled in [Recorder] mode.
- Using the [Voice Balancer] function will make the batteries deplete more quickly.

Selecting playback modes [Play Mode]

Several playback modes are available for different listening styles.

- 1 Press the **+** or **-** button to select [Recorder] or [Music].

When [Recorder] was selected

- 2 Press the **+** or **-** button to select [File] or [Folder].

[File]:

Stops playback after the current file has been played.

[Folder]:

Plays all the files in the current folder consecutively, stopping playback after the last file in the folder is played.

When [Music] was selected

- 3 Press the **+** or **-** button to select [Playback Range], [Repeat] or [Random].

[Playback Range]:

Lets you specify a range of files for playback.

[Repeat]:

Repeatedly plays the files in the set range.

[Random]:

Plays the files in the set range at random.

4 Press the + or – button to select a setting.

When [Playback Range] was selected:

[File], [Folder], [All]:

Specify the range of files for playback.

When [Repeat] or [Random] was selected:

[On]:

The files in the specified playback range are played repeatedly or at random.

[Off]:

Cancels repeat playback and random playback.

NOTE

- When [Playback Range] is set to [File], [End] will be displayed after the last file in the folder has been played and playback will stop at the start position of the last file.
- When [Playback Range] is set to [Folder], [End] will be displayed after the last file in the folder has been played and playback will stop at the start position of the first file in the folder.
- When [Playback Range] is set to [All], after the last file in the current folder has been played, the first file in the next folder is being played. When playback reaches the end of the last file in the voice recorder, [End] will be displayed and playback will stop at the start position of the first file in the voice recorder.

Changing music sound quality [Equalizer]

The voice recorder's equalizer settings can be changed to change music sound quality as desired.

When [User] was selected

1 Press the ►►► button.

2 Press the ►►► or ◀◀◀ button to select a frequency band.

- You can set different levels for the [60 Hz], [250 Hz], [1 kHz], [4 kHz] and [12 kHz] frequency bands.

3 Press the + or – button to set a level.

- Levels can be set to values between [–6] and [+6], in 1 dB increments.
- Increasing a level setting emphasizes the corresponding frequency band.
- To change another frequency band, repeat Steps 2 and 3.

NOTE

- [Equalizer] function is only enabled in [Music] mode.

Setting a skip space [Skip Space]

The **[Skip Space]** function lets you skip a preset amount forward (forward skip) or backward (reverse skip) in a file during playback. It is handy for quickly moving the playback position, or for repeated playback of a short segment.

- 1 Press the **+** or **-** button to select **[Forward Skip]** or **[Reverse Skip]**.

[Forward Skip]:

Starts playback after moving the playback position forward by the set amount.

[Reverse Skip]:

Starts playback after moving the playback position backward by the set amount.

- 2 Press the **+** or **-** button to select a setting.

When **[Forward Skip]** was selected:

[File Skip], **[10 sec. Skip]**, **[30 sec. Skip]**, **[1 min. Skip]**, **[5 min. Skip]**, **[10 min. Skip]**

When **[Reverse Skip]** was selected:

[File Skip], **[1 sec. Skip]** to **[3 sec. Skip]**, **[5 sec. Skip]**, **[10 sec. Skip]**, **[30 sec. Skip]**, **[1 min. Skip]**, **[5 min. Skip]**

NOTE

- Forward/reverse skip operations over a skip space that contains an index mark/temp mark or the starting position of a file will stop at that mark or at the start position.

Forward/reverse skip playback

- 1 Press the **▶OK** button to start playback.
- 2 Press the **▶▶** or **◀◀** button during playback.
 - Playback starts after skipping forward or backward by the set amount.

LCD/Sound menu [LCD/Sound Menu]

Setting the backlight [Backlight]

The display backlights are switched on for a preset amount of time when a button operation is performed.

[5 sec.], **[10 sec.]**, **[30 sec.]**, **[1 min.]**:

Set the amount of time that the backlight stays lit.

[Off]:

Disables the backlight.

Adjusting the contrast [Contrast]

You can adjust the contrast of the display to 12 different levels.

- The setting can be adjusted to between **[01]** to **[12]**.

Setting the LED indicator light [LED]

Disable the LED (recording/**PEAK**) indicator light.

[On]:

LED indicator light is switched on.

[Off]:

LED indicator light stays off.

TIP

- Even if you set the **[LED]** setting to **[Off]**, the LED indicator light will flash while files are being transferred between the voice recorder and a computer.

Turning beeping sound on/off [Beep]

The voice recorder makes beeping sounds when buttons are pressed, or to warn in case of operation errors. You can select whether the voice recorder makes these beeping sounds.

[On]:

Enables beeping sounds.

[Off]:

Disables beeping sounds.

Changing the display language [Language]

You can select the language used in the voice recorder's displays.

- **[Čeština]**, **[Dansk]**, **[Deutsch]**, **[English]**, **[Español]**, **[Français]**, **[Italiano]**, **[Nederlands]**, **[Polski]**, **[Русский]**, **[Svenska]**, **[繁體中文]**.

Playing the beginning of files automatically [Intro Play]

Each time you select a file in the file list screen, the voice recorder can automatically play a few seconds of the beginning of the file. This function is convenient for searching for a file because it allows you to check the content of files.

[3 sec.], [5 sec.], [10 sec.]:

Each time you select a file, the beginning part will be played automatically.

[Off]:

Turns **[Intro Play]** off.

Selecting the speaker output [Speaker]

You can set the built-in speaker to be On or Off when the earphones are not connected. When set to **[Off]**, sound will not be output from the speaker even if the earphones are accidentally disconnected. Use this setting to prevent possible embarrassment on public transport.

[On]:

The voice recorder's playback sound is output from the earphones when the earphones are connected, or from the built-in speaker when the earphones are not connected.

[Off]:

The voice recorder's playback sound is not output from the built-in speaker even if the earphones are disconnected.

Device menu [Device Menu]

4

Menu

Connecting a Bluetooth® device [Bluetooth]

This function is compatible with **Bluetooth®** and allows you to connect the voice recorder to a device that is compatible with the same standard. See "**Before using the Bluetooth® function**" (☞ P.135) for details.

Selecting the recording media [Memory Select]

If a microSD card is inserted into the voice recorder, you can select whether to use the internal memory or the microSD card (☞ P.22).

[Internal memory]:

Uses on the internal memory on the voice recorder.

[microSD card]:

Uses on the microSD card.

Setting power save mode [Power Save]

The voice recorder automatically enters power save mode if the voice recorder is stopped for a set amount of time after it is turned on. Pressing any button releases power save mode.

[5 min.], [10 min.], [30 min.], [1 hr.]:

Select the desired amount of time.

[Off]:

Disables power save mode. Note that leaving the voice recorder on will quickly deplete the batteries.

Choosing the type of battery in use [Battery]

Set the battery type to match the batteries you are using.

[Ni-MH]:

Select this setting when using Ni-MH rechargeable BR404 batteries.

[Alkaline]:

Select this setting when using alkaline dry-cell batteries.

Setting the time/date [Time & Date]

If you set the date and time, you will be able to check when a file was recorded in the information for each file accessed from [Property] of the menu.

- 1 Press the **▶▶▶** or **◀◀◀** button to select the desired setting item.

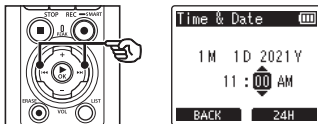

- 2 Press the **+** or **-** button to change the number.

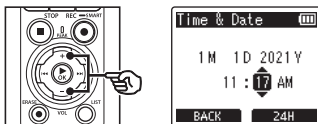

- To change the setting of another item, press the **▶▶▶** or **◀◀◀** button to move the blinking cursor, then press the **+** or **-** button to change the number.

- 3 Press the **▶OK** button to finalize the setting.

TIP

- When setting the hour or minute, each time you press the **F2** button the display changes between the AM/PM and 24-hour clock formats.

Example: 10:38 PM

10:38 PM (default format) ↔ 22:38

- When setting the year, month or date, each time you press the **F2** button the display order used for the date changes.

Example: January 31, 2021

1M 31D 2021Y (default format)

↓
31D 1M 2021Y

↓
2021Y 1M 31D

NOTE

- If the batteries are removed from the voice recorder, the [Time & Date] screen is displayed automatically when the power is turned on.
- Even if the voice recorder is not used for a long period of time, when the batteries are used up, the date and time must be re-entered.

Setting the USB connection [USB Settings]

The **[PC]** setting lets you connect the voice recorder to a computer to transfer files. The **[AC Adapter]** setting lets you connect the voice recorder to a USB-connection AC adapter (model F-5AC; optional) or a computer to charge the rechargeable batteries. You can change the USB class setting as required by different USB applications.

See “**Setting the USB connection [USB Settings]**” (P.131) for the procedure.

Restoring the default settings [Reset Settings]

The **[Reset Settings]** function restores all the voice recorder’s functions to their initial (factory default) settings. Time setting and file number will remain the same.

- 1 **Press the + button to select [Start].**

Rec Menu:

Rec Level: Manual
Limiter: Music
Rec Mode: PCM: 44.1kHz/16bit
Zoom Mic: 00
Low Cut Filter: Off
Bright Sound: Off
Rec Scene: Off
Rec Monitor: On
External Input: Microphone
Timer Rec: Off
Rec Standby: Off
Fn Rec: Off
V-Sync. Time: 2 sec.
Slate Tone: Off

Play Menu:

Voice Playback: Off

Noise Cancel: Off

Voice Balancer: Off

Play Mode:

Recorder:

Playback Range / File

Music:

Playback Range / Folder

Repeat / Off

Random / Off

Equalizer: Off

Skip Space:

Forward Skip: File Skip

Reverse Skip: File Skip

LCD/Sound Menu:

Backlight: 10 sec.

Contrast: Level 06

LED: On

Beep: On

Language: English

Intro Play: Off

Speaker: On

Device Menu:

Bluetooth: Off

Memory Select: Internal memory

Power Save: 10 min.

Battery: Ni-MH

USB Settings:

USB Connection: PC

USB Class: Storage Class

Formatting a recording media [Format]

Formatting a recording media erases all existing files saved on it. Be sure to transfer all important files to a computer before formatting.

See "**Formatting recording media [Format]**" (P.133) for the procedure.

Checking recording media information [Memory Info.]

You can display the capacity and remaining memory space of the recording media from a menu screen.

NOTE

- Some recording media memory capacity is used as a management area, so the actual usable capacity will always be slightly less than the displayed capacity.

Checking voice recorder information [System Info.]

You can display voice recorder information from a menu screen.

- The voice recorder's **[Model]**, **[Version]** (system version) and **[Serial No.]** information is displayed.

Viewing Certification Marks [Certification]

View the recorder's product certifications.

Extracting the speaking portions of files of spoken-word content [Voice Detect]

The function extracts the speech portions of a voice file or a file being recorded by the voice recorder.

- The [Voice Detect] function can only be used in [Recorder] mode.

NOTE

- To extract the speech portion from saved files, select a folder from the [Recorder] folder beforehand.

- 1 Press the **MENU/SCENE** button while the voice recorder is in stop mode.
- 2 Press the **▶OK** button to move the cursor into the list of setting items.
- 3 Press the **▶OK** button.
- 4 Press the **+** or **-** button to select [Select a file] or [While recording].

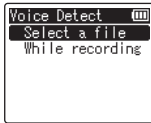
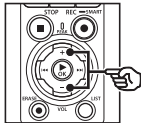

[Select a file]:

Select a file for which you want to extract the speech portion.

[While recording]:

Extract the speech portion while recording.

- 5 Press the **▶OK** button to move to the respective setting.

When [Select a file] is selected

- ① Press the **+** or **-** button to select the desired file in which you want to detect voice.

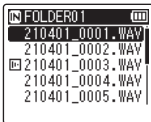

- ② Press the **▶OK** button.
 - The progress of the operation is shown as a percentage in the display.
 - [Voice Detection completed] appears when the process has finished.
- ③ Press the **STOP** (■) button to exit the menu screen.
 - Files created via voice detection are indicated by icons in the file list.

File created via voice detection

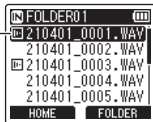

TIP

- The **[Voice Playback]** option in **[Play Menu]** toggles to **[On]** when voice detection is complete. To hear the original, pre-voice-detection audio for files created using voice detection, select **[Off]** for **[Voice Playback]** (☞ P.94).

TIP

- To resume normal recording and include non-voice audio, select **[Off]** for **[While recording]**.
- To play only the voice portion of audio recorded with **[On]** selected for **[While recording]**, select **[On]** for **[Voice Playback]** in **[Play Menu]**. To hear the original audio, including the non-voice portion, select **[Off]** for **[Voice Playback]** (☞ P.94).

When [While recording] is selected

- ① Press the **+** or **-** button to select **[On]** or **[Off]**.



- Only the voice portions of files recorded with **[On]** selected for **[While recording]** will be saved.
- ② Press the **▶OK** button.
- **[Setting fixed]** appears when the process has finished.
 - To check for an icon showing whether voice detection is active, press the **STOP** (■) button while the recorder is stopped and then cycle the display by pressing the **+** or **-** button.

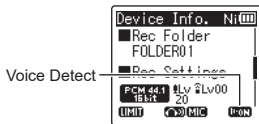

NOTE

- The message [**No file**] appears if you select a folder that doesn't contain a saved file. You must select a folder containing a file before you can perform the process.
- The voice recorder may not be able to properly extract non-silent portions from files of non-spoken word content such as recorded musical performances.
- The voice recorder may not be able to properly extract speaking portions when they were low in volume when recorded (level meter readout of -12 dB or less), or due to surrounding noise.
- The time needed for the extraction process will increase in proportion to the size of the recorded file. Before starting extraction, it's recommended to charge or replace the batteries to ensure they will not run out before the process has finished.
- Using the [**While recording**] function will make the batteries deplete more quickly.
- [**While recording**] function is only available when [**Rec Mode**] is set to [**MP3**] (☞ P.85).
- The following functions are disabled when using the [**While recording**] function:
 - [**Rec Scene**] (☞ P.47)
 - [**Fn Rec**] (☞ P.121)

Moving/copying files [Move/Copy]

Files saved in the internal memory or on a microSD card can be moved or copied within memory.

- 1 Before performing the move/copy operation, first select the folder containing the file you want to move or copy (P.33).**
- 2 Press the MENU/SCENE button while the voice recorder is in stop mode.**
- 3 Press the ►OK button to move the cursor into the list of setting items.**
- 4 Press the + or – button to select [Move/Copy].**
- 5 Press the ►OK button.**
- 6 Press the + or – button to select the desired file movement/copying method.**

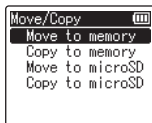
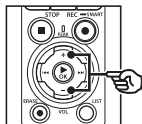

[Move to memory]:

Moves one or more files saved in the internal memory or inserted microSD card to a different folder in the internal memory.

[Copy to memory]:

Copies one or more files saved in the internal memory or inserted microSD card to a different folder in the internal memory.

[Move to microSD]:

Moves one or more files saved in the internal memory or inserted microSD card to a different folder in the microSD card.

[Copy to microSD]:

Copies one or more files saved in the internal memory or inserted microSD card to a different folder in the microSD card.

- 7 Press the ►OK button.**
- 8 Press the + or – button to select the number of files to move or copy.**

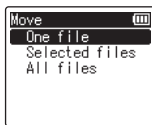
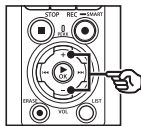

[One file]:

Selects only the specified file.

[Selected files]:

Selects multiple files.

[All files]:

Selects all the files in the folder.

- 9 Press the **▶OK** button to continue to the next setting.

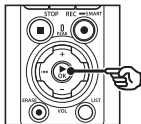

When [One file] was selected

- ① Press the **+** or **-** button to select the file to move or copy, then press the **▶OK** button.

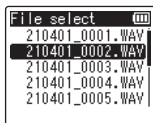

When [Selected files] was selected

- ① Press the **+** or **-** button to select a file to move or copy, then press the **▶OK** button.

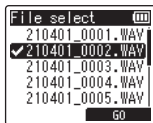

TIP

- You can deselect a previously selected file by selecting it and pressing the **▶OK** button again.

- ② Repeat Step ① to select all the files you want to move or copy, then press the **F2** button.

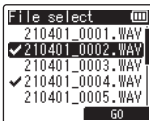

When [All files] was selected

All the files in the current folder are selected automatically, and the display switches to the **[Destination]** screen.

- 10 Press the **+**, **-**, **▶▶** or **◀◀** button to select the folder to move or copy the files to.

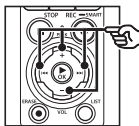

TIP

- Files cannot be moved or copied directly within the **[Recorder]** folder. Press the **▶▶** or **◀◀** button to select a folder in the **[Recorder]** folder.

11 Press the F2 button.

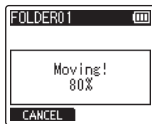
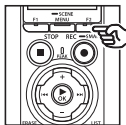

- The progress of the operation is shown as a percentage in the display.
- **[File move completed]** or **[File copy completed]** appears when the process has finished.

TIP

- Locked files (P.80) remain locked after being moved or copied.

NOTE

- Files cannot be copied if there is insufficient remaining memory.
- Files cannot be moved or copied if there are over 200 files.
- To prevent the risk of data damage, never remove the batteries while moving or copying a file.
- Files cannot be moved or copied within the same folder.
- When a file moving or copying process is canceled before completion, the files that completed the process will have been moved or copied, and process is canceled for the other files.

Dividing files [File Divide]

Large files or files with long recording times can be divided for easier management and editing.

NOTE

- Only PCM or MP3 format files recorded on the voice recorder can be divided.

- 1 Before performing the file dividing operation, first select the file you want to divide (☞ P.33).
- 2 Press the **MENU/SCENE** button while the voice recorder is in stop mode.
- 3 Press the **▶OK** button to move the cursor into the list of setting items.
- 4 Press the **+** or **-** button to select [File Divide].
- 5 Press the **▶OK** button.
- 6 Press the **▶OK** button and play the file to the desired division point (☞ P.58).

TIP

- Writing an index mark/temp mark at the division point beforehand is handy (☞ P.70).

- 7 Press the **F2** button at the desired division point.

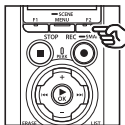

- 8 Press the **+** button to select [Start].

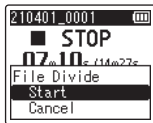
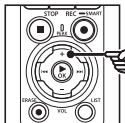

- 9 Press the **▶OK** button.

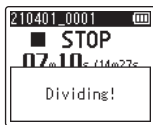
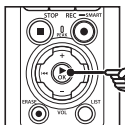

- [Dividing!] appears in the display, and the file dividing process starts. [File divide completed] appears when the process has finished.

- 10 Press the **STOP (■)** button to exit the menu screen.

TIP

- After dividing a file, the first half of the file is given the name "**File name_1**" and the second half "**File name_2**".
- If the current folder contains 200 files, a new folder will be created to hold the additional files.

NOTE

- [File Divide] can be performed only when the file list is displayed.
- Locked files (Ⓛ P.80) cannot be divided.
- It may not be possible to divide some MP3 or PCM files with extremely short recording times.
- To prevent the risk of data damage, never remove the batteries while dividing a file.

Partially erasing files [Partial Erase]

You can erase unneeded parts of a file.

NOTE

- Only PCM-format file recorded on the voice recorder can be erased.

- 1 Before performing the file erasing operation, first select the file you want to erase (P.33).**
- 2 Press the MENU/SCENE button while the voice recorder is in stop mode.**
- 3 Press the ►OK button to move the cursor into the list of setting items.**
- 4 Press the + or - button to select [Partial Erase].**
- 5 Press the ►OK button.**
- 6 Press the ►OK button to play the file to the desired erasing point (P.58).**
 - You can change the playback speed (P.66), and fast-forward/rewind (P.60).

- 7 Press the F2 button at the partial erase start position.**

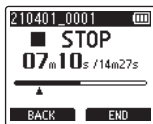
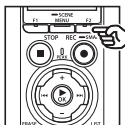

TIP

- Playback continues while [Start] position is set and as with usual playback, changing the playback speed and fast-forward/rewind can be performed and you can quickly advance to the [End] position.
- When the end of the file is reached while the [End] position is not set, that position becomes the end position of erase.
- Writing an index mark/temp mark at the start point and end point beforehand is handy (P.70).

- 8 Press the F2 button again at the position where you want to end partial erase.**

- 9** Press the **+** button to select **[Start]**.

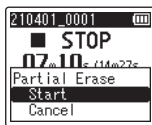
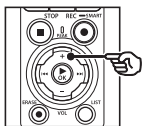

- 10** Press the **▶OK** button.

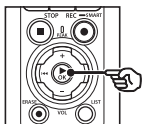

- **[Partial erasing!]** appears in the display, and the file erasing process starts.
- **[Partial erase completed]** appears when the process has finished.

- 11** Press the **STOP** (■) button to exit the menu screen.

NOTE

- Files cannot be restored after being erased, so please check carefully before erasing a file.
- Locked files and read-only files cannot be erased (refer P.80).
- Before erasing a file or folder, charge or replace the batteries to ensure they will not run out before the process has finished. Erasing processes can take over 10 seconds to complete. To prevent the risk of damage to data, never attempt to perform any of the following processes before an erasing process has finished:
 - Disconnecting the AC adapter
 - Removing the batteries
 - Removing the microSD card (if the recording media has been set to [microSD card]).

Trimming a file [Trimming]

A file can be trimmed down to just the required portion and then re-saved.

NOTE

- Only PCM-format file recorded on the voice recorder can be trimmed.

- 1** Before performing the file trimming operation, first select the file you want to trim (☞ P.33).
- 2** Press the **MENU/SCENE** button while the voice recorder is in stop mode.
- 3** Press the **▶OK** button to move the cursor into the list of setting items.
- 4** Press the **+** or **-** button to select [Trimming].
- 5** Press the **▶OK** button.
- 6** Press the **▶OK** button to play the file to the desired trimming point (☞ P.58).
 - You can change the playback speed (☞ P.66), and fast-forward/rewind (☞ P.60).

- 7** Press the **F2** button at the position where you want to start trimming.

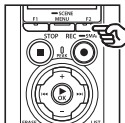

TIP

- Playback continues while [Start] position is set and as with usual playback, changing the playback speed and fast-forward/rewind can be performed and you can quickly advance to the [End] position.
- When the end of the file is reached while the [End] position is not set, that position becomes the end position of trimming.
- Writing an index mark/temp mark at the start point and end point beforehand is handy (☞ P.70).

- 8** Press the **F2** button again at the position where you want to end trimming.

- 9** Press the **+** button to select [Start].

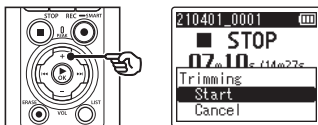

- 10** Press the **▶OK** button.

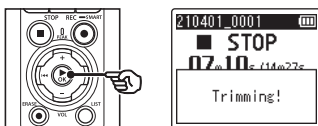

- [Trimming!] appears in the display, and the file trimming process starts. [Trimming completed] appears when the process has finished.

- 11** Press the **STOP** (■) button to exit the menu screen.

NOTE

- If a file has an extremely short recording time, it may not be trimmed even if it is a PCM file.
- Locked files and read-only files cannot be trimmed (refer P.80).
- Before trimming a file, charge or replace the batteries to ensure they will not run out before the process has finished. Trimming processes can take over 10 seconds to complete. To prevent the risk of damage to data, never attempt to perform any of the following processes before a trimming process has finished:
 - Disconnecting the AC adapter
 - Removing the batteries
 - Removing the microSD card (if the recording media has been set to [microSD card]).

Fading in/out audio at the beginning/end of a file [Fade in/out]

You can apply fade in/out effect to the beginning/end of a file for approximately 1 second respectively and save the file as another file.

NOTE

- Only PCM format files recorded with this recorder can be faded in/out.

- 1 Select a file you want to apply fade in/out effect to (see P.33).
- 2 Press the **MENU/SCENE** button while the voice recorder is in stop mode.
- 3 Press the **▶OK** button to move the cursor into the list of setting items.
- 4 Press the **+** or **-** button to select [Fade in/out].
- 5 Press the **▶OK** button.
- 6 Press the **+** button to select [Start].

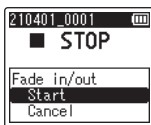
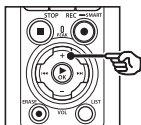

- 7 Press the **▶OK** button.

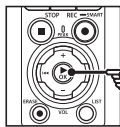

- [Fading in/out!] is displayed on the screen, and the audio is faded in and out. The process is finished when [Faded in/out] is displayed.
- 8 Press the **STOP (■)** button to exit the menu screen.

TIP

- The file is given the name "File name_1" after fade in/out effect is applied.
- If the current folder contains 200 files, a new folder will be created to hold the additional files.

Starting Recording at a Set Time [Timer Rec]

Start and end recording at specified times.

NOTE

- Before proceeding, check that the recorder's clock is set to the correct time and date. If it is not, set the clock using [Time & Date] (☞ P.101).
- Timed recording is performed according to the settings currently chosen on the recorder. Any changes must be made before recording begins. Recording time and power consumption vary with the settings chosen (☞ P.84).
- Check the battery level and charge the batteries or insert fresh batteries as needed (☞ P.12, P.13, P.20).
- Check the amount of memory available and insert a new microSD card or delete files to free up additional space as needed (☞ P.22, P.74).

4

Menu

Choosing Start and End Times

- 1 Press the **MENU/SCENE** button while the voice recorder is in stop mode.
- 2 Press the **+** or **-** button to select the [Rec Menu] tab.
- 3 Press the **▶OK** button to move the cursor into the list of setting items.
- 4 Press the **+** or **-** button to select [Timer Rec].

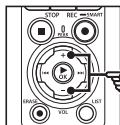

- 5 Press the **▶OK** button.
- 6 Press the **+** or **-** button to select [Time].

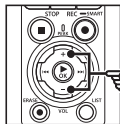

- 7 Press the **▶OK** button.

- 8** Press the **▶▶** or **◀◀** button to select the desired setting item.

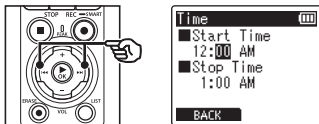

- 9** Edit the selected item using the **+** or **-** button.

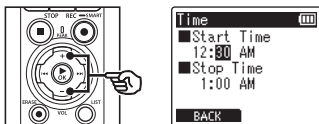

- Use the **▶▶** or **◀◀** button to highlight additional items and press the **+** or **-** button to edit.

NOTE

- Timed recording may start a few seconds after the selected starting time.

- 10** Press the **▶OK** button to save the start and end times.
- 11** Press the **STOP** (■) button to exit the menu screen.

Starting Timed Recording

- 1** Press the **MENU/SCENE** button while the voice recorder is in stop mode.
- 2** Press the **+** or **-** button to select the [Rec Menu] tab.
- 3** Press the **▶OK** button to move the cursor into the list of setting items.
- 4** Press the **+** or **-** button to select [Timer Rec].
- 5** Press the **▶OK** button.
- 6** Press the **+** or **-** button to select [On/Off].

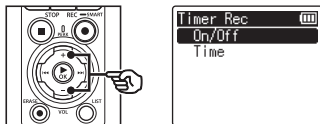

- 7** Press the **▶OK** button.
- 8** Press the **+** or **-** button to select [On].

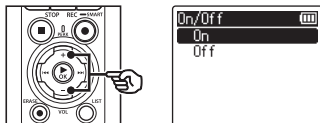

- 9** Press the **STOP** (■) button to exit the menu screen.

NOTE

- [Timer Rec] > [On/Off] reverts to [Off] when timed recording ends.
- Timed recording will not start if the recorder is in use or recording is in progress at the starting time selected for [Timer Rec].

TIP

- Timed recording will start if the recorder is off or in HOLD mode at the time selected for [Timer Rec].

Choosing a Recording Method [Fn Rec]

A variety of recording options can be assigned to the **F2** button for quick recall.

NOTE

- Before using [Pre-Recording], select an option other than [FLAC] for [Rec Mode] (☞ P.85).

- 1 During recording or while the voice recorder is in stop mode, press the **MENU/SCENE** button.
- 2 Press the **+ or -** button to select the [Rec Menu] tab.
- 3 Press the **▶OK** button to move the cursor into the list of setting items.
- 4 Press the **+ or -** button to select [Fn Rec].

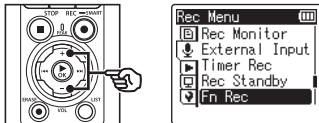

- 5 Press the **▶OK** button.

- 6 Press the **+ or -** button to select the option you plan to assign to the **F2** button.

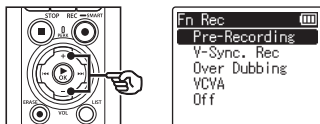

[Pre-Recording]:

Recording starts approximately two seconds before the **REC** (●) button is pressed (☞ P.123).

[V-Sync. Rec]:

Recording starts automatically when the recorder detects sounds above a certain volume and stops automatically when the volume drops (☞ P.89).

[Over Dubbing]:

Overdub a recording while playback is in progress (☞ P.125).

[VCVA]:

Recording starts automatically when the recorder detects sounds above a certain volume and pauses automatically when the volume drops (☞ P.91).

[Off]:

The **F2** button is not assigned a recording function.

- 7 Press the **▶OK** button.
- 8 Press the **STOP** (■) button to exit the menu screen.

NOTE

- Assigning a recording function to the **F2** button using **[Fn Rec]** selects **[Off]** for **[Slate Tone]**.
- Selecting **[Pre-Recording]**, **[V-Sync. Rec]**, or **[VCVA]** for **[Fn Rec]** selects **[Off]** for **[Voice Detect]** > **[While Recording]** (☞ P.105).
- Selecting **[Pre-Recording]** or **[Over Dubbing]** for **[Fn Rec]** selects **[Off]** for **[Rec Scene]** (☞ P.47).

TIP

- The following is required for using the **[Over Dubbing]** function.
- Select a file recorded in the **[PCM 44.1kHz/16bit]** or **[PCM 44.1kHz mono]** (.wav) format for overdubbing (☞ P.33, P.58).
- Set **[PCM 44.1kHz/16bit]** or **[PCM 44.1kHz mono]** for **[Rec Mode]** beforehand (☞ P.85).

Starting Recording Before You Press Record [Pre-Recording]

With pre-recording, recording starts approximately two seconds before you press the **REC** (●) button. If, for example, you were recording bird song and pressed the **REC** (●) button the moment you heard the first note, the recording would actually begin slightly before the bird started singing.

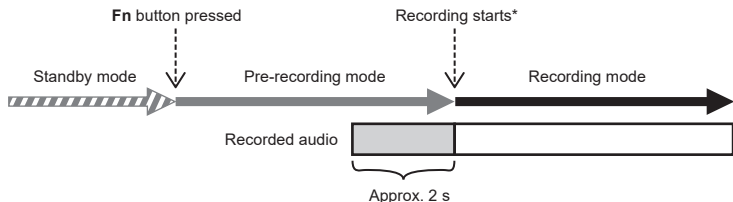

* The recorded audio may include the click made when the **REC** (●) button is pressed to start recording. This can be prevented by starting recording remotely via the "DVR Remote" smartphone app (see P.142).

NOTE

- Before using [Pre-Recording], select an option other than [FLAC] for [Rec Mode] (see P.85).

1 Select [Pre-Recording] for [Fn Rec] (see P.121).

2 Press the ►► or ◀◀ button in the [Home] screen and select [Recorder] (see P.28).

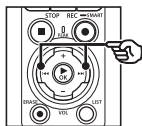

3 Press the ►OK button.

4 Press the + or - button to select the folder to save the recording in.

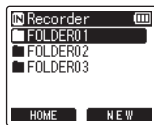
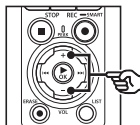

- Each new voice recording file is saved in the selected folder.

5 Press the ►► button twice to select file view.

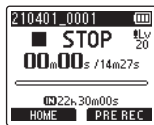
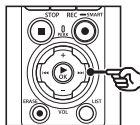

- 6** Press the **F2 (PRE REC)** button to activate pre-recording.

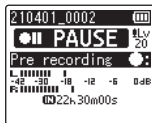
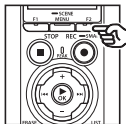

- Recordings made while pre-recording is active will begin approximately two seconds before the **REC (●)** button is pressed (Step 7).

- 7** Press the **REC (●)** button to start recording.

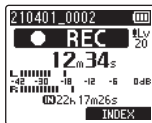
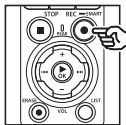

- 8** Press the **STOP (■)** button to stop recording.

NOTE

- The recording time shown after recording starts includes the time for the pre-recorded portion.

Using Overdubbing [Over Dubbing]

You can overdub a file while listening to its playback sound. The overdubbed file is saved with a different name. This function is useful for composing music or practicing musical instruments.

1 Select [Over Dubbing] for [Fn Rec] (☞ P.121).

2 Connect the earphones to the voice recorder's earphone jack (📎).

- The playback sound is output from the earphones.

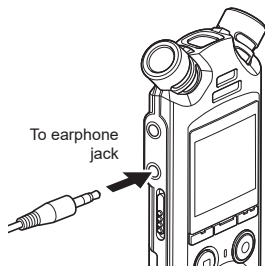

3 Select a file to be overdubbed (☞ P.33).

4 Press the **F2 (OVER DUB)** button in stop mode.

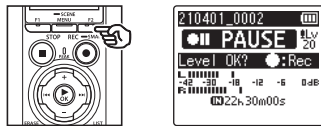

5 Press the **▶▶** or **◀◀** button to adjust the recording level.

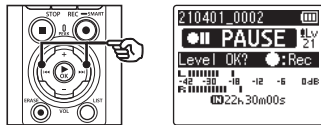

6 Press the **REC (●)** button.

- Playback starts from the beginning of the file simultaneously with start of overdubbing.

7 Press the **STOP (■)** button when you want to stop recording.

- Overdubbing is ended when the playback is finished.

Recording a Reference Tone for Use When Synchronizing Audio and Video [Slate Tone]

Reference tones, otherwise known as “slate tones”, can be recorded for use during editing to help synchronize audio and video when audio from the voice recorder is substituted for sound recorded by the camera (P.128).

Selecting [On] for [Slate Tone]

- 1 Press the **MENU/SCENE** button while the voice recorder is in stop mode.
- 2 Press the **+** or **-** button to select the [Rec Menu] tab.
- 3 Press the **▶OK** button to move the cursor into the list of setting items.
- 4 Press the **+** or **-** button to select [Slate Tone].

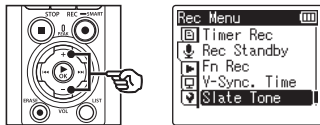

- 5 Press the **▶OK** button.

- 6 Press the **+** or **-** button to select [On].

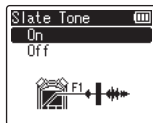
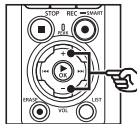

- 7 Press the **▶OK** button to finalize the setting.
- 8 Press the **STOP** (■) button to exit the menu screen.

NOTE

- Selecting [On] for [Slate Tone] selects [Off] for [Fn Rec].
- Sound will not be output to **Bluetooth®** earphones if a 24-bit [PCM] or [FLAC] option is selected for [Rec Menu] > [Rec Mode]. Choose a non-24-bit option (P.85).

Shooting Videos with a Slate Tone

- 1 Connect the camera audio input jack to the earphone jack (🔊) on the voice recorder (📖 P.63).

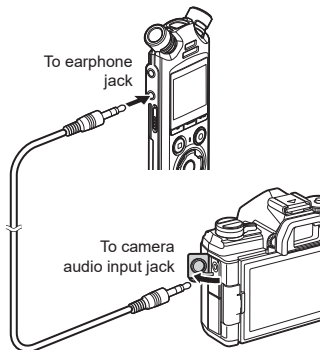

[Rec Standby] is [On]:

📖 Go to Step 2

[Rec Standby] is [Off]:

📖 Go to Step 4

- 2 Press the **REC** (●) button to prepare for recording.

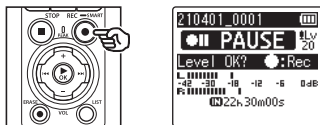

- 3 Press the **▶▶** or **◀◀** button to adjust the recording level.

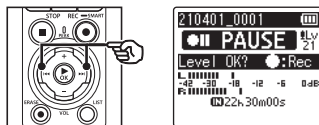

- 4 Press the **REC** (●) button to start recording.

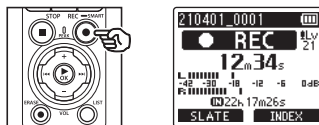

- During recording, the recording indicator light (LED) turns on and [● REC] appears in the display.
 - Press the **▶▶** or **◀◀** button to adjust the recording level.
- 5 **Start filming on the camera.**
 - For information on filming videos, see the user's manual provided with the camera.

- 6 Press the F1 (SLATE) button on the voice recorder.**
- A beep (slate tone) will be recorded.

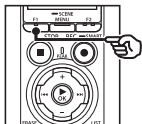

- 8 Press the STOP (■) button when you want to stop recording.**

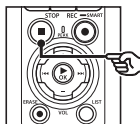

- 7 End filming on the camera.**

NOTE

- The slate tone is recorded to both the video and audio files.
- The slate tone is not output on the voice recorder or the camera's built-in speaker during filming.

TIP

- Having the slate tone waveform available as a marker will help you synchronize the audio and video when using OM Workspace to replace the audio originally recorded with the video with the sound file from the voice recorder. For information on downloading OM Workspace, visit our website. Third-party editing software can also be used. For more information, see the user's manual provided with the editing software.

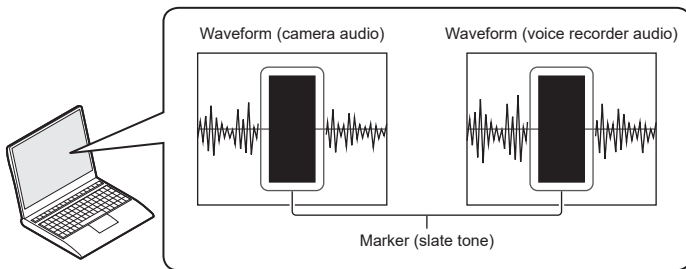

Adjusting Sound Level for Output to the Camera [Test Tone]

Using a test tone to match output volume to the optimal camera recording level before beginning recording helps prevent crackling and distortion.

- 1 Connect the camera audio input jack to the earphone jack (📶) on the voice recorder (see P.63).

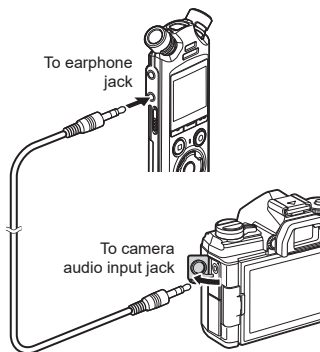

- 2 Press the **MENU/SCENE** button while the voice recorder is in stop mode.
- 3 Press the **+** or **-** button to select the [Rec Menu] tab.

- 4 Press the **▶OK** button to move the cursor into the list of setting items.
- 5 Press the **+** or **-** button to select [Test Tone].

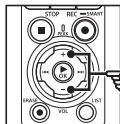

- 6 Press the **▶OK** button.
- 7 Press the **▶OK** button again to sound a test tone.

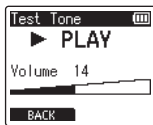
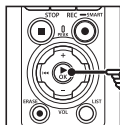

- 8** Adjust the volume using the **+** or **-** button.

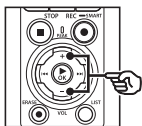

- The volume can be adjusted to a setting between [00] to [30]. The higher the number, the louder the volume.
- If the volume is set too loud, a warning screen may appear.

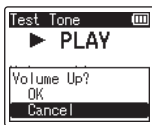

- 9** Press the **STOP** (■) button to stop the test tone.

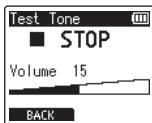
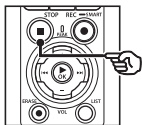

- 10** Press the **F1 (BACK)** button to return to the menus.

- 11** Press the **STOP** (■) button to exit the menu screen.

- Press and hold the **STOP** (■) button when the voice recorder is stopped to check setting indicators meanings.

NOTE

- Changes to test tone volume also apply to voice recorder playback volume (☞ P.58).
- The test tone is not output on the voice recorder or the camera's built-in speaker.

TIP

- Noise can be minimized by setting the voice recorder to maximum volume and adjusting the recording level on the camera.
- Test tones can also be output to **Bluetooth®** compatible audio devices (☞ P.137).

Setting the USB connection [USB Settings]

Choose USB settings for tasks such as downloading files or charging the batteries.

USB Connection Settings

Choose whether the recorder uses a pre-selected download or charging option or instead prompts you to choose USB settings whenever a device is connected.

- 1 Press the **MENU/SCENE** button while the voice recorder is in stop mode.
- 2 Press the **+** or **-** button to select the [Device Menu] tab.
- 3 Press the **▶OK** button to move the cursor into the list of setting items.
- 4 Press the **+** or **-** button to select [USB Settings].
- 5 Press the **▶OK** button.
- 6 Press the **+** or **-** button to select [USB Connection].

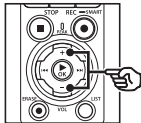

- 7 Press the **▶OK** button.
- 8 Press the **+** or **-** button to select a setting.

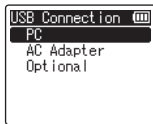
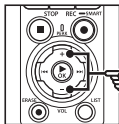

[PC]:

Choose this option when connecting the recorder to a computer via a USB cable. The voice recorder will be connected as a storage or composite device.

[AC Adapter]:

Choose this option when charging the batteries using a computer or optional F-5AC AC adapter. Files cannot be transferred.

[Optional]:

Select to confirm the connection method whenever making a USB connection.

- 9 Press the **▶OK** button.
- 10 Press the **STOP (■)** button to exit the menu screen.

USB Class

Before connecting the recorder to a computer, choose a USB class according to the task to be performed.

- 1 Press the **MENU/SCENE** button while the voice recorder is in stop mode.
- 2 Press the **+ or -** button to select the [Device Menu] tab.
- 3 Press the **▶OK** button to move the cursor into the list of setting items.
- 4 Press the **+ or -** button to select [USB Settings].
- 5 Press the **▶OK** button.
- 6 Press the **+ or -** button to select [USB Class].
- 7 Press the **▶OK** button.
- 8 Press the **+ or -** button to select a setting.

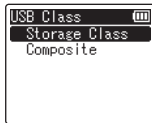
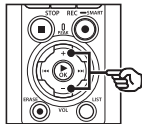

[Storage Class]:

Select to have the voice recorder recognized as an external memory device by a connected computer.

[Composite]:

Select to have the voice recorder recognized as an external memory device by a connected computer, and to use the voice recorder as a USB speaker/microphone.

TIP

- If the computer fails to identify the recorder as an external drive, select [Storage Class] for [USB Class].
- To charge the batteries from a computer when [Composite] is selected, first choose [Optional] for [USB Connection], and then select [AC adapter] in response to the prompt displayed when the USB cable is connected (see P.131).

- 9 Press the **▶OK** button.
- 10 Press the **STOP (■)** button to exit the menu screen.

Formatting recording media [Format]

Formatting a recording media erases all existing files saved on it. Be sure to transfer all important files to a computer before formatting.

1 Press the **MENU/SCENE** button while the voice recorder is in stop mode.

2 Press the **+ or -** button to select the [Device Menu] tab.

3 Press the **▶OK** button to move the cursor into the list of setting items.

4 Press the **+ or -** button to select [Format].

5 Press the **▶OK** button.

6 Press the **+ or -** button to select the recording media to be formatted.

7 Press the **▶OK** button.

8 Press the **+ or -** button to select [Start].

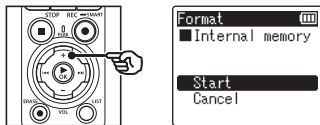

9 Press the **▶OK** button.

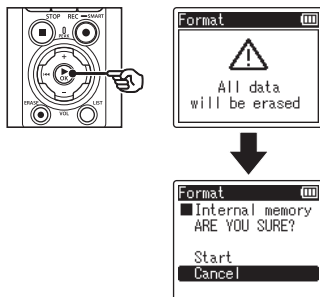

10 Press the **+ or -** button to select [Start] again.

11 Press the **▶OK** button.

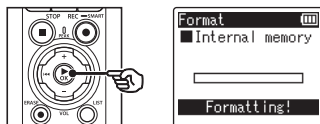

- **[Formatting!]** appears, and formatting starts.
- **[Format done]** appears when the process has finished.

TIP

- To reset all the voice recorder's settings to their default values, use the **[Reset Settings]** operation (☞ P.102).

NOTE

- Never format the voice recorder from a computer.
- Formatting erases all the existing data, including locked files and read-only files.
- If there is a microSD card in the voice recorder, make sure [**Internal memory**] or [**microSD card**] has been correctly selected as the recording media to erase (☞ P.100).
- Before formatting, charge or replace the batteries to ensure they will not run out before the process has finished. The formatting process can sometimes take over 10 seconds to complete. To prevent the risk of damage to data, never attempt to perform any of the following processes before a formatting process has finished:
 - Disconnecting the USB-connection AC adapter
 - Removing the batteries
 - Removing the microSD card (if the recording media has been set to [**microSD card**])
- Even when formatting or erasing (☞ P.74) is performed, only the file management information of the internal memory and/or microSD card is updated and the recorded data is not completely erased. When disposing of a microSD card, be sure to destroy the card, format the card and record silence until the recording time runs out, or perform a similar operation in order to prevent the leakage of personal information.

Bluetooth® function

Before using the Bluetooth® function

This function is compatible with **Bluetooth®** and allows you to connect the voice recorder to a device that is compatible with the same standard.

If you use **Bluetooth®** compatible earphones, you can use the voice recorder freely within the range that a signal can be received without a troublesome cable connected.

Radio signals extend a certain range and can penetrate obstacles (wood, glass, etc.), thus even if the voice recorder is placed another room, connection is possible.

Furthermore, if you use a special application on your smartphone, you can operate (record/stop) the voice recorder at a distance as long as you are within the range that a signal can be received. For details, see our website.

What can you do with the Bluetooth® function?

- Connecting to **Bluetooth®** Compatible Audio Devices
- Controlling the Recorder Using the Dedicated Smartphone App (P.142)
- Connecting Simultaneously to Smartphones and Audio Devices
- Automatically Connecting to the Last Device Used



Voice recorder



Smartphone

NOTE

- This voice recorder is equipped with **Bluetooth®**. Use of these features in countries outside the region of purchase may violate local wireless regulations. Do not use the **Bluetooth®** function of the device in regions other than those mentioned above. Also do not use the **Bluetooth®** function in other than the country or region of purchase. Using the function could violate the radio signal restrictions in that country. We will assume no responsibility whatsoever for the use of this technology.
- Communication may be affected if there is reinforced structures, metal or concrete between the voice recorder and smartphone.
- Do not use the **Bluetooth®** function of the voice recorder in a hospital and airplane where its use is prohibited.

- Near a microwave, cordless telephone set, or device that uses the 2.4GHz frequency band, if the voice recorder is used at the same time with such a device, communication performance may be affected. When using the voice recorder, keep a sufficient distance away from such devices.
- To the extent possible, try not to use the voice recorder near mobile phones, televisions, or radios.
 - Mobile phones, PHS, TV sets, and radios use different frequencies than the voice recorder but electromagnetic waves generated from **Bluetooth®** devices including this voice recorder could generate noise in audio or video images.
- When using the **Bluetooth®** function, battery life is consumed quickly. Therefore, when using a **Bluetooth®** connection we recommend using a separately sold AC adapter.
- The voice recorder does not guarantee connection or operation with all **Bluetooth®** compatible devices.
- We will assume no responsibility for any loss of data resulting from the use of the **Bluetooth®** function.

Notes on security when using Bluetooth® devices

- With a **Bluetooth®** connection, information is exchanged wirelessly between a smartphone and the voice recorder and as long as radio signals reach the unit, flexible connection is possible. However, because radio signals can penetrate through obstacles (wood, glass, etc.), if there is no security-related setting, the following problems could occur.
 - A malicious third party intentionally intercepts radio signals to spy on communication content.
 - Unauthorized intrusion causes the leaking of personal information.
 - Intercepted communication contents are rewritten and transmitted.
 - Destructive computer viruses are released that can destroy data or systems.
- When you are not using the **Bluetooth®** function, disconnect the connection.
- Should a problem occur for an inevitable reason due to the specifications of the **Bluetooth®** connection, we assume no responsibility whatsoever for any damage incurred.

Connecting/disconnecting a Bluetooth® device

Connecting a Bluetooth® device

This function is compatible with **Bluetooth®** and allows you to connect the voice recorder to a device that is compatible with the same standard. A wireless connection enables you to use earphones and other compatible devices freely within a certain range.

NOTE

- Check that there is sufficient battery life. Replace or charge the batteries if needed (☞ P.12, P.16).
- Check that the **Bluetooth®** indicator is off (☞ P.7).
- Turn on the power of the device to be connected and check that there is sufficient battery power.
- Place the voice recorder and device to be connected within 1 m of each other.

TIP

- There are the following two ways to connect a **Bluetooth®** device.

[Pairing]:

Use this method when connecting a device that is to be used for the first time or when the connection settings have been deleted.

[Connection] (☞ P.144):

Use this option when reconnecting to paired devices after the connection is lost or to connect to a device other than the one to which the recorder connected automatically.

Connecting using [Pairing]

The initial connection between two **Bluetooth®** devices is established through a process called “pairing”. Once the devices are paired, the recorder will automatically re-establish a connection to the most recently connected smartphone when [On] is selected for [Bluetooth] > [On/Off] (☞ P.145).

- 1 Switch to pairing mode on the device to be connected.**
 - For details on pairing mode, see the user's manual of the device to be used.
- 2 Press the MENU/SCENE button while the voice recorder is in stop mode.**
- 3 Press the + or – button to select [Device Menu] tab.**
- 4 Press the ►OK button to move the cursor into the list of setting items.**
- 5 Press the ►OK button.**
- 6 Press the + or – button to select [Audio Device].**
- 7 Press the ►OK button.**

- 8** Press the **+** or **-** button to select **[Pairing]**.



- 9** Press the **▶OK** button.

- A search is performed for **Bluetooth®** devices that can be connected.
- It may take a while for the device to be connected to appear.

- 10** Press the **+** or **-** button to select the device to be connected.

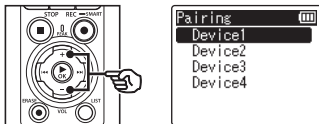

- 11** Press the **▶OK** button.

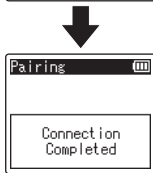
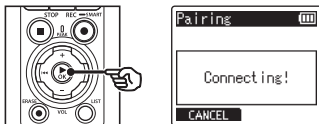

- **[Connecting!]** appears in the display, and the connecting process starts. **[Connection Completed]** appears when the process has finished.

- 12** Press the **STOP (■)** button to exit the menu screen.

■ About pairing

Pairing will need to be performed again in the following cases.

- When the information for pairing with the voice recorder has been deleted on the **Bluetooth®** compatible device to be connected.
- When **[Reset Settings]** item of the voice recorder was executed to restore the factory default settings (P.102).
- When the pairing information was deleted by a means other than the above.

Connecting using [Connection]

Performing operations such as turning the recorder off after it has been paired with a **Bluetooth®** compatible device ends the **Bluetooth®** connection. Select **[Connection]** to reconnect. **[Connection]** can also be used to connect to a device other than the one to which the recorder connected automatically.

1 Ready the Bluetooth® compatible device for pairing.

- For details on pairing mode, see the user's manual of the device to be used.
- If the recorder is currently connected to a device other than that to which you want to connect, end the connection before proceeding (see P.141).

2 Press the **MENU/SCENE** button while the voice recorder is in stop mode.

3 Press the **+** or **-** button to select **[Device Menu]** tab.

4 Press the **▶OK** button to move the cursor into the list of setting items.

5 Press the **▶OK** button.

6 Press the **+** or **-** button to select **[Audio Device]**.

7 Press the **▶OK** button.

8 Press the **+** or **-** button to select **[Connection]**.

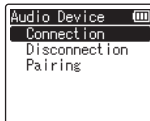
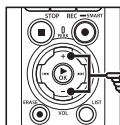

9 Press the **▶OK** button.

- The name of the **Bluetooth®** device connected with the voice recorder up until now is displayed in the list.

10 Press the **+** or **-** button to select the device to be connected.

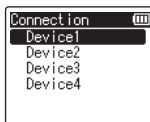
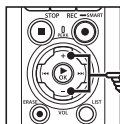

- Press the **▶▶I** button to confirm the name and address of the selected **Bluetooth®** device. Press the **◀◀I** button to return to the previous screen.

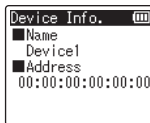
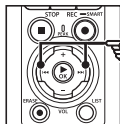

11 Press the ►OK button.

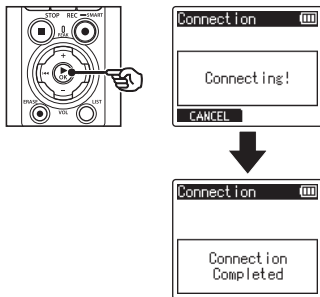

- [Connecting!] appears in the display, and the connecting process starts. [Connection Completed] appears when the process has finished.

12 Press the STOP (■) button to exit the menu screen.

NOTE

- Recording, playback, and other operations are not possible during the pairing process.
- Only one **Bluetooth®** device can be connected by performing pairing setting once. Multiple devices cannot be paired simultaneously. Configure the connection settings separately for each device.
- The recorder can connect with only one audio device at a time. It can connect with both an audio device and a smartphone at the same time (P.136).
- If communication become unstable after the connecting is completed, the voice recorder may enter the connection wait state.
- If the **Bluetooth®** connection wait state is entered while playback is in progress, the playback operation is interrupted. Check the status of the voice recorder while playback is in progress.
- If **Bluetooth®** is disconnected while playback is in progress, the playback operation stops.

Disconnecting the connection with a Bluetooth® device

Disconnecting the connection using [Disconnection]

- 1 Press the **MENU/SCENE** button while the voice recorder is in stop mode.
- 2 Press the **+** or **-** button to select [Device Menu] tab.
- 3 Press the **▶OK** button to move the cursor into the list of setting items.
- 4 Press the **▶OK** button.
- 5 Press the **+** or **-** button to select [Audio Device].
- 6 Press the **▶OK** button.
- 7 Press the **+** or **-** button to select [Disconnection].

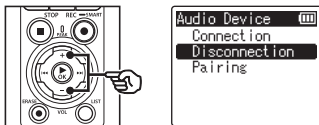

- 8 Press the **▶OK** button.

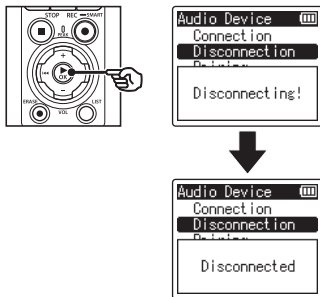

- [Disconnection!] appears in the display, and the disconnecting process starts. [Disconnected] appears when the process has finished.

- 9 Press the **STOP** (■) button to exit the menu screen.

Connecting to Smartphones via Bluetooth®

About DVR.Remote



The DVR.Remote application for smartphones is required to use your smartphone to operate the voice recorder from a distance.

What the application can do

With the application installed on your smartphone, you can remotely:

- Start and end recording.
- Start and end playback.
- Adjust recording settings.
- Add index marks.

For more information, visit our website.

TIP

- The recorder can connect to smartphones and audio devices simultaneously. You can control the recorder from a smartphone while listening to recordings on **Bluetooth®** earphones.

NOTE

- When you download the application using a mobile phone line such as 4G, depending on your particular contract, you may incur packet communication fees.

Connecting to Smartphones via [Pairing]

The initial connection between two **Bluetooth®** devices is established through a process called “pairing”. Once the devices are paired, the recorder will automatically re-establish a connection to the most recently connected smartphone when [On] is selected for [Bluetooth] > [On/Off] (P.145).

Configuring the Recorder

- 1 Press the MENU/SCENE button while the voice recorder is in stop mode.**
- 2 Press the + or – button to select the [Device Menu] tab.**
- 3 Press the ►OK button to move the cursor into the list of setting items.**
- 4 Press the ►OK button.**
- 5 Press the + or – button to select [Smartphone App].**

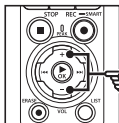

6 Press the ►OK button.

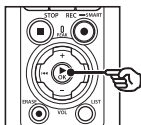

7 Press the ►OK button.

- The recorder will display the network name and passcode the smartphone app will need to establish the connection.

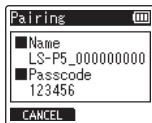
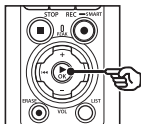

Configuring the Smartphone

8 Search for devices and select the network name displayed by the recorder in Step 7.

9 Enter the passcode.

- The devices will be paired.

TIP

- For information on searching for networks and entering the passcode, see the user manual for your smartphone.

■ About pairing

Pairing will need to be performed again in the following cases.

- When the information for pairing with the voice recorder has been deleted on the smartphone to be connected.
- When the pairing information was deleted by a means other than the above.

Enabling or Disabling Bluetooth®

Enabling Bluetooth® and Connecting Automatically to Paired Devices

Enabling Bluetooth®

To enable **Bluetooth®** and allow the recorder to connect automatically to the last-used smartphone or other device, select **[On]** for **[Bluetooth]** > **[On/Off]**.

- 1 Press the **MENU/SCENE** button while the voice recorder is in stop mode.
- 2 Press the **+** or **-** button to select the **[Device Menu]** tab.
- 3 Press the **▶OK** button to move the cursor into the list of setting items.
- 4 Press the **▶OK** button.
- 5 Press the **+** or **-** button to select **[On/Off]**.
- 6 Press the **▶OK** button.
- 7 Press the **+** or **-** button to select **[On]**.
- 8 Press the **▶OK** button.
- 9 Press the **STOP (■)** button to exit the menu screen.

Disabling Bluetooth®

To prevent the recorder connecting to **Bluetooth®** devices automatically, select **[Off]** for **[Bluetooth]** > **[On/Off]**.

Use with a computer

When connecting the voice recorder to a computer you can do the following:

- You can enjoy MP3 or linear PCM (WAV) format files saved on your computer, or FLAC format music files downloaded from high-resolution distribution site.
- Use the voice recorder as external storage to save or load data to/from your computer (P.32).
- The recorder firmware can be updated via firmware updates downloaded to the computer.

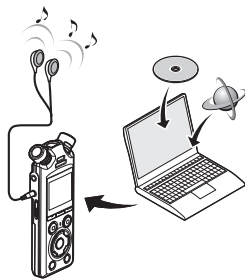

- The earphones are optional

Computer connection precautions

- When uploading or downloading a file to or from the voice recorder, data transfer will continue as long as the voice recorder's LED indicator light is flashing, even if the computer data communication screen disappears. Never disconnect the USB cable before data communication has finished. Always use the procedure on P.147 to disconnect the USB cable. Data may not be transferred correctly if you disconnect the connector before the drive has stopped.
- Do not format (initialize) the voice recorder's drive from a computer. Formatting done from a computer will not be done correctly. Use the voice recorder's **[Format]** menu for formatting (P.133).
- Voice recorder folders or files that are moved or renamed in a computer file management screen may be reordered or become unrecognizable.
- Note that it will still be possible to read and write data on the voice recorder after setting the attribute of the voice recorder's drive to 'Read only' on a computer.
- To prevent nearby electronic devices being affected by noise, disconnect the external microphone and earphones when connecting the voice recorder to a computer.

Computer connection/disconnection

Connecting the voice recorder to a computer

- 1 Start the computer.
- 2 After confirming that the recorder is stopped or off, connect it to the computer using the USB cable.

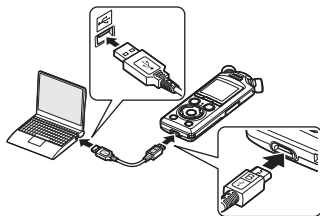

- **[Remote (Storage)]** appears in the recorder display when the recorder is connected to a computer via USB.
- Files cannot be transferred when **[AC adapter]** is selected for **[USB Connection]** in the **[USB Settings]** menu. Select **[PC]** for **[USB Connection]** (☞ P.131).

TIP

- For information on the computer's USB port, see the computer's user manual.

NOTE

- Insert the USB connector securely all the way. Operation will not be normal if the connection is not made properly.
- Connecting the voice recorder through a USB hub may result in unstable operation. Do not use a USB hub if operation is unstable.
- Use the supplied USB cable only. Never use a third-party cable, as this could damage the product. The supplied cable should similarly never be used for connections between third-party devices.

Disconnecting the voice recorder from a computer

After checking the recorder to confirm that the LED indicator light is not flashing, disconnect the USB cable from the recorder and computer.

TIP

- You can disconnect the USB cable and use the voice recorder before the batteries are fully charged.

NOTE

- Never disconnect the USB cable while the LED indicator light is flashing. Failure to observe this precaution could result in data corruption.

Other information

Alarm message list

Message	Meaning	Action required
Battery low	The remaining battery power is low.	Replace or charge the batteries (☞ P.12, P.16).
File locked	An attempt was made to erase a locked file.	You must unlock the file before you can erase it (☞ P.80).
Further marking not possible	The maximum number of index marks (99) have been written in the file.	Erase unneeded index marks (☞ P.71).
	The maximum number of temp marks (99) have been written in the file.	Erase unneeded temp marks (☞ P.71).
Recorder Folder Full	The maximum number of files (200) have been saved in the folder.	Erase unneeded files (☞ P.74).
Memory error	An internal memory error occurred.	Contact the Customer Support Center.
Card error	The microSD card was not recognized correctly.	Remove and reinsert the microSD card (☞ P.22, P.24).
Memory full	There is no remaining memory.	Erase unneeded files (☞ P.74).
No file	There are no files in the folder.	Select another folder (☞ P.33).
Format error	A formatting problem occurred.	Format the memory again (☞ P.133).
Can't create the system file. Connect to PC and erase unnecessary file	The voice recorder is unable to create a management file due to low remaining memory.	Connect the voice recorder to a computer and erase unneeded files.
Cannot play this file	The file's format is not supported.	Select a file that can be played by the voice recorder (☞ P.65).
Select a file	No file has been selected.	You must select a file before you can perform the operation (☞ P.33).

Alarm message list

Message	Meaning	Action required
Same folder Can't move (copy)	An attempt was made to move (copy) a file to the same folder.	Select another folder.
Some files can't be moved (copied)	A file with the same name as a file being moved (copied) exists in the destination folder.	Select another file.
This file can't be divided.	An attempt was made to divide a file that is not an MP3- or WAV-format file recorded by the voice recorder.	Select another file.
Partial erase not possible	An attempt was made to erase a file that is not a WAV-format file recorded by the voice recorder.	Select another file.

Troubleshooting

Problem	Possible cause	Solution
The display is blank.	The batteries are not inserted properly.	Check that the positive and negative terminals of the batteries are placed correctly (☞ P.12).
	The remaining battery power is low.	Replace or charge the batteries (☞ P.12, P.16).
	The power is OFF.	Turn the power ON (☞ P.26).
Unable to operate the voice recorder	The remaining battery power is low.	Replace or charge the batteries (☞ P.12, P.16).
	The power is OFF.	Turn the power ON (☞ P.26).
	The voice recorder is in HOLD mode.	Release HOLD mode (☞ P.27).
Unable to record	There is no remaining memory.	Erase unneeded files (☞ P.74).
	The maximum number of recordable files has been reached.	Select another folder (☞ P.33).
Playback is inaudible.	The earphones are connected to the earphone jack.	To output the playback through the built-in speaker, disconnect the earphones.
	The recorder is connected to an audio device via Bluetooth ®.	To play audio over the built-in speaker, end the Bluetooth ® connection (☞ P.141).
	[Off] has been selected for [Speaker].	To output the playback through the built-in speaker, select [On] for [Speaker] (☞ P.99).
	The volume is set to [00].	Adjust the volume (☞ P.58).
The recording is too quiet.	A low recording level has been set.	Redo recording after setting the recording level to [High] or [Middle] (☞ P.84).
	The output level of the connected external device may be too low.	Adjust the output level of the external device.
	The recording level hasn't been adjusted.	Redo recording after adjusting the recording level (☞ P.84).

Problem	Possible cause	Solution
Audio file sound is distorted.	The recording level hasn't been adjusted.	Redo recording after adjusting the recording level (☞ P.84).
	The voice recorder's recording level, or the output level of the connected external device may be too high.	If the problem continues after adjusting the voice recorder's recording level (☞ P.84), adjust the output level of the external device.
An audio file is not recorded in stereo.	The connected external microphone is a mono microphone.	Sound recorded by a connected external mono microphone is recorded on the left channel only.
	[Rec Mode] is set to a mono recording format.	Set [Rec Mode] to a stereo recording format (☞ P.85).
	A positive (+) value has been selected for [Zoom Mic].	Select [Off] for [Zoom Mic] (☞ P.86).
Missing audio file	The file was recorded in a different folder.	Select another folder (☞ P.33).
A music file cannot be found in the destination folder to which it was copied.	The music file was in second-level sub-folder of a transferred folder.	Place music files in the top level of folders for transfer (☞ P.32).
Noise during playback	Objects brushed against the voice recorder while recording.	Try your best not to touch the voice recorder during recording.
	The voice recorder was placed near a mobile phone or fluorescent light during recording or playback.	Redo the operation with the voice recorder in a different location.
Non-voice portions are not skipped during playback.	The [Voice Detect] process has not been performed.	Use the [Voice Detect] function to extract the speaking portions (☞ P.105).
	[Off] has been selected for [Voice Playback].	Select [On] for [Voice Playback] (☞ P.94).
Unable to erase a file	The file is locked.	You must unlock the file before you can erase it (☞ P.80).
	The file is a read-only file.	Unlock the file, or undo the read-only setting on a computer.

Problem	Possible cause	Solution
No sound can be heard from the earphones during recording.	[Off] is selected for [Rec Monitor].	Select [On] for [Rec Monitor] (☞ P.88).
Unable to erase a folder	The folder contains a file that the voice recorder cannot recognize.	Connect the voice recorder to a computer to erase the folder (☞ P.146).
Noise when monitoring a recording	Feedback is being caused.	Connecting a speaker with a built-in amplifier may cause feedback during recording. Using the earphones to monitor recording is recommended. Adjust the recording setup such as by moving the earphones and microphone farther apart, or ensuring the microphone is not facing the earphones.
Unable to overdub	The file to be played back is not in [PCM 44.1kHz/16bit] or [PCM 44.1kHz mono] format.	Select a file recorded in [PCM 44.1kHz/16bit] or [PCM 44.1kHz mono] format (☞ P.33, P.58).
	[PCM 44.1kHz/16bit] or [PCM 44.1kHz mono] is not set for [Rec Mode].	Set [PCM 44.1kHz/16bit] or [PCM 44.1kHz mono] for [Rec Mode]. (☞ P.85).
Unable to write index marks/temp marks	The maximum number of marks (99) has been reached.	Erase unneeded marks (☞ P.71).
	The file is locked.	Unlock the file (☞ P.80).
	The file is a read-only file.	Unlock the file, or undo the read-only setting on a computer.
Unable to charge the batteries.	[Alkaline] has been selected for [Battery].	To use the supplied rechargeable batteries, select [Ni-MH] for [Battery]. Do not use the rechargeable batteries at higher/lower temperatures than the recommended range (☞ P.20, P.100).
	The ►OK button was not pressed.	Press the ►OK button as directed in the confirmation screen shown when connecting the USB connector.
	[Composite] has been selected for [USB Class].	Select [Storage Class] for [USB Class] (☞ P.131).

Problem	Possible cause	Solution
The computer is unable to recognize the voice recorder.	[AC Adapter] has been selected for [USB Connection].	Select [PC] for [USB Connection] (☞ P.131).
Playback speed is fast (or slow).	Playback speed function is set to anything other than [x1.0 Play].	Set the playback speed function setting to [x1.0 Play] (☞ P.66).
Operation is different from usual.	The settings of functions have been changed.	Try [Reset settings]. Various functions will be restored to their initial (factory default) settings. Time clock settings and recorded files are retained (☞ P.102).
Unable to connect with a Bluetooth® device.	The Bluetooth® device to be connected is not in a connectable state.	Make the Bluetooth® device connectable and then try configuring the settings again (☞ P.137).
	The distance between the Bluetooth® device and voice recorder is too far or there is an obstruction between them.	Place the Bluetooth® device within 1 m of the voice recorder and then try configuring the settings again (☞ P.137).
	The pairing information has been deleted.	Perform pairing setting again (☞ P.137).
Recording cannot be monitored from a Bluetooth® device.	A 24-bit option is selected for [Rec Mode].	Select an option with a different bit depth (☞ P.85).

Accessories (optional)

For more information on the accessories available for this product, visit our website. Availability of accessories differs depending on the country.

Batteries

BR404/BR404J nickel-metal hydride AAA rechargeable batteries (4 pcs)

High efficiency, long-lasting rechargeable batteries.

Microphone

ME51SW stereo microphone

A compact, high-quality stereo microphone that comes with a tie clip.



ME31 compact gun microphone (unidirectional)

A directional gun microphone handy for outdoor recording of wild birds singing and other highly directional applications. The metal body provides a highly rigid body.

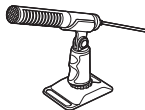

ME34 compact zoom microphone (unidirectional)

Comes with an integrated stand ideal for table placement when recording events from a distance, such as conferences or lectures.

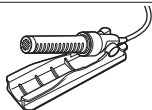

ME33 boundary microphone

A microphone for recording conferences that enables connection of up to three left- and three right-channel units.

Cascade connection enables the left/right channel connections to be extended up to about 12 meters, to capture sound from a broad range.



Accessories (optional)

AC adapter

F-5AC USB-connection AC adapter

A USB-connected AC adapter that provides 5-volt DC output. (100-240 VAC, 50/60 Hz)

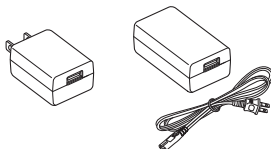

Other Accessories

KA335 connecting cord

A high-quality cable for connecting the camera to the recorder.

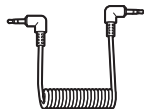

SM2 Shock Mount

An adapter that helps prevent noise being transmitted to the recorder from the camera to which it is attached. The shock mount effectively mitigates the sounds made by camera controls and the like for higher-quality recordings.



WJ2 Windshield

Reduces low-frequency wind noise.



CS131 Carrying case

The case can also be used as a cushion to mitigate noise.



NOTE

- As the main plug of AC adaptor is used to disconnect the AC adaptor from the mains, connect it to an easily accessible AC outlet.

Recorder care

● Exterior

- Wipe gently with a soft cloth when the recorder gets dirty. If the recorder is very dirty, soak the cloth in mild soapy water and wring well. Wipe the recorder with the damp cloth and then wipe it with a dry cloth.

● Display

- Wipe gently with a soft cloth.

NOTE

- Do not use benzene, alcohol or other strong solvents, or chemical cleaning cloths.

Copyright and trademark information

- The information in this document is subject to change in future without prior notice. Contact Customer Support Center for the latest product names, model numbers and other information.
- Voice recorder displays and product illustrations shown in this manual may differ from the actual product. While every precaution has been taken to ensure the accuracy of the information in this manual, errors may occasionally arise. Any questions or concerns regarding doubtful information, or possible errors or omissions should be directed to the Customer Support Center.
- OM Digital Solutions Corporation is the copyright holders of this manual. Copyright law prohibits unauthorized reproduction of this manual, or unauthorized distribution of reproductions thereof.
- Note that we will not be held liable in the event of damages, lost earnings, or any claims from third parties resulting from improper use of the product.

Trademarks and registered trademarks

- IBM and PC/AT are trademarks or registered trademarks of International Business Machines Corporation.
- microSD, microSDHC and microSDXC are trademarks of the SD Card Association.
- The product uses voice activity detection technology licensed from NTT Electronics Corporation.
- The **Bluetooth**[®] word mark and logos are registered trademarks owned by Bluetooth SIG, Inc. and any use of such marks by OM Digital Solutions Corporation is under license. Other trademarks and trade names are those of their respective owners.

All other brand or product names in this manual are the trademarks or registered trademarks of their respective owners.



Notes

WARNING

- **Turn off the voice recorder in a hospital or near medical electric devices.**
Electric waves from the voice recorder could affect electric medical devices and could cause accidents due to malfunction.
- **Keep a distance of at least 15cm from persons who have a pacemaker.**
Electric waves from this voice recorder could affect the operation of a pacemaker.
- **Turn OFF the voice recorder when onboard aircraft.**
Using wireless devices onboard may hinder safe operation of the aircraft.

Third-Party Software

THIS PRODUCT IS LICENSED UNDER THE AVC PATENT PORTFOLIO LICENSE FOR THE PERSONAL AND NONCOMMERCIAL USE OF A CONSUMER TO (i) ENCODE VIDEO IN COMPLIANCE WITH THE AVC STANDARD ("AVC VIDEO") AND/OR (ii) DECODE AVC VIDEO THAT WAS ENCODED BY A CONSUMER ENGAGED IN A PERSONAL AND NON-COMMERCIAL ACTIVITY AND/OR WAS OBTAINED FROM A VIDEO PROVIDER LICENSED TO PROVIDE AVC VIDEO. NO LICENSE IS GRANTED OR SHALL BE IMPLIED FOR ANY OTHER USE. ADDITIONAL INFORMATION MAY BE OBTAINED FROM MPEG LA, L.L.C. SEE [HTTP://WWW.MPEGLA.COM](http://www.mpegla.com)

The software in this product may include third party software. Any third party software is subject to the terms and conditions, imposed by the owners or licensors of that software, under which software is provided to you.

Those terms and other third party software notices, if any, may be found in the software notice PDF file stored at

<https://cs.olympus-imaging.jp/en/support/msgs/digicamera/download/notice/notice.cfm>

Specifications

General items

■ Recording formats

Linear PCM format
FLAC format
MP3 format

■ Input level

-63 dBv

■ Sampling frequency

Linear PCM/FLAC format

96.0 kHz/24 bits	96.0 kHz
88.2 kHz/24 bits	88.2 kHz
48.0 kHz/24 bits	48.0 kHz
48.0 kHz/16 bits	48.0 kHz
44.1 kHz/24 bits	44.1 kHz
44.1 kHz/16 bits	44.1 kHz
44.1 kHz mono	44.1 kHz

MP3 format

320 kbps	44.1 kHz
128 kbps	44.1 kHz
64 kbps mono	44.1 kHz

■ Maximum working output

230 mW (8 Ω speaker)

■ Recording media*

Internal NAND flash memory: 16 GB
Compatible microSD cards:
microSD card
microSDHC card
microSDXC card

* Some recording media memory capacity is used as a management area, so the actual usable capacity will always be slightly less than the displayed capacity.

■ Bluetooth® Specification

Standard: Version 5.0 Support
Transmit Power Level: Class 1
Communication Distance:
Line of sight approx. 10 m* (max.)
Operational Frequency Range:
2.4 GHz to 2.4835 GHz
7 mW or less
Modulation Method: FHSS/GFSK
Firmware: Ver. 1.0 or later
Compatible Profiles:
A2DP (Advanced Audio Distribution Profile)
AVRCP (Audio/Video Remote Control Profile)

Compatible Codec:

SBC (Subband Codec)

* The communication distance is guideline values. The communication distance may vary depending on ambient conditions.

■ Speaker

Built-in 18 mm diameter round dynamic speaker

■ Microphone/Line jack

3.5 mm diameter;
Microphone: Impedance: 2.2 kΩ
Line: Impedance: 10 kΩ

■ Earphone jack

3.5 mm diameter;
Impedance: 8 Ω minimum

■ USB cable

TA-KP29

■ Power source

Batteries: Two AAA dry-cell batteries (model LR03), or two BR404 nickel-metal hydride rechargeable batteries (always use BR404 batteries for charging with the recorder)

External power supply: USB-connection AC adapter (model F-5AC; 5 VDC)

■ External dimensions

112.2 × 39.6 × 16.1 mm (Not including largest projection)

■ Weight

78 g (including batteries)

■ Operating temperature

0 to 42°C (32 to 107.6°F)

Frequency response

■ When recording from microphone/line jack

Linear PCM/FLAC format

96.0 kHz/24 bits	20 Hz to 44 kHz
88.2 kHz/24 bits	20 Hz to 42 kHz
48.0 kHz/24 bits	20 Hz to 23 kHz
48.0 kHz/16 bits	20 Hz to 23 kHz
44.1 kHz/24 bits	20 Hz to 21 kHz
44.1 kHz/16 bits	20 Hz to 21 kHz
44.1 kHz mono	20 Hz to 21 kHz

MP3 format

320 kbps	20 Hz to 21 kHz
128 kbps	20 Hz to 17 kHz
64 kbps mono	20 Hz to 15 kHz

■ During playback

20 Hz to 44 kHz (The upper and lower limit values of the frequency response depend on each recording format.)

Battery life

The figures below are guideline values.

■ When recording with built-in stereo microphone (using internal memory)

Recording mode		Alkaline dry-cell batteries	Nickel-metal hydride rechargeable batteries
Linear PCM format	96.0 kHz/24 bits	29 hours (approx.)	20 hours (approx.)
	88.2 kHz/24 bits	31 hours (approx.)	21 hours (approx.)
	48.0 kHz/24 bits	47 hours (approx.)	31 hours (approx.)
	48.0 kHz/16 bits	54 hours (approx.)	36 hours (approx.)
	44.1 kHz/24 bits	50 hours (approx.)	33 hours (approx.)
	44.1 kHz/16 bits	56 hours (approx.)	37 hours (approx.)
	44.1 kHz mono	59 hours (approx.)	39 hours (approx.)
FLAC format	96.0 kHz/24 bits	23 hours (approx.)	16 hours (approx.)
	88.2 kHz/24 bits	24 hours (approx.)	17 hours (approx.)
	48.0 kHz/24 bits	40 hours (approx.)	27 hours (approx.)
	48.0 kHz/16 bits	43 hours (approx.)	29 hours (approx.)
	44.1 kHz/24 bits	41 hours (approx.)	28 hours (approx.)
	44.1 kHz/16 bits	46 hours (approx.)	31 hours (approx.)
MP3 format	320 kbps	62 hours (approx.)	40 hours (approx.)
	128 kbps	63 hours (approx.)	42 hours (approx.)
	64 kbps mono	64 hours (approx.)	42 hours (approx.)

■ During audio file playback

During speaker playback

Recording mode		Alkaline dry-cell batteries	Nickel-metal hydride rechargeable batteries
MP3 format	320 kbps	24 hours (approx.)	16 hours (approx.)
	128 kbps	24 hours (approx.)	16 hours (approx.)
	64 kbps mono	24 hours (approx.)	17 hours (approx.)

During earphone playback

Recording mode		Alkaline dry-cell batteries	Nickel-metal hydride rechargeable batteries
MP3 format	320 kbps	63 hours (approx.)	42 hours (approx.)
	128 kbps	64 hours (approx.)	43 hours (approx.)
	64 kbps mono	72 hours (approx.)	48 hours (approx.)

NOTE

- The figures given here for battery life are the results of in-house testing ([**LED**]: [**Off**]; [**Backlight**]: [**Off**]). Actual battery life varies widely by battery type and conditions of use (among the features with the greatest effect on battery life are pre-recording, noise cancellation, the voice balancer, **Bluetooth**[®], and changes in playback speed).
- Battery life will be shorter when using nickel-metal hydride rechargeable batteries that have been used repeatedly.
- Battery life will be shorter when using a microSD card.

Recording times

The figures below are guideline values.

■ Linear PCM format

Recording mode	Internal memory	microSD card	
		64 GB	32 GB
96.0 kHz/24 bits	7 hours (approx.)	29 hours, 30 minutes (approx.)	14 hours, 30 minutes (approx.)
88.2 kHz/24 bits	7 hours, 45 minutes (approx.)	32 hours (approx.)	16 hours (approx.)
48.0 kHz/24 bits	14 hours (approx.)	59 hours (approx.)	29 hours (approx.)
48.0 kHz/16 bits	21 hours, 30 minutes (approx.)	89 hours (approx.)	44 hours (approx.)
44.1 kHz/24 bits	15 hours, 30 minutes (approx.)	64 hours (approx.)	32 hours (approx.)
44.1 kHz/16 bits	23 hours, 30 minutes (approx.)	97 hours (approx.)	48 hours (approx.)
44.1 kHz mono	47 hours (approx.)	194 hours (approx.)	96 hours (approx.)

■ FLAC format

Recording mode	Internal memory	microSD card	
		64 GB	32 GB
96.0 kHz/24 bits	10 hours (approx.)	42 hours, 30 minutes (approx.)	21 hours (approx.)
88.2 kHz/24 bits	11 hours (approx.)	46 hours (approx.)	22 hours, 30 minutes (approx.)
48.0 kHz/24 bits	20 hours, 30 minutes (approx.)	85 hours (approx.)	42 hours (approx.)
48.0 kHz/16 bits	31 hours (approx.)	127 hours (approx.)	63 hours (approx.)
44.1 kHz/24 bits	22 hours (approx.)	92 hours (approx.)	45 hours, 30 minutes (approx.)
44.1 kHz/16 bits	33 hours, 30 minutes (approx.)	139 hours (approx.)	68 hours (approx.)
44.1 kHz mono	67 hours (approx.)	278 hours (approx.)	137 hours (approx.)

Specifications

■ MP3 format

Recording mode	Internal memory	microSD card	
		64 GB	32 GB
320 kbps	104 hours (approx.)	429 hours (approx.)	212 hours (approx.)
128 kbps	260 hours (approx.)	1070 hours (approx.)	530 hours (approx.)
64 kbps mono	520 hours (approx.)	2140 hours (approx.)	1060 hours (approx.)

NOTE

- Actually available recording times may be shorter than the figures shown here when making short recordings repeatedly (Equipment displays of available/elapsed recording times should be considered guideline values).
- Available recording time will also vary due to differences in the available memory capacity of different microSD cards.

Maximum recording time per file

- The maximum file size is limited to approximately 2 GB in linear PCM (WAV) format, and approximately 4 GB in FLAC/MP3 format.
- Regardless of the amount of remaining memory, the maximum recording time per file is restricted to the following values:

■ Linear PCM format

Recording mode	Recording time
96.0 kHz/24 bits	1 hour (approx.)
88.2 kHz/24 bits	1 hour (approx.)
48.0 kHz/24 bits	2 hours (approx.)
48.0 kHz/16 bits	3 hours (approx.)
44.1 kHz/24 bits	2 hours (approx.)
44.1 kHz/16 bits	3 hours, 20 minutes (approx.)
44.1 kHz mono	6 hours, 40 minutes (approx.)

■ FLAC format

Recording mode	Recording time
96.0 kHz/24 bits	2 hours, 50 minutes (approx.)
88.2 kHz/24 bits	3 hours, 10 minutes (approx.)
48.0 kHz/24 bits	5 hours, 50 minutes (approx.)
48.0 kHz/16 bits	8 hours, 50 minutes (approx.)
44.1 kHz/24 bits	6 hours, 20 minutes (approx.)
44.1 kHz/16 bits	9 hours, 30 minutes (approx.)
44.1 kHz mono	19 hours, 10 minutes (approx.)

■ MP3 format

Recording mode	Recording time
320 kbps	29 hours, 40 minutes (approx.)
128 kbps	74 hours, 30 minutes (approx.)
64 kbps mono	149 hours (approx.)

Linear PCM Files with Sizes over 2 GB

Recording in Linear PCM format will continue even after the file has reached 2 GB in size.

- The resulting recording will be divided into files with a maximum size of 2 GB each. These recordings are treated as separate files during playback.
- If the 200th file exceeds 2 GB, a new folder will be created to store the files containing the remainder of the recording. If the limit of 99 folders has already been reached, recording will end without a new folder being created.

Recording FLAC or MP3 Files with Sizes over 4 GB

Recording in FLAC and MP3 formats will end automatically once the file reaches the maximum size (roughly 4 GB).

Number of music tracks (songs) that can be recorded

The figures below are guideline values.

16 GB	3600 tracks (approx.)
-------	-----------------------

(At 128 kbps, 4 minutes per track)

Note that voice recorder specifications and appearance are subject to change without prior notice for performance improvements or other upgrading.

Safety precautions

Before using the voice recorder, read this manual to ensure correct and safe operation. After reading this manual, be sure to keep it on hand for ready reference whenever needed.

Important safety precautions

- Important safety precautions in this manual are accompanied by the symbol and labels below. Always follow these precautions to prevent harming yourself or others, or causing damage to property.
- The meaning of each precaution type is given below.

DANGER

A precaution about an imminent danger that is expected to result in death or serious injury if equipment is handled incorrectly.

WARNING

A precaution about a situation that is expected to potentially result in death or serious injury if equipment is handled incorrectly.

CAUTION

A precaution about a situation that is expected to potentially result in injury, or is expected to result only in property damage, if equipment is handled incorrectly.

Voice recorder safety precautions

WARNING

- **Do not use the voice recorder in an atmosphere that might contain flammable or explosive gases.**
It may cause fire or explosion.
- **Do not attempt to disassemble, repair or modify the voice recorder.**
It may cause electric shock or injury.
- **Do not operate the voice recorder while operating a vehicle (such as a bicycle, motorcycle or car).**
It may cause traffic accidents.
- **Do not leave the voice recorder in a location accessible to infants and children.**

Pay attention when using the voice recorder near an infant or child, taking care not to leave it unattended. Infants and children are unable to understand voice recorder safety precautions, and are at risk of accidents such as:

- Strangulation caused by accidental entanglement of the earphone cord around the neck.
- Operation errors resulting in injury or electric shock.

- **If you notice unusual odor, noise, heat, burning odor or smoke coming from the recorder:**

- ① Disconnect batteries and USB connection immediately, taking care not to burn or injure yourself. Continued use may result in fire or burns (Do not touch the product with bare hands when it's overheating).
- ② Contact your place of purchase or service center.

- **Do not use the USB power supply via the car cigarette lighter socket or the self-modified power supply.**

It may cause overheating, fire, electric shock or malfunctions.

- **Use microSD/microSDHC/microSDXC memory cards only. Never place other types of cards in the voice recorder.**

If another card type is placed in the voice recorder by accident, do not try to pull it out by force. Contact a repair center or service center.

- **If the voice recorder is dropped in water or, if water, metal or combustible foreign matter gets inside:**

- ① Remove batteries immediately.
- ② Contact your place of purchase or service center for repair. Continued use may result in fire or electric shock.

- **Do not use the voice recorder or use it only as directed in airplanes, hospitals or other locations where use of electronic devices is restricted.**
- **Stop using the voice recorder if you notice unusual odor, noise, or smoke coming from it.**

It may cause fire or burns. Remove batteries immediately, taking care not to burn yourself. Contact your place of purchase, repair center, or service center. (Do not touch batteries with bare hands when removing them. Remove batteries outdoors, and away from flammable objects.)

- **When carrying the voice recorder by its strap, take care to prevent it becoming caught on other items.**

CAUTION

- **Do not raise the volume before performing an operation.**
Hearing damage or loss may result.

Batteries

DANGER

- **Do not place batteries near ignition sources.**
- **Do not incinerate, heat or disassemble batteries. Do not short-circuit batteries' positive and negative electrodes.**
It may cause fire, ruptures, combustion or overheating.
- **Do not solder connections directly onto batteries. Do not deform, modify or disassemble batteries.**
- **Do not connect batteries' positive and negative terminals.**
It may cause overheating, electric shock or fire.
- **When carrying or storing batteries, always place them in the case and protect their terminals. Do not carry or store batteries together with precious metal items such as key rings.**
It may cause overheating, electric shock or fire.
- **Do not connect batteries directly to a power outlet or car cigarette lighter.**
- **Do not use or leave batteries in a hot location such as in direct sunlight, inside a vehicle on a hot day, or near a room heater.**
It may cause fire, burns or injuries from leaking, overheating or ruptures.

WARNING

- **Do not touch or hold batteries with wet hands.**
It may cause electric shock or malfunctions.
- **Do not use batteries with a scratched or damaged case.**
It may cause ruptures or overheating.
- **Do not insert batteries with their positive/negative terminals in the opposite directions.**
It may cause leaking, overheating, combustion or ruptures.
 - Do not use batteries with torn casing seals (insulating coverings).
 - Always remove batteries when the voice recorder will not be used for an long period.
 - When disposing used batteries, insulate their contacts with tape and discard them as general waste in the manner prescribed by the local authority.
 - Remove batteries from the voice recorder as soon as batteries become unusable. It may cause leakage.
- **Battery fluid in the eyes may cause blindness. If battery fluid gets in eyes, do not rub the eyes. Instead, rinse them thoroughly with tap water or other clean water right away. Go to doctor immediately.**
- **Do not attempt to recharge alkaline, lithium or any other non-rechargeable batteries.**

- **Keep batteries out of the reach of infants and children.**

Batteries could be swallowed by infants and children. Swallowing may lead to burns, perforation of soft tissue, and death. Severe burns can occur within 2 h of ingestion. If swallowed, go to doctor immediately.

- **Do not submerge batteries in freshwater or saltwater, or allow their terminals to become wet.**
- **Discontinue use of batteries if they develop a problem such as leaking, discoloration or deformation.**
- **Stop charging the rechargeable batteries if charging has not finished after the specified amount of charging time.**
- **Battery fluid on clothing or skin may damage the skin, so rinse the battery fluid off right away with tap water or other clean water.**

CAUTION

- **Do not mix charged and discharged batteries.**
- **Do not mix batteries of different capacities, types, or makes.**
- **Charge each pair of batteries together.**
- **Do not throw batteries around, or subject them to strong shocks.**
- **Always charge the rechargeable batteries before use when using them for the first time or if they have not been used for a long time.**

- **Rechargeable batteries have a limited life. When the recorders operating time becomes shorter after recharging under the specified condition, please consider that batteries are expired and replace them with new ones.**
- **There is a risk of explosion if the batteries are replaced with batteries of the incorrect type. When disposing used batteries follow the instructions.**
Please recycle batteries to help save our planet's resources. When you throw away dead batteries, be sure to cover their terminals and always observe local laws and regulations.

Disposing the rechargeable batteries

- **Recycling batteries helps saving resources. When disposing used batteries, always cover its terminals and observe local laws and regulations.**

Operating precautions

- Do not leave the voice recorder in hot or humid locations such as in direct sunlight inside a vehicle, or on a beach during summer.
- Do not store the voice recorder in humid or dusty locations.
- If the voice recorder becomes wet or damp, wipe off the moisture right away with a dry cloth. Contact with salt water should be particularly avoided.
- Do not place the voice recorder on top of or near a TV, refrigerator or other electrical appliance.
- Prevent sand or mud from getting on the voice recorder. It may cause product not to be repairable.
- Do not subject the voice recorder to intense vibrations or shocks.
- Do not use the voice recorder in humid locations.
- Placing a magnetic card (such as a bank cash card) near the speaker or earphones may cause errors in the data stored on the magnetic card.
- Noise may be heard when the voice recorder is placed near an electric lamp line, fluorescent light or a mobile phone during recording or playback.

<Data loss precautions>

- Recorded content in the internal memory and microSD card may be destroyed or lost due to reasons such as operating errors, device failure or repair.
- Also, when content is saved in the memory for long period of time or is used repeatedly, operations such as writing to, reading from, or erasing of contents may not be possible.
- Making a backup of important recorded information and saving it on a computer's hard disk or other recording media is recommended.
- Note that we will not be held liable for damages or lost earnings resulting from recorded data damage or loss, regardless of the nature or cause thereof.

<Recorded file precautions>

- Note that we will not be held liable for recorded files being erased or becoming unplayable due to voice recorder or computer failure.
- Recording of copyrighted material is permitted when the recording is for your personal use only. Any other type of use without the permission of the copyright owner is prohibited by copyright law.

<Voice recorder and microSD cards disposal precautions>

- Even when formatting (☞ P.133) or erasing (☞ P.74) are performed, only the file management information of the internal memory and/or microSD card is updated and the recorded data is not completely erased.

When disposing of the voice recorder or a microSD card, be sure to destroy it, format and record silence until the recording time runs out, or perform a similar operation in order to prevent the leakage of personal information.

date of issue 2022.01.



<https://om-digitalsolutions.com/>