

# **GIGABYTE™**

# **R161-340**

Dual LGA3647 sockets motherboard for Intel® Scalable Family Processors

## Service Guide

Rev. 1.0

## **Copyright**

© 2019 GIGA-BYTE TECHNOLOGY CO., LTD. All rights reserved.

The trademarks mentioned in this manual are legally registered to their respective owners.

## **Disclaimer**

Information in this manual is protected by copyright laws and is the property of GIGABYTE.

Changes to the specifications and features in this manual may be made by GIGABYTE without prior notice. No part of this manual may be reproduced, copied, translated, transmitted, or published in any form or by any means without GIGABYTE's prior written permission.

## **Documentation Classifications**

In order to assist in the use of this product, GIGABYTE provides the following types of documentations:

- For detailed product information, carefully read the User's Manual.

## **For More Information**

For related product specifications, the latest firmware and software, and related information, please visit our website at:

<http://www.gigabyte.com>

For GIGABYTE distributors and resellers, additional sales & marketing materials are available from our reseller portal:

<http://reseller.b2b.gigabyte.com>

For further information & technical assistance, please contact your GIGABYTE sales representative.



You may also message GIGABYTE server directly by email, Facebook or twitter

Email: [server.grp@gigabyte.com](mailto:server.grp@gigabyte.com)

Facebook: <https://www.facebook.com/gigabiteserver>

## Conventions

The following conventions are used in this user's guide:

	<b>NOTE!</b> Gives bits and pieces of additional information related to the current topic.
	<b>CAUTION!</b> Gives precautionary measures to avoid possible hardware or software problems.
	<b>WARNING!</b> Alerts you to any damage that might result from doing or not doing specific actions.

## Server Warnings and Cautions

Before installing a server, be sure that you understand the following warnings and cautions.



### WARNING!

**To reduce the risk of electric shock or damage to the equipment:**

- Do not disable the power cord grounding plug. The grounding plug is an important safety feature.
- Plug the power cord into a grounded (earthed) electrical outlet that is easily accessible at all times.
- Unplug the power cord from the power supply to disconnect power to the equipment.
- Do not route the power cord where it can be walked on or pinched by items placed against it. Pay particular attention to the plug, electrical outlet, and the point where the cord extends from the server.



### WARNING!

**To reduce the risk of personal injury from hot surfaces, allow the drives and the internal system components to cool before touching them.**



### WARNING!

**This server is equipped with high speed fans. Keep away from hazardous moving fan blades during servicing.**



### CAUTION!

- Do not operate the server for long periods with the access panel open or removed. Operating the server in this manner results in improper airflow and improper cooling that can lead to thermal damage.
- Danger of explosion if battery is incorrectly replaced.
- Replace only with the same or equivalent type recommended by the manufacturer.
- Dispose of used batteries according to the manufacturer's instructions.



## Electrostatic Discharge (ESD)



### CAUTION!

ESD CAN DAMAGE DRIVES, BOARDS, AND OTHER PARTS. WE RECOMMEND THAT YOU PERFORM ALL PROCEDURES AT AN ESD WORKSTATION. IF ONE IS NOT AVAILABLE, PROVIDE SOME ESD PROTECTION BY WEARING AN ANTI-STATIC WRIST STRAP ATTACHED TO CHASSIS GROUND -- ANY UNPAINTED METAL SURFACE -- ON YOUR SERVER WHEN HANDLING PARTS.

Always handle boards carefully. They can be extremely sensitive to ESD. Hold boards only by their edges without any component and pin touching. After removing a board from its protective wrapper or from the system, place the board component side up on a grounded, static free surface. Use a conductive foam pad if available but not the board wrapper. Do not slide board over any surface.

**System power on/off:** To remove power from system, you must remove the system from rack. Make sure the system is removed from the rack before opening the chassis, adding, or removing any non hot-plug components.

**Hazardous conditions, devices and cables:** Hazardous electrical conditions may be present on power, telephone, and communication cables. Turn off the system and disconnect the cables attached to the system before servicing it. Otherwise, personal injury or equipment damage can result.

**Electrostatic discharge (ESD) and ESD protection:** ESD can damage drives, boards, and other parts. We recommend that you perform all procedures in this chapter only at an ESD workstation. If one is not available, provide some ESD protection by wearing an antistatic wrist strap attached to chassis ground (any unpainted metal surface on the server) when handling parts.

**ESD and handling boards:** Always handle boards carefully. They can be extremely sensitive to electrostatic discharge (ESD). Hold boards only by their edges. After removing a board from its protective wrapper or from the system, place the board component side up on a grounded, static free surface. Use a conductive foam pad if available but not the board wrapper. Do not slide board over any surface.

**Installing or removing jumpers:** A jumper is a small plastic encased conductor that slips over two jumper pins. Some jumpers have a small tab on top that can be gripped with fingertips or with a pair of fine needle nosed pliers. If the jumpers do not have such a tab, take care when using needle nosed pliers to remove or install a jumper; grip the narrow sides of the jumper with the

pliers, never the wide sides. Gripping the wide sides can damage the contacts inside the jumper, causing intermittent problems with the function controlled by that jumper. Take care to grip with, but not squeeze, the pliers or other tool used to remove a jumper, or the pins on the board may bend or break.



**CAUTION!**

Risk of explosion if battery is replaced incorrectly or with an incorrect type. Replace the battery only with the same or equivalent type recommended by the manufacturer. Dispose of used batteries according to the manufacturer's instructions.

# Table of Contents

Chapter 1	Hardware Installation .....	10
1-1	Installation Precautions .....	10
1-2	Product Specifications .....	11
1-3	System Block Diagram .....	14
Chapter 2	System Appearance .....	15
2-1	Front View .....	15
2-2	Rear View .....	15
2-3	Front Panel LED and Buttons .....	16
2-4	Rear System LAN LEDs .....	17
2-5	Hard Disk Drive LEDs .....	18
2-6	Power Supply Unit LED .....	19
Chapter 3	System Hardware Installation .....	21
3-1	Removing and Installing the Chassis Cover .....	22
3-2	Removing and Installing the Fan Duct .....	23
3-3	Removing and Installing the CPU and Heat Sink .....	24
3-4	Removing and Installing Memory .....	26
3-4-1	Six-Channel Memory Configuration .....	26
3-4-2	Removing and Installing a Memory Module .....	27
3-4-3	DIMM Population Table .....	27
3-5	Removing and Installing the PCI Expansion Card .....	28
3-6	Removing and Installing the Hard Disk Drive .....	29
3-7	Installing and Removing an M.2 Solid State Drive .....	30
3-8	Replacing the Fan Assembly .....	31
3-9	Removing and Installing the Power Supply .....	32
3-10	Cable Routing .....	33
Chapter 4	Motherboard Components .....	35
4-1	Motherboard Components .....	35
4-2	Jumper Settings .....	37
Chapter 5	BIOS Setup .....	39
5-1	The Main Menu .....	41
5-2	Advanced Menu .....	44
5-2-1	Trusted Computing .....	45
5-2-2	Serial Port Console Redirection .....	46

5-2-3	SIO Configuration .....	49
5-2-4	PCI Subsystem Settings .....	50
5-2-5	USB Configuration .....	52
5-2-6	Post Report Configuration .....	53
5-2-7	NVMe Configuration .....	54
5-2-8	Chipset Configuration .....	55
5-2-9	Network Stack Configuration .....	56
5-2-10	iSCSI Configuration .....	57
5-2-11	Intel(R) I210 Gigabit Network Connection .....	58
5-2-12	VLAN Configuration .....	60
5-2-13	Driver Health .....	62
5-3	Chipset Setup Menu .....	63
5-3-1	Processor Configuration .....	64
5-3-2	Common RefCode Configuration .....	67
5-3-3	UPI Configuration .....	68
5-3-4	Memory Configuration .....	69
5-3-5	IIO Configuration .....	71
5-3-6	Advanced Power Management Configuration .....	73
5-3-7	PCH Configuration .....	76
5-3-8	Miscellaneous Configuration .....	78
5-3-9	Server ME Configuration .....	79
5-3-10	Runtime Error Logging .....	80
5-3-11	Power Policy .....	82
5-4	Server Management Menu .....	84
5-4-1	System Event Log .....	86
5-4-2	View FRU Information .....	87
5-4-3	BMC VLAN Configuration .....	88
5-4-4	BMC Network Configuration .....	89
5-4-5	IPv6 BMC Network Configuration .....	90
5-5	Security Menu .....	91
5-5-1	Secure Boot .....	92
5-6	Boot Menu .....	94
5-6-1	UEFI NETWORK Drive BBS Priorities .....	96
5-6-2	UEFI Application Boot Priorities .....	97
5-7	Save & Exit Menu .....	98
5-8	BIOS POST Codes .....	100
5-8-1	AMI Standard - PEI .....	100
5-8-2	AMI Standard - DXE .....	100
5-8-3	AMI Standard - ERROR .....	102
5-8-4	Intel UPI POST Codes .....	103
5-8-5	Intel UPI Error Codes .....	103
5-8-6	Intel MRC POST Codes .....	104

5-8-7	Intel MRC Error Codes .....	104
5-8-8	Intel PM POST Codes .....	105
5-8-9	Intel PM POST Codes .....	105
5-9	BIOS POST Beep code (AMI standard) .....	106
5-9-1	PEI Beep Codes .....	106
5-9-2	DXE Beep Codes .....	106
5-10	BIOS Recovery Instruction .....	107









# Chapter 1 Hardware Installation







## 1-1 Installation Precautions

The motherboard/system contain numerous delicate electronic circuits and components which can become damaged as a result of electrostatic discharge (ESD). Prior to installation, carefully read the service guide and follow these procedures:





- Prior to installation, do not remove or break motherboard S/N (Serial Number) sticker or warranty sticker provided by your dealer. These stickers are required for warranty validation.
- Always remove the AC power by unplugging the power cord from the power outlet before installing or removing the motherboard or other hardware components.
- When connecting hardware components to the internal connectors on the motherboard, make sure they are connected tightly and securely.
- When handling the motherboard, avoid touching any metal leads or connectors.
- It is best to wear an electrostatic discharge (ESD) wrist strap when handling electronic components such as a motherboard, CPU or memory. If you do not have an ESD wrist strap, keep your hands dry and first touch a metal object to eliminate static electricity.
- Prior to installing the motherboard, please have it on top of an antistatic pad or within an electrostatic shielding container.
- Before unplugging the power supply cable from the motherboard, make sure the power supply has been turned off.
- Before turning on the power, make sure the power supply voltage has been set according to the local voltage standard.
- Before using the product, please verify that all cables and power connectors of your hardware components are connected.
- To prevent damage to the motherboard, do not allow screws to come in contact with the motherboard circuit or its components.
- Make sure there are no leftover screws or metal components placed on the motherboard or within the computer casing.
- Do not place the computer system on an uneven surface.
- Do not place the computer system in a high-temperature environment.
- Turning on the computer power during the installation process can lead to damage to system components as well as physical harm to the user.
- If you are uncertain about any installation steps or have a problem related to the use of the product, please consult a certified computer technician.

## 1-2 Product Specifications

 CPU	<ul style="list-style-type: none"> <li>◆ 2nd Generation Intel® Xeon® Scalable and Intel® Xeon® Scalable Processors</li> <li>◆ Intel® Xeon® Platinum Processor, Intel® Xeon® Gold Processor, Intel® Xeon® Silver Processor and Intel® Xeon® Bronze Processor</li> <li>◆ CPU TDP up to 125W</li> </ul> <p><b>NOTE:</b> If only 1 CPU is installed, some PCIe or memory functions might be unavailable</p>
 Socket	<ul style="list-style-type: none"> <li>◆ 2 x LGA 3647</li> <li>◆ Socket P</li> </ul>
 Chipset	<ul style="list-style-type: none"> <li>◆ Intel® C621 Express Chipset</li> </ul>
 Memory	<ul style="list-style-type: none"> <li>◆ 16 x DIMM slots</li> <li>◆ DDR4 memory supported only</li> <li>◆ 6-channel memory architecture</li> <li>◆ RDIMM modules up to 64GB supported</li> <li>◆ LRDIMM modules up to 128GB supported</li> <li>◆ 1.2V modules: 2933( 1DPC)/2666/2400/2133 MHz</li> </ul> <p><b>NOTE:</b> 2933MHz for 2nd Generation Intel® Xeon® Scalable Processors only</p>
 LAN	<ul style="list-style-type: none"> <li>◆ 2 x 1Gb/s LAN ports (Intel® I210-AT)</li> <li>◆ 1 x 10/100/1000 management LAN</li> </ul> <ul style="list-style-type: none"> <li>◆ * 2 x 10Gb/s LAN ports (Intel® X557) as an option</li> <li>◆ * 2 x 25Gb/s SFP28 ports (Mellanox® ConnectX-4 Lx) as an option</li> </ul>
 Expansion Slot	<p><b>Riser Card CRS1014:</b></p> <ul style="list-style-type: none"> <li>◆ - 1 x PCIe x16 slots (Gen3 x16), Full height half-length</li> </ul> <p><b>Riser Card CRS1015:</b></p> <ul style="list-style-type: none"> <li>◆ - 1 x PCIe x16 slot (Gen3 x16), Full height half-length</li> </ul> <p>2 x M.2 slots:</p> <ul style="list-style-type: none"> <li>◆ - M-key</li> <li>◆ - PCIe Gen3 x4</li> <li>◆ - Supports NGFF-2260/2280 cards</li> </ul>
 Video	<ul style="list-style-type: none"> <li>◆ Integrated in Aspeed® AST2500</li> <li>◆ 2D Video Graphic Adapter with PCIe bus interface</li> <li>◆ 1920x1200@60Hz 32bpp, DDR4 SDRAM</li> </ul>
 Storage	<ul style="list-style-type: none"> <li>◆ 4 x 3.5" SATA/SAS hot-swappable HDD/SSD bays</li> <li>◆ 2.5" HDD/SSD supported</li> <li>◆ SAS card is required for SAS devices support</li> <li>◆ 1 x 2.5" internal fixed SATA HDD/SSD bay</li> <li>◆ 2 x 2.5" internal fixed SATA HDD/SSD bays as an option</li> </ul>
 SATA	<ul style="list-style-type: none"> <li>◆ 2 x 7-pin SATA III 6Gb/s with SATA DOM supported</li> <li>◆ By using pin_8 or external cable for power function</li> </ul>

 SAS	<ul style="list-style-type: none"> <li>◆ Supported via add-on SAS Card</li> </ul>
 Support RAID Function	<ul style="list-style-type: none"> <li>◆ Intel® SATA RAID 0/1/10/5</li> </ul>
 Internal Connectors	<ul style="list-style-type: none"> <li>◆ 2 x Power supply connectors</li> <li>◆ 5 x SlimSAS connectors</li> <li>◆ 2 x SATA 7-pin connectors</li> <li>◆ 2 x CPU fan headers</li> <li>◆ 1 x USB 3.0 header</li> <li>◆ 1 x TPM header</li> <li>◆ 1 x VROC connector</li> <li>◆ 1 x Front panel header</li> <li>◆ 1 x HDD back plane board header</li> <li>◆ 1 x IPMB connector</li> <li>◆ 1 x Clear CMOS jumper</li> <li>◆ 1 x BIOS recovery jumper</li> </ul>
 Front Panel LED/Buttons	<ul style="list-style-type: none"> <li>◆ 2 x USB 3.0</li> <li>◆ 1 x Power button with LED</li> <li>◆ 1 x ID button with LED</li> <li>◆ 1 x Reset button</li> <li>◆ 1 x NMI button</li> <li>◆ 1 x System status LED</li> <li>◆ 1 x HDD activity LED</li> <li>◆ 2 x LAN activity LEDs</li> </ul>
 Rear Panel I/O	<ul style="list-style-type: none"> <li>◆ 2 x USB 3.0</li> <li>◆ 1 x VGA</li> <li>◆ 1 x COM (as an option)</li> <li>◆ 2 x RJ45</li> <li>◆ 1 x MLAN</li> <li>◆ 1 x ID button with LED</li> </ul>
 Backplane I/O	<ul style="list-style-type: none"> <li>◆ 4 x SATA/SAS ports</li> <li>◆ Bandwidth: SATAIII 6Gb/s or SAS 12Gb/s per port</li> </ul>
 TPM	<ul style="list-style-type: none"> <li>◆ 1 x TPM header with SPI interface</li> <li>◆ Optional TPM2.0 kit: CTM010</li> </ul>



	System Management	<ul style="list-style-type: none"> <li>◆ Aspeed® AST2500 management controller</li> <li>◆ Avocent® MergePoint IPMI 2.0 web interface:</li> <li>◆ Network settings</li> <li>◆ Network security settings</li> <li>◆ Hardware information</li> <li>◆ Users control</li> <li>◆ Services settings</li> <li>◆ IPMI settings</li> <li>◆ Sessions control</li> <li>◆ LDAP settings</li> <li>◆ Power control</li> <li>◆ Fan profiles</li> <li>◆ Voltages, fans and temperatures monitoring</li> <li>◆ System event log</li> <li>◆ Events management (platform events, trap settings, email settings)</li> <li>◆ Serial Over LAN</li> <li>◆ vKVM &amp; vMedia (HTML5)</li> </ul>
	Power Supply	<ul style="list-style-type: none"> <li>◆ 1 x 550W single PSUs</li> <li>◆ 80 PLUS Platinum</li>   <li>◆ AC Input:</li> <li>◆ - 100-240V~/ 8-4A, 50-60Hz</li> <li>◆ DC Input:</li> <li>◆ - 240Vdc/ 2.75A</li>   <li>◆ DC Output:</li> <li>◆ - 550W</li> <li>◆ +12V/ 44A</li> <li>◆ +12Vsb/ 2.1A</li>   <li>◆ * Enable to upgrade to 2 x 550W redundant PSU (as an option)</li> </ul>
	Environment Ambient Temperature  Relative Humidity	<ul style="list-style-type: none"> <li>◆ Operating temperature: 10°C to 35°C</li> <li>◆ Non-operating temperature: -40°C to 60°C</li>   <li>◆ Operating humidity: 8-80% (non-condensing)</li> <li>◆ Non-operating humidity: 20%-95% (non-condensing)</li> </ul>
	System Dimension	<ul style="list-style-type: none"> <li>◆ 1U</li> <li>◆ 438mm (W) x 43.5mm (H) x 730mm (D)</li> </ul>
<p>* We reserves the right to make any changes to the product specifications and product-related information without prior notice.</p>		



# Chapter 2 System Appearance

## 2-1 Front View



No.	Description
1.	Front Panel LEDs and buttons
2.	Front USB 3.0 ports



- Refer to Chapter 2-3 **Front Panel LED** and Buttons for a detailed description of the function of the LEDs.

## 2-2 Rear View

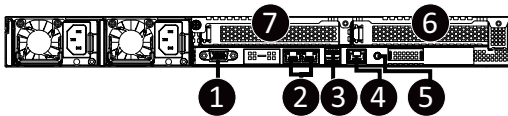

No.	Description
1.	VGA Port
2.	1Gbe LAN Port x 2
3.	USB 3.0 Port x 2
4.	10/100/1000 Server management LAN port
5.	ID Button
6.	PCIe Card Bay #1
7.	PCIe Card Bay #2



- Refer to Chapter 2-4 **Rear System LAN LEDs** for a detailed description of the function of the LEDs.

### 2-3 Front Panel LED and Buttons

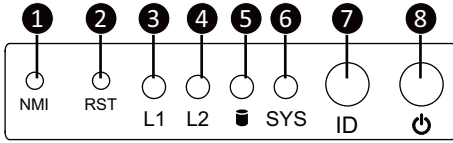

No.	Name	Color	Status	Description
1.	NMI button			Press the button server generates a NMI to the processor if the multiple-bit ECC errors occur, which effectively halt the server.
2.	Reset Button			Press the button to reset the system.
3/4.	LAN 1/2 Active/Link LEDs	Green	Solid On	Link between system and network or no access.
		Green	Blink	Data trasmission or receiving is occurring
		N/A	Off	No data transmission or receiving is occurring
5.	HDD Status LED	Green	On	HDD locate
			Blink	HDD access
		Amber	On	HDD fault
		Green/Amber	Blink	HDD rebuilding
		N/A	Off	No HDD access or no HDD fault.
6.	System Status LED	Green	Solid On	System is operating normally.
			Solid On	Critical condition, may indicate: System fan failure System temperature
		Amber	Blink	Non-critical condition, may indicate: Redundant power module failure Temperature and voltage issue Chassis intrusion
			Off	System is not ready, may indicate: POST error NMI error Processor or terminator missing
7.	ID Button			Press the button to activate system identification
8.	Power button with LED	Green	On	System is powered on
		Green	Blink	System is in ACPI S1 state (sleep mode)
		N/A	Off	<ul style="list-style-type: none"> <li>• System is not powered on or in ACPI S5 state (power off)</li> <li>• System is in ACPI S4 state (hibernate mode)</li> </ul>

## 2-4 Rear System LAN LEDs

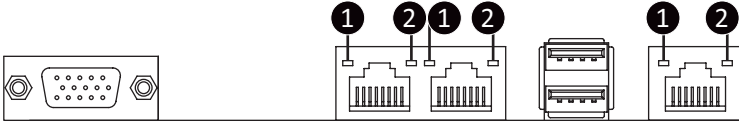

No.	Name	Color	Status	Description
1.	1GbE Speed LED	Yellow	On	1 Gbps data rate
		Green	On	100 Mbps data rate
		N/A	Off	10 Mbps data rate
2.	1GbE Link/ Activity LED	Green	On	Link between system and network or no access
			Blink	Data transmission or receiving is occurring
		N/A	Off	No data transmission or receiving is occurring

## 2-5 Hard Disk Drive LEDs

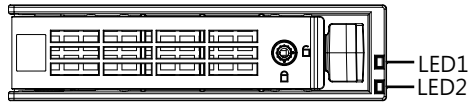

RAID SKU		LED1	Locate	HDD Fault	Rebuilding	HDD Access	HDD Present (No Access)
No RAID configuration (via HBA, PCH)	Disk LED (LED on Back Panel)	Green	ON(*1)	OFF		BLINK (*2)	OFF
		Amber	OFF	OFF		OFF	OFF
	Removed HDD Slot (LED on Back Panel)	Green	ON(*1)	OFF		--	--
		Amber	OFF	OFF		--	--
RAID configuration (via HW RAID Card or SW RAID Card)	Disk LED	Green	ON	OFF		BLINK (*2)	OFF
		Amber	OFF	ON	(Low Speed: 2 Hz)	OFF	OFF
	Removed HDD Slot	Green	ON(*1)	OFF	(*3)	--	--
		Amber	OFF	ON	(*3)	--	--

NOTE:

\*1: Depends on HBA/Utility Spec.

\*2: Blink cycle depends on HDD's activity signal.

\*3: If HDD is pulled out during rebuilding, the disk status of this HDD is regarded as faulty.

LED 2	HDD Present	No HDD
Green	ON	OFF

## 2-6 Power Supply Unit LED

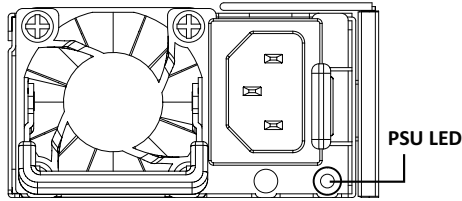

State	Description
Off	No AC power to all power supplies
GREEN	Output ON and OK
1Hz Blink GREEN	AC present/ only standby on/ Cold redundant mode
2Hz Blink GREEN	Power supply F.W updateing mode
Green BLINKING 0.25 Sec./On 0.25 Sec./Off 2Hz	PSU Sleep Mode (cold Redundant/Offline mode)
Amber	AC cord unplugged or AC power lost; with a second power supply in parallel still with AC input power
	Power supply critical event causing shut down: failure, OCP, OVP, Fan Fail, UVP
1Hz Blink AMBER	Power supply warning events where the power supply continues to operate: high temp, high power, high current, slow fan

This page intentionally left blank



## Chapter 3 System Hardware Installation



### Pre-installation Instructions

Computer components and electronic circuit boards can be damaged by discharges of static electricity. Working on computers that are still connected to a power supply can be extremely dangerous. Follow the simple guidelines below to avoid damage to your computer or injury to yourself.

- Always disconnect the computer from the power outlet whenever you are working inside the computer case.
- If possible, wear a grounded wrist strap when you are working inside the computer case. Alternatively, discharge any static electricity by touching the bare metal system of the computer case, or the bare metal body of any other grounded appliance.
- Hold electronic circuit boards by the edges only. Do not touch the components on the board unless it is necessary to do so. Do not flex or stress the circuit board.
- Leave all components inside the static-proof packaging until you are ready to use the component for the installation.

### 3-1 Removing and Installing the Chassis Cover



Before you remove or install the system cover

- Make sure the system is not turned on or connected to AC power.

**Follow these instructions to remove the chassis covers:**

1. Loosen and remove the two thumbscrews securing the back cover.
2. Push down the indentation located at the side of the back chassis
3. Slide the cover horizontally to the back and remove the cover in the direction of the arrow.
4. To reinstall the chassis cover follow steps 1-3 in reverse order.

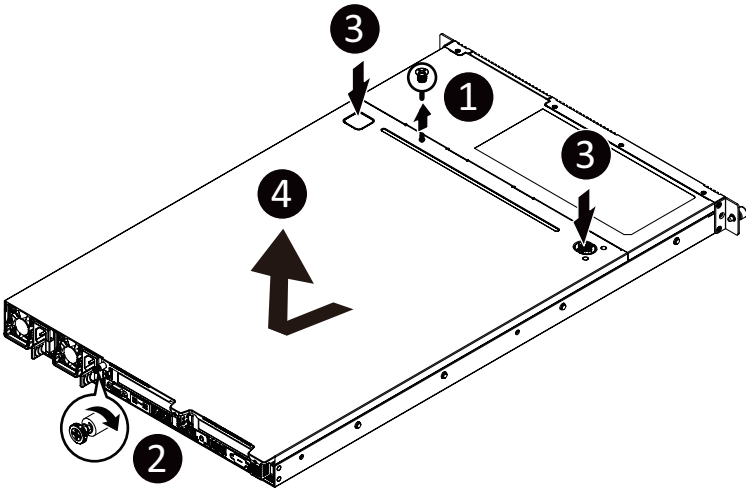

## 3-2 Removing and Installing the Fan Duct

Follow these instructions to remove the fan duct:

1. Lift up to remove the two fan ducts
2. To install the fan duct, align the fan duct with the guiding groove. Push down the fan duct into chassis until its firmly seats

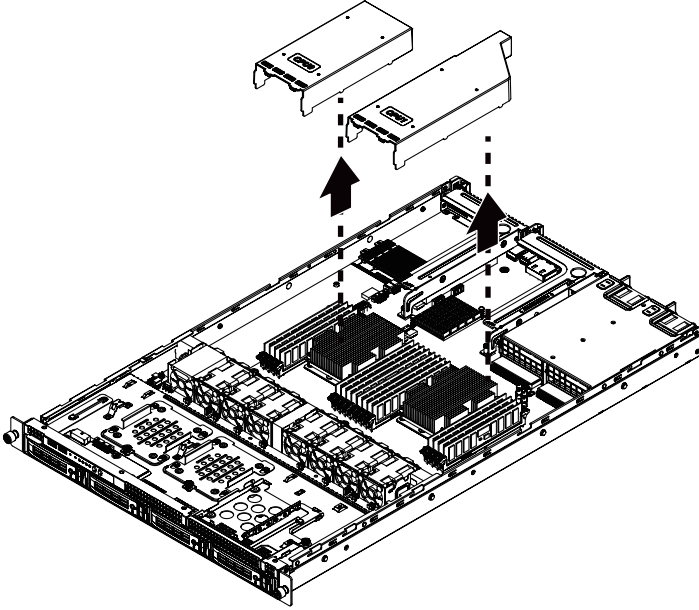

### 3-3 Removing and Installing the CPU and Heat Sink



Read the following guidelines before you begin to install the CPU:

- Make sure that the motherboard supports the CPU.
- Always turn off the computer and unplug the power cord from the power outlet before installing the CPU to prevent hardware damage.
- Unplug all cables from the power outlets.
- Disconnect all telecommunication cables from their ports.
- Place the system unit on a flat and stable surface.
- Open the system according to the instructions.



#### **WARNING!**

Failure to properly turn off the server before you start installing components may cause serious damage. Do not attempt the procedures described in the following sections unless you are a qualified service technician.

#### **Follow these instructions to install the CPU:**

1. Align and install the processor on the carrier.

**NOTE:** Apply thermal compound evenly on the top of the CPU. Remove the protective cover from the underside of the heat sink.

2. Carefully flip the heatsink over. Then install the carrier assembly on the bottom of the heatsink and make sure the gold arrow is located in the correct direction.

3. Remove the CPU cover.

**NOTE:** Save and replace the CPU cover if the processor is removed from its socket.

4. Align the heatsink with the CPU socket by the guide pins and make sure the gold arrow is located in the correct direction. Then place the heatsink onto the top of the CPU socket.

5. To secure the heatsink, tighten the screws in a sequential order (1→2→3→4).

**NOTE:** When disassembling the heatsink, loosen the screws in reverse order (4→3→2→1).

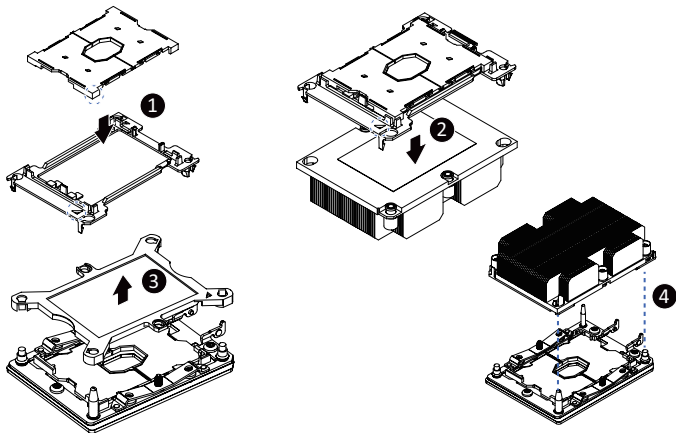

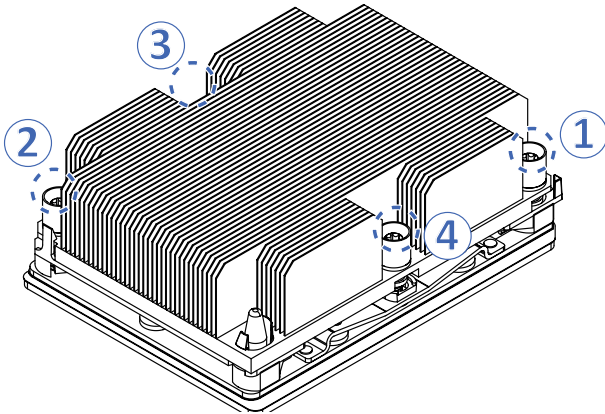
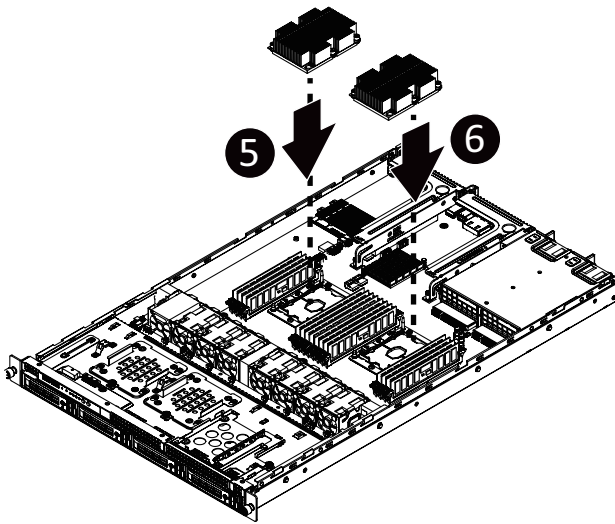

## 3-4 Removing and Installing Memory



Read the following guidelines before you begin to install the memory:

- Make sure that the motherboard supports the memory. It is recommended that memory of the same capacity, brand, speed, and chips be used.
- Always turn off the computer and unplug the power cord from the power outlet before installing the memory to prevent hardware damage.
- Memory modules have a foolproof design. A memory module can be installed in only one direction. If you are unable to insert the memory, switch the direction.

### 3-4-1 Six-Channel Memory Configuration

This motherboard provides 16 DDR4 memory sockets and supports Six Channel Technology. After the memory is installed, the BIOS will automatically detect the specifications and capacity of the memory.

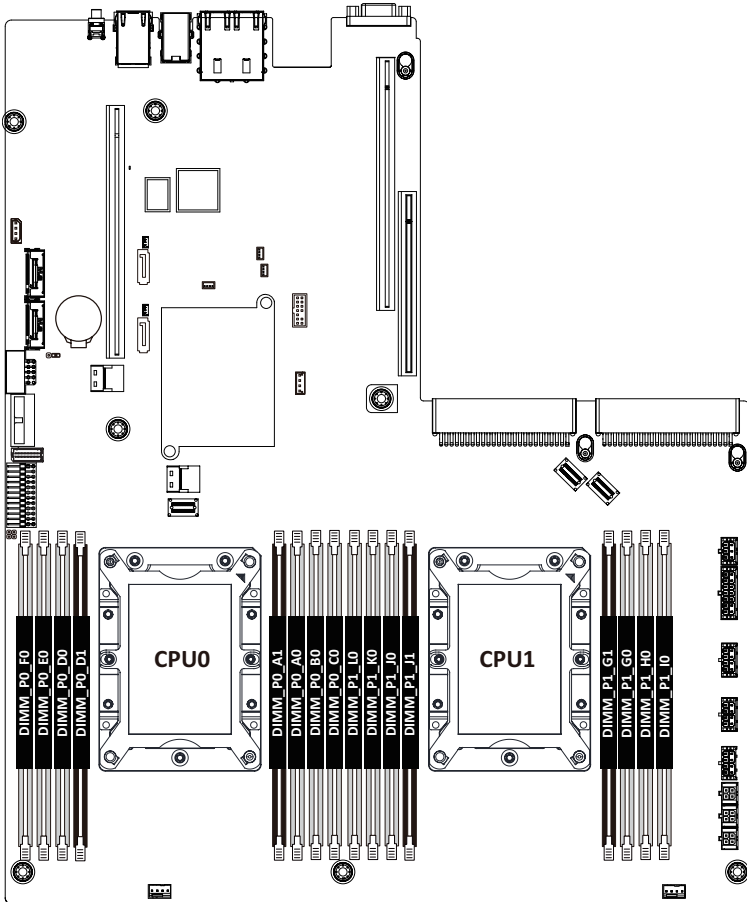

### 3-4-2 Removing and Installing a Memory Module



Before installing a memory module, make sure to turn off the computer and unplug the power cord from the power outlet to prevent damage to the memory module.

Be sure to install DDR4 DIMMs on to this motherboard.

Follow these instructions to install a DIMM module:

1. Insert the DIMM memory module vertically into the DIMM slot and push it down.
2. Close the plastic clip at both edges of the DIMM slots to lock the DIMM module.
3. Reverse the installation steps when you want to remove the DIMM module.

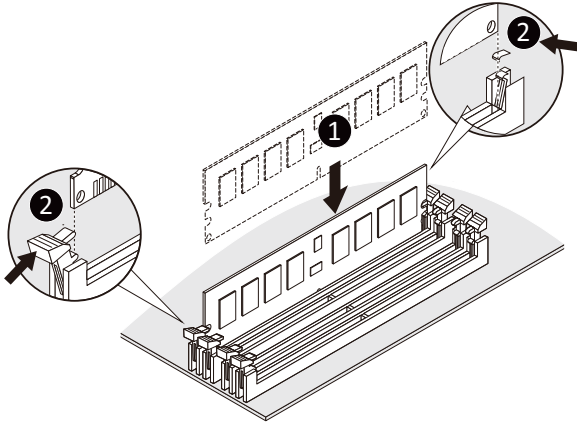

### 3-4-3 DIMM Population Table

Type	Ranks Per DIMM and Data Width	DIMM Capacity (GB)			Speed (MT/s); Voltage (V) Slot Per Channel (SPC) DIMM Per Channel (DPC)		
					1 Slot per Channel	2 Slot per Channel	
		DIMM Density			1DPC	1DPC	2DPC
RDIMM	SRx4	4Gb	8Gb	8Gb	1.2V	1.2V	1.2V
RDIMM	SRx8	4GB	8GB	16GB	2933	2933	2666
RDIMM	DRx8	8GB	16GB	32GB			
RDIMM	DRx4	16GB	32GB	64GB			
RDIMM 3DS	QRx 4	N/A	2H-64GB	2H-128GB			
RDIMM 3DS	8Rx 4	N/A	4H-128GB	4H-256GB			
LRDIMM	QRx4	32GB	64GB	128GB			
LRDIMM	QRx4	N/A	2H-64GB	2H-128GB			
LRDIMM 3DS	8Rx4	N/A	4H-128GB	4H-256GB			

### 3-5 Removing and Installing the PCI Expansion Card



- Voltages can be present within the server whenever an AC power source is connected. This voltage is present even when the main power switch is in the off position. Ensure that the system is powered off and all power sources have been disconnected from the server prior to installing a PCIe card.

- Failure to observe these warnings could result in personal injury or damage to equipment.



- The PCI riser assembly does not include a riser card or any cabling as standard. To install a PCIe card, a riser card must be installed.

#### Follow these instructions to PCI Expansion card:

1. Loosen and remove the thumbscrew on the riser bracket.
2. Remove the screw securing the riser bracket.
3. Lift up the riser bracket out of system.
4. Loosen and remove the screw securing the slot cover from riser bracket.
5. Orient the PCIe card with the riser guide slot and push in the direction of the arrow until the PCIe card sits in the PCIe card connector.

**NOTE:** Some riser brackets allow for single or multiple PCIe cards. Repeat steps 4-5 as necessary.

6. Secure the PCIe card with the screw.
7. Reverse steps 1-3 to install the riser bracket.

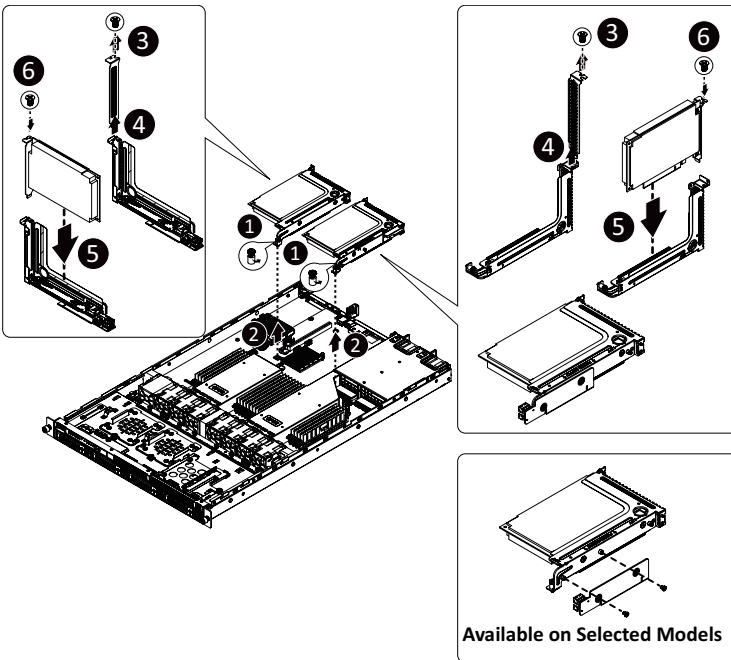



## 3-6 Removing and Installing the Hard Disk Drive



Read the following guidelines before you begin to install the hard disk drive:

- Take note of the drive tray orientation before sliding it out.
- The tray will not fit back into the bay if it is inserted incorrectly.
- Make sure that the HDD is connected to the HDD connector on the backplane.

**Follow these instructions to install a hard disk drive:**

1. Press the release button.
2. Extend the locking lever.
3. Pull the locking lever in the direction of the arrow to remove the HDD tray.
4. Slide the hard disk into the HDD tray.
5. Install 4 screws to secure the hard drive to the HDD tray.
6. Reinsert the HDD tray into the slot and close the locking lever.

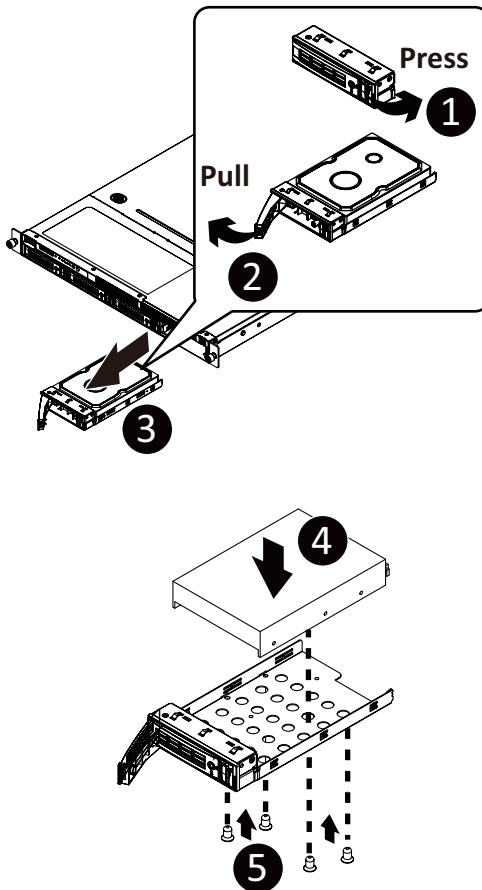

## 3-7 Installing and Removing an M.2 Solid State Drive

Follow these instructions to install an optional M.2 solid state drive (SSD):

1. Loosen and remove the thumbscrew on the riser bracket.
2. Lift up the screw securing the riser bracket.
3. Loosen and remove the thumbscrew on the M.2 heat sink. Remove the M.2 heat sink and warning mylar.
4. Loosen and remove the stand-off.
5. Place the stand off to the dedicated position.  
**NOTE:** The position of the screw will depend on the size of the SSD. Refer to the second image below for proper placement.
6. Place the solid state drive into the M.2 connector.
7. Secure the solid state drive to the motherboard with a single screw.  
**NOTE:** The position of the screw will depend on the size of the SSD. Refer to the second image below for proper placement.
8. Reverse steps 5-7 to remove the solid state drive.

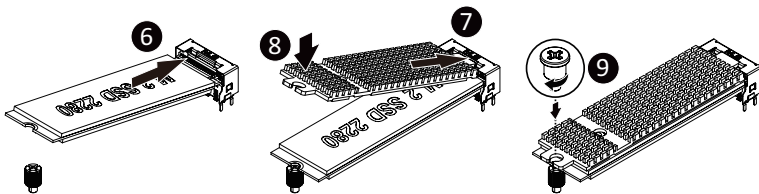
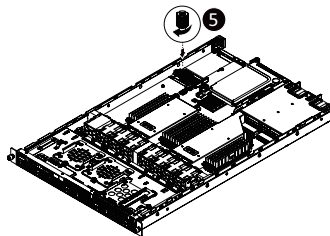
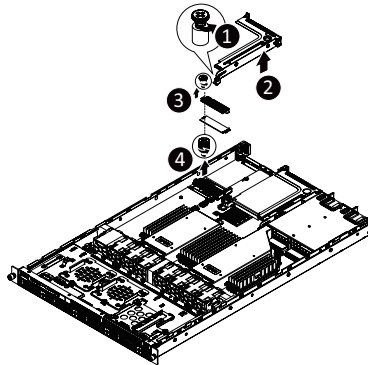

## 3-8 Replacing the Fan Assembly

Follow these instructions to replace a fan assembly:

1. Flip the latches on the top of the fan outwards.
2. Using the latches, lift up the fan assembly from the chassis.
3. Reverse the previous steps to install the replacement fan assembly.

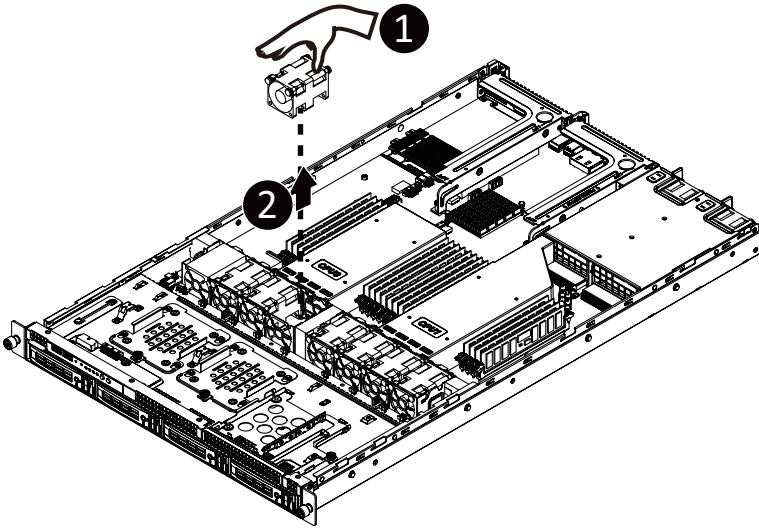

## 3-9 Removing and Installing the Power Supply



Before you remove or install the power supply unit:

- Make sure the system is not turned on or connected to AC power.

**Follow these instructions to replace the power supply:**

1. Press the retaining clip on the left side of the power supply unit along the direction of the arrow.
2. Pull the power supply handle at the same time and pull out the power supply unit.
3. Insert the replacement power supply unit firmly into the chassis. Connect the AC power cord to the replacement power supply.
4. Repeat steps 1-3 for replacement of the second power supply.

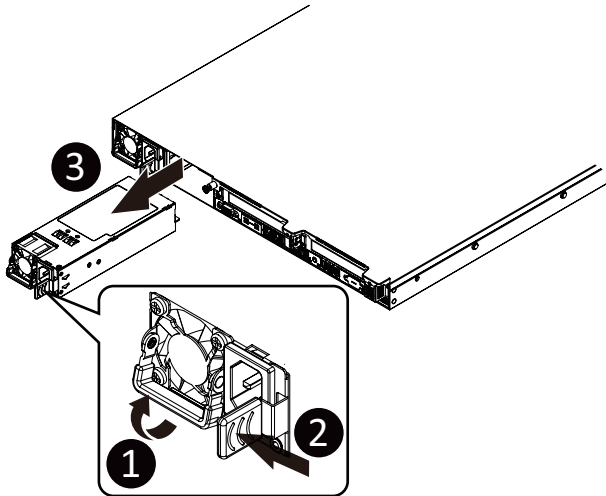

### 3-10 Cable Routing

Front Switch Cable/Front LED Cable

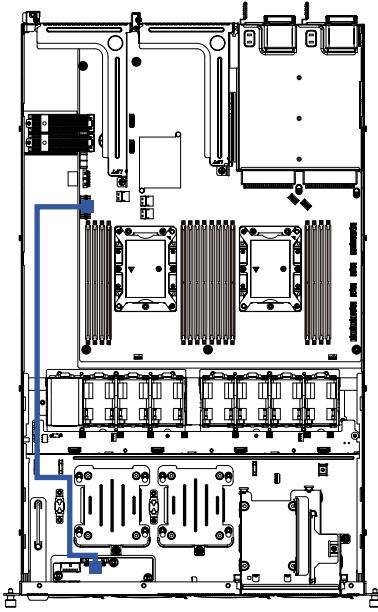

Front Panel USB 3.0 Cable

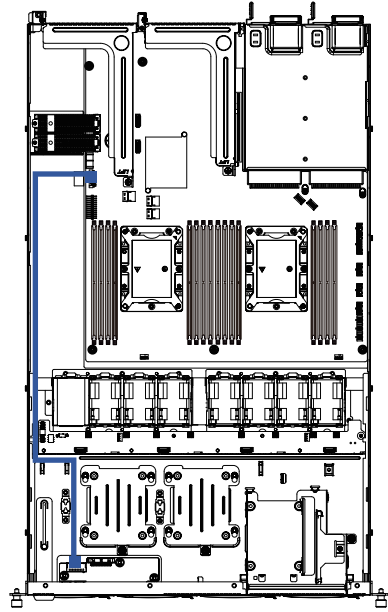

HDD Back Panel Board Power Cable

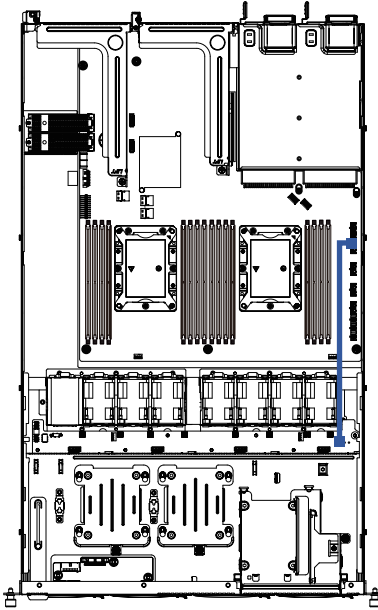

HDD Back Panel Board Signal Cable

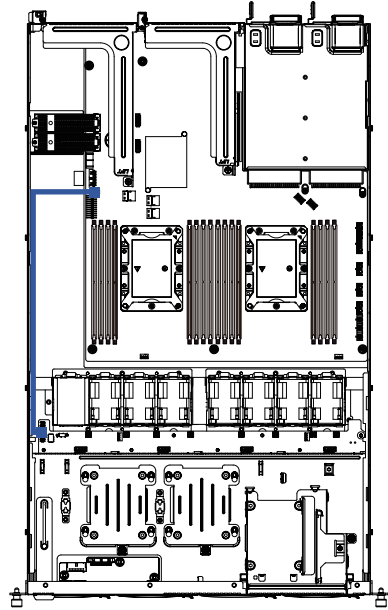

**On-Board SATA to HDD Back Plane Board System Fan Cable  
Cable**

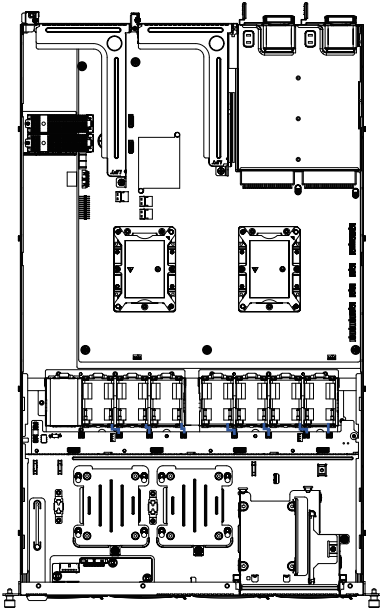
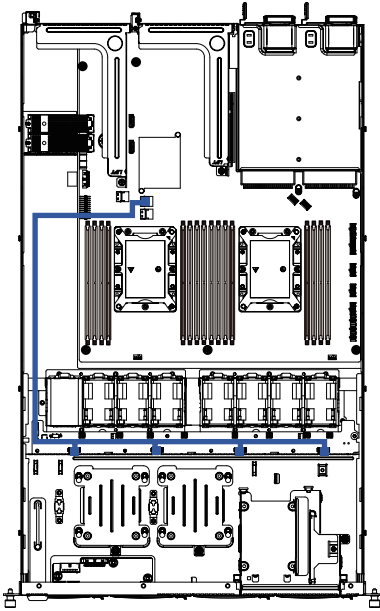

# Chapter 4 Motherboard Components

## 4-1 Motherboard Components

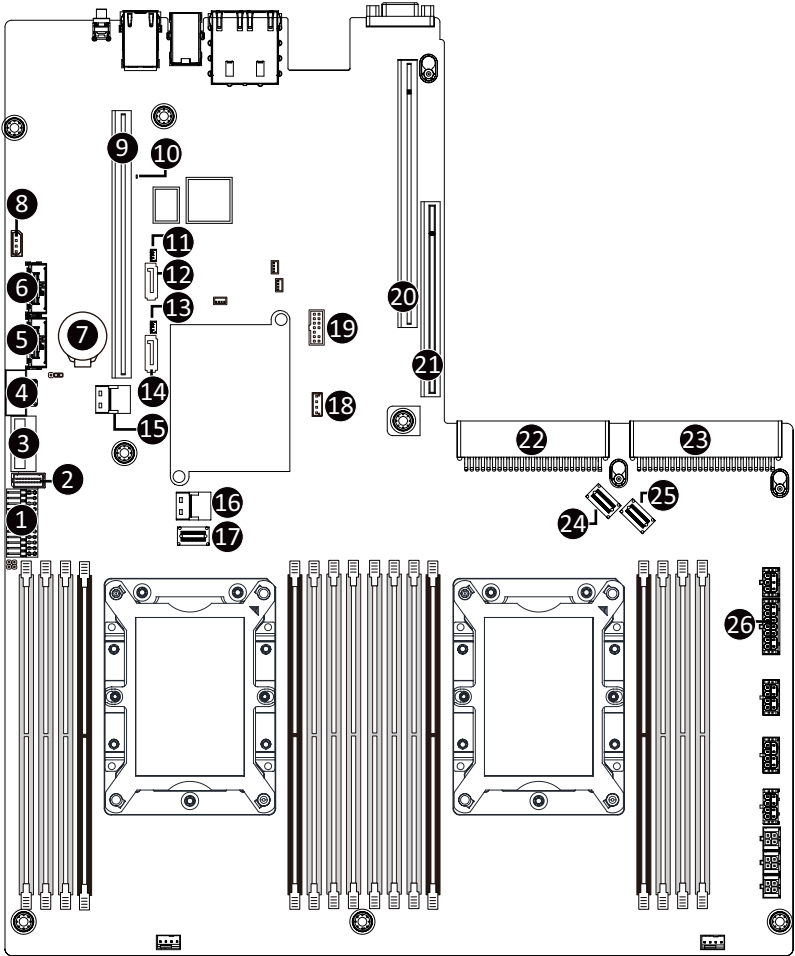

Item	Description
1	Front Panel Connector
2	HDD Back Plane Board Connector
3	Front panel USB 3.0 connector
4	Serial Port cable Connector
5	M.2 Connector (PCIe3 x4, Supports NGFF-2280)
6	M.2 Connector (PCIe3 x4, Supports NGFF-2280)

7	System Battery
8	IPMB Connector
9	Riser Connector #1
10	BMC Firmware Readiness LED
11	SATA DOM Support Power Connector (for sSATA connector #5)
12	sSATA Connector #5
13	SATA DOM Support Power Connector (for sSATA connector #4)
14	sSATA Connector #4
15	Slimline SAS Connector (SSATA0/HDD 8-11)
16	Slimline SAS Connector (SATA0/HDD 0-3)
17	Slimline SAS Connector (SATA1/ HDD 4-7)
18	VROC Upgrade Module (Function available on selected models)
19	TPM Module Connector
20	Riser Connector #2
21*	Riser Connector #3 (Function available on selected models)
22	Power Supply Connector#1 (Primary)
23	Power Supply Connector#2 (Secondary)
24	Slimline SAS Connector (U2_0/Function available on selected models)
25	Slimline SAS Connector (U2_1/Function available on selected models)
26	2 x 9 Pin HDD Back Plane Board Power Connector



# 4-2 Jumper Settings

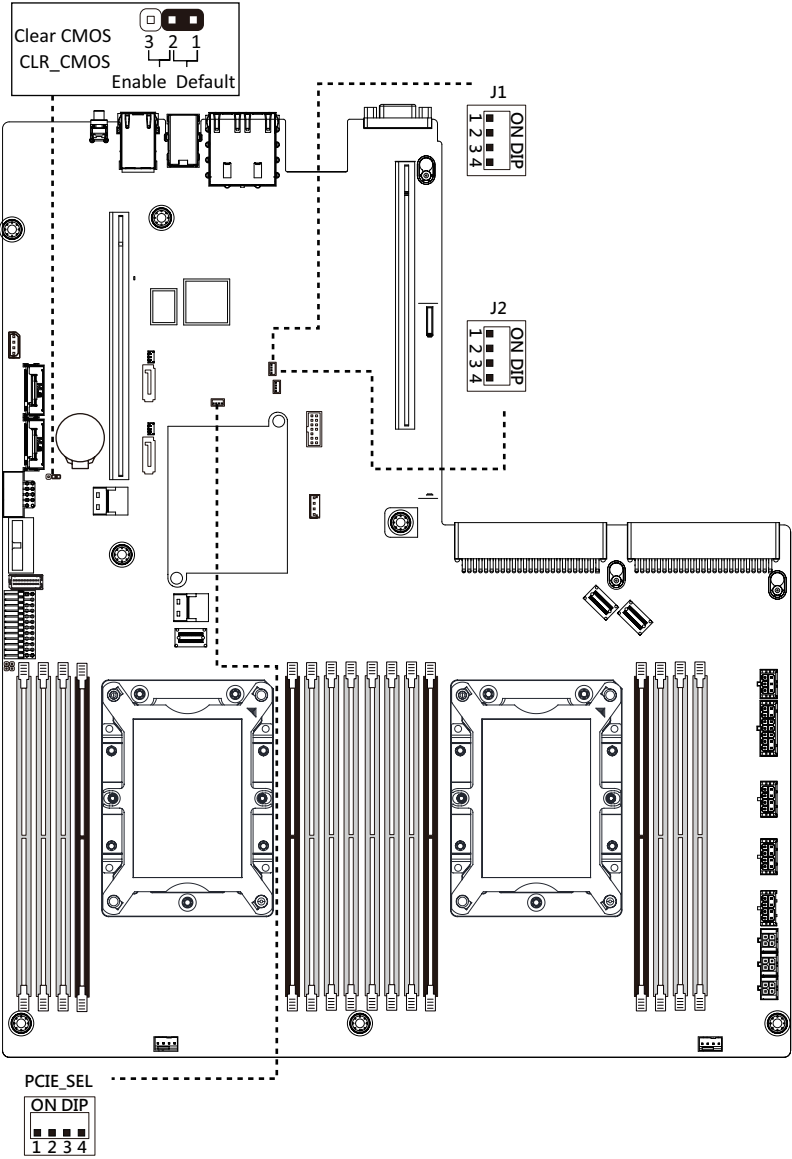

J1		ON	OFF
1	HSMB_SEL	BIOS Defined	
2	PMBUS_SEL	BIOS Defined	
3	S3_MASK	Stop initial power on when BMC is not ready	Normal [Default]
4	DB_PLD	CPLD debug mode	Normal [Default]

J2		ON	OFF
1	ME_UPDATE	Force ME update	Normal [Default]
2	BIOS_PWD	Clear supervisor password	Normal [Default]
3	BIOS_RCVR	BIOS recovery mode	Normal [Default]
4	ME_RCVR	ME recovery mode	Normal [Default]

PCIE_SEL		CPU1_PCIE_2A		
1	2	3	Setting	
OFF	OFF	OFF	X16	
OFF	OFF	ON	X8X4X4	✓
OFF	ON	OFF	X4X4X4X4	
ON	OFF	OFF	X8X8	

PCIE_SEL	U2 SETTING
4	Setting
OFF	PCIE
ON	NVME

## Chapter 5 BIOS Setup

BIOS (Basic Input and Output System) records hardware parameters of the system in the EFI on the motherboard. Its major functions include conducting the Power-On Self-Test (POST) during system startup, saving system parameters and loading operating system, etc. BIOS includes a BIOS Setup program that allows the user to modify basic system configuration settings or to activate certain system features. When the power is turned off, the battery on the motherboard supplies the necessary power to the CMOS to keep the configuration values in the CMOS.

To access the BIOS Setup program, press the <DEL> key during the POST when the power is turned on.



- BIOS flashing is potentially risky, if you do not encounter problems of using the current BIOS version, it is recommended that you don't flash the BIOS. To flash the BIOS, do it with caution. Inadequate BIOS flashing may result in system malfunction.
- It is recommended that you not alter the default settings (unless you need to) to prevent system instability or other unexpected results. Inadequately altering the settings may result in system's failure to boot. If this occurs, try to clear the CMOS values and reset the board to default values. (Refer to the **Exit** section in this chapter or introductions of the battery/clearing CMOS jumper in Chapter 1 for how to clear the CMOS values.)

### BIOS Setup Program Function Keys

<<-><->>	Move the selection bar to select the screen
<↑><↓>	Move the selection bar to select an item
<+>	Increase the numeric value or make changes
<->	Decrease the numeric value or make changes
<Enter>	Execute command or enter the submenu
<Esc>	Main Menu: Exit the BIOS Setup program Submenus: Exit current submenu
<F1>	Show descriptions of general help
<F3>	Restore the previous BIOS settings for the current submenus
<F9>	Load the Optimized BIOS default settings for the current submenus
<F10>	Save all the changes and exit the BIOS Setup program

- **Main**

This setup page includes all the items in standard compatible BIOS.

- **Advanced**

This setup page includes all the items of AMI BIOS special enhanced features.

(ex: Auto detect fan and temperature status, automatically configure hard disk parameters.)

- **Chipset**

This setup page includes all the submenu options for configuring the function of processor, network, North Bridge, South Bridge, and System event logs.

- **Server Management**

Server additional features enabled/disabled setup menus.

- **Security**

Change, set, or disable supervisor and user password. Configuration supervisor password allows you to restrict access to the system and BIOS Setup.

A supervisor password allows you to make changes in BIOS Setup.

A user password only allows you to view the BIOS settings but not to make changes.

- **Boot**

This setup page provides items for configuration of boot sequence.

- **Save & Exit**

Save all the changes made in the BIOS Setup program to the CMOS and exit BIOS Setup. (Pressing <F10> can also carry out this task.)

Abandon all changes and the previous settings remain in effect. Pressing <Y> to the confirmation message will exit BIOS Setup. (Pressing <Esc> can also carry out this task.)

# 5-1 The Main Menu

Once you enter the BIOS Setup program, the Main Menu (as shown below) appears on the screen. Use arrow keys to move among the items and press <Enter> to accept or enter other sub-menu.

## Main Menu Help

The on-screen description of a highlighted setup option is displayed on the bottom line of the Main Menu.

## Submenu Help

While in a submenu, press <F1> to display a help screen (General Help) of function keys available for the menu. Press <Esc> to exit the help screen. Help for each item is in the Item Help block on the right side of the submenu.



- When the system is not stable as usual, select the **Restore Defaults** item to set your system to its defaults.
- The BIOS Setup menus described in this chapter are for reference only and may differ by BIOS version.

```
Aptio Setup Utility - Copyright (C) 2019 American Megatrends, Inc.
Main Advanced Chipset Server Mgmt Security Boot Save & Exit

BIOS Information
Project Name                MR51-CE0-00
Project Version             R01
Build Date and Time         03/08/2019 10:44:10

BMC Information
BMC Firmware Version        02.78

Processor Information
CPU 0 Brand String          Intel(R) Xeon(R) Gold 522...
CPU 1 Brand String          Intel(R) Xeon(R) Gold 522...
Max CPU Speed               2200 MHz
CPU Signature               50655
Processor Core              36
Microcode Patch             03000010

Platform Information
Processor                   CLX A0
PCH                          LBG QS/PRQ - 1G - S1
RC Revision                  0575.D01

Memory Information
Total Memory                 1048576 MB
Memory Frequency             2666 MHz

++: Select Screen
↑↓: Select Item
Enter: Select
+/-: Change Opt.
F1: General Help
F3: Previous Values
F9: Optimized Defaults
F10: Save & Exit
ESC: Exit

Version 2.20.1274. Copyright (C) 2019 American Megatrends, Inc. 84
```

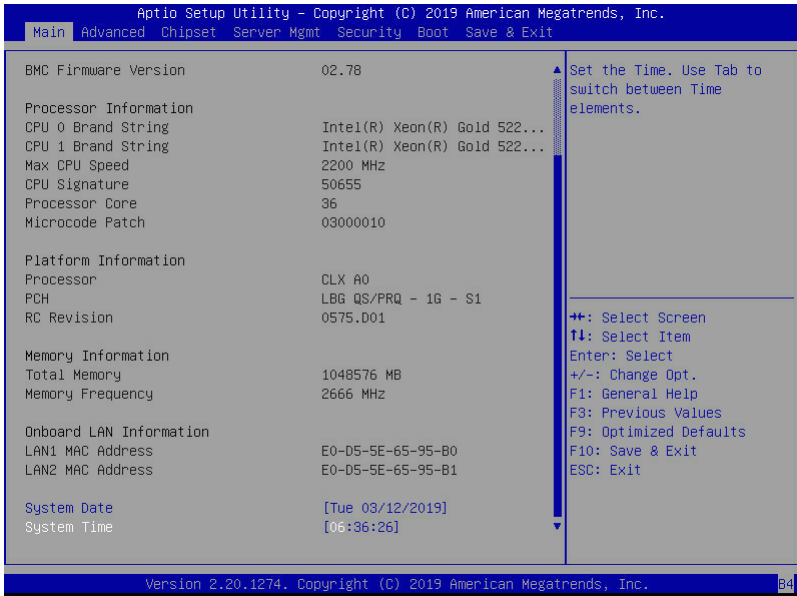

Parameter	Description
<b>BIOS Information</b>	
Project Name	Displays the project name information.
Project Version	Displays version number of the BIOS setup utility.
Build Date and Time	Displays the date and time when the BIOS setup utility was created.
<b>BMC Information</b>	
BMC Firmware Version	Displays BMC firmware version information.
<b>Processor Information</b>	
CPU 0 Brand String / CPU 1 Brand String / Max CPU Speed / CPU Signature / Processor Core / Microcode Patch	Displays the technical specifications for the installed processor(s).
<b>Platform Information</b>	
Processor / PCH / RC Revision	Displays the information for the installed platform.
<b>Memory Information</b>	
Total Memory <sup>(Note)</sup>	Displays the total memory size of the installed memory.
Memory Frequency <sup>(Note)</sup>	Displays the frequency information of the installed memory.

(Note) This section will display capacity and frequency information of the memory that the customer has installed.

Parameter	Description
Onboard LAN Information	
LAN1 MAC Address <sup>(Note)</sup>	Displays LAN MAC address information.
LAN2 MAC Address <sup>(Note)</sup>	Displays LAN MAC address information.
System Date	Sets the date following the weekday-month-day-year format.
System Time	Sets the system time following the hour-minute-second format.

(Note) The number of LAN ports listed will depend on the motherboard / system model.

# 5-2 Advanced Menu

The Advanced menu display submenu options for configuring the function of various hardware components. Select a submenu item, then press <Enter> to access the related submenu screen.

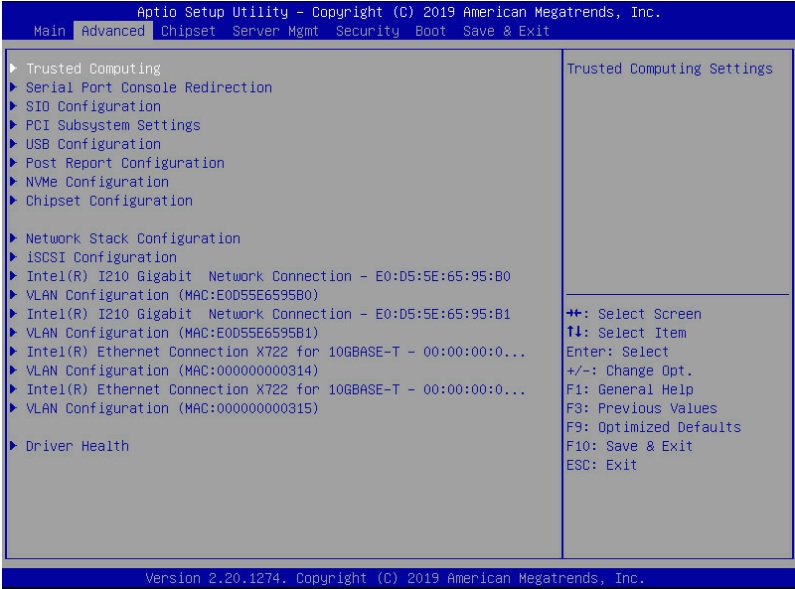



## 5-2-1 Trusted Computing

Aptio Setup Utility - Copyright (C) 2019 American Megatrends, Inc.

Advanced

<p>Configuration</p> <p>Security Device Support                    [Enable]</p> <p>Disable Block Sid                         [Disabled]</p> <p>NO Security Device Found</p>	<p>Enables or Disables BIOS support for security device. O.S. will not show Security Device. TCG EFI protocol and INT1A interface will not be available.</p> <hr/> <p>           ++: Select Screen            ↑↓: Select Item            Enter: Select            +/-: Change Opt.            F1: General Help            F3: Previous Values            F9: Optimized Defaults            F10: Save &amp; Exit            ESC: Exit         </p>
---	---

Version 2.20.1274. Copyright (C) 2019 American Megatrends, Inc.

Parameter	Description
Configuration	
Security Device Support	Select Enabled to activate TPM support feature. Options available: Enabled/Disabled. Default setting is <b>Disabled</b> .
Disable Block Sid	Options available: Enabled/Disabled. Default setting is <b>Disabled</b> .

## 5-2-2 Serial Port Console Redirection

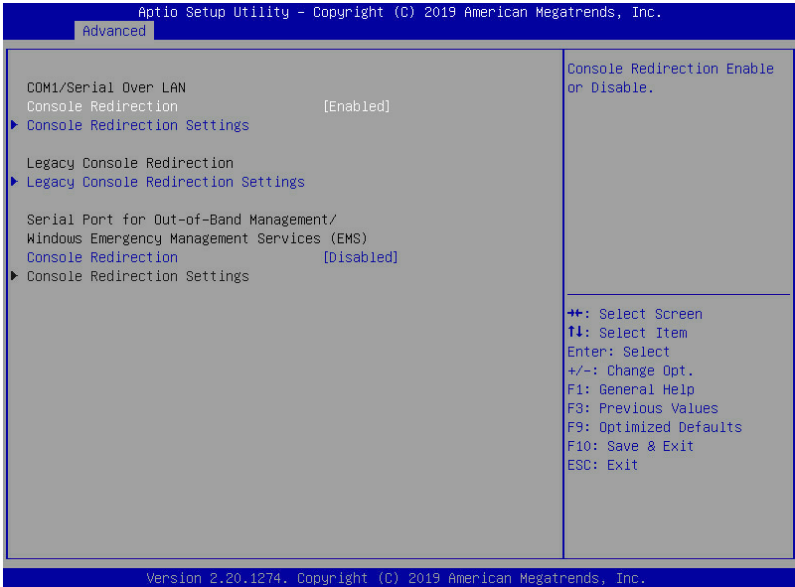

Parameter	Description
COM1 Serial Over LAN Console Redirection <sup>(Note)</sup>	Select whether to enable console redirection for specified device. Console redirection enables the users to manage the system from a remote location. Options available: Enabled/Disabled. Default setting is <b>Disabled</b> .
Legacy Console Redirection	Selects a COM port for Legacy serial redirection. The options are dependent on the available COM ports.
Serial Port for Out-of-Band Management / Windows Emergency Management Services (EMS) Console Redirection <sup>(Note)</sup>	Selects a COM port for EMS console redirection. EMS console redirection allows the user to configure Console Redirection Settings to support Out-of-Band Serial Port management. Options available: Enabled/Disabled. Default setting is <b>Disabled</b> .
COM1 Serial LAN/Legacy/Serial Port for Out-of-Band EMS Console Redirection Settings	Press [Enter] to configure advanced items. <b>Please note that this item is configurable when COM1 Serial Over LAN/Serial Port for Out-of-Band Management EMS Console Redirection is set to Enabled.</b> <ul style="list-style-type: none"> <li>◆ Terminal Type           <ul style="list-style-type: none"> <li>– Selects a terminal type to be used for console redirection.</li> <li>– Options available: VT100/VT100+/ANSI /VT-UTF8. Default setting is <b>ANSI</b>.</li> </ul> </li> </ul>

(Note) Advanced items prompt when this item is defined.

Parameter	Description
COM1 Serial LAN/Legacy/ Serial Port for Out-of-Band EMS Console Redirection Settings (continued)	<ul style="list-style-type: none"> <li>◆ Bits per second <ul style="list-style-type: none"> <li>– Selects the transfer rate for console redirection.</li> <li>– Options available: 9600/19200/38400/57600/115200. Default setting is <b>115200</b>.</li> </ul> </li> <li>◆ Data Bits <ul style="list-style-type: none"> <li>– Selects the number of data bits used for console redirection.</li> <li>– Options available: 7/8. Default setting is <b>8</b>.</li> </ul> </li> <li>◆ Parity <ul style="list-style-type: none"> <li>– A parity bit can be sent with the data bits to detect some transmission errors.</li> <li>– Even: parity bit is 0 if the num of 1's in the data bits is even.</li> <li>– Odd: parity bit is 0 if num of 1's in the data bits is odd.</li> <li>– Mark: parity bit is always 1. Space: Parity bit is always 0.</li> <li>– Mark and Space Parity do not allow for error detection.</li> <li>– Options available: None/Even/Odd/Mark/Space. Default setting is <b>None</b>.</li> </ul> </li> <li>◆ Stop Bits <ul style="list-style-type: none"> <li>– Stop bits indicate the end of a serial data packet. (A start bit indicates the beginning). The standard setting is 1 stop bit. Communication with slow devices may require more than 1 stop bit.</li> <li>– Options available: 1/2. Default setting is <b>1</b>.</li> </ul> </li> <li>◆ Flow Control <ul style="list-style-type: none"> <li>– Flow control can prevent data loss from buffer overflow. When sending data, if the receiving buffers are full, a 'stop' signal can be sent to stop the data flow. Once the buffers are empty, a 'start' signal can be sent to re-start the flow. Hardware flow control uses two wires to send start/stop signals.</li> <li>– Options available: None/Hardware RTS/CTS. Default setting is <b>None</b>.</li> </ul> </li> <li>◆ VT-UTF8 Combo Key Support <ul style="list-style-type: none"> <li>– Enable/Disable the VT-UTF8 Combo Key Support.</li> <li>– Options available: Enabled/Disabled. Default setting is <b>Enabled</b>.</li> </ul> </li> <li>◆ Recorder Mode<sup>(Note)</sup> <ul style="list-style-type: none"> <li>– When this mode enabled, only texts will be send. This is to capture Terminal data.</li> <li>– Options available: Enabled/Disabled. Default setting is <b>Disabled</b>.</li> </ul> </li> <li>◆ Resolution 100x31<sup>(Note)</sup> <ul style="list-style-type: none"> <li>– Enable/Disable extended terminal resolution.</li> <li>– Options available: Enabled/Disabled. Default setting is <b>Enabled</b>.</li> </ul> </li> </ul>

(Note) Advanced items prompt when this item is defined.

Parameter	Description
COM1/Serial LAN/Legacy/ Serial Port for Out-of-Band EMS Console Redirection Settings (continued)	<ul style="list-style-type: none"> <li>◆ Legacy OS Redirection Resolution<sup>(Note)</sup> <ul style="list-style-type: none"> <li>– Specifies the number of Rows and Columns supported for the Legacy OS redirection.</li> <li>– Options available: 80x24/80x25. Default setting is <b>80x24</b>.</li> </ul> </li> <li>◆ Putty KeyPad<sup>(Note)</sup> <ul style="list-style-type: none"> <li>– Selects FunctionKey and KeyPad on Putty.</li> <li>– Options available: T100/LINUX/XTERMR6/SCO/ESCN/VT400. Default setting is <b>VT100</b>.</li> </ul> </li> <li>◆ Redirection After BIOS POST<sup>(Note)</sup> <ul style="list-style-type: none"> <li>– This item allows user to enable console redirection after OS has loaded.</li> <li>– Options available: Always Enable/Boot Loader. Default setting is Always <b>Enable</b>.</li> </ul> </li> <li>◆ Legacy Console Redirection Settings <ul style="list-style-type: none"> <li>– Selects a COM port to display redirection of Legacy OS and Legacy OPROM Messages.</li> <li>– Options available: COM1/Serial Over LAN. Default setting is <b>COM1</b>.</li> </ul> </li> <li>◆ Out-of-Band Mgmt Port <ul style="list-style-type: none"> <li>– Microsoft Windows Emergency Management Service (EMS) allows for remote management of a Windows Server OS through a serial port.</li> <li>– Options available: COM1/COM2 Serial Over LAN. Default setting is <b>COM1</b>.</li> </ul> </li> </ul>

(Note) Advanced items prompt when this item is defined.

### 5-2-3 SIO Configuration

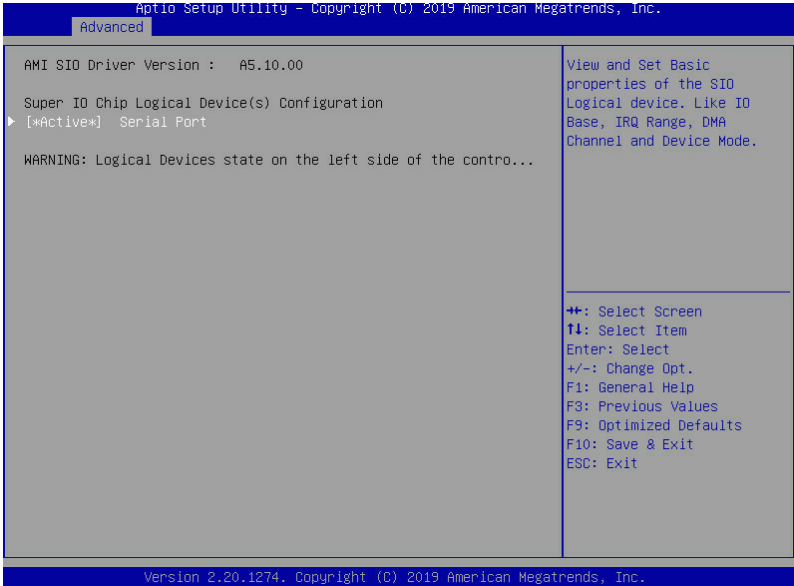

Parameter	Description
AMI SIO Driver Version	Displays the AMI SIO driver version information.
Super IO Chip Logical Device(s) Configuration	
[*Active*] Serial Port	<p>Press [Enter] to configure advanced items.</p> <ul style="list-style-type: none"> <li>◆ Use This Device <ul style="list-style-type: none"> <li>– When set to Enabled allows you to configure the serial port settings. When set to Disabled, displays no configuration for the serial port.</li> <li>– Options available: Enabled/Disabled. Default setting is <b>Enabled</b>.</li> </ul> </li> <li>◆ Current: <ul style="list-style-type: none"> <li>– Displays the serial port base I/O address and IRQ.</li> </ul> </li> <li>◆ Possible: <ul style="list-style-type: none"> <li>– Configures the serial port base I/O address and IRQ.</li> </ul> </li> </ul> <p>Use Automatic Settings  IO=3F8h; IRQ=4; DMA;  IO=3F8h; IRQ=3, 4, 5, 7, 9, 10, 11, 12; DMA;  IO=2F8h; IRQ=3, 4, 5, 7, 9, 10, 11, 12; DMA;  IO=3E8h; IRQ=3, 4, 5, 7, 9, 10, 11, 12; DMA;  IO=2E8h; IRQ=3, 4, 5, 7, 9, 10, 11, 12; DMA;  Default setting is <b>Use Automatic Settings</b>.</p>

## 5-2-4 PCI Subsystem Settings

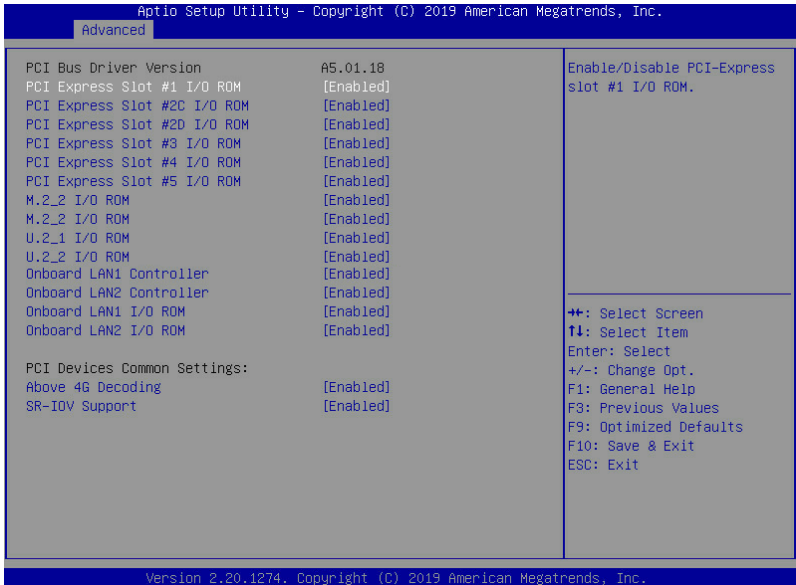

Parameter	Description
PCI Bus Driver Version	Displays the PCI Bus Driver version information.
PCI Express Slot # I/O ROM <sup>Note1)</sup>	When enabled, this setting will initialize the device expansion ROM for the related PCI-E slot. Options available: Enabled/Disabled. Default setting is <b>Enabled</b> .
M2_2 I/O ROM	When enabled, this setting will initialize the device expansion ROM for the related M.2 device. Options available: Enabled/Disabled. Default setting is <b>Enabled</b> .
U2_1 I/O ROM U2_2 I/O ROM	When enabled, this setting will initialize the device expansion ROM for the related U.2 device. Options available: Enabled/Disabled. Default setting is <b>Enabled</b> .
Onboard LAN1 / LAN2 Controller <sup>Note2)</sup>	Enable/Disable the onboard LAN1 / LAN2 devices. Options available: Enabled/Disabled. Default setting is <b>Enabled</b> .
Onboard LAN1 / LAN2 I/O ROM <sup>Note2)</sup>	Enable/Disable the onboard LAN1 / LAN2 devices, and initializes device expansion ROM. Options available: Enabled/Disabled. Default setting is <b>Enabled</b> .

(Note1) This section is dependent on the available PCIe Slot.

(Note2) This section is dependent on the available LAN controller.

PCI Devices Common Settings	
Above 4G Decoding	Enable/Disable memory mapped I/O to 4GB or greater address space (Above 4G Decoding). Options available: Enabled/Disabled. Default setting is <b>Enabled</b> .
SR-IOV Support	If the system has SR-IOV capable PCIe devices, this item Enable/Disable Single Root IO Virtualization Support. Options available: Enabled/Disabled. Default setting is <b>Enabled</b> .

## 5-2-5 USB Configuration



Parameter	Description
USB Configuration	
USB Devices:	Displays the USB devices connected to the system.
XHCI Hand-off	Enable/Disable the XHCI (USB 3.0) Hand-off support. Options available: Enabled/Disabled. Default setting is <b>Enabled</b> .
USB Mass Storage Driver Support <sup>(Note)</sup>	Enable/Disable the USB Mass Storage Driver Support. Options available: Enabled/Disabled. Default setting is <b>Enabled</b> .
Port 60/64 Emulation	Enables the I/O port 60h/64h emulation support. This should be enabled for the complete USB Keyboard Legacy support for non-USB aware OS. Options available: Enabled/Disabled. Default setting is <b>Enabled</b> .

(Note) This item is present only if you attach USB devices.



## 5-2-6 Post Report Configuration

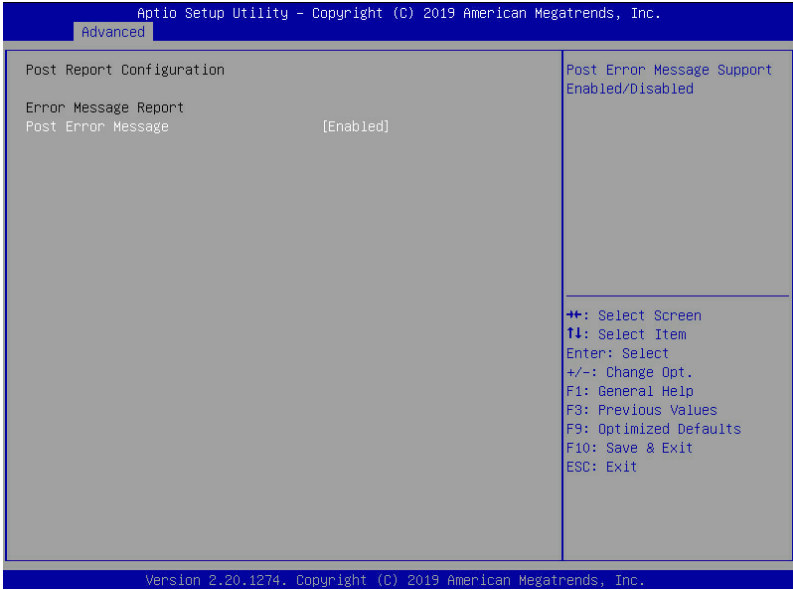

Parameter	Description
Post Report Configuration	
Error Message Report	
Post Error Message	Enable/Disable the POST Error Message support. Options available: Enabled/Disabled. Default setting is <b>Enabled</b> .

## 5-2-7 NVMe Configuration

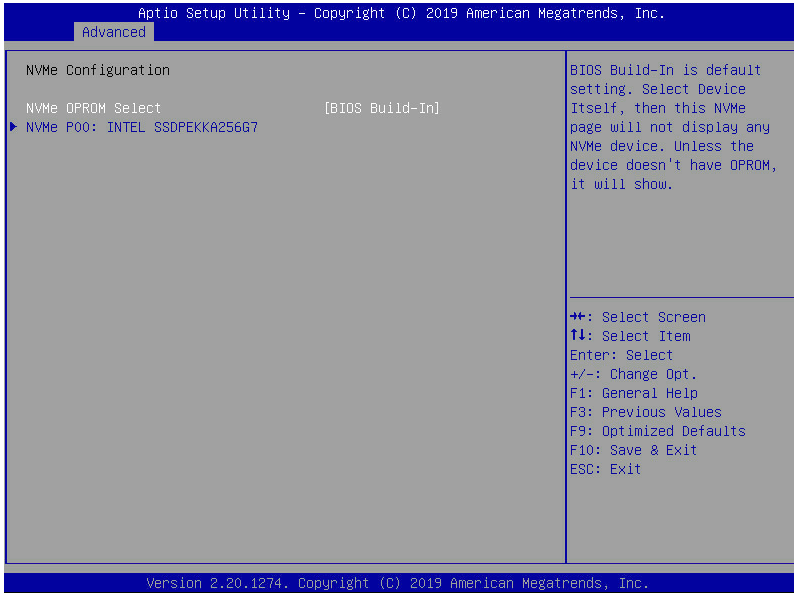

Parameter	Description
NVMe Configuration	Displays the NVMe devices connected to the system.
NVMe OPROM Select	Options available: BIOS Build-In/NVMe Device. Default setting is <b>BIOS Build-In</b> .

## 5-2-8 Chipset Configuration



Parameter	Description
Restore on AC Power Loss <sup>(Note)</sup>	Defines the power state to resume to after a system shutdown that is due to an interruption in AC power. When set to Last State, the system will return to the active power state prior to shutdown. When set to Power Off, the system remains off after power shutdown. Options available: Last State/Power Off/Power On. The default setting depends on the BMC setting.
Skip Above 4G Decoding for VGA	Enable/Disable 64bit capable devices to be decoded in Skip Above 4G Address VGA Space. Options available: Enabled/Disabled. Default setting is <b>Disabled</b> .
P2P Bridge IO Size	Sets P2P Bridge IO aligned to the size. Options available: 0x100/0x150/0x1000. Default setting is <b>0x1000</b> .
Chassis Opened Warning	Enable/Disable the chassis intrusion alter function. Options available: Enabled/Disabled/Clear. Default setting is <b>Disabled</b> .

(Note) When the power policy is controlled by BMC, please wait for 15-20 seconds for BMC to save the last power state.

## 5-2-9 Network Stack Configuration

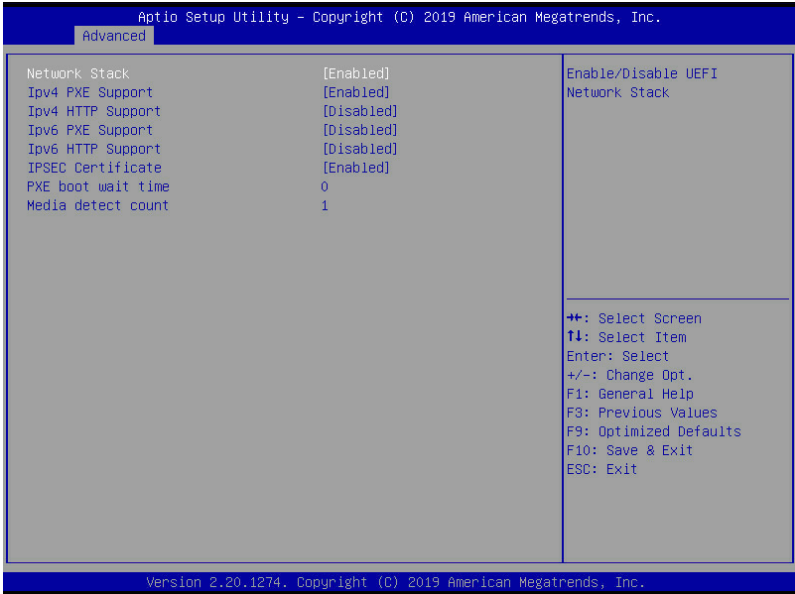

Parameter	Description
Network Stack	Enable/Disable the UEFI network stack. Options available: Enabled/Disabled. Default setting is <b>Enabled</b> .
Ipv4 PXE Support <sup>(Note)</sup>	Enable/Disable the Ipv4 PXE feature. Options available: Enabled/Disabled. Default setting is <b>Enabled</b> .
Ipv4 HTTP Support <sup>(Note)</sup>	Enable/Disable the Ipv4 HTTP feature. Options available: Enabled/Disabled. Default setting is <b>Disabled</b> .
Ipv6 PXE Support <sup>(Note)</sup>	Enable/Disable the Ipv6 PXE feature. Options available: Enabled/Disabled. Default setting is <b>Disabled</b> .
Ipv6 HTTP Support <sup>(Note)</sup>	Enable/Disable the Ipv6 HTTP feature. Options available: Enabled/Disabled. Default setting is <b>Disabled</b> .
PXE boot wait time <sup>(Note)</sup>	Press the <+> / <-> keys to increase or decrease the desired values.
Media detect count <sup>(Note)</sup>	Press the <+> / <-> keys to increase or decrease the desired values.

(Note) This item appears when **Network Stack** is set to **Enabled**.

## 5-2-10 iSCSI Configuration

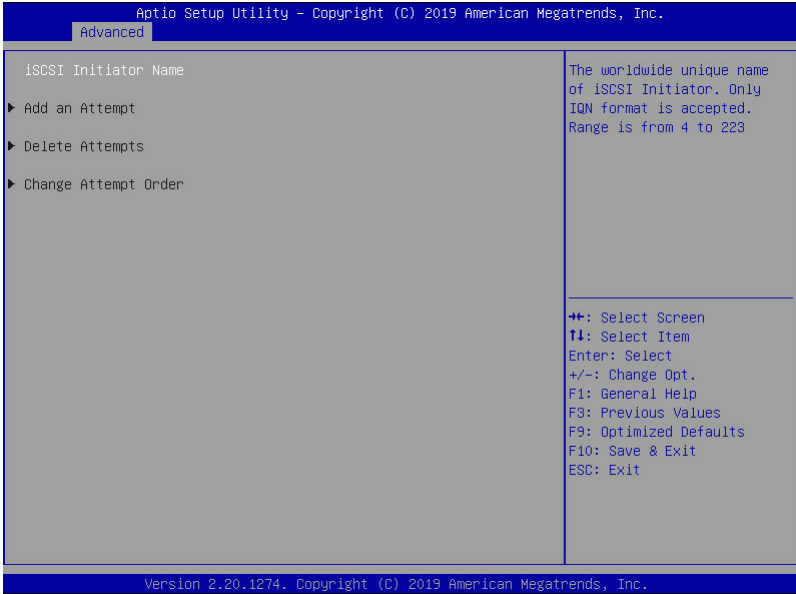

Parameter	Description
iSCSI Initiator Name	
Add an Attempt	Press [Enter] to configure advanced items.
Delete Attempts	Press [Enter] to configure advanced items.
Change Attempt Order	Press [Enter] to configure advanced items.

## 5-2-11 Intel(R) I210 Gigabit Network Connection

Aptio Setup Utility - Copyright (C) 2019 American Megatrends, Inc.

Advanced

<p>▶ NIC Configuration</p> <p>Blink LEDs <span style="float: right;">0</span></p> <p>UEFI Driver <span style="float: right;">Intel(R) PRO/1000 7.5.11 ...</span></p> <p>Adapter PBA <span style="float: right;">130916-002</span></p> <p>Device Name <span style="float: right;">Intel(R) I210 Gigabit Ne...</span></p> <p>Chip Type <span style="float: right;">Intel i210</span></p> <p>PCI Device ID <span style="float: right;">1533</span></p> <p>PCI Address <span style="float: right;">02:00:00</span></p> <p>Link Status <span style="float: right;">[Connected]</span></p> <p>MAC Address <span style="float: right;">E0:D5:5E:65:95:B0</span></p> <p>Virtual MAC Address <span style="float: right;">00:00:00:00:00:00</span></p>	<p>Click to configure the network device port.</p> <hr/> <p>           ++: Select Screen            ↑↓: Select Item            Enter: Select            +/-: Change Opt.            F1: General Help            F3: Previous Values            F9: Optimized Defaults            F10: Save &amp; Exit            ESC: Exit         </p>
--	---

Version 2.20.1274. Copyright (C) 2019 American Megatrends, Inc.

Aptio Setup Utility - Copyright (C) 2019 American Megatrends, Inc.

Advanced

<p>Link Speed <span style="float: right;">[Auto Negotiated]</span></p> <p>Wake On LAN <span style="float: right;">[Enabled]</span></p>	<p>Specifies the port speed used for the selected boot protocol.</p> <hr/> <p>           ++: Select Screen            ↑↓: Select Item            Enter: Select            +/-: Change Opt.            F1: General Help            F3: Previous Values            F9: Optimized Defaults            F10: Save &amp; Exit            ESC: Exit         </p>
--	---

Version 2.20.1274. Copyright (C) 2019 American Megatrends, Inc.

Parameter	Description
NIC Configuration	<p>Press [Enter] to configure advanced items.</p> <ul style="list-style-type: none"> <li>◆ Link Speed <ul style="list-style-type: none"> <li>– Allows for automatic link speed adjustment.</li> <li>– Options available: Auto Negotiated/10 Mbps Half/10 Mbps Full/100 Mbps Half/100 Mbps Full. Default setting is <b>Auto Negotiated</b>.</li> </ul> </li> <li>◆ Wake On LAN <ul style="list-style-type: none"> <li>– Enables power on of the system via LAN. Note that configuring Wake on LAN in the operating system does not change the value of this setting, but does override the behavior of Wake on LAN in OS controlled power states.</li> <li>– Options available: Enabled/Disabled. Default setting is <b>Enabled</b>.</li> </ul> </li> </ul>
Blink LEDs	Identifies the physical network port by blinking the associated LED. Press the numeric keys to adjust desired values.
UEFI Driver	Displays the technical specifications for the Network Interface Controller.
Adapter PBA	Displays the technical specifications for the Network Interface Controller.
Device Name	Displays the technical specifications for the Network Interface Controller.
Chip Type	Displays the technical specifications for the Network Interface Controller.
PCI Device ID	Displays the technical specifications for the Network Interface Controller.
PCI Address	Displays the technical specifications for the Network Interface Controller.
Link Status	Displays the technical specifications for the Network Interface Controller.
MAC Address	Displays the technical specifications for the Network Interface Controller.
Virtual MAC Address	Displays the technical specifications for the Network Interface Controller.

## 5-2-12 VLAN Configuration

Aptio Setup Utility - Copyright (C) 2019 American Megatrends, Inc.

Advanced

▶ Enter Configuration Menu

Press ENTER to enter configuration menu for VLAN configuration.

---

++: Select Screen  
↑↓: Select Item  
Enter: Select  
+/-: Change Opt.  
F1: General Help  
F3: Previous Values  
F9: Optimized Defaults  
F10: Save & Exit  
ESC: Exit

Version 2.20.1274. Copyright (C) 2019 American Megatrends, Inc.

Aptio Setup Utility - Copyright (C) 2019 American Megatrends, Inc.

Advanced

Create new VLAN

VLAN ID

Priority 0

Add VLAN

Configured VLAN List

Remove VLAN

VLAN ID of new VLAN or existing VLAN, valid value is 0~4094

---

++: Select Screen  
↑↓: Select Item  
Enter: Select  
+/-: Change Opt.  
F1: General Help  
F3: Previous Values  
F9: Optimized Defaults  
F10: Save & Exit  
ESC: Exit

Version 2.20.1274. Copyright (C) 2019 American Megatrends, Inc.



Parameter	Description
Enter Configuration Menu	<p data-bbox="338 153 674 177">Press [Enter] to configure advanced items.</p> <ul style="list-style-type: none"> <li data-bbox="338 185 519 208">◆ Create new VLAN</li> <li data-bbox="338 216 937 323">◆ VLAN ID <ul style="list-style-type: none"> <li data-bbox="376 239 804 263">– Sets VLAN ID for a new VLAN or an existing VLAN.</li> <li data-bbox="376 271 937 294">– Press the &lt;+&gt; / &lt;-&gt; keys to increase or decrease the desired values.</li> <li data-bbox="376 302 663 326">– The valid range is from 0 to 4094.</li> </ul> </li> <li data-bbox="338 330 937 439">◆ Priority <ul style="list-style-type: none"> <li data-bbox="376 354 852 377">– Sets 802.1Q Priority for a new VLAN or an existing VLAN.</li> <li data-bbox="376 385 937 409">– Press the &lt;+&gt; / &lt;-&gt; keys to increase or decrease the desired values.</li> <li data-bbox="376 417 636 440">– The valid range is from 0 to 7.</li> </ul> </li> <li data-bbox="338 445 905 500">◆ Add VLAN <ul style="list-style-type: none"> <li data-bbox="376 476 905 500">– Press [Enter] to create a new VLAN or update an existing VLAN.</li> </ul> </li> <li data-bbox="338 506 878 586">◆ Configured VLAN List <ul style="list-style-type: none"> <li data-bbox="376 529 607 553">– Enable/Disable the VLAN.</li> <li data-bbox="376 561 878 586">– Options available: Enable/Disable. Default setting is <b>Disable</b>.</li> </ul> </li> <li data-bbox="338 592 732 647">◆ Remove VLAN <ul style="list-style-type: none"> <li data-bbox="376 616 732 647">– Press [Enter] to remove an existing VLAN.</li> </ul> </li> </ul>

## 5-2-13 Driver Health

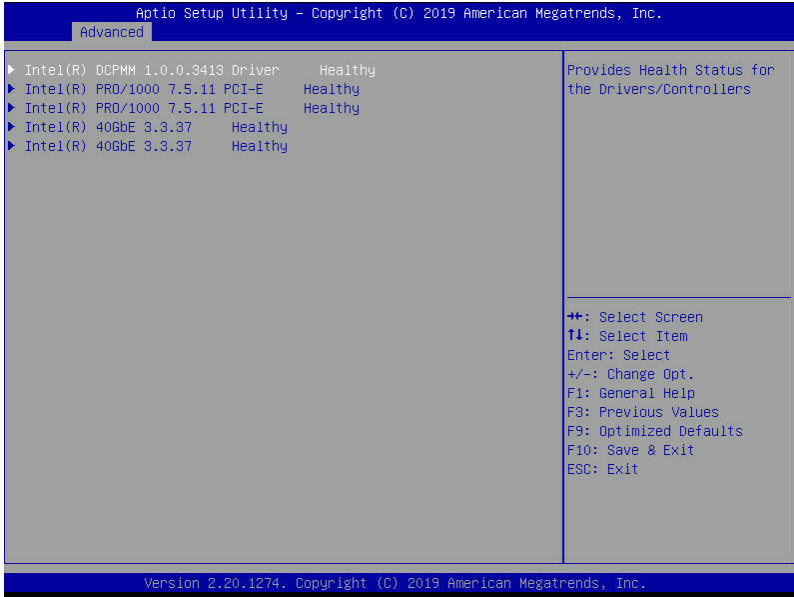

Parameter	Description
Driver Health	Press [Enter] to view the specified driver health status information.

### 5-3 Chipset Setup Menu

Chipset Setup menu displays submenu options for configuring the function of Platform Controller Hub. Select a submenu item, then press <Enter> to access the related submenu screen.

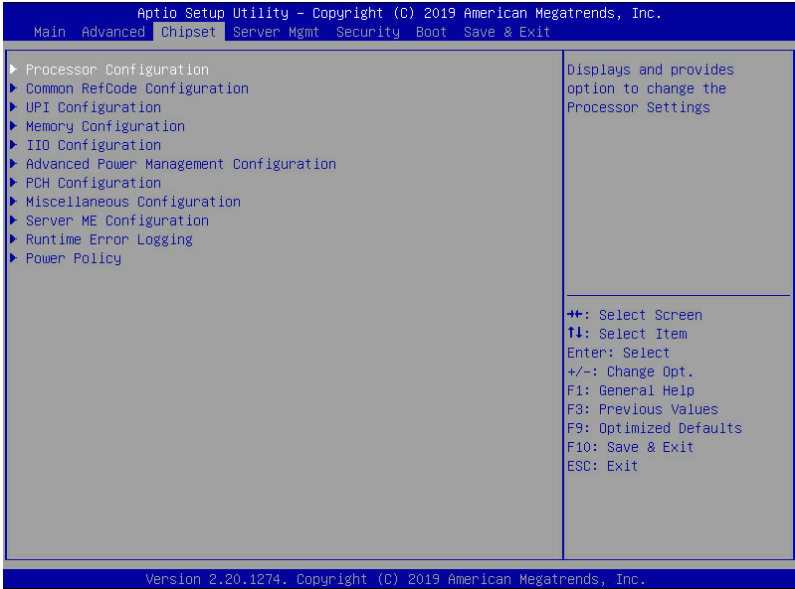

## 5-3-1 Processor Configuration

Aptio Setup Utility - Copyright (C) 2019 American Megatrends, Inc.

Chipset

Processor Configuration		Change Per-Socket Settings
▶ Per-Socket Configuration		
Processor Socket	Socket 0    Socket 1	
Processor ID	00050655*   00050655	
Processor Frequency	2.200GHz   2.200GHz	
Processor Max Ratio	16H   16H	
Processor Min Ratio	0AH   0AH	
Microcode Revision	03000010   03000010	
L1 Cache RAM	64KB   64KB	
L2 Cache RAM	1024KB   1024KB	
L3 Cache RAM	25344KB   25344KB	
Processor 0 Version	Intel(R) Xeon(R) Gold 5 220 CPU @ 2.20GHz	
Processor 1 Version	Intel(R) Xeon(R) Gold 5 220 CPU @ 2.20GHz	
Hyper-Threading [ALL]	[Enable]	++: Select Screen
Enable Intel(R) TXT	[Disable]	↑↓: Select Item
VMX	[Enable]	Enter: Select
Enable SMX	[Disable]	+/-: Change Opt.
Hardware Prefetcher	[Enable]	F1: General Help
L2 RFO Prefetch Disable	[Disable]	F3: Previous Values
Adjacent Cache Prefetch	[Enable]	F9: Optimized Defaults
DCU Streamer Prefetcher	[Enable]	F10: Save & Exit
		ESC: Exit

Version 2.20.1274. Copyright (C) 2019 American Megatrends, Inc.

Aptio Setup Utility - Copyright (C) 2019 American Megatrends, Inc.

Chipset

Per-Socket Configuration		Enable/disable AES-NI support
Processor Socket	Socket 0    Socket 1	
Processor ID	00050655*   00050655	
Processor Frequency	2.200GHz   2.200GHz	
Processor Max Ratio	16H   16H	
Processor Min Ratio	0AH   0AH	
Microcode Revision	03000010   03000010	
L1 Cache RAM	64KB   64KB	
L2 Cache RAM	1024KB   1024KB	
L3 Cache RAM	25344KB   25344KB	
Processor 0 Version	Intel(R) Xeon(R) Gold 5 220 CPU @ 2.20GHz	
Processor 1 Version	Intel(R) Xeon(R) Gold 5 220 CPU @ 2.20GHz	
Hyper-Threading [ALL]	[Enable]	++: Select Screen
Enable Intel(R) TXT	[Disable]	↑↓: Select Item
VMX	[Enable]	Enter: Select
Enable SMX	[Disable]	+/-: Change Opt.
Hardware Prefetcher	[Enable]	F1: General Help
L2 RFO Prefetch Disable	[Disable]	F3: Previous Values
Adjacent Cache Prefetch	[Enable]	F9: Optimized Defaults
DCU Streamer Prefetcher	[Enable]	F10: Save & Exit
DCU IP Prefetcher	[Enable]	ESC: Exit
AES-NI	[Enable]	

Version 2.20.1274. Copyright (C) 2019 American Megatrends, Inc.

Parameter	Description
Processor Configuration	
Pre-Socket Configuration	<p>Press [Enter] to configure advanced items.</p> <ul style="list-style-type: none"> <li>◆ CPU Socket 0/1 Configuration <ul style="list-style-type: none"> <li>– Press [Enter] to configure advanced items.</li> </ul> </li> <li>◆ Core Disable Bitmap(Hex) (for CPU socket 0/1) <ul style="list-style-type: none"> <li>– Number of Cores to enable. 0 means all cores. FFFFFFFF means to disable all cores. The maximum value depends on the number of CPUs available. Press the numeric keys to adjust desired values.</li> </ul> </li> </ul>
Processor Socket / Processor ID / Processor Frequency / Processor Max Ratio / Processor Min Ratio / Microcode Revision / L1 Cache RAM / L2 Cache RAM / L3 Cache RAM / Processor 0 Version / Processor 1 Version	Displays the technical specifications for the installed processor(s).
Hyper-Threading [All]	<p>The Hyper Threading Technology allows a single processor to execute two or more separate threads concurrently. When hyper-threading is enabled, multi-threaded software applications can execute their threads, thereby improving performance.</p> <p>Options available: Enable/Disable. Default setting is <b>Enable</b>.</p>
Enable Intel(R) TXT	<p>Enables or disables the Intel Trusted Execution Technology support function.</p> <p>Options available: Enable/Disable. Default setting is <b>Disable</b>.</p>
VMX (Vanderpool Technology)	<p>Enable/Disable the Vanderpool Technology. This will take effect after rebooting the system.</p> <p>Options available: Enable/Disable. Default setting is <b>Enable</b>.</p>
Enable SMX	<p>Enable/Disable the Secure Mode Extensions (SMX) support function.</p> <p>Options available: Enable/Disable. Default setting is <b>Disable</b>.</p>
Hardware Prefetcher	<p>Select whether to enable the speculative prefetch unit of the processor.</p> <p>Options available: Enable/Disable. Default setting is <b>Disable</b>.</p>
L2 RF0 Prefetcher	Options available: Enable/Disable. Default setting is <b>Disable</b> .
Adjacent Cache Prefetch	<p>When enabled, cache lines are fetched in pairs. When disabled, only the required cache line is fetched.</p> <p>Options available: Enable/Disable. Default setting is <b>Enable</b>.</p>

DCU Streamer Prefetcher	Prefetches the next L1 data line based upon multiple loads in same cache line. Options available: Enable/Disable. Default setting is <b>Enable</b> .
DCU IP Prefetcher	Prefetches the next L1 Data line based upon sequential load history. Options available: Enable/Disable. Default setting is <b>Enable</b> .
AES-NI	Enable/Disable the AES-NI (Intel Advanced Encryption Standard New Instructions) support function. Options available: Enable/Disable. Default setting is <b>Enable</b> .

### 5-3-2 Common RefCode Configuration

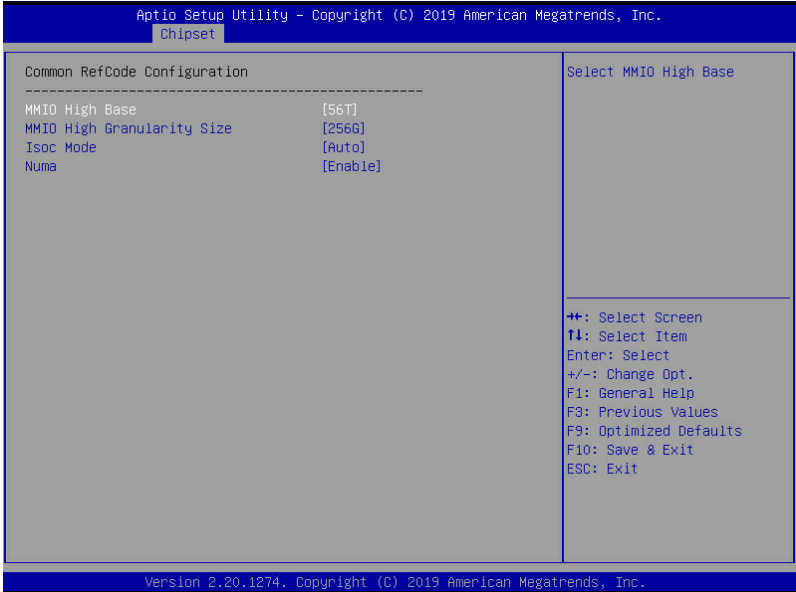

Parameter	Description
Common RefCode Configuration	
MMIO High Base	Selects the MMIO High Base setting. Options available: 56T/40T/24T/16T/4T/1T. Default setting is <b>56T</b> .
MMIO High Granularity Size	Selects the allocation size used to assign mmioh resources. Total mmioh space can be up to 32xgranularity. Per stack mmioh resource assignments are multiples of the granularity where 1 unit per stack is the default allocation. Options available: 1G/4G/16G/64G/256G/1024G. Default setting is <b>256G</b> .
Isoc Mode	Options available: Auto/Enable/Disable. Default setting is <b>Auto</b> .
Numa (Non-Uniform Memory Access)	Enable/Disable Non-uniform Memory Access (NUMA). Options available: Enable/Disable. Default setting is <b>Enable</b> .

### 5-3-3 UPI Configuration

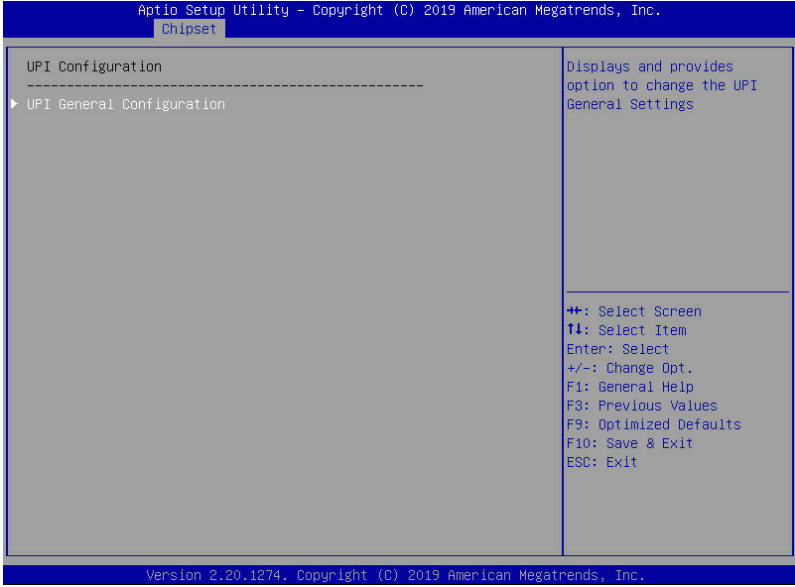

Parameter	Description
UPI Configuration	
UPI General Configuration	<p>Press [Enter] to configure advanced items.</p> <ul style="list-style-type: none"> <li>◆ UPI Status               <ul style="list-style-type: none"> <li>– Press [Enter] to view the UPI status.</li> </ul> </li> <li>◆ Link Frequency Select               <ul style="list-style-type: none"> <li>– Selects the UPI link frequency.</li> <li>– Options available: 9.6GB/10.4GB/Auto. Default setting is <b>Auto</b>.</li> </ul> </li> <li>◆ SNC               <ul style="list-style-type: none"> <li>– Enable/Disable SNC.</li> <li>– Options available: Disable/Enable/Auto. Default setting is <b>Disable</b>.</li> </ul> </li> <li>◆ Stale AtoS               <ul style="list-style-type: none"> <li>– Enable/Disable Stale A to S Dir optimization.</li> <li>– Options available: Disable/Enable/Auto. Default setting is <b>Disable</b>.</li> </ul> </li> <li>◆ LLC dead line alloc               <ul style="list-style-type: none"> <li>– Enable/Disable LLC dead line alloc.</li> <li>– Options available: Disable/Enable/Auto. Default setting is <b>Auto</b>.</li> </ul> </li> </ul>



## 5-3-4 Memory Configuration

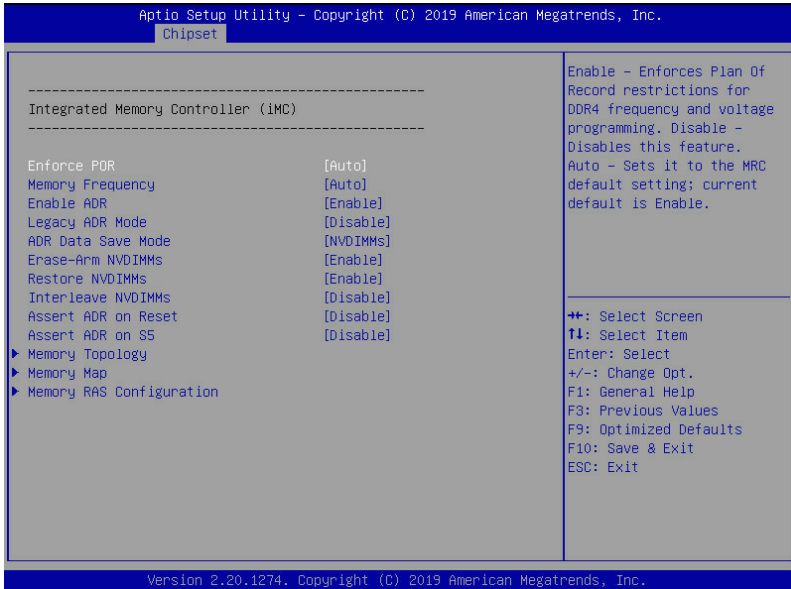

Parameter	Description
Integrated Memory Controller (iMC)	
Enforce POR	When set to Enable, the system enforces Plan Of Record restrictions for DDR4 frequency and voltage programming. When set to Auto, the system sets it to the MRC default settings. Options available: Auto/POR/Disable. Default setting is <b>Enable</b> .
Memory Frequency	Configures the memory frequency. Options available: Auto/2133/2400/2666. Default setting is <b>Auto</b> .
Enable ADR	Enables the detecting and enabling of ADR. Options available: Enable/Disable. Default setting is <b>Enable</b> .
Legacy ADR Mode	Enable/Disable the Legacy ADR Mode. Options available: Enable/Disable. Default setting is <b>Disable</b> .
ADR Data Save Mode	Data Save Mode for ADR, Batterybacked or Type 01 NVDIMM. Options available: Disable/Batterybacked DIMMs/NVDIMMs. Default setting is <b>NVDIMMs</b> .
Erase-ARM NVDIMMs	Enable/Disable Erasing and Arming NVDIMMs. Options available: Enable/Disable. Default setting is <b>Enable</b> .
Restore NVDIMMs	Enable/Disable Automatic restoring of NVDIMMs. Options available: Enable/Disable. Default setting is <b>Enable</b> .

Parameter	Description
Interleave NVDIMMs	Controls if NVDIMMs are interleaved together or not. Options available: Enable/Disable. Default setting is <b>Disable</b> .
Assert ADR on Reset	Enable/Disable Assert ADR on Reset. Options available: Enable/Disable. Default setting is <b>Disable</b> .
Assert ADR on S5	Enable/Disable Assert ADR on S5. Options available: Enable/Disable. Default setting is <b>Disable</b> .
Memory Topology	Press [Enter] to configure advanced items.
Memory Map	Press [Enter] to configure advanced items. <ul style="list-style-type: none"> <li>◆ IMC Interleaving <ul style="list-style-type: none"> <li>– Select to configure IMC Interleaving.</li> <li>– Options available: Auto/1-way Interleave/2-way Interlave.</li> <li>Default setting is <b>Auto</b>.</li> </ul> </li> </ul>
Memory RAS Configuration	Press [Enter] to configure advanced items. <ul style="list-style-type: none"> <li>◆ RAS Type <ul style="list-style-type: none"> <li>– Displays the RAS type.</li> </ul> </li> <li>◆ Static Virtual Lockstep Mode <ul style="list-style-type: none"> <li>– Enable/Disable the Static Virtual Lockstep mode.</li> <li>– Options available: Disable/Enable. Default setting is <b>Disable</b>.</li> </ul> </li> <li>◆ Mirror Mode <ul style="list-style-type: none"> <li>– Mirror Mode will set entire 1LM/2LM memory in system to be mirrored, consequently reducing the memory capacity by half. Enables the Mirror Mode will disable the XPT Prefetch.</li> <li>– Options available: Disable/Mirror Mode 1LM/Mirror Mode 2LM.</li> <li>Default setting is <b>Disable</b>.</li> </ul> </li> <li>◆ Memory Rank Sparing <ul style="list-style-type: none"> <li>– Enable/Disable Memory Rank Sparing.</li> <li>– Options available: Disable/Enable. Default setting is <b>Disable</b>.</li> </ul> </li> <li>◆ Correctable Error Threshold <ul style="list-style-type: none"> <li>– Correctable Error Threshold (1-32767) used for sparing, tagging, and leaky bucket.</li> <li>– Press the &lt;+&gt; / &lt;-&gt; keys to increase or decrease the desired values.</li> </ul> </li> <li>◆ SDDC Plus One <ul style="list-style-type: none"> <li>– Enable/Disable SDDC Plus One.</li> <li>– Options available: Disable/Enable. Default setting is <b>Disable</b>.</li> </ul> </li> </ul>

### 5-3-5 IIO Configuration



Parameter	Description
IIO Configuration	<p>Press [Enter] to configure advanced items.</p> <ul style="list-style-type: none"> <li>◆ Intel® VT for Directed I/O (VT-d) <ul style="list-style-type: none"> <li>– Enable/Disable the Intel VT for Directed I/O (VT-d) support function by reporting the I/O device assignment to VMM through DMAR ACPI Tables.</li> <li>– Options available: Enable/Disable. Default setting is <b>Enable</b>.</li> </ul> </li> <li>◆ ACS Control <ul style="list-style-type: none"> <li>– Enable: Programs ACS only to Chipset Pcie Root Ports Bridges.</li> <li>– Disable: Programs ACS to all PCIe bridges.</li> <li>– Default setting is <b>Enable</b>.</li> </ul> </li> <li>◆ Intel® VT for Directed I/O (VT-d) <ul style="list-style-type: none"> <li>◆ Interrupt Remapping <ul style="list-style-type: none"> <li>– Enable/Disable the interrupt remapping support function.</li> <li>– Options available: Enable/Disable. Default setting is <b>Enable</b>.</li> </ul> </li> <li>◆ PassThrough DMA <ul style="list-style-type: none"> <li>– Enable/Disable the Non-Isocch VT_D Engine PassThrough DMA support function.</li> <li>– Options available: Enable/Disable. Default setting is <b>Enable</b>.</li> </ul> </li> <li>◆ ATS <ul style="list-style-type: none"> <li>– Enable/Disable Non-Isocch VT_D Engine ATS support.</li> <li>– Options available: Enable/Disable. Default setting is <b>Enable</b>.</li> </ul> </li> </ul> </li> </ul>

Parameter	Description
Intel® VT for Directed I/O (VT-d) (continued)	<ul style="list-style-type: none"> <li>◆ Post Interrupt <ul style="list-style-type: none"> <li>– Enable/Disable VT_D posted interrupt.</li> <li>– Options available: Enable/Disable. Default setting is <b>Enable</b>.</li> </ul> </li> <li>◆ Coherency Support (Non-IsocH) <ul style="list-style-type: none"> <li>– Enable/Disable Non-IsocH VT_D Engine Coherency support.</li> <li>– Options available: Enable/Disable. Default setting is <b>Enable</b>.</li> </ul> </li> </ul>
Intel® VMD technology	<p data-bbox="387 335 719 357">Press [Enter] to configure advanced items.</p> <ul style="list-style-type: none"> <li>◆ Intel® VMD technology</li> <li>◆ Intel® VMD Configuration <ul style="list-style-type: none"> <li>– Enable/Disable the Intel VMD support function.</li> <li>– Options available: Enable/Disable. Default setting is <b>Disable</b>.</li> </ul> </li> </ul>
MCTP	<p data-bbox="387 492 929 514">Enable/Disable MCTP (Management Component Transport Protocol).</p> <p data-bbox="387 519 862 540">Options available: Enable/Disable. Default setting is <b>Disable</b>.</p>

### 5-3-6 Advanced Power Management Configuration

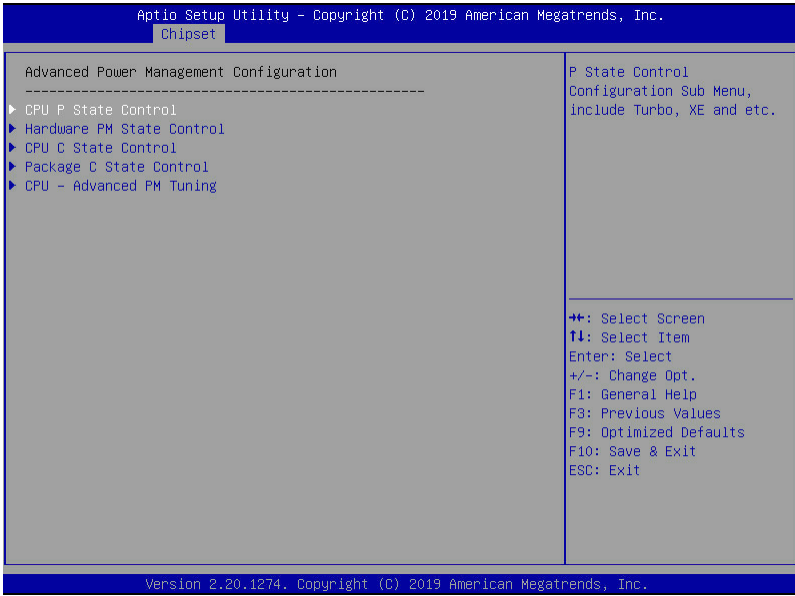

Parameter	Description
Advanced Power Management Configuration	Press [Enter] to configure advanced items.
CPU P State Control	<ul style="list-style-type: none"> <li>◆ SpeedStep (Pstates)               <ul style="list-style-type: none"> <li>– Conventional Intel SpeedStep Technology switches both voltage and frequency in tandem between high and low levels in response to processor load.</li> <li>– Options available: Enable/Disable. Default setting is <b>Enable</b>.</li> </ul> </li> <li>◆ Turbo Mode               <ul style="list-style-type: none"> <li>– When this item is enabled, the processor will automatically ramp up the clock speed of 1-2 of its processing cores to improve its performance. When this item is disabled, the processor will not overclock any of its core.</li> <li>– Options available: Enable/Disable. Default setting is <b>Enable</b>.</li> </ul> </li> </ul>

Parameter	Description
Hardware PM State Control	<p>Press [Enter] to configure advanced items.</p> <ul style="list-style-type: none"> <li>◆ Hardware P-States <ul style="list-style-type: none"> <li>– When this item is disabled, the processor hardware chooses a P-state based on OS Request (Legacy P-States).</li> <li>– In Native mode, the processor hardware chooses a P-state based on OS guidance.</li> <li>– In Out of Band mode, the processor hardware autonomously chooses a P-state (with no OS guidance).</li> <li>– Options available: Disable/Native Mode/Out of Band Mode/Native Mode with No Legacy Support. Default setting is <b>Native Mode</b>.</li> </ul> </li> </ul>
CPU C State Control	<p>Press [Enter] to configure advanced items.</p> <ul style="list-style-type: none"> <li>◆ Autonomous Core C-State <ul style="list-style-type: none"> <li>– Enable/Disable the Autonomous Core C-State Control.</li> <li>– Options available: Enable/Disable. Default setting is <b>Disable</b>.</li> </ul> </li> <li>◆ CPU C6 Report <ul style="list-style-type: none"> <li>– Allows you to determine whether to let the CPU enter C6 mode in system halt state. When enabled, the CPU core frequency and voltage will be reduced during system halt state to decrease power consumption. The C6 state is a more enhanced power-saving state than C1.</li> <li>– Options available: Disable/Enable/Auto. Default setting is <b>Auto</b>.</li> </ul> </li> <li>◆ Enhanced Halt State (C1E)<sup>(Note)</sup> <ul style="list-style-type: none"> <li>– Core C1E auto promotion control. Takes effect after reboot.</li> <li>– Options available: Enable/Disable. Default setting is <b>Enable</b>.</li> </ul> </li> <li>◆ OS ACPI Cx <ul style="list-style-type: none"> <li>– Reports CPU C3/C6 to OS ACPI C2 or ACPI C3.</li> <li>– Options available: ACPI C2/ACPI C3. Default setting is <b>ACPI C2</b>.</li> </ul> </li> </ul>
Package C State Control	<p>Configures the state for the C-State package limit.</p> <p>Options available: C0/C1 state/C2 state/C6 (non Retention) state/C6 (Retention) state/No Limit/Auto.</p> <p>Default setting is <b>Auto</b>.</p>

Parameter	Description
CPU - Advanced PM Tuning	<p>Press [Enter] to configure advanced items.</p> <ul style="list-style-type: none"> <li>◆ Energy Perf BIAS <ul style="list-style-type: none"> <li>– Enters the Energy Perf BIAS submenu.</li> </ul> </li> <li>◆ Power Performance Tuning<sup>(Note)</sup> <ul style="list-style-type: none"> <li>– Tunes the Power Performance Configuration mode. When enabled, uses IA32_ENERGY_PERF_BIAS input from the core. When disabled, uses alternate performance BIAS input from ENERGY_PERF_BIAS_CONFIG.</li> <li>– Options available: OS Controls EPB/BIOS Controls EPB. Default setting is <b>OS Controls EPB</b>.</li> </ul> </li> <li>◆ Energy_PERF_BIAS_CFG mode <ul style="list-style-type: none"> <li>– Selects the Energy Performance Bias Configuration Mode.</li> <li>– Options available: Performance/Balanced Performance/Balanced Power/Power. Default setting is <b>Balanced Performance</b>.</li> <li>– Please note that this item is configurable when Power Performance Tuning is set to BIOS Controls EPB.</li> </ul> </li> </ul>

(Note) Advanced items prompt when this item is defined.

## 5-3-7 PCH Configuration

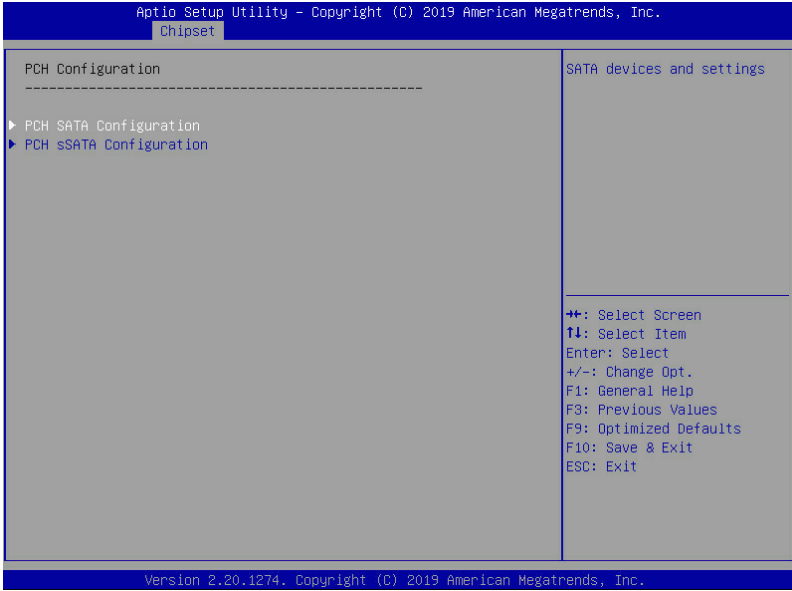

Parameter	Description
PCH Configuration	<p>Press [Enter] to configure advanced items.</p> <ul style="list-style-type: none"> <li>◆ SATA Controller <ul style="list-style-type: none"> <li>– Enable/Disable SATA controller.</li> <li>– Options available: Enable/Disable. Default setting is <b>Enable</b>.</li> </ul> </li> <li>◆ Configure SATA as <ul style="list-style-type: none"> <li>– Configures on chip SATA type.</li> <li>– AHCI Mode: When set to AHCI, the SATA controller enables its AHCI functionality. Then the RAID function is disabled and cannot be access the RAID setup utility at boot time.</li> <li>– RAID Mode: When set to RAID, the SATA controller enables both its RAID and AHCI functions. You will be allowed to access the RAID setup utility at boot time.</li> <li>– Options available: AHCI/RAID. Default setting is <b>AHCI</b>.</li> </ul> </li> <li>◆ Alternate Device ID on RAID<sup>(Note 1)</sup> <ul style="list-style-type: none"> <li>– Enable/Disable Alternate Device ID on RAID mode.</li> <li>– Options available: Enable/Disable. Default setting is Disabled</li> <li>– Please note that this option appears when HDD is in <b>RAID Mode</b>.</li> </ul> </li> <li>◆ SATA Port 0/1/2/3/4/5/6/7 <ul style="list-style-type: none"> <li>– The category identifies SATA hard drives that are installed in the computer. System will automatically detect HDD type.</li> </ul> </li> </ul>
PCH SATA Configuration	



Parameter	Description
PCH SATA Configuration (continued)	<ul style="list-style-type: none"> <li>◆ Port 0/1/2/3/4/5/6/7 <ul style="list-style-type: none"> <li>– Enable/Disable Port 0/1/2/3/4/5/6/7 device.</li> <li>– Options available: Enable/Disable. Default setting is <b>Enable</b>.</li> </ul> </li> <li>◆ Hot Plug (for Port 0/1/2/3/4/5/6/7)<sup>(Note 2)</sup> <ul style="list-style-type: none"> <li>– Enable/Disable HDD Hot-Plug function.</li> <li>– Options available: Enable/Disable. Default setting is <b>Disable</b>.</li> </ul> </li> <li>◆ Spin Up Device (for Port 0/1/2/3/4/5/6/7)<sup>(Note 2)</sup> <ul style="list-style-type: none"> <li>– On an edge detect from 0 to 1, the PCH starts a COM reset initialization to the device.</li> <li>– Options available: Enable/Disable. Default setting is <b>Disable</b>.</li> </ul> </li> </ul>
PCH sSATA Configuration	<ul style="list-style-type: none"> <li>◆ sSATA Controller <ul style="list-style-type: none"> <li>– Enable/Disable sSATA controller.</li> <li>– Options available: Enable/Disable. Default setting is <b>Enable</b>.</li> </ul> </li> <li>◆ Configure sSATA as <ul style="list-style-type: none"> <li>– Configures on chip SATA type.</li> <li>– AHCI Mode: When set to AHCI, the SATA controller enables its AHCI functionality. Then the RAID function is disabled and cannot be access the RAID setup utility at boot time.</li> <li>– RAID Mode: When set to RAID, the SATA controller enables both its RAID and AHCI functions. You will be allowed to access the RAID setup utility at boot time.</li> <li>– Options available: AHCI/RAID. Default setting is <b>AHCI</b>.</li> </ul> </li> <li>◆ Alternate Device ID on RAID<sup>(Note 1)</sup> <ul style="list-style-type: none"> <li>– Enable/Disable Alternate Device ID on RAID mode.</li> <li>– Options available: Enable/Disable. Default setting is <b>Disabled</b>.</li> <li>– <b>Please note that this option appears when HDD is in RAID Mode.</b></li> </ul> </li> <li>◆ sSATA Port 0/1/2/3/4/5 <ul style="list-style-type: none"> <li>– The category identifies sSATA hard drives that are installed in the computer. System will automatically detect HDD type.</li> </ul> </li> <li>◆ Port 0/1/2/3/4/5 <ul style="list-style-type: none"> <li>– Enable/Disable Port 0/1/2/3/4/5 device.</li> <li>– Options available: Enable/Disable. Default setting is <b>Enable</b>.</li> </ul> </li> <li>◆ Hot Plug (for Port 0/1/2/3/4/5)<sup>(Note 2)</sup> <ul style="list-style-type: none"> <li>– Enable/Disable HDD Hot-Plug function.</li> <li>– Options available: Enable/Disable. Default setting is <b>Disable</b>.</li> </ul> </li> <li>◆ Spin Up Device (for Port 0/1/2/3/4/5)<sup>(Note 2)</sup> <ul style="list-style-type: none"> <li>– On an edge detect from 0 to 1, the PCH starts a COM reset initialization to the device.</li> <li>– Options available: Enable/Disable. Default setting is <b>Disabled</b>.</li> </ul> </li> </ul>

(Note 1) Only appears when HDD sets to **RAID** Mode.

(Note 2) Only Supported when HDD is in **AHCI** or **RAID** Mode.

## 5-3-8 Miscellaneous Configuration

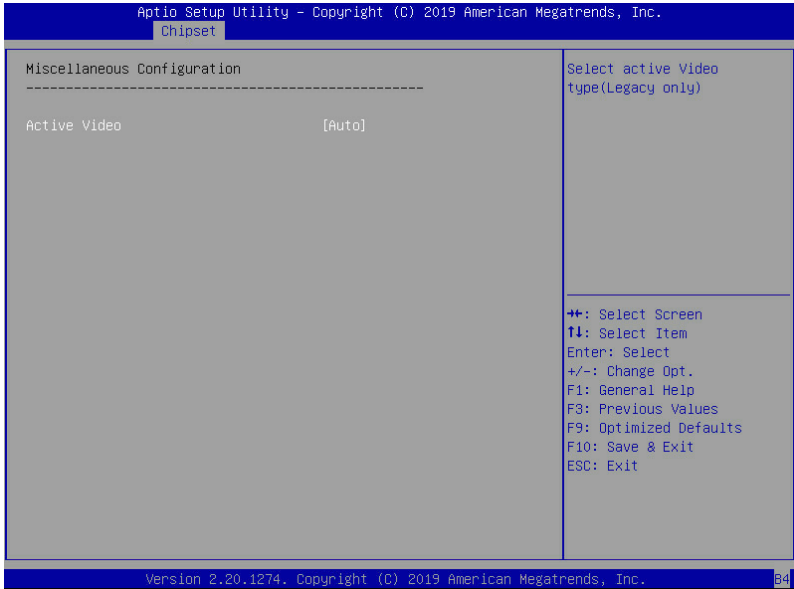

Parameter	Description
Miscellaneous Configuration	
Active Video	Selects the active video type. Options available: Auto/Onboard Device/PCIE Device. Default setting is <b>Auto</b> .

### 5-3-9 Server ME Configuration

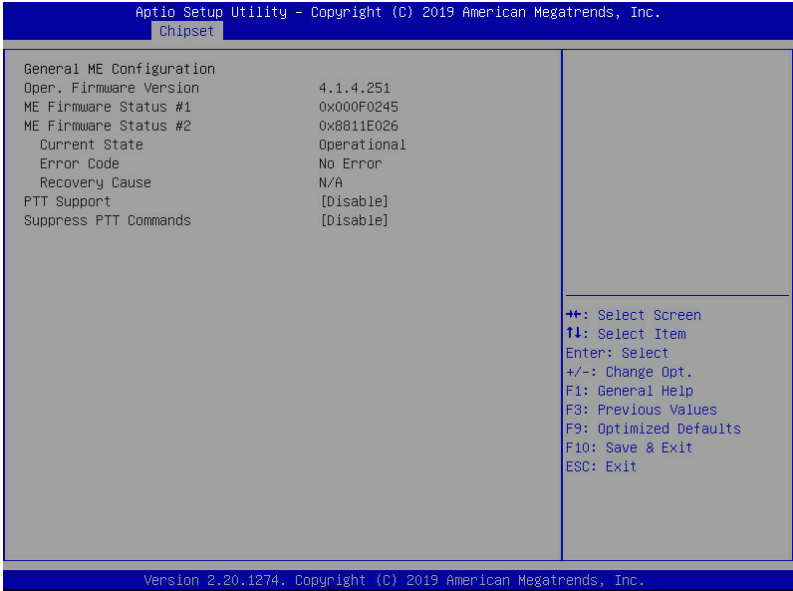

Parameter	Description
General ME Configuration	
Operational Firmware Version	Selects the active video type. Options available: Auto/Onboard Device/PCIE Device. Default setting is <b>Auto</b> .
ME Firmware Status #1/#2	Displays ME Firmware status information.
Current State (for ME Firmware)	Displays ME Firmware current status information.
Error Code (for ME Firmware)	Displays ME Firmware status error code.
Recovery Cause (for ME Firmware)	Displays ME Firmware recovery cause.
PTT Support	Displays if the system supports the Intel® Platform Trust Technology.

### 5-3-10 Runtime Error Logging

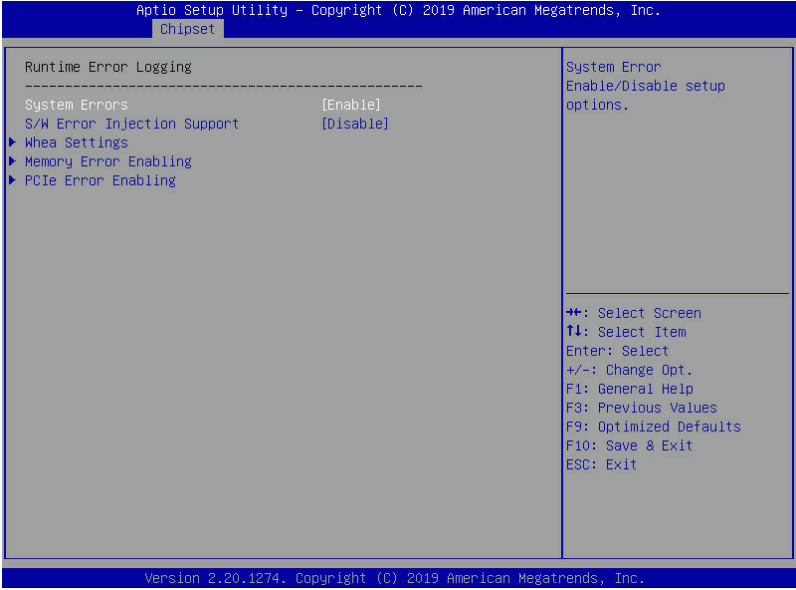

Parameter	Description
Runtime Error Logging	
System Errors	Enable/Disable system error logging function. Options available: Enable/Disable. Default setting is <b>Enable</b> .
S/W Error Injection Support	Enable/Disable software injection error logging function. Options available: Enable/Disable. Default setting is <b>Disable</b> .
Whea Settings	Press [Enter] to configure advanced items. <ul style="list-style-type: none"> <li>◆ WHEA (Windows Hardware Error Architecture) Support <ul style="list-style-type: none"> <li>- Enable/Disable WHEA Support.</li> <li>- Options available: Enable/Disable. Default setting is <b>Enable</b>.</li> </ul> </li> </ul>
Memory Error Enabling	Press [Enter] to configure advanced items. <ul style="list-style-type: none"> <li>◆ Memory Error <ul style="list-style-type: none"> <li>- Enable/Disable Memory Error.</li> <li>- Options available: Enable/Disable. Default setting is <b>Enable</b>.</li> </ul> </li> <li>◆ Memory Corrected Error <ul style="list-style-type: none"> <li>- Enable/Disable Memory Corrected Error.</li> <li>- Options available: Enable/Disable. Default setting is <b>Enable</b>.</li> </ul> </li> <li>◆ Uncorrected Error disable Memory <ul style="list-style-type: none"> <li>- Enable/Disable the Memory that triggers Uncorrected Error.</li> <li>- Options available: Enable/Disable. Default setting is <b>Disable</b>.</li> </ul> </li> </ul>

Parameter	Description
PCIe Error Enabling	<p data-bbox="317 155 646 175">Press [Enter] to configure advanced items.</p> <ul style="list-style-type: none"> <li data-bbox="317 185 849 263">◆ Corrected Error <ul style="list-style-type: none"> <li data-bbox="352 213 806 233">– Enables and escalates Correctable Errors to error pins.</li> <li data-bbox="352 241 849 261">– Options available: Enable/Disable. Default setting is <b>Enable</b>.</li> </ul> </li> <li data-bbox="317 271 929 349">◆ Uncorrected Error <ul style="list-style-type: none"> <li data-bbox="352 299 929 319">– Enables and escalates Uncorrectable/Recoverable Errors to error pins.</li> <li data-bbox="352 327 849 348">– Options available: Enable/Disable. Default setting is <b>Enable</b>.</li> </ul> </li> <li data-bbox="317 357 849 435">◆ Fatal Error Enable <ul style="list-style-type: none"> <li data-bbox="352 385 753 406">– Enables and escalates Fatal Errors to error pins.</li> <li data-bbox="352 413 849 434">– Options available: Enable/Disable. Default setting is <b>Enable</b>.</li> </ul> </li> <li data-bbox="317 443 849 522">◆ SERR Propagation <ul style="list-style-type: none"> <li data-bbox="352 471 653 492">– Enable/Disable SERR propagation.</li> <li data-bbox="352 500 849 520">– Options available: Enable/Disable. Default setting is <b>Enable</b>.</li> </ul> </li> <li data-bbox="317 529 849 608">◆ PERR Propagation <ul style="list-style-type: none"> <li data-bbox="352 558 653 578">– Enable/Disable PERR propagation.</li> <li data-bbox="352 586 849 606">– Options available: Enable/Disable. Default setting is <b>Enable</b>.</li> </ul> </li> </ul>

### 5-3-11 Power Policy

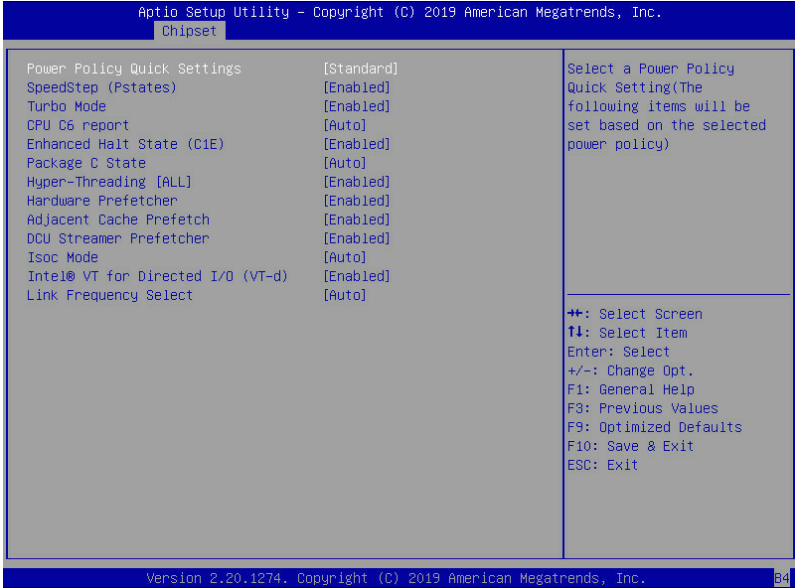

Parameter	Description
Power Policy Quick Settings	Selects a Power Policy Quick Setting. Options available: Standard/Best Performance/Energy Efficient
SpeedStep (Pstates)	Conventional Intel SpeedStep Technology switches both voltage and frequency in tandem between high and low levels in response to processor load. Options available: Enable/Disable. Default setting is <b>Enable</b> .
Turbo Mode	When this item is enabled, the processor will automatically ramp up the clock speed of 1-2 of its processing cores to improve its performance. When this item is disabled, the processor will not overclock any of its core. Options available: Enable/Disable. Default setting is <b>Enable</b> .
CPU C6 report	Allows you to determine whether to let the CPU enter C6 mode in system halt state. When enabled, the CPU core frequency and voltage will be reduced during system halt state to decrease power consumption. The C6 state is a more enhanced powersaving state than C1. Options available: Disable/Enable/Auto. Default setting is <b>Auto</b> .
Enhanced Halt State (C1E) <sup>(Note)</sup>	Core C1E auto promotion control. Takes effect after reboot. Options available: Enable/Disable. Default setting is <b>Enable</b> .

(Note) Advanced items prompt when this item is defined.

Parameter	Description
Package C State	Configures the state for the C-State package limit. Options available: C0/C1 state/C2 state/C6 (non Retention) state/C6 (Retention) state/No Limit/Auto. Default setting is <b>Auto</b> .
Hyper-Threading [ALL]	The Hyper Threading Technology allows a single processor to execute two or more separate threads concurrently. When hyper-threading is enabled, multi-threaded software applications can execute their threads, thereby improving performance. Options available: Enable/Disable. Default setting is <b>Enable</b> .
Hardware Prefetcher	Select whether to enable the speculative prefetch unit of the processor. Options available: Enable/Disable. Default setting is <b>Disable</b> .
Adjacent Cache Prefetch	When enabled, cache lines are fetched in pairs. When disabled, only the required cache line is fetched. Options available: Enable/Disable. Default setting is <b>Enable</b> .
DCU Streamer Prefetcher	Prefetches the next L1 data line based upon multiple loads in same cache line. Options available: Enable/Disable. Default setting is <b>Enable</b> .
Isoc Mode	Options available: Auto/Enable/Disable. Default setting is <b>Auto</b> .
Intel® VT for Directed I/O (VT-d)	Enable/Disable the Intel VT for Directed I/O (VT-d) support function by reporting the I/O device assignment to VMM through DMAR ACPI Tables. Options available: Enable/Disable. Default setting is <b>Enable</b> .
Link Frequency Select	Selects the UPI link frequency. Options available: 9.6GB/10.4GB/Auto. Default setting is <b>Auto</b> .

# 5-4 Server Management Menu

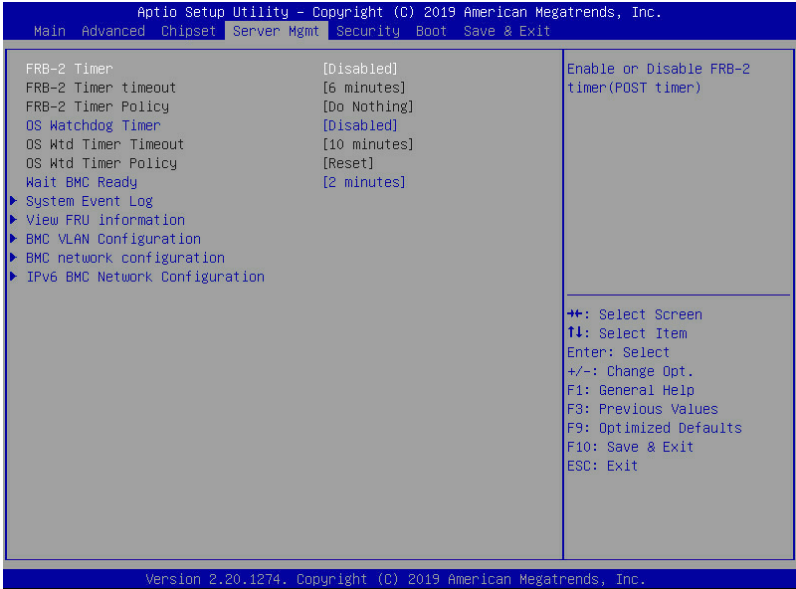

Parameter	Description
FRB-2 Timer	Enable/Disable FRB-2 timer (POST timer). Options available: Enabled/Disabled. Default setting is <b>Disabled</b> .
FRB-2 Timer timeout	Configure the FRB2 Timer timeout. Options available: 3 minutes/4 minutes/5 minutes/6 minutes. Default setting is <b>6 minutes</b> . <b>Please note that this item is configurable when FRB-2 Timer is set to Enabled.</b>
FRB-2 Timer Policy	Configure the FRB2 Timer policy. Options available: Do Nothing/Reset/Power Down. Default setting is <b>Do Nothing</b> . <b>Please note that this item is configurable when FRB-2 Timer is set to Enabled.</b>
OS Watchdog Timer	Enable/Disable OS Watchdog Timer function. Options available: Enabled/Disabled. Default setting is <b>Disabled</b> .
OS Wtd Timer Timeout	Configure OS Watchdog Timer. Options available: 5 minutes/10 minutes/15 minutes/20 minutes. Default setting is <b>10 minutes</b> . <b>Please note that this item is configurable when OS Watchdog Timer is set to Enabled.</b>
OS Wtd Timer Policy	Configure OS Watchdog Timer Policy. Options available: Reset/Do Nothing/Power Down. Default setting is <b>Reset</b> . <b>Please note that this item is configurable when OS Watchdog Timer is set to Enabled.</b>



<b>Parameter</b>	<b>Description</b>
System Event Log	Press [Enter] to configure advanced items.
View FRU Information	Press [Enter] to view the advanced items.
BMC network configuration	Press [Enter] to configure advanced items.
IPv6 BMC Network Configuration	Press [Enter] to configure advanced items.

## 5-4-1 System Event Log

Aptio Setup Utility - Copyright (C) 2019 American Megatrends, Inc.

Server Mgmt

<p>Enabling/Disabling Options SEL Components [Enabled]</p> <p>Erasing Settings Erase SEL [No] When SEL is Full [Do Nothing]</p> <p>Custom EFI Logging Options Log EFI Status Codes [Error code]</p> <p>NOTE: All values changed here do not take effect until computer is restarted.</p>	<p>Change this to enable or disable event logging for error/progress codes during boot.</p> <hr/> <p>           ++: Select Screen            ↑↓: Select Item            Enter: Select            +/-: Change Opt.            F1: General Help            F3: Previous Values            F9: Optimized Defaults            F10: Save &amp; Exit            ESC: Exit         </p>
--	--

Version 2.20.1274. Copyright (C) 2019 American Megatrends, Inc. 84

Parameter	Description
Enabling / Disabling Options	
SEL Components	Change this item to enable or disable all features of System Event Logging during boot. Options available: Enabled/Disabled. Default setting is <b>Enabled</b> .
Erasing Settings	
Erasing SEL	Choose options for erasing SEL. Options available: No/Yes, On next reset/Yes, On every reset. Default setting is <b>No</b> .
When SEL is Full	Choose options for reactions to a full SEL. Options available: Do Nothing/Erased Immediately. Default setting is <b>Do Nothing</b> .
Custom EFI Logging Options	
Log EFI Status Codes	Enable/Disable the logging of EFI Status Codes (if not already converted to legacy). Options available: Disabled/Both/Error code/Progress code. Default setting is <b>Error code</b> .

## 5-4-2 View FRU Information

The FRU page is a simple display page for basic system ID information, as well as System product information. Items on this window are non-configurable.

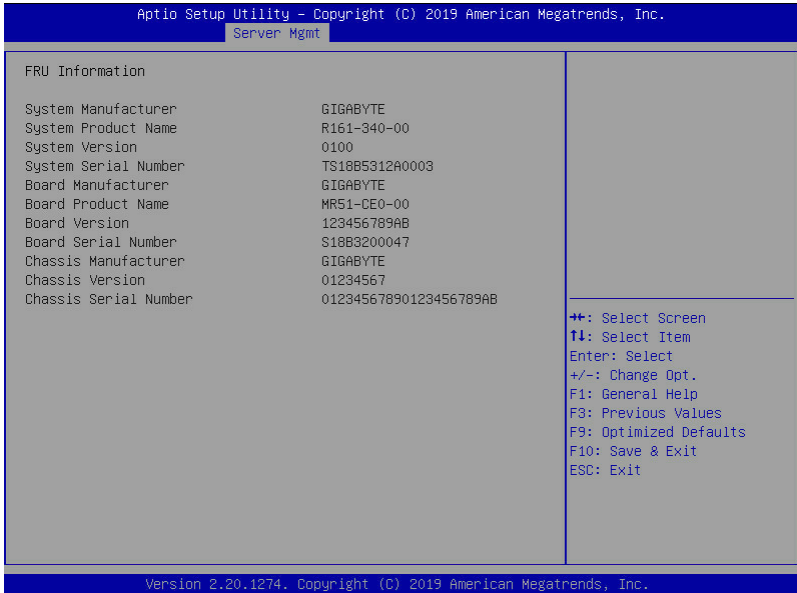

(Note) The model name will vary depends on the product you purchased.

### 5-4-3 BMC VLAN Configuration

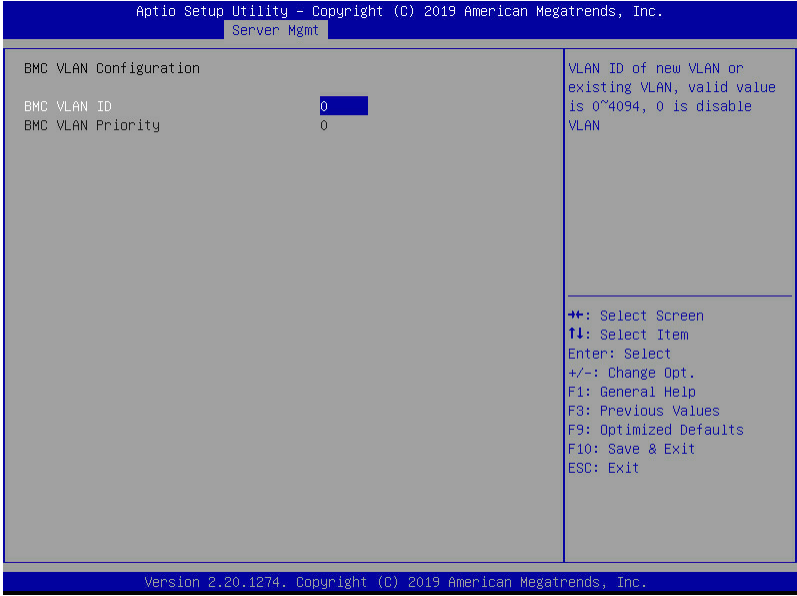

Parameter	Description
BMC VLAN Configuration	
BMC VLAN ID	Select to configure BMC VLAN ID. The valid range is from 0 to 4094. When set to 0, BMC VLAN ID will be disabled.
BMC VLAN Priority	Select to configure BMC VLAN Priority. The valid range is from 0 to 7. When BMC VLAN ID is set to 0, BMC VLAN Priority will not be selected.

## 5-4-4 BMC Network Configuration

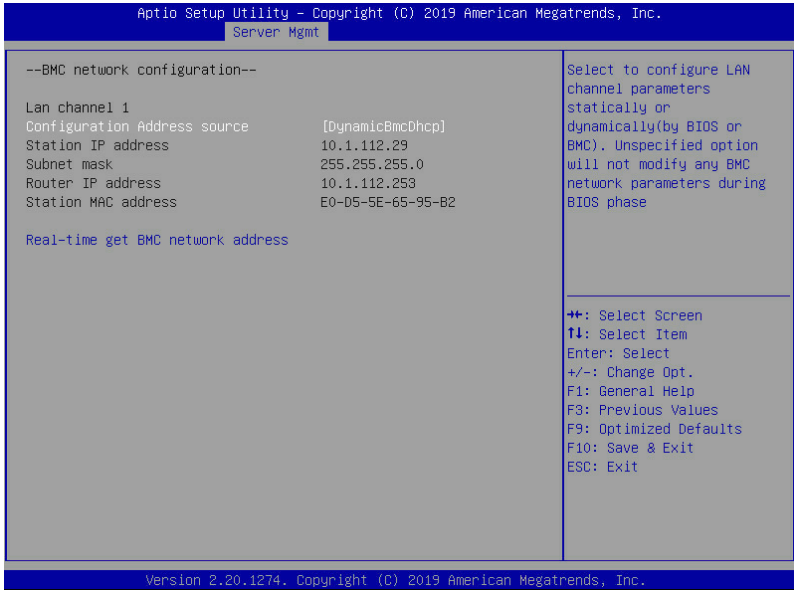

Parameter	Description
BMC network configuration	
Select NCSI and Dedicated LAN	Switch NCSI and dedicated LAN and send KCS command. Options available: Do Nothing/Mode1 (Dedicated)/Mode2(NCSI)/Mode3 (Failover). Default setting is <b>Mode1 (Dedicated)</b> .
Lan Channel 1	
Configuration Address source	Select to configure LAN channel parameters statically or dynamically (DHCP). Do nothing option will not modify any BMC network parameters during BIOS phase. Options available: Unspecified/Static/DynamicBmcDhcp. Default setting is <b>DynamicBmcDhcp</b> .
Station IP address	Displays IP Address information.
Subnet mask	Displays Subnet Mask information. Please note that the IP address must be in three digitals, for example, 192.168.000.001.
Router IP address	Displays the Router IP Address information.
Station MAC address	Displays the MAC Address information.
Real-time synchronize BMC network parameter values	Press [Enter] to synchronize the BMC network parameter values.

## 5-4-5 IPv6 BMC Network Configuration



Parameter	Description
IPv6 BMC Network Configuration	
IPv6 BMC Lan Channel 1	
IPv6 BMC Lan Option	Enable/Disable IPv6 BMC LAN channel function. When this item is disabled, the system will not modify any BMC network during BIOS phase. Options available: Enable/Disable. Default setting is <b>Enable</b> .
IPv6 BMC Lan IP Address Source	Select to configure LAN channel parameters statically or dynamically (by BIOS or BMC). Options available: Unspecified/Static/Dynamic-Obtained by BMC running DHCP. Default setting is <b>Dynamic-Obtained by BMC running DHCP</b> .
IPv6 BMC Lan IP Address/Prefix Length	Check if the IPv6 BMC LAN IP address matches those displayed on the screen.

# 5-5 Security Menu

The Security menu allows you to safeguard and protect the system from unauthorized use by setting up access passwords.

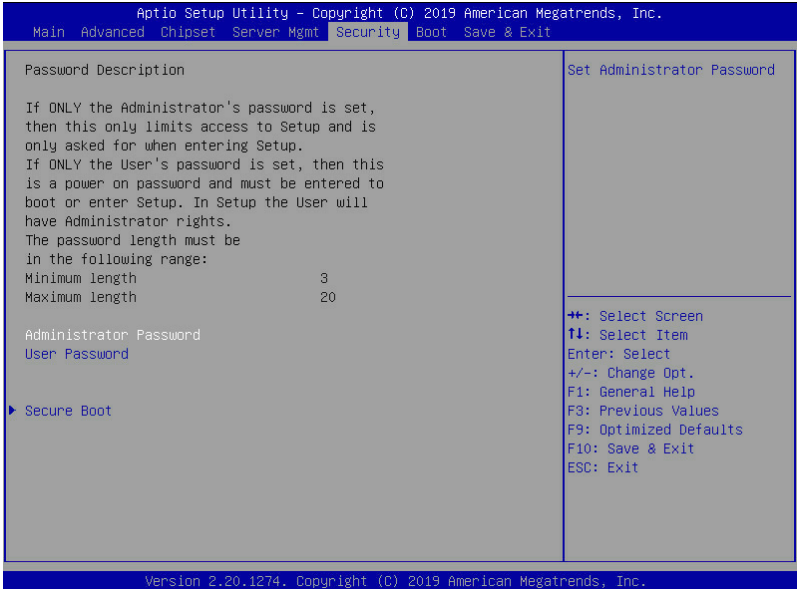

There are two types of passwords that you can set:

- Administrator Password
  - Entering this password will allow the user to access and change all settings in the Setup Utility.
- User Password
  - Entering this password will restrict a user's access to the Setup menus. To enable or disable this field, a Administrator Password must first be set. A user can only access and modify the System Time, System Date, and Set User Password fields.

Parameter	Description
Administrator Password	Press [Enter] to configure the administrator password.
User Password	Press [Enter] to configure the user password.
Secure Boot	Press [Enter] to configure advanced items.

## 5-5-1 Secure Boot

The Secure Boot submenu is applicable when your device is installed the Windows® 8 (or above) operating system.



Parameter	Description
System Mode	Displays the system is in User mode or Setup mode.
Secure Boot	Displays the Secure Boot function is active or not active.
Vendor Keys	Displays the Vendor Keys function is active or not active.
Attempt Secure Boot	Secure Boot activated when Platform Key (PK) is enrolled, System mode is User/Deployed, and CSM function is disabled. Options available: Enabled/Disabled. Default setting is <b>Disabled</b> .
Secure Boot Mode <sup>(Note)</sup>	Secure Boot requires all the applications that are running during the booting process to be pre-signed with valid digital certificates. This way, the system knows all the files being loaded before Windows loads and gets to the login screen have not been tampered with. When set to Standard, it will automatically load the Secure Boot keys from the BIOS databases. When set to Custom, you can customize the Secure Boot settings and manually load its keys from the BIOS database. Options available: Standard/Custom. Default setting is Custom.

(Note) Advanced items prompt when this item is set to **Custom**.



Parameter	Description
Key Management	<p data-bbox="334 153 666 174">Press [Enter] to configure advanced items.</p> <p data-bbox="334 181 937 232"><b>Please note that this item is configurable when Secure Boot Mode is set to Custom.</b></p> <ul style="list-style-type: none"> <li data-bbox="334 239 944 341">◆ Provision Factory Defaults <ul style="list-style-type: none"> <li data-bbox="370 268 944 318">– Allows to provision factory default Secure Boot keys when system is in Setup Mode.</li> <li data-bbox="370 326 900 346">– Options available: Enabled/Disabled. Default setting is <b>Disabled</b>.</li> </ul> </li> <li data-bbox="334 354 926 428">◆ Install Factory Default Keys <ul style="list-style-type: none"> <li data-bbox="370 382 926 402">– Installs all factory default keys. It will force the system in User Mode.</li> <li data-bbox="370 410 602 431">– Options available: Yes/No.</li> </ul> </li> <li data-bbox="334 439 902 512">◆ Enroll Efi Image <ul style="list-style-type: none"> <li data-bbox="370 467 902 517">– Press [Enter] to enroll SHA256 hash of the binary into Authorized Signature Database (db).</li> </ul> </li> <li data-bbox="334 520 876 570">◆ Save all Secure Boot variables <ul style="list-style-type: none"> <li data-bbox="370 551 876 572">– Press [Enter] to save all Secure Boot Keys and Key variables.</li> </ul> </li> <li data-bbox="334 580 898 624">◆ Secure Boot variable <ul style="list-style-type: none"> <li data-bbox="370 608 898 628">– Displays the current status of the variables used for secure boot.</li> </ul> </li> <li data-bbox="334 633 802 736">◆ Platform Key (PK) <ul style="list-style-type: none"> <li data-bbox="370 661 802 682">– Displays the current status of the Platform Key (PK).</li> <li data-bbox="370 689 678 710">– Press [Enter] to configure a new PK.</li> <li data-bbox="370 718 610 738">– Options available: Set New.</li> </ul> </li> <li data-bbox="334 746 944 876">◆ Key Exchange Keys (KEK) <ul style="list-style-type: none"> <li data-bbox="370 774 944 848">– Displays the current status of the Key Exchange Key Database (KEK).</li> <li data-bbox="370 802 905 852">– Press [Enter] to configure a new KEK or load additional KEK from storage devices.</li> <li data-bbox="370 860 678 881">– Options available: Set New/Append.</li> </ul> </li> <li data-bbox="334 884 948 1014">◆ Authorized Signatures (DB) <ul style="list-style-type: none"> <li data-bbox="370 912 905 932">– Displays the current status of the Authorized Signature Database.</li> <li data-bbox="370 940 948 990">– Press [Enter] to configure a new DB or load additional DB from storage devices.</li> <li data-bbox="370 998 678 1019">– Options available: Set New/Append.</li> </ul> </li> <li data-bbox="334 1022 902 1152">◆ Forbidden Signatures (DBX) <ul style="list-style-type: none"> <li data-bbox="370 1050 902 1070">– Displays the current status of the Forbidden Signature Database.</li> <li data-bbox="370 1078 894 1128">– Press [Enter] to configure a new dbx or load additional dbx from storage devices.</li> <li data-bbox="370 1136 678 1157">– Options available: Set New/Append.</li> </ul> </li> <li data-bbox="334 1160 929 1290">◆ Authorized TimeStamps (DBT) <ul style="list-style-type: none"> <li data-bbox="370 1188 929 1208">– Displays the current status of the Authorized TimeStamps Database.</li> <li data-bbox="370 1216 905 1266">– Press [Enter] to configure a new DBT or load additional DBT from storage devices.</li> <li data-bbox="370 1274 678 1295">– Options available: Set New/Append.</li> </ul> </li> <li data-bbox="334 1298 919 1430">◆ OsRecovery Signatures <ul style="list-style-type: none"> <li data-bbox="370 1326 919 1346">– Displays the current status of the OsRecovery Signature Database.</li> <li data-bbox="370 1354 887 1404">– Press [Enter] to configure a new OsRecovery Signature or load additional OsRecovery Signature from storage devices.</li> <li data-bbox="370 1412 678 1433">– Options available: Set New/Append.</li> </ul> </li> </ul>

## 5-6 Boot Menu

The Boot menu allows you to set the drive priority during system boot-up. BIOS setup will display an error message if the legacy drive(s) specified is not bootable.

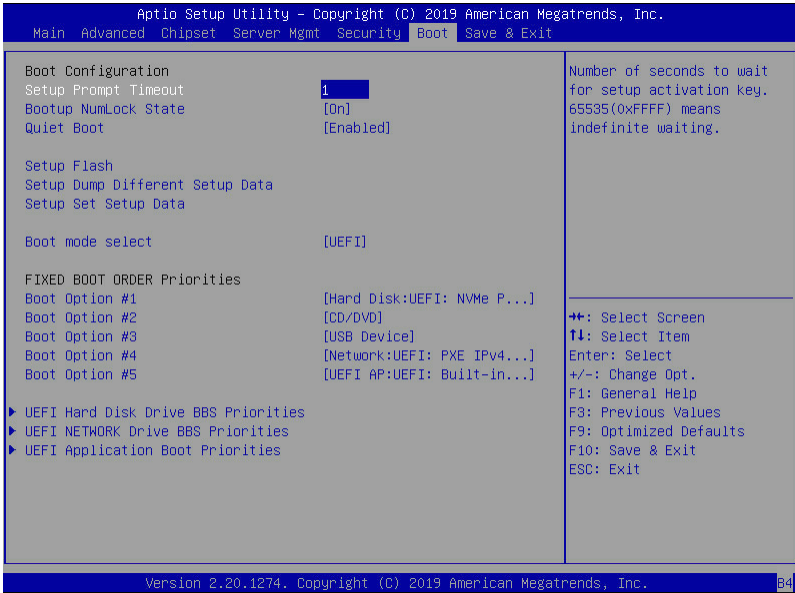

Parameter	Description
Boot Configuration	
Setup Prompt Timeout	Number of seconds to wait for setup activation key. 65535 (0xFFFF) means indefinite waiting. Press the numeric keys to input the desired values.
Bootup NumLock State	Enable/Disable the Bootup NumLock function. Options available: On/Off. Default setting is <b>On</b> .
Quiet Boot	Enable/Disable showing the logo during POST. Options available: Enabled/Disabled. Default setting is <b>Enabled</b> .
Boot mode select	Selects the boot mode. Options available: LEGACY/UEFI. Default setting is <b>UEFI</b> .

Parameter	Description
FIXED BOOT ORDER Priorities	
Boot Option #1 / #2 / #3 / #4 / #5	<p>Press [Enter] to configure the boot priority.</p> <p>By default, the server searches for boot devices in the following sequence:</p> <ol style="list-style-type: none"> <li>1. Hard drive.</li> <li>2. CD-COM/DVD drive.</li> <li>3. USB device.</li> <li>4. Network.</li> <li>5. UEFI.</li> </ol>
UEFI Network Drive BBS Priorities	Press [Enter] to configure the boot priority.
UEFI Application Boot Priorities	Press [Enter] to configure the boot priority.

### 5-6-1 UEFI NETWORK Drive BBS Priorities

The UEFI network drive BBS priorities submenu allows you to specify the boot device priority from the available UEFI network drives during system boot-up. BIOS setup will display an error message if the legacy drive(s) specified is not bootable.



## 5-6-2 UEFI Application Boot Priorities

The UEFI application boot priorities submenu allows you to specify the boot device priority from the available UEFI applications during system boot-up. BIOS setup will display an error message if the legacy drive(s) specified is not bootable.

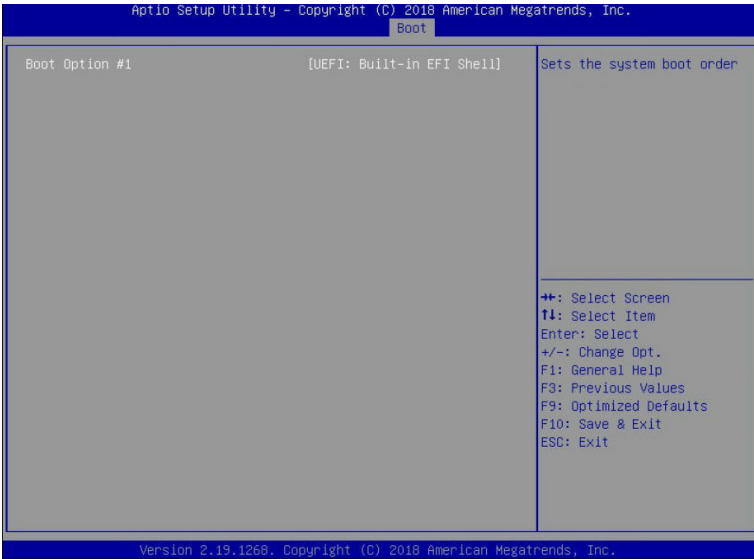

## 5-7 Save & Exit Menu

The Save & Exit menu displays the various options to quit from the BIOS setup. Highlight any of the exit options then press <Enter>.



Parameter	Description
Save Options	
Save Changes and Exit	Saves changes made and closes the BIOS setup. Options available: Yes/No.
Discard Changes and Exit	Discards changes made and exits the BIOS setup. Options available: Yes/No.
Save Changes and Reset	Restarts the system after saving the changes made. Options available: Yes/No.
Discard Changes and Reset	Restarts the system without saving any changes. Options available: Yes/No.
Save Changes	Saves changes made in the BIOS setup. Options available: Yes/No.
Discard Changes	Discards changes made and closes the BIOS setup. Options available: Yes/No.

Parameter	Description
Default Options	
Restore Defaults	Loads the default settings for all BIOS setup parameters. Setup Defaults are quite demanding in terms of resources consumption. If you are using low-speed memory chips or other kinds of low-performance components and you choose to load these settings, the system might not function properly. Options available: Yes/No.
Save as User Defaults	Saves the changes made as the user default settings. Options available: Yes/No.
Restore User Defaults	Loads the user default settings for all BIOS setup parameters. Options available: Yes/No.
Boot Override	Press [Enter] to configure the device as the boot-up drive.

## 5-8 BIOS POST Codes

### 5-8-1 AMI Standard - PEI

PEI_CORE_STARTED	0x10
PEI_CAR_CPU_INIT	0x11
PEI_CAR_NB_INIT	0x15
PEI_CAR_SB_INIT	0x19
PEI_MEMORY_SPD_READ	0x2B
PEI_MEMORY_PRESENCE_DETECT	0x2C
PEI_MEMORY_TIMING	0x2D
PEI_MEMORY_CONFIGURING	0x2E
PEI_MEMORY_INIT	0x2F
PEI_MEMORY_INSTALLED	0x31
PEI_CPU_INIT	0x32
PEI_CPU_CACHE_INIT	0x33
PEI_CPU_AP_INIT	0x34
PEI_CPU_BSP_SELECT	0x35
PEI_CPU_SMM_INIT	0x36
PEI_MEM_NB_INIT	0x37
PEI_MEM_SB_INIT	0x3B
PEI_DXE_IPL_STARTED	0x4F
DXE_CORE_STARTED	0x60
//Recovery	
PEI_RECOVERY_AUTO	0xF0
PEI_RECOVERY_USER	0xF1
PEI_RECOVERY_STARTED	0xF2
PEI_RECOVERY_CAPSULE_FOUND	0xF3
PEI_RECOVERY_CAPSULE_LOADED	0xF4
//S3	
PEI_S3_STARTED	0xE0
PEI_S3_BOOT_SCRIPT	0xE1
PEI_S3_VIDEO_REPOST	0xE2
PEI_S3_OS_WAKE	0xE3
DXE_CORE_STARTED	0x60
DXE_NVRAM_INIT	0x61
DXE_SBRUN_INIT	0x62

### 5-8-2 AMI Standard - DXE

DXE_CPU_INIT	0x63
DXE_NB_HB_INIT	0x68
DXE_NB_INIT	0x69
DXE_NB_SMM_INIT	0x6A
DXE_SB_INIT	0x70
DXE_SB_SMM_INIT	0x71
DXE_SB_DEVICES_INIT	0x72



DXE_ACPI_INIT	0x78
DXE_CSM_INIT	0x79
DXE_BDS_STARTED	0x90
DXE_BDS_CONNECT_DRIVERS	0x91
DXE_PCI_BUS_BEGIN	0x92
DXE_PCI_BUS_HPC_INIT	0x93
DXE_PCI_BUS_ENUM	0x94
DXE_PCI_BUS_REQUEST_RESOURCES	0x95
DXE_PCI_BUS_ASSIGN_RESOURCES	0x96
DXE_CON_OUT_CONNECT	0x97
DXE_CON_IN_CONNECT	0x98
DXE_SIO_INIT	0x99
DXE_USB_BEGIN	0x9A
DXE_USB_RESET	0x9B
DXE_USB_DETECT	0x9C
DXE_USB_ENABLE	0x9D
DXE_IDE_BEGIN	0xA0
DXE_IDE_RESET	0xA1
DXE_IDE_DETECT	0xA2
DXE_IDE_ENABLE	0xA3
DXE_SCSI_BEGIN	0xA4
DXE_SCSI_RESET	0xA5
DXE_SCSI_DETECT	0xA6
DXE_SCSI_ENABLE	0xA7
DXE_SETUP_VERIFYING_PASSWORD	0xA8
DXE_SETUP_START	0xA9
DXE_SETUP_INPUT_WAIT	0xAB
DXE_READY_TO_BOOT	0xAD
DXE_LEGACY_BOOT	0xAE
DXE_EXIT_BOOT_SERVICES	0xAF
RT_SET_VIRTUAL_ADDRESS_MAP_BEGIN	0xB0
RT_SET_VIRTUAL_ADDRESS_MAP_END	0xB1
DXE_LEGACY_OPROM_INIT	0xB2
DXE_RESET_SYSTEM	0xB3
DXE_USB_HOTPLUG	0xB4
DXE_PCI_BUS_HOTPLUG	0xB5
DXE_NVRAM_CLEANUP	0xB6
DXE_CONFIGURATION_RESET	0xB7

### 5-8-3 AMI Standard - ERROR

PEI_MEMORY_INVALID_TYPE	0x50
PEI_MEMORY_INVALID_SPEED	0x50
PEI_MEMORY_SPD_FAIL	0x51
PEI_MEMORY_INVALID_SIZE	0x52
PEI_MEMORY_MISMATCH	0x52
PEI_MEMORY_NOT_DETECTED	0x53
PEI_MEMORY_NONE_USEFUL	0x53
PEI_MEMORY_ERROR	0x54
PEI_MEMORY_NOT_INSTALLED	0x55
PEI_CPU_INVALID_TYPE	0x56
PEI_CPU_INVALID_SPEED	0x56
PEI_CPU_MISMATCH	0x57
PEI_CPU_SELF_TEST_FAILED	0x58
PEI_CPU_CACHE_ERROR	0x58
PEI_CPU_MICROCODE_UPDATE_FAILED	0x59
PEI_CPU_NO_MICROCODE	0x59
PEI_CPU_INTERNAL_ERROR	0x5A
PEI_CPU_ERROR	0x5A
PEI_RESET_NOT_AVAILABLE	0x5B
//Recovery	
PEI_RECOVERY_PPI_NOT_FOUND	0xF8
PEI_RECOVERY_NO_CAPSULE	0xF9
PEI_RECOVERY_INVALID_CAPSULE	0xFA
//S3 Resume	
PEI_MEMORY_S3_RESUME_FAILED	0xE8
PEI_S3_RESUME_PPI_NOT_FOUND	0xE9
PEI_S3_BOOT_SCRIPT_ERROR	0xEA
PEI_S3_OS_WAKE_ERROR	0xEB
DXE_CPU_ERROR	0xD0
DXE_NB_ERROR	0xD1
DXE_SB_ERROR	0xD2
DXE_ARCH_PROTOCOL_NOT_AVAILABLE	0xD3
DXE_PCI_BUS_OUT_OF_RESOURCES	0xD4
DXE_LEGACY_OPROM_NO_SPACE	0xD5
DXE_NO_CON_OUT	0xD6
DXE_NO_CON_IN	0xD7
DXE_INVALID_PASSWORD	0xD8
DXE_BOOT_OPTION_LOAD_ERROR	0xD9
DXE_BOOT_OPTION_FAILED	0xDA
DXE_FLASH_UPDATE_FAILED	0xDB
DXE_RESET_NOT_AVAILABLE	0xDC

#### 5-8-4 Intel UPI POST Codes

Initialize KTIRC ininput structure default values	0xA0
Collect info such as SBSP, Boot Mode, Reset type etc	0xA1
Setup IO SADs in SBSP to access the config space	0xA2
Setup up minimum path between SBSP & other sockets Add the node to the tree Parse the LEP of the discovered socket Check if the system has the supported topology Setup the boot path for the parent which is not directly connected to Legacy CPU Setup path from SBSP to the new found node	0xA3
Setup IO SADs in PBSP to access the config space	0xA4
System configurations that require some kind of reset	0xA5
Sync up with PBSPs	0xA6
Topology discovery and route calculation	0xA7
Program final route	0xA8
Program final IO SAD setting	0xA9
Protocol layer and other Uncore settings	0xAA
Transition links to full speed operation	0xAB
Phy layer settings	0xAC
Link layer settings	0xAD
Coherency Settings	0xAE
KTIRC is done	0xAF

#### 5-8-5 Intel UPI Error Codes

When system BSP tries to setup path for remote sockets or sends a Boot_Go command to remote socket in SetupSbspPathToAllSockets() or SyncUpPbspForReset(). If the remote socket(s) hasn't checked-in, assert; it is a fatal condition, this error will be logged. No retry. <i>RC Behavior: System Halt</i>	0xD8
When SBSP tries to add this remote socket into system topology tree in SetupSbspPathToAllSockets(), there are some errors occur in the data structure. No retry. <i>RC Behavior: The current Socket is not added to the tree.</i> When SBSP setups the boot path for the parent which is not directly connected to Legacy CPU in SetupSbspPathToAllSockets(). The Child is not an immediate neighbor of Parent. No retry.	0xDA

SAD setup error <i>RC Behavior: System Halt</i>	0xDB
Unsupported topology <i>RC Behavior: System Halt</i>	0xDC
SBSP cannot find KPIRC TXEQ Parameters for this link in GetSocketLinkEparams(). No retry. <i>RC Behavior: System Halt</i>	0xDD

### 5-8-6 Intel MRC POST Codes

Detect DIMM population	0xB0
Set DDR frequency	0xB1
Gather remaining SPD data	0xB2
Program registers on the memory controller level	0xB3
Evaluate RAS modes and save rank information	0xB4
Program registers on the channel level	0xB5
DDRIO Initialization	0xB6
Train DDR	0xB7
Initialize CLTT/OLTT	0xB8
Hardware memory test and init	0xB9
Execute memory init	0xBA
Program memory map and interleaving	0xBB
Program RAS configuration	0xBC
Rank margin tool	0xBD
MRC is done	0xBF

### 5-8-7 Intel MRC Error Codes

No memory was detected	0xE8
Memory test failure	0xEB
Different dimm types are detected installed in the system	0xED
Number of HAs found in system greater than MAX_HA defined in MRC build	0xEE
Indicates a CLTT table structure error	0xEF
Invalid VR mode, unable to set DRAM VDD	0xF0
Failure occurred reserving memory for IOT	0xF1
Reference code assert	0xF2
Unsupported MC frequency set	0xF3
Unable to get current MC frequency	0xF4

### 5-8-8 Intel PM POST Codes

Start of PPM structure initialization	0xD0
PPM CSR programming	0xD1
PPM MSR programming	0xD2
Start of PState transition init	0xD3
PPM exit	0xD4
PPM On ready to boot event	0xD5

### 5-8-9 Intel PM POST Codes

Start of IIO early Initialization	0xE0
Pre Link training	0xE1
Start of Gen3 EQ training	0xE2
Start of PState transition init	0xE3
Gen3 parameters override	0xE4
End of IIO Early Initialization	0xE5
Start of IIO Late initialization	0xE6
PCIe port initialization	0xE7
IOAPIC initialization	0xE8
VTD initialization	0xE9
IOAT initialization	0xEA
DFX initialization	0xEB
NTB initialization	0xEC
Security Initialization	0xED
IIO late initialization	0xEE
IIO On ready to boot event	0xEF

## 5-9 BIOS POST Beep code (AMI standard)

### 5-9-1 PEI Beep Codes

# of Beeps	Description
1	Memory not Installed.
1	Memory was installed twice (InstallPeiMemory routine in PEI Core called twice)
2	Recovery started
3	DXE IPL was not found
3	DXE Core Firmware Volume was not found
4	Recovery failed
4	S3 Resume failed
7	Reset PPI is not available

### 5-9-2 DXE Beep Codes

# of Beeps	Description
1	Invalid password
4	Some of the Architectural Protocols are not available
5	No Console Output Devices are found
5	No Console Input Devices are found
6	Flash update is failed
7	Reset protocol is not available
8	Platform PCI resource requirements cannot be met

## 5-10 BIOS Recovery Instruction

The system has an embedded recovery technique. In the event that the BIOS becomes corrupt the boot block can be used to restore the BIOS to a working state. To restore your BIOS, please visit the Gigabyte website: <https://www.gigabyte.com> and search for the specific product and find the document: **Easy BIOS Refresh User's Guide** from **Manual**.