

Lenovo

ThinkVision

T86 Smart Large Format Display

User's Guide

Machine Type:62F0

Think

Product Number

62F0-KATA-WW

Type/Model

L21856UT0



First Edition (March 2022)

© Copyright Lenovo 2022 All rights reserved.

LENOVO products, data, computer software, and services have been developed exclusively at private expense and are sold to governmental entities as commercial items as defined by 47 C.F.R. 2.101 with limited and restricted rights to use, reproduction and disclosure.

LIMITED AND RESTRICTED RIGHTS NOTICE: IF products, data, computer software, or services are delivered pursuant a General Services Administration "GSA" contract, use, reproduction, or disclosure is subject to restrictions set forth in Contract No. GS-35F-05925.

Contents

Chapter 1	Getting started with your Smart Large Format Display (LFD)	1-1
	In the box.....	1-1
	Wall Mounting.....	1-2
	Setup the product.....	1-3
	Interface	1-3
	User controls.....	1-5
	Startup & Shutdown.....	1-5
	Features and specs.....	1-6
Chapter 2	Explore your smart large format display	2-1
	Quick Access Controls	2-1
Chapter 3	Troubleshooting	3-1
Appendix A	Important safety information	A-1
	General Safety guidelines.....	A-1
	Maintenance.....	A-2
Appendix B	Usage Precautions	B-1
	Health Tips	B-2
	Adjustment and Using.....	B-3
Appendix C	Service and support	C-1
	Online technical support	C-1
	Telephone technical support	C-1
	Service information	C-1
Appendix D	Compliance information	D-1
	Recycling information.....	D-1
	Collecting and recycling a disused Lenovo computer or monitor	D-1
	Disposing of Lenovo computer components	D-1
	Energy Star Compliance	D-2
Appendix E	Notices and trademarks	E-1
	Trademarks	E-2

Chapter 1 Getting started with your Smart Large Format Display (LFD)

This User's Guide contains detailed information on the ThinkVision® T86 Smart Large Format Display (LFD), for a quick overview, please see the Setup Poster that was shipped with your LFD

In the box

The product package should include the following items:

- Smart Large Format Display
- Wall hanger -2 vertical beams
- Wall hanger -1cross beam
- Setup Poster
- Warranty card
- Power Cord
- HDMI Cable (3m)
- Remote control
- Touch Pen (2)
- AAA Battery (2)
- USB cable (A to B interface) (3m)

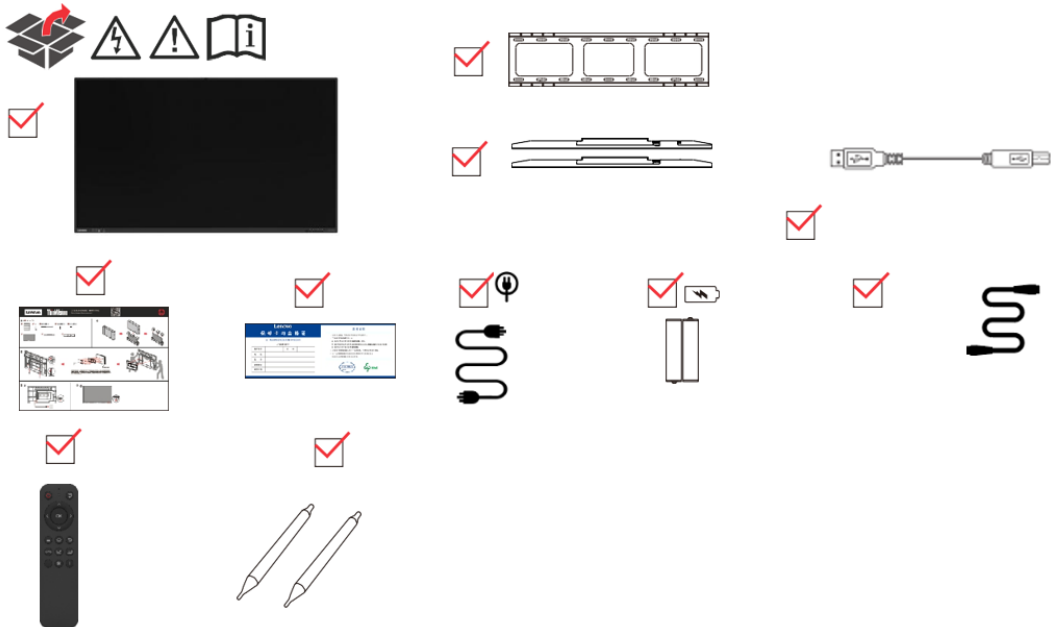

*: Depending on many factors such as the processing capability of peripheral devices, file attributes, and other factors related to system configuration and operating environments, the actual transfer rate using the various USB connectors on this device will vary and is typically slower than the data rates as defined by the respective USB specifications: -5 Gbit/s for USB 3.2 Gen 1; 10 Gbit/s for USB 3.2 Gen 2.

Wall Mounting

Installation notes

- To install the wall hangers, at least two or more professionals are required to carry out all the installation work of the product at the same time. Users should not install by themselves without authorization to avoid harm caused by improper installation.
- Be sure to confirm the installation location with the assistance of professionals during installation so that the strength can support the total weight of the product and the wall hangers for a long time and take proper measures to ensure that it has sufficient strength to withstand the effects of external forces. The hanging point should be directly stressed on the wall. Do not install it on a decorative structure or plaster board with insufficient strength, etc.
- The product should be installed on a vertical plane rather than on an inclined plane or upward for fear that the product falls and personal injury occurs.
- To prevent accidental damage to the product and personal accidents, try to install the hangers in places out of the reach of children.
- During installation, make sure that the screws and fasteners are tightly connected to avoid personal injury due to fall-off of the product caused by loose screws.
- Leave adequate ventilation space around the product as shown below:

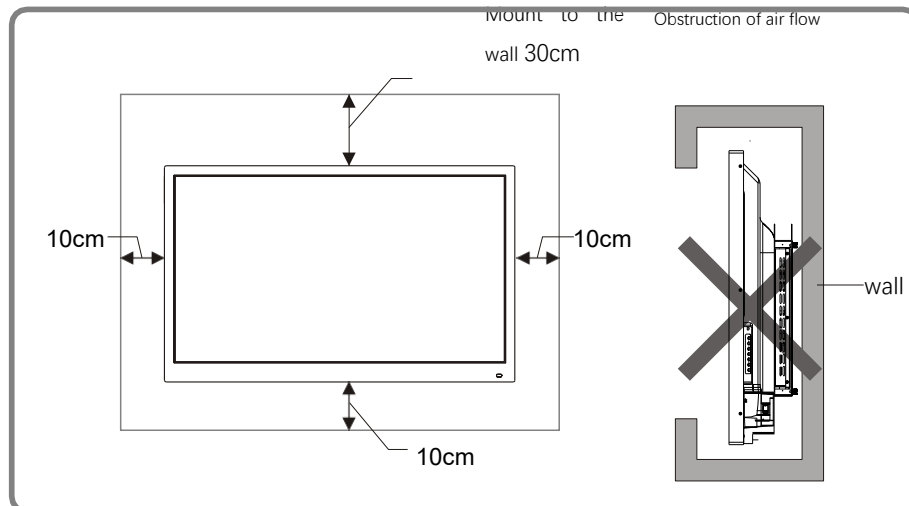









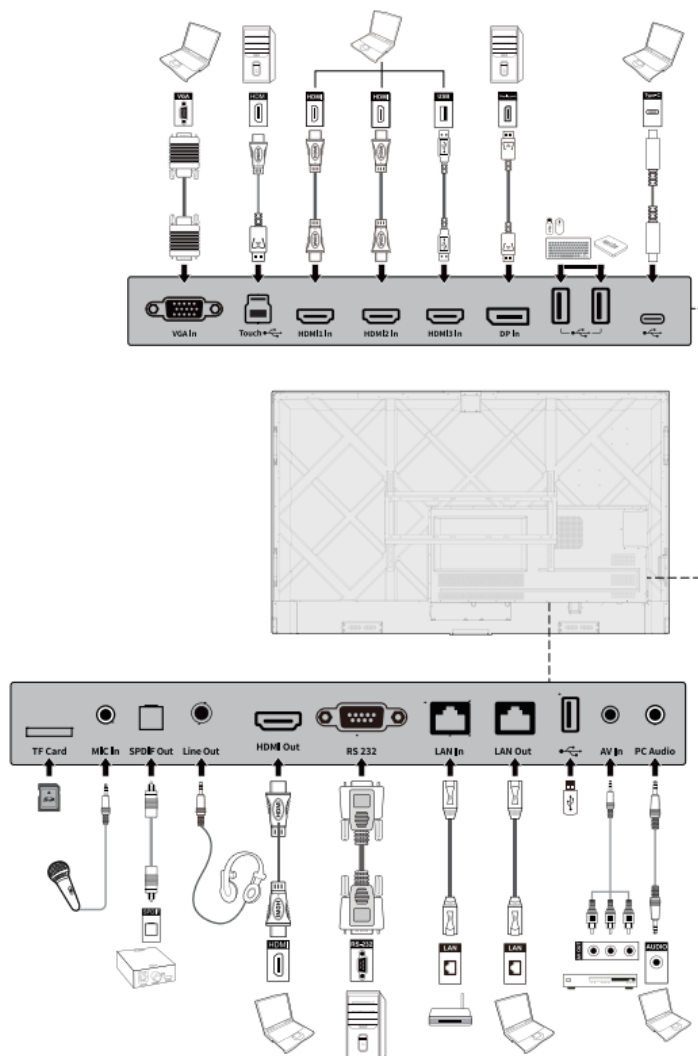







For detailed installation steps, see the Setup Poster.

Setup the product

Interface

Note: This section describes how to connect various interfaces, the listed interface types are for reference only.



Icons	Name	Functions
	Micro SD (TF Card)	Micro SD (TF Card) slot interface for external expansion storage
	MIC In	Microphone input port
	SPDIF Out	Digital audio port. Connected audio equipment with fiber optic input, such as power amplifier, stereo, speakers
	Line Out	Connect to audio device such as headphone and speaker
	HDMI Out	Connect to an electronic video device with HDMI In
	RS232	Serial port signal input port, which allows inputting serial port settings through a specific serial port control device to control the machine.
	LAN In	Ethernet port for connecting to network switch
	LAN Out	Network port for connecting another LFD LAN in port
	AV In	For connecting to DVD or STB
	PC Audio	Audio input port, work with "VGA In" as audio input source.
	VGA In	VGA signal input port
	Touch	Connect to the USB port of PC, thus can use touch screen to control your PC.
	HDMI 1、2、3 In	HDMI input ports, can work with "Touch" port above to access the touch screen
	DP In	DisplayPort to connect with computer, can work with "Touch" port above to access the touch screen
	USB	Connect to USB sink devices, such as mobile HDD, U disk, USB keyboard and mouse. When the display screen is in Android mode, the USB device can be accessed via Android. When video source switched to OPS channel, the USB device is accessed to by OPS.
	USB-C	Connect host device, i.e., OTG USB disk, MAC, PC, mobile phone and other devices with Type-C interface. It can delivery USB, Video and touch screen instructions.

User controls

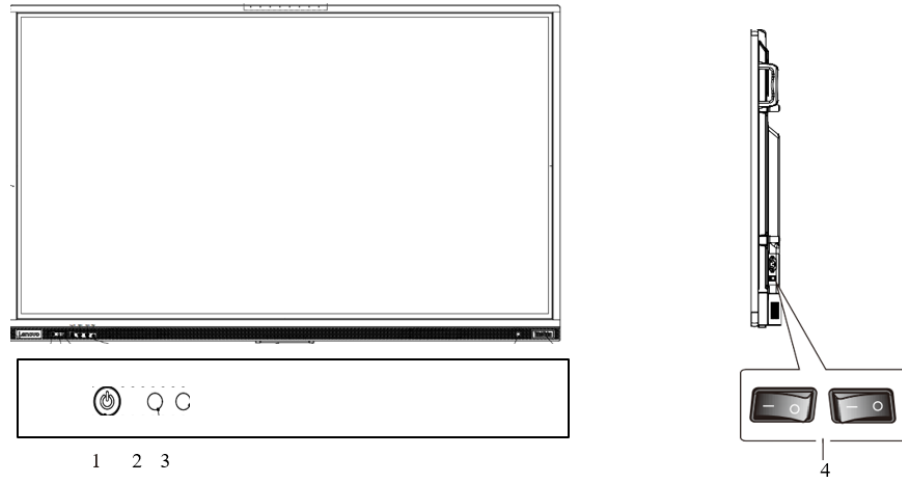



1. :
 - a. Short press the button to shut down the product (system default)
 - b. After the system hibernation function is enabled: short press the power button to turn off/wake up the screen, long press the power button to shut down the product.
 2. Remote control receiver: Remote control signals (up/down 15°, left/right 30°, at least 5m of remote control distance)
 3. Light sensor: ambient sensing (5 options: 0%, 20%, 40%, 60%, 80%, 100%)
 4. AC power switch
-

Startup & Shutdown

On/Off

The T86 is designed operate using 100 – 240V AC.

The button  on the panel and remote control is a unipolar switch, press this button to switch between power on or standby state when the power is on.

The button  on the back panel is the all-polarity switch, switch "O" to turn off the power, switch "I" to turn on the power.

Auto Stand-by

On android's homepage, the device does not enter standby mode, regardless of whether there is a valid input signal.

On the non-Android homepage, if there is no input signal for more than 15 minutes in any signal source channel, the machine will enter standby mode automatically.

Save before shutdown

When shut down, the machine will save the image and sound settings. When turned on again, the machine will be in the state before it was shut down.

Timing switcher

Users can set the required on/off time.

OPS Switch

When the machine is installed with OPS module, the OPS will start automatically if the machine is powered on at the OPS source or switched to the OPS source from another source. If the OPS does not start on its own, it can be started manually. Please shut down OPS before shutting down the machine. User can shut down the machine only after OPS is completely shut down, otherwise, the OPS will be damaged due to forced shutdown.

After the OPS enters the closed state, the computer will enter the standby state if it does not take any operation for a long time. If you need to use OPS again, you can restart the machine

Features and specs

Specification	Parameter
Screen Size	86"
Backlight Type	LED
Aspect Ratio	16:9
Viewing Angle	Horizon:178° Vertical:178°
Resolution	3840 × 2160 Pixel
Working Voltage	100 - 240V, 50/60Hz
Stand-by Power Consumption	< 0.5W
Rated Power (No OPS plug in)	410W
Max Power (OPS operating)	550W
Rated Current	Max 5.5A
Energy Saving (Backlit off)	≤ 225W
Speaker	15W×2
Cover Glass	Tempered glass
Touch Sensing Technology	Infrared
Touch Points	20 points
Viewable image size	1895.04 mm×1065.96 mm
Dimension (width x height x depth)	1982.0 x1209.2 x92 mm
Storage Temperature/Humidity	-15°C~ 55°C/20%RH ~ 90%RH (Non coagulation)
Operating Temperature/Humidity	0°C~45°C/20%RH ~ 80%RH (Non coagulation)
Installation Method	Wall hanging or floor stand support
Net Weight	67.65kg
Gross Weight	86kg







Chapter 2 Explore your smart large format display

This section describes the basic operation functions of the display.

Quick Access Controls

Under any channel, there is a sidebar shortcut arrow on the left and right, touch the screen to bring up the sidebar function menu.

The menu includes the following functions:

Icons	Functions
	Expand/hide the floating bar
	Return to the Android launcher
	Return to the previous menu
	Enter annotation mode
	Source selection
	Bring up the task management sidebar

Source Switching

When switching the source, you can use the remote control or touch function to select. The selection method is as follows:

Method One: Press the "" button of the remote control to bring up the "Signal Source Menu", then press the cursor key of the remote control to select the signal source, press the "OK" button of the remote control, and the machine will switch to the input signal source selected by you.

Method Two: Select the sidebar menu, click the source icon, select the signal source, the machine will switch to the input signal source of your choice.



Note: The picture is for reference only, please refer to the actual signal source menu.

Network Settings

Enter the Network sub-menu, you can set Wi-Fi, Ethernet, Hotspot Setting, and Other Settings.

1. Wi-Fi: View the MAC address of the device and enable or disable Wi-Fi.
2. Ethernet: View the MAC address, IP address, gateway, subnet mask, and DNS information of the device. You can automatically obtain the LAN IP address or set a static IP address as required.
3. Hotspot Setting: You can set items related to portable Wi-Fi hotspots (To enable the screen casting function, you need to enable the hotspot first)
4. Bluetooth: It can be connected with Bluetooth devices (e.g. mobile phone, headset, computer)

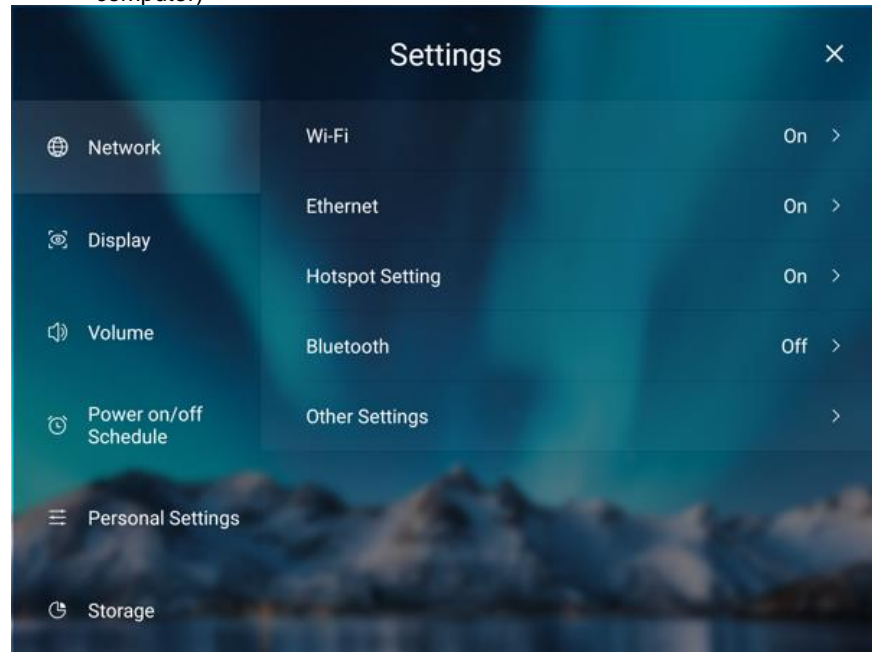

5. Other Settings: You can set network reset, network proxy.

Display

Enter the Display menu, you can set the screen backlight brightness and wallpaper information.

1. Brightness: You can set automatic adjustment or manual adjustment, manual adjustment of the brightness from 0 to 100.
2. Wallpaper Settings: You can select the wallpaper delivered with the system or a custom wallpaper rer.

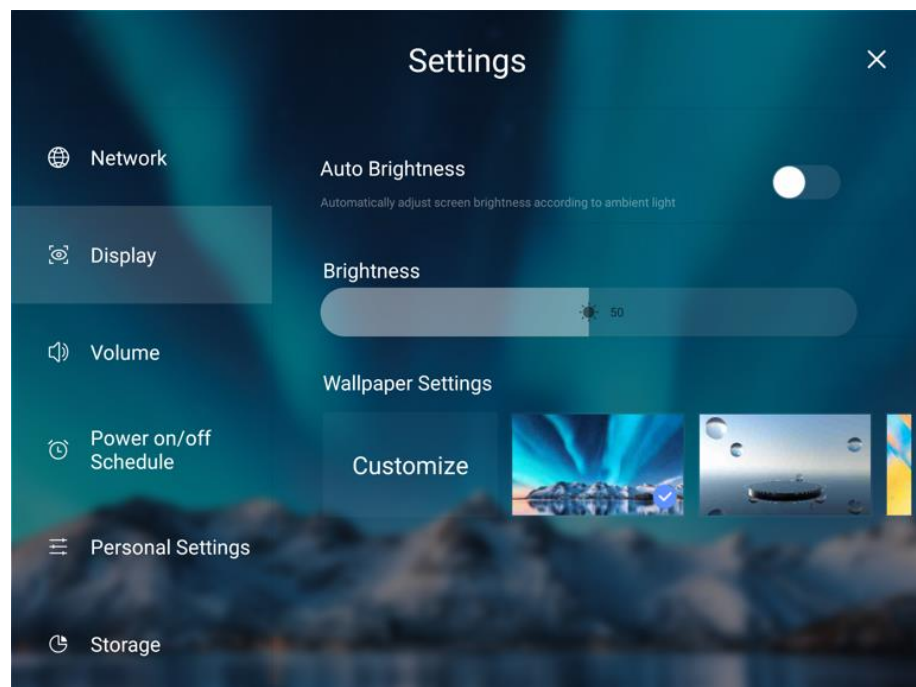

Volume

Enter the volume submenu, you can set the media and alarm tone. Slide your finger left or right to adjust the volume. The volume range is 0-100

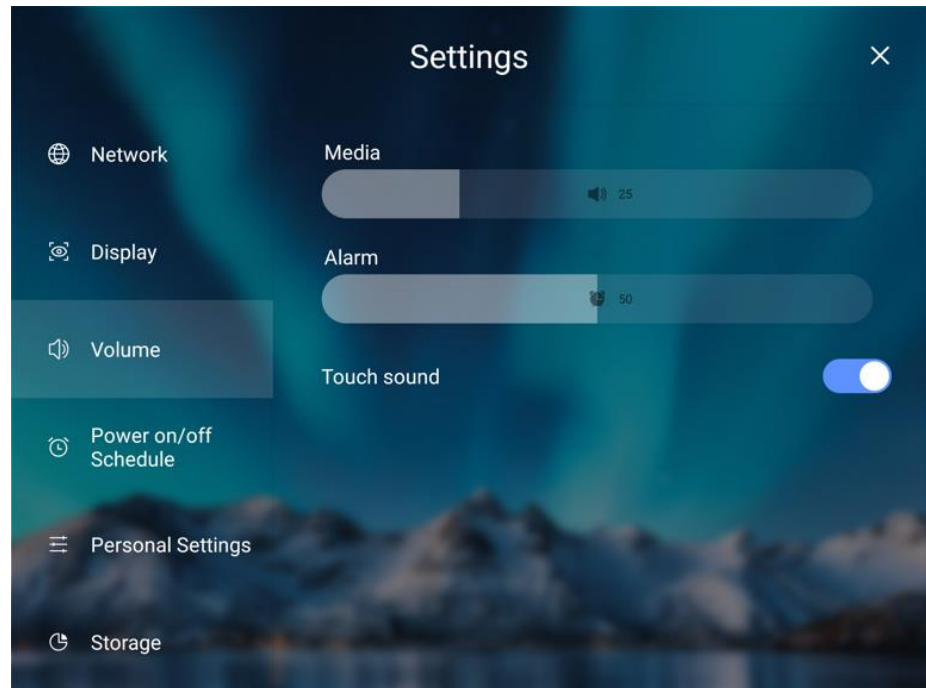

Power on/off Schedule

Enter the sub-menu of "Power on/off Schedule ", you can set auto power on and off or customize the switch time (the startup time is repeated by default)

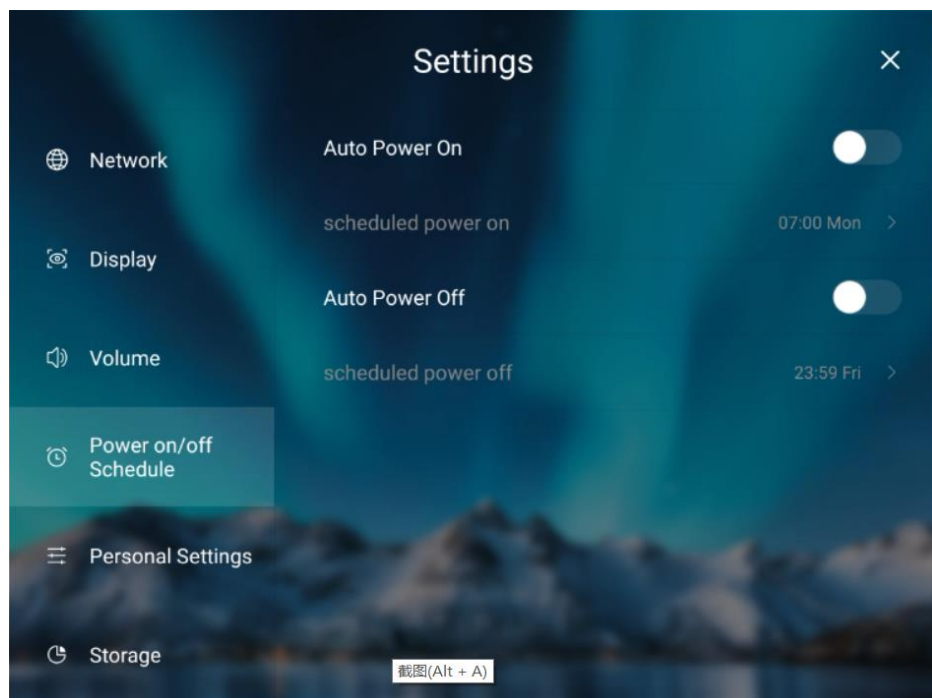

Personal Settings

The “Personal Settings” menu allows the user to customize the USB device, camera, microphone and touch for wakeup etc. settings.

1. Subordinate system of USB device: Android, Adaptive. When select Android, all the USB device will be accessed by local Android system. If user select Adaptive, the USB devices will be accessed by the external host (i.e. computer). For example, current source is USB-C, the USB device (microphone, camera, USB ports) could be accessed by USB-C computer.
2. Screen off setting: enable/disable the sleep mode. When sleep mode is enabled, if there is no video source input or no operation within the specified time, the device will automatically sleep and Windows will shut down.
3. Screen on setting: enable/disable the Touch to Wake-up. When this function is enabled, the user can touch the screen to wake up the device.
4. Standby: If there is no operation or signal within 60 minutes, the device automatically standby and Windows shuts down
5. Power on to Enter: you can set the signal source after power-on. The options are HDMI1, HDMI2, VGA, FRONT HDMI and the last channel.
6. Microphone: Device microphone control switch
7. HDMI Output Version: V1.4 and V2.0
8. CEC Auto Power on:
Enable this function can turn on LFD by external HDMI device (i.e., DVD player) through CEC command.
9. CEC Auto Power Off:
LFD can be turned off by external HDMI device through CEC command.

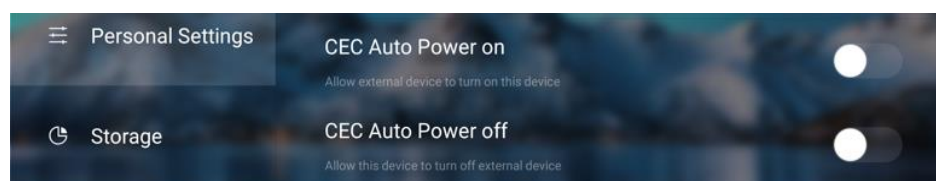
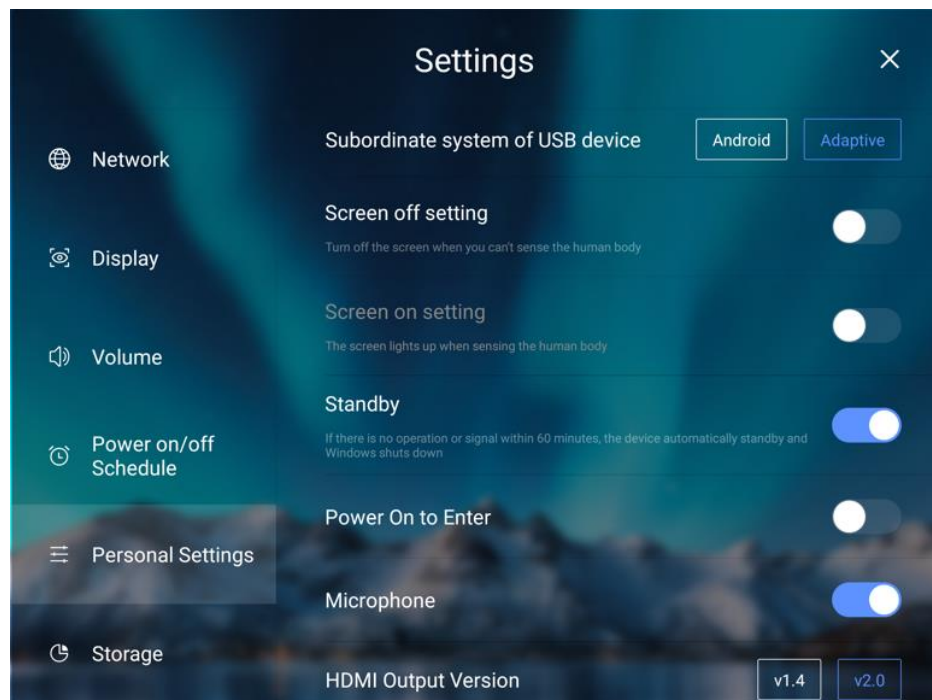

Storage

The “Storage” submenu allows the user to view the memory capacity and storage space usage.

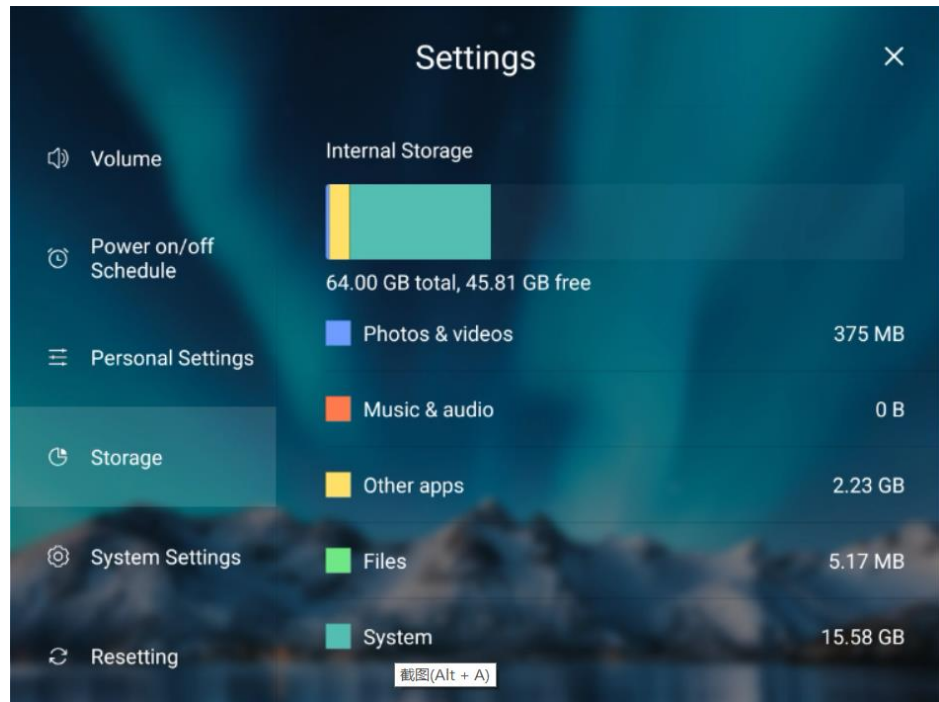

System Settings

The “**System Settings**” submenu allows the user to view device information and set time, date, language, and input method.

1. About the Device: View device name (customizable), Android version and firmware version.
2. Date and Time: The user can customize for the device to automatically get the Internet date and time, customize the date and time, and choose whether to enable the 24-hour format.
3. Language and Keyboard: The user can set their preferred language and input method.

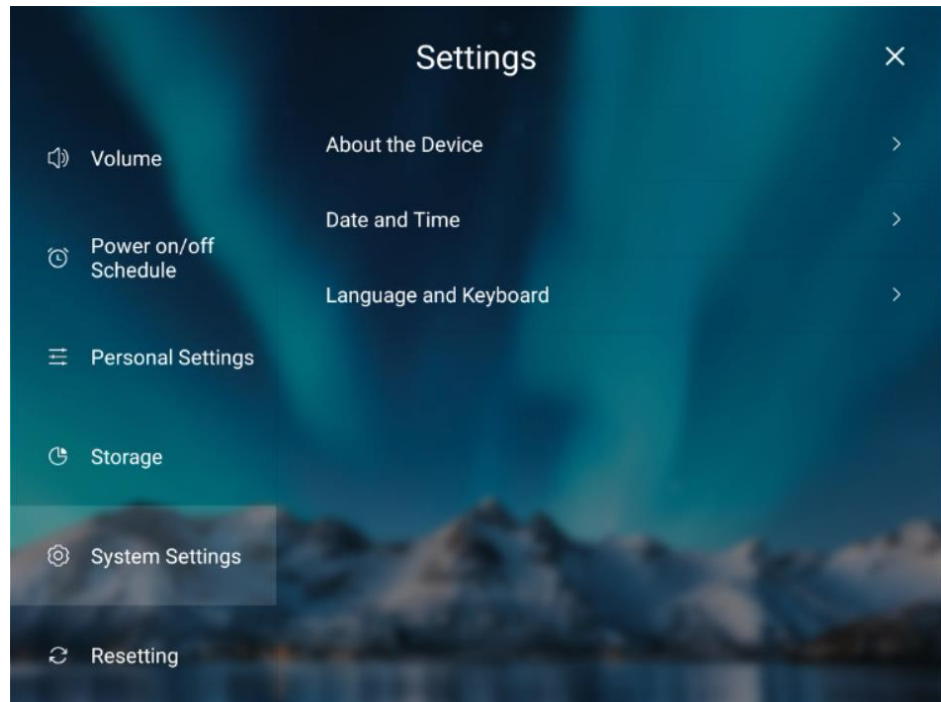

Reset

The "**Reset**" submenu allows the user to restore factory settings, this operation will clear all data on the device. Please use with caution!

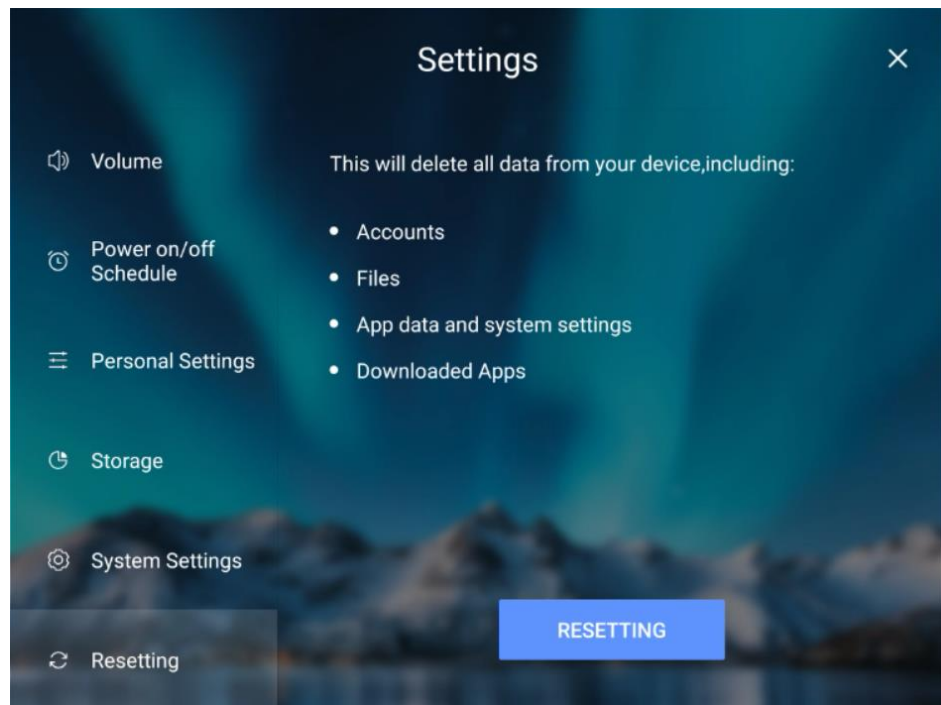

Annotation

At this mode, user can annotate on current screenshot.

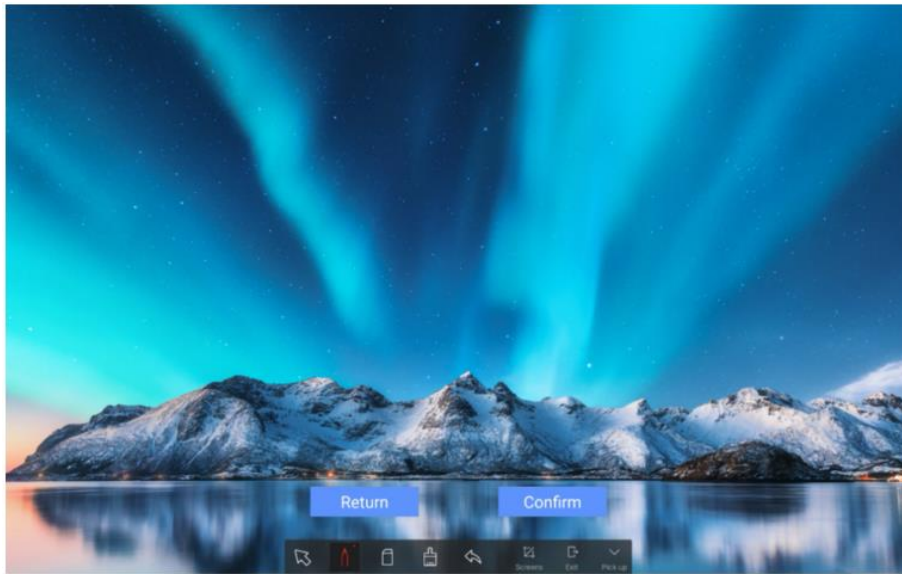

1 2 3 4 5 6 7 8

No.	Name	Functions
1	Select	Tap this icon to return to the current interface from the annotation mode.
2	Pen	Tap the icon to enter the writing state. Tap again to set the pen color and thickness.
3	Eraser	Tap the icon to enter the eraser function. Tap again to set the eraser size.
4	Clear Screen	Clear all content on the current page.
5	Cancel	Return to the previous step.
6	Screenshot	Capture the current comment page, and the images can be selected to import whiteboard or sharing.
7	Exit	Tap the icon to exit annotation mode.
8	Hide Toolbar	Tap the icon to hide or show the toolbar.

Home

The home page contains time, date, USB flash drive information, network information, hot spot information, whiteboard and file manager shortcuts. More Apps list include system applications and third-party applications.

Note: The background and icons of the home page are subject to actual objects.



★Special tips:

Users can load application programs by themselves. Operation methods vary according to application programs.

The operation methods of application programs described in this manual are for reference only.

Whiteboard

The whiteboard function is designed to present conference writing to attendees in a quick and easy manner. Users can write, draw and take screenshots on the whiteboard page.

The user can enter the whiteboard interface through the following two methods:

1. Tap the “whiteboard” icon in the toolbar on the homepage to enter the whiteboard interface.
2. Tap the “whiteboard” icon in the “More Apps” interface to enter the whiteboard interface.

Whiteboard writing software includes selection, background setting, brush setting, undo, redo, text, clear screen, save, import pictures, spotlight, split screen selection and other functions

Note: Writing software functions will be updated in real time, please refer to the actual object.

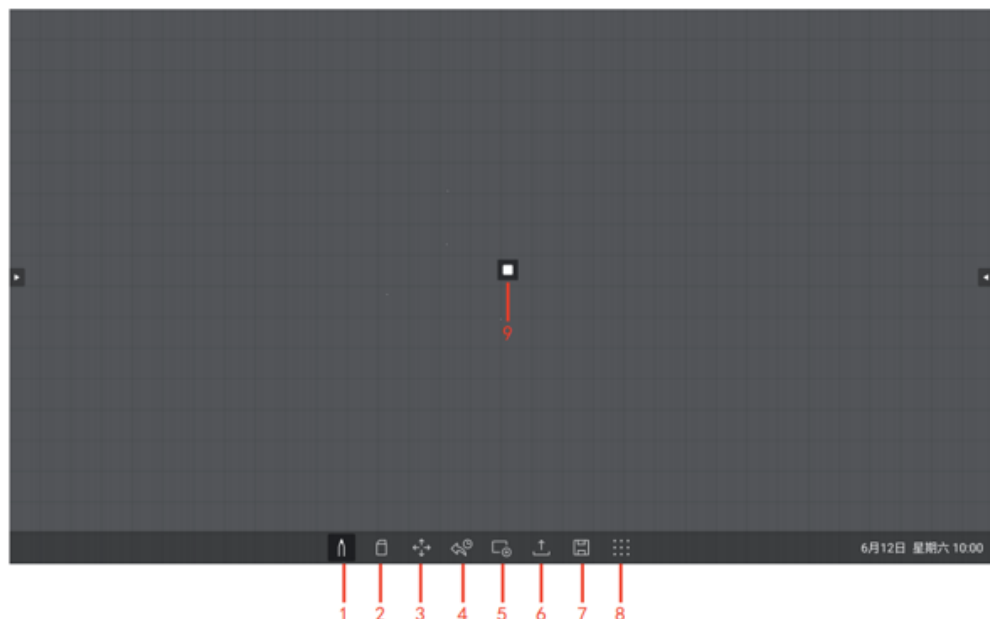

No.	Name	Functions
1	Brush tool	Support to preset 6 colors + universal palette, adjust brightness, select the pen type of whiteboard pen + Mark pen and set thickness of fine, medium and broad options
2	Eraser	Support to select eraser size of fine, medium and broad options, select local erasure, clear the screen with one click and use clear all-content gesture and support the use of the back of the hand for erasure
3	Thumbnail navigation	Support to locate the content you want to find in the thumbnail navigation and select three display modes of Display Center, Actual Size and Display All.
4	Time backtrack	Support to return in unlimited steps, all minutes of the meeting process writing contents and to undo or restore the minutes in a single operation.
5	Page management	Support to implement canvas paging of 1-6 pages, add or delete the pages.
6	One-click share	Support to record meeting minutes, write annotations and other contents, and view, share and save by one-click code scanning and support to share the current window.
7	Save source file	Support to save the whiteboard source file and continue to edit next time it is opened. Support default name and manual name
8	More	Insert Picture: support to insert PNG and JPG formats, adsorb pictures by 45°, erase pictures by eraser, and add up to 4 pictures; Insert File: open a third-party file which can be used with the LFD annotation function; Insert Web Page: support to insert a web page in Windows, switch between writing mode and operation mode, and take full-screenshots, and insert up to 1 web page; Open Whiteboard: support to open whiteboard source files and edit them again; Set Whiteboard: support to set toolbar follow, floating menu, simulated touch, background setting and network setting; About Whiteboard: support to display the current version of whiteboard, software license agreement, open source component license, privacy statement and software update check; Exit: support to exit without a trace, that is, you can delete whiteboard files, system screenshots, and screen and sound recording and other files with one click after a meeting.
9	Floating Toolbar	Press and hold the screen with the finger for more than 2s and then release it release the call out the floating toolbar which is convenient for users to quickly use the whiteboard common tools. Note: The floating toolbar will automatically hide if no operation within 2s.

File Manager

File manager supports playback of files such as pictures, videos, and audio files. You can press and hold down to move, copy, or delete the selected file.

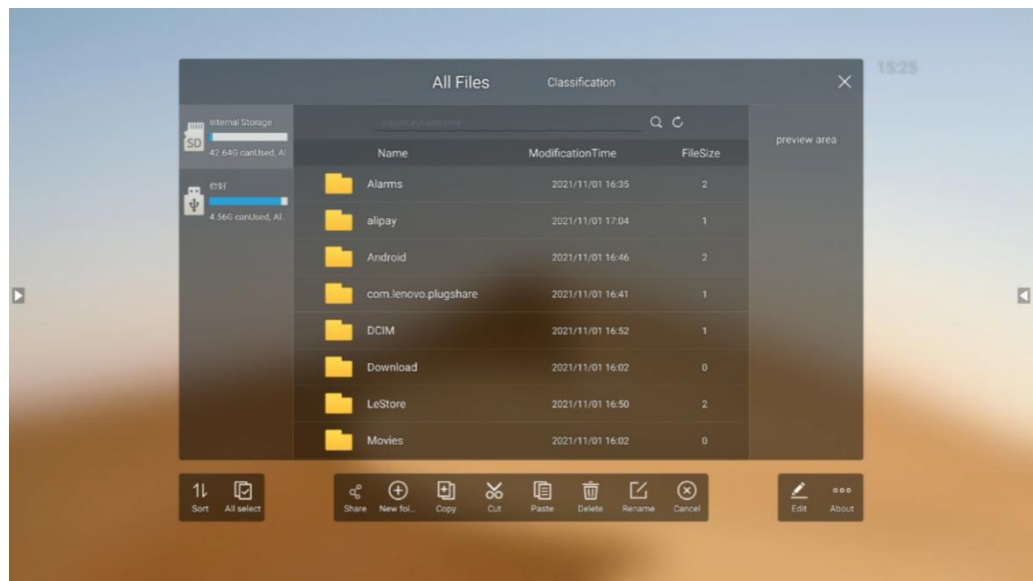

Resolution

VGA Display Mode

No.	Resolution	Refresh Rate
1	640 x 480	60Hz
2	800 x 600	60Hz
3	1024 x 768	60Hz
4	1360 x 768	60Hz
5	1920 x 1080	60Hz

HDMI Display Mode

No.	Resolution	Refresh Rate
1	720 x 480	60Hz
2	1280 x 720	60Hz
3	1920 x 1080	50Hz
4	1920 x 1080	60Hz
5	3840 x 2160	30Hz
6	3840 x 2160	60Hz

HDMI Out Video Output Mode

No.	Resolution	Refresh Rate
1	1920 x 1080	60Hz
2	3840 x 2160	30Hz
3	3840 x 2160	60Hz

Understanding power management

The indicator has two colors: green and red, the system status is as follows :

Indicator	Status
Off	Shut down or power disconnected
Red	Standby
Red on, green flashes once every 3 seconds	Sleep mode
Green	Screen off/normal working state
Green on, red flashes once every 3 seconds	Locked screen

Comment: Shutdown suggests total power off so no power to allow the LED to display, I think standby is better.

Chapter 3 Troubleshooting

If you have a problem setting up or using your LFD, you might be able to solve it yourself. Before calling your dealer or Lenovo, try the suggested actions that are appropriate to your problem.

Issue	Possible Reason	Solution
There's nothing on the screen, no sound, no light	The power not connected	Check whether the power cable is properly connected at both ends.
No image is on your screen or a "No Input" message appears when switch the input from USB type-C, HDMI or OPS	Your LFD is not receiving a video signal	Ensure the video cable connecting to your computer. Ensure your computer have external video connection enabled.
	Your computer is in standby mode.	Move the mouse, or press the keyboard of your computer to wake up the system.
	Your computer is off.	Turn on your computer by pressing the power button of your computer. In OPS mode, select other source (i.e. HDMI), then select OPS source again to power on OPS.
The display image offset, unsatisfactory screen, over screen, fuzzy display, distortion	Your computer's video resolution settings don't match your LFD's native resolution.	Change your computer video's resolution to 3840x2160 @ 60hz from control panel of OS.
LFD not responding correctly to the remote control	1. There is something blocking the IR Receiver on the LFD. 2. The batteries on of the remote control need to be replaced.	1.Remove items to avoid blocking the remote reception window 2.Replace batteries
System halted, unable to operate the LFD.	1. Too many applications running. 2. The normal operation of the machine is disturbed by the external environment (such as lightning, static electricity, etc.)	Switch of the main power switch for 1 to 2 minutes to reset the LFD.
Touch is slow and malfunctioning	Too many applications running.	Clearing accounts for a larger operation of the program or restart the machine.
Can not control your external computer through touch screen	No USB signal connection between LFD and your computer	If your computer connect LFD by HDMI cable, please connect one USB (A to B) cable too.
Your computer can not access camera and microphone of LFD	No USB signal connection between LFD and your computer	If your computer connect LFD by HDMI cable, please connect one USB (A to B) cable too. Switch the computer source to HDMI in LFD's setting
OPS cannot be started normally, and there is no display, no touch	OPS is not fixed	Reinstall the OPS computer.
Touch offset	Touch System needs to be calibrated.	Use the Control Panel to calibrate the Touch System.

Appendix A Important safety information

General Safety guidelines

For tips to help you use your computer safely, go to:

<http://www.lenovo.com/safety>

Before installing this product, read the Safety Information.

This equipment is not suitable for use in locations where children are likely to be present, avoid hurting your child when machine falling down.

مع، يجب قراءة ذات السلامة

Antes de instalar este produto, leia as Informações de Segurança.

在安裝本產品之前，請仔細閱讀 **Safety Information** (安全信息)。

Prije instalacije ovog produkta obavezno pročitajte Sigurnosne Upute.

Před instalací tohoto produktu si přečtěte příručku bezpečnostních instrukcí.

Læs sikkerhedsforskrifterne, før du installerer dette produkt.

Ennen kuin asennat tämän tuotteen, lue turvaohjeet kohdasta Safety Information

Avant d'installer ce produit, lisez les consignes de sécurité.

Vor der Installation dieses Produkts die Sicherheitshinweise lesen.

Πριν εγκαταστήσετε το προϊόν αυτό, διαβάστε τις πληροφορίες ασφαλείας (safety information).

לפני שתתקינו מוצר זה, קראו את הוראות הבטיחות.

A termék telepítése előtt olvassa el a Biztonsági előírásokat!

Prima di installare questo prodotto, leggere le Informazioni sulla Sicurezza

製品の設置の前に、安全情報をお読みください。

본 제품을 설치하기 전에 안전 정보를 읽으십시오.

Пред да се инсталира овој продукт, прочитајте информацијата за безбедност.

Lees voordat u dit product installeert eerst de veiligheidsvoorschriften.

Les sikkerhetsinformasjonen (Safety Information) før du installerer dette produktet.

Przed zainstalowaniem tego produktu, należy zapoznać się

z książką "Informacje dotyczące bezpieczeństwa" (Safety Information).

Antes de instalar este produto, leia as Informações de Segurança.

Перед установкой продукта прочтите инструкции по технике безопасности.

Pred inštaláciou tohto produktu si prečítajte bezpečnostné informácie.

Pred namestitvijo tega proizvoda preberite Varnostne informacije.

Antes de instalar este producto lea la información de seguridad.

Läs säkerhetsinformationen innan du installerar den här produkten.

សូមអានព័ត៌មានសុវត្ថិភាព មុនពេលចាប់ផ្តើមបញ្ចូលកម្មវិធី

安裝本產品之前，請先閱讀「安全諮詢」。

Maintenance

Important Safety Information

The power cable is dedicated to the smart screen. If you want to use a different power cable, only use the power cable that matches the smart screen.

To prevent the machine from being damaged, do not use any cables other than the one provided with the machine.



Please do not overload the power sockets and make sure that the sockets you use are certified by the state for safety.

The socket-outlet shall be installed near the equipment and shall be easily accessible.



The power cable in the attachment is a three-socket power cable (with grounding protection). Ensure that the ground terminal of the wall socket is properly grounded.

When wiring power cables, avoid channels to avoid trampling. You should also avoid areas that are squeezed by other objects.



In case of a thunderstorm, pull out the power plug and cable plug and disconnect the device from the antenna to avoid damage to the device.

The disconnection from line voltage is made by pulling the mains plug.



If the product is not used for a long time, please turn off the power and unplug the power plug.

If there is any abnormal sound or smell, please immediately turn off the power and unplug the power plug. If it is confirmed as abnormal, do not continue to use it. Contact the product maintenance personnel for repair as soon as possible.



Do not place inflammable and explosive objects on the machine, such as candles, electric stoves and light bulbs should not be placed on or near the machine to avoid accidents.



Be careful of liquid and metal foreign matter falling into the machine. If any liquid or metal foreign matter falling into the machine, please do not turn on the machine and contact professional personnel to deal with it as soon as possible.



After the machine is moved from a low temperature environment to a warm area, dew may occur inside the machine. In order to make the dew fully distributed and dry, it should be placed for 24 hours before powering on and starting up.



When moving the machine, it should be completed by two or more people, and the impact should be avoided during the moving process, and the display screen should be specially protected.



In order to prevent accidental injury, the machine must be installed on a flat and stable ground according to the installation instructions; or according to the wall mounting bracket installation instructions to firmly fix the machine on the wall

Do not install the machine in an improper place, such as:



- Do not install or place the machine near a heat source, or place it in direct sunlight, in a dusty or humid environment.
- Poor ventilation or closure.
- Storage or use of flammable and explosive materials environment.
- An environment with flammable or corrosive gases.



Do not expose the battery to excessive heat, such as sunlight or fire. Otherwise, it may explode.

Appendix B Usage Precautions

- Please do not disassemble or assemble this product by yourself in any way. Opening or removing the cover without authorization may expose you to dangerous voltage or other hazards. If you have any maintenance matters, please contact professional maintenance personnel for handling.
- If the unit is dirty, please unplug the unit and wipe it with a soft semi-dry cloth dipped in a small amount of water, do not repeatedly wipe the display to avoid scratches. Do not use alcohol, gasoline, acid, alkali, detergent, volatile oil, thinner and other solvents to wipe the machine. These solvents may cause material deterioration or damage the paint surface.
- Under the environment of high humidity, there may be water mist inside the screen, which is normal. This is due to the reason of weather humidity and temperature caused by the difference in temperature between the outer glass and the inner glass surface to produce condensation in the glass inner surface of the small water droplets. It will disappear automatically after 24 hours of normal use. Please feel free to use it.
- Do not put any sharp objects or metal objects into the cooling hole or touch the signal connector to avoid damage or electric shock caused by short circuit.
- The main material of the LCD screen is glass, which is fragile. Do not apply pressure to the LCD screen to avoid damage.
- Do not place the machine on an unstable trolley, shelf or table, which may cause the machine to tip over. The machine should be moved with care when placed on a cart. A quick and sudden stop, too much force or uneven ground can cause carts and machines to tip over.
- The openings on the machine are designed for ventilation and heat dissipation to ensure the reliable operation of the components in the machine and prevent overheating. Ventilation should not be impeded by covering such items as newspapers, tablecloths and curtains.
- Do not let the machine for a long time to display the same picture or the active picture contains a long time fixed text, icons, etc., this will leave "residual shadow" on the screen, and does not disappear in a long period of time after shutdown the machine.

Health Tips

1. As to this product, in OPS computer channel or external signal mode, press the remote control volume +, up, down, volume - in turn to bring up the image setting menu and select the eye comfort mode (as shown below). The eye comfort display mode meets the requirements of TUV eye comfort certification and can improve the user's eye comfort when enabled.

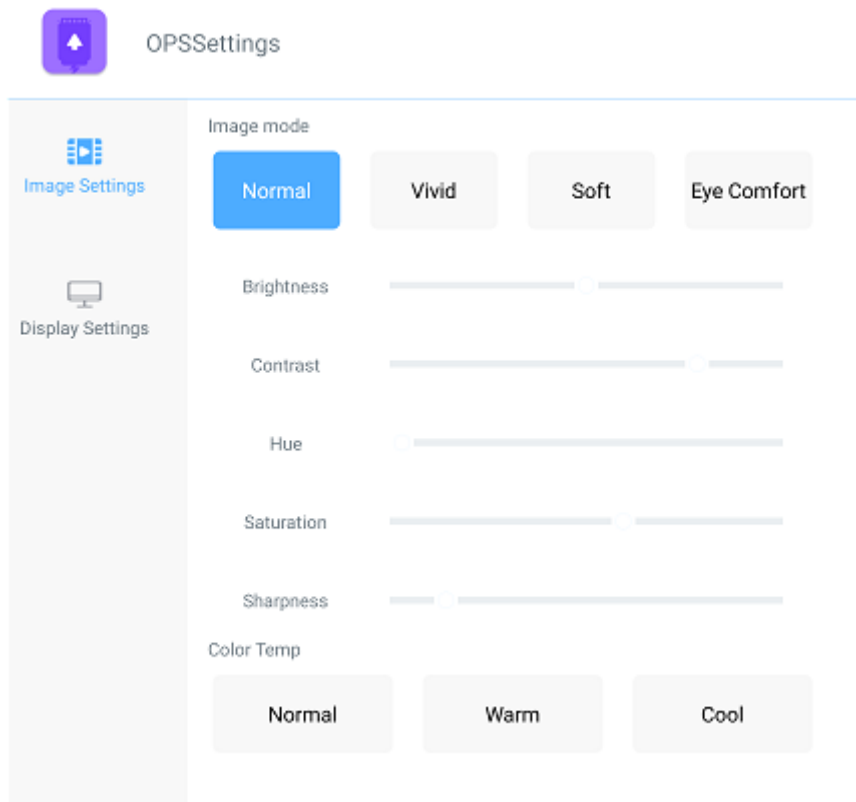

2. Please set an optimum image quality to keep your eyes in a relaxed state.
3. Please relax your eyes at regular intervals. You are recommended to take breaks after 30min continuously using the LFD. You are also recommended to look at distant objects or do a set of eye exercises to protect your eyes when taking a break.
4. This product has passed the TUV hardware low blue-light certification, which can reduce the blue light damage to the user's eyes.
5. This product can also meet the requirements of TUV strobe-free certification, and have no visible and invisible strobe within 0-3000Hz.

Adjustment and Using

- **Comfort and accessibility**
 - 1. Install the product at an appropriate height to allow you to work in comfort.
 - 2. Avoid glare or reflection from overhead or nearby windows.
 - 3. Use appropriate lighting according to your working type.
 - 4. Adjust the monitor's brightness, contrast and image to meet your visual preferences.
 - 5. Keep your screen clean so that you can focus on what is displayed on the screen.
 - 6. Any sustained and concentrated visual activity will let your eyes get tired. Be sure to take your eyes off the monitor screen periodically and stare at distant objects, which will allow your eye muscles to relax. If you have questions about eye fatigue or visual discomfort, consult a vision care professional for advice.
 - 7. Prolonged exposure to computer screens may cause temporary visual fatigue. Work environment, work habits and posture, screen flicker, blue light and other unfavorable factors may cause this situation. To minimize visual fatigue, you can make some adjustments while working or use a suitable computer screen to relieve eye fatigue.
- **Work habits**
 - 1. Visual fatigue is influenced by the work environment. Reducing glare and using proper lighting are conducive to lowering the occurrence of such situation.
 - a) Change the location of any light sources that cause the glare.
 - b) Install appropriate diffusers or lamp shades for light sources.
 - c) Use curtains or louvers on windows to reduce the glare from direct sunlight.
 - d) Adjust the position of the monitor so that it is perpendicular to the light source or window.
 - e) Use anti-glare screen- Lenovo smart LFD which has anti-glare finish to disperse light and avoid reflection in use of your work.
 - 2. Lighting
 - Adequate lighting is necessary to avoid glare and eye fatigue. However, in too much or inadequate light, you will be hard to see what is displayed on the screen. The illumination level shall be no more than 750 lux generally. Recommended lighting arrangements include placing the product away from direct sunlight or using overhead lights with baffles or louvers to reduce glare.
 - 3. Prolonged exposure to the screen may lead to eye fatigue. Symptoms include headaches, eyes burning, blurred vision and discomfort. To reduce eye fatigue, computer users can adjust their work habits to allow their eyes to relax and recover.
 - 4. Break time
 - Users should keep away from the screen for a while, especially after working for a long time. In general, a break of 5-15min is recommended after 1-2 hours of continuous work. Short and frequent breaks are preferable to long breaks.
 - 5. Look at distant objects
 - The number of blinks will decrease whenever users are in front of the monitor screen. To reduce eye fatigue and dryness, users should periodically rest their eyes and focus on distant objects.
 - 6. Eye and neck exercises
 - Certain exercises can reduce eye fatigue and prevent early onset of musculoskeletal disorders. Repeating these exercises frequently is suggested. However, if symptoms persist, it is recommended to consult a doctor.
 - Eye exercises:
 - a. Look up and down alternately while keeping your body and head upright.
 - b. Slowly move your eyes to look left and right.
 - c. Move your eyes to look at the object in the upper right corner, then the object in the lower right corner. View the top-left and bottom-left objects in the upper left and lower left corners in the same way.
 - Neck exercises:
 - a. Relax arms on one side. Tilt your head forward and stretch your neck slightly. Hold for 5s.
 - b. Relax arms on one side. Turn right. Hold for 5s. Then turn left.
 - c. Relax arms on one side. Swing your head to the left. Hold for 5s. Then swing your head to the right.

1



2

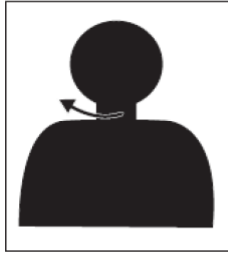

3

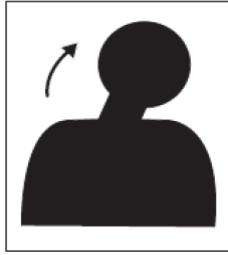

Appendix C Service and support

The following information describes the technical support that is available for your product, during the warranty period or throughout the life of the product. Refer to your Lenovo Statement of Limited Warranty for a fully explanation of Lenovo warranty terms

Online technical support

Online technical support is available during the life of your product through the Lenovo Support Web site at <http://www.lenovo.com/support>

Product replacement assistance or exchange of defective components also is available during the warranty period, assistance for replacement or exchange of defective components is available.

In addition, if your option is installed in a Lenovo computer, you might be entitled to service at your location. Your technical support representative can help you determine the best alternative

Telephone technical support

Installation and configuration support through the Customer Support Center will be withdrawn or made available for a fee, at Lenovo's discretion, 90 days after the option has been withdrawn from marketing, Additional support offerings, including step-by-step installation assistance, are available for a nominal fee.

To assist the technical support representative, have available as much of the following information as possible:

- Option name
- Option number
- Proof of purchase
- Computer manufacturer, model, serial number, and manual
- Exact wording of the error message (if any)
- Description of the problem
- Hardware and software configuration information for your system

If possible, be at your computer. Your technical support representative might want to walk you through the problem during the call.

Worldwide telephone list

Phone numbers are subject to change without notice. For the most current phone Numbers, go to <https://pcsupport.lenovo.com/us/en/premiersupport>

Service information

Customer responsibilities

The warranty does not apply to a product which has been damaged due to accident, misuse, abuse, improper installation, usage not in accordance with product specifications and instructions, natural or personal disaster, or unauthorized alterations, repairs or modifications.

The following are examples of misuse or abuse and not covered by warranty:

- Images burned on to the screen of a CRT monitor. Burned image is preventable by utilizing a moving screen saver or power management.
- Physical damage to covers, bezel, base and cables.
- Scratches or punctures on monitor screens.

Getting further help

If you still can't solve your problem, please contact the Customer Support Centre. For more information on contacting the Customer Support Centre, please see Appendix C, "Service and support " on page C-1.

Appendix D Compliance information

Recycling information

Lenovo encourage owners of information technology (IT) equipment to responsibly recycle their equipment when it is no longer needed. Lenovo offers a variety of programs and services to assist equipment owners in recycling their IT products. For information on recycling Lenovo products, go to:

www.lenovo.com/recycling

環境配慮に関して

本機器またはモニターの回収リサイクルについて

企業のお客様が、本機器が使用済みとなり廃棄される場合は、資源有効利用促進法の規定により、産業廃棄物として、地域を管轄する県知事あるいは、政令市長の許可を持った産業廃棄物処理業者に適正処理を委託する必要があります。また、弊社では資源有効利用促進法に基づき使用済みパソコンの回収および再利用・再資源化を行う「PC回収リサイクル・サービス」を提供しています。詳細は、

https://www.lenovo.com/jp/ja/services_warranty/recycle/pcrecycle/をご参照ください。

また、同法により、家庭で使用済みとなったパソコンのメーカー等による回収再資源化が2003年10月1日よりスタートしました。詳細は、https://www.lenovo.com/jp/ja/services_warranty/recycle/personal/をご参照ください。

重金属を含む内部部品の廃棄処理について

本機器のプリント基板等には微量の重金属（鉛など）が使用されています。使用後は適切な処理を行うため、上記「本機器またはモニターの回収リサイクルについて」に従って廃棄してください。

Collecting and recycling a disused Lenovo computer or monitor

If you are a company employee and need to dispose of a Lenovo computer or monitor that is the property of the company, you must do so in accordance with the Law for Promotion of Effective Utilization of Resources. Computers and monitors are categorized as industrial waste and should be properly disposed of by an industrial waste disposal contractor certified by a local government. In accordance with the Law for Promotion of Effective Utilization of Resources, Lenovo Japan provides, through its PC Collecting and Recycling Services, for the collecting, reuse, and recycling of disused computers and monitors. For details, visit the Lenovo Web site at

https://www.lenovo.com/jp/ja/services_warranty/recycle/pcrecycle/. Pursuant to the Law for Promotion of Effective Utilization of Resources, the collecting and recycling of home-used computers and monitors by the manufacturer was begun in October 1, 2003. This service is provided free of charge for home-used computers sold after October 1, 2003. For details, visit the Lenovo Web site at

https://www.lenovo.com/jp/ja/services_warranty/recycle/personal/.

Disposing of Lenovo computer components

Some Lenovo computer products sold in Japan may have components that contain heavy metals or other environmental sensitive substances. To properly dispose of disused components, such as a printed circuit board or drive, use the methods described above for collecting and recycling a disused computer or monitor

Energy Star Compliance

Signage Displays



As an ENERGY STAR Partner, Lenovo Group Limited has followed the EPA's enhanced product qualification and certification process to ensure that the products marked with the ENERGY STAR logo are ENERGY STAR qualified per the applicable ENERGY STAR guidelines for energy efficiency. The logo appears on the boot screen on all ENERGY STAR qualified Signage Displays.

As an ENERGY STAR Partner, Lenovo Group Limited has followed the EPA's enhanced product qualification and certification process to ensure that the products marked with the ENERGY STAR logo are ENERGY STAR qualified per the applicable ENERGY STAR guidelines for energy efficiency. The logo appears on the boot screen on all ENERGY STAR qualified Signage Displays.

For L21856UT0, sleep mode can be initiated in a couple of different ways. Users can take the action of pressing the power button on the panel for 5 seconds, or a remote command can be sent via RS232. The panel will also go into sleep mode without user action after 1 hours of inactivity L21856UT0 can exit sleep mode by the user pressing the power button, by through a remote command via RS232.

In the event that brightness settings or power mode settings are changed by the user, energy consumption of the panel may increase beyond the limits required for ENERGY STAR certification.

Additional information on the ENERGY STAR program and its environment benefits are available on the EPA ENERGY STAR website at <http://www.energystar.gov>

The Manufacturer-reported maximum luminance L_Max Reported is 400cd/m2.

Appendix E Notices and trademarks

Lenovo may not offer the products, services, or features discussed in this document in all countries. Consult your local Lenovo representative for information on the products and services currently available in your area. Any reference to a Lenovo product, program, or service is not intended to state or imply that only that Lenovo product, program, or service may be used. Any functionally equivalent product, program, or service that does not infringe any Lenovo intellectual property right may be used instead. However, it is the user's responsibility to evaluate and verify the operation of any other product, program, or service.

Lenovo may have patents or pending patent applications covering subject matter described in this document. The furnishing of this document does not give you any license to these patents. You can send license inquiries, in writing to:

*Lenovo (United States),inc.
1009 Think
Place –
Building
One
Morrisville,
NC 27560
U.S.A.
Attention: Lenovo Director of Licensing*

LENOVO PROVIDES THIS PUBLICATION "AS IS" WITHOUT WARRANTY OF ANY KIND, EITHER EXPRESS OR IMPLIED, INCLUDING, BUT NOT LIMITED TO THE IMPLIED WARRANTIES OF NON-INFRINGEMENT,

MERCHANTABILITY OR FITNESS FOR A PARTICULAR PURPOSE.

Some jurisdictions do not allow disclaimer of express or implied warranties in certain transactions, therefore, this statement may not apply to you.

This information could include technical inaccuracies or typographical errors. Changes are periodically made to the information herein; these changes will be incorporated in new editions of the publication. Lenovo may make improvements and/or changes in the product(s) and/or the program(s) described in this publication at any time without notice.

The products described in this document are not intended for use in implantation or other life support applications where malfunction may result in injury or death to persons. The information contained in this document does not affect or change Lenovo product specifications or warranties. Nothing in this document shall operate as an express or implied license or indemnity under the intellectual property rights of Lenovo or third parties. All information contained in this document was obtained from specific environments and presented as an illustration. The result obtained in other operating environments may vary.

Lenovo may use or distribute any of the information you supply in any way it believe appropriate without incurring any obligation to you.

Any references in this publication to non-Lenovo Web sites are provided for convenience only and do not in any manner serve as an endorsement of those Web sites. The materials at those Web sites are not part of the materials for this Lenovo product, and use of those Web sites is at your own risk.

Any performance data contained herein was determined in a controlled environment. Therefore, the result obtained in other operating environments may vary significantly. Some measurements may have been made on development-level systems and there is no guarantee that these measurements will be the same on generally available systems. Furthermore, some measurements may have been estimated through extrapolation. Actual results may vary.

Trademarks

Users of the following terms are trademarks of Lenovo in the United-States, other countries, or both:

Lenovo

ThinkVision

Other company, product, or service names may be trademarks or service marks of others.