



---

# Cisco UCS C240 M4 High-Density Rack Server (Small Form Factor Disk Drive Model)

---

# CONTENTS

OVERVIEW	5
DETAILED VIEWS	6
Chassis Front View	6
Chassis Rear View	9
BASE SERVER STANDARD CAPABILITIES and FEATURES	11
CONFIGURING the SERVER	15
STEP 1 VERIFY SERVER SKU	16
STEP 2 SELECT RISER CARDS (OPTIONAL)	17
STEP 3 SELECT CPU(s)	18
STEP 4 SELECT MEMORY	21
STEP 5 SELECT RAID CONTROLLERS	27
RAID Controller Options (internal HDD/SSD support)	27
Embedded Software RAID	27
Cisco 12G SAS Modular RAID Controller	27
SAS HBA (internal HDD/SSD/JBOD support)	27
SAS HBA (external JBOD support)	27
RAID Volumes and Groups	28
STEP 6 SELECT HARD DISK DRIVES (HDDs) or SOLID STATE DRIVES (SSDs)	38
STEP 7 SELECT PCIe OPTION CARD(s)	43
STEP 8 ORDER OPTIONAL NETWORK CARD ACCESSORIES	46
STEP 9 ORDER GPU CARDS AND GPU POWER CABLES (OPTIONAL)	52
STEP 10 ORDER POWER SUPPLY	55
STEP 11 SELECT AC POWER CORD(s)	56
STEP 12 ORDER TOOL-LESS RAIL KIT AND OPTIONAL REVERSIBLE CABLE MANAGEMENT ARM	59
STEP 13 SELECT NIC MODE (OPTIONAL)	60
STEP 14 ORDER A TRUSTED PLATFORM MODULE (OPTIONAL)	61
STEP 15 ORDER CISCO FLEXIBLE FLASH SD CARD MODULE (OPTIONAL)	63
STEP 16 ORDER OPTIONAL USB 3.0 DRIVE	64
STEP 17 SELECT OPERATING SYSTEM AND VALUE-ADDED SOFTWARE	65
STEP 18 SELECT OPERATING SYSTEM MEDIA KIT	68
STEP 19 SELECT SERVICE and SUPPORT LEVEL	69
OPTIONAL STEP - ORDER RACK(s)	74
OPTIONAL STEP - ORDER PDU	75
SUPPLEMENTAL MATERIAL	76
CHASSIS	76
Block Diagram	78
CPUs and DIMMs	79
Physical Layout	79
Memory Population Rules	80
DIMM Population Order	81
Recommended Memory Configuration	82
Additional DIMM Populations	84
RAID Details	85
Cisco 12G SAS Modular RAID Controller (RAID Support)	85
Cisco 12 Gbps SAS HBA (JBOD Only Support)	85
RAID Option ROM (OPROM) Settings	86
Riser Card Configuration and Options	87
Embedded SATA RAID: Two SATA Controllers	89
Serial Port Details	92

---

Upgrade and Servicing-Related Parts . . . . .	93
Adding an Additional CPU (with CPU heat sink) or Replacing CPUs . . . . .	94
Motherboard Lithium Battery . . . . .	94
Thermal Grease (with syringe applicator) for CPU to Heatsink Seal . . . . .	94
Air Baffle Replacement Kit . . . . .	95
CPU Heat Sink Cleaning Kit . . . . .	95
RACKS . . . . .	96
PDU's . . . . .	98
KVM CABLE . . . . .	99
Motherboard USB and SD Ports, and RAID Card Backup Locations . . . . .	100
<b>TECHNICAL SPECIFICATIONS . . . . .</b>	<b>101</b>
Dimensions and Weight . . . . .	101
Power Specifications . . . . .	102
Environmental Specifications . . . . .	106
Compliance Requirements . . . . .	107

---

# CONTENTS

## OVERVIEW

The UCS C240 M4 SFF server is the newest 2-socket, 2U rack server from Cisco, designed for both performance and expandability over a wide range of storage-intensive infrastructure workloads from big data to collaboration.

The enterprise-class UCS C240 M4 SFF server extends the capabilities of Cisco's Unified Computing System portfolio in a 2U form factor with the addition of the Intel® Xeon E5-2600 v3 and v4 series processor family that delivers the best combination of performance, flexibility, and efficiency gains. In addition, the UCS C240 M4 SFF server provides 24 DIMM slots, up to 6 PCI Express (PCIe) 3.0 slots, up to 24 front-loading drives plus two (optional) internal SATA boot drives for a total of 26 internal drives.

The C240 M4 server includes a modular LAN on motherboard (mLOM) slot for installation of a Cisco Virtual Interface Card (VIC) or third-party network interface card (NIC) without consuming a PCI slot in addition to 2 x 1 GbE embedded (on the motherboard) LOM ports. These features combine to provide outstanding levels of internal memory and storage expandability along with exceptional performance.

The Cisco UCS C240 M4 server can be used standalone, or as part of the Cisco Unified Computing System, which unifies computing, networking, management, virtualization, and storage access into a single integrated architecture enabling end-to-end server visibility, management, and control in both bare metal and virtualized environments.

Figure 1 Cisco UCS C240 M4 High-Density SFF Rack Server (24-drive version)

### Front View



### Rear View



# DETAILED VIEWS

## Chassis Front View

Figure 2 shows the 24-drive Cisco UCS C240 M4 High-Density SFF Rack Server.

Figure 2 Chassis Front View (24-drive version)

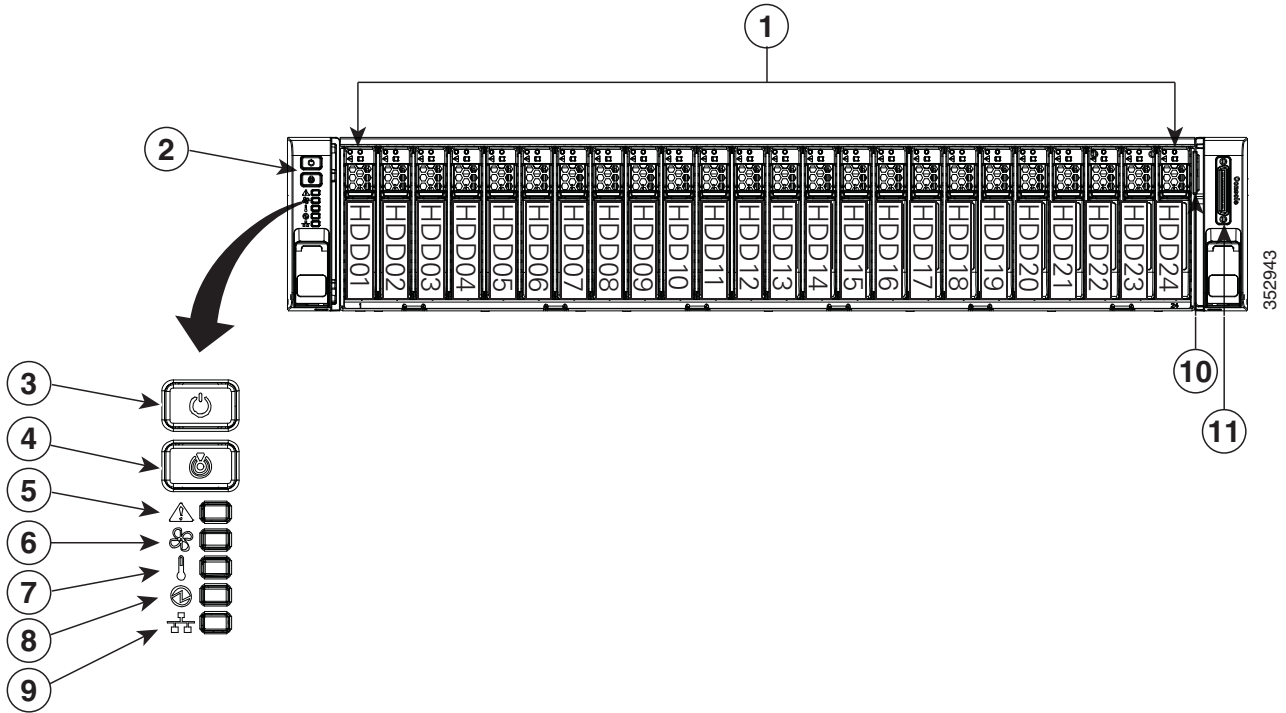

1	Drive bays 1-24 (up to 24 2.5-inch drives)	7	Temperature status LED
2	Operations panel buttons and LEDs	8	Power supply status LED
3	Power button/LED	9	Network link activity LED
4	Unit Identification button/LED	10	Pull-out asset tag
5	System status LED	11	KVM connector (used with KVM cable that provides two USB 2.0, one VGA, and one serial connector)
6	Fan status LED		

Figure 3 shows the 16-drive Cisco UCS C240 M4 High-Density SFF Rack Server.

Figure 3 Chassis Front View (16-drive version)

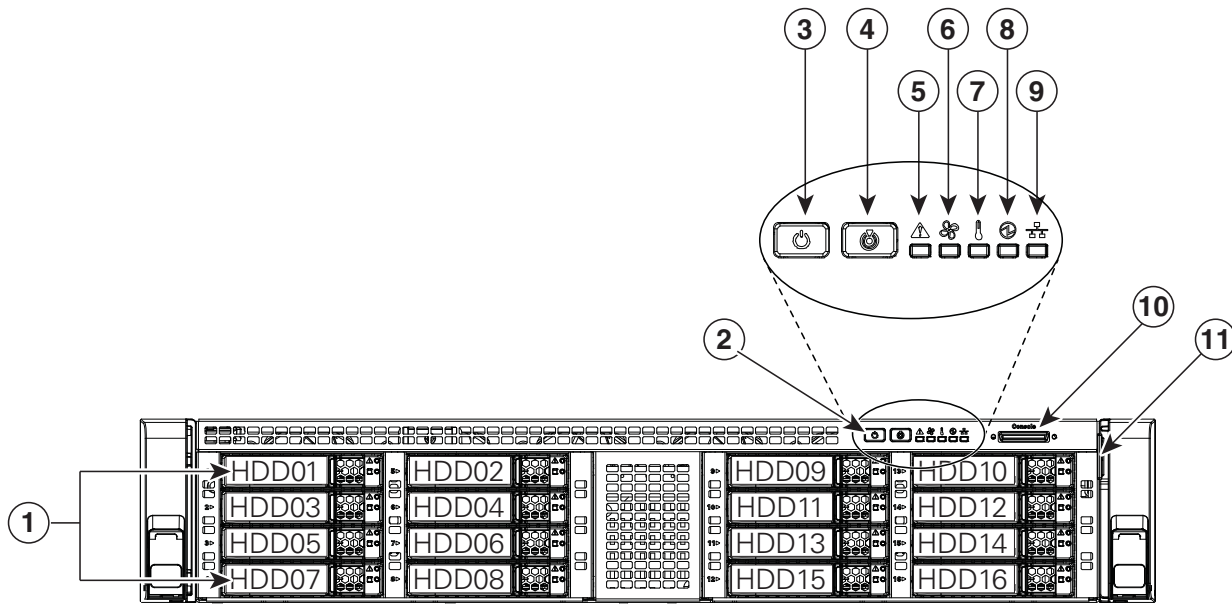

352944

1	Drive bays 1-16 (up to 16 2.5-inch drives)	7	Temperature status LED
2	Operations panel buttons and LEDs	8	Power supply status LED
3	Power button/LED	9	Network link activity LED
4	Unit Identification button/LED	10	KVM connector (used with KVM cable that provides two USB 2.0, one VGA, and one serial connector)
5	System status LED	11	Pull-out asset tag
6	Fan status LED		

Figure 3 shows the 8-drive Cisco UCS C240 M4 High-Density SFF Rack Server.

Figure 4 Chassis Front View (8-drive version)

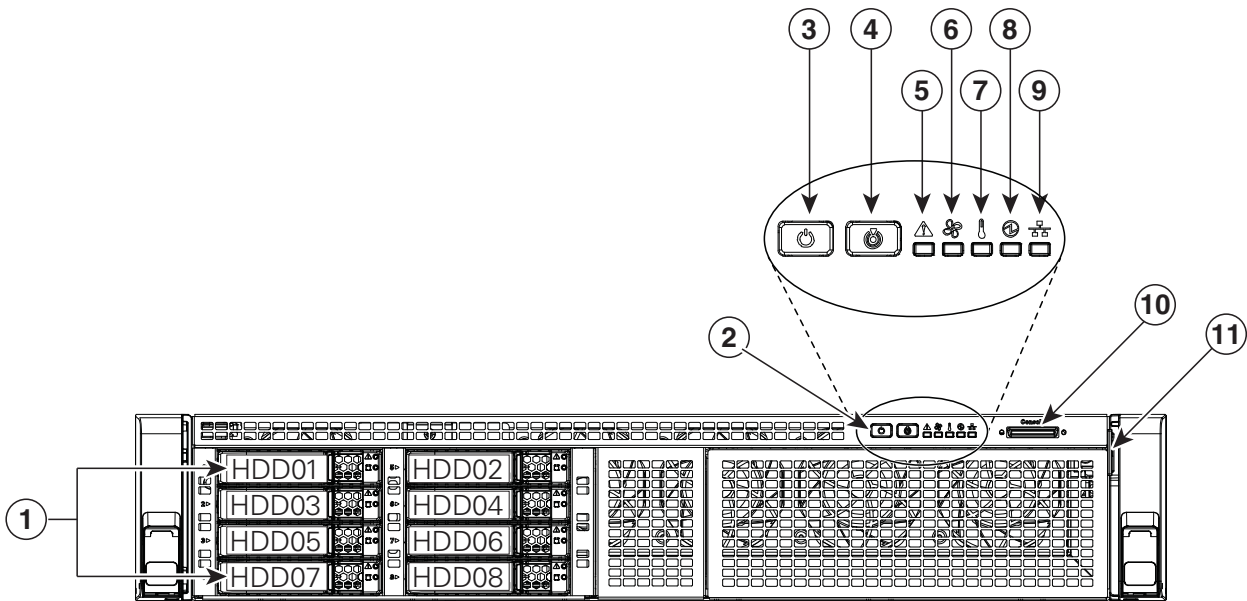

352945

1	Drive bays 1-8 (up to 8 2.5-inch drives)	7	Temperature status LED
2	Operations panel buttons and LEDs	8	Power supply status LED
3	Power button/LED	9	Network link activity LED
4	Unit Identification button/LED	10	KVM connector (used with KVM cable that provides two USB 2.0, one VGA, and one serial connector)
5	System status LED	11	Pull-out asset tag
6	Fan status LED		

For more information about the KVM cable connection, see [KVM CABLE, page 99](#).



## Chassis Rear View

Figure 5 shows the external features of the rear panel (identical for all server versions).

Figure 5 Chassis Rear View

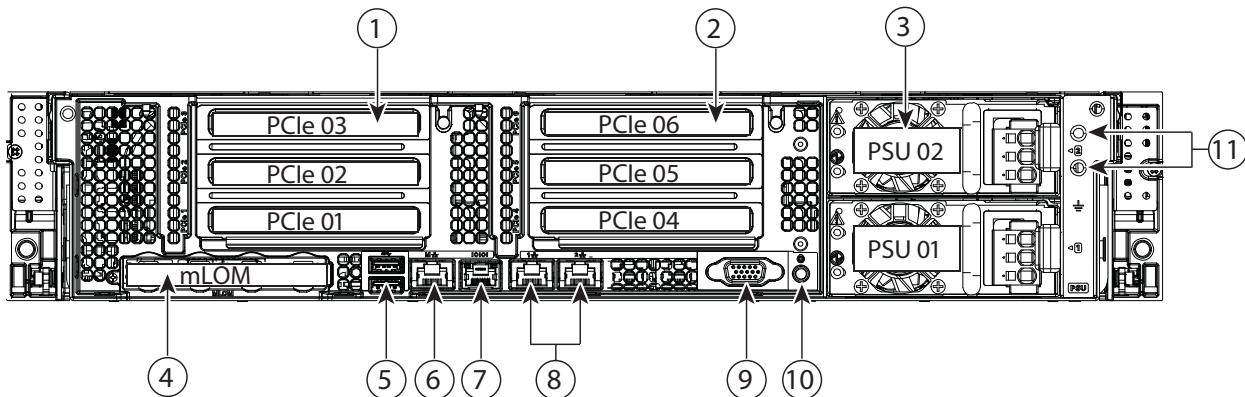

352947

1	PCIe riser 1 (slots 1, 2, 3*) *Slot 3 not present in all versions. See <a href="#">Riser Card Configuration and Options, page 87</a> for details.	7	Serial connector (RJ-45) <sup>1</sup>
2	PCIe riser 2 (slots 4, 5, 6), See <a href="#">Riser Card Configuration and Options, page 87</a> for details.	8	Two embedded (on the motherboard) Intel i350 GbE Ethernet controller ports LAN1 is left connector, LAN2 is right connector
3	Power supplies (DC power supplies shown)	9	VGA video port (DB-15 connector)
4	Modular LAN-on-motherboard (mLOM) card slot	10	Rear Unit Identification button/LED
5	USB 3.0 ports (two)	11	Grounding-lug holes (for DC power supplies)
6	1-Gbps dedicated management port		—

Notes . . .

1. For serial port pinout details, see [Serial Port Details, page 92](#)

The port numbers for an mLOM VIC (for example, the VIC 1227T) and for a PCIe VIC (for example, the VIC 1225T) are shown in [Figure 6](#). In the case of both cards, the Port 1 connector is on the right and the Port 2 connector is on the left.

Figure 6 VIC Port Numbering

VIC 1227T



VIC 1225T



## BASE SERVER STANDARD CAPABILITIES and FEATURES

*Table 1* lists the capabilities and features of the base server. Details about how to configure the server for a particular feature or capability (for example, number of processors, disk drives, or amount of memory) are provided in *CONFIGURING the SERVER, page 15*.

Table 1 Capabilities and Features

Capability/Feature	Description
Chassis	Two rack unit (2RU) chassis
CPU	One or two Intel Xeon E5-2600 v3 or v4 series processor family CPUs
Chipset	Intel® C610 series chipset
Memory	24 slots for registered ECC DIMMs (RDIMMs) or load-reduced DIMMs (LRDIMMs)
Multi-bit Error Protection	This server supports multi-bit error protection.
Expansion slots	<p>Up to six PCIe slots (on two riser cards)</p> <ul style="list-style-type: none"> <li>■ Riser 1 (PCIe slots 1, 2, and 3), controlled by CPU 1 <ul style="list-style-type: none"> <li>• Option A: Two slots available. Slot 1 = full height, 3/4 length, x8, NCSI<sup>1</sup>. Slot 2 = full height, full length, x16, NCSI, GPU capable. NCSI is supported on only one slot at a time.</li> <li>• Option B: Three slots available. Slot 1 = full height, 3/4 length, x8. Slot 2 = full height, full length, x8, NCSI. Slot 3 = full height, full length, x8.</li> <li>• Option C: Two slots available. Slot 1 = full height, 3/4 length, x8, NCSI. Slot 2 = full height, full length, x16, NCSI. In addition, the riser contains two connectors for connecting up to two SATA boot drives.</li> </ul> </li> <li>■ Riser 2 (PCIe slots 4, 5, and 6), controlled by CPU 2. Three slots available. Slot 4 = full height, 3/4 length, x8, NCSI. Slot 5 = full height, full length, x16, NCSI, GPU capable. Slot 6 = full height, full length, x8. NCSI is supported on only one slot at a time.</li> <li>■ Dedicated RAID controller slot (see <i>Figure 9 on page 76</i>) <ul style="list-style-type: none"> <li>• An internal slot is reserved for the Cisco 12G SAS Modular RAID controller.</li> </ul> </li> </ul> <p>For more details on riser 1 and riser 2 see <i>Riser Card Configuration and Options, page 87</i>.</p>
PCIe Interposer Board	An optional interposer board inside the chassis containing two mini-SAS HD connectors allows two front-mount NVMe PCIe SSDs to mount in drive bays 1 and 2 (only) and connect to the PCIe bus of CPU2.
Video	<p>The Cisco Integrated Management Controller (CIMC) provides video using the Matrox G200e video/graphics controller:</p> <ul style="list-style-type: none"> <li>■ Integrated 2D graphics core with hardware acceleration</li> <li>■ DDR2/3 memory interface supports up to 512 MB of addressable memory (8 MB is allocated by default to video memory)</li> <li>■ Supports display resolutions up to 1920 x 1200 16bpp @ 60Hz</li> <li>■ High-speed integrated 24-bit RAMDAC</li> <li>■ Single lane PCI-Express host interface running at Gen 1 speed</li> </ul>

Capability/Feature	Description
Internal storage devices	<p>Drives are installed into front-panel drive bays that provide hot-pluggable access.</p> <ul style="list-style-type: none"> <li>■ Small Form Factor (SFF) drives. The server can hold up to: <ul style="list-style-type: none"> <li>• 24 2.5 inch (63.5 mm) SAS/SATA hard drives (HDDs) or SAS/SATA solid state drives (SSDs) with the 24-drive backplane (with expander) server configuration, plus two optional internal 2.5 inch SATA SSDs for booting an OS.</li> <li>• 16 2.5 inch (63.5 mm) SAS/SATA HDDs or SAS/SATA SSDs with the 16-drive backplane (with expander) server configuration</li> <li>• 8 2.5 inch (63.5 mm) SAS/SATA HDDs or SAS/SATA SSDs with the 8-drive backplane server (no expander) configuration.</li> <li>• NVMe PCIe SSD drives. These drives can be placed in front drive bays 1 and 2 only.</li> </ul> </li> <li>■ The server also contains one internal USB 3.0 port on the motherboard that you can use with an optional 16 GB USB thumb drive for additional storage</li> <li>■ UCS Storage Accelerators are also available. These PCIe plug-in flash storage cards provide independent high-speed storage.</li> </ul>
Cisco Flexible Flash drives	<p>The server supports up to two internal 32 GB or two internal 64 GB Cisco Flexible Flash drives (SD cards).</p> <p>The second SD card is blank and can be used to mirror the first SD card. It can be used to protect the Hypervisor Partition with RAID1.</p>
Interfaces	<ul style="list-style-type: none"> <li>■ Rear panel <ul style="list-style-type: none"> <li>• One DB15 VGA connector</li> <li>• One RJ45 serial port connector</li> <li>• Two USB 3.0 port connectors</li> <li>• One RJ-45 10/100/1000 Ethernet management port, using Cisco Integrated Management Controller (CIMC) firmware</li> <li>• Two Intel i350 embedded (on the motherboard) GbE LOM ports</li> <li>• One flexible modular LAN on motherboard (mLOM) slot that can accommodate various interface cards</li> </ul> </li> <li>■ Various PCIe card ports (dependent on which cards are installed) <ul style="list-style-type: none"> <li>• Virtual Interface Card (VIC) ports</li> <li>• Converged Network Adapter (CNA) ports</li> <li>• Network Interface Card (NIC) ports</li> <li>• Host Bus Adapter (HBA) ports</li> </ul> </li> <li>■ Front panel <ul style="list-style-type: none"> <li>• One KVM console connector (supplies two USB 2.0 connectors, one VGA DB15 video connector, and one serial port (RS232) RJ45 connector)</li> </ul> </li> </ul>
Power subsystem	<p>Up to two of the following hot-swappable power supplies:</p> <ul style="list-style-type: none"> <li>■ 650 W (AC)</li> <li>■ 1200 W (AC)</li> <li>■ 1400 W (AC)</li> </ul> <p>One power supply is mandatory; one more can be added for 1 + 1 redundancy.</p>

Capability/Feature	Description															
Storage controller	<ul style="list-style-type: none"> <li>■ Embedded Software RAID (6 Gbps)                             <ul style="list-style-type: none"> <li>• Embedded SATA-only RAID controller, supporting up to 8 SATA-only drives (RAID 0, 1), or</li> <li>• Embedded Software RAID 5 key upgrade, supporting up to 8 SATA-only drives (RAID 0, 1, 10, 5)</li> </ul> </li> </ul> <p>Note that embedded RAID options can be supported only with the version of the C240 M4 SFF server that has been configured with an 8-drive backplane.</p> <ul style="list-style-type: none"> <li>■ Cisco 12G SAS Modular RAID controller card with internal SAS connectivity.                             <ul style="list-style-type: none"> <li>• Supports up to 24 internal drives</li> <li>• Plugs into a dedicated RAID controller slot</li> </ul> </li> <li>■ Can be purchased alone, or along with an onboard Flash-Backed Write Cache (FBWC) upgrade option, as shown in the table below</li> </ul> <table border="1" style="margin-top: 10px;"> <thead> <tr> <th>RAID Card Version</th> <th>Supported RAID Levels</th> <th>Onboard FBWC</th> </tr> </thead> <tbody> <tr> <td>UCSC-MRAID12G<sup>1</sup></td> <td>JBOD, 0, 1, 10</td> <td>None</td> </tr> <tr> <td>UCSC-MRAID12G-1GB<sup>2</sup></td> <td>JBOD, 0, 1, 10, 5, 6, 50, 60</td> <td>1 GB</td> </tr> <tr> <td>UCSC-MRAID12G-2GB<sup>2</sup></td> <td>JBOD, 0, 1, 10, 5, 6, 50, 60</td> <td>2 GB</td> </tr> <tr> <td>UCSC-MRAID12G-4GB<sup>2</sup></td> <td>JBOD, 0, 1, 10, 5, 6, 50, 60</td> <td>4 GB</td> </tr> </tbody> </table>	RAID Card Version	Supported RAID Levels	Onboard FBWC	UCSC-MRAID12G <sup>1</sup>	JBOD, 0, 1, 10	None	UCSC-MRAID12G-1GB <sup>2</sup>	JBOD, 0, 1, 10, 5, 6, 50, 60	1 GB	UCSC-MRAID12G-2GB <sup>2</sup>	JBOD, 0, 1, 10, 5, 6, 50, 60	2 GB	UCSC-MRAID12G-4GB <sup>2</sup>	JBOD, 0, 1, 10, 5, 6, 50, 60	4 GB
RAID Card Version	Supported RAID Levels	Onboard FBWC														
UCSC-MRAID12G <sup>1</sup>	JBOD, 0, 1, 10	None														
UCSC-MRAID12G-1GB <sup>2</sup>	JBOD, 0, 1, 10, 5, 6, 50, 60	1 GB														
UCSC-MRAID12G-2GB <sup>2</sup>	JBOD, 0, 1, 10, 5, 6, 50, 60	2 GB														
UCSC-MRAID12G-4GB <sup>2</sup>	JBOD, 0, 1, 10, 5, 6, 50, 60	4 GB														
	<p>Notes . . .</p> <ol style="list-style-type: none"> <li>1. Base RAID controller card (RAID 0, 1, 10 only)</li> <li>2. FBWC option for base RAID controller card (adding the FBWC option extends the RAID levels)</li> </ol> <p>All versions of the UCSC-MRAID12G RAID controller support up to 24 internal SAS drives on the 24-drive backplane version of the server, up to 16 drives on the 16-drive backplane version, or up to 8 drives on the 8-drive backplane version.</p>															
WoL	The 1-Gb Base-T Ethernet LAN ports support the wake-on-LAN (WoL) standard.															
Front Panel	A front panel controller provides status indications and control buttons															
ACPI	This server supports the advanced configuration and power interface (ACPI) 4.0 standard.															
Fans	Chassis: <ul style="list-style-type: none"> <li>■ Six hot-swappable fans for front-to-rear cooling</li> </ul>															
Boot drives	Up to two optional SATA drives can be installed internal to the chassis on riser 1. The two SATA boot drives are supported only on the 24-drive backplane chassis version and are managed in AHCI mode, using OS-based software RAID.															

Capability/Feature	Description				
Storage controller	<ul style="list-style-type: none"> <li>■ Cisco 12 Gbps Modular SAS HBA with internal SAS connectivity                             <ul style="list-style-type: none"> <li>• Supports up to 24 internal drives</li> <li>• Is compatible with all backplane versions (8-, 16-, and 24-drive backplanes)</li> <li>• Plugs into a dedicated PCIe slot at the rear of the server (slot 1 of riser 1)</li> <li>• Supports JBOD only, not RAID, as shown in the below table.</li> </ul> </li> </ul> <table border="1" style="margin-left: 40px;"> <thead> <tr> <th>HBA Card Version</th> <th>Supported RAID Levels</th> </tr> </thead> <tbody> <tr> <td>UCSC-SAS12GHBA</td> <td>JBOD only</td> </tr> </tbody> </table>	HBA Card Version	Supported RAID Levels	UCSC-SAS12GHBA	JBOD only
HBA Card Version	Supported RAID Levels				
UCSC-SAS12GHBA	JBOD only				
Embedded NIC	<ul style="list-style-type: none"> <li>■ Cisco 9300-8E 12G SAS HBA with external SAS connectivity                             <ul style="list-style-type: none"> <li>• Provides 8 external SAS ports</li> <li>• Plugs into a PCIe slot at the rear of the server</li> <li>• No FBWC (cache) or cache power backup</li> <li>• SAS 3.0 compliant</li> </ul> </li> </ul> <p>Two embedded (on the motherboard) Intel i350 GbE ports, supporting the following:</p> <ul style="list-style-type: none"> <li>■ Pre-Execution Boot (PXE boot)</li> <li>■ iSCSI boot</li> <li>■ Checksum and segmentation offload</li> <li>■ NIC teaming</li> </ul>				
Modular LAN on Motherboard (mLOM) slot	<p>The mLOM slot can flexibly accommodate the following cards:</p> <ul style="list-style-type: none"> <li>■ Cisco Virtual Interface Cards (VIC)</li> <li>■ Quad Port Intel i350 1GbE RJ45 Network Interface Card (NIC)</li> </ul>				
<div style="display: flex; align-items: center; justify-content: center;">  <p><b>NOTE:</b> The four Intel i350 ports are provided on an optional card that plugs into the mLOM slot, and are separate from the two embedded (on the motherboard) LAN ports</p> </div>					
Integrated management processor	<p>Baseboard Management Controller (BMC) running Cisco Integrated Management Controller (CIMC) firmware.</p> <p>Depending on your CIMC settings, the CIMC can be accessed through the 1-GbE dedicated management port, the 1-GbE LOM ports, or a Cisco virtual interface card (VIC).</p>				

Notes . . .

1. NCSI = Network Communications Services Interface protocol. An NCSI slot is powered even when the server is in standby power mode.

## CONFIGURING the SERVER

Follow these steps to configure the Cisco UCS C240 M4 High-Density SFF Rack Server:

- *STEP 1 VERIFY SERVER SKU, page 16*
- *STEP 2 SELECT RISER CARDS (OPTIONAL), page 17*
- *STEP 3 SELECT CPU(s), page 18*
- *STEP 4 SELECT MEMORY, page 21*
- *STEP 5 SELECT RAID CONTROLLERS, page 27*
- *STEP 6 SELECT HARD DISK DRIVES (HDDs) or SOLID STATE DRIVES (SSDs), page 38*
- *STEP 7 SELECT PCIe OPTION CARD(s), page 43*
- *STEP 8 ORDER OPTIONAL NETWORK CARD ACCESSORIES, page 46*
- *STEP 9 ORDER GPU CARDS AND GPU POWER CABLES (OPTIONAL), page 52*
- *STEP 10 ORDER POWER SUPPLY, page 55*
- *STEP 11 SELECT AC POWER CORD(s), page 56*
- *STEP 12 ORDER TOOL-LESS RAIL KIT AND OPTIONAL REVERSIBLE CABLE MANAGEMENT ARM, page 59*
- *STEP 13 SELECT NIC MODE (OPTIONAL), page 60*
- *STEP 14 ORDER A TRUSTED PLATFORM MODULE (OPTIONAL), page 61*
- *STEP 15 ORDER CISCO FLEXIBLE FLASH SD CARD MODULE (OPTIONAL), page 63*
- *STEP 16 ORDER OPTIONAL USB 3.0 DRIVE, page 64*
- *STEP 17 SELECT OPERATING SYSTEM AND VALUE-ADDED SOFTWARE, page 65*
- *STEP 18 SELECT OPERATING SYSTEM MEDIA KIT, page 68*
- *STEP 19 SELECT SERVICE and SUPPORT LEVEL, page 69*
- *OPTIONAL STEP - ORDER RACK(s), page 74*
- *OPTIONAL STEP - ORDER PDU, page 75*

## STEP 1 VERIFY SERVER SKU

Select one server product ID (PID) from [Table 2](#).

Table 2 PID of the C240 M4 High-Density SFF Rack Base Server

Product ID (PID)	Description
UCSC-C240-M4SX	UCS C240 M4 SFF, no CPU, memory, HDD, SSD, PCIe cards, tool-less rail kit, or power supply, with 24-drive backplane with SAS expander
UCSC-C240-M4S2	UCS C240 M4 SFF, no CPU, memory, HDD, SSD, PCIe cards, tool-less rail kit, or power supply, with 16-drive backplane with SAS expander
UCSC-C240-M4S	UCS C240 M4 SFF, no CPU, memory, HDD, SSD, PCIe cards, tool-less rail kit, or power supply, with 8-drive backplane with no SAS expander

The Cisco UCS C240 M4 server:

- Includes either a 24-, 16-, or 8-drive backplane.



NOTE: Embedded Software RAID can only be used with the 8-drive backplane version of the server.

The Cisco 12G SAS Modular RAID controller and Cisco 12 Gbps Modular SAS HBA can be used with any backplane version.



NOTE: The C240 M4 SFF server hard drive backplane is not field upgradeable. This means, for example, that you cannot "upgrade" from the 8-drive backplane version to the 16-drive or 24-drive backplane version or from the 16-drive backplane version to the 24-drive backplane version. Likewise, the backplane is not field "downgradeable."

- Does not include power supply, CPU, memory, hard disk drives (HDDs), solid-state drives (SSDs), boot drives, SD cards, riser 1, riser 2, tool-less rail kit, or PCIe cards.



NOTE: Use the steps on the following pages to configure the server with the components that you want to include.



## STEP 2 SELECT RISER CARDS (OPTIONAL)

There are two optional riser cards, riser card 1 and 2. There are three options for riser card 1. Order one riser card 1 from [Table 3](#) and one riser 2 card from [Table 4](#). Riser card 1 is the one on the left when viewed from the back of the server and riser card 2 is on the right.

Table 3 Riser 1 Options

Product ID (PID)	Description
UCSC-PCI-1A-240M4	C240 M4 PCIe Riser 1 Assy (option A) (2 PCIe slots: 1x8 and 1x16 GPU capable)
UCSC-PCI-1B-240M4	C240 M4 PCIe Riser 1 Assy (option B) (3 PCIe slots: 3x8)
UCSC-PCI-1C-240M4	C240 M4 PCIe Riser 1 Assy (option C) (2 PCIe slots: 1x8 and 1x16 plus connectors for 2 SATA boot drives)

The selection of riser card 1 determines the number and type of PCIe cards and SATA boot drives supported in the riser.

Table 4 Riser 2 Options

Product ID (PID)	Description
UCSC-PCI-2-C240M4	PCIe Riser Board (Riser 2) for C240 M4 (3 slots: 2x8 and 1x16)



**NOTE:** If no riser is selected, a riser blanking panel will be installed. You will not be able to install any PCIe cards without a riser selected

For additional details, see [Riser Card Configuration and Options, page 87](#).

### STEP 3 SELECT CPU(s)

The standard CPU features are:

- Intel Xeon E5-2600 v3 and v4 series processor family CPUs
- Intel C610 series chipset
- Cache size of up to 55 MB

#### Select CPUs

The available CPUs are listed in [Table 5](#).

Table 5 Available Intel CPUs

Product ID (PID)	Intel Number	Clock Freq (GHz)	Power (W)	Cache Size (MB)	Cores	QPI	Highest DDR4 DIMM Clock Support (MHz) <sup>1</sup>
<b>E5-2600 v4 Series Processor Family CPUs</b>							
UCS-CPU-E52699E	E5-2699 v4	2.20	145	55	22	9.6 GT/s	2400
UCS-CPU-E52698E	E5-2698 v4	2.20	135	50	20	9.6 GT/s	2400
UCS-CPU-E52697AE	E5-2697A v4	2.60	145	40	16	9.6 GT/s	2400
UCS-CPU-E52697E	E5-2697 v4	2.30	145	45	18	9.6 GT/s	2400
UCS-CPU-E52695E	E5-2695 v4	2.10	120	45	18	9.6 GT/s	2400
UCS-CPU-E52690E	E5-2690 v4	2.60	135	35	14	9.6 GT/s	2400
UCS-CPU-E52683E	E5-2683 v4	2.10	120	40	16	9.6 GT/s	2400
UCS-CPU-E52680E	E5-2680 v4	2.40	120	35	14	9.6 GT/s	2400
UCS-CPU-E52667E	E5-2667 v4	3.20	135	25	8	9.6 GT/s	2400
UCS-CPU-E52660E	E5-2660 v4	2.00	105	35	14	9.6 GT/s	2400
UCS-CPU-E52650E	E5-2650 v4	2.20	105	30	12	9.6 GT/s	2400
UCS-CPU-E52650LE	E5-2650L v4	1.70	65	35	14	9.6 GT/s	2400
UCS-CPU-E52643E	E5-2643 v4	3.40	135	20	6	9.6 GT/s	2400
UCS-CPU-E52640E	E5-2640 v4	2.40	90	25	10	8.0 GT/s	2133
UCS-CPU-E52637E	E5-2637 v4	3.50	135	15	4	9.6 GT/s	2400
UCS-CPU-E52630E	E5-2630 v4	2.20	85	25	10	8.0 GT/s	2133
UCS-CPU-E52630LE	E5-2630L v4	1.80	55	25	8	8.0 GT/s	2133
UCS-CPU-E52623E	E5-2623 v4	2.60	85	10	4	8.0 GT/s	2133
UCS-CPU-E52620E	E5-2620 v4	2.10	85	20	8	8.0 GT/s	2133
UCS-CPU-E52609E	E5-2609 v4	1.70	85	20	8	6.4 GT/s	1866
UCS-CPU-E52658E	E5-2658 v4	2.30	105	35	14	9.6 GT/s	2400

Table 5 Available Intel CPUs

Product ID (PID)	Intel Number	Clock Freq (GHz)	Power (W)	Cache Size (MB)	Cores	QPI	Highest DDR4 DIMM Clock Support (MHz) <sup>1</sup>
E5-2600 v3 Series Processor Family CPUs							
UCS-CPU-E52699D	E5-2699 v3	2.30	145	45	18	9.6 GT/s	2133
UCS-CPU-E52698D	E5-2698 v3	2.30	135	40	16	9.6 GT/s	2133
UCS-CPU-E52697D	E5-2697 v3	2.60	145	35	14	9.6 GT/s	2133
UCS-CPU-E52695D	E5-2695 v3	2.30	120	35	14	9.6 GT/s	2133
UCS-CPU-E52690D	E5-2690 v3	2.60	135	30	12	9.6 GT/s	2133
UCS-CPU-E52683D	E5-2683 v3	2.00	120	35	14	9.6 GT/s	2133
UCS-CPU-E52680D	E5-2680 v3	2.50	120	30	12	9.6 GT/s	2133
UCS-CPU-E52670D	E5-2670 v3	2.30	120	30	12	9.6 GT/s	2133
UCS-CPU-E52667D	E5-2667 v3	3.20	135	20	8	9.6 GT/s	2133
UCS-CPU-E52660D	E5-2660 v3	2.60	105	25	10	9.6 GT/s	2133
UCS-CPU-E52658D	E5-2658 v3	2.20	105	30	12	9.6 GT/s	2133
UCS-CPU-E52650D	E5-2650 v3	2.30	105	25	10	9.6 GT/s	2133
UCS-CPU-E52650LD	E5-2650L v3	1.80	65	30	12	9.6 GT/s	1866
UCS-CPU-E52643D	E5-2643 v3	3.40	135	20	6	9.6 GT/s	2133
UCS-CPU-E52640D	E5-2640 v3	2.60	90	20	8	8.0 GT/s	1866
UCS-CPU-E52637D	E5-2637 v3	3.50	135	15	4	9.6 GT/s	2133
UCS-CPU-E52630D	E5-2630 v3	2.40	85	20	8	8.0 GT/s	1866
UCS-CPU-E52630LD	E5-2630L v3	1.80	55	20	8	8.0 GT/s	1866
UCS-CPU-E52623D	E5-2623 v3	3.00	105	10	4	8.0 GT/s	1866
UCS-CPU-E52620D	E5-2620 v3	2.40	85	15	6	8.0 GT/s	1866
UCS-CPU-E52609D <sup>2</sup>	E5-2609 v3	1.90	85	15	6	6.4 GT/s	1600

## Notes . . .

1. If higher or lower speed DIMMs are selected than what is shown in the table for a given CPU, the DIMMs will be clocked at the lowest common denominator of CPU clock and DIMM clock.
2. The E5-2609 v3 CPU does not support Intel Hyper-Threading or Intel Turbo Boost technologies.

## Approved Configurations

---

(1) 1-CPU configurations:

- Select any one CPU listed in [Table 5 on page 18](#).

(2) 2-CPU Configurations:

- Select two identical CPUs from any one of the rows of [Table 5 on page 18](#).

## Caveats

---

- You can select either one processor or two identical processors.
- The selection of 1 or 2 CPUs depends on the desired server functionality. See the following sections:
  - [STEP 4 SELECT MEMORY, page 21](#) (memory mirroring section)
  - [Table 11 on page 33](#) (RAID support table)
  - [STEP 6 SELECT HARD DISK DRIVES \(HDDs\) or SOLID STATE DRIVES \(SSDs\), page 38](#)
  - [STEP 7 SELECT PCIe OPTION CARD\(s\), page 43](#)
  - [ORDER GPU CARDS AND GPU POWER CABLES \(OPTIONAL\), page 52](#)

## STEP 4 SELECT MEMORY

The standard memory features are:

- DIMMs
  - Clock speed: 2400 or 2133 MHz
  - Ranks per DIMM: 1, 2, or 4
  - Operational voltage: 1.2 V
  - Registered ECC DDR4 DIMMs (RDIMMs) or load-reduced DIMMs (LRDIMMs)
- Memory is organized with four memory channels per CPU, with up to three DIMMs per channel, as shown in [Figure 7](#).

Figure 7 C240 M4 SFF Memory Organization

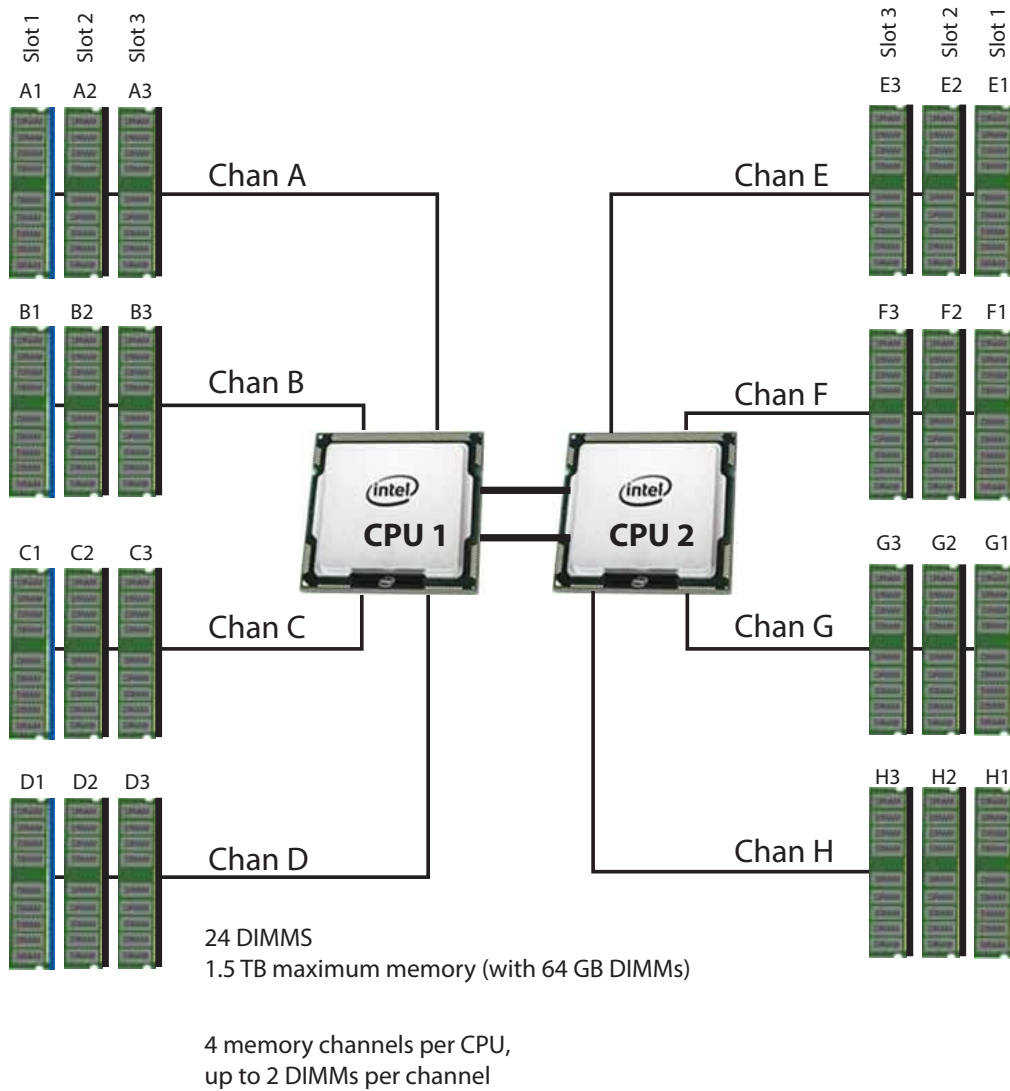

Select DIMMs and Memory Mirroring

Select the memory configuration and whether or not you want the memory mirroring option. The available memory DIMMs and mirroring option are listed in [Table 6](#).



**NOTE:** When memory mirroring is enabled, the memory subsystem simultaneously writes identical data to two channels. If a memory read from one of the channels returns incorrect data due to an uncorrectable memory error, the system automatically retrieves the data from the other channel. A transient or soft error in one channel does not affect the mirrored data, and operation continues unless there is a simultaneous error in exactly the same location on a DIMM and its mirrored DIMM. Memory mirroring reduces the amount of memory available to the operating system by 50% because only one of the two populated channels provides data.

Table 6 Available DDR4 DIMMs

Product ID (PID)	PID Description	Voltage	Ranks /DIMM
<b>2400-MHz DIMM Options</b>			
UCS-MR-1X322RV-A	32GB DDR4-2400-MHz RDIMM/PC4-19200/dual rank/x4	1.2 V	2
UCS-MR-1X161RV-A	16GB DDR4-2400-MHz RDIMM/PC4-19200/single rank/x4	1.2 V	1
UCS-MR-1X081RV-A	8 GB DDR4-2400-MHz RDIMM/PC4-19200/single rank/x4	1.2 V	1
<b>2133-MHz DIMM Options</b>			
UCS-MR-1X648RU-A <sup>1, 2</sup>	64GB DDR4-2133-MHz TSV-RDIMM/PC4-17000/octal rank/x4	1.2 V	8
UCS-MR-1X322RU-A	32GB DDR4-2133-MHz RDIMM/PC4-17000/dual rank/x4	1.2 V	2
UCS-ML-1X324RU-A	32GB DDR4-2133-MHz LRDIMM/PC4-17000/quad rank/x4	1.2 V	4
UCS-MR-1X162RU-A	16GB DDR4-2133-MHz RDIMM/PC4-17000/dual rank/x4	1.2 V	2
UCS-MR-1X081RU-A	8GB DDR4-2133-MHz RDIMM/PC4-17000/single rank/x4	1.2 V	1
<b>Memory Mirroring Option</b>			
N01-MMIRROR	Memory mirroring option		

Notes . . .

1. Power capping is not supported when using 64GB TSV-RDIMMS.
2. NVIDIA GPUs can support only less than 1 TB of total memory in the server. Do not install more than fourteen 64-GB DIMMs when using an NVIDIA GPU card in this server.

Approved Configurations

(1) 1-CPU configuration without memory mirroring:

- Select from 1 to 12 DIMMs. Refer to *Memory Population Rules, page 80*, for more detailed information.

(2) 1-CPU configuration with memory mirroring:

- Select 2, 4, 6, 8, or 12 identical DIMMs. The DIMMs will be placed by the factory as shown in the following table.

Total Number of DIMMs	CPU 1 DIMM Placement in Channels (for identical dual-rank DIMMs for 3DPC or identical quad-rank DIMMs for 2DPC)		
	Blue Slots	Black Slots	White Slots
2	(A1, B1)	—	—
4	(A1,B1); (C1,D1)	—	—
8	(A1,B1); (C1,D1)	(A2,B2); (C2,D2)	—
12	(A1,B1); (C1,D1)	(A2,B2); (C2,D2)	(A3,B3); (C3,D3)

- Select the memory mirroring option (N01-MMIRROR) as shown in *Table 6 on page 22*.

(3) 2-CPU configuration without memory mirroring:

- Select from 1 to 12 DIMMs per CPU. Refer to *Memory Population Rules, page 80*, for more detailed information.

(4) 2-CPU configuration with memory mirroring:

- Select 2, 4, 6, 8, or 12 identical DIMMs per CPU. The DIMMs will be placed by the factory as shown in the following table.

Number of DIMMs per CPU	CPU 1 DIMM Placement in Channels (for identical dual-rank DIMMs for 3DPC or identical quad-rank DIMMs for 2DPC)			CPU 2 DIMM Placement in Channels (for identical dual-rank DIMMs for 3DPC or identical quad-rank DIMMs for 2DPC)		
	Blue Slots	Black Slots	White Slots	Blue Slots	Black Slots	White Slots
2	(A1, B1)	—	—	(E1, F1)	—	—
4	(A1,B1); (C1,D1)	—	—	(E1,F1); (G1,H1)	—	—
8	(A1,B1); (C1,D1)	(A2,B2); (C2,D2)	—	(E1,F1); (G1,H1)	(E2,F2); (G2,H2)	—
12	(A1,B1); (C1,D1)	(A2,B2); (C2,D2)	(A3, B3); (C3, D3)	(E1,F1); (G1,H1)	(E2,F2); (G2,H2)	(E3,F3); (G3,H3)

- Select the memory mirroring option (N01-MMIRROR) as shown in [Table 6 on page 22](#).



NOTE: System performance is optimized when the DIMM type and quantity are equal for both CPUs, and when all channels are filled equally across the CPUs in the server.

Caveats

- System speed is dependent on how many DIMMs are populated per channel and the CPU DIMM speed support. See [Table 7](#) for details.

Table 7 2133-MHz DIMM Memory Speeds with Different CPUs

DIMM Speed	DPC	1600-MHz Capable CPU		1866-MHz Capable CPU		2133-MHz Capable CPU	
		LRDIMM (QR)	RDIMM (8R, DR, SR)	LRDIMM (QR)	RDIMM (8R, DR, SR)	LRDIMM (QR)	RDIMM (8R, DR, SR)
2133 DIMM	1DPC	1600	1600	1866	1866	2133	2133
	2DPC	1600	1600	1866	1866	2133	2133
	3DPC	1600	1600	1600	1600	1866	1866 (32 GB RDIMMs and 16 GB DIMMs)  1600 (64 GB TSV RDIMMs, 8 GB RDIMMs)



Table 8 2400-MHz DIMM Memory Speeds with Different v4 CPUs

DIMM and CPU Frequencies	DPC	LRDIMM (QRx4) - 64 GB <sup>1</sup>	RDIMM (2Rx4) - 32 GB	LRDIMM (QRx4) - 32 GB <sup>1</sup>	RDIMM (SRx4) - 16 GB	RDIMM (SRx4) - 8 GB
		1.2 V	1.2 V	1.2 V	1.2 V	1.2 V
DIMM = 2400 MHz CPU = 2400 MHz	1DPC	2400 MHz	2400 MHz	2400 MHz	2400 MHz	2400 MHz
	2DPC	2400 MHz	2400 MHz	2400 MHz	2400 MHz	2400 MHz
	3DPC	2133 MHz	1866 MHz	2133 MHz	2133 MHz	2133 MHz
DIMM = 2400 MHz CPU = 2133 MHz	1DPC	2133 MHz	2133 MHz	2133 MHz	2133 MHz	2133 MHz
	2DPC	2133 MHz	2133 MHz	2133 MHz	2133 MHz	2133 MHz
	3DPC	1866 MHz	1866 MHz	1866 MHz	1866 MHz	1600 MHz
DIMM = 2400 MHz CPU = 1866 MHz	1DPC	1866 MHz	1866 MHz	1866 MHz	1866 MHz	1866 MHz
	2DPC	1866 MHz	1866 MHz	1866 MHz	1866 MHz	1866 MHz
	3DPC	1866 MHz	1600 MHz	1866 MHz	1600 MHz	1600 MHz

Notes . . .

1. Available at a future date

- The C240 M4 server supports four different memory reliability, availability, and serviceability (RAS) modes:
  - Independent Channel Mode
  - Mirrored Channel Mode
  - Lockstep Channel Mode
- Below are the system level RAS Mode combination limitations:
  - Mixing of Independent and Lockstep channel mode is not allowed per platform.
  - Mixing of Non-Mirrored and Mirrored mode is not allowed per platform.
  - Mixing of Lockstep and Mirrored mode is not allowed per platform.
- Do not mix RDIMMs with LRDIMMs
- Do not mix 64GB DDR4-2133-MHz TSV-RDIMMs with any other DIMMs
- Single-rank DIMMs can be mixed with dual-rank DIMMs in the same channel
- Do not mix quad-rank DIMMs with single- or dual-rank DIMMs in the same channel
- For best performance, observe the following:
  - DIMMs with different timing parameters can be installed on different slots within the same channel, but only timings that support the slowest DIMM will be applied to all.

As a consequence, faster DIMMs will be operated at timings supported by the slowest DIMM populated.

- When one DIMM is used, it must be populated in DIMM slot 1 (farthest away from the CPU) of a given channel.
- When single, dual or quad rank DIMMs are populated for 2DPC or 3DPC, always populate the higher number rank DIMM first (starting from the farthest slot). For a 3DPC example, first populate with quad-rank DIMMs in the DIMM slot 1. Then dual-rank DIMMs in the DIMM 2 slot. Then single-rank DIMMs in the DIMM 3slot.
- DIMMs for CPU 1 and CPU 2 (when populated) must always be configured identically.
- When using mirroring, DIMMs must be installed in identical pairs across paired DDR4 buses. That is, mirrored pairs in channels A and B must be identical and pairs in channels C and D must be identical. However, the DIMMs used in channels A and B can be different from those in channels C and D.
- Memory mirroring reduces the amount of available memory by 50% (quantity of DIMMs must be even for mirroring).
- Non-ECC DIMMs are not supported.
- Cisco memory from previous generation servers (DDR3) is not compatible with this server

For more information regarding memory, see [CPUs and DIMMs, page 79](#).

## STEP 5 SELECT RAID CONTROLLERS

### RAID Controller Options (internal HDD/SSD support)

#### Embedded Software RAID

You can choose either the default embedded software RAID or the embedded software RAID 5 key upgrade.

- The default RAID configuration is embedded software RAID, which supports SATA HDDs (RAID 0, 1, 10).
- The embedded software RAID 5 key upgrade supports RAID 0, 1, 5, 10.



**NOTE:** The embedded software RAID in the Intel chipset hub is split into two, SATA and sSATA (secondary SATA). They are seen as separate software RAID controllers and are configurable separately. For more details, see *Embedded SATA RAID: Two SATA Controllers*, page 89.

#### Cisco 12G SAS Modular RAID Controller

You can choose the Cisco 12G SAS RAID controller, which plugs into a dedicated RAID controller card slot. This RAID controller supports RAID 0, 1, 10 (without the FBWC option) and supports RAID 0, 1, 10, 5, 6, 50, 60 (with the FBWC option).



**NOTE:** The number of RAID groups (virtual drives) supported per RAID controller is as follows:

- Embedded RAID = 8
- Cisco 12G SAS Modular RAID controller = 64

#### SAS HBA (internal HDD/SSD/JBOD support)

Instead of a RAID controller, you can choose a SAS HBA for internal JBOD drive connectivity (non-RAID):

- Cisco 12 Gbps Modular SAS HBA, which plugs into a dedicated RAID controller slot.

#### SAS HBA (external JBOD support)

In addition to a RAID controller or JBOD controller for internal drives, you can choose the following SAS HBA for external JBOD drive connectivity (non-RAID):

- Cisco 9300-8e 12G SAS HBA (provides 8 SAS ports for external JBOD connectivity).



NOTE: The UCSC-C240-M4SX (24-drive server) and UCSC-C240-M4S2 (16-drive server) do not support the default embedded software RAID or the embedded software RAID 5 key upgrade (UCSC-SWRAID5), which is installed on the motherboard. The only drive controller support available for the 24-drive or 16-drive versions is through the Cisco 12G SAS Modular RAID controller (provides RAID control) or the Cisco 12 Gbps Modular SAS HBA (provides JBOD control) for internal drives. The only RAID support available for the 8-drive version is through the Cisco 12G SAS Modular RAID controller for internal drives, the Cisco 12 Gbps Modular SAS HBA, embedded software RAID, or the embedded software RAID 5 key upgrade.

---

## RAID Volumes and Groups

When creating each RAID volume, follow these guidelines:

- Use the same capacity for each drive in each RAID volume
- For embedded software RAID or the embedded software RAID 5 key upgrade:
  - Use only SATA HDDs
  - Embedded software RAID has two ports and each port can control 4 drives, for 8 drives total.
  - Each set of 4 SATA HDDs for a port must be in separate RAID volumes.
  - You cannot mix drives across ports to create a RAID volume.
  - For more details, see *Embedded SATA RAID: Two SATA Controllers, page 89*.
- For the Cisco 12G SAS modular RAID controller upgrade:
  - Use either all SAS HDDs, or all SAS SSDs, or all SATA SSDs in each RAID volume

The number of RAID groups (virtual drives) supported per RAID controller is as follows:

- Embedded RAID = 8
- Cisco 12G SAS Modular RAID controller = 64

## Select Controller Options

---

Select as follows (these choices are dependent on the backplane used (24-drive, 16-drive, or 8-drive backplane)):

- For a 24-drive backplane system, select one of the following:
  - Cisco 12G SAS Modular RAID controller from *Table 10 on page 31*, or
  - Cisco 9300-8E 12G SAS HBA option (JBOD support only for external drives) from *Table 10 on page 31*, or
  - Mixed controllers:
    - One Cisco 12G SAS Modular RAID controller or one Cisco 12 Gbps Modular SAS HBA from *Table 10 on page 31*, and

- One or two Cisco 9300-8E 12G SAS HBAs (JBOD support only for external drives) from [Table 10 on page 31](#)

- Dual HBAs:

- Two Cisco 9300-8E 12G SAS HBAs (JBOD support only for external drives) from [Table 10 on page 31](#)

Select an appropriate optional RAID configuration listed in [Table 10 on page 31](#) (note that the Cisco 12 Gbps Modular SAS HBA supports JBOD only and is not a RAID controller).

- For a 16-drive backplane system, select one of the following:

- Cisco 12G SAS Modular RAID controller or the Cisco 12 Gbps Modular SAS HBA from [Table 10 on page 31](#), or

- Cisco 9300-8E 12G SAS HBA upgrade option from [Table 10 on page 31](#), or

- Mixed controllers:

- One Cisco 12G SAS Modular RAID controller or the Cisco 12 Gbps Modular SAS HBA from [Table 10 on page 31](#), and

- One or two Cisco 9300-8E 12G SAS HBAs (JBOD support only for external drives) from [Table 10 on page 31](#)

- Dual HBAs:

- Two Cisco 9300-8E 12G SAS HBAs (JBOD support only for external drives) from [Table 10 on page 31](#)

Select an appropriate optional RAID configuration listed in [Table 10 on page 31](#).

- For an 8-drive backplane system, select one of the following:

- Embedded software RAID (this is the default if no other selection is made), or

- Embedded software RAID 5 key upgrade option for internal drives (see [Table 9](#)), or

- Cisco 12G SAS modular RAID controller or the Cisco 12 Gbps Modular SAS HBA (see [Table 10 on page 31](#)), or

- Cisco 9300-8E 12G SAS HBA upgrade option from [Table 10 on page 31](#), or

- Mixed controllers:

- One Cisco 12G SAS modular RAID controller or the Cisco 12 Gbps Modular SAS HBA, and

- One or two Cisco 9300-8E 12G SAS HBAs for external SAS JBOD/enclosure connectivity support (see [Table 10 on page 31](#)).

- Dual HBAs:

- Two Cisco 9300-8E 12G SAS HBAs (JBOD support only for external drives) from [Table 10 on page 31](#)



---

NOTE: Mixing the Cisco 9300-8E 12G SAS HBA in the same server as the Cisco 12 Gbps Modular SAS HBA requires the following firmware levels:

- Cisco IMC/BIOS 2.0(8) or later
  - Cisco UCS Manager 2.2(6) or later (for integrated servers only)
- 

For the Cisco 12G SAS modular RAID controller upgrade, select an appropriate optional RAID configuration listed in [Table 10 on page 31](#)



---

NOTE: The Cisco 12G SAS modular RAID controller can be ordered with or without an optional FBWC (cache). The FBWC option backs up the RAID controller write cache. The FBWC is available in 1 GB, 2 GB, or 4 GB sizes. See [Table 10 on page 31](#) for details.

---



---

NOTE: For all valid combinations of embedded RAID and internal/external controller combinations, see [RAID Details, page 85](#).

---

[Table 9](#) shows the product ID for the C240 M4 server entry-level RAID solution. This RAID option is accomplished with embedded software that supports a limited number of drives, operating systems, and virtualized environments. For a more comprehensive enterprise RAID solution, choose the Cisco 12G SAS

modular RAID controller listed in [Table 10](#).

Table 9 Entry Level RAID Solution

Product ID (PID)	PID Description
Embedded Software RAID 5 Key Upgrade	
UCSC-SWRAID5	<p>Embedded Software RAID 5 key upgrade, consisting of a storage controller unit (SCU) module that plugs into a 2-pin header on the motherboard, supporting up to eight internal SATA only HDDs. See <a href="#">Embedded SATA RAID: Two SATA Controllers, page 89</a>. This module upgrades the embedded software RAID controller option to add RAID 5. This option supports RAID 0, 1, 10, 5 and operates at 6 Gbps. Operating systems supported are Windows and Linux only (no VMware support).</p> <p>VMware ESX/ESXi or any other virtualized environments (such as Hyper-V, Xen, or KVM) are not supported for use with the embedded software RAID controller.</p>

Table 10 Hardware Controller Options

Product ID (PID)	PID Description
Controllers for Internal Drives	
<p>Note that if the following Cisco 12G SAS Modular RAID controller or Cisco 12Gbps Modular SAS HBA controller is selected, it is factory-installed in the dedicated internal slot.</p>	
UCSC-MRAID12G	<p>Cisco 12G SAS Modular RAID Controller</p> <ul style="list-style-type: none"> <li>■ Supports up to 24 internal SAS HDDs and SAS/SATA SSDs</li> <li>■ Supports JBOD, RAID 0, 1, 10 (with no FBWC option chosen) and has the ability to also support RAID 5, 6 if a Flash-Backed Write cache upgrade is chosen (shown below in this table)</li> </ul>
UCSC-SAS12GHBA	<p>Cisco 12 Gbps Modular SAS HBA</p> <ul style="list-style-type: none"> <li>■ Supports up to 24 internal SAS HDDs and SAS/SATA SSDs</li> <li>■ Supports JBOD mode only (no RAID functionality. Ideal for SDS (Software Defined Storage) applications. It is also ideal for environments demanding the highest IOPs (for external SSD attach), where a RAID controller can be an I/O bottleneck.</li> </ul>
Flash-Backed Write Cache (FBWC) Upgrade Options for Cisco 12G SAS Modular RAID controller	
UCSC-MRAID12G-1GB	1 GB FBWC, which includes a 1 GB MB memory plus a SuperCap for write cache backup. Supports JBOD, RAID 0, 1, 10, 5, 6, 50, and 60.
UCSC-MRAID12G-2GB	2 GB FBWC, which includes a 2 GB MB memory plus a SuperCap for write cache backup. Supports JBOD, RAID 0, 1, 10, 5, 6, 50, and 60.
UCSC-MRAID12G-4GB	4 GB FBWC, which includes a 4 GB MB memory plus a SuperCap for write cache backup. Supports JBOD, RAID 0, 1, 10, 5, 6, 50, and 60.
SAS HBA for External JBOD Attach	
Two SFF8644 mini-SAS HD connectors on this card are accessible at the rear of the chassis.	

Table 10 Hardware Controller Options (*continued*)

Product ID (PID)	PID Description
UCSC-SAS9300-8E	<p>Cisco 12G 9300-8e 12G SAS HBA for external JBOD attach</p> <ul style="list-style-type: none"> <li>■ Supports external JBOD using x8 wide SAS ports</li> </ul>
<hr/> <div style="display: flex; align-items: flex-start;">  <p>NOTE: For Cisco 9300-8e 12G SAS HBA external drive enclosure support, see the enclosure section of the compatibility list at the following link:</p> <p style="color: #0070C0;"><a href="http://tinyurl.com/pp83xyk">http://tinyurl.com/pp83xyk</a></p> <p>Customers should contact their storage vendor for technical support related to external JBOD enclosures.</p> </div> <hr/>	

RAID Configuration Options (not available for Cisco 12 Gbps Modular SAS HBA or embedded software RAID)	
R2XX-SRAID0	Enable Single Disk Raid 0 Setting
R2XX-RAID0	Factory preconfigured RAID striping option Enable RAID 0 Setting. Requires a minimum of one hard drive.
R2XX-RAID1	Factory preconfigured RAID mirroring option Enable RAID 1 Setting. Requires exactly two drives with the same size, speed, capacity.
R2XX-RAID5	Factory preconfigured RAID option Enable RAID 5 Setting. Requires a minimum of three drives of the same size, speed, capacity.
R2XX-RAID6	Factory preconfigured RAID option Enable RAID 6 Setting. Requires a minimum of four drives of the same size, speed, capacity.



NOTE: Although RAID levels 50 and 60 are not orderable from the factory, they are supported for selected controllers as shown in [Table 10](#)

### Approved Configurations

The C240 M4 SFF server can be ordered as a UCSC-C240-M4SX (24-drive backplane with SAS expander), a UCSC-C240-M4S2 (16-drive backplane with SAS expander), or UCSC-C240-M4S (8-drive backplane with no SAS expander).

- The embedded software RAID (default) supports up to 8 internal SATA HDDs with RAID 0, 1, 10 support.
- The embedded software RAID 5 upgrade key option supports up to 8 internal SATA HDDs with RAID 0, 1, 10, 5 support.



- The Cisco 12G SAS Modular RAID controller upgrade option supports up to 24 internal drives with up to RAID 0, 1, 10, 5, 6, 50, 60 support (with FBWC option chosen).
- The Cisco 12 Gbps Modular SAS HBA supports up to 24 internal drives with JBOD support.
- The Cisco 9300-8e 12G SAS HBA supports up to 8 external SAS ports with JBOD support.

See [Table 11](#) for a summary of the supported controller configuration options.

Table 11 Supported Controller Configurations

Server	# CPUs	Embedded RAID <sup>1</sup>	Cisco 12G SAS Modular RAID Controller or Cisco 12 Gbps Modular SAS HBA <sup>2</sup> (only one can be installed at a time)		Cisco 9300-8E 12G SAS HBA <sup>3</sup>	# Drives Supported	RAID Support	Internal Drive Types Allowed
			Cisco 12G SAS Modular RAID Controller	Cisco 12G Modular SAS HBA				
C240 M4 SFF 24 HDD	1	Not allowed	Installed in dedicated slot	Installed in dedicated slot	Card absent	24 internal	0,1,10,5,6,50,60 (for 12G SAS) or JBOD (for Modular SAS HBA)	SAS HDDs, SAS/SATA SSDs
			Only one of the above can be installed at a time					
C240 M4 SFF 24 HDD	1	Not allowed	Card absent	Card absent	Installed slot 1, 2, or 3	0 internal 1024 external	JBOD	None
C240 M4 SFF 24 HDD	1	Not allowed	Installed in dedicated slot	Installed in dedicated slot	Installed slot 1, 2, or 3	24 internal 1024 external	0,1,10,5,6,50,60 (for 12G SAS) or JBOD (for Modular SAS HBA) and JBOD (for 9300)	SAS HDDs, SAS/SATA SSDs
			Only one of the above can be installed at a time					
C240 M4 SFF 24 HDD	2	Not allowed	Installed in dedicated slot	Installed in dedicated slot	Card absent	24 internal	0,1,10,5,6,50,60 (for 12G SAS) or JBOD (for Modular SAS HBA)	SAS HDDs, SAS/SATA SSDs
			Only one of the above can be installed at a time					

Table 11 Supported Controller Configurations (continued)

Server	# CPUs	Embedded RAID <sup>1</sup>	Cisco 12G SAS Modular RAID Controller or Cisco 12 Gbps Modular SAS HBA <sup>2</sup> (only one can be installed at a time)		Cisco 9300-8E 12G SAS HBA <sup>3</sup>	# Drives Supported	RAID Support	Internal Drive Types Allowed
			Cisco 12G SAS Modular RAID Controller	Cisco 12G Modular SAS HBA				
C240 M4 SFF 24 HDD	2	Not allowed	Card absent	Card absent	Installed any slot	0 internal 1024 external	JBOD	None
C240 M4 SFF 24 HDD	2	Not allowed	Installed in dedicated slot	Installed in dedicated slot	Installed any slot	24 internal 1024 external	0,1,10,5,6,50,60 (for 12G SAS) or JBOD (for Modular SAS HBA) and JBOD (for 9300)	SAS HDDs, SAS/SATA SSDs
			Only one of the above can be installed at a time					
C240 M4 SFF 16 HDD	1	Not allowed	Installed in dedicated slot	Installed in dedicated slot	Card absent	16 internal	0,1,10,5,6,50,60 (for 12G SAS) or JBOD (for Modular SAS HBA)	SAS HDDs, SAS/SATA SSDs
			Only one of the above can be installed at a time					
C240 M4 SFF 16 HDD	1	Not allowed	Card absent	Card absent	Installed slot 1, 2, or 3	0 internal 1024 external	JBOD	None
C240 M4 SFF 16 HDD	1	Not allowed	Installed in dedicated slot	Installed in dedicated slot	Installed slot 1, 2, or 3	16 internal 1024 external	0,1,10,5,6,50,60 (for 12G SAS) or JBOD (for Modular SAS HBA) and JBOD (for 9300)	SAS HDDs, SAS/SATA SSDs
			Only one of the above can be installed at a time					
C240 M4 SFF 16 HDD	2	Not allowed	Installed in dedicated slot	Installed in dedicated slot	Card absent	16 internal	0,1,10,5,6,50,60 (for 12G SAS) or JBOD (for Modular SAS HBA)	SAS HDDs, SAS/SATA SSDs

Table 11 Supported Controller Configurations (continued)

Server	# CPUs	Embedded RAID <sup>1</sup>	Cisco 12G SAS Modular RAID Controller or Cisco 12 Gbps Modular SAS HBA <sup>2</sup> (only one can be installed at a time)		Cisco 9300-8E 12G SAS HBA <sup>3</sup>	# Drives Supported	RAID Support	Internal Drive Types Allowed
			Cisco 12G SAS Modular RAID Controller	Cisco 12G Modular SAS HBA				
			Only one of the above can be installed at a time					
C240 M4 SFF 16 HDD	2	Not allowed	Card absent	Card absent	Installed any slot	0 internal 1024 external	JBOD	None
C240 M4 SFF 16 HDD	2	Not allowed	Installed in dedicated slot	Installed in dedicated slot	Installed any slot	16 internal 1024 external	0,1,10,5,6,50,60 (for 12G SAS) or JBOD (for Modular SAS HBA) and JBOD (for 9300)	SASHDDs, SAS/SATA SSDs
			Only one of the above can be installed at a time					
C240 M4 SFF 8 HDD	1	Enabled	Not allowed	Not allowed	Not allowed	8 internal	0, 1, 10 (default) or 0, 1, 10, 5 (RAID 5 key upgrade)	SATA HDDs
C240 M4 SFF 8 HDD	1	Not allowed	Installed in dedicated slot	Installed in dedicated slot	Card absent	8 internal	0,1,10,5,6,50,60 (for 12G SAS) or JBOD (for Modular SAS HBA)	SASHDDs, SAS/SATA SSDs
			Only one of the above can be installed at a time					
C240 M4 SFF 8 HDD	1	Not allowed	Card absent	Card absent	Installed slot 1, 2, or 3	0 internal 1024 external	JBOD	None
C240 M4 SFF 8 HDD	1	Not allowed	Installed in dedicated slot	Installed in dedicated slot	Installed slot 1, 2, or 3	8 internal 1024 external	0,1,10,5,6,50,60 (for 12G SAS) or JBOD (for Modular SAS HBA) and JBOD (for 9300)	SASHDDs, SAS/SATA SSDs

Table 11 Supported Controller Configurations (continued)

Server	# CPUs	Embedded RAID <sup>1</sup>	Cisco 12G SAS Modular RAID Controller or Cisco 12 Gbps Modular SAS HBA <sup>2</sup> (only one can be installed at a time)		Cisco 9300-8E 12G SAS HBA <sup>3</sup>	# Drives Supported	RAID Support	Internal Drive Types Allowed	
			Cisco 12G SAS Modular RAID Controller	Cisco 12G Modular SAS HBA					
			Only one of the above can be installed at a time						
C240 M4 SFF 8 HDD	2	Enabled	Not allowed	Not allowed	Not allowed	8 internal SATA only	0, 1, 10 (default) or 0, 1, 10, 5 (RAID 5 key upgrade)	SATA HDDs	
C240 M4 SFF 8 HDD	2	Not allowed	Installed in dedicated slot	Installed in dedicated slot	Card absent	8 internal	0,1,10,5,6,50,60 (for 12G SAS) or JBOD (for Modular SAS HBA)	SASHDDs, SAS/SATA SSDs	
			Only one of the above can be installed at a time						
C240 M4 SFF 8 HDD	2	Not allowed	Card absent	Card absent	Installed any slot	0 internal 1024 external	JBOD	None	
C240 M4 SFF 8 HDD	2	Not allowed	Installed in dedicated slot	Installed in dedicated slot	Installed any slot	8 internal 1024 external	0,1,10,5,6,50,60 (for 12G SAS) or JBOD (for Modular SAS HBA) and JBOD (for 9300)	SASHDDs, SAS/SATA SSDs	
			Only one of the above can be installed at a time						

Notes . . .

1. Embedded RAID is only compatible with the 8 HDD backplane. It cannot be used with the 16 or 24 HDD backplane, because those backplanes have SAS extenders.
2. If you want to boot from a device other than the Cisco 12G SAS Modular RAID controller or Cisco 12 Gbps Modular SAS HBA, you can leave the card installed. Just disable the OPROM for its slot, and the system will boot even with the card installed.
3. External drive PCIe controller card is the Cisco 12G 9300-8e 12G SAS HBA and can be installed simultaneously with the Cisco 12G SAS Modular RAID controller card or Cisco 12 Gbps Modular SAS HBA.

---

## Caveats

---

- A maximum of two Cisco 9300-8e 12G SAS HBAs can be installed in any slot (depending on the number of CPUs installed). The system can also support combinations of one Cisco 9300-8e 12G SAS HBA and a Storage Accelerator card along with either a Cisco 12G SAS Modular RAID Controller, or a Cisco 12 Gbps Modular SAS HBA.
- For the Cisco 12G SAS Modular RAID controller you can choose an optional RAID configuration (up to RAID 0, 1, 10, 5, 6, 50, 60 if optional FBWC option is chosen), which is preconfigured at the factory. The RAID level you choose must be an available RAID choice for the controller selected. RAID levels 50 and 60 are supported, although they are not available as configuration options. It can also be combined with AHCI support for internal SSDs (SATA Boot Drives) in 24-drive systems (only) and cannot be mixed with Embedded RAID.
- A system supports up to 8 SATA-only drives through the embedded software RAID controller if no Cisco 12G SAS Modular RAID controller is chosen.



NOTE: For more important information regarding RAID support, see [RAID Details, page 85](#) and [RAID Option ROM \(OPROM\) Settings, page 86](#).

---

## STEP 6 SELECT HARD DISK DRIVES (HDDs) or SOLID STATE DRIVES (SSDs)

The standard disk drive features are:

- 2.5-inch small form factor
- Hot-pluggable
- Drives come mounted in sleds

### Select Drives

The available HDDs and SSDs are listed in [Table 12](#).

Table 12 Available Hot-Pluggable Sled-Mounted HDDs and SSDs

Product ID (PID)	PID Description <sup>1</sup>	Drive Type	Capacity
<b>HDDs (15K RPM)</b>			
UCS-HD600G15K9	600 GB 12G SAS 15K RPM SFF HDD (SED)	SAS	600 GB
UCS-HD600G15K12G	600 GB 12G SAS 15K RPM SFF HDD	SAS	600 GB
UCS-HD450G15K12G	450 GB 12G SAS 15K RPM SFF HDD	SAS	450 GB
UCS-HD300G15K12G	300 GB 12G SAS 15K RPM SFF HDD	SAS	300 GB
<b>HDDs (10K RPM)</b>			
UCS-HD18G10K9	1.8 TB 12G SAS 10K RPM SFF HDD (4K)	SAS	1.8 TB
UCS-HD12G10K9	1.2 TB 12G SAS 10K RPM SFF HDD (SED)	SAS	1.2 TB
UCS-HD300G10K9	300 GB 12G SAS 10K RPM SFF HDD (SED)	SAS	300 GB
UCS-HD18TB10KS4K <sup>2</sup>	1.8 TB 12 Gbps SAS 10K RPM SFF HDD (4K sector format)	SAS	1.8 TB
UCS-HD12TB10K12G	1.2 TB 12G SAS 10K RPM SFF HDD	SAS	1.2 TB
UCS-HD900G10K12G	900 GB 12G SAS 10K RPM SFF HDD	SAS	900 GB
UCS-HD600G10K12G	600 GB 12G SAS 10K RPM SFF HDD	SAS	600 GB
UCS-HD600G10KS4K <sup>1</sup>	600 GB 12 Gbps SAS 10K RPM SFF HDD (4K sector format)	SAS	600 GB
UCS-HD300G10K12G	300 GB 12G SAS 10K RPM SFF HDD	SAS	300 GB
UCS-HDD900GI2F106	900 GB 6 Gbps SAS 10K RPM SFF HDD	SAS	900 GB
A03-D600GA2	600 GB 6 Gbps SAS 10K RPM SFF HDD	SAS	600 GB
A03-D300GA2	300 GB 6 Gbps SAS 10K RPM SFF HDD	SAS	300 GB

Table 12 Available Hot-Pluggable Sled-Mounted HDDs and SSDs (continued)

Product ID (PID)	PID Description <sup>1</sup>	Drive Type	Capacity
<b>HDDs (7.2K RPM)</b>			
UCS-HD2T7KS4K	2 TB 12G SAS 7.2K RPM SFF HDD (4K sector format)	SAS	2 TB
UCS-HD2T7K12G	2 TB 12G SAS 7.2K RPM SFF HDD	SAS	2 TB
UCS-HD1T7KS4K	1 TB 12G SAS 7.2K RPM SFF HDD (4K sector format)	SAS	1 TB
UCS-HD1T7K12GA	1 TB 12G SAS 7.2K RPM SFF HDD	SAS	1 TB
UCS-HD1T7K6GA	1 TB 6G SATA 7.2K RPM SFF HDD	SATA	1 TB
UCS-HD1T7KS2-E	1 TB 6 Gbps SAS 7.2K RPM SFF HDD	SAS	1 TB
<b>SSDs</b>			
<b>Enterprise Performance SSDs (High endurance, supports up to 10 FDWP (Full drive writes per day))<sup>3</sup></b>			
UCS-SD600GBE3K9	600 GB Enterprise performance SATA SSD (3X FWPD, SED)	SATA	600 GB
UCS-SD16TB12S4-EP	1.6 TB 2.5 inch Enterprise Performance 12G SAS SSD(10X endurance)	SAS	1.6 TB
UCS-SD16TB12S3-EP	1.6 TB 2.5 inch Enterprise Performance 6G SATA SSD(3X endurance)	SATA	1.6 TB
UCS-SD400G12S4-EP	400 GB 2.5 inch Enterprise Performance 12G SAS SSD (10X endurance)	SAS	400 GB
UCS-SD800G12S4-EP	800 GB 2.5 inch Enterprise Performance 12G SAS SSD (10X endurance)	SAS	800 GB
UCS-SD800G0KS2-EP	800 GB Enterprise Performance 6 Gbps SAS eMLC SSD (Samsung 1625)	SAS	800 GB
UCS-SD480G12S3-EP	480 GB 2.5 inch Enterprise Performance 6GSATA SSD (3X endurance)	SATA	480 GB
UCS-SD400G0KS2-EP	400 GB Enterprise Performance 6 Gbps SAS eMLC SSD (Samsung 1625)	SAS	400 GB
UCS-SD200G0KS2-EP	200 GB Enterprise Performance 6 Gbps SAS eMLC SSD (Samsung 1625)	SAS	200 GB
<b>Enterprise Value SSDs (Low endurance, supports up to 1 FDWP (Full drive write per day))<sup>4</sup></b>			
UCS-SD960GBE1K9	960 GB Enterprise value SATA SSD (1X FWPD, SED)	SATA	960 GB
UCS-SD480GBE1K9	480 GB Enterprise Value SATA SSD (1XFWPD, SED)	SATA	480 GB
UCS-SD38TBKS4-EV	3.8TB 2.5 inch Enterprise Value 6G SATA SSD (Samsung 863)	SATA	3.8 TB
UCS-SD16TBKS4-EV	1.6 TB 2.5 inch Enterprise Value 6G SATA SSD (Intel 3510)	SATA	1.6 TB
UCS-SD480GBKS4-EV	480 GB 2.5 inch Enterprise Value 6G SATA SSD (Intel 3510)	SATA	480 GB
UCS-SD120GBKS4-EV	120 GB 2.5 inch Enterprise Value 6G SATA SSD (Intel 3510)	SATA	120 GB
UCS-SD960GBKS4-EV	960 GB 2.5 inch Enterprise Value 6G SATA SSD	SATA	960 GB
UCS-SD960G0KS2-EV	960 GB 2.5 inch Enterprise Value 6 Gbps SATA SSD (Samsung 853T)	SATA	960 GB
UCS-SD240GBKS4-EV	240 GB 2.5 inch Enterprise Value 6G SATA SSD	SATA	240 GB

## Notes . . .

1. For all self-encrypting drives (SED), standalone Management (CIMC) is supported for configuring and managing local keys (UCSM is not supported). Also, 4K format drives do not support Vmware and require UEFI boot.

2. Operating system support on 4k sector size drives is as follows:
  - Windows: Win2012 and Win2012R2.
  - Linux: RHEL 6.5/6.6/6.7/7.0/7.2/Sles 11 SP3 and Sles 12.
  - ESXi/Vmware is not supported
 EFI mode is available only for boot support- legacy boot mode is not supported. EFI mode is needed only when you boot from 4K format drives.  
 Ensure that the 4K sector size and 512 byte sector size drives are not configured as part of the same RAID volume.
3. Targeted for write centric IO applications. Supports endurance of 10 FDWP (Full drive writes per day). Target applications are caching, online transaction processing (OLTP), data warehousing, and virtual desktop infrastructure (VDI).
4. Targeted for read centric IO applications. Supports endurance of 1 FDWP (Full drive write per day). Target applications are boot, streaming media, and collaboration.

The available boot drives are listed in [Table 13](#).

Table 13 Available Boot Drives (mounted inside chassis)

Product ID (PID)	PID Description	Drive Type	Capacity
<b>Boot Drives</b>			
UCS-SD16TBKS4-EB	1.6 TB 2.5 inch Enterprise Value 6G SATA SSD (BOOT)	SATA	1.6 TB
UCS-SD240GBKS4-EB	240 GB 2.5 inch Enterprise Value 6G SATA SSD (boot)	SATA	240 GB
UCS-SD120GBE1K9	120GB Enterprise Value SSD (SATA) (boot)	SATA	120 GB

The available plug-in PCIe SSD drives and kits are listed in [Table 14](#).

Table 14 Available Plug-In NVMe PCIe SSDs<sup>1</sup>

Product ID (PID)	PID Description	Drive Type	Capacity
<b>NVMe PCIe SSDs</b>			
UCS-SDHPCIE16TB	1.6 TB 2.5-inch NVMe-based PCIe SSD	NVMe SSD	1.6 TB
UCS-SDHPCIE800GB	800 GB 2.5-inch NVMe-based PCIe SSD	NVMe SSD	800 GB
C240 M4 PCIE SSD Interposer board + cable kit (24 drive configuration) <sup>2</sup>			
UCSC-IPSSD-240M4B			
C240 M4 PCIE SSD Interposer board + cable kit (8 or 16 drive configurations) <sup>2</sup>			
UCSC-IP-SSD-240M4			

Notes . . .

1. If you choose one or two PCIe SSD drives, drive slots 1 and 2 at the front of the chassis are reserved for these drives (see [Figure 2 on page 6](#) for drive slot numbering).
2. You must order an interposer board and cable kit if you order an NVMe PCIe SSD. A single interposer board and cable kit supports up to two NVMe PCIe SSDs.



---

## Approved Configurations

---

### (1) For systems with an 8-drive backplane:

- The embedded software RAID default supports up to 8 internal SATA HDDs with RAID 0, 1, 10 support.
- The embedded software RAID 5 upgrade key option supports up to 8 internal SATA HDDs with RAID 0, 1, 10, 5 support.

### (2) For systems with a 16-drive backplane:

- The Cisco 12G SAS Modular RAID controller upgrade option supports up to 16 internal SAS HDDs and SAS/SATA SSDs.
  - The Cisco 12G SAS Modular RAID controller *with no FBWC option* (supports JBOD, RAID 0, 1, 10)
  - The Cisco 12G SAS Modular RAID controller *with FBWC option* (supports JBOD, RAID 0, 1, 10, 5, 6, 50, and 60)

### (3) For systems with a 24-drive backplane:

- The Cisco 12G SAS Modular RAID controller upgrade option supports up to 24 internal SAS HDDs and SAS/SATA SSDs.
- The Cisco 12 Gbps Modular SAS HBA upgrade option supports up to 24 internal SAS HDDs and SAS/SATA SSDs.



**NOTE:** If you selected a Cisco 12G SAS Modular RAID controller for internal HDDs/SSDs, you have the following options:

- Cisco 12G SAS Modular RAID controller with *no FBWC* option (supports JBOD, RAID 0, 1, 10)
  - Cisco 12G SAS Modular RAID controller *with FBWC* option (supports JBOD, and RAID up to 0, 1, 10, 5, 6, 50, and 60)
  - For either option, select up to 8, 16, or 24 SAS HDDs or SAS/SATA SSDs, as appropriate listed in [Table 12 on page 38](#).
  - See [SELECT RAID CONTROLLERS, page 27](#) for more details.
-

#### (4) Systems Using Boot Drives

- If you are configuring a 24-drive backplane system that uses SATA SSD boot drives, choose up to two identical boot drives from [Table 13 on page 40](#).



NOTE: The two SATA SSD boot drives are supported only on the 24-drive backplane chassis version. The drives are managed in AHCI mode, using OS-based software RAID. These two drives, managed with OS software RAID, can coexist with drives managed by either embedded RAID, the Cisco 12 Gbps Modular SAS HBA, or a Cisco UCS 12G SAS modular RAID controller. The drives are plugged directly into the SATA boot drive connectors on riser card 1 (option 3). The internal boot drives come mounted to their own unique internal drive sleds, which are different from the front loading hot-swappable drive sleds. See [Riser Card Configuration and Options, page 87](#).

---

#### (5) Systems Using Plug-in NVMe PCIe SSDs

Systems using NVMe PCIe SSDs are controlled through the PCIe bus. If you choose one or two NVMe PCIe SSDs, they must be plugged into only drive slots 1 and 2 in the front of the chassis. Additionally, any system implementing NVMe PCIe SSDs must be ordered with two CPUs.

#### Caveats

---

- You can choose only SATA HDDs when using embedded software RAID.
- You can choose only SAS HDDs or SAS/SATA SSDs when using the Cisco 12G SAS Modular RAID Controller or Cisco 12 Gbps Modular SAS HBA.
- You can mix HDDs and SSDs as long as you keep all HDDs in their own RAID volume and all SSDs in their own RAID volume.
- You can mix SAS HDDs and SAS/SATA SSDs when using the Cisco 12G SAS Modular RAID Controller or Cisco 12 Gbps Modular SAS HBA.
- If you order one or two boot drives, you can order a maximum of one GPU and it must be installed in Riser 2 (UCSC-PCI-2-C240M4) slot 5.
- If you order any NVMe PCIe SSDs, you must also order two CPUs.
- A maximum of two NVMe PCIe SSDs can be ordered.
- NVMe PCIe SSDs are not bootable
- NVMe PCIe SSDs cannot be controlled with a RAID controller.

## STEP 7 SELECT PCIe OPTION CARD(s)

The standard PCIe card offerings are:

- Modular LAN on Motherboard (MLOM)
- Virtual Interface Cards (VICs)
- Network Interface Cards (NICs)
- Converged Network Adapters (CNAs)
- Host Bus Adapters (HBAs)
- UCS Storage Accelerators

### Select PCIe Option Cards

The available PCIe option cards are listed in [Table 15](#).

Table 15 Available PCIe Option Cards<sup>1</sup>

Product ID (PID)	PID Description	Card Height
<b>Modular LAN on Motherboard (mLOM)<sup>2</sup></b>		
UCSC-MLOM-C10T-02	Cisco UCS VIC1227T VIC MLOM - Dual Port 10GBaseT	N/A
UCSC-MLOM-CSC-02	Cisco UCS VIC1227 VIC MLOM - Dual Port 10Gb SFP+	N/A
UCSC-MLOM-IRJ45	Intel i350 quad-port MLOM NIC	N/A
UCSC-MLOM-C40Q-03	Cisco VIC 1387 Dual Port 40Gb QSFP CNA MLOM	N/A
<b>Virtual Interface Cards (VICs)</b>		
UCSC-PCIE-CSC-02	Cisco VIC 1225 Dual Port 10Gb SFP+ CNA	Half
UCSC-PCIE-C10T-02	Cisco VIC 1225T Dual Port 10GBaseT CNA	Half
UCSC-PCIE-C40Q-03	Cisco VIC 1385 Dual Port 40Gb QSFP+ CNA w/RDMA	Half
<b>Network Interface Cards (NICs)</b>		
<b>1 Gb NICs</b>		
N2XX-ABPCI03-M3	Broadcom 5709 Quad Port 1Gb w/TOE iSCSI for M3 Servers	Half
N2XX-ABPCI01-M3	Broadcom 5709 Dual-Port Ethernet PCIe Adapter M3 & later	Half
UCSC-PCIE-IRJ45	Intel i350 Quad Port 1Gb Adapter	Half
<b>10 Gb NICs</b>		
N2XX-AIPCI01	Intel X520 Dual Port 10Gb SFP+ Adapter	Half
UCSC-PCIE-ITG	Intel X540 Dual Port 10GBase-T Adapter	Half
UCSC-PCIE-QNICBT	QLogic QLE8442 dual-port 10Gbase-T NIC	Half
UCSC-PCIE-QNICSFP	QLogic QLE8442 dual-port 10G SFP+ NIC	Half

Table 15 Available PCIe Option Cards<sup>1</sup> (continued)

Product ID (PID)	PID Description	Card Height
<b>10 Gb Converged Network Adapters (CNAs)</b>		
UCSC-PCIE-E14102B	Emulex OCe14102B-UX dual-port 10G SFP+ with iSCSI, FCoE CNA	Half
UCSC-PCIE-E14102	Emulex OCe14102-UX dual-port 10 GbE FCoE CNA	Half
UCSC-PCIE-Q8362	Qlogic QLE8362 dual-port 10 GbE FCoE CNA	Half
<b>Host Bus Adapters (HBAs)</b>		
N2XX-AQPCI05	Qlogic QLE2562 Dual Port 8Gb Fibre Channel HBA	Half
UCSC-PCIE-Q2672	Qlogic QLE2672-CSC, 16Gb Fibre Channel HBA with SR Optics	Half
N2XX-AEPCI05	Emulex LPe 12002 Dual Port 8Gb Fibre Channel HBA	Half
UCSC-PCIE-E16002	Emulex LPe16002-M6, 16Gb Fibre Channel HBA with SR Optics	Half
<b>UCS Storage Accelerators<sup>3</sup></b>		
UCSC-F-S64002	UCS Rack PCIe Storage 6400 GB SanDisk SX350 Medium Endurance	Full
UCSC-F-S32002	UCS Rack PCIe Storage 3200 GB SanDisk SX350 Medium Endurance	Half
UCSC-F-S16002	UCS Rack PCIe Storage 1600 GB SanDisk SX350 Medium Endurance	Half
UCSC-F-S13002	UCS Rack PCIe Storage 1300 GB SanDisk SX350 Medium Endurance	Half
UCSC-F-FIO-5200PS	UCS 5200 GB Fusion ioMemory3 PX Performance line for C-Series	Full
UCSC-F-FIO-2600PS	UCS 2600 GB Fusion ioMemory3 PX Performance line for C-Series	Half
UCSC-F-FIO-1300PS	UCS 1300 GB Fusion ioMemory3 PX Performance line for C-Series	Half
UCSC-F-FIO-1000PS	UCS 1000 GB Fusion ioMemory3 PX Performance line for C-Series	Half
UCSC-F-FIO-6400SS	UCS 6400GB Fusion ioMemory3 SX Scale line for C-Series	Full
UCSC-F-FIO-3200SS	UCS 3200GB Fusion ioMemory3 SX Scale line for C-Series	Half

## Notes . . .

1. The GPU cards (see [ORDER GPU CARDS AND GPU POWER CABLES \(OPTIONAL\), page 52](#)) must be inserted into a full length x16 (electrical) PCIe slot. See [Riser Card Configuration and Options, page 87](#) for more details. The rest of the PCIe cards are x8 (electrical) and can be plugged into any PCIe slot of riser 1 or riser 2.
2. The mLOM cards do not plug into any of the riser 1 or riser 2 card slots; instead, they plug into a connector inside the server chassis.
3. A maximum of six storage accelerator cards are supported and some are riser dependent. 1.3 TB, 2.6 TB, or 3.2 TB cards should not be installed in slots 5 or 6 so the total number of those capacity points is four.

## Caveats

- If you choose an external drives controller (Cisco 9300-8e 12G SAS HBA), it will consume one PCIe slot.
- A maximum of six storage accelerator cards are supported and some are riser dependent. 1.3 TB, 2.6 TB, or 3.2 TB cards should not be installed in to slots 5 or 6 so the total number of those capacity points is four.
- For 1-CPU systems:
  - Only the PCIe slots on PCIe riser 1 are available for 1-CPU system.

- The PCIe slots on riser 2 are not supported on 1-CPU systems. The slots are full-height PCIe slots 4, 5, and 6 (see [Figure 5 on page 9](#)). These are the slots on the right when looking at the rear of the server.
  - Only a single plug-in PCIe VIC card may be installed on a 1-CPU system, and it must be installed in slot 2 of riser 1. You can order an mLOM VIC card to be installed in the mLOM slot internal to the chassis and thus have two VIC cards in operation at the same time. See [Table 15 on page 43](#) for the selection of plug-in and mLOM VIC cards. See also [Table 1 on page 11](#) and [Riser Card Configuration and Options, page 87](#) for the PCIe slot physical descriptions.
- For 2-CPU systems:
- Depending on the riser 1 option chosen, up to six PCIe slots are available, three on PCIe riser 1 (PCIe slots 1, 2, and 3) and three on PCIe riser 2 (PCIe slots 4, 5, and 6).
  - All of the slots are full-height.
  - Two plug-in PCIe VIC cards can be installed in 2-CPU systems, using slots 2 and 5. In addition, you can order an mLOM VIC card, which is installed in the mLOM slot inside the chassis and thus have three VIC cards in operation at the same time. See [Table 15 on page 43](#) for the selection of plug-in and mLOM VIC cards. See also [Table 1 on page 11](#) and [Riser Card Configuration and Options, page 87](#) for the PCIe slot physical descriptions.
  - If GPUs are installed in slots 2 (Riser 1 option A) and 5 (Riser 2), the NCSI capability automatically switches over to slots 1 (Riser 1 option A) and 4 (Riser 2). Therefore, Cisco PCIe VICs can be installed in slots 1 and 4 if GPUs are installed in slots 2 and 5.



NOTE: UCSM managed servers are discoverable only if a VIC 1225 is installed in slot 2 or a VIC 1227/1227T is installed in the MLOM slot. If you install two GPUs, they must be located in slots 2 and 5. Therefore, if two GPUs are installed, UCSM managed servers are discoverable only if you install a VIC 1227/1227T in the MLOM slot.

- Other considerations for the Cisco VIC 1225/1225T/1227/1227T/1385 cards:
- VIC 1225 and VIC 1227/1227T support 10G SFP+ optical and copper twinax connections
  - VIC 1225T supports RJ45 Category 6 or better twisted pair cable connections
  - The 2-CPU version of the server supports installation of two PCIe Cisco VIC 1225/1225T/1385 cards and they are supported in PCIe slots 2 and 5. Slot 2 is the primary slot for UCSM integration and slots 2 and 5 are the primary slots for Cisco NIC card mode.
  - VIC 1385 supports a 4x10 Gbps QSFP to SFP breakout fiber cable.
  - The server supports up to two PCIe Cisco VICs (1225, 1225T, 1385) plus an MLOM VIC (1227, 1227T), however, single wire management is supported on only one VIC at a time. If multiple VICs are installed on a server, only one slot has NCSI enabled at a time and for single wire management, priority goes to the MLOM slot, then slot 2, then slot 5 for NCSI management traffic. When multiple cards are installed, connect the single wire management cables in the priority order mentioned above.

- Installation of the Cisco UCS VIC1225 requires that the server have CIMC firmware version 1.4(6) or later installed and VIC firmware of 2.1(0) or later. Installation of the Cisco UCS VIC1225T, requires that the server have CIMC firmware version 1.5(1) or later installed and VIC firmware of 2.1(1) or later.
- The server supports installation of up to two plug-in Cisco VIC 1225/1225T/1385 cards and they are supported only in certain slots. A third simultaneously operating VIC can be the mLOM VIC 1227/1227T card, which is installed in a slot inside the chassis. See [Table 16](#) for details.
- The VIC features mentioned in this section are supported with the following software releases: 2.0.6 (CIMC) and 2.2.5a (UCSM).

Table 16 Cisco UCS 240 M4 Requirements for Plug-in Virtual Interface Cards

VIC PID	Number of Plug-in VICs Supported in Server	Slots That Support VICs <sup>1</sup>	Primary Slot For UCS Integration or Cisco Card NIC Mode	Minimum Cisco IMC Firmware	Minimum VIC Firmware
Cisco UCS VIC1225 (UCSC-PCIE-CSC-02)	2	PCIe 2 PCIe 1	Riser 1: PCIe 2 Riser 2: PCIe 5	1.4(6)	2.1(0)
Cisco UCS VIC1225T (UCSC-PCIE-C10T-02)	2	PCIe 5 PCIe 4	See footnote	1.5(1)	2.1(1)
Cisco UCS VIC 1385 <sup>3</sup> (UCSC-PCIE-C40Q-03)	2	See footnote <sup>2</sup>		2.0(2)	2.2(16)

Notes . . .

1. For riser PID UCSC-PCI-1B-240M4 (riser 1 option B) only: Slot 2 is the only slot that supports a VIC.
2. For riser PID UCSC-PCI-1A-240M4 (riser 1 option A) only: When a GPU card is present in slot 2 of riser 1 option A, NCSI support automatically shifts to slot 1, which becomes the primary slot for a VIC. When a GPU card is present in riser 2 slot 5, NCSI support automatically shifts to slot 4, which becomes the primary slot for a VIC. UCSM managed servers are discoverable only if a VIC 1225 is installed in slot 2 or a VIC 1227/1227T is installed in the MLOM slot. If you install two GPUs, they must be located in slots 2 and 5. Therefore, if two GPUs are installed, UCSM managed servers are discoverable only if you install a VIC 1227/1227T in the MLOM slot.
3. If the Cisco UCS VIC 1385 is installed with another VIC, the VIC 1385 should be installed in the primary VIC slot (an x16 slot, such as riser 1 option A slot 2 or riser 2 slot 5). If riser1 option B is installed, slot 2 is an x8 slot, in which case the VIC 1385 should be installed in slot 5.

- The quantity and type of PCIe cards that can be installed depends in the riser card options. See [Riser Card Configuration and Options, page 87](#) for additional details.
- To help ensure that your operating system is compatible with the card you have selected, or to see additional cards that have been qualified to work with the UCS C240 M4 server, but are not sold on the Cisco pricelist, check the Hardware Compatibility List at this URL:

[http://www.cisco.com/en/US/products/ps10477/prod\\_technical\\_reference\\_list.html](http://www.cisco.com/en/US/products/ps10477/prod_technical_reference_list.html)

## STEP 8 ORDER OPTIONAL NETWORK CARD ACCESSORIES

Copper twinax cables and SFP optical modules may be ordered to support the two-port network cards that are available with the server.

### Choose Optional Twinax Cables

---

*Table 17* lists the copper twinax cables available for the PCIe cards. You can choose cable lengths of 1, 3, 5, 7, or 10 meters. The two longer cables (7 and 10 meters) are active, which means that they contain active components within the SFP+ housing to improve signal quality.

Table 17 Available Twinax Cables

Product ID (PID)	PID Description
SFP-H10GB-CU1M	10GBASE-CU SFP+ Cable (1 M)
SFP-H10GB-CU3M	10GBASE-CU SFP+ Cable (3 M)
SFP-H10GB-CU5M	10GBASE-CU SFP+ Cable (5 M)
SFP-H10GB-ACU7M	10GBASE-CU SFP+ Cable (7 M)
SFP-H10GB-ACU10M	10GBASE-CU SFP+ Cable (10 M)

### Approved Configurations

---

#### (1) Choose Up to Two Twinax Cables for Each Network Card Ordered

- You may choose one or two twinax cables for each compatible PCIe network card ordered. The cables can be different lengths; however, you would normally order two cables of equal lengths to connect to the primary and redundant network switching equipment.

### Choose Optional SFP Modules

---

Optical Cisco SFP+ modules are listed in *Table 18*.

Table 18 Available SFP Modules

Product ID (PID)	PID Description
SFP-10G-SR	10GBASE-SR SFP+ Module 850 nm, multimode, SR, 3.3V, LC connector, with Digital Optical Monitoring
SFP-10G-LR	10GBASE-LR SFP+ Module 1310 nm, single mode, LR, 3.3 V, with Digital Optical Monitoring
DS-SFP-FC8G-SW	8 Gbit SFP+ Module 850 nm, multimode, SR, 3.3V, LC connector, with Digital Optical Monitoring

## Approved Configurations

---

### (1) Choose Up to Two SFP+ Modules for Each Network Card Ordered

- You may choose one or two SFP+ optical modules cables for each compatible PCIe network card ordered. You would normally order two modules for connecting to the primary and redundant network switching equipment. With the SFP+ optical modules, you can use common fiber optic cables, widely available.

See the *Figure 8 on page 51* for typical SFP+ and twinax connections to the network cards.

## Caveats

---

Check the table on the following page for compatibility between the PCIe network cards and SFPs or twinax cables.



**NOTE: The table shows all PCIe network cards for all C-series servers. Not all of the cards shown in the table are supported in this server. The intent of the table is to show compatibility between cards and twinax cables or SFPs.**

---



Table 19 PCIe Card Compatibility

PCIe Cards	Twinax Cables	Cisco SFP Modules		
		SFP-10G-SR	SFP-10G-LR	DS-SFP-FC8G-SW
<b>Converged Network Adapters (CNAs)</b>				
UCSC-PCIE-BSFP (Broadcom 57712 Dual Port 10Gb SFP+ w/TOE iSCSI)	Yes	Yes	No	
UCSC-PCIE-CSC-02 (Cisco VIC 1225 Dual Port 10Gb SFP+ CNA)	Yes	Yes	Yes	No
UCSC-PCIE-C10T-02 (Cisco VIC 1225T Dual Port 10GBaseT CNA)	No	No	No	No
UCSC-MLOM-CSC-02 (Cisco UCS VIC1227 VIC MLOM - Dual Port 10Gb SFP+)	Yes	Yes	Yes	No
UCSC-MLOM-C10T-02 (Cisco UCS VIC1227T VIC MLOM - Dual Port 10GBaseT)	No	No	No	No
UCSC-PCIE-C40Q-02 (Cisco VIC 1285 Dual Port 40Gb QSFP CNA)	Yes	No <sup>1</sup>	No	
UCSC-PCIE-C40Q-03 (Cisco VIC 1385 Dual Port 40Gb QSFP+ CNA w/RDMA)	Yes	No <sup>1</sup>	No	
UCSC-PCIE-ESFP (Emulex OCe11102-FX dual-port 10 GbE FCoE CNA (Gen 3 CNA))	Yes	Yes	No	
UCSC-PCIE-QSFP (QLogic QLE8242-CU dual-port 10 GbE FCoE CNA)	Yes	Use QLogic SFP		
UCSC-PCIE-B3SFP (Broadcom 57810 10Gb A-FEX SFP+)	Yes	Yes	No	
UCSC-PCIE-Q8362 (QLogic QLE8362 dual-port 10 GbE FCoE CNA)	Yes	Use QLogic SFP		
UCSC-PCIE-E14102 (Emulex OCe14102-UX dual-port 10 GbE FCoE CNA)	Yes	Yes	No	
<b>Network Interface Cards (NICs)</b>				
N2XX-ABPCI01-M3 (Broadcom 5709 Dual-Port Ethernet PCIe Adapter for M3 Servers)	Use RJ45 Ethernet cable			
N2XX-ABPCI03-M3 (Broadcom 5709 Quad Port 10/100/1Gb NIC w/TOE iSCSI for M3 Servers)	Use RJ45 Ethernet cable			
N2XX-AIPCI01 (Intel X520 Dual Port 10Gb SFP+ Adapter)	Yes	Use Intel SFP CDE2-SFP-1WLR or CDE2-SFP-1WSR		
UCSC-PCIE-ITG (Intel X540 Dual Port 10GBase-T Adapter)	Use RJ45 Ethernet cable			
UCSC-PCIE-IRJ45 (Intel i350 Quad Port 1Gb Adapter)	Use RJ45 Ethernet cable			

Table 19 PCIe Card Compatibility (continued)

PCIe Cards	Twinax Cables	Cisco SFP Modules		
		SFP-10G-SR	SFP-10G-LR	DS-SFP-FC8G-SW
UCSC-PCIE-BTG (Broadcom 57712 Dual Port 10GBASE-T w/TOE iSCSI)	Yes	No	No	
Host Bus Adapters (HBAs)				
N2XX-AEPCI03 (Emulex LPe 11002 Dual Port 4Gb Fibre Channel HBA)	No	Preinstalled - do not change SFP		
N2XX-AEPCI05 (Emulex LPe 12002 Dual Port 8Gb Fibre Channel HBA)	No	Preinstalled - do not change SFP		
N2XX-AQPCI03 (QLogic QLE2462 Dual Port 4Gb Fibre Channel HBA)	No	Preinstalled - do not change SFP		
N2XX-AQPCI05 (QLogic QLE2562 Dual Port 8Gb Fibre Channel HBA)	No	Preinstalled - do not change SFP		
UCSC-PCIE-Q2672 (QLogic QLE2672-CSC, 16Gb Fibre Channel HBA with SR Optics)	No	Preinstalled - do not change SFP		
UCSC-PCIE-E16002 (Emulex LPe16002-M6, 16Gb Fibre Channel HBA with SR Optics)	No	Preinstalled - do not change SFP		

Notes . . .

1. This card supports a 4x10 Gbps QSFP to SFP breakout fiber cable.

Figure 8 Network Card Connections

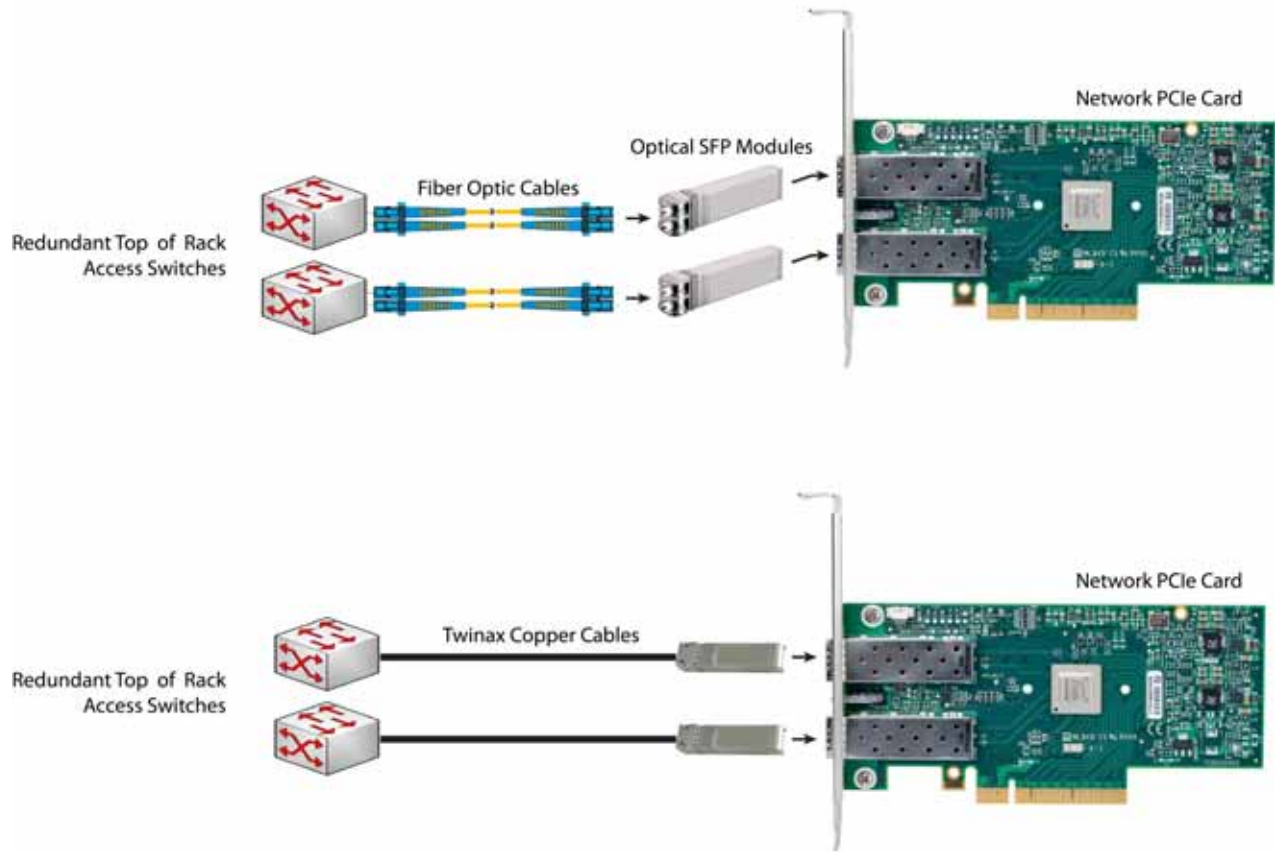

## STEP 9 ORDER GPU CARDS AND GPU POWER CABLES (OPTIONAL)

### Select GPU Options

The available GPU PCIe options are listed in *Table 20*.

Table 20 Available PCIe Option Cards

Product ID (PID)	PID Description	Card Size
GPU PCIe Cards		
UCSC-GPU-K10	NVIDIA K10	Full-height, double wide
UCSC-GPU-K20	NVIDIA K20	Full-height, double wide
UCSC-GPU-K20X	NVIDIA K20X	Full-height, double wide
UCSC-GPU-VGXX1	NVIDIA GRID K1	Full-height, double wide
UCSC-GPU-VGXX2	NVIDIA GRID K2	Full-height, double wide
UCSC-GPU-K40	NVIDIA Tesla K40	Full-height, double wide
UCSC-GPU-M60 <sup>1</sup>	NVIDIA Tesla M60	Full-height, double wide
UCSC-GPU-K80 <sup>1</sup>	NVIDIA K80	Full-height, double wide

Notes . . .

1. You must order a kit with this GPU (UCS-300WKIT-240M4). It is a 300-Watt cable kit system for the UCS C240M4 rack server. Only one kit is needed for either one or two GPUs.



**CAUTION:** Do not operate the C240 M4 server with the 300W GPU kit installed, but no GPU card installed. The kit has been designed to provide adequate airflow for cooling only when at least one GPU card is installed.



**CAUTION:** When using GPU cards, the operating temperature range is 32° to 95°F (0° to 35°C).



**NOTE:** All GPU cards require two CPUs and a minimum of two power supplies in the server. 1400 W power supplies are recommended. Use the power calculator at the following link to determine the needed power based on the options chosen (CPUs, drives, memory, and so on):

<http://ucspowercalc.cisco.com>

## Select GPU Power Cables

---

Whenever you select a K1/K2/K10/K20/K20X/K40 GPU for this server, you must also select one power cable for each GPU selected. The available GPU power cables are listed in [Table 21](#).

Table 21 Available GPU Power Cables

Product ID (PID)	PID Description
UCSC-GPUCBL-240M4	C240 M4 GPU Power Cable

Whenever you select a K80 GPU for this server, you must also select one power cable kit (for either one or two K80 GPUs). The available GPU power cables are listed in [Table 22](#).

Table 22 Available GPU Power Cables (K80 and M60 only)

Product ID (PID)	PID Description
UCS-300WKIT-240M4	300 Watt Cable and Kit for UCS C240M4 Rack Server

## Caveats

---

- NVIDIA GPUs can support only less than 1 TB of total memory in the server. Do not install more than fourteen 64-GB DIMMs when using an NVIDIA GPU card in this server.
- NVIDIA GRID K1 and K2 GPUs can be mixed. No other GPU mixing is allowed.
- If you order a K80 GPU, note the following:
  - You cannot mix the K80 with any other GPU
  - You must select 2 CPUs for the server
  - You must select two 1400 W power supplies (see [ORDER POWER SUPPLY, page 55](#))
- Slot 5 on riser card 2 is the required slot for the first GPU.
- Slot 2 on riser card 1 is the secondary slot for a second GPU. The riser card 1 options that are compatible with GPUs are:
  - Riser card 1 option A (UCSC-PCI-1A-240M4)



NOTE: UCSM managed servers are discoverable only if a VIC 1225 is installed in slot 2 or a VIC 1227/1227T is installed in the MLOM slot. If you install two GPUs, they must be located in slots 2 and 5. Therefore, if two GPUs are installed, UCSM managed servers are discoverable only if you install a VIC 1227/1227T in the MLOM slot.



NOTE: For more information on the riser 1 card options, see [Riser Card Configuration and Options, page 87](#).

- If you order one or two boot drives, you can order a maximum of one GPU and it must be installed in Riser 2 (UCSC-PCI-2-C240M4) slot 5.

## STEP 10 ORDER POWER SUPPLY

The C240 M4 server requires at least one power supply. A lightly loaded server may require one or two 650 W power supplies. A fully loaded server might need to be powered with two larger capacity power supplies. A server with one GPU requires at least two power supplies (1400 W power supplies are recommended). A server with two GPUs also requires at least two power supplies (1400 W power supplies are recommended). Use the power calculator at the following link to determine the needed power based on the options chosen (CPUs, drives, memory, and so on):

<http://ucspowercalc.cisco.com>

Table 23 Power Supply

Product ID (PID)	PID Description
UCSC-PSU2V2-1400W	1400W V2 AC Power Supply (200 - 240V) 2U & 4U C Series
UCSC-PSU2V2-1200W <sup>1</sup>	1200W / 800W V2 AC Power Supply for 2U C-Series Servers
UCSC-PSU-930WDC	930 W -48V DC Common Slot Power Supply for C-series servers
UCSC-PSU2V2-930DC	930 W - 48V V2 DC Power Supply for 2U C-Series Servers
UCSC-PSU2V2-650W	650W V2 AC Power Supply for C-Series Servers

Notes . . .

1. The power output is 1200W with a 200-240V input and 800W with a 100-120V input.



**NOTE:** In a two power supply server, both power supplies must be identical.

## STEP 11 SELECT AC POWER CORD(S)

Using [Table 24](#), select the appropriate AC power cords. You can select a minimum of no power cords and a maximum of two. If you select the option R2XX-DMYMPWRCORD, no power cord is shipped with the server.

Table 24 Available Power Cords

Product ID (PID)	PID Description	Images
R2XX-DMYMPWRCORD	No power cord (dummy PID to allow for a no power cord option)	Not applicable
CAB-N5K6A-NA	Power Cord, 200/240V 6A, North America	
CAB-AC-L620-C13	AC Power Cord, NEMA L6-20 - C13, 2M/6.5ft	
CAB-C13-CBN	CABASY,WIRE,JUMPER CORD, 27" L, C13/C14, 10A/250V	
CAB-C13-C14-2M	CABASY,WIRE,JUMPER CORD, PWR, 2 Meter, C13/C14,10A/250V	
CAB-C13-C14-AC	CORD,PWR,JMP,IEC60320/C14,IEC60320/C13, 3.0M	



Table 24 Available Power Cords

Product ID (PID)	PID Description	Images
CAB-250V-10A-AR	Power Cord, 250V, 10A, Argentina	
CAB-9K10A-AU	Power Cord, 250VAC 10A 3112 Plug, Australia	
CAB-250V-10A-CN	Power Cord, SFS, 250V, 10A, China	
CAB-250V-10A-CN	AC Power Cord - 250V, 10A - PRC	
CAB-9K10A-EU	Power Cord, 250VAC 10A CEE 7/7 Plug, EU	
CAB-250V-10A-ID	Power Cord, SFS, 250V, 10A, India	
CAB-250V-10A-IS	Power Cord, SFS, 250V, 10A, Israel	

Table 24 Available Power Cords

Product ID (PID)	PID Description	Images
CAB-9K10A-IT	Power Cord, 250VAC 10A CEI 23-16/VII Plug, Italy	
CAB-9K10A-SW	Power Cord, 250VAC 10A MP232 Plug, Switzerland	
CAB-9K10A-UK	Power Cord, 250VAC 10A BS1363 Plug (13 A fuse), UK	
CAB-9K12A-NA	Power Cord, 125VAC 13A NEMA 5-15 Plug, North America	
CAB-250V-10A-BR	Power Cord - 250V, 10A - Brazil	
CAB-JPN-3PIN	Power Cord 3PIN, Japan	Image not available
CAB-C19-C20-3M-JP	Power Cord C19-C20, 3M/10ft Japan PSE mark	Image not available

## STEP 12 ORDER TOOL-LESS RAIL KIT AND OPTIONAL REVERSIBLE CABLE MANAGEMENT ARM

### Select a Tool-Less Rail Kit

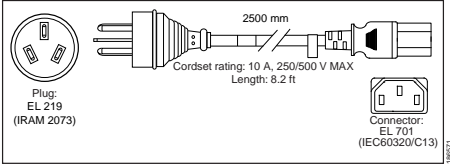
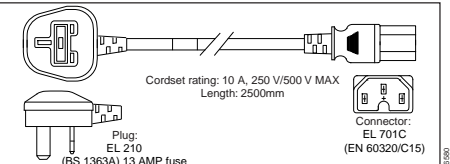
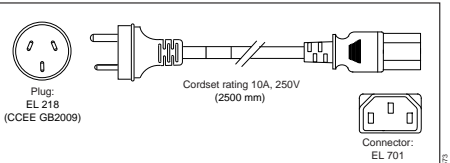
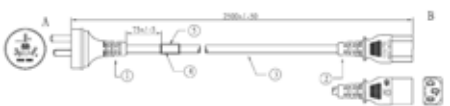
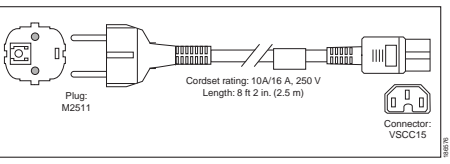
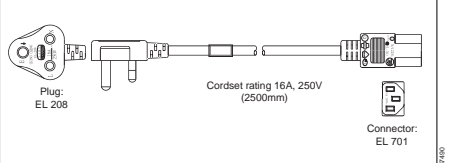
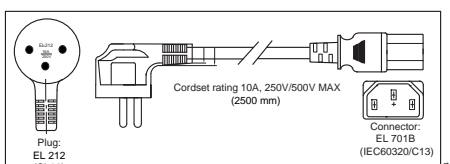
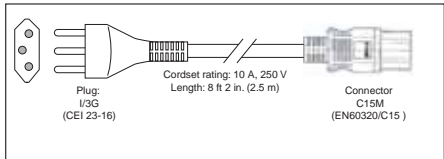
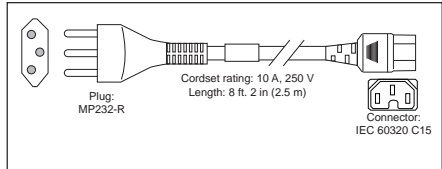
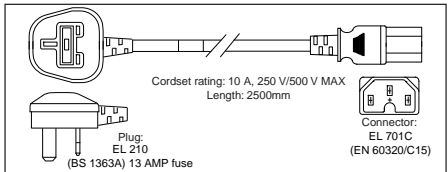
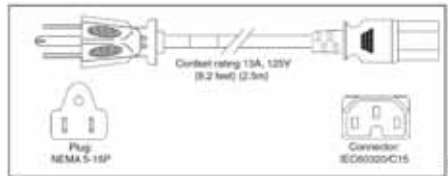
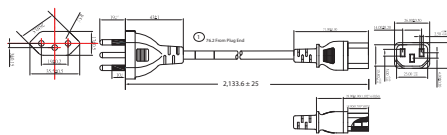
---

Select a tool-less rail kit from [Table 25](#).

Table 25 Tool-Less Rail Kit Options

Product ID (PID)	PID Description
UCSC-RAILB-M4	Ball Bearing Rail Kit for C220 M4 and C240 M4 Rack Servers

### Select an Optional Reversible Cable Management Arm

---

The reversible cable management arm mounts on either the right or left slide rails at the rear of the server and is used for cable management. Use [Table 26](#) to order a cable management arm.

Table 26 Cable Management Arm

Product ID (PID)	PID Description
UCSC-CMA-M4	Reversible CMA for tool-less C240 M4 ball bearing rail kit

For more information about the tool-less rail kit and cable management arm, see the *Cisco UCS C240 M4 Installation and Service Guide* at this URL:

[http://www.cisco.com/c/en/us/td/docs/unified\\_computing/ucs/c/hw/C240M4/install/C240M4.html](http://www.cisco.com/c/en/us/td/docs/unified_computing/ucs/c/hw/C240M4/install/C240M4.html)



**NOTE:** If you plan to rackmount your UCS C240 M4 server, you must order a tool-less tool-less rail kit.

---

## STEP 13 SELECT NIC MODE (OPTIONAL)

By default, the C240 M4 server NIC mode is configured to be Shared LOM Extended. This NIC mode allows any LOM port or adapter card port to be used to access the Cisco Integrated Management Controller (CIMC). The Cisco VIC card must be installed in a slot with NCSI support.

To change the default NIC mode to Dedicated, select the UCSC-DLOM-01 PID shown in [Table 27](#). In Dedicated NIC mode, the CIMC can be accessed only through the dedicated management port. See [Chassis Rear View, page 9](#) for the location of the management port.

To change the default NIC mode to Cisco Card Mode, select the UCSC-CCARD-01 PID shown in [Table 27](#). In this mode, you can assign an IP address to the CIMC using DHCP and from there you can fully automate your deployment.

For more details on all the NIC mode settings, see

[http://www.cisco.com/c/en/us/td/docs/unified\\_computing/ucs/c/sw/gui/config/guide/2-0/b\\_Cisco\\_UCS\\_C-series\\_GUI\\_Configuration\\_Guide\\_201.pdf](http://www.cisco.com/c/en/us/td/docs/unified_computing/ucs/c/sw/gui/config/guide/2-0/b_Cisco_UCS_C-series_GUI_Configuration_Guide_201.pdf)

Table 27 Dedicated NIC Mode Ordering Information

Product ID (PID)	PID Description
UCSC-DLOM-01	Dedicated Mode BIOS setting for C-Series Servers
UCSC-CCARD-01	Cisco Card Mode BIOS setting for C-Series Servers

## STEP 14 ORDER A TRUSTED PLATFORM MODULE (OPTIONAL)

Trusted Platform Module (TPM) is a computer chip (microcontroller) that can securely store artifacts used to authenticate the platform (server). These artifacts can include passwords, certificates, or encryption keys. A TPM can also be used to store platform measurements that help ensure that the platform remains trustworthy. Authentication (ensuring that the platform can prove that it is what it claims to be) and attestation (a process helping to prove that a platform is trustworthy and has not been breached) are necessary steps to ensure safer computing in all environments.

The TPM ordering information is listed in [Table 28](#).

Table 28 Trusted Platform Module

Product ID (PID)	PID Description
UCSX-TPM2-001	Trusted Platform Module 1.2 SPI-based for UCS Servers
UCSX-TPM2-002	Trusted Platform Module 2.0 for UCS servers



**NOTE:** The module used in this system conforms to TPM v1.2 and 2.0, as defined by the Trusted Computing Group (TCG). It is also SPI-based.



**NOTE:** TPM installation is supported after-factory. However, a TPM installs with a one-way screw and cannot be replaced, upgraded, or moved to another server. If a server with a TPM is returned, the replacement server must be ordered with a new TPM. If there is no existing TPM in the server, you can install TPM 2.0. You must first upgrade to UCS firmware that supports Intel E5-2600 v4 CPUs, which is Cisco UCS Manager Release 2.2(7) and later or Release 3.1(1) and later (because Cisco aligned support for TPM 2.0 with these CPUs).



**CAUTION:** If the Cisco UCS server (with Intel E5-2600 v4 or v3 CPUs) is running UCS firmware that added support for Intel E5-2600 v4 CPUs, then it will work with TPM version 2.0. However, if you downgrade the firmware and BIOS to a version earlier than Release 2.2(7) or earlier than Release 3.1(1), then you are vulnerable to a potential security exposure. See the following support matrix for TPM versions.

Table 29 TPM Support Matrix by Intel CPU Version

Intel CPU	TPM Version	Minimum UCS Manager (UCSM) Version
Intel E5-2600 v3	TPM 1.2	Release 2.2(3)
	TPM 2.0	Release 2.2(7) or Release 3.1(1)
Intel E5-2600 v4	TPM 1.2	Release 2.2(7) or Release 3.1(1)
	TPM 2.0	Release 2.2(7) or Release 3.1(1)

## STEP 15 ORDER CISCO FLEXIBLE FLASH SD CARD MODULE (OPTIONAL)

Order 64 GB SD cards or 32 GB SD cards. See [Figure 9 on page 76](#) for the location of the SD cards. There are two locations, SD1 and SD2.

Table 30 64 GB Secure Digital (SD) Card (blank)

Product ID (PID)	PID Description
UCS-SD-64G-S	64 GB SD Card for UCS Servers

Table 31 32 GB Secure Digital (SD) Card (blank)

Product ID (PID)	PID Description
UCS-SD-32G-S	32 GB SD Card for UCS Servers

### Caveats

- Install either one or two 64 GB SD cards or one or two 32 GB SD cards
- Do not mix SD card sizes

## STEP 16 ORDER OPTIONAL USB 3.0 DRIVE

You can order one optional USB 3.0 drive. The USB drive ordering information is listed in [Table 32](#).

Table 32 USB 3.0 Drive

Product ID (PID)	PID Description
UCS-USBFLSHB-16GB	UCS Servers 16 GB Flash USB Drive

See [Figure 9 on page 76](#) for the location of the USB connector



## STEP 17 SELECT OPERATING SYSTEM AND VALUE-ADDED SOFTWARE

Several operating systems and value-added software programs are available. Select as desired from [Table 33](#).

Table 33 OSs and Value-Added Software (for 2-CPU servers)

PID Description	Product ID (PID)
<b>Cisco One</b>	
C1F2PUCSK9	Cisco ONE Foundation Perpetual UCS
C1F2SICFBK9	Cisco ONE Foundation Subsr Intercloud Fabric For Business
C1A1PUCSK9	Cisco ONE Enterprise Cloud Perpetual UCS
C1UCS-OPT-OUT	Cisco One Data Center Compute Opt Out Option
<b>Microsoft Windows Server</b>	
MSWS-12-ST2S	Windows Server 2012 Standard (2 CPU/2 VMs)
MSWS-12-DC2S	Windows Server 2012 Datacenter (2 CPU/Unlimited VMs)
MSWS-12-ST2S-NS	Windows Server 2012 Standard (2 CPU/2 VMs) No Cisco SVC
MSWS-12-DC2S-NS	Windows Server 2012 Datacenter (2 CPU/Unlim VM) No Cisco SVC
MSWS-12R2-ST2S	Windows Server 2012 R2 Standard (2 CPU/2 VMs)
MSWS-12R2-DC2S	Windows Server 2012 R2 Datacenter (2 CPU/Unlimited VMs)
MSWS-12R2-ST2S-NS	Windows Server 2012 R2 Standard (2 CPU/2 VMs) No Cisco SVC
MSWS-12R2-DC2S-NS	Windows Server 2012 R2 Datacen (2 CPU/Unlim VM) No Cisco Svc
<b>SUSE</b>	
SLES-2S2V-1A	SUSE Linux Enterprise Svr (1-2 CPU,1 Phys);1yr Support Reqd
SLES-2S2V-3A	SUSE Linux Enterprise Svr (1-2 CPU,1 Phys);3yr Support Reqd
SLES-2S2V-5A	SUSE Linux Enterprise Svr (1-2 CPU,1 Phys);5yr Support Reqd
SLES-2SUV-1A	SUSE Linux Enterprise Svr (1-2 CPU,Unl Vrt);1yr Support Reqd
SLES-2SUV-3A	SUSE Linux Enterprise Svr (1-2 CPU,Unl Vrt);3yr Support Reqd
SLES-2SUV-5A	SUSE Linux Enterprise Svr (1-2 CPU,Unl Vrt);5yr Support Reqd
SLES-2S-HA-1S	SUSE Linux High Availability Ext (1-2 CPU); 1yr Support Reqd
SLES-2S-HA-3A	SUSE Linux High Availability Ext (1-2 CPU); 3yr Support Reqd
SLES-2S-HA-5A	SUSE Linux High Availability Ext (1-2 CPU); 5yr Support Reqd
SLES-2S-GC-1S	SUSE Linux GEO Clustering for HA (1-2 CPU); 1yr Support Reqd
SLES-2S-GC-3S	SUSE Linux GEO Clustering for HA (1-2 CPU); 3yr Support Reqd
SLES-2S-GC-5S	SUSE Linux GEO Clustering for HA (1-2 CPU); 5yr Support Reqd
SLES-SAP-2S2V-1A	SLES for SAP Applications (1-2 CPU,1 Phys); 1yr Support Reqd
SLES-SAP-2S2V-3A	SLES for SAP Applications (1-2 CPU,1 Phys); 3yr Support Reqd
SLES-SAP-2S2V-5A	SLES for SAP Applications (1-2 CPU,1 Phys); 5yr Support Reqd
SLES-SAP-2SUV-1A	SLES for SAP Applications (1-2 CPU,Unl Vrt);1yr Support Reqd
SLES-SAP-2SUV-3A	SLES for SAP Applications (1-2 CPU,Unl Vrt);3yr Support Reqd
SLES-SAP-2SUV-5A	SLES for SAP Applications (1-2 CPU,Unl Vrt);5yr Support Reqd
<b>Nexus 1000V for Hyper-V and vSphere</b>	

Table 33 OSs and Value-Added Software (for 2-CPU servers) *(continued)*

PID Description	Product ID (PID)
N1K-VSG-UCS-BUN	Over half off N1K and VSG w/ purchase of UCS B/C Series
N1K-VLEM-UCS-1	Nexus 1000V License Paper Delivery (1 CPU) for bundles
VSG-VLEM-UCS-1	VSG License Paper Delivery (1 CPU) for bundles
<b>UCS Director</b>	
CUIC-PHY-SERV-BM-U	Cisco Cloupia Resource Lic - One Phy Server node bare metal
CUIC-PHY-SERV-U	Cisco Cloupia Resource Lic - One physical Server node
CUIC-TERM	Acceptance of Cisco Cloupia License Terms
<b>UCS Performance Manager</b>	
UCS-PM-IE	UCS Performance Manager
UCS-PM-EE	UCS Performance Manager Express
EVAL-UCS-PM-IE	UCS Performance Manager - 60 days evaluation
EVAL-UCS-PM-EE	UCS Performance Manager Express - 60 days evaluation
NFR-UCS-PM-IE	UCS Performance Manager - Not For Resale
NFR-UCS-PM-EE	CS Performance Manager Express - Not For Resale
<b>IMC Supervisor</b>	
EVAL-CIMC-SUP	EVAL: IMC Supervisor-Branch Mgt SW for C/E-Series - 50 Svrs
EVAL-CIMC-SUP-BAS	EVAL: IMC Supervisor One-time Site Installation License
CIMC-SUP-B01	IMC Supervisor-Branch Mgt SW for C-Series & E-Series up to 100 Svrs
CIMC-SUP-B02	IMC Supervisor- Branch Mgt SW for C-Series & E-Series up to 250 Svrs
CIMC-SUP-B10	IMC Supervisor- Branch Mgt SW for C-Series & E-Series up to 1K Svrs
CIMC-SUP-BASE-K9	IMC Supervisor One-time Site Installation License
CIMC-SUP-TERM	Acceptance of Cisco IMC Supervisor License Terms
<b>VMware 5</b>	
VMW-VS5-STD-1A	VMware vSphere 5 Standard for 1 Processor, 1 Year, Support Rqd
VMW-VS5-STD-2A	VMware vSphere 5 Standard for 1 Processor, 2 Year, Support Rqd
VMW-VS5-STD-3A	VMware vSphere 5 Standard for 1 Processor, 3 Year, Support Rqd
VMW-VS5-STD-4A	VMware vSphere 5 Standard for 1 Processor, 4 Year, Support Rqd
VMW-VS5-STD-5A	VMware vSphere 5 Standard for 1 Processor, 5 Year, Support Rqd
VMW-VS5-ENT-1A	VMware vSphere 5 Enterprise for 1 Processor, 1 Year Support Rqd
VMW-VS5-ENT-2A	VMware vSphere 5 Enterprise for 1 CPU, 2 Yr Support Rqd
VMW-VS5-ENT-3A	VMware vSphere 5 Enterprise for 1 CPU, 3 Yr Support Rqd
VMW-VS5-ENT-4A	VMware vSphere 5 Enterprise for 1 Processor, 4 Year Support Rqd
VMW-VS5-ENT-5A	VMware vSphere 5 Enterprise for 1 CPU, 5 Yr Support Rqd
VMW-VS5-ENTP-1A	VMware vSphere 5 Enterprise Plus for 1 Processor, 1 Year Support Rqd
VMW-VS5-ENTP-2A	VMware vSphere 5 Enterprise Plus for 1 CPU, 2 Yr Support Rqd
VMW-VS5-ENTP-3A	VMware vSphere 5 Enterprise Plus for 1 Processor, 3 Year Support Rqd
VMW-VS5-ENTP-4A	VMware vSphere 5 Enterprise Plus for 1 Processor, 4 Year Support Rqd
VMW-VC5-STD-1A	VMware vCenter 5 Server Standard, 1 yr support required
VMW-VC5-STD-2A	VMware vCenter 5 Server Standard, 2 yr support required

Table 33 OSs and Value-Added Software (for 2-CPU servers) *(continued)*

PID Description	Product ID (PID)
VMW-VC5-STD-3A	VMware vCenter 5 Server Standard, 3 yr support required
VMW-VC5-STD-4A	VMware vCenter 5 Server Standard, 4 yr support required
VMW-VC5-STD-5A	VMware vCenter 5 Server Standard, 5 yr support required

## STEP 18 SELECT OPERATING SYSTEM MEDIA KIT

Select the optional operating system media listed in [Table 34](#).

Table 34 OS Media

Product ID (PID)	PID Description
RHEL-6	RHEL 6 Recovery Media Only (Multilingual)
SLES-11	SLES 11 media only (multilingual)
MSWS-08R2-STHV-RM	Windows Svr 2008 R2 ST (1-4CPU, 5CAL), Media
MSWS-08R2-ENHV-RM	Windows Svr 2008 R2 EN (1-8CPU, 25CAL), Media
MSWS-08R2-DCHV-RM	Windows Svr 2008 R2 DC (1-8CPU, 25CAL), Media
MSWS-12-ST2S-RM	Windows Server 2012 Standard (2 CPU/2 VMs) Recovery Media
MSWS-12-DC2S-RM	Windows Server 2012 Datacenter(2 CPU/Unlimited VM) Rec Media
MSWS-12R2-ST2S-RM	Windows Server 2012 R2 Standard (2 CPU/2 VMs) Recovery Media
MSWS-12R2-DC2S-RM	Windows Server 2012 R2 Datacen(2 CPU/Unlimited VM) Rec Media

## STEP 19 SELECT SERVICE and SUPPORT LEVEL

A variety of service options are available, as described in this section.

### Unified Computing Warranty, No Contract

If you have noncritical implementations and choose to have no service contract, the following coverage is supplied:

- Three-year parts coverage.
- Next business day (NBD) onsite parts replacement eight hours a day, five days a week.
- 90-day software warranty on media.
- Ongoing downloads of BIOS, drivers, and firmware updates.
- UCSM updates for systems with Unified Computing System Manager. These updates include minor enhancements and bug fixes that are designed to maintain the compliance of UCSM with published specifications, release notes, and industry standards.

### SMARTnet for UCS

For support of the entire Unified Computing System, Cisco offers the Cisco SMARTnet for UCS Service. This service provides expert software and hardware support to help sustain performance and high availability of the unified computing environment. Access to Cisco Technical Assistance Center (TAC) is provided around the clock, from anywhere in the world.

For UCS blade servers, there is Smart Call Home, which provides proactive, embedded diagnostics and real-time alerts. For systems that include Unified Computing System Manager, the support service includes downloads of UCSM upgrades. The Cisco SMARTnet for UCS Service includes flexible hardware replacement options, including replacement in as little as two hours. There is also access to Cisco's extensive online technical resources to help maintain optimal efficiency and uptime of the unified computing environment. You can choose a desired service listed in [Table 35](#).

Table 35 Cisco SMARTnet for UCS Service

Product ID (PID)	On Site?	Description
CON-PREM-C240M4SF	Yes	ONSITE 24X7X2 UCS C240 M4 Server - SFF
CON-OSP-C240M4SF	Yes	ONSITE 24X7X4 UCS C240 M4 Server - SFF
CON-OSE-C240M4SF	Yes	ONSITE 8X5X4 UCS C240 M4 Server - SFF
CON-OS-C240M4SF	Yes	ONSITE 8X5XNBD UCS C240 M4 Server - SFF
CON-S2P-C240M4SF	No	SMARTNET 24X7X2 UCS C240 M4 Server - SFF
CON-SNTP-C240M4SF	No	SMARTNET 24X7X4 UCS C240 M4 Server - SFF
CON-SNTE-C240M4SF	No	SMARTNET 8X5X4 UCS C240 M4 Server - SFF
CON-SNT-C240M4SF	No	SMARTNET 8X5XNBD UCS C240 M4 Server - SFF

### SMARTnet for UCS Hardware Only Service

For faster parts replacement than is provided with the standard Cisco Unified Computing System warranty, Cisco offers the Cisco SMARTnet for UCS Hardware Only Service. You can choose from two levels of advanced onsite parts replacement coverage in as little as four hours. SMARTnet for UCS Hardware Only Service provides remote access any time to Cisco support professionals who can determine if a return materials authorization (RMA) is required. You can choose a service listed in [Table 36](#).

Table 36 SMARTnet for UCS Hardware Only Service

Product ID (PID)	Service Level GSP	On Site?	Description
CON-UCW7-C240M4SF	UCW7	Yes	UC PLUS 24X7X40S UCS C240 M4 Server - SFF
CON-UCW5-C240M4SF	UCW5	Yes	UC PLUS 8X5XNBDOS UCS C240 M4 Server - SFF

### Unified Computing Partner Support Service

Cisco Partner Support Service (PSS) is a Cisco Collaborative Services service offering that is designed for partners to deliver their own branded support and managed services to enterprise customers. Cisco PSS provides partners with access to Cisco's support infrastructure and assets to help them:

- Expand their service portfolios to support the most complex network environments
- Lower delivery costs
- Deliver services that increase customer loyalty

Partner Unified Computing Support Options enable eligible Cisco partners to develop and consistently deliver high-value technical support that capitalizes on Cisco intellectual assets. This helps partners to realize higher margins and expand their practice.

PSS is available to all Cisco PSS partners, but requires additional specializations and requirements. For additional information, see the following URL:

[www.cisco.com/go/partnerucssupport](http://www.cisco.com/go/partnerucssupport)

The two Partner Unified Computing Support Options include:

- Partner Support Service for UCS
- Partner Support Service for UCS Hardware Only

Partner Support Service for UCS provides hardware and software support, including triage support for third party software, backed by Cisco technical resources and level three support.

See [Table 37](#).

Table 37 Partner Support Service for UCS

Product ID (PID)	Service Level GSP	On Site?	Description
CON-PSJ1-C240M4SF	PSJ1	No	UCS SUPP PSS 8X5XNBD UCS C240 M4 Server - SFF
CON-PSJ2-C240M4SF	PSJ2	No	UCS SUPP PSS 8X5X4 UCS C240 M4 Server - SFF
CON-PSJ3-C240M4SF	PSJ3	No	UCS SUPP PSS 24X7X4 UCS C240 M4 Server - SFF
CON-PSJ4-C240M4SF	PSJ4	No	UCS SUPP PSS 24X7X2 UCS C240 M4 Server - SFF

Partner Support Service for UCS Hardware Only provides customers with replacement parts in as little as two hours. See [Table 38](#).

Table 38 Partner Support Service for UCS (Hardware Only)

Product ID (PID)	Service Level GSP	On Site?	Description
CON-PSW2-C240M4SF	PSW2	No	UCS W PL PSS 8X5X4 UCS C240 M4 Server - SFF
CON-PSW3-C240M4SF	PSW3	No	UCS W PL PSS 24X7X4 UCS C240 M4 Server - SFF
CON-PSW4-C240M4SF	PSW4	No	UCS W PL PSS 24X7X2 UCS C240 M4 Server - SFF

### Unified Computing Combined Support Service

Combined Services makes it easier to purchase and manage required services under one contract. SMARTnet services for UCS help increase the availability of your vital data center infrastructure and realize the most value from your unified computing investment. The more benefits you realize from the Cisco Unified Computing System (Cisco UCS), the more important the technology becomes to your business. These services allow you to:

- Optimize the uptime, performance, and efficiency of your UCS
- Protect your vital business applications by rapidly identifying and addressing issues
- Strengthen in-house expertise through knowledge transfer and mentoring
- Improve operational efficiency by allowing UCS experts to augment your internal staff resources
- Enhance business agility by diagnosing potential issues before they affect your operations

You can choose a service listed in [Table 39](#).

Table 39 UCS Computing Combined Support Service

Product ID (PID)	Service Level GSP	On Site?	Description
CON-NCF2-C240M4SF	NCF2	No	CMB SPT SVC 24X7X2 UCS C240 M4 Server - SFF
CON-NCF2P-C240M4SF	NCF2P	Yes	CMB SPT SVC 24X7X2OS UCS C240 M4 Server - SFF
CON-NCF4P-C240M4SF	NCF4P	Yes	CMB SPT SVC 24X7X4OS UCS C240 M4 Server - SFF
CON-NCF4S-C240M4SF	NCF4S	Yes	CMB SPT SVC 8X5X4OS UCS C240 M4 Server - SFF
CON-NCFCS-C240M4SF	NCFCS	Yes	CMB SPT SVC 8X5XNBDOS UCS C240 M4 Server - SFF
CON-NCFE-C240M4SF	NCFE	No	CMB SPT SVC 8X5X4 UCS C240 M4 Server - SFF
CON-NCFP-C240M4SF	NCFP	No	CMB SPT SVC 24X7X4 UCS C240 M4 Server - SFF
CON-NCFT-C240M4SF	NCFT	No	CMB SPT SVC 8X5XNBD UCS C240 M4 Server - SFF

**Unified Computing Drive Retention Service**

With the Cisco Unified Computing Drive Retention (UCDR) Service, you can obtain a new disk drive in exchange for a faulty drive without returning the faulty drive. In exchange for a Cisco replacement drive, you provide a signed Certificate of Destruction (CoD) confirming that the drive has been removed from the system listed, is no longer in service, and has been destroyed.

Sophisticated data recovery techniques have made classified, proprietary, and confidential information vulnerable, even on malfunctioning disk drives. The UCDR service enables you to retain your drives and ensures that the sensitive data on those drives is not compromised, which reduces the risk of any potential liabilities. This service also enables you to comply with regulatory, local, and federal requirements.

If your company has a need to control confidential, classified, sensitive, or proprietary data, you might want to consider one of the Drive Retention Services listed in [Table 40 on page 73](#).



**NOTE:** Cisco does not offer a certified drive destruction service as part of this service.



Table 40 Drive Retention Service Options

Service Description	Service Program Name	Service Level GSP	Service Level	Product ID (PID)
SMARTnet for UCS Service with Drive Retention	UCS DR	UCSD7	24x7x4 Onsite	CON-UCSD7-C240M4SF
		UCSD5	8x5xNBD Onsite	CON-UCSD5-C240M4SF
SMARTnet for UCS HW ONLY+Drive Retention	UCS HW+DR	UCWD7	24x7x4 Onsite	CON-UCWD7-C240M4SF
		UCWD5	8x5xNBD Onsite	CON-UCWD5-C240M4SF

For more service and support information, see the following URL:

[http://www.cisco.com/en/US/services/ps2961/ps10312/Unified\\_Computing\\_Services\\_Overview.pdf](http://www.cisco.com/en/US/services/ps2961/ps10312/Unified_Computing_Services_Overview.pdf)

For a complete listing of available services for Cisco Unified Computing System, see this URL:

[http://www.cisco.com/en/US/products/ps10312/serv\\_group\\_home.html](http://www.cisco.com/en/US/products/ps10312/serv_group_home.html)

## OPTIONAL STEP - ORDER RACK(S)

The optional R42610 rack is available from Cisco for the C-Series servers, including the C240 M4 SFF server. This rack is a standard 19-inch rack and can be ordered with a variety of options, as listed in [Table 41](#). Racks are shipped separately from the C240 M4 SFF server.

Table 41 Racks and Rack Options

Product ID (PID)	PID Description
RACK-UCS <sup>1</sup>	Cisco R42610 expansion rack, no side panels
RACK-UCS2 <sup>1</sup>	Cisco R42610 standard rack, w/side panels
RACK-BLANK-001	Filler panels (qty 12), 1U, plastic, toolless
RACK-CBLMGT-001	Cable mgt D rings (qty 10), metal
RACK-CBLMGT-011	Cable mgt straps (qty 10), Velcro
RACK-FASTEN-001	Mounting screws (qty 100), M6
RACK-FASTEN-002	Cage nuts (qty 50), M6
RACK-JOIN-001	Rack joining kit

Notes . . .

1. Use these same base PIDs to order spare racks (available only as next-day replacements).

For more information about the R42610 rack, see [RACKS, page 96](#).

## OPTIONAL STEP - ORDER PDU

An optional power distribution unit (PDU) is available from Cisco for the C-Series rack servers, including the C240 M4 server. This PDU is available in a zero rack unit (RU) style (see [Table 42](#)).

Table 42 PDU Options

Product ID (PID)	PID Description
RP208-30-2P-U-2	Zero RU PDU

For more information about the PDU, see [PDUs, page 98](#).

# SUPPLEMENTAL MATERIAL

## CHASSIS

An internal view of the C240 M4 chassis with the top cover removed is shown in *Figure 9*.

Figure 9 C240 M4 SFF With Top Cover Off

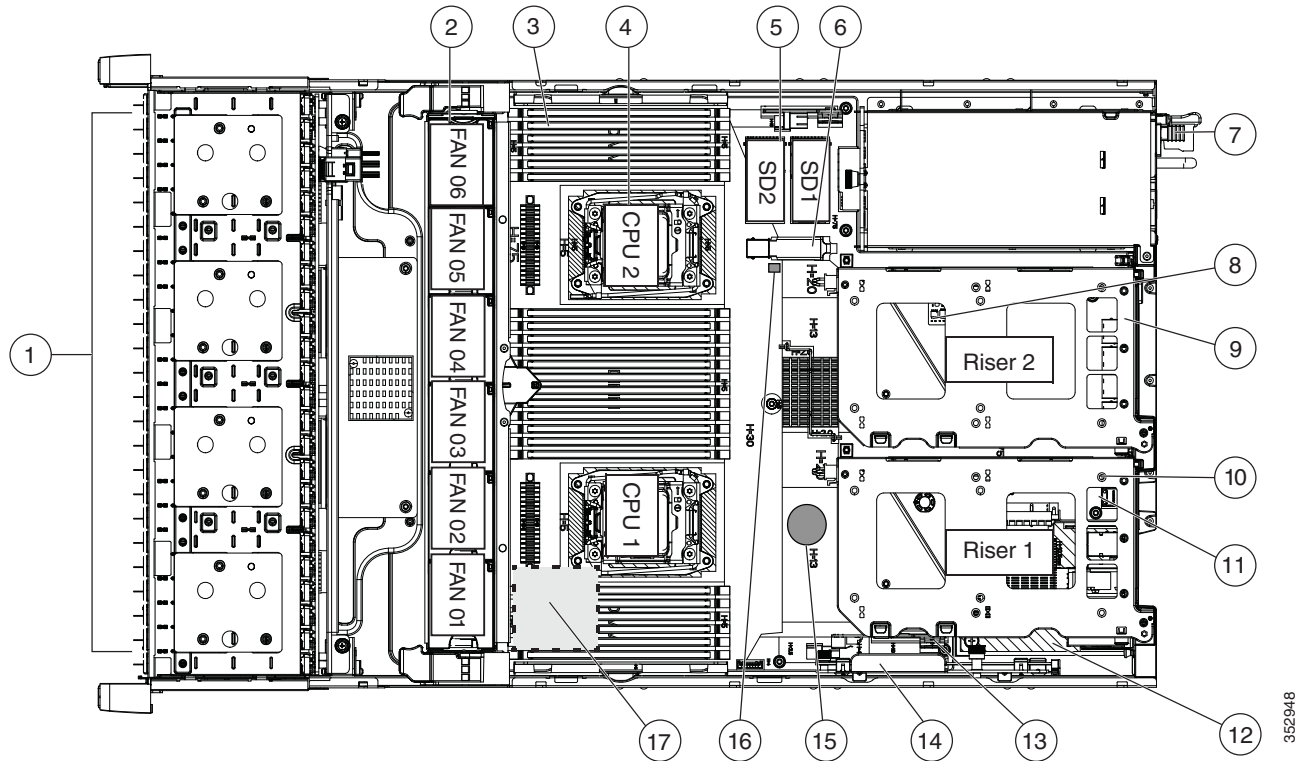

352948

1	Drives (hot-swappable, accessed through front panel)	10	PCIe riser 1 (PCIe slots 1, 2, 3*) *Slot 3 not present in all versions. See <a href="#">Riser Card Configuration and Options, page 87</a> for riser options and slot specifications.
2	Fan modules (six, hot-swappable)	11	SATA boot drives (two sockets available only on PCIe riser 1 option C)
3	DIMM sockets on motherboard (up to 24 DIMMs)	12	mLOM card socket on motherboard under PCIe riser 1
4	CPUs and heatsinks (two)	13	Socket for embedded RAID interposer board
5	Cisco SD card slots on motherboard (two)	14	Cisco modular RAID controller PCIe slot (dedicated slot and bracket)

6	USB 3.0 slot on motherboard	15	RTC battery on motherboard
7	Power supplies (hot-swappable, accessed through rear panel)	16	Embedded RAID header for RAID key
8	Trusted platform module (TPM) socket on motherboard, under PCIe riser 2	17	SuperCap power module (RAID backup) mounting location on air baffle (not shown)
9	PCIe riser 2 (PCIe slots 4, 5, 6)		

# Block Diagram

A simplified block diagram of the C240 M4 server is shown in *Figure 10*.

Figure 10 C240 M4 SFF Block Diagram (simplified)

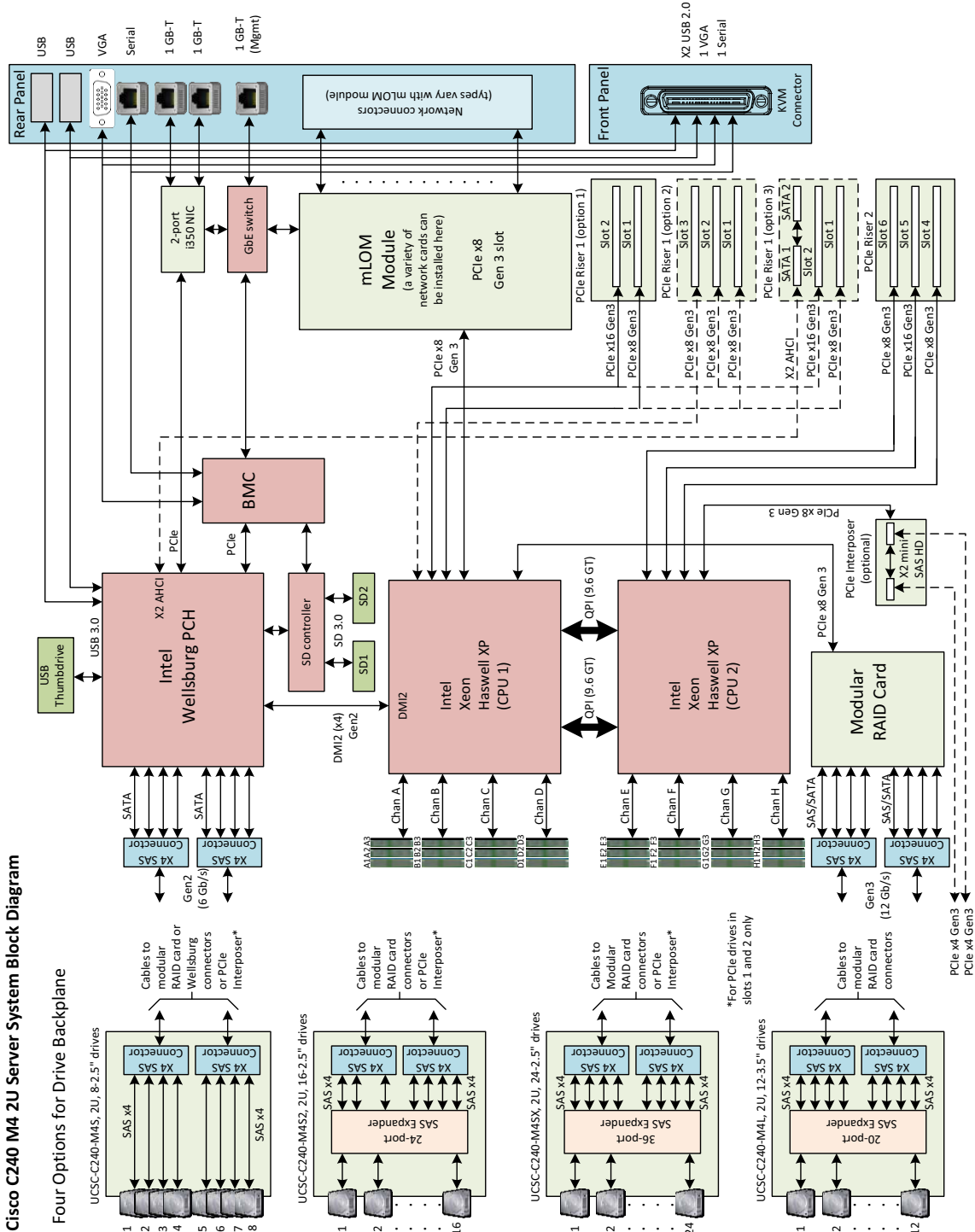

## CPUs and DIMMs

### Physical Layout

Each CPU has four DIMM channels:

- CPU1 has channels A, B, C, and D
- CPU2 has channels E, F, G, and H

Each DIMM channel has three slots: slot 1, slot 2, and slot 3. The blue-colored DIMM slots are for slot 1, the black-colored slots for slot 2, and the white slots for slot 3.

As an example, DIMM slots A1, B1, C1, and D1 belong to slot 1, while A2, B2, C2, and D2 belong to slot 2.

*Figure 11* shows how slots and channels are physically laid out on the motherboard. The DIMM slots on the right half of the motherboard (channels A, B, C, and D) are associated with CPU 1, while the DIMM slots on the left half of the motherboard (channels E, F, G, and H) are associated with CPU 2. The slot 1 (blue) DIMM slots are always located farther away from a CPU than the corresponding slot 2 (black) and slot 3 (white) slots. Slot 1 slots (blue) are populated before slot 2 slots (black) and slot 3 (white) slots.

Figure 11 Physical Layout of CPU DIMM Channels and Slots

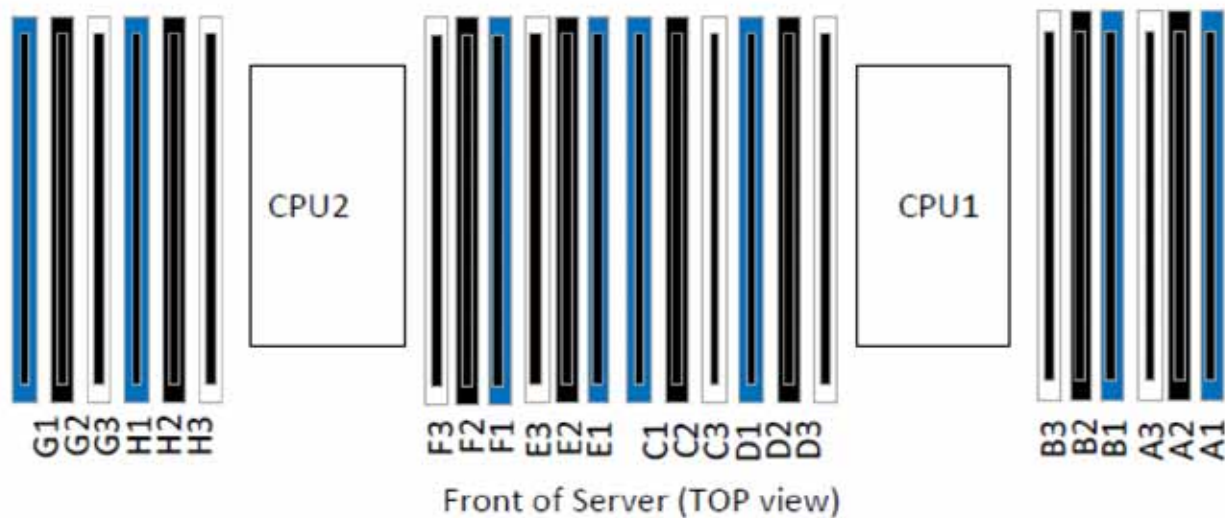

## Memory Population Rules

When considering the memory configuration of your server, consider the following items:

- Each channel has three DIMM slots (for example, channel A = slots A1, A2, and A3).
  - A channel can operate with one, two, or three DIMMs installed.
  - If a channel has only one DIMM, populate slot 1 first (the blue slot).
- When both CPUs are installed, populate the DIMM slots of each CPU identically.
  - Fill blue slots in the channels first: A1, E1, B1, F1, C1, G1, D1, H1
  - Fill black slots in the channels second: A2, E2, B2, F2, C2, G2, D2, H2
  - Fill white slots in the channels third: A3, E3, B3, F3, C3, G3, D3, H3
- Any DIMM installed in a DIMM socket for which the CPU is absent is not recognized.
- Observe the DIMM mixing rules shown in [Table 43](#)

Table 43 DIMM Rules for C240 M4 Servers

DIMM Parameter	DIMMs in the Same Channel	DIMM in the Same Slot <sup>1</sup>
<u>DIMM Capacity</u>		
RDIMM = 8, 16, or 32 GB LRDIMM = 32 or 64 GB TSV-RDIMM = 64 GB	DIMMs in the same channel (for example, A1, A2, and A3) can have different capacities.	For best performance, DIMMs in the same slot (for example, A1, B1, C1, D1) should have the same capacity.
	Do not mix TSV-RDIMMS with LRDIMMs nor RDIMMs	Do not mix TSV-RDIMMS with LRDIMMs nor RDIMMs
<u>DIMM Speed</u>		
2400-MHz 2133-MHz	DIMMs will run at the lowest speed of the CPU installed	DIMMs will run at the lowest speed of the CPU installed
<u>DIMM Type</u>		
TSV-RDIMMS, RDIMMs, or LRDIMMs	Do not mix DIMM types in a channel	Do not mix DIMM types in a slot
<b>DIMMs per Channel (DPC)</b>		
	1 DPC, 2 DPC, or 3 DPC	
	See <a href="#">Table 7 on page 24</a> for valid LRDIMM and RDIMM 1 DPC, 2 DPC, and 3 DPC memory configurations	

Notes . . .

1. Although different DIMM capacities can exist in the same slot, this will result in less than optimal performance. For optimal performance, all DIMMs in the same slot should be identical.



## DIMM Population Order

Populate the DIMMs for a CPU according to [Table 44](#).

Table 44 DIMM Population Order per CPU

DIMMs per CPU	Populate CPU 1 Slots	Populate CPU 2 Slots
1	A1	E1
2	A1, B1	E1, F1
3	A1, B1, C1	E1, F1, G1
4	A1, B1, C1, D1	E1, F1, G1, H1
8	A1, B1, C1, D1, A2, B2, C2, D2	E1, F1, G1, H1, E2, F2, G2, H2
12	A1, B1, C1, D1, A2, B2, C2, D2 A3, B3, C3, D3	E1, F1, G1, H1, E2, F2, G2, H2 E3, F3, G3, H3

## Recommended Memory Configuration

This section explains the recommended DIMM population order rules for the C240 M4 server.

- All DIMMs must be DDR4 DIMMs.
- Do not mix:
  - DIMMs with different clock rates in a channel
  - RDIMMs and LRDIMMs
- There are blue, black, and white DIMM slots. Populate blue slots first.
- When DIMMs ranks are mixed in the same channel, always populate the highest rank DIMM in the blue DIMM slot and lower rank DIMM(s) in the black and white DIMM slots.

Many memory configurations are possible. For best results, follow [Table 45](#) when populating 2133-MHz DIMMs for Intel Xeon E5-2600 v3 CPUs and [Table 46](#) when populating 2400-MHz DIMMs for Intel Xeon E5-2600 v4 CPUs.



**NOTE:** These tables list only some recommended and suggested configurations. There are numerous other possible configurations supported by Cisco. Cisco supports all mixing and population configurations of the Cisco DIMMs as long as the mixing does not violate the few fundamental rules noted in this document.

Table 45 Recommended Memory Configurations for Intel Xeon E5-2600 v3 CPUs (with 2133-MHz DIMMs)<sup>1</sup>

Total System Memory Size	CPU 1 DIMMs			CPU 2 DIMMs			DIMM Max Speed (MHz)	Total DIMMs
	Blue Slots Slot 1 (A1,B1, C1,D1)	Black Slots Slot 2 (A2,B2, C2,D2)	White Slots Slot 3 (A3,B3, C3,D3)	Blue Slots Slot 1 (E1,F1, G1,H1)	Black Slots Slot 2 (E2,F2, G2,H2)	White Slots Slot 3 (E3,F3, G3,H3)		
64 GB	4x8 GB	–	–	4x8 GB	–	–	2133	8
128 GB	4x8 GB	4x8 GB	–	4x8 GB	4x8 GB	–	2133	16
	4x16 GB	–	–	4x16 GB	–	–	2133	8
192 GB	4x8 GB	4x8 GB	4x8 GB	4x8 GB	4x8 GB	4x8 GB	1600	24
	4x16 GB	4x8 GB	–	4x16 GB	4x8 GB	–	2133	16
256 GB	4x16 GB	4x16 GB	–	4x16 GB	4x16 GB	–	2133	16
	4x32 GB	–	–	4x32 GB	–	–	2133	8
384 GB	4x16 GB	4x16 GB	4x16 GB	4x16 GB	4x16 GB	4x16 GB	1866	24
512 GB	4x32 GB	4x32 GB	–	4x32 GB	4x32 GB	–	2133	16
	4x64 GB	–	–	4x64 GB	–	–	2133	8
768 GB	4x32 GB	4x32 GB	4x32 GB	4x32 GB	4x32 GB	4x32 GB	1866	24
1024 GB	4x64 GB	4x64 GB	–	4x64 GB	4x64 GB	–	2133	16
1536 GB	4x64 GB	4x64 GB	4x64 GB	4x64 GB	4x64 GB	4x64 GB	1600	24

Notes . . .

1. Rows marked in yellow indicate best performance.

Table 46 Recommended Memory Configurations for Intel Xeon E5-2600 v4 CPUs (with 2400-MHz DIMMs)<sup>1</sup>

Total System Memory Size	CPU 1 DIMMs			CPU 2 DIMMs			DIMM Max Speed (MHz)	Total DIMMs
	Blue Slots Slot 1 (A1,B1, C1,D1)	Black Slots Slot 2 (A2,B2, C2,D2)	White Slots Slot 3 (A3,B3, C3,D3)	Blue Slots Slot 1 (E1,F1, G1,H1)	Black Slots Slot 2 (E2,F2, G2,H2)	White Slots Slot 3 (E3,F3, G3,H3)		
128 GB	4x16 GB	—	—	4x16 GB	—	—	2400	8
192 GB	4x16 GB	4x8 GB	—	4x16 GB	4x8 GB	—	2400	16
256 GB	4x16 GB	4x16 GB	—	4x16 GB	4x16 GB	—	2400	16
	4x32 GB	—	—	4x32 GB	—	—	2400	8
384 GB	4x16 GB	4x16 GB	4x16 GB	4x16 GB	4x16 GB	4x16 GB	2133	24
	4x32GB	4x16GB	—	4x32GB	4x16GB	—	2400	16
512 GB	4x32 GB	4x32 GB	—	4x32 GB	4x32 GB	—	2400	16
	4x64 GB	—	—	4x64 GB	—	—	2400	8
768 GB	4x32 GB	4x32 GB	4x32 GB	4x32 GB	4x32 GB	4x32 GB	2133	24
1024 GB	4x64 GB	4x64 GB	—	4x64 GB	4x64 GB	—	2400	16
1536 GB	4x64 GB	4x64 GB	4x64 GB	4x64 GB	4x64 GB	4x64 GB	2133	24

Notes . . .

1. Rows marked in yellow indicate best performance.

## Additional DIMM Populations

The list in [Table 47](#) is not a complete list of all supported DIMM populations, but highlights common configuration options.

Table 47 Supported DIMM Configurations

CPU 1 DIMMs	Total DIMMs for CPU 1	CPU 1 Capacity	CPU 2 DIMMs	Total DIMMs for CPU 2	CPU 2 Capacity	Total Capacity for 2 CPUs
1 x 8 GB	1	8 GB	1 x 8 GB	1	8 GB	16 GB
2 x 8 GB	2	16 GB	2 x 8 GB	2	16 GB	32 GB
1 x 16 GB	1	16 GB	1 x 16 GB	1	16 GB	32 GB
4 x 8 GB	4	32 GB	4 x 8 GB	4	32 GB	64 GB
2 x 16 GB	2	32 GB	2 x 16 GB	2	32 GB	64 GB
1 x 32 GB	1	32 GB	1 x 32 GB	1	32 GB	64 GB
8 x 8 GB	8	64 GB	8 x 8 GB	8	64 GB	128 GB
4 x 16 GB	4	64 GB	4 x 16 GB	4	64 GB	128 GB
2 x 32 GB	2	64 GB	2 x 32 GB	2	64 GB	128 GB
12 x 8 GB	12	96 GB	12 x 8 GB	12	96 GB	192 GB
8 x 16 GB	8	128 GB	8 x 16 GB	8	128 GB	256 GB
4 x 32 GB	4	128 GB	4 x 32 GB	4	128 GB	256 GB
12 x 16 GB	12	192 GB	12 x 16 GB	12	192 GB	384 GB
8 x 32 GB	8	256 GB	8 x 32 GB	8	256 GB	512 GB
12 x 32 GB	12	384 GB	12 x 32 GB	12	384 GB	768 GB
12 x 64 GB	12	768 GB	12 x 64 GB	12	768 GB	1536 GB

## RAID Details

The available disk drive support configurations are shown in this section.



NOTE: You can select a Cisco 12G Modular RAID controller or a Cisco 12 Gbps Modular SAS HBA, but not both at the same time.

By default, the server comes with embedded software RAID.

To upgrade from the default, select one of these:

### Cisco 12G SAS Modular RAID Controller (RAID Support)

- For a 24-drive or 16-drive backplane system, select one of the following:
  - Cisco 12G SAS Modular RAID controller from *Table 10 on page 31*, or
  - Cisco 9300-8E 12G SAS HBA from *Table 10 on page 31*, or
  - One Cisco 12G SAS Modular RAID controller and one or two Cisco 9300-8E 12G SAS HBAs from *Table 10 on page 31*.

Select an appropriate optional RAID configuration listed in *Table 10 on page 31*.

- For an 8-drive backplane system, select one of the following:
  - Embedded software RAID 5 key upgrade option from *Table 10 on page 31*, or
  - Cisco 12G SAS Modular RAID controller from *Table 10 on page 31*, or
  - Cisco 9300-8E 12G SAS HBA from *Table 10 on page 31*
  - One Cisco 12G SAS Modular RAID controller from *Table 10 on page 31* and one or two Cisco 9300-8E 12G SAS HBAs from *Table 10 on page 31*

Select an appropriate optional RAID configuration listed in *Table 10 on page 31*.

### Cisco 12 Gbps SAS HBA (JBOD Only Support)

- Select one of the following:
  - Cisco 12 Gbps Modular SAS HBA from *Table 10 on page 31*, and/or
  - One or two Cisco 9300-8E 12G SAS HBAs from *Table 10 on page 31*, or

## RAID Option ROM (OPROM) Settings

The server contains an Option ROM (OPROM) for the PCIe slots. The server has a finite amount of option ROM with which it can boot up devices. Go into the BIOS and disable the OPROM on the PCIe slots not used for booting so that resources are available for the slots that are used for booting. An example OPROM BIOS screen is shown in *Figure 12*.

Figure 12 Example BIOS Screen for OPROM

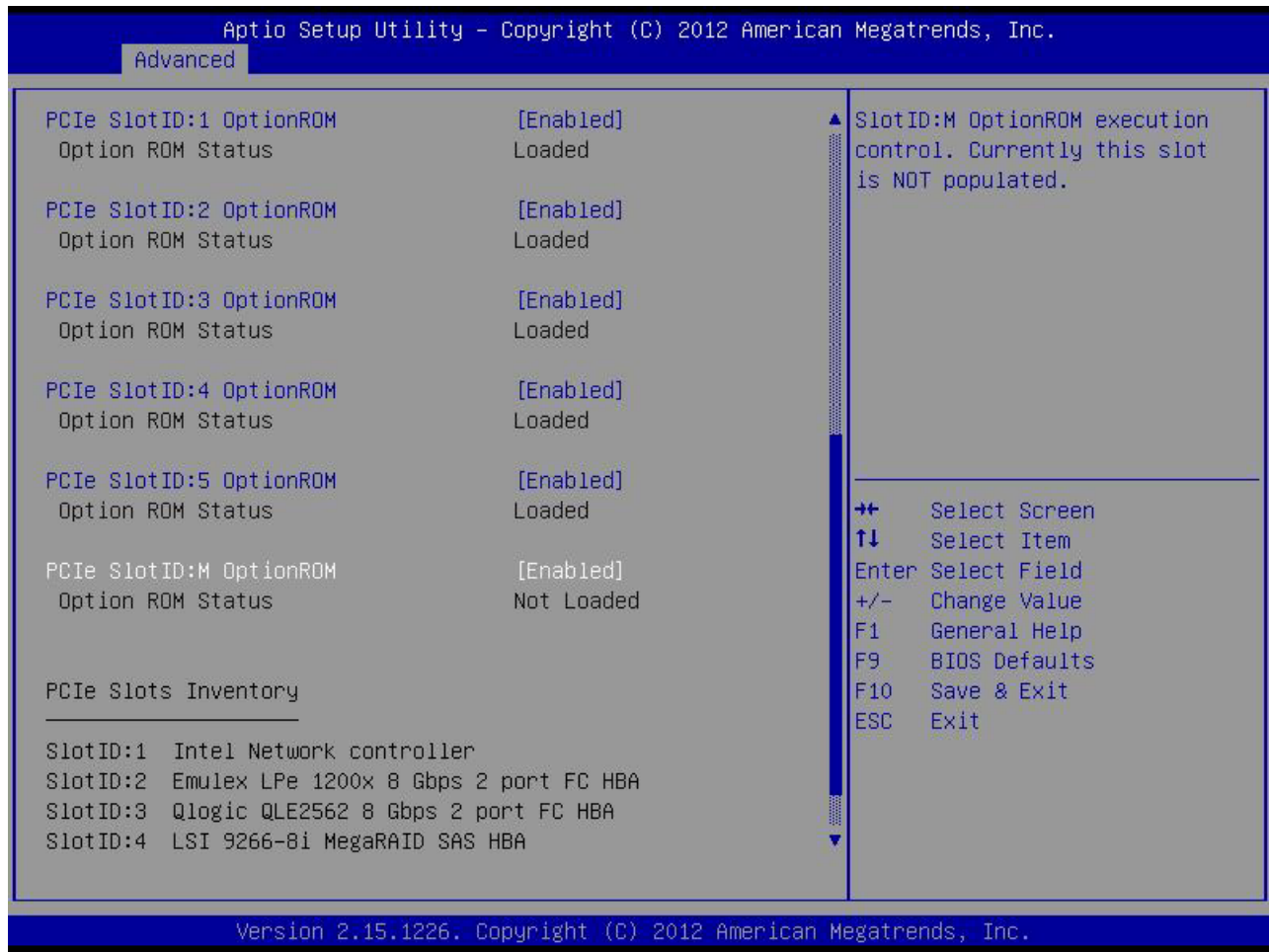

## Riser Card Configuration and Options

The three riser card 1 options are shown in [Table 48](#). The number of PCIe card slots and connectors for SATA boot drives depends on which option is selected for riser 1. The riser card 2 slot assignments are fixed and are shown in [Table 49 on page 88](#).

Table 48 Riser Card 1 Slot Options

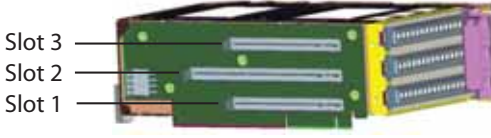
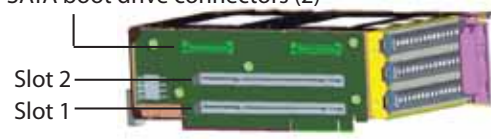
Slot #	Height	Length	Electrical	Mechanical	NCSI	Physical
Riser Card 1 (option A, PID UCSC-PCI-1A-240M4)						
						
3	No slot available					
2	Full	Full <sup>1</sup>	x16	x24	Yes <sup>2</sup>	
1	Full	3/4	x8	x24	Yes <sup>2</sup>	
Riser Card 1 (option B, PID UCSC-PCI-1B-240M4) <sup>3</sup>						
						
3	Full	Full	x8	x16	No	
2	Full	Full	x8	x24	Yes	
1	Full	3/4	x8	x16	No	
Riser Card 1 (option C, PID UCSC-PCI-1C-240M4)						
						
3	No slot available <sup>4</sup>					
2	Full	Full	x16	x24	Yes <sup>2</sup>	
1	Full	3/4	x8	x24	Yes	

Notes . . .

1. GPU capable slot
2. NCSI supported in only one slot at a time (default slot 2). If a GPU card is present in slot 2, NCSI support automatically moves to slot 1.
3. No GPUs are supported on this riser. There is no GPU power connector in this version. Use riser version 1A for GPU cards.
4. There is no PCIe connector in slot 3; instead, there are two connectors available for connecting SATA boot drives.

Table 49 Riser Card 2 Slots

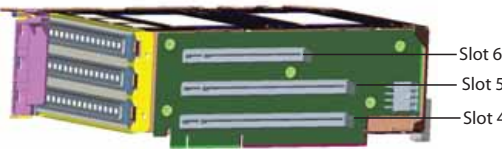
Slot #	Height	Length	Electrical	Mechanical	NCSI	Physical
Riser Card 2						
						
6	Full	Full	x8	x16	No	
5	Full	Full <sup>1</sup>	x16	x24	Yes <sup>2</sup>	
4	Full	3/4	x8	x24	Yes <sup>2</sup>	

Notes . . .

1. GPU capable slot
2. NCSI supported in only one slot at a time (default slot 5). If a GPU card is present in slot 5, NCSI support automatically moves to slot 4.



## Embedded SATA RAID: Two SATA Controllers

The embedded SATA RAID controller hub is split into two controllers, SATA and sSATA (secondary SATA). These two controllers are seen as separate RAID controllers in the Cisco IMC interface and are configurable separately.

- The first SATA controller controls drives 1-4; the secondary sSATA controller controls drives 5-8.
- When configuring RAID groups, you cannot create a group that spans more than four drives.
  - The first SATA controller can control a RAID group of up to four drives, consisting only of drives 1-4.
  - The secondary sSATA controller can control a RAID group of up to four drives, consisting only of drives 5-8. See [Figure 13](#).

Figure 13 Embedded RAID Controller RAID Groups

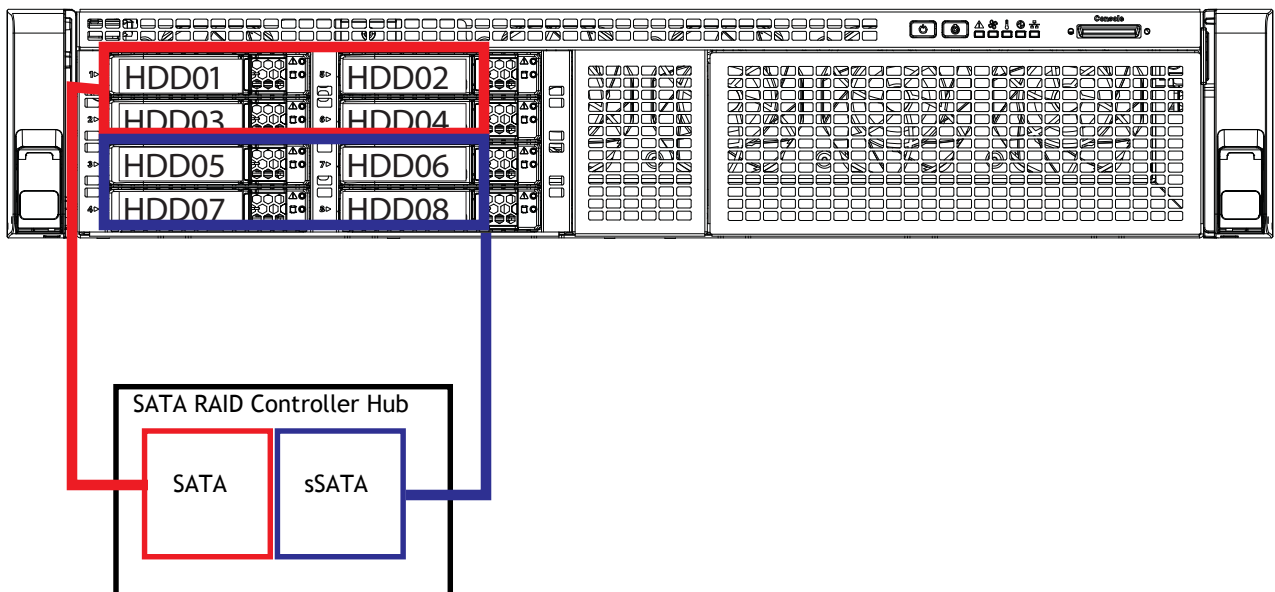

- Each controller is listed separately in the BIOS. You can select the boot order of the controllers in the BIOS (use the Boot Options tab in the BIOS Setup Utility).

Note the following considerations:

- The default setting for this embedded controller hub is SATA RAID 0, 1, and 10 support for up to eight SATA drives (in two groups of four drives).
- You can upgrade this to support to SATA RAID 0, 1, 10, and 5 support for up to eight SATA drives (in two groups of four drives) by installing a RAID 5 key module on the motherboard.
- When you order the server with this embedded controller, the controller is enabled in the BIOS.
- You cannot downgrade from using a HW RAID controller card to using the SW RAID embedded controller.

To Create a RAID Group

(1) While the server is booting, wait for the prompt and press function key F2 as shown in *Figure 14*.

Figure 14 Function Key F2 Prompt



In a few seconds, you will see the screen that allows you to set up a RAID group for the primary SATA controller (see *Figure 15*).

Figure 15 Screen to Configure Primary SATA RAID Group

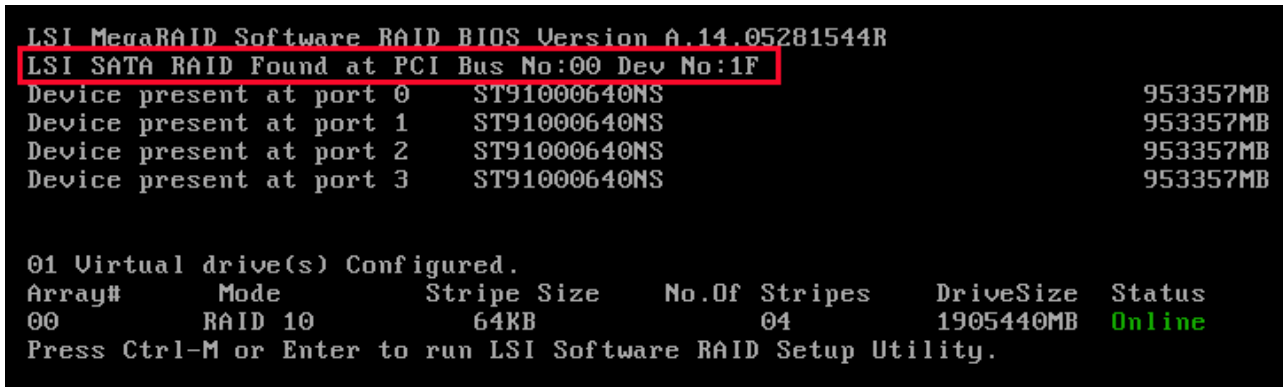

(2) Press Ctrl+M to start the RAID group creation process for the primary SATA controller (for drives 1-4, as shown in [Figure 13 on page 89](#)). Or, do nothing and wait for the next screen, which allows you to create a RAID group for the secondary SATA (sSATA) controller see [Figure 16](#)).

Figure 16 Screen to Configure Secondary SATA (sSATA) RAID Group

```

Device present at port 3      ST91000640NS      953357MB

01 Virtual drive(s) Configured.
Array#      Mode      Stripe Size      No.Of Stripes      DriveSize      Status
00          RAID 10      64KB             04                 1905440MB     Online
Press Ctrl-M or Enter to run LSI Software RAID Setup Utility.

LSI MegaRAID Software RAID BIOS Version A.14.05281544R
LSI sSATA RAID Found at PCI Bus No:00 Dev No:11
Device present at port 0      INTEL SSDSC2BA200G3      190270MB
Device present at port 1      INTEL SSDSC2BA200G3      190270MB
Device present at port 2      INTEL SSDSC2BB120G4      113961MB
Device present at port 3      Micron_P400e-MTFDDAK100MAR      94884MB

04 Virtual drive(s) Configured.
Array#      Mode      Stripe Size      No.Of Stripes      DriveSize      Status
00          RAID 0      64KB             01                 189781MB     Online
01          RAID 0      64KB             01                 189781MB     Online
02          RAID 0      64KB             01                 113487MB     Online
03          RAID 0      64KB             01                 94413MB      Online
Press Ctrl-M or Enter to run LSI Software RAID Setup Utility.

```

(3) Press Ctrl+M to start the RAID group creation process for the secondary SATA (sSATA) controller (for drives 5-8, as shown in [Figure 13 on page 89](#)).

## Serial Port Details

The pinout details of the rear RJ-45 serial port connector are shown in *Figure 17*.

Figure 17 Serial Port (Female RJ-45 Connector) Pinout

### Serial Port (RJ-45 Female Connector)

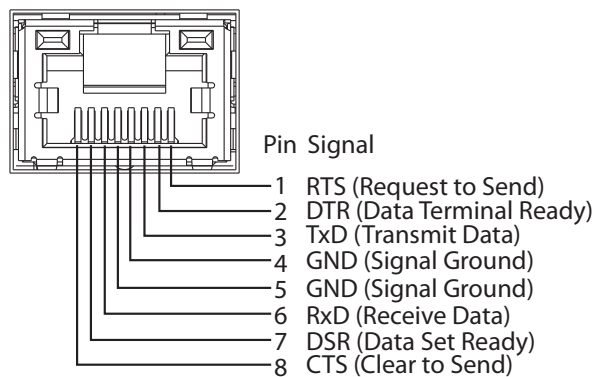

## Upgrade and Servicing-Related Parts

This section lists the upgrade and servicing-related parts you may need during the life of your server. Some of these parts are configured with every server, and some may be ordered when needed or may be ordered and kept on hand as spares for future use. See [Table 50](#).

Table 50 Upgrade and Servicing-related Parts for UCS C240 M4 SFF Server

Spare Product ID (PID)	Description
UCSC-PCIF-01F=	PCIe Full Height blanking panel for UCS C-Series Server <sup>1</sup>
UCSC-PCIF-C240M4=	C240 M4 PCIe Riser Blanking Panel <sup>1</sup>
UCSC-PCI-2-C240M4=	C240 M4 PCIe Riser 2 Assembly <sup>1</sup>
UCSC-PCI-1A-240M4=	C240 M4 PCIe Riser 1 Assembly (x8 slot + GPU) <sup>1</sup>
UCSC-PCI-1B-240M4=	C240 M4 PCIe Riser 1 Assembly (3 x8 slots) <sup>1</sup>
UCSC-PCI-1C-240M4=	C240 M4 PCIe Riser 1 Assembly (SATA Boot + 2 PCIe slots) <sup>1</sup>
UCSC-IP-SSD-240M4=	PCIe interposer board + cable for PCIe SSD (8 and 16 HDD backplane versions) <sup>1</sup>
UCSC-IPSSD-240M48=	PCIe interposer board + cable for PCIe SSD (24 HD backplane version) <sup>1</sup>
UCSC-IP-PCH-240M4=	Interposer board + cables for onboard PCH SATA 6G Embedded Software RAID <sup>1</sup>
UCSC-MLOM-BLK=	MLOM Blanking Panel
UCS-240CBLMR8=	C240 M4 (2) RAID controller cables for 8 HD backplane <sup>2</sup>
UCS-240CBLMR16=	C240 M4 (2) RAID controller cables for 16 HD backplane <sup>2</sup>
UCS-240CBLMR24=	C240 M4 (2) RAID controller cables for 24 HD backplane <sup>2</sup>
UCSC-HS-C240M4=	Heat Sink for UCS C240 M4 Rack Server <sup>1</sup>
UCS-CPU-LPCVR=	CPU load plate dust cover (for unpopulated CPU sockets)
UCSC-GPUCBL-240M4=	C240 M4 GPU Power Cable (1 cable per GPU card) <sup>1</sup>
N20-MBLIBATT=	Replacement Lithium Battery for Server Motherboard (CR2032) <sup>1</sup>
UCSC-FAN-C240M4=	C240 M4 Fan Module (one)
UCSC-BAFF-C240M4=	C240 M4 Air Baffle Replacement Kit
UCSC-PSU-BLKP240=	Power Supply Blanking Panel for C240 M4 Servers <sup>1</sup>
UCSC-RAILB-M4=	Tool-Less Ball Bearing Rail Kit for C220 M4 and C240 M4 rack servers
UCSC-CMAB-M4=	Reversible CMA for C240 M4 ball bearing rail kit
UCS-SD-32G-S=	32 GB SD Card for UCS servers <sup>3</sup>
UCS-SD-64G-S=	64 GB SD Card for UCS servers <sup>2</sup>
UCS-USBFLSHB-16GB=	UCS Servers 16 GB Flash USB Drive
N20-BKVM=	KVM local IO cable for UCS servers console port
UCS-CPU-GREASE3=	M4 Server CPU thermal grease syringe - needed for heatsink seal <sup>4</sup>
UCSX-HSCK=	UCS Processor Heat Sink Cleaning Kit (when replacing a CPU) <sup>3</sup>
UCSC-MRAID-SC=	SuperCap for Cisco 12G SAS Modular RAID, including all cables.
UCSC-IP-SSD-240M4=	PCIe 8639 interposer board + cable for PCIe SSD (8&16 HD)

Table 50 Upgrade and Servicing-related Parts for UCS C240 M4 SFF Server

Spare Product ID (PID)	Description
UCSC-IPSSD-240M4B=	PCIe 8639 interposer board + cable for PCIe SSD (24 HD)
UCS-300WKIT-240M4=	300 Watt Cable and Kit for UCS C240M4 Rack Server Includes two heat sinks and two power cables)

## Notes . . .

1. This part is included/configured with your UCS server (in some cases, as determined by the configuration of your server).
2. Required if ordering the RAID controller as a spare or to replace damaged cables
3. This SD card is blank.
4. This part should be ordered with the purchase of each optional or spare Intel Xeon E5-2600 v3 CPU processor kit

## Adding an Additional CPU (with CPU heat sink) or Replacing CPUs

All Cisco UCS two CPU socket-capable servers can be upgraded from having one to having two CPUs configured or can also support replacement of the CPUs. You will need to order and install a heat sink when adding any additional CPU to a server. Instructions for installing the new CPU or replacing CPUs and heat sink can be found at the following link:

[http://www.cisco.com/c/en/us/td/docs/unified\\_computing/ucs/c/hw/C240M4/install/C240M4.html](http://www.cisco.com/c/en/us/td/docs/unified_computing/ucs/c/hw/C240M4/install/C240M4.html)



**NOTE:** Unlike previous generation servers, the C240 M4 has tool-less CPU sockets, so no separate tools (such as “pick n place” tools) are required to add or replace CPUs.

See the section titled “Replacing CPUs and Heatsinks.”

## Motherboard Lithium Battery

You can order a replacement motherboard battery. Installation instructions are found at this link:

[http://www.cisco.com/c/en/us/td/docs/unified\\_computing/ucs/c/hw/C240M4/install/C240M4.html](http://www.cisco.com/c/en/us/td/docs/unified_computing/ucs/c/hw/C240M4/install/C240M4.html)

See the section titled “Replacing the Motherboard RTC Battery.”

## Thermal Grease (with syringe applicator) for CPU to Heatsink Seal

Thermal grease must be applied to the top of the CPU where it comes in contact with the heat sink (a grease syringe also ships with each CPU spare option kit). Instructions for applying thermal grease are found at:

[http://www.cisco.com/c/en/us/td/docs/unified\\_computing/ucs/c/hw/C240M4/install/C240M4.html](http://www.cisco.com/c/en/us/td/docs/unified_computing/ucs/c/hw/C240M4/install/C240M4.html)

See the section titled “Replacing CPUs and Heatsinks.”



**CAUTION:** Use only the thermal grease specified for this server (UCS-CPU-GREASE3=). This thermal grease comes in a white-tipped syringe and is to be used only in the C220 M4 and C240 M4 servers. Other servers use thermal grease in a blue-tipped syringe (UCS-CPU-GREASE=).

Thermal grease for other systems may have different thermal conductivity properties and may cause overheating if used in the C220 M4 or C240 M4 servers.

**DO NOT** use thermal grease available for purchase at any commercial electronics store. If these instructions are not followed, the CPU may overheat and be destroyed.



**NOTE:** When you purchase a spare CPU, the thermal grease with syringe applicator is included.

---

### Air Baffle Replacement Kit

Air baffles are designed to direct airflow through the server to maintain server temperature at a safe operating level. These baffles must always remain installed during server operation. The Air Baffle Replacement Kit includes the air baffles needed for one UCS C220 M4 server.

### CPU Heat Sink Cleaning Kit

The cleaning kit is used to remove the existing thermal compound from the bottom of the heat sink during a CPU replacement process. Instructions for cleaning are found at the following link:

[http://www.cisco.com/c/en/us/td/docs/unified\\_computing/ucs/c/hw/C220M4/install/C220M4.html](http://www.cisco.com/c/en/us/td/docs/unified_computing/ucs/c/hw/C220M4/install/C220M4.html)

See the section titled “Replacing CPUs and Heatsinks.”



**NOTE:** When you purchase a spare CPU, the CPU cleaning kit is included.

## RACKS

The Cisco R42610 rack (see [Figure 18 on page 97](#)) is certified for Cisco UCS installation at customer sites and is suitable for the following equipment:

- Cisco UCS B-Series servers and fabric interconnects
- Cisco UCS C-Series and select Nexus switches

The rack is compatible with hardware designed for EIA-standard 19-inch racks. Rack specifications are listed in [Table 51](#).

Table 51 Cisco R42610 Rack Specifications

Parameter	Standard Rack	Expansion Rack
Dimensions (H x W x D)	78.74 x 24 x 43.38 in. (2000 x 610 x 1102 mm)	78.74 x 23.58 x 43.38 in. (2000 x 599 x 1102 mm)
Dimensions (H x W x D) with packaging	89 x 33 x 47 in. (2261 x 838 x 1194 mm)	89 x 33 x 47 in. (2261 x 838 x 1194 mm)
Distance from front mounting rail to rear mounting rail	29.2 in (741 mm)	29.2 in (741 mm)
Weight	299.83 lb (136 kg)	231.49 lb (105 kg)
Weight with packaging	354 lb (161 kg)	284 lb (129 kg)
Side panels included	Yes	No
Equipment mounting capacity	42RU	42RU
Static load capacity	2100 lb (954 kg)	2100 lb (954 kg)
Dynamic load capacity	Not applicable	Not applicable



NOTE: The AC input connector is an IEC 320 C-14 15 A/250 VAC power inlet.



Figure 18 Cisco R42610 Rack



Front view - door closed



Front view - door open



Front view - door removed

## PDU

Cisco RP Series Power Distribution Units (PDUs) offer power distribution with branch circuit protection.

Cisco RP Series PDU models distribute power to up to 24 outlets. The architecture organizes power distribution, simplifies cable management, and enables you to move, add, and change rack equipment without an electrician.

With a Cisco RP Series PDU in the rack, you can replace up to two dozen input power cords with just one. The fixed input cord connects to the power source from overhead or under-floor distribution. Your IT equipment is then powered by PDU outlets in the rack using short, easy-to-manage power cords.

The C-series severs accept the zero-rack-unit (ORU) PDU. See [Figure 19](#).

Figure 19 Zero Rack Unit PDU (PID = RP208-30-2P-U-2)

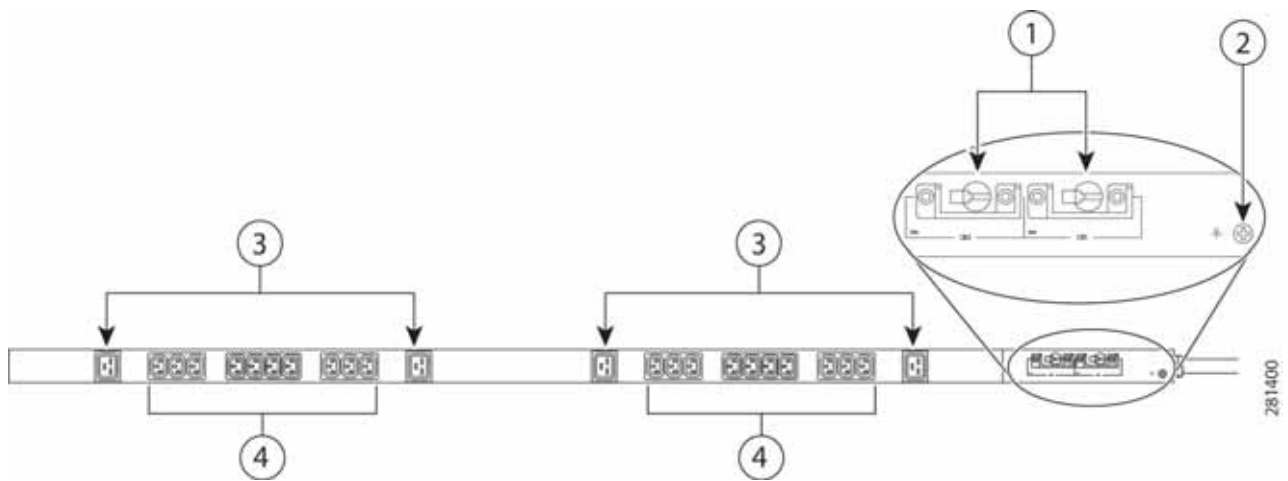

1	Breakers	3	C19 plugs
2	Ground connection	4	C13 plugs

Cisco RP Series PDU models provide two 20-ampere (A) circuit breakers for groups of receptacles. The effects of a tripped circuit are limited to a receptacle group. Simply press a button to reset that circuit.

## KVM CABLE

The KVM cable provides a connection into the server, providing a DB9 serial connector, a VGA connector for a monitor, and dual USB 2.0 ports for a keyboard and mouse. With this cable, you can create a direct connection to the operating system and the BIOS running on the server.

The KVM cable ordering information is listed in [Table 52](#).

Table 52 KVM Cable

Product ID (PID)	PID Description
N20-BKVM=	KVM cable for server console port

Figure 20 KVM Cable

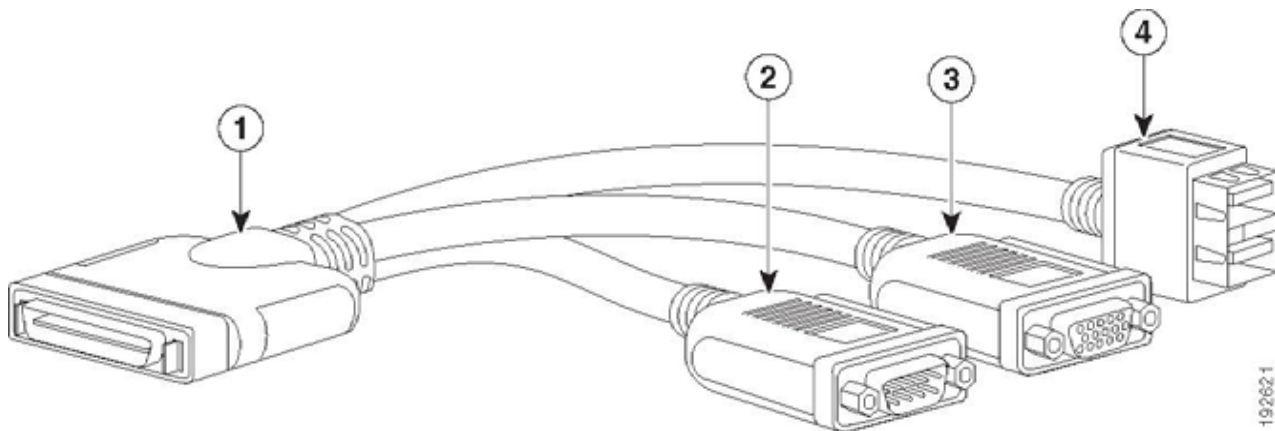

1	Connector (to server front panel)	3	VGA connector (for a monitor)
2	DB-9 serial connector	4	Two-port USB 2.0 connector (for a mouse and keyboard)

## Motherboard USB and SD Ports, and RAID Card Backup Locations

The C240 M4 SFF motherboard has a general-purpose USB socket and two SD sockets, as shown in *Figure 21*. The mounting locations for RAID card backup are also shown

Figure 21 Motherboard USB and SD Ports and RAID Backup Location

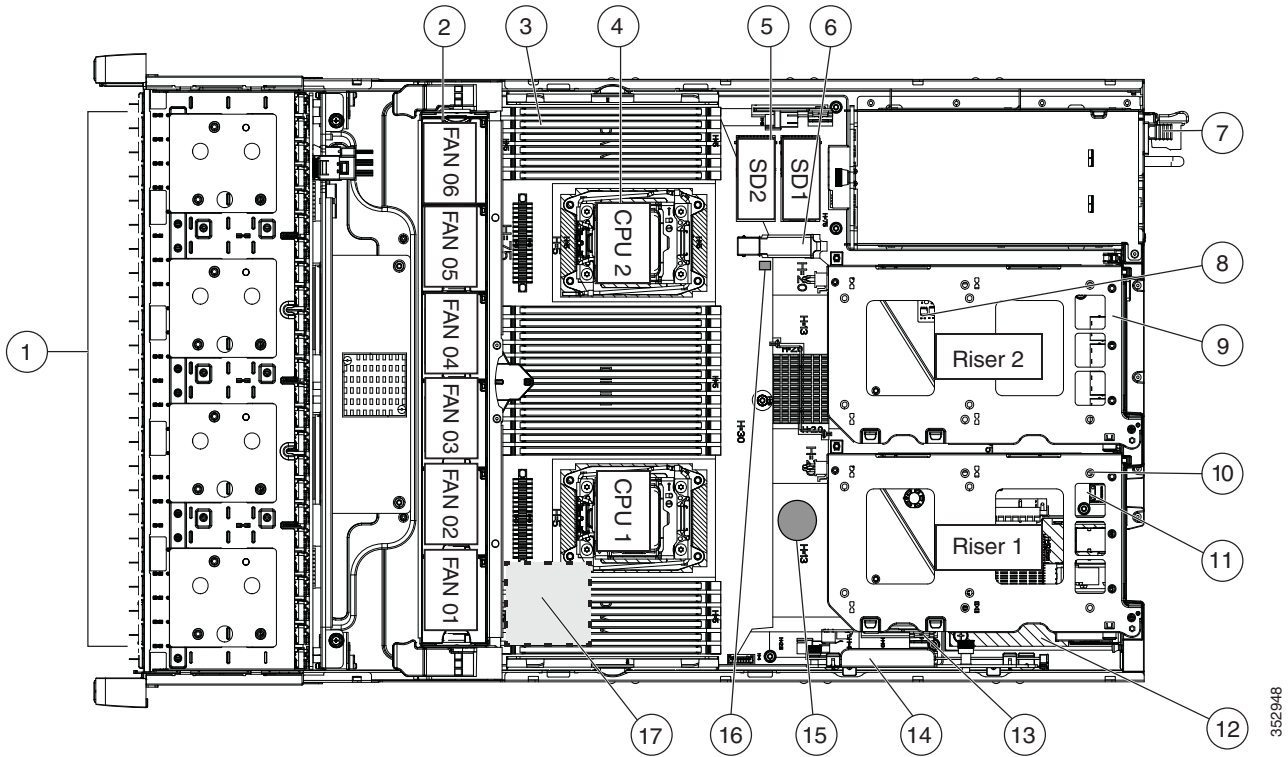

1	Drives (hot-swappable, accessed through front panel)	10	PCIe riser 1 (PCIe slots 1, 2, 3*) *Slot 3 not present in all versions.
2	Fan modules (six, hot-swappable)	11	SuperCap RAID data cache power backup unit mounting locations (two, on air baffle not shown in this view)
3	DIMM sockets on motherboard (up to 24 DIMMs)	12	SATA boot drives (two sockets available only on PCIe riser 1 option C)
4	CPUs and heatsinks (two)	13	Socket for embedded RAID interposer board
5	Cisco SD card slots on motherboard (two)	14	Cisco modular RAID controller PCIe slot (dedicated slot and bracket)
6	USB 3.0 slot on motherboard	15	RTC battery on motherboard
7	Power supplies (hot-swappable, accessed through rear panel)	16	Embedded RAID header for RAID key
8	Trusted platform module (TPM) socket on motherboard, under PCIe riser 2	17	SuperCap power module (RAID backup) mounting location on air baffle (not shown)
9	PCIe riser 2 (PCIe slots 4, 5, 6)		

# TECHNICAL SPECIFICATIONS

## Dimensions and Weight

Table 53 UCS C240 M4 Dimensions and Weight

Parameter	Value
Height	3.43 in. (8.70 cm)
Width (including slam latches)	17.65 in. (44.8 cm) Including handles: 18.96 in. (48.2 cm)
Depth	29.0 in. (73.8 cm) Including handles: 30.18 in. (76.6 cm)
Front Clearance	3 in. (76 mm)
Side Clearance	1 in. (25 mm)
Rear Clearance	6 in. (152 mm)
Weight <sup>1</sup>	
Maximum	
(24 HDD model with 24 HDDs, 2 CPUs, 24 DIMMs, 2 1200 W power supplies)	62.7 lbs (28.4 kg)
(16 HDD model with 16 HDDs, 2 CPUs, 24 DIMMs, 2 1200 W power supplies)	58.9 lbs (27.7 kg)
(8 HDD model with 8 HDDs, 2 CPUs, 24 DIMMs, 2 1200 W power supplies)	52.9 lbs (24.0 kg)
Minimum	
(24 HDD model with 1 HDD, 1 CPU, 1 DIMM, 1 1200 W power supply)	40.1 lbs (18.2 kg)
(16 HDD model with 1 HDD, 1 CPU, 1 DIMM, 1 1200 W power supply)	40.7 lbs (18.5 kg)
(8 HDD model with 1 HDD, 1 CPU, 1 DIMM, 1 1200 W power supply)	39.2 lbs (17.8 kg)
Bare	
(24 HDD model with 0 HDD, 0 CPU, 0 DIMM, 1 1200 W power supply)	37.9 lbs (17.2 kg)
(16 HDD model with 0 HDD, 0 CPU, 0 DIMM, 1 1200 W power supply)	38.5 lbs (17.5 kg)
(8 HDD model with 0 HDD, 0 CPU, 0 DIMM, 1 1200 W power supply)	37.0 lbs (16.8 kg)

## Notes . . .

1. Weight includes inner rail, which is attached to the server. Weight does not include outer rail, which is attached to the rack.

## Power Specifications

The server is available with the following types of power supplies:

- 650 W (AC)
- 930 W (DC)
- 1200 W (AC)
- 1400 W (AC)

The general power specifications for the C240 M4 SFF server are listed as follows:

- 650 W (AC) power supply (see [Table 54](#)).
- 930 W (DC) power supply (see [Table 55](#)).
- 930 W V2 (DC) power supply (see [Table 56](#))
- 1200 W V2 (AC) power supply (see [Table 57 on page 104](#))
- 1400 W V2 (AC) power supply (see [Table 58 on page 105](#))

Table 54 UCS C240 M4 SFF Power Specifications (650 W AC power supply)

Description	Specification
AC input voltage range	Voltage Range 100-127 VAC, 200-240 VAC nominal (range: 90-140 VAC, 180-264 VAC)
AC input frequency	50 to 60 Hz nominal (range: 47 to 63 Hz)
Maximum AC input current	7.6 Amps maximum at 100 VAC 3.65 Amps maximum at 208 VAC
Maximum Input VA	760 VA at 100 VAC
Maximum output power for each power supply	650 W
Maximum AC inrush current	35 A (sub cycle duration)
Maximum hold up time	12 ms @ 650 W
Power supply output voltage	12 VDC
Power supply standby voltage	12 VDC
Power supply efficiency	Climate Savers Platinum Efficiency (80Plus Platinum Certified)
Form factor	RSP1
Input connector	IEC320 C14

Table 55 UCS C240 M4 SFF Power Specifications (930 W DC power supply)

Description	Specification
AC input voltage	Voltage Range: -48 to -60 VDC nominal (range: -40 to -60 VDC)
Max DC Input current	23A at -48 VDC
Maximum Input Power	1104 W at -48VDC
Maximum output power per power supply	930W
Maximum inrush current	35 A (sub cycle duration)
Maximum hold up time	4ms @ 930 W
Power supply output voltage	12 VDC
Power supply standby voltage	12 VDC
Efficiency rating	> 92% at 50% Load
Form Factor	RSP1
Input connector	3-pos euro terminal block spring cage connection connector. Plug PID UCSC-CONN-930WDC=

Table 56 UCS C240 M4 SFF Power Specifications (930 W DC V2 power supply)

Description	Specification
AC input voltage	Voltage Range: -48 to -60 VDC nominal (range: -40 to -60 VDC)
Max DC Input current	23 A at -48 VDC
Maximum Input Power	1104 W at -48 VDC
Maximum output power per power supply	930 W
Maximum inrush current	35 A (sub cycle duration)
Maximum hold up time	4 ms @ 930 W
Power supply output voltage	12 VDC

Table 56 UCS C240 M4 SFF Power Specifications (930 W DC V2 power supply) *(continued)*

Description	Specification
Power supply standby voltage	12 VDC
Efficiency rating	> 92% at 50% Load
Form Factor	RSP1
Input connector	3 wire Connector (Molex MINIFIT SR. R/A)

Table 57 UCS C240 M4 SFF Power Specifications (1200 W V2 AC power supply)

Description	Specification
AC input voltage	Voltage Range 100-127 VAC, 200-240 VAC nominal (range: 90-140 VAC, 180-264 VAC)
AC input frequency	50 to 60 Hz nominal (range: 47 to 63 Hz)
Max AC Input current	11 A at 100 VAC 7 A at 200 VAC
Maximum Input VA	1400 VA @230VAC
Maximum output power per power supply	800 W at 100 - 120 VAC 1200 W at 200 - 240 VAC 36 W on 12V DC Standby
Maximum inrush current	30 A (sub cycle duration)
Maximum hold up time	12 ms @ 1200 W
Power supply output voltage	12 VDC
Power supply standby voltage	12 VDC
Efficiency rating	Climate Savers Platinum Efficiency (80Plus Platinum Certified)
Form Factor	RSP1 (C-Series 2U and 4U Server)
Input connector	IEC320 C14



Table 58 UCS C240 M4 SFF Power Specifications (1400 W V2 AC power supply)

Description	Specification
AC input voltage	Voltage Range 200-240 VAC nominal (range:180-264 VAC)
AC input frequency	50 to 60 Hz nominal (range: 47 to 63 Hz)
Max AC Input current	8.5 A at 200 VAC
Maximum Input VA	1630 VA @230 VAC
Maximum output power per power supply	1400 W at 200-240 VAC 36 W on 12V DC Standby
Maximum inrush current	30 A (sub cycle duration)
Maximum hold up time	12 ms @ 1400 W
Power supply output voltage	12 VDC
Power supply standby voltage	12 VDC
Efficiency rating	Climate Savers Platinum Efficiency (80Plus Platinum Certified)
Form Factor	RSP1 (C-Series 2U and 4U Server)
Input connector	IEC320 C14

For configuration-specific power specifications, use the Cisco UCS Power Calculator at this URL:

<http://ucspowercalc.cisco.com>

## Environmental Specifications

The power specifications for the C240 M4 server are listed in [Table 59](#).

Table 59 UCS C240 M4 SFF Environmental Specifications

Parameter	Minimum
Temperature operating	41 to 95° F (5 to 35° C) derate the maximum temperature by 1° C per every 1000 ft. (305 m) of altitude above sea level
Temperature nonoperating	-40 to 149° F (-40 to 65° C)
Humidity (RH) operating	10 to 90%, non-condensing at 82° F (28° C)
Humidity (RH) nonoperating	5 to 93% at 82° F (28° C)
Altitude operating	0 to 3,000 m (0 to 10,000 ft.)
Altitude nonoperating	0 to 12,192 m (0 to 40,000 ft.)
Sound Power level, Measure A-weighted per ISO7779 LWAd (Bels) Operation at 73° F (23° C)	5.8
Sound Pressure level, Measure A-weighted per ISO7779 LpAm (dBA) Operation at 73° F (23° C)	43

## Compliance Requirements

The regulatory compliance requirements for C-Series servers are listed in [Table 60](#).

Table 60 UCS C-Series Regulatory Compliance Requirements

Parameter	Description
Regulatory Compliance	Products should comply with CE Markings per directives 2004/108/EC and 2006/95/EC
Safety	UL 60950-1 Second Edition CAN/CSA-C22.2 No. 60950-1 Second Edition EN 60950-1 Second Edition IEC 60950-1 Second Edition AS/NZS 60950-1 GB4943 2001
EMC - Emissions	47CFR Part 15 (CFR 47) Class A AS/NZS CISPR22 Class A CISPR22 Class A EN55022 Class A ICES003 Class A VCCI Class A EN61000-3-2 EN61000-3-3 KN22 Class A CNS13438 Class A
EMC - Immunity	EN55024 CISPR24 EN300386 KN24



---

**Americas Headquarters**  
Cisco Systems, Inc.  
San Jose, CA

**Asia Pacific Headquarters**  
Cisco Systems (USA) Pte. Ltd.  
Singapore

**Europe Headquarters**  
Cisco Systems International BV Amsterdam,  
The Netherlands

---

Cisco has more than 200 offices worldwide. Addresses, phone numbers, and fax numbers are listed on the Cisco Website at [www.cisco.com/go/offices](http://www.cisco.com/go/offices).

---

Cisco and the Cisco Logo are trademarks of Cisco Systems, Inc. and/or its affiliates in the U.S. and other countries. A listing of Cisco's trademarks can be found at [www.cisco.com/go/trademarks](http://www.cisco.com/go/trademarks). Third party trademarks mentioned are the property of their respective owners. The use of the word partner does not imply a partnership relationship between Cisco and any other company. (1005R)