

# Acer LCD Monitor Quick Start Guide (QSG)

## Important safety instructions

Please read the following instructions carefully.

1. To clean the LCD monitor screen: Be sure that your monitor is electrically rated to operate with the AC power available in your location.
  - Turn off the LCD monitor and unplug the power cord.
  - Spray a non-solvent cleaning solution onto a rag and clean the screen gently.
  - NEVER SPRAY OR POUR ANY LIQUID DIRECTLY ONTO THE SCREEN OR CASE.
  - PLEASE DO NOT USE ANY AMMONIA OR ALCOHOL-BASED CLEANERS ON THE LCD DISPLAY SCREEN OR CASE.
  - Acer will not be liable for damage resulting from use of any ammonia or alcohol-based cleaners.
2. Do not place the LCD monitor near a window. Exposing the monitor to rain, moisture or sunlight can severely damage it.
3. Do not apply pressure to the LCD screen. Excessive pressure may cause permanent damage to the display.
4. Do not remove the cover or attempt to service this unit yourself. An authorized technician should perform servicing of any nature.
5. Store the LCD monitor in a room with a temperature of -20° to 60°C (-4° to 140°F). Storing the LCD monitor outside this range may result in permanent damage.
6. Immediately unplug your monitor and call an authorized technician if any of the following circumstances occur:
  - Monitor-to-PC signal cable is frayed or damaged.
  - Liquid spills onto the LCD monitor or the monitor is exposed to rain.
  - The LCD monitor or case is damaged.

# Package contents

LCD Monitor	AC Power Cord	DP Cable (Optional)
-------------	---------------	---------------------

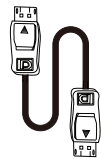
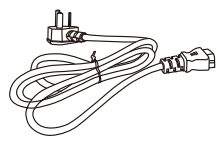

HDMI Cable (Optional)	Adaptor	Quick Start Guide
-----------------------	---------	-------------------

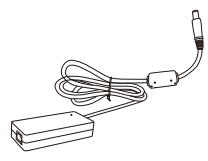

## Attaching the monitor to the base

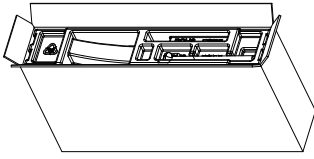

1. Unpack the box. Take out the Styrofoam side by side and set flat on the desktop.

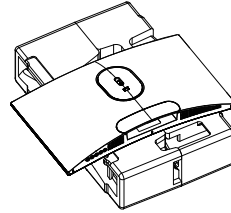

2. Take the LCD monitor out of the box carefully and put it on the side by side Styrofoam.

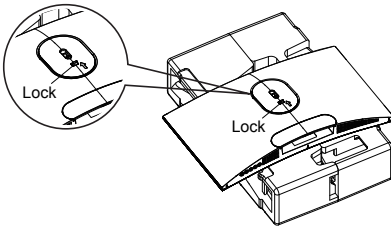

3. Press up the quick release button as illustrated to remove rotary shaft cover.

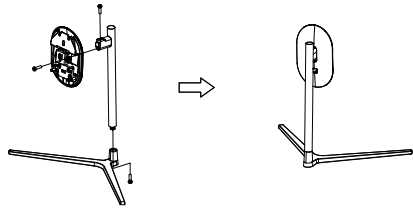

4. Tighten the rotary shaft, base and stand arm with three screws. (There will be one spare screw left.)

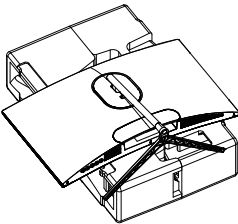

5. Attach the base of step 4 to the quick release notch of the LCD monitor securely.

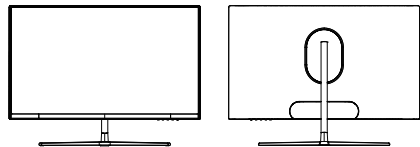

6. Flip the LCD monitor over to make it stand upright on the desk where it will be used. (Note: Do NOT press the screen to avoid damage any time.)

## Connecting Your Monitor to a Computer



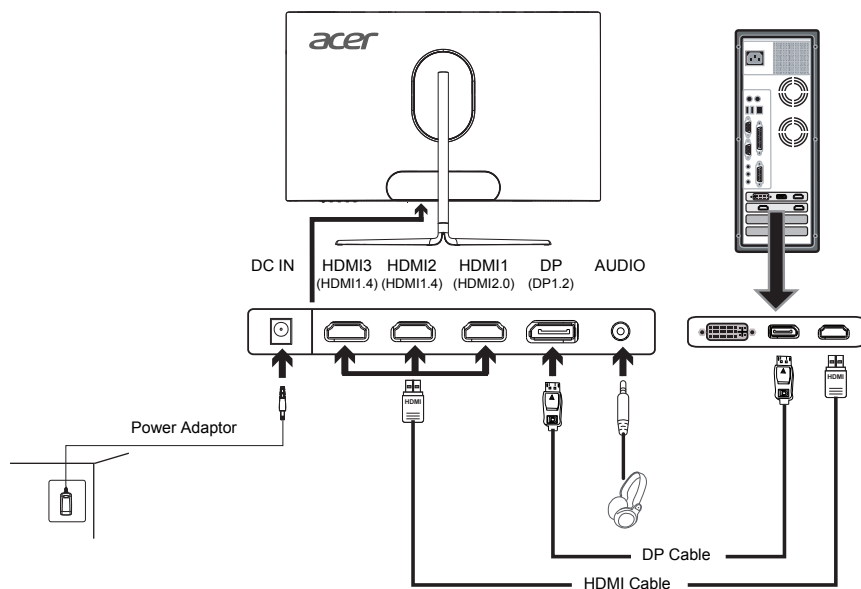



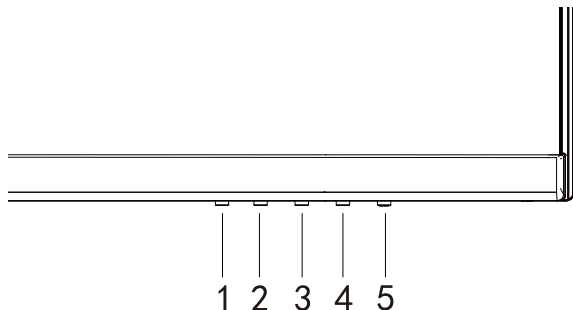

1. Make sure both the monitor and computer are powered-OFF.
2. Connect DP Cable (Only DP-input model)
  - a. Make sure both the monitor and computer are powered-OFF.
  - b. Connect the DP cable to the computer.
3. Connect HDMI Cable (Only HDMI-input model)
  - a. Make sure both the monitor and computer are powered-OFF.
  - b. Connect the HDMI cable to the computer.
4. Plug the power cords of your computer and your monitor into a nearby electrical outlet.



- Note:**
1. The audio output function depends on models. Please refer to User's Guide for more information.
  2. DP (1.2): 2560x1440 supports 144Hz, (also support FreeSync2 and HDR function).  
HDMI (2.0): 2560x1440 supports 144Hz, and also support FreeSync2 and HDR function.  
HDMI (1.4): 2560x1440 supports 60Hz.

## External Controls



No.	Icon	Item	Description
1	 / 	Mode / Exit	a. Press to trigger Mode control. b. When the OSD menu is enabled, press to exit the current menu and go back one level.
2	 / 	Brightness / Enter	a. Press the key to open the Brightness control. b. When the OSD menu is enabled, press to enter to next level.
3	 / 	Input button/+	a. Press to toggle input sources. b. When the OSD menu is enabled, press to select or return to the previous menu.
4	 / 	OSD functions/-	a. Press to view the OSD. b. When the OSD menu is enabled, press to select or go to the next menu.
5	POWER	Power button	Turns the monitor on/off. Blue indicates power on. Blinking Blue indicates standby mode.

### FreeSync (HDMI1/DP Only):

It can allow a FreeSync supported graphics source to dynamically adjust display refresh rate based on typical content frame rates for power efficient, virtually stutter free and low-latency display.

## Regulations and safety notices

### FCC notice

This device has been tested and found to comply with the limits for a Class B digital device pursuant to Part 15 of the FCC rules. These limits are designed to provide reasonable protection against harmful interference in a residential installation. This device generates, uses, and can radiate radio frequency energy and, if not installed and used in accordance with the instructions, may cause harmful interference to radio communications.

However, there is no guarantee that interference will not occur in a particular installation. If this device does cause harmful interference to radio or television reception, which can be determined by turning the device off and on, the user is encouraged to try to correct the interference by one or more of the following measures:

- Reorient or relocate the receiving antenna.
- Increase the separation between the device and receiver.
- Connect the device into an outlet on a circuit different from that to which the receiver is connected.
- Consult the dealer or an experienced radio/television technician for help.

### CE declaration of Conformity

Hereby, Acer Inc., declares that this LCD monitor is in compliance with the essential requirements and other relevant provisions of EMC Directive 2014/30/EU, Low Voltage Directive 2014/35/EU, and RoHS Directive 2011/65/EU and Directive 2009/125/EC with regard to establishing a framework for the setting of ecodesign requirements for energy-related product.

### Notice:

In order to prevent damage to the monitor, do not lift the monitor by its base.

### Notice: Shielded cables

All connections to other computing devices must be made using shielded cables to maintain compliance with EMC regulations.

### Notice:

Acer monitor is purposed for video and visual display of information obtained from electronic devices.

### Notice: Peripheral devices

Only peripherals (input/output devices, terminals, printers, etc.) certified to comply with the Class B limits may be attached to this equipment. Operation with non-certified peripherals is likely to result in interference to radio and TV reception.

### Caution

Changes or modifications not expressly approved by the manufacturer could void the user authority, which is granted by the Federal Communications Commission, to operate this product.

### Operation conditions

This device complies with Part 15 of the FCC Rules. Operation is subject to the following two conditions: (1) this device may not cause harmful interference, and (2) this device must accept any interference received, including interference that may cause undesired operation.

### Notice: Canadian users

This Class B digital apparatus complies with Canadian ICES-003.

### Remarque à l'intention des utilisateurs canadiens

Cet appareil numérique de la classe B est conforme à la norme NMB-003 du Canada.

## Disposal of Waste Equipment by Users in Private Household in the European Union



This symbol on the product or on its packaging indicates that this product must not be disposed of with your other household waste. Instead, it is your responsibility to dispose of your waste equipment by handing it over to a designated collection point for the recycling of waste electrical and electronic equipment. The separate collection and recycling of your waste equipment at the time of disposal will help to conserve natural resources and ensure that it is recycled in a manner that protects human health and the environment. For more information about where you can drop off your waste equipment for recycling, please contact your local city office, your household waste disposal service or the shop where you purchased the product.

Acer monitor is purposed for video and visual display of information obtained from electronic devices.

## SPECIFICATION

LCD Panel	Model No.	EI272UR
	Driving System	TFT Color LCD
	Size	27" W (69 cm)
	Pixel pitch	0.2331 (H) x 0.2331 (V)
	Brightness	Typical: 350 cd/m <sup>2</sup> ; HDR400 Mode: 400 cd/m <sup>2</sup> (peak)
	Contrast	100,000,000:1 Max. (ACM)
	Viewable angle	178° (H) 178° (V) (CR≥10)
	Response time	4 ms (G to G)
	Panel Type	VA
	Video	Digital Interface
H-Frequency	70.56~214.56 KHz	
V-Frequency	48~144 Hz	
Display Colors	16.7M Colors	
Dot Clock	645.18 MHz	
Max. Resolution	DP: 2560x1440 @144Hz HDMI1 (2.0): 2560x1440 @144Hz HDMI2/3 (1.4): 2560x1440 @60Hz	
Plug & Play	VESA DDCI/DDC2B	
Energy Efficiency Class	A	
*Annual Energy Consumption	33 (kWh) (for HDMI-input Model)	
Power consumption @200cd/m <sup>2</sup>	ON Mode	22W (typ.)
	Sleep Mode	≤0.5W (typ.)
	Off	≤0.5W (typ.)
Input Connector	DP (Only DP Model) HDMI (Only HDMI model)	
Input Video Signal	DP signal (Only DP-Input Model) HDMI signal (Only HDMI-Input Model)	
Speakers	3W x 2	
Audio	Audio-Output (Only Audio-Output Model)	
Maximum Screen Size	Horizontal: 596.736 mm Vertical: 335.664 mm	
Power Source	100-240V, 50/60Hz	
Environmental Considerations	Operating Temp: 5° to 35°C Storage Temp: -20° to 60°C Operating Humidity: 20% to 80%	
Dimensions	616.2 (W) x 453.1 (H) x 195.7 (D) mm	
Weight (N. W.)	4.87 kg/Unit (net)	
Mechanism spec	Tilt: -5° to +15° Swivel: N/A Height adjustment: N/A Pivot: N/A Detachable foot stand: Yes	



External Controls	Functions	Brightness Contrast Black Boost Blue Light ACM HDR Super Sharpness Gamma Color Temp. Modes Color Space Grayscale Mode 6-axis Hue 6-axis Saturate DDC/CI Quick Start Mode	Volume Mute Over Drive FreeSync Refresh Rate Num. Aim Point Language OSD Timeout Transparency OSD Lock Input Auto Source DP Format Wide Mode Hot Key Assignment HDMI Black Level LED Control
-------------------	-----------	---	--

\* All specifications are subject to change without notice.

\* Annual energy consumption is calculated using the typical power consumption 4 hours per day, 365 days per year.

#### Regulatory Compliance

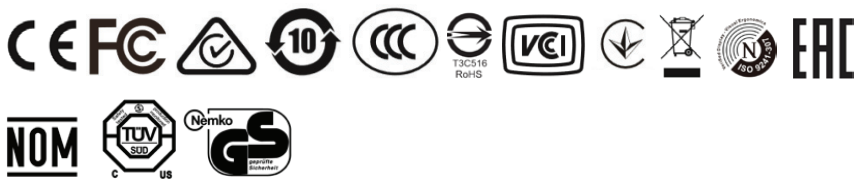

Find manuals and other documents for your Acer product on the official Acer support website.

#### Note:

- HDMI1 (2.0): Support max timing resolution (2560x1440-144Hz), support (FreeSync2 & HDR).
- HDMI2 (1.4): Support max timing resolution (2560x1440-60Hz).
- HDMI3 (1.4): Support max timing resolution (2560x1440-60Hz).
- DP (1.2): Support max timing resolution (2560x1440-144Hz), support (FreeSync2 & HDR).