

# Alienware AW3418DW/AW3418HW Monitor User's Guide

Model: AW3418DW/AW3418HW  
Regulatory model: AW3418DWb/AW3418HWb

A L I E N W A R E™ 

# Notes, cautions, and warnings

-  **NOTE:** A NOTE indicates important information that helps you make better use of your computer.
-  **CAUTION:** A CAUTION indicates potential damage to hardware or loss of data if instructions are not followed.
-  **WARNING:** A WARNING indicates a potential for property damage, personal injury, or death.

**Copyright © 2017 Dell Inc. All rights reserved.** This product is protected by U.S. and international copyright and intellectual property laws. Dell™ and the Dell logo are trademarks of Dell Inc. in the United States and/or other jurisdictions. All other marks and names mentioned herein may be trademarks of their respective companies.

2017 - 09

Rev. A00

# Contents

<b>About your monitor</b> .....	<b>5</b>
Package contents .....	5
Product features .....	7
Identifying parts and controls .....	8
Front view .....	8
Back view .....	9
Rear and bottom view .....	10
<b>Monitor specifications</b> .....	<b>11</b>
Flat panel specifications .....	11
Resolution specifications .....	13
Supported video modes .....	13
Preset display modes .....	13
Electrical specifications .....	16
Physical characteristics .....	16
Environmental characteristics .....	17
Power management modes .....	18
Pin assignments .....	19
<b>Plug and Play capability</b> .....	<b>20</b>
<b>Universal Serial Bus (USB) interface</b> .....	<b>21</b>
USB upstream connector .....	21
USB downstream connector .....	22
USB ports .....	22
<b>LCD monitor quality and pixel policy</b> .....	<b>23</b>
<b>Maintenance guidelines</b> .....	<b>23</b>
Cleaning your monitor .....	23
<b>Setting up the monitor</b> .....	<b>24</b>
Attaching the stand .....	24



Connecting the computer . . . . .	28
Removing the monitor stand . . . . .	29
VESA wall mounting (optional) . . . . .	31
<b>Operating the monitor . . . . .</b>	<b>32</b>
Power on the monitor . . . . .	32
Using the front-panel controls . . . . .	32
Front-panel button . . . . .	33
Using the On-Screen Display (OSD) menu . . . . .	34
Accessing the menu system . . . . .	34
OSD warning message . . . . .	47
Setting the maximum resolution . . . . .	47
Using the tilt, swivel, and vertical extension . . . . .	48
Tilt, swivel . . . . .	48
Vertical extension . . . . .	49
<b>Troubleshooting . . . . .</b>	<b>50</b>
Self-test . . . . .	50
Built-in diagnostics . . . . .	51
Common problems . . . . .	52
Product specific problems . . . . .	54
Universal Serial Bus (USB) specific problems . . . . .	55
<b>Appendix . . . . .</b>	<b>56</b>
FCC notices (U.S. only) and other regulatory information . . . . .	56
Contact Dell . . . . .	56

# About your monitor

## Package contents

Your monitor ships with the components shown below. If any component is missing, contact Dell technical support. For more information see [Contact Dell](#).

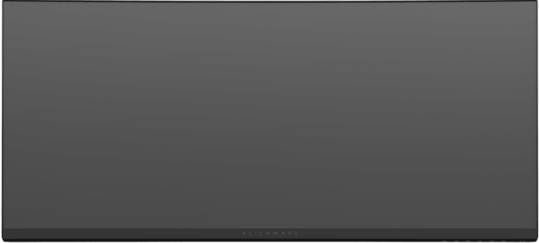
 **NOTE: Some items may be optional and may not ship with your monitor. Some features or media may not be available in certain countries.**

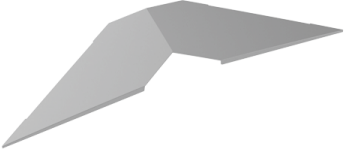
	Monitor
	Stand riser
	I/O cover

	<p>Power cable (varies by country)</p>
	<p>DisplayPort cable</p>
	<p>Mini-DisplayPort to DisplayPort cable</p>
	<p>USB 3.0 upstream cable (Enables the USB ports on the monitor)</p>
	<ul style="list-style-type: none"> <li>▪ Drivers and Utilities media</li> <li>▪ Quick Setup Guide</li> <li>▪ Safety, Environmental, and Regulatory Information</li> </ul>

## Product features

The **Alienware AW3418DW/AW3418HW** flat panel display has an active matrix, Thin-Film Transistor (TFT), Liquid Crystal Display (LCD) and LED backlight. The monitor features include:

- **AW3418DW:** 86.72 cm (34.14 inch) viewable area (measured diagonally). Resolution: Up to 3440 x 1440 through DisplayPort and HDMI, with full-screen support or lower resolutions, supporting an extremely high refresh rate of 100 Hz (120 Hz with overclock).
- **AW3418HW:** 86.70 cm (34.13 inch) viewable area (measured diagonally). Resolution: Up to 2560 x 1080 through DisplayPort and HDMI, with full-screen support or lower resolutions, supporting an extremely high refresh rate of 144 Hz (160 Hz with overclock).
- Nvidia G-Sync-enabled monitor with a rapid response time of 4 ms.
- Color gamut of 99% sRGB.
- Tilt, swivel, and height adjustment capabilities.
- Removable stand and Video Electronics Standards Association (VESA™) 100 mm mounting holes for flexible mounting solutions.
- Digital connectivity with DisplayPort and HDMI.
- Equipped with one USB upstream port and four USB downstream ports.
- Plug and play capability if supported by your system.
- On-Screen Display (OSD) adjustments for ease of set-up and screen optimization.
- AW3418DW and AW3418HW offer six preset modes including FPS (First-Person Shooter), RTS (Real-Time Strategy), RPG (Role-Playing Game) and three customizable game modes for user's own preference. In addition, key enhanced gaming features such as Timer, Frame Rate and Display Alignment are provided to help improve gamer's performance and provide best-in game advantage.
- Software and documentation media includes an Information File (INF), Image Color Matching File (ICM), and product documentation.
- 0.5 W standby power when in sleep mode.
- Optimize eye comfort with a flicker-free screen.

**WARNING: The possible long-term effects of blue light emission from the monitor may cause damage to the eyes, including eye fatigue, digital eye strain, and so on. ComfortView feature is designed to reduce the amount of blue light emitted from the monitor to optimize eye comfort.**

# Identifying parts and controls

## Front view

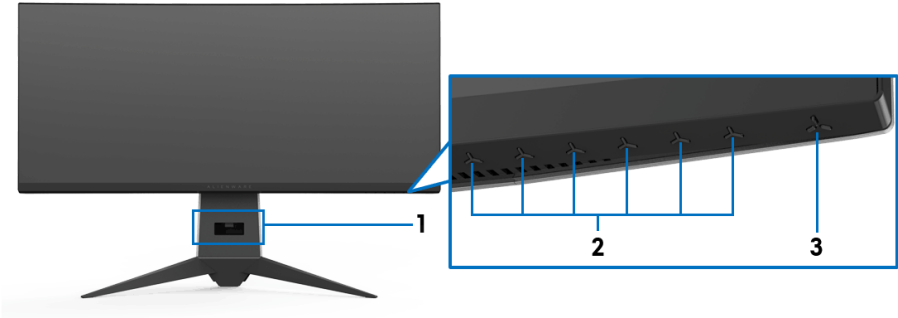

Label	Description
1	Cable-management slot (on the front side of the stand)
2	Function buttons (For more information, see <a href="#">Operating the monitor</a> )
3	Power On/Off button (with LED indicator)



## Back view



**Back view with monitor stand**

Label	Description	Use
<b>1</b>	VESA mounting holes (100 mm x 100 mm - behind attached VESA Cover)	Wall mount monitor using VESA-compatible wall mount kit (100 mm x 100 mm).
<b>2</b>	Lighting dock	When the stand riser is attached to the monitor, the dock supplies power to the light on the stand.
<b>3</b>	Regulatory label	Lists the regulatory approvals.
<b>4</b>	Stand release button	Releases stand from the monitor.
<b>5</b>	Barcode serial number label	Refer to this label if you need to contact Dell for technical support.
<b>6</b>	Cable-management slots (on the left and right sides of the stand)	Use to organize cables by inserting them through the slots.

## Rear and bottom view

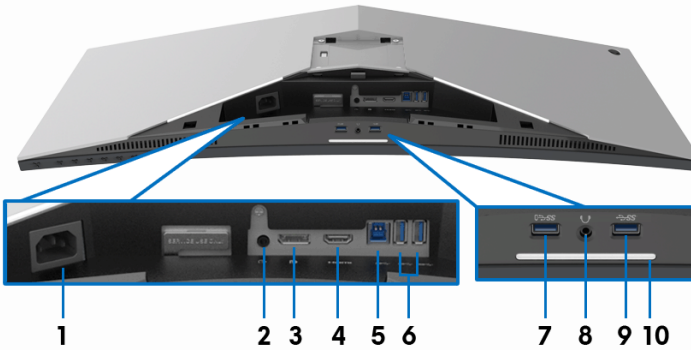

Rear and bottom view without monitor stand

Label	Description	Use
1	Power connector	Connect the power cable (shipped with your monitor).
2	Line-out port	Connect your speakers. <b>NOTE:</b> This port does not support headphones.
3	DisplayPort	Connect your computer with DisplayPort-DisplayPort or Mini-DisplayPort-DisplayPort cable (shipped with your monitor).
4	HDMI port	Connect your computer with HDMI cable.
5	USB upstream port	Connect the USB cable (shipped with your monitor) to this port and your computer to enable the USB ports on your monitor.
6, 9	USB 3.0 ports (3)	Connect your USB device. <b>NOTE:</b> To use these ports, you must connect the USB cable (shipped with your monitor) to the USB-upstream port on the monitor and to your computer.
7	USB port with Power Charging	Connect to charge your USB device.

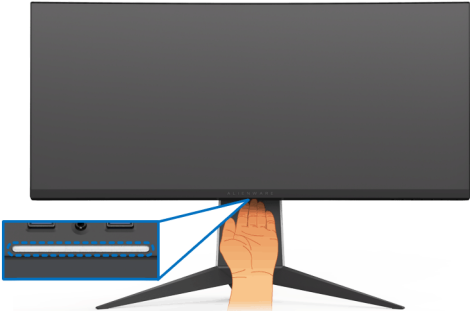
<b>8</b>	Headphone port	Connect a headphone or speakers.
<b>10</b>	Downlights	<p>When the monitor is completely set up (see <a href="#">Attaching the stand</a> and <a href="#">Connecting the computer</a>), tap the touch sensor to turn the downlights on or off.</p>  <p><b>NOTE:</b> The factory setting is on. To change the default settings, see <a href="#">AlienFX Lighting</a>.</p>

## Monitor specifications

### Flat panel specifications

Model	AW3418DW	AW3418HW
Screen type	Active matrix - TFT LCD	
Panel technology	In-Plane Switching Type	
Aspect ratio	21:9	
Viewable image		
Diagonal	867.2 mm (34.14 inches)	867.0 mm (34.13 inches)
Width (active area)	799.80 mm (31.49 inches)	799.80 mm (31.49 inches)
Height (active area)	334.80 mm (13.18 inches)	334.80 mm (13.18 inches)
Total area	267773.04 mm <sup>2</sup> (415.01 inch <sup>2</sup> )	267771.43 mm <sup>2</sup> (415.01 inch <sup>2</sup> )
Pixel pitch	0.2325 mm x 0.2325 mm	0.31 mm x 0.31 mm
Pixel per inch (PPI)	109	81.9

Viewing angle	178° (vertical) typical 178° (horizontal) typical	
Luminance output	300 cd/m <sup>2</sup> (typical)	
Contrast ratio	1000 to 1 (typical)	
Faceplate coating	Anti-Glare with 3H hardness	
Backlight	LED edgelight system	
Response time	4 ms gray-to-gray	
Curvature	1900R (typical)	3800R (typical)
Color depth	16.77 million colors	
Color gamut	sRGB 99%, CIE1931 (73%) and CIE 1976 (82%)	sRGB 99%, CIE1931 (74%) and CIE 1976 (81%)
Built-in devices	<ul style="list-style-type: none"> <li>▪ USB 3.0 super-speed hub (with one USB 3.0 upstream port)</li> <li>▪ Four USB 3.0 downstream ports (including one port which supports power-charging)</li> </ul>	
Ports and connectors	<ul style="list-style-type: none"> <li>▪ One DisplayPort version 1.2</li> <li>▪ One HDMI port version 1.4</li> <li>▪ One USB 3.0 Upstream port (rear)</li> <li>▪ Two USB 3.0 Downstream ports (rear)</li> <li>▪ Two USB 3.0 Downstream ports (bottom)</li> <li>▪ One Headphone port (bottom)</li> <li>▪ One Audio line-out port (rear)</li> </ul>	
Border width (edge of monitor to active area)	10.45 mm (Top) 9.77 mm (Left/Right) 18.43 mm (Bottom)	7.9 mm (Top) 7.02 mm (Left/Right) 25.58 mm (Bottom)
Adjustability		
Height adjustable stand	0 to 130 mm	
Tilt	-5° to 25°	
Swivel	-20° to 20°	

## Resolution specifications

Model	AW3418DW	AW3418HW
Horizontal scan range	73 kHz to 151 kHz (automatic)	66 kHz to 166 kHz (automatic)
Vertical scan range	30 Hz to 100 Hz (automatic) 120 Hz (with overclock)	30 Hz to 144 Hz (automatic) 160 Hz (with overclock)
Maximum preset resolution	3440 x 1440 at 120 Hz (with overclock)	2560 x 1080 at 160 Hz (with overclock)

## Supported video modes

Model	AW3418DW/AW3418HW
Video display capabilities (HDMI & DP playback)	480p, 576p, 720p, 1080p, FHD

## Preset display modes

### HDMI display modes (AW3418DW)

Display mode	Horizontal frequency (kHz)	Vertical frequency (Hz)	Pixel clock (MHz)	Sync polarity (Horizontal/Vertical)
IBM VGA, 640 x 480p	31.5	60	25.2	-/-
VESA, 720 x 480p	29.83	60	26.25	+/-
VESA, 720 x 576p	29.55	50	26	+/-
VESA, 800 x 600p	37.88	60	40	+/+
VESA, 1024 x 768p	48.36	60	65	-/-
HDTV, 1280 x 720p	37.5	50	74.25	+/+
HDTV, 1280 x 720p	45	60	74.25	+/+
HDTV, 1920 x 1080p	56.25	50	148.5	-/+

HDTV, 1920 x 1080p	67.5	60	148.5	+/+
3440 x 1440 @ 50Hz	73.7	50	265.25	+/-

### HDMI display modes (AW3418HW)

Display mode	Horizontal frequency (kHz)	Vertical frequency (Hz)	Pixel clock (MHz)	Sync polarity (Horizontal/Vertical)
IBM VGA, 640 x 480p	31.5	60	25.2	-/-
VESA, 720 x 480p	29.83	60	26.25	+/-
VESA, 720 x 576p	29.55	50	26	+/-
VESA, 800 x 600p	37.88	60	40	+/+
VESA, 1024 x 768p	48.36	60	65	-/-
HDTV, 1280 x 720p	37.5	50	74.25	+/+
HDTV, 1280 x 720p	45	60	74.25	+/+
HDTV, 1920 x 1080p	56.25	50	148.5	-/+
HDTV, 1920 x 1080p	67.5	60	148.5	+/+
2560 x 1080 @ 60Hz	66.64	60	181.25	+/-

### DP Display Modes (AW3418DW)

Display mode	Horizontal frequency (kHz)	Vertical frequency (Hz)	Pixel clock (MHz)	Sync polarity (Horizontal/Vertical)
VESA, 640 x 480	31.5	60	25.2	-/-
VESA, 800 x 600	37.88	60	40	+/+
VESA, 1024 x 768	48.36	60	65	-/-
3440 x 1440@60Hz	88.8	60	319.75	+/-
3440 x 1440@50Hz	73.7	50	265.25	+/-
3440 x 1440@85Hz	127.4	85	458.5	+/-

3440 x 1440@100Hz	151	100	531.52	+/-
3440 x 1440@105Hz	159	105	559.57	+/-
3440 x 1440@110Hz	166.9	110	587.38	+/-
3440 x 1440@115Hz	172.5	115	607.2	+/+
3440 x 1440@120Hz	180	120	633.6	+/+

### DP display modes (AW3418HW)

Display mode	Horizontal frequency (kHz)	Vertical frequency (Hz)	Pixel clock (MHz)	Sync polarity (Horizontal/Vertical)
VESA, 640 x 480	31.5	60	25.2	-/-
VESA, 800 x 600	37.88	60	40	+/+
VESA, 1024 x 768	48.36	60	65	-/-
2560 x 1080@60Hz	66.6	60	181.25	+/-
2560 x 1080@85Hz	95.5	85	259.75	+/-
2560 x 1080@100Hz	113.2	100	308	+/-
2560 x 1080@120Hz	137.2	120	373.25	+/-
2560 x 1080@144Hz	166.5	144	453	+/-
2560 x 1080@150Hz	174.1	150	473.5	+/-
2560 x 1080@155Hz	180.2	155	490.25	+/-
2560 x 1080@160Hz	186.5	160	507.25	+/-

 **NOTE:** This monitor supports NVIDIA G-Sync. For information about the graphic cards that support NVIDIA G-SYNC feature, go to [www.geforce.com](http://www.geforce.com).

## Electrical specifications

Model	AW3418DW	AW3418HW
Video input signals	<ul style="list-style-type: none"> <li>▪ HDMI 1.4, 600 mV for each differential line, 100 ohm input impedance per differential pair</li> <li>▪ DisplayPort 1.2, 600 mV for each differential line, 100 ohm input impedance per differential pair</li> </ul>	
AC input voltage/frequency/current	100 VAC to 240 VAC / 50 Hz or 60 Hz $\pm$ 3 Hz / 1.8 A (typical)	100 VAC to 240 VAC / 50 Hz or 60 Hz $\pm$ 3 Hz / 1.5 A (typical)
Inrush current	<ul style="list-style-type: none"> <li>▪ 120 V: 30 A (Max.) at 0 °C (cold start)</li> <li>▪ 220 V: 60 A (Max.) at 0 °C (cold start)</li> </ul>	<ul style="list-style-type: none"> <li>▪ 120 V: 30 A (Max.) at 0 °C (cold start)</li> <li>▪ 220 V: 60 A (Max.) at 0 °C (cold start)</li> </ul>

## Physical characteristics

Model	AW3418DW	AW3418HW
<b>Signal cable type</b>	<ul style="list-style-type: none"> <li>▪ Digital: HDMI, 19 pins (cable not included)</li> <li>▪ Digital: DisplayPort, 20 pins</li> <li>▪ Universal Serial Bus: USB, 9 pins</li> </ul>	
<b>Dimensions (with stand)</b>		
Height (extended)	560.89 mm (22.08 inches)	563.15 mm (22.17 inches)
Height (compressed)	442.44 mm (17.42 inches)	442.44 mm (17.42 inches)
Width	813.45 mm (32.03 inches)	813.83 mm (32.04 inches)
Depth	319.09 mm (12.56 inches)	319.09 mm (12.56 inches)
<b>Dimensions (without stand)</b>		
Height	363.68 mm (14.32 inches)	368.28 mm (14.50 inches)
Width	813.45 mm (32.03 inches)	813.83 mm (32.04 inches)



Depth	121.37 mm (4.78 inches)	95.15 mm (3.74 inches)
<b>Stand dimensions</b>		
Height (extended)	448.95 mm (17.68 inches)	
Height (compressed)	442.44 mm (17.42 inches)	
Width	559.40 mm (22.02 inches)	
Depth	319.09 mm (12.56 inches)	
<b>Weight</b>		
Weight with packaging	19.28 kg (42.49 lb)	18.89 kg (41.64 lb)
Weight with stand assembly and cables	12.24 kg (26.98 lb)	11.81 kg (26.03 lb)
Weight without stand assembly (For wall mount or VESA mount considerations - no cables)	7.27 kg (16.02 lb)	6.91 kg (15.23 lb)
Weight of stand assembly	4.59 kg (10.12 lb)	4.52 kg (9.96 lb)
Front frame gloss	Black Frame - 20 gloss unit (max.)	

## Environmental characteristics

Model	AW3418DW	AW3418HW
<b>Compliant standards</b>		
<ul style="list-style-type: none"> <li>Arsenic-free glass and Mercury-free for the panel only</li> </ul>		
<b>Temperature</b>		
Operating	0 °C to 40 °C (32 °F to 104 °F)	
Non-operating	<ul style="list-style-type: none"> <li>Storage: -20 °C to 60 °C (-4 °F to 140 °F)</li> <li>Shipping: -20 °C to 60 °C (-4 °F to 140 °F)</li> </ul>	
<b>Humidity</b>		
Operating	10% to 80% (non-condensing)	
Non-operating	<ul style="list-style-type: none"> <li>Storage: 5% to 90% (non-condensing)</li> <li>Shipping: 5% to 90% (non-condensing)</li> </ul>	
<b>Altitude</b>		
Operating	5,000 m (16,404 ft) (maximum)	

Non-operating	12,192 m (40,000 ft) (maximum)	
<b>Thermal dissipation</b>	<ul style="list-style-type: none"> <li>▪ 375.3 BTU/hour (maximum)</li> <li>▪ 204.7 BTU/hour (typical)</li> </ul>	<ul style="list-style-type: none"> <li>▪ 324.1 BTU/hour (maximum)</li> <li>▪ 170.6 BTU/hour (typical)</li> </ul>

### Power management modes

If you have VESA's DPM™ compliance display card or software installed on your computer, the monitor can automatically reduce its power consumption when not in use. This is referred to as **Power save mode\***. If the computer detects input from the keyboard, mouse, or other input devices, the monitor automatically resumes to function. The following table shows the power consumption and signaling of this automatic power saving feature.

#### AW3418DW

VESA modes	Horizontal sync	Vertical sync	Video	Power indicator	Power consumption
Normal operation	Active	Active	Active	Blue	110 W (maximum)** 60 W (typical)
Active-off mode	Inactive	Inactive	Blanked	White (blinking)	Less than 0.5 W
Switch off	-	-	-	Off	Less than 0.3 W

#### AW3418HW

VESA modes	Horizontal sync	Vertical sync	Video	Power indicator	Power consumption
Normal operation	Active	Active	Active	Blue	95 W (maximum)** 50 W (typical)
Active-off mode	Inactive	Inactive	Blanked	White (blinking)	Less than 0.5 W
Switch off	-	-	-	Off	Less than 0.3 W

\* Zero power consumption in OFF mode can only be achieved by disconnecting the main cable from the monitor.

\*\* Maximum power consumption with max luminance, and USB active.

## Pin assignments

### DisplayPort connector

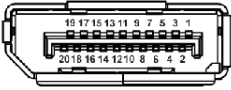

Pin number	20-pin side of the connected signal cable
1	ML0(p)
2	GND
3	ML0(n)
4	ML1(p)
5	GND
6	ML1(n)
7	ML2(p)
8	GND
9	ML2(n)
10	ML3(p)
11	GND
12	ML3(n)
13	GND
14	GND
15	AUX(p)
16	GND
17	AUX(n)
18	GND
19	Re-PWR
20	+3.3 V DP_PWR

## HDMI connector

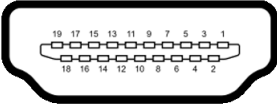

Pin number	19-pin side of the connected signal cable
1	TMDS DATA 2+
2	TMDS DATA 2 SHIELD
3	TMDS DATA 2-
4	TMDS DATA 1+
5	TMDS DATA 1 SHIELD
6	TMDS DATA 1-
7	TMDS DATA 0+
8	TMDS DATA 0 SHIELD
9	TMDS DATA 0-
10	TMDS CLOCK+
11	TMDS CLOCK SHIELD
12	TMDS CLOCK-
13	CEC
14	Reserved (N.C. on device)
15	DDC CLOCK (SCL)
16	DDC DATA (SDA)
17	DDC/CEC Ground
18	+5V POWER
19	HOT PLUG DETECT

## Plug and Play capability

You can install the monitor in any Plug and Play-compatible system. The monitor automatically provides the computer system with its Extended Display Identification Data (EDID) using Display Data Channel (DDC) protocols so that the system can configure itself and optimize the monitor settings. Most monitor installations are automatic; you can select different settings if desired. For more information about changing the monitor settings, see [Operating the monitor](#).

## Universal Serial Bus (USB) interface

This section gives you information about the USB ports that are available on the monitor.

 **NOTE: This monitor is Super-Speed USB 3.0 compatible.**

Transfer speed	Data rate	Power consumption*
Super-speed	5 Gbps	4.5 W (Max, each port)
High speed	480 Mbps	4.5 W (Max, each port)
Full speed	12 Mbps	4.5 W (Max, each port)

\* Up to 2 A on USB downstream port (port with  battery icon) with battery charging version-compliant devices or normal USB devices.

### USB upstream connector

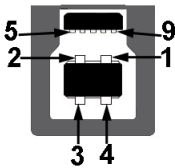

Pin number	9-pin side of the connector
1	VCC
2	D-
3	D+
4	GND
5	SSTX-
6	SSTX+
7	GND
8	SSRX-
9	SSRX+

## USB downstream connector



Pin number	9-pin side of the connector
1	VCC
2	D-
3	D+
4	GND
5	SSRX-
6	SSRX+
7	GND
8	SSTX-
9	SSTX+

## USB ports

- One upstream - rear
- Two downstream - rear
- Two downstream - bottom
- Power charging port - the port with  battery icon; supports fast current charging capability if the device is BC1.2 compatible.

 **NOTE: USB 3.0 functionality requires a USB 3.0-capable computer.**

 **NOTE: The USB ports on the monitor work only when the monitor is turned On or in power save mode. If you turn Off the monitor and then turn it On, the attached peripherals may take a few seconds to resume normal functionality.**

## LCD monitor quality and pixel policy

During the LCD Monitor manufacturing process, it is not uncommon for one or more pixels to become fixed in an unchanging state which are hard to see and do not affect the display quality or usability. For more information on Dell Monitor Quality and Pixel Policy, see [www.dell.com/support/monitors](http://www.dell.com/support/monitors).

## Maintenance guidelines

### Cleaning your monitor

- △ **CAUTION:** Read and follow the [Safety instructions](#) before cleaning the monitor.
- ⚠ **WARNING:** Before cleaning the monitor, unplug the monitor power cable from the electrical outlet.

For best practices, follow the instructions in the list below when unpacking, cleaning, or handling your monitor:

- To clean your anti-static screen, lightly dampen a soft, clean cloth with water. If possible, use a special screen-cleaning tissue or solution suitable for the anti-static coating. Do not use benzene, thinner, ammonia, abrasive cleaners, or compressed air.
- Use a lightly-dampened, warm cloth to clean the monitor. Avoid using detergent of any kind as some detergents leave a milky film on the monitor.
- If you notice white powder when you unpack your monitor, wipe it off with a cloth.
- Handle your monitor with care as a darker-colored monitor may get scratched and show white scuff marks more than a lighter-colored monitor.
- To help maintain the best image quality on your monitor, use a dynamically changing screen saver and turn off your monitor when not in use.

# Setting up the monitor

## Attaching the stand

- ✎ **NOTE:** The stand is not installed at the factory when shipped.
- ✎ **NOTE:** The following instructions are applicable only for attaching the stand that was shipped with your monitor. If you are attaching a stand that you purchased from any other source, follow the set up instructions that were included with the stand.
- ⚠ **CAUTION:** The steps are important to protect your curved screen. Do follow the instructions below to finish up the installation.

To attach the monitor stand:

1. After opening the box, remove the foam cushion from the top of the package.

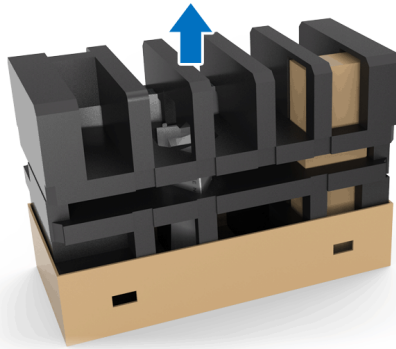

2. Invert the foam cushion and place it on a flat surface.

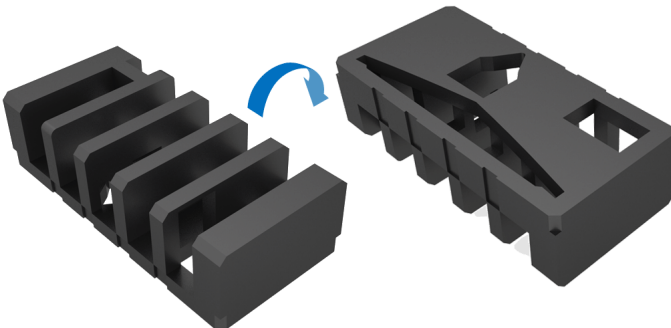



**3.** Gently lift up the monitor by holding it firmly on both sides.



**4.** Place the monitor on the foam and lift the cover from the monitor.



5. Place the monitor on the foam with the screen facing down.

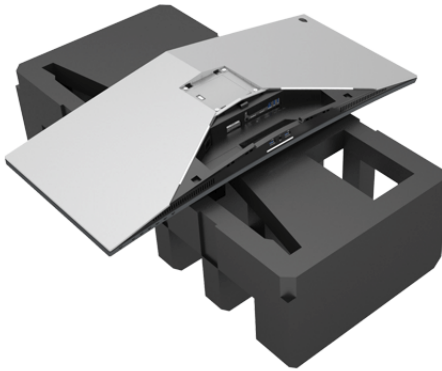

6. Attach the stand riser till it snaps into place.

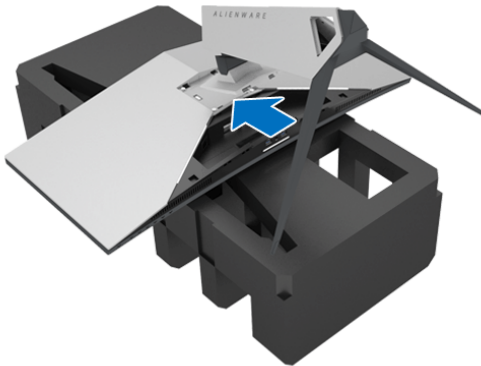

7. Connect the necessary cables to the monitor, as shown in the illustration, and route the cables through the cable-management slot on the stand riser.
  - a. Power cable
  - b. DisplayPort cable or Mini-DisplayPort to DisplayPort cable
  - c. HDMI cable (optional, cable not included)
  - d. USB upstream cable
  - e. USB downstream cables (optional, cable not included)

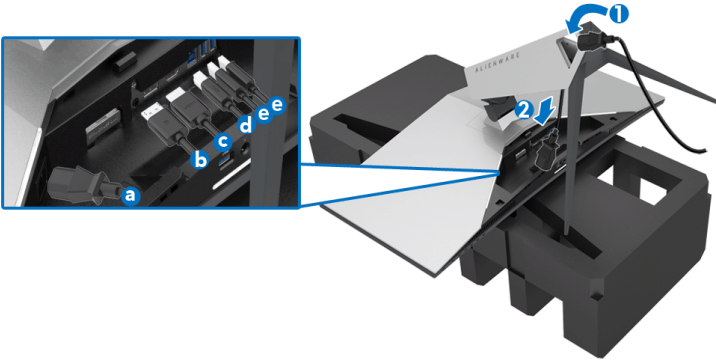

**NOTE:** Route each cable neatly so that the cables will be organized after the I/O cover is attached.

**WARNING:** Do not plug-in power cable to the wall outlet or turn on the monitor until you are instructed to do so.

8. Slide the I/O cover till it snaps into place.

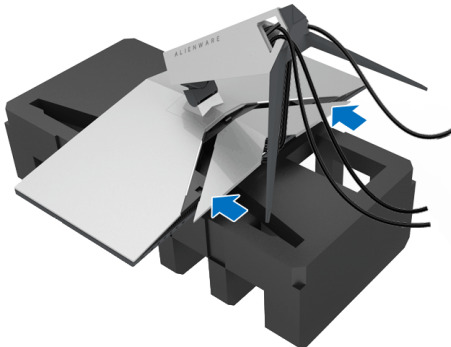

**NOTE:** Ensure that the cables are free from obstruction and pass through the I/O cover and cable-management slot on the stand riser.

## Connecting the computer

**⚠ WARNING:** Before you begin any of the procedures in this section, follow the [Safety instructions](#).

**🔪 NOTE:** Do not connect all cables to the computer at the same time.

To connect your monitor to the computer:

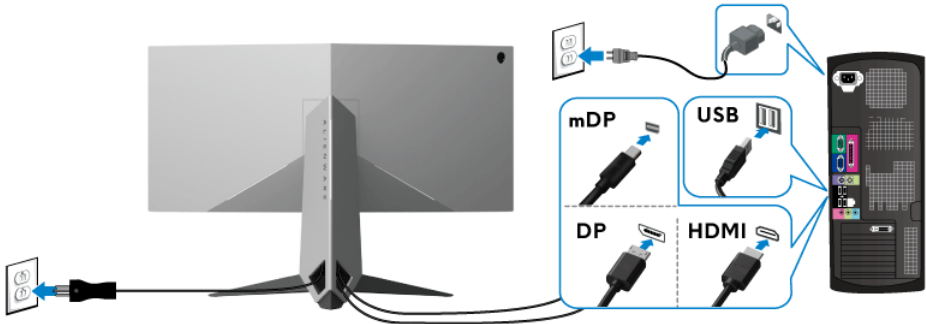



1. Connect the other end of the connected DisplayPort (or Mini-DisplayPort to DisplayPort), or HDMI cable to your computer.
2. Connect the upstream USB 3.0 port (cable supplied) to an appropriate USB 3.0 port on your computer. (See [Rear and bottom view](#) for details.)
3. Connect the USB 3.0 peripherals to the downstream USB 3.0 ports on the monitor.
4. Plug the power cables for your computer and monitor into a nearby outlet.
5. Turn On the monitor and the computer.

If your monitor displays an image, installation is complete. If it does not display an image, see [Universal Serial Bus \(USB\) specific problems](#).

**🔪 NOTE:** The graphics are used for the purpose of illustration only. Appearance of the computer may vary.

## Removing the monitor stand

-  **NOTE:** To prevent scratches on the LCD when removing the stand, ensure that the monitor is placed on a soft, clean surface.
-  **NOTE:** The following instructions are applicable only for attaching the stand that was shipped with your monitor. If you are attaching a stand that you purchased from any other source, follow the set up instructions that were included with the stand.

To remove the stand:

1. Turn off the monitor.
2. Disconnect the cables from the computer.
3. Place the monitor on a soft cloth or cushion.
4. Using your thumbs, apply gentle pressure on the I/O cover and slide it off from the monitor.

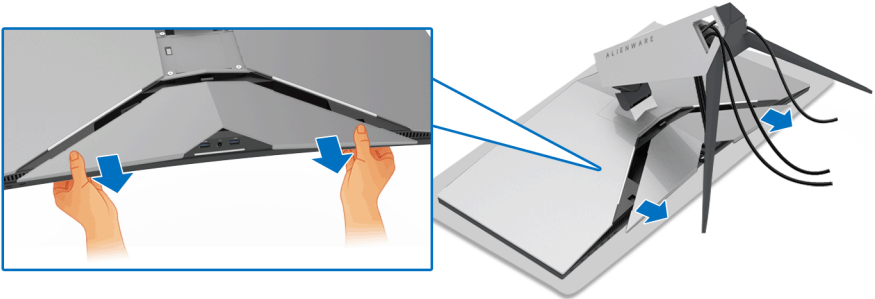

5. Disconnect the cables from the monitor and slide the cables through the cable-management slot on the stand riser.

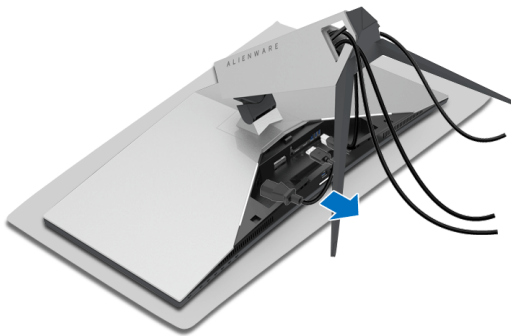

6. Press and hold the stand release button.

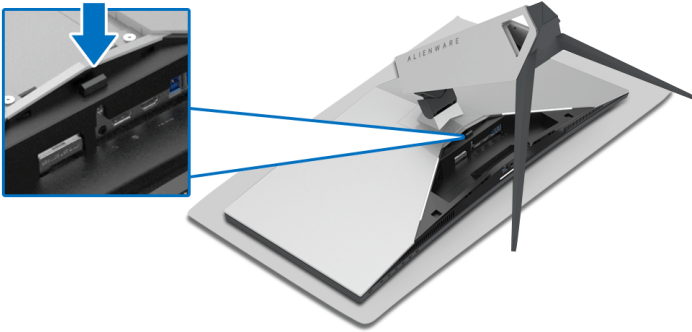

7. Lift the stand riser up and away from the monitor.



## VESA wall mounting (optional)

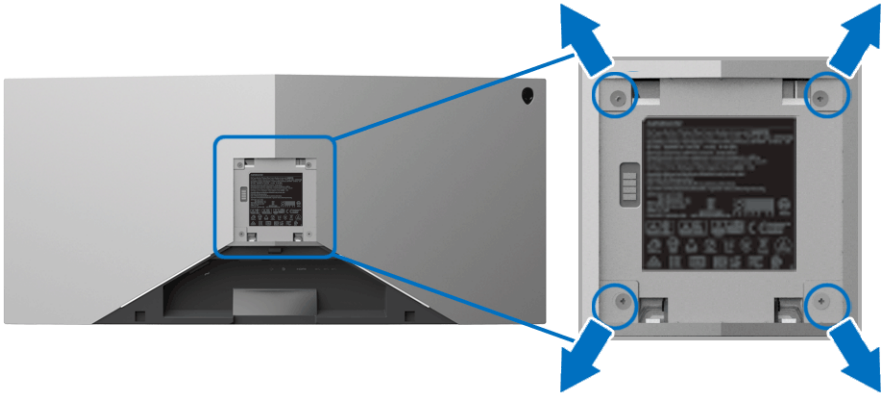

(Screw dimension: M4 x 10 mm).

Refer to the instructions that come with the VESA-compatible wall mounting kit.

1. Place the monitor panel on a soft cloth or cushion on a stable flat surface.
2. Remove the monitor stand. (See [Removing the monitor stand.](#))
3. Use a Phillips crosshead screwdriver to remove the four screws securing the plastic cover.
4. Attach the mounting bracket from the wall mounting kit to the monitor.
5. Mount the monitor on the wall. For more information, see the documentation that shipped with the wall mounting kit.

**NOTE:** For use only with UL-listed wall mount bracket with minimum weight or load bearing capacity of 29.1 kg (AW3418DW)/27.6 kg (AW3418HW).

# Operating the monitor

## Power on the monitor

Press the Power button to turn on the monitor.

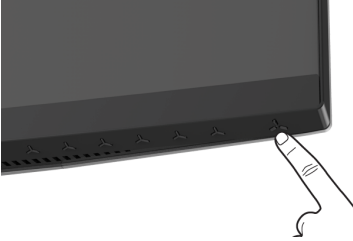



## Using the front-panel controls

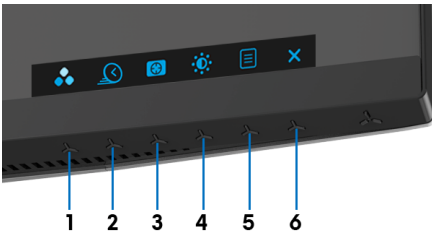

Use the control buttons on the front of the monitor to adjust settings.



The following table describes the front-panel buttons:

Front-panel button	Description
1  Shortcut key/ Preset Modes	Use this button to choose from a list of preset color modes.
2  Shortcut key/ Overclock Refresh Rate	Use this button to launch the <b>Overclock Refresh Rate</b> menu.
3  Shortcut key/ Dark Stabilizer	Use this button to launch the <b>Dark Stabilizer</b> menu.





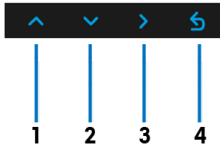

4	 <b>Shortcut key/ Brightness/ Contrast</b>	Use this button to directly access the <b>Brightness/Contrast</b> menu.
5	 <b>Menu</b>	Use the <b>MENU</b> button to launch the On-Screen Display (OSD). See <a href="#">Accessing the menu system</a> .
6	 <b>Exit</b>	Use this button to exit the OSD main menu.

### Front-panel button

Use the buttons on the front of the monitor to adjust the image settings.



Front-panel button	Description
1  <b>Up</b>	Use the <b>Up</b> button to adjust (increase ranges) items in the OSD menu.
2  <b>Down</b>	Use the <b>Down</b> button to adjust (decrease ranges) items in the OSD menu.
3  <b>Select</b>	Use the <b>Select</b> button to confirm your selection.
4  <b>Back</b>	Use the <b>Back</b> button to go back to the previous menu.





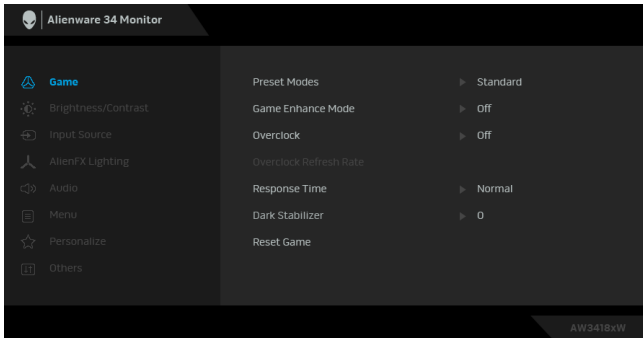

# Using the On-Screen Display (OSD) menu

## Accessing the menu system

**NOTE:** If you change the settings and then either proceed to another menu or exit the OSD menu, the monitor automatically saves those changes. The changes are also saved if you change the settings and then wait for the OSD menu to disappear.

1. Press the  button to launch the OSD menu and display the main menu.



2. Press the  and  buttons to move between the setting options. As you move from one icon to another, the option name is highlighted. See the following table for a complete list of all the options available for the monitor.
3. Press the  button once to activate the highlighted option.
4. Press the  and  buttons to select the desired parameter.
5. Press  to enter the submenu and then use the directional buttons, according to the indicators on the menu, to make your changes.
6. Select the  button to return to the main menu.

**Icon****Menu and submenus****Description****Game**

Use this menu to personalize your visual gameplay experience.

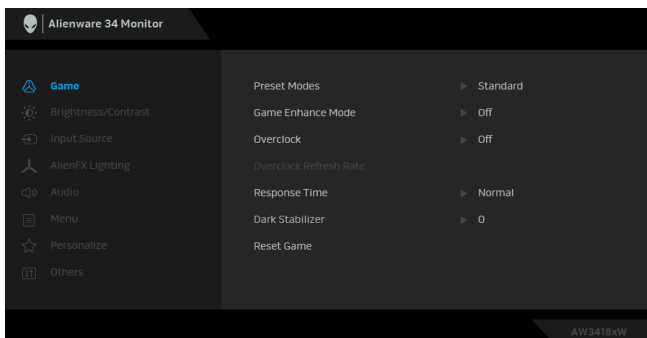

**Preset Modes** Allows you to choose from a list of preset color modes.

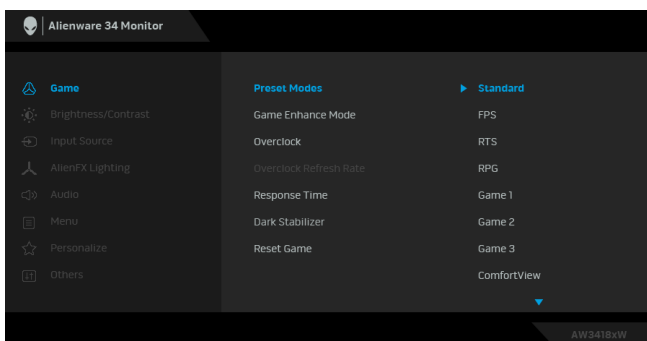

- **Standard:** Loads the monitor's default color settings. This is the default preset mode.
- **FPS:** Loads color settings ideal for First-Person Shooter games.
- **RTS:** Loads color settings ideal for Real-Time Strategy games.
- **RPG:** Loads color settings ideal for Role-Playing games.
- **Game 1/Game 2/Game 3:** Allows you to customize the color settings for your gaming needs.

- 
- Preset Modes** • **ComfortView:** Decreases the level of blue light emitted from the screen to make viewing more comfortable for your eyes.

**WARNING: The possible long-term effects of blue light emission from the monitor may cause personal injury such as digital eye strain, eye fatigue and damage to the eyes. Using monitor for extended periods of time may also cause pain in parts of body such as neck, arm, back and shoulder.**

To reduce the risk of eye strain and neck/arm/back/shoulder pain from using the monitor for long periods of time, we suggest you to:

1. Set the distance of the screen between 20 inches to 28 inches (50cm-70cm) from your eyes.
  2. Blink frequently to moisten your eyes or wet your eyes with water after prolonged usage of the monitor.
  3. Take regular and frequent breaks for 20 minutes every two hours.
  4. Look away from your monitor and gaze at a distant object at 20 feet away for at least 20 seconds during the breaks.
  5. Perform stretches to relieve tension in the neck, arm, back, and shoulders during the breaks.
- **Warm:** Increases the color temperature. The screen appears warmer with a red/yellow tint.
  - **Cool:** Decreases the color temperature. The screen appears cooler with a blue tint.
  - **Custom Color:** Allows you to manually adjust the color settings. Press the  and  buttons to adjust the three colors (R, G, B) values and create your own preset color mode.
-

---

## Game Enhance Mode

The feature offers three available functions to enhance your gameplay experience.

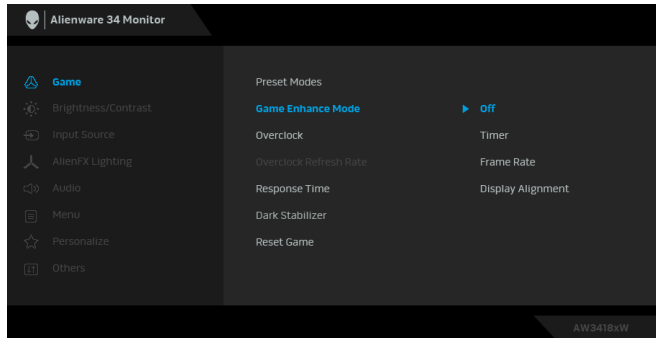

- **Off**

Select to disable the functions under **Game Enhance Mode**.

- **Timer**

Allows you to disable or enable the timer at the upper left corner of the display. The timer shows the time elapsed since the game starts. Select an option from the time-interval list to measure your target game rate.

- **Frame Rate**

Selecting **On** allows you to display the current frames per second when playing games. The higher the rate, the smoother the motion appears.

- **Display Alignment**

Activate the function to help ensure the perfect alignment of the video contents from multiple displays.

---

## Overclock

Allows you to operate the monitor at a higher refresh rate than specified by the panel specification.

**NOTE:** This function is only available when using DP (DisplayPort) input.

**NOTE:** Overclocking may cause screen flickering. To reduce such effects, try to setting a lower refresh rate in the



**Overclock Refresh Rate** menu.

---

---

## Overclock Refresh Rate

The function increases your displays refresh rate.

Use  or  to adjust the frequency in 5 Hz increments, from 105 to 120 Hz (for AW3418DW) or 150 to 160 Hz (for AW3418HW).

After you specify the refresh rate, the following message appears to guide you through the process:

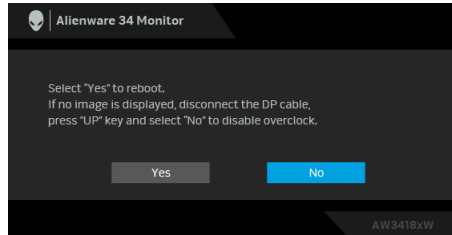

**NOTE:** This function is only available when **Overclock** is enabled.

**NOTE:** Overclocking may cause screen flickering. To reduce such effects, try to setting a lower refresh rate.

---

**Response Time** Allows you to set the **Response Time** to **Normal**, **Fast** or **Super Fast**.

---

**Dark Stabilizer** The feature improves the visibility in the dark gaming scenarios. The higher the value (between 0 to 3), the better visibility in dark area of the display image.

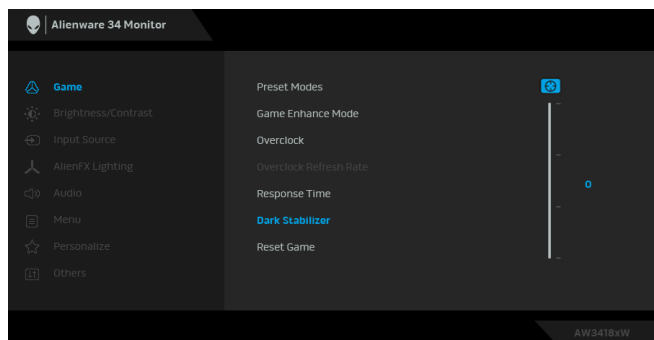

---

**Reset Game** Select this option to restore default game settings.

---





## Brightness/ Contrast

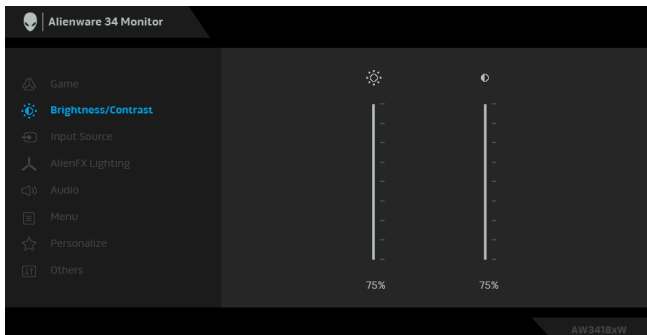

Use this menu to activate **Brightness/Contrast** adjustment.



**Brightness** **Brightness** adjusts the luminance of the backlight.

Press the  button to increase the brightness and press the  button to decrease the brightness (min. 0 / max. 100).

**Contrast** Adjust the **Brightness** first, and then adjust the **Contrast** only if further adjustment is necessary.

Press the  button to increase the contrast and press the  button to decrease the contrast (min. 0 / max. 100).

The **Contrast** function adjusts the degree of difference between darkness and lightness on the monitor screen.



**Input Source** Use the **Input Source** menu to select between the different video signals that may be connected to your monitor.

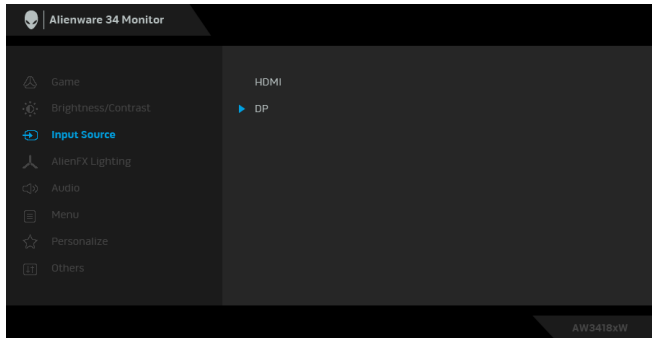

---

**HDMI** Select the **HDMI** input when you are using the HDMI connector.

---

**DP** Select the **DP** input when you are using the DisplayPort (DP) connector.

---





## AlienFX Lighting

Use this menu to adjust the Alienware logo lighting, Triad lights on the back and stand of the monitor, downlights on the bottom of the monitor, and the power button.

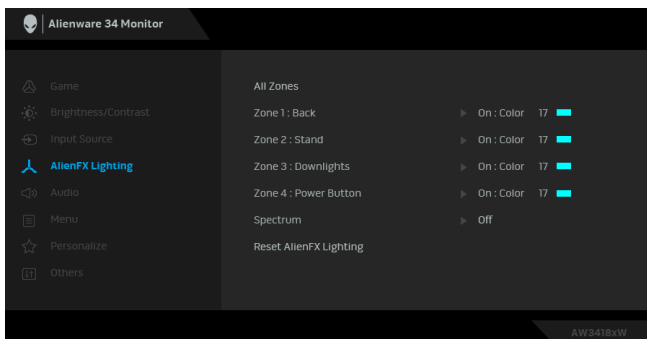

Before making any adjustments, select any or all of these 4 zones from the submenus. The illustration below indicates the lighting zones.

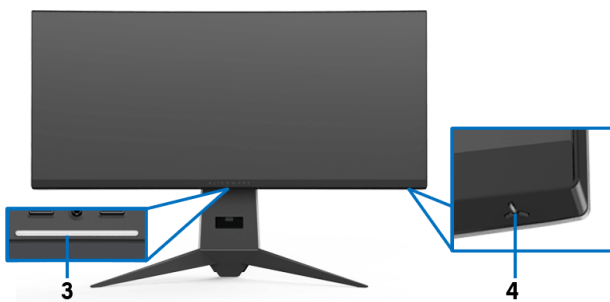
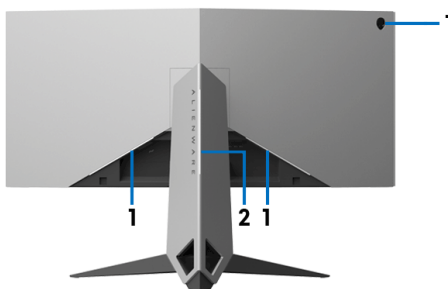

---

## All Zones

### Zone 1: Back



### Zone 2: Stand

### Zone 3: Downlights

### Zone 4: Power Button

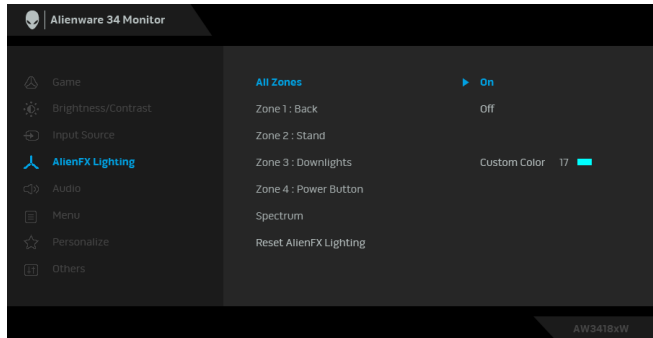
To specify an LED lighting color for the selected area, select **On** and press the  button to highlight the **Custom Color** option.



Then make a selection from the list of 20 available colors by using the  and  buttons.

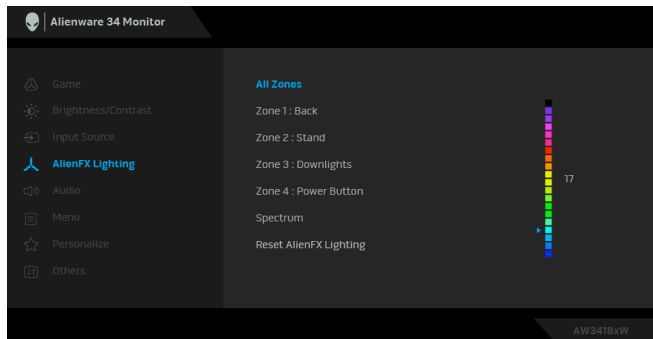

---

The following table depicts the color number and the RGB codes used for the 20 LED colors.

No.	R	G	B
1	0	0	0
2	100	0	240
3	144	0	240
4	240	0	240
5	240	0	176
6	240	0	112
7	240	0	0
8	240	80	0
9	240	128	0
10	240	224	0
11	120	240	0
12	160	240	0
13	100	245	35
14	0	240	0
15	0	240	85
16	70	240	145
17	0	240	240
18	0	160	240
19	0	96	240
20	0	0	240

To turn off the AlienFX lights, select **Off**.

**NOTE:** These functions are only available when **Spectrum** is disabled.

---

---

## Spectrum

When you select **On**, the AlienFX lights of 4 zones glow and change colors in sequence of spectrum: red, orange, yellow, green, blue, indigo, and violet.

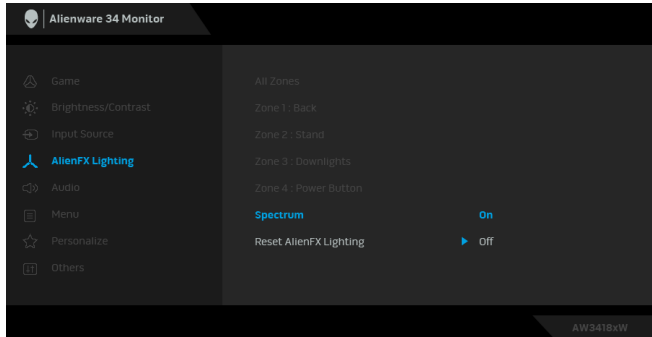

**NOTE:** When the function is **On**, the functions above are deactivated.

---

## Reset AlienFX Lighting

Select this option to restore default lighting settings.



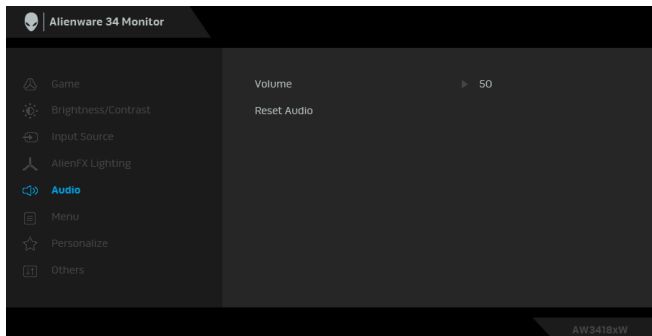

## Audio



---

## Volume

Allows you to set the volume level of headphone output.

Use  or  to adjust the volume level from 0 to 100.

---

## Reset Audio

Select this option to restore default audio settings.

---



## Menu

Select this option to adjust the settings of the OSD, such as, the languages of the OSD, the amount of time the menu remains on screen, and so on.

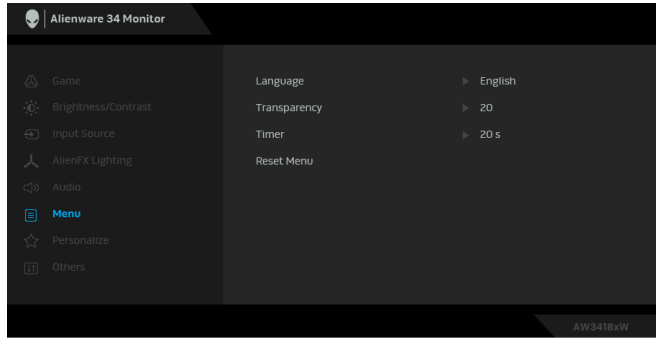

---

**Language** Set the OSD display to one of the eight languages (English, Spanish, French, German, Brazilian Portuguese, Russian, Simplified Chinese, or Japanese).

---

**Transparency** Select this option to change the menu transparency by pressing the and buttons (min. 0 / max. 100).

---

**Timer** Sets the length of time the OSD will remain active after the last time you pressed a button.  
Use or to adjust the slider in 1 second increments, from 5 to 60 seconds.

---

**Reset Menu** Reset all OSD settings to the factory preset values.

---



## Personalize

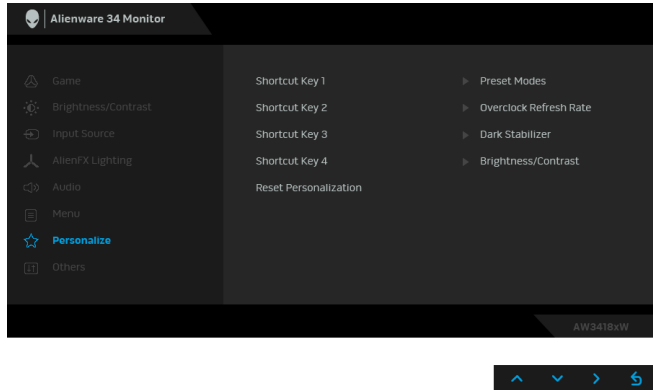

- Shortcut Key 1** Allows you to choose a feature from **Preset Modes**,
- Shortcut Key 2** **Overclock Refresh Rate**, **Dark Stabilizer**, **Brightness/Contrast**, **Game Enhance Mode**, **Input Source**, or **Volume**
- Shortcut Key 3** and set it as a shortcut key.
- Shortcut Key 4**

**Reset Personalization** Restores shortcut keys to factory defaults.



## Others

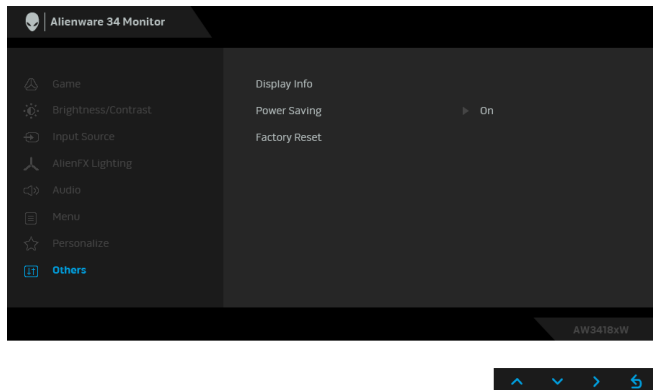

**Display Info** Displays the monitor's current settings.

**Power Saving** The default setting is **On**, letting the monitor go to sleep as the system sleeps. Selecting **Off** may prevent the monitor from going into deep sleep and being unable to wake up.

**NOTE:** Pressing any button (except the Power button) on the front panel of the monitor may also wake up the monitor after it goes into deep sleep.

**Factory Reset** Reset all settings to the factory preset values.

## OSD warning message

When the monitor enters the **Power Saving** mode, the following message appears:

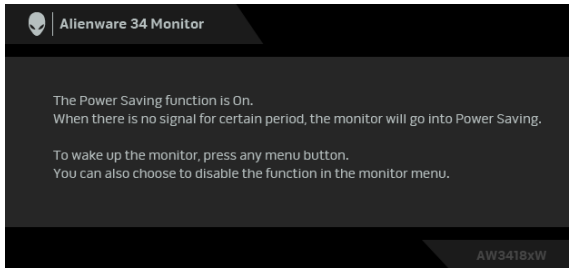

See [Troubleshooting](#) for more information.

## Setting the maximum resolution

To set the maximum resolution for the monitor:

In Windows 7, Windows 8, and Windows 8.1:

1. For Windows 8 and Windows 8.1 only, select the Desktop tile to switch to classic desktop.
2. Right-click on the desktop and click **Screen Resolution**.
3. Click the Dropdown list of the Screen Resolution and select **3440 x 1440** (for AW3418DW) or **2560 x 1080** (for AW3418HW).
4. Click **OK**.

In Windows 10:

1. Right-click on the desktop and click **Display settings**.
2. Click **Advanced display settings**.
3. Click the dropdown list of **Resolution** and select **3440 x 1440** (for AW3418DW) or **2560 x 1080** (for AW3418HW).
4. Click **Apply**.

If you do not see 3440 x 1440 or 2560 x 1080 as an option, you may need to update your graphics driver. Depending on your computer, complete one of the following procedures:

If you have a Dell desktop or a laptop:

- Go to [www.dell.com/support](http://www.dell.com/support), enter your service tag, and download the latest driver for your graphics card.

If you are using a non-Dell computer (laptop or desktop):

- Go to the support site for your computer and download the latest graphic drivers.
- Go to your graphics card website and download the latest graphic drivers.

## Using the tilt, swivel, and vertical extension

**NOTE:** The following instructions are applicable only for attaching the stand that was shipped with your monitor. If you are attaching a stand that you purchased from any other source, follow the set up instructions that were included with the stand.

### Tilt, swivel

With the stand attached to the monitor, you can tilt and swivel the monitor for the most comfortable viewing angle.

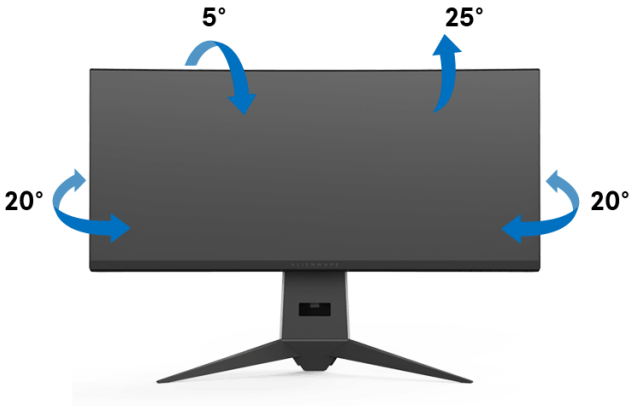

**NOTE:** The stand is not installed at the factory when shipped.



## Vertical extension

 **NOTE:** The stand extends vertically up to 130 mm. The figure below illustrates how to extend the stand vertically.



# Troubleshooting

**⚠ WARNING:** Before you begin any of the procedures in this section, follow the [Safety instructions](#).

## Self-test

Your monitor provides a self-test feature that allows you to check whether your monitor is functioning properly. If your monitor and computer are properly connected but the monitor screen remains dark, run the monitor self-test by performing the following steps:

1. Turn off both your computer and the monitor.
2. Unplug the video cable from the back of the computer. To ensure proper Self-Test operation, remove all digital cables from the back of computer.
3. Turn on the monitor.

**✍ NOTE:** A dialog box should appear on-screen (against a black background), if the monitor cannot sense a video signal and is working correctly. While in self-test mode, the power LED blinks white.

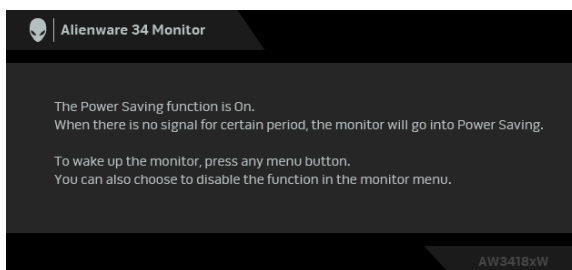

**✍ NOTE:** This box also appears during normal system operation, if the video cable is disconnected or damaged.

4. Turn Off your monitor and reconnect the video cable; then turn On both your computer and the monitor.

If your monitor screen remains blank after you use the previous procedure, check your video controller and computer, because your monitor is functioning properly.

## Built-in diagnostics

Your monitor has a built-in diagnostic tool that helps you determine if the screen abnormality you are experiencing is an inherent problem with your monitor, or with your computer and video card.

 **NOTE: You can run the built-in diagnostics only when the video cable is unplugged and the monitor is in self-test mode.**

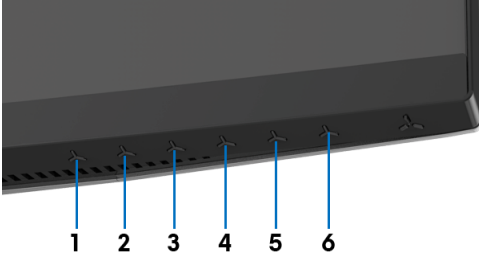

To run the built-in diagnostics:

1. Ensure that the screen is clean (no dust particles on the surface of the screen).
2. Unplug the video cable(s) from the back of the computer or monitor. The monitor then goes into the self-test mode.
3. Press and hold **Button 3** for 5 seconds. A gray screen appears.
4. Carefully inspect the screen for abnormalities.
5. Press **Button 3** again. The color of the screen changes to red.
6. Inspect the display for any abnormalities.
7. Repeat steps 5 and 6 to inspect the display in green, blue, black, and white screens.

The test is complete when the white screen appears. To exit, press **Button 3** again.

If you do not detect any screen abnormalities upon using the built-in diagnostic tool, the monitor is functioning properly. Check the video card and computer.

## Common problems

The following table contains general information about common monitor problems you might encounter and the possible solutions:

Common symptoms	What you experience	Possible solutions
No Video/ Power LED off	No picture	<ul style="list-style-type: none"><li>Ensure that the video cable connecting the monitor and the computer is properly connected and secure.</li><li>Verify that the power outlet is functioning properly using any other electrical equipment.</li><li>Ensure that the power button is depressed fully.</li><li>Ensure that the correct input source is selected in the <b>Input Source</b> menu.</li></ul>
No Video/ Power LED on	No picture or no brightness	<ul style="list-style-type: none"><li>Increase brightness &amp; contrast controls via OSD.</li><li>Perform monitor self-test feature check.</li><li>Check for bent or broken pins in the video cable connector.</li><li>Run the built-in diagnostics.</li><li>Ensure that the correct input source is selected in the <b>Input Source</b> menu.</li></ul>
Poor Focus	Picture is fuzzy, blurry, or ghosting	<ul style="list-style-type: none"><li>Eliminate video extension cables.</li><li>Reset the monitor to factory settings.</li><li>Change the video resolution to the correct aspect ratio.</li></ul>
Shaky/Jittery Video	Wavy picture or fine movement	<ul style="list-style-type: none"><li>Reset the monitor to factory settings.</li><li>Check environmental factors.</li><li>Relocate the monitor and test in another room.</li></ul>
Missing Pixels	LCD screen has spots	<ul style="list-style-type: none"><li>Cycle power On-Off.</li><li>Pixel that is permanently Off is a natural defect that can occur in LCD technology.</li><li>For more information on Dell Monitor Quality and Pixel Policy, see Dell support site: <b><a href="http://www.dell.com/support/monitors">www.dell.com/support/monitors</a></b>.</li></ul>
Stuck-on Pixels	LCD screen has bright spots	<ul style="list-style-type: none"><li>Cycle power On-Off.</li><li>Pixel that is permanently off is a natural defect that can occur in LCD technology.</li><li>For more information on Dell Monitor Quality and Pixel Policy, see Dell support site: <b><a href="http://www.dell.com/support/monitors">www.dell.com/support/monitors</a></b>.</li></ul>

Brightness Problems	Picture too dim or too bright	<ul style="list-style-type: none"> <li>Reset the monitor to factory settings.</li> <li>Adjust brightness &amp; contrast controls via OSD.</li> </ul>
Geometric Distortion	Screen not centered correctly	<ul style="list-style-type: none"> <li>Reset the monitor to factory settings.</li> </ul>
Horizontal/Vertical Lines	Screen has one or more lines	<ul style="list-style-type: none"> <li>Reset the monitor to factory settings.</li> <li>Perform monitor self-test feature check and determine if these lines are also in self-test mode.</li> <li>Check for bent or broken pins in the video cable connector.</li> <li>Run the built-in diagnostics.</li> </ul>
Synchronization Problems	Screen is scrambled or appears torn	<ul style="list-style-type: none"> <li>Reset the monitor to factory settings.</li> <li>Perform monitor self-test feature check to determine if the scrambled screen appears in self-test mode.</li> <li>Check for bent or broken pins in the video cable connector.</li> <li>Restart the computer in the <i>safe mode</i>.</li> </ul>
Safety Related Issues	Visible signs of smoke or sparks	<ul style="list-style-type: none"> <li>Do not perform any troubleshooting steps.</li> <li>Contact Dell immediately.</li> </ul>
Intermittent Problems	Monitor malfunctions on & off	<ul style="list-style-type: none"> <li>Ensure that the video cable connecting the monitor to the computer is connected properly and is secure.</li> <li>Reset the monitor to factory settings.</li> <li>Perform monitor self-test feature check to determine if the intermittent problem occurs in self-test mode.</li> </ul>
Missing Color	Picture missing color	<ul style="list-style-type: none"> <li>Perform monitor self-test feature check.</li> <li>Ensure that the video cable connecting the monitor to the computer is connected properly and is secure.</li> <li>Check for bent or broken pins in the video cable connector.</li> </ul>

Wrong Color	Picture color not good	<ul style="list-style-type: none"> <li>Change the settings of the <b>Preset Modes</b> in the <b>Game</b> menu OSD depending on the application.</li> <li>Adjust R/G/B value under <b>Custom Color</b> in <b>Game</b> menu OSD.</li> <li>Run the built-in diagnostics.</li> </ul>
Image retention from a static image left on the monitor for a long period of time	Faint shadow from the static image displayed appears on the screen	<ul style="list-style-type: none"> <li>Use the Power Management feature to turn off the monitor at all times when not in use (for more information, see <a href="#">Power management modes</a>).</li> <li>Alternatively, use a dynamically changing screensaver.</li> </ul>

## Product specific problems

Specific symptoms	What you experience	Possible solutions
Screen image is too small	Image is centered on screen, but does not fill entire viewing area	<ul style="list-style-type: none"> <li>Reset the monitor to factory settings.</li> </ul>
Cannot adjust the monitor with the buttons on the front panel	OSD does not appear on the screen	<ul style="list-style-type: none"> <li>Turn Off the monitor, unplug the power cord, plug it back, and then turn On the monitor.</li> </ul>
No Input Signal when user controls are pressed	No picture, the LED light is blue	<ul style="list-style-type: none"> <li>Check the signal source. Ensure the computer is not in the power saving mode by moving the mouse or pressing any key on the keyboard.</li> <li>Check whether the signal cable is plugged in properly. Re-plug the signal cable if necessary.</li> <li>Reset the computer or video player.</li> </ul>
The picture does not fill the entire screen	The picture cannot fill the height or width of the screen	<ul style="list-style-type: none"> <li>Due to different video formats (aspect ratio) of DVDs, the monitor may display in full screen.</li> <li>Run the built-in diagnostics.</li> </ul>

## Universal Serial Bus (USB) specific problems

Specific symptoms	What you experience	Possible solutions
USB interface is not working	USB peripherals are not working	<ul style="list-style-type: none"><li>▪ Check that your monitor is turned On.</li><li>▪ Reconnect the upstream cable to your computer.</li><li>▪ Reconnect the USB peripherals (downstream connector).</li><li>▪ Switch Off and then turn On the monitor again.</li><li>▪ Reboot the computer.</li><li>▪ Some USB devices like external portable HDD require higher electric current; connect the device directly to the computer system.</li></ul>
High Speed USB 3.0 interface is slow	High Speed USB 3.0 peripherals working slowly or not working at all	<ul style="list-style-type: none"><li>▪ Check that your computer is USB 3.0-capable.</li><li>▪ Some computers have USB 3.0, USB 2.0, and USB 1.1 ports. Ensure that the correct USB port is used.</li><li>▪ Reconnect the upstream cable to your computer.</li><li>▪ Reconnect the USB peripherals (downstream connector).</li><li>▪ Reboot the computer.</li></ul>
Wireless USB peripherals stop working when a USB 3.0 device is plugged in	Wireless USB peripherals responding slowly or only working as the distance between itself and its receiver decreases	<ul style="list-style-type: none"><li>▪ Increase the distance between the USB 3.0 peripherals and the wireless USB receiver.</li><li>▪ Position your wireless USB receiver as close as possible to the wireless USB peripherals.</li><li>▪ Use a USB-extender cable to position the wireless USB receiver as far away as possible from the USB 3.0 port.</li></ul>

# Appendix

## **WARNING: Safety instructions**

 **WARNING: Use of controls, adjustments, or procedures other than those specified in this documentation may result in exposure to shock, electrical hazards, and/or mechanical hazards.**

For information on safety instructions, see the Safety, Environmental, and Regulatory Information (SERI).

## **FCC notices (U.S. only) and other regulatory information**

For FCC notices and other regulatory information, see the regulatory compliance website located at [www.dell.com/regulatory\\_compliance](http://www.dell.com/regulatory_compliance).

## **Contact Dell**

**For customers in the United States, call 800-WWW-DELL (800-999-3355).**

 **NOTE: If you do not have an active Internet connection, you can find contact information on your purchase invoice, packing slip, bill, or Dell product catalog.**

**Dell provides several online and telephone-based support and service options. Availability varies by country and product, and some services may not be available in your area.**

- Online technical assistance — [www.dell.com/support/monitors](http://www.dell.com/support/monitors)
- Contacting Dell — [www.dell.com/contactdell](http://www.dell.com/contactdell)