

SR61B

Cordless Scanner

SR61B, SR61BNI



User's Guide

Intermec Technologies Corporation

Worldwide Headquarters

6001 36th Ave.W.

Everett, WA 98203

U.S.A.

www.intermec.com

The information contained herein is provided solely for the purpose of allowing customers to operate and service Intermec-manufactured equipment and is not to be released, reproduced, or used for any other purpose without written permission of Intermec Technologies Corporation.

Information and specifications contained in this document are subject to change without prior notice and do not represent a commitment on the part of Intermec Technologies Corporation.

© 2009-2012 by Intermec Technologies Corporation. All rights reserved.

The word Intermec, the Intermec logo, Norand, ArciTech, Beverage Routebook, CrossBar, dcBrowser, Duratherm, EasyADC, EasyCoder, EasySet, Fingerprint, i-gistics, INCA (under license), Intellitag, Intellitag Gen2, JANUS, LabelShop, MobileLAN, Picolink, Ready-to-Work, RoutePower, Sabre, ScanPlus, ShopScan, Smart Mobile Computing, SmartSystems, TE 2000, Trakker Antares, and Vista Powered are either trademarks or registered trademarks of Intermec Technologies Corporation.

There are U.S. and foreign patents as well as U.S. and foreign patents pending.

Document Change Record

This page records changes to this document. The document was originally released as Revision 001.

Version Number	Date	Description of Change
002	3/2009	Revised to support hardware and software for release 2. Updates included new cables and data transmission settings.
003	8/2010	Revised to support all new SR61B models (SR61B1D-xxx, SR61BL-xxx, SR61BHP-xxx, and SR61BXR-xxx, SR61BDPM). Version 002 of this document remains valid for legacy models (SR61BVxxxx, SR61BAxxxx, SR61BLxxxx and SR61BExxxx).
004	10/2012	Updated reading distances to reflect extended reading range, added full HID support and DPM.

Contents

Document Change Record.....	iii
Before You Begin.....	viii
Safety Information.....	viii
Global Services and Support.....	viii
Warranty Information.....	viii
Web Support.....	ix
Send Feedback.....	ix
Telephone Support.....	ix
Service Location Support.....	ix
Who Should Read This Manual.....	x
Related Documents.....	x
Patent Information.....	xi

1 Introducing the SR61B Cordless Scanner.....	1
What is the SR61B Cordless Scanner.....	2
Charging the Battery.....	3
Checking the Battery Status.....	3
Turning On the SR61B.....	4
Understanding the SR61B Behavior.....	5
Intermec-Ready-to-Work Indicator.....	5
Status Light.....	6
Beeps and Vibrate Alert.....	7
Using Vibrate Alert.....	7
Scanning Bar Codes.....	8
Accessories.....	12
Required Accessories.....	12
SR61 Desktop/Wall Mount 1-Bay Charger.....	12
SR61 2-Bay, 4-Bay, or 8-Bay Charger.....	12
Optional Accessories.....	13
SD61 Base Station.....	13
Dangle Suspension.....	14
Belt Holster.....	14
SR61 Wrist Strap.....	15

2	Connecting the SR61B	17
	Introducing SR61B Bluetooth Connections	18
	Out of Range Behavior	19
	Connecting the SR61B to an Intermec Computer	19
	Connecting the SR61B to an Intermec SD61 Base Station	20
	Connecting the SR61B to Other Bluetooth Devices	21
	HID Bluetooth Device Connection	21
	Pairing and Connecting as an HID Bluetooth Device.....	21
	SPP Bluetooth Device Connection.....	23
	Pairing as an SPP Bluetooth Device.....	24
	Connecting from your Host as an SPP Bluetooth Device	25
	Connecting from your Scanner as an SPP Bluetooth Device	26
	Connecting the SR61B as a Keyboard Wedge	27
3	Configuring the SR61B	31
	Basic Setup with Configuration Bar Codes	32
	Resetting Your Scanner.....	32
	Setting an International Keyboard.....	32
	Configuring Your Scanner with EasySet.....	35
	Online Setup with EasySet.....	35
	Offline Setup with EasySet	36
	Configuring your Scanner From Your Intermec Computer	36
4	Troubleshooting and Maintaining the SR61B	39
	Troubleshooting the SR61B.....	40
	Calling Product Support	40
	Problems and Possible Solutions	41
	Maintaining the SR61B.....	44
	Upgrading the SR61B	44
	Cleaning the SR61B.....	52
	Recovering the SR61B	53
	Resetting the SR61B	53

Rescuing the SR61B.....53

A Specifications and Reading Distances 55

Specifications.....56

Reading Distances59

 SR61B1D60

 SR61BL61

 SR61BHP62

 SR61BXR63

 SR61BDPM64

Before You Begin

This section provides you with safety information, technical support information, and sources for additional product information.

Safety Information

Your safety is extremely important. Read and follow all warnings and cautions in this document before handling and operating Intermec equipment. You can be seriously injured, and equipment and data can be damaged if you do not follow the safety warnings and cautions.

This section explains how to identify and understand dangers, warnings, cautions, and notes that are in this document. You may also see icons that tell you when to follow ESD procedures and when to take special precautions for handling optical parts.



A warning alerts you of an operating procedure, practice, condition, or statement that must be strictly observed to avoid death or serious injury to the persons working on the equipment.



A caution alerts you to an operating procedure, practice, condition, or statement that must be strictly observed to prevent equipment damage or destruction, or corruption or loss of data.



Note: Notes either provide extra information about a topic or contain special instructions for handling a particular condition or set of circumstances.

Global Services and Support

Warranty Information

To understand the warranty for your Intermec product, visit the Intermec web site at www.intermec.com and click **Support > Returns and Repairs > Warranty**.

Web Support

Visit the Intermec web site at www.intermec.com to download our current manuals (in PDF).

Visit the Intermec technical knowledge base (Knowledge Central) at www.intermec.com and click **Support > Knowledge Central** to review technical information or to request technical support for your Intermec product.

Send Feedback

Your feedback is crucial to the continual improvement of our documentation. To provide feedback about this manual, please contact the Intermec Technical Communications department directly at TechnicalCommunications@intermec.com.

Telephone Support

In the U.S.A. and Canada, call **1-800-755-5505**.

Outside the U.S.A. and Canada, contact your local Intermec representative. To search for your local representative, from the Intermec web site, click **About Us > Contact Us**.

Service Location Support

For the most current listing of service locations, go to www.intermec.com and click **Support > Returns and Repairs > Repair Locations**.

For technical support in South Korea, use the after service locations listed below:

AWOO Systems

102-1304 SK Ventium

522 Dangjung-dong

Gunpo-si, Gyeonggi-do Korea, South 435-776

Contact: Mr. Sinbum Kang

Telephone: +82-31-436-1191

E-mail: mjyun@awoo.co.kr

IN Information System PTD LTD
6th Floor
Daegu Venture Center Bldg 95
Shinchun 3 Dong
Donggu, Daegu City, Korea
E-mail: jmyou@idif.co.kr or korlim@gw.idif.co.kr

Who Should Read This Manual

This *SR61B Cordless Scanner User's Guide* is for the person who is responsible for installing, configuring, and maintaining the SR61B Cordless Scanner.

This *SR61B Cordless Scanner User's Guide* provides you with information about the features of the SR61B Cordless Scanner, and how to install, configure, operate, maintain, and troubleshoot them.

Before you work with the SR61B Cordless Scanner, you should be familiar with your network and general networking terms, such as IP address.

Related Documents

The Intermec web site at www.intermec.com contains our documents (as .pdf files) that you can download for free.

To download documents

- 1** Visit the Intermec web site at www.intermec.com.
- 2** Click the **Products** tab.
- 3** Using the **Products** menu, navigate to your product page. For example, to find the CN3 computer product page, click **Computers > Handheld Computers > CN3**.
- 4** Click the **Manuals** tab.

If your product does not have its own product page, click **Support > Manuals**. Use the **Product Category** field, the **Product Family** field, and the **Product** field to help you locate the documentation for your product.

Patent Information

There may be U.S. and foreign patents pending.

Before You Begin

1

Introducing the SR61B Cordless Scanner

Use this chapter to familiarize yourself with the SR61B Cordless Scanner. This chapter covers these topics:

- **What is the SR61B Cordless Scanner**
- **Charging the Battery**
- **Turning On the SR61B**
- **Understanding the SR61B Behavior**
- **Scanning Bar Codes**
- **Accessories**

What is the SR61B Cordless Scanner

The SR61B Cordless Scanner is a rugged purpose-built handheld scanner with an ergonomic design. It uses a Bluetooth™ radio for RF communications.

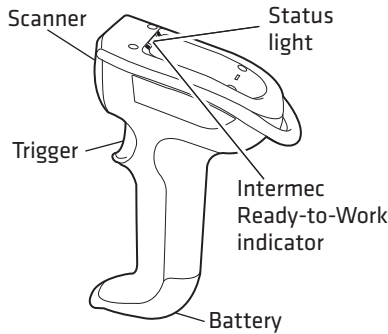

SR61B Cordless Scanner

The SR61B is available in the following models:

- 1D linear imager—SR61B1D-xxx
- Laser scanner—SR61BL-xxx
- Extra range area imager—SR61BXR-xxx
- High performance 2D area imager—SR61BHP-xxx
- High Density / DPM—SR61BDPM-xxx

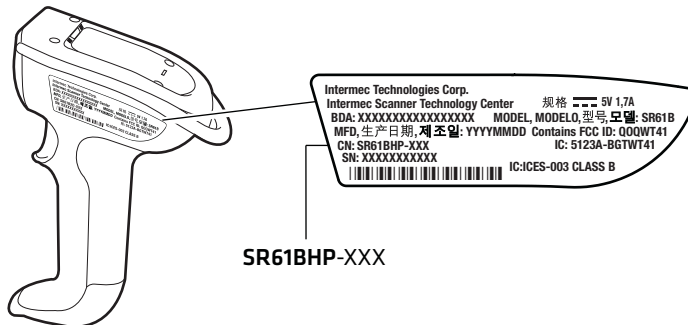

SR61B Scan Engine Option: The scan engine option of your SR61B is the first part of the configuration number. In this illustration, the model is SR61BHP-XXX for 2D area imager.

For more information about the scanner options, see [“Scanning Bar Codes” on page 8](#).

Charging the Battery



The SR61B uses a lithium-ion battery as its main power source. You need to fully charge the battery before you can use the SR61B.

The battery pack used in this device may ignite, create a chemical burn hazard, explode, or release toxic materials if mistreated. Do not incinerate, disassemble, or heat above 100°C (212°F). Charge only with Intermec Models AC5, AC6, AC7, and AC8 (see [“SR61 2-Bay, 4-Bay, or 8-Bay Charger” on page 12](#)). Do not short circuit; may cause burns. Keep away from children.

Use only Intermec battery pack Model AB3 (P/N 075082-xxx). Use of incorrect battery pack may present risk of fire or explosion. Promptly dispose of used battery pack according to the instructions.

Make sure you fully charge the battery before you start using the SR61B.

To charge the battery

- Place the SR61B with the battery installed in the desktop/wall mount 1-bay charger (AC5).
- Or,
- Remove the battery from the SR61B, and insert the battery into the 2-bay, 4-bay, or 8-bay (AC6, AC7, or AC8) charger.

For more information, see [“Required Accessories” on page 12](#).

Checking the Battery Status

The SR61B status light automatically displays a low battery signal (blinking red) when less than 20% of the battery capacity remains. If so, you need to charge the battery.

Status light signals are different when the scanner is docked in a charger. For more information, see [“Status Light” on page 6](#).

Turning On the SR61B

The following procedure describes how to turn on the SR61B.

To turn on the SR61B

- Pull and release the trigger.

The SR61B beeps 2 times and vibrates at power-up by default.

It enters a discoverable state and remains discoverable for about 5 minutes (before automatically shutting off, can be configured). While the SR61B is discoverable and in communications range, your host Bluetooth device can discover your SR61B and establish a Bluetooth connection.

If your SR61B is already connected to a Bluetooth device (blue Intermec Ready-to-Work indicator on), it is not discoverable.

Understanding the SR61B Behavior

The SR61B uses lights, beeps and vibrations to indicate if a bar code has been successfully decoded. The lights and beeps described in this section are new and do not correspond to the legacy SR61B models (SR61BV, SR61BA, SR61BL or SR61BE).



Note: If you prefer to use the legacy beep and LED mode you can activate the legacy mode using EasySet. For information on using EasySet see [“Configuring Your Scanner with EasySet” on page 35](#).

Intermec-Ready-to-Work Indicator

The Intermec-Ready-to-Work indicator [™] (blue LED) gives information about the Bluetooth connection. When a connection has been established the light is always on (blue) unless the scanner is docked in a charge base. In this case the blue light turns off even though the Bluetooth connection is still active.

Blue Intermec Ready-to-Work Indicator

Light State	What it Means
Off	A Bluetooth connection has not been established. OR Scanner is docked in a charge base.
Blinking, slow	The scanner is trying to establish a Bluetooth connection with a Bluetooth device.
Blinking, fast	The scanner is awaiting user acknowledgement in a pairing procedure.
On	A Bluetooth connection to the base station or host computer is established. The SR61B is ready to scan bar codes and send data.

When using your scanner to scan bar codes (blue light on) your scanner will also flash status information using green or red lights. See the Status Light information in the next section.



Note: By default the Intermec Ready-to-Work light is enabled however you can disable the light if desired. You can also change the color. See EasySet version 5. 6. 5. 4. for more information.

Status Light

The status light flashes green or red to indicate the status of the scanner and/or battery. Status information is sometimes shown even if the Intermec Ready-to-Work Indicator is on. This way the scanner can communicate more than one type of information at the same time.

For example while the blue LED is on to show that there is a Bluetooth connection, the scanner will flash green when you have successfully scanned a bar code.

Default Status Light Description

Light State	What it Means
Green light on for 2 seconds	The scanner successfully decoded a bar code and sent the data to the host.
Green light flashes 2 times	A configuration bar code was successfully read.
Red light on for 2 seconds	Transmission error OR Configuration bar code was not accepted
Red, blinking slow	Battery power is low (< 20% - need to charge).
Red, on (only when docked)	The scanner is charging.
Green, on (only when docked)	Battery is fully charged.
Red, blinking fast	Battery fault.

Beeps and Vibrate Alert

The SR61B beeps to give you audio feedback and vibrates when performing some functions. For example, you hear a beep each time you scan a valid bar code.

Default SR61B Beep and Vibrate Alert Descriptions

Beep Sequence	What it Means
Single beep	The SR61B successfully scanned a bar code.
Two fast beeps and vibrates	Power-up.
Two fast beeps	The SR61B successfully scanned a configuration bar code
Two beeps, bitonal	The SR61B is docked correctly in the SR61B Charge Base.
Six very fast beeps	Transmission error OR Configuration bar code was not accepted
Series of beeps from low to high	The SR61B is connecting to a Bluetooth host.
Series of beeps from high to low	The SR61B is disconnecting from a Bluetooth host. Note: The scanner does not beep when disconnecting automatically after a long period of inactivity.
Six-beep melody	Scanner confirmation after rescue procedure (see “Rescuing the SR61B” on page 53).

Using Vibrate Alert

You can configure the SR61B to vibrate when it successfully decodes a bar code. This feature can be useful in these situations:

- You are in a noisy environment, such as a busy warehouse, where it can be difficult to hear the beep.
- You are working in a quiet environment, such as a library, where you do not want to make a lot of noise.

To turn on vibrate alert

- Scan this bar code:

Turn On Vibrate Alert



To turn off vibrate alert

- Scan this bar code:

Turn Off Vibrate Alert



Note: For more vibrate alert functions such as error vibrate alert, see EasySet version 5.6.5.4 or later.

Scanning Bar Codes



Warning

For the SR61BL, SR61BXR, SR61BHP, SR61BDPM do not look directly into the window area or at a reflection of the laser beam or laser aiming beam while the laser is scanning. Long-term exposure to the laser beam can damage your vision.

The SR61B contains either a 1D linear imager (SR61B1D), 2D area imager (SR61BHP, SR61BDPM), laser scan engine (SR61BL), or near-far range area imager (SR61BXR) to scan bar code data. The type of scan engine you are using and the type of bar code you are decoding determines the way you scan the bar code.

When you unpack the SR61B, these bar code symbologies are enabled:

- Code 39
- Code 128 / GS1-128
- EAN/UPC
- PDF417 (SR61BL, SR61BHP, SR61BDPM and SR61BXR only)
- DataMatrix (SR61BHP, SR61BDPM and SR61BXR only)

If you are using bar code labels that are encoded in a different symbology, you need to enable the symbology on your SR61B. Use EasySet version 5.6.5.3 or later to enable and disable symbologies for your scanner. EasySet is available on the Intermec web site at www.intermec.com.

Before you can scan bar codes and send data to your data collection application, you need to establish a Bluetooth connection between your SR61B and the host device. If your scanner is not connected it will emit an error beep when scanning bar codes. For more information about establishing a Bluetooth connection, see **“Connecting the SR61B” on page 17.**

To scan a bar code label with an SR61BL or SR61B1D

- 1 Turn on your scanner by pressing the trigger.
- 2 Connect your scanner to a Bluetooth device.
- 3 Point the SR61B at the bar code label and hold the SR61B at a slight angle 5 to 10 cm (2 to 4 in) from the label.
- 4 Pull the trigger, and direct the red beam so that it falls across all bars in the bar code label.

Use this test bar code:

Code 39 Test Bar Code



123456

Tip: Depending on your screen resolution, you may be able to scan bar codes displayed on your computer screen except with SR61BL (laser imager). Print out and scan bar codes with the SR61BL.

When the SR61B successfully reads a bar code label, the SR61B beeps one time, the status light briefly turns green, and the scanner beam turns off. If Vibrate Alert is enabled, the SR61B briefly vibrates.

- 5 Release the trigger.

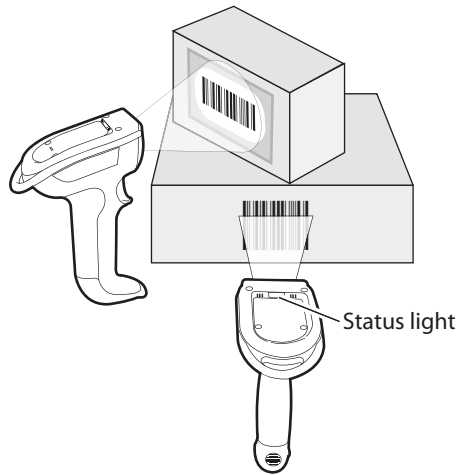

Scanning Bar Codes: The aiming and scanner beams that you see depend on which SR61B model you are using.

To scan omni-directionally with the SR61BHP, SR61BDPM or SR61BXR

- 1** Point the scanner window at the bar code label and hold the SR61B steady a few inches from the label.
- 2** Pull the trigger.
 - If you are scanning with one of the 2D imagers, use the laser framing to position the imager over the bar code or area to capture.

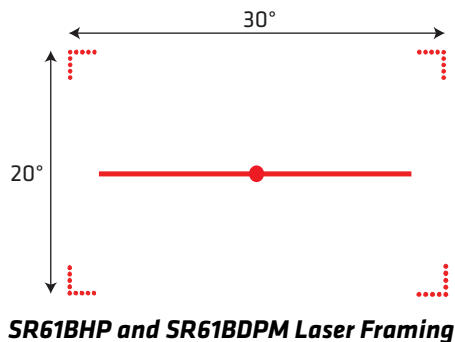

SR61BHP and SR61BDPM Laser Framing

- If you are scanning with a near-far range area imager (SR61BXR) at a near distance (< 30 cm / 11.8 in), position the red aiming beam just to the right of the center of the bar code label.

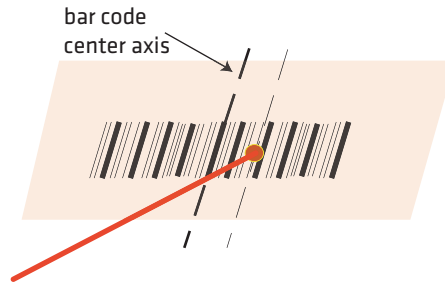

SR61BXR Aiming Beam

- 3** When the SR61B successfully reads a bar code label, the SR61B beeps one time, the status light briefly turns green, and the scanner lighting turns off. If Vibrate Alert is enabled, the SR61B briefly vibrates.
- 4** Release the trigger.

Accessories

There are several different accessories available. Here you will find a list of required and optional accessories.

Required Accessories

You will need one of the following chargers for your SR61B.

SR61 Desktop/Wall Mount 1-Bay Charger

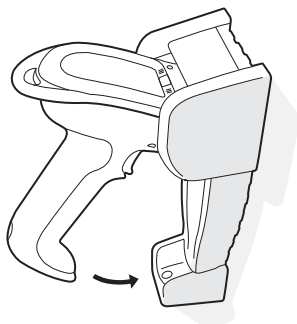

SR61 Desktop/Wall Mount 1-Bay Charger (P/N 825-901-xxx): Used to charge the scanner without removing the battery.

SR61 2-Bay, 4-Bay, or 8-Bay Charger

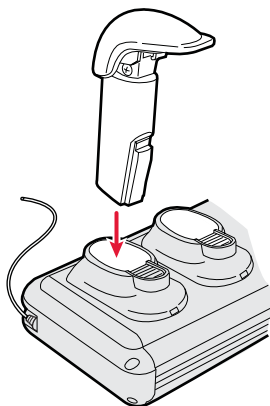

SR61 2-Bay, 4-Bay, or 8-Bay Charger P/N 852-907-xxx, 852-908-xxx or 852-902-xxx: Used to charge up to 8 AB3 batteries (P/N 075082-xxx) that powers the scanner.

Optional Accessories

The following accessories are optional.

SD61 Base Station

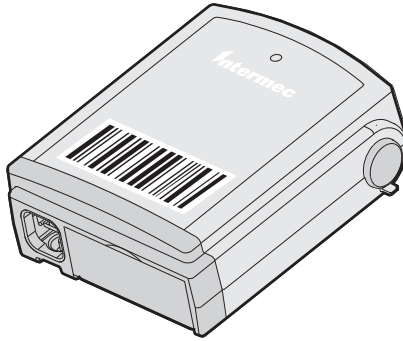

SD61 Base Station (P/N 3-231019-xxx): The SD61 Base Station is used to connect up to seven Intermec cordless Bluetooth™ scanners to a non-Bluetooth host device.

Dangle Suspension

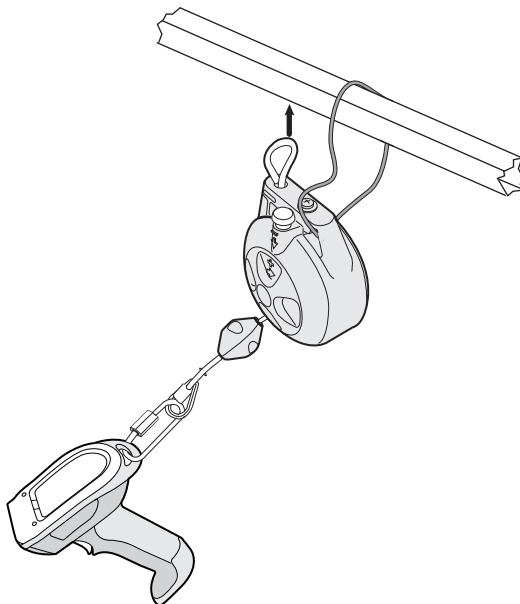

SR61 Dangle Suspension (P/N 825-181-xxx): The dangle suspension provides you with a convenient way to secure the scanner to your vehicle or work station.

Belt Holster

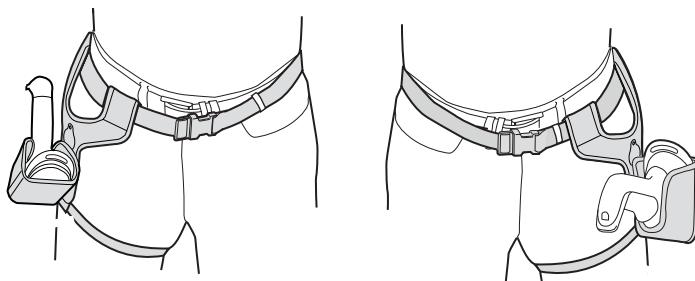

SR61 Belt Holster (P/N 825-179-xxx): The belt holster (P/N 825-179-xxx) provides you with a convenient way to carry the scanner when you are not using it.

SR61 Wrist Strap

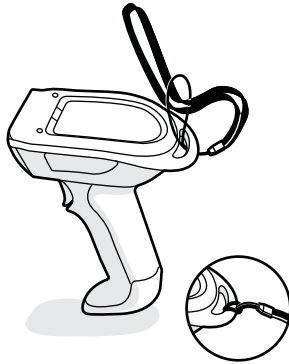

SR61 Wrist Strap: P/N 825-184-xxx: The wrist strap provides you with a convenient way to keep the scanner securely hanging from your wrist when you're not using it.

2

Connecting the SR61B

Use this chapter to understand how to connect the SR61B to a number of Bluetooth devices. This chapter covers these topics:

- **Introducing SR61B Bluetooth Connections**
- **Connecting the SR61B to an Intermec Computer**
- **Connecting the SR61B to an Intermec SD61 Base Station**
- **Connecting the SR61B to Other Bluetooth Devices**
- **Connecting the SR61B as a Keyboard Wedge**

Introducing SR61B Bluetooth Connections

You can use Bluetooth radio communications to connect up to seven SR61B scanners to the following devices:

- Intermec computers that are Bluetooth-enabled
- Intermec SD61 Base Station
- Other Bluetooth-enabled devices that support Serial Port Profile (SPP) or Human Interface Device Profile (HID)

The SR61B can also be connected as a keyboard wedge to a Bluetooth-enabled host PC via an Intermec software, SmartWedgeLite™.

Before connecting the SR61B to a host device, note the Bluetooth address for the:

- Host Bluetooth device
- SR61B

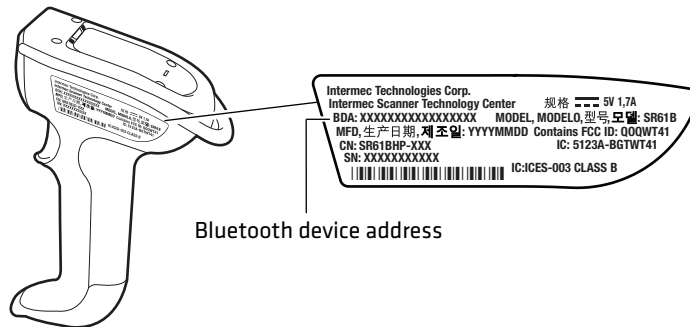

Bluetooth device address

SR61B Bluetooth Address: The SR61B Bluetooth address is located on the scanner label.

To connect to a host device, you may need to install EasySet, the Intermec configuration application that allows you to change settings on the SR61B. For the SR61B, you need EasySet version 5.6.5.3 or later. You can download EasySet at no charge from the Intermec web site at www.intermec.com.

Out of Range Behavior

If the Bluetooth connection is lost (out of range, scanner battery too low, etc.) the scanner will automatically try to reconnect once the problem is resolved (back in to range, recharge scanner battery, etc.). If you try to read a bar code while the scanner is disconnected from the host, the scanner will emit an error beep.

Connecting the SR61B to an Intermec Computer



Note: When you first connect to an Intermec computer, only SR61B settings common to the Intermec computer's internal scanner settings are changed to the internal scanner's default settings.

- 1 Turn on the SR61B by pulling the trigger.
- 2 Scan the Bluetooth association bar code label that ships with your Intermec computer. If you do not have a Bluetooth association bar code label for your Intermec computer, use EasySet to create a Bluetooth connect bar code. For help, see the EasySet software.

Tip: Depending on your screen resolution, you may be able to scan this bar code displayed on your computer screen.

The SR61B beeps twice, the green status light flashes twice, and the blue Intermec Ready-to-Work™ indicator starts blinking. On your Intermec computer, the Authen. Request dialog box appears.



- 3 In the **Enter PIN** field, enter the default PIN (0000) and select **OK**.

When the SR61B connects to your Intermec computer, the SR61B emits a series of beeps from low to high, and the blue Intermec Ready-to-Work indicator turns on and stays on. The SR61B is ready to scan data.

- 4 Repeat Steps 1 to 3 to connect up to seven scanners to the Intermec computer.



Note: You can also use the Intermec Bluetooth Scanner Wizard on the Intermec computer. For help, see the documentation for your Intermec computer.

Connecting the SR61B to an Intermec SD61 Base Station

You can connect up to seven Intermec Bluetooth scanners to the SD61 Base Station.

To connect up to 7 scanners

- 1 Connect the SD61 base station to a host device using the correct cable for your interface (see the *SD61 Base Station User's Guide* available on our web site at www.intermec.com).
- 2 With an Intermec Bluetooth scanner, scan the association bar code on the top of the SD61 Base Station. If you do not have a Bluetooth association bar code label for your base station, use EasySet to create a Bluetooth connect bar code. For help, see the EasySet software.

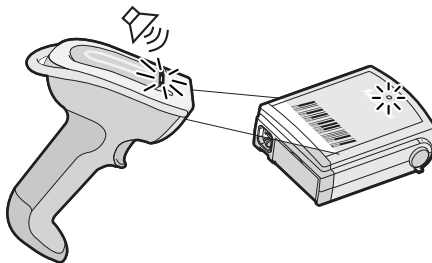

The scanner beeps twice, the green status light flashes twice and the blue Intermec Ready-to-Work indicator starts blinking. When the scanner connects to the base station it emits a series of beeps from low to high. The blue Intermec Ready-to-Work indicator turns on and stays on for both the scanner and base station.

- 3 To add more scanners, repeat steps 1 and 2.

Connecting the SR61B to Other Bluetooth Devices

The cordless SR61B scanner can communicate with a host device through the Bluetooth communications Human Interface Device Profile (HID) and Serial Port Profile (SPP).

HID Bluetooth Device Connection

With the HID profile, your SR61B is recognized as a keyboard. Connection information is stored, meaning that if the scanner loses connection (out of range, low battery, etc.), it will try to reconnect as soon as possible (back into range, charged battery, etc.). Moreover, no specific software is needed in HID profile as opposed to SPP profile to collect data. HID profile is available with software version BF4_252 and later.

Before trying to pair and connect your scanner, make sure:

- it is not already trying to establish a Bluetooth connection. If so, the blue Intermec Ready-to-Work indicator blinks; read the Bluetooth device disconnect bar code.

Bluetooth Device Disconnect



- it is not already paired with your Bluetooth device. If so, remove it from your host's Bluetooth devices list.
- your host is set to allow Bluetooth device connections.

Pairing and Connecting as an HID Bluetooth Device

This section describes how to pair and connect your scanner from your host PC.

To pair and connect as an HID Bluetooth device

- 1 Turn on your scanner by pulling the trigger.

- 2 Scan the Bluetooth device profile - HID configuration bar code
Bluetooth Device Profile - HID



- 3 Double-click the Bluetooth icon on your task bar. The Bluetooth Devices listing all paired devices window appears.
- 4 Click on the command for adding a Bluetooth device (**Add** or **Add a device** depending on operating systems). The wizard for adding Bluetooth devices appears.
- 5 Follow the on screen instructions until your host searches for Bluetooth devices. The SR61B scanner appears in the Bluetooth device list as a keyboard in the following format: SR61B - *BDA*, where *BDA* is the scanner's Bluetooth Device Address.

You can find the BDA on the scanner's label.



Note: If the scanner does not appear in the list, it might be already paired with the host. Under some operating systems, already paired Bluetooth devices do not appear in the Bluetooth device search list.

- 6 Select your scanner and validate.
- 7 If a PIN is required (depending on your host operating system and Bluetooth version), enter the default Bluetooth PIN (0000) and validate.



Note: A pairing confirmation can be enabled. If so, the blue Intermec Ready-to-Work indicator starts blinking rapidly at this stage, indicating that the scanner is awaiting acknowledgement. Pull the trigger to complete the pairing procedure.

Your scanner automatically connects to the host: it emits a series of beeps from low to high, and the blue Intermec Ready-to-Work indicator turns solid blue.

SPP Bluetooth Device Connection

The SPP profile allows your SR61B to use the Bluetooth link as a serial port to communicate with your host device. If you are using an application working with serial ports, you do not need to modify it to collect data with the SR61B.

Before connecting your scanner you must first pair it to your host. Then you can connect your scanner to your host by initiating the Bluetooth connection either from your SR61B scanner (*incoming* connection) or from your host (*outgoing* connection):

- A scanner-initiated connection (*incoming*) requires reading a Bluetooth association bar code then opening the incoming port from an application such as a terminal emulation program.

The advantage of this method is that the scanner automatically tries to reconnect to the host each time the connection is lost.

This method is recommended for collecting data in your data collection software.

- A host-initiated connection (*outgoing*) requires opening the outgoing port from an application such as EasySet or a terminal emulation program.

The advantage of this method is that no Bluetooth association bar code is required. However, if the connection with the host is lost, you must re-connect using the connection procedure.

This method is recommended for setting up your scanner online using EasySet.

Before trying to pair or connect your scanner, make sure:

- it is not already trying to establish a Bluetooth connection. If so, the blue Intermec Ready-to-Work indicator blinks; read the Bluetooth device disconnect bar code.

Bluetooth Device Disconnect



- it is not already paired with your Bluetooth device. If so, remove it from your host's Bluetooth devices list or skip the pairing step.
- your host is set to allow Bluetooth device connections.

Pairing as an SPP Bluetooth Device

This section describes how to pair your scanner from your host PC.

To pair as an SPP Bluetooth device

- 1 Turn on your scanner by pulling the trigger.
- 2 Scan the Bluetooth device profile - SPP configuration bar code.
Bluetooth Device Profile - SPP (*)



- 3 Double-click the Bluetooth icon on your task bar. The Bluetooth Devices window appears.
- 4 Click on the command for adding a Bluetooth device (**Add** or **Add a device** depending on operating systems). The wizard for adding Bluetooth devices appears.
- 5 Follow the on screen instructions until your host searches for Bluetooth devices. The SR61B scanner appears in the Bluetooth device list in the following format: SR61B - *BDA*, where *BDA* is the scanner's Bluetooth Device Address.

You can find the BDA on the scanner's label.



Note: If the scanner does not appear in the list, it might be already paired with the host. Under some operating systems, paired devices do not appear in the Bluetooth device search list.

- 6 Select your scanner and validate.
- 7 If a PIN is required (depending on your host operating system and Bluetooth version), enter the default Bluetooth PIN (0000) and validate.



Note: A pairing confirmation can be enabled. If so, the blue Intermec Ready-to-Work indicator starts blinking rapidly at this stage, indicating that the scanner is awaiting acknowledgement. Pull the trigger to complete the pairing procedure.

Your scanner is now paired with your host. Two virtual Standard serial ports over Bluetooth link (incoming and outgoing) are created.

- 8 Note the **COM** port numbers and port type (incoming, outgoing) for example by opening the Bluetooth settings from the Bluetooth icon in the taskbar or the operating system **Device Manager**.

Connecting from your Host as an SPP Bluetooth Device

This section describes how to perform a host-initiated connection, for example prior to setting up your scanner online using EasySet.

To connect from the host

- 1 Once your scanner is paired with your host, turn it on by pulling the trigger. Make sure it is set as an SPP Bluetooth device.
- 2 Start EasySet version 5.6.5.3 or later. Make sure that SR61B is selected as your product.
- 3 Select **Communication** > **Select communication interface**. The Device Selection dialog box appears.
- 4 Select the outgoing COM port (Standard Serial over Bluetooth link) that you noted at the end of the pairing procedure and click **OK**.
- 5 Depending on the time elapsed since your last connection or if your scanner has been reset since pairing, a pop-up might appear, indicating that a Bluetooth device is trying to connect.
- 6 If so, click on the pop-up. A window appears asking for the pairing code. Enter the default Bluetooth PIN (0000) and validate.

When the scanner connects to your host PC, it emits a series of beeps from low to high, and the blue Intermec Ready-to-Work indicator turns solid blue.

- 7 To disconnect from EasySet, select **Communication** > **Disconnect**.

When the scanner disconnects from your host PC, it emits a series of beeps from high to low, and the blue Intermec Ready-to-Work indicator turns off.



Note: You can also connect your scanner to your host from any terminal emulation program by opening the required port.

Connecting from your Scanner as an SPP Bluetooth Device

This section describes how to perform a scanner-initiated connection, for example prior to collecting data.

To connect from the scanner

- 1 Once your scanner is paired, turn it on by pulling the trigger. Make sure it is set as an SPP Bluetooth device.
- 2 Start EasySet version 5.6.5.3 or later. Make sure that SR61B is selected as your product.
- 3 Select the **Interface > Bluetooth > Connect/disconnect** folder.
- 4 Double-click on the **Compose BT address** command. A **Bluetooth - Connect/disconnect - Compose BT address** window opens.
- 5 Compose your host Bluetooth Device Address (BDA) and click **OK**. The Bluetooth association bar code is created.
- 6 Print and read the Bluetooth association bar code. The blue Intermec Ready-to-Work starts blinking.
- 7 Open the incoming port that you noted at the end of the pairing procedure, for example from a terminal emulation program.

When the scanner connects to your host PC, it emits a series of beeps from low to high, and the blue Intermec Ready-to-Work indicator turns solid blue.
- 8 To disconnect, close the incoming port.

When the scanner disconnects from your host PC, it emits a series of beeps from high to low, and the blue Intermec Ready-to-Work indicator turns off. The LED starts blinking.

Connecting the SR61B as a Keyboard Wedge

You can connect your SR61B to your host PC in SPP profile as a keyboard wedge using a dedicated Intermec software, SmartWedgeLite.

Connecting as a keyboard wedge lets your host PC receive data from the SR61B as it would from a keyboard. This can be useful if you do not want to set your scanner as an HID Bluetooth device and still collect data in your business applications.

Before connecting your scanner using SmartWedgeLite, make sure:

- your host PC is Bluetooth-enabled,
- your scanner is set as an SPP Bluetooth device,
- your host PC has SmartWedgeLite installed.



Note: You can download SmartWedgeLite at:

http://intermec.custhelp.com/app/answers/detail/a_id/13629

To connect your scanner as a keyboard wedge using SmartWedgeLite

- 1 Start SmartWedgeLite.

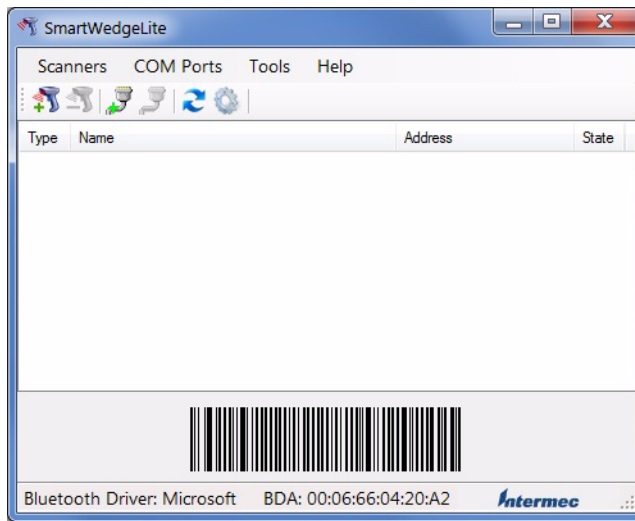

SmartWedgeLite main screen

A connection barcode appears at the bottom of the main screen based on your host Bluetooth device BDA (Bluetooth Device Address).

2 Connect your scanner either by:

- reading the association bar code displayed on the SmartWedgeLite application main screen with your scanner.

This is a scanner-initiated (or *incoming*) connection. If your scanner later loses connection to your host PC, it will automatically try to reestablish it.

- clicking on **Scanners > Add scanner** (or the  icon), then by choosing your scanner in the list of Bluetooth devices which opens or by checking **Type in manually the bluetooth address of my scanner** and entering your scanner BDA address.

Both methods are host-initiated (or *outgoing*) connections. If your scanner later loses connection to your host PC, you will need to follow this procedure again to reestablish Bluetooth connection.

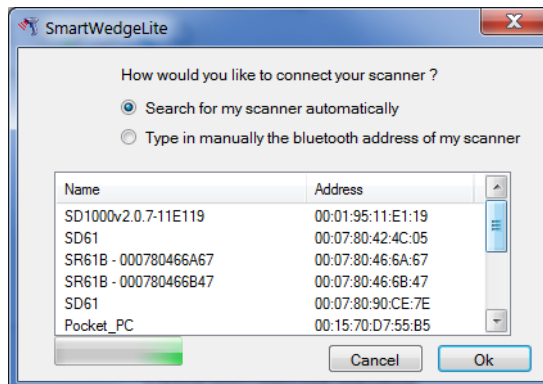

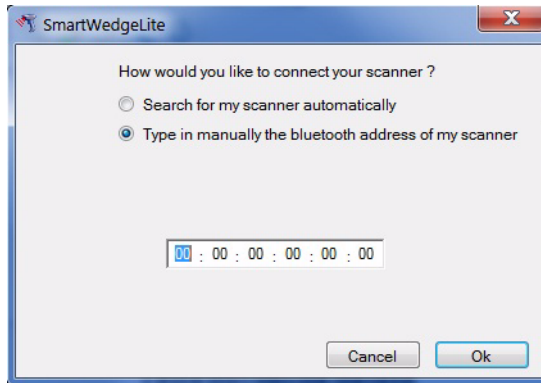

Host-initiated connection: Choosing your scanner in a list of detected Bluetooth devices



Host-initiated connection: Typing manually your scanner Bluetooth Device Address.

When the scanner connects to your host PC, it emits a series of beeps from low to high, the blue Intermec Ready-to-Work indicator turns solid blue and the scanner is added to your list of connected scanners.

An arrow indicates whether:

- the connection is incoming  or outgoing ,
- the connection is operational (green arrow) or in fault (red arrow).

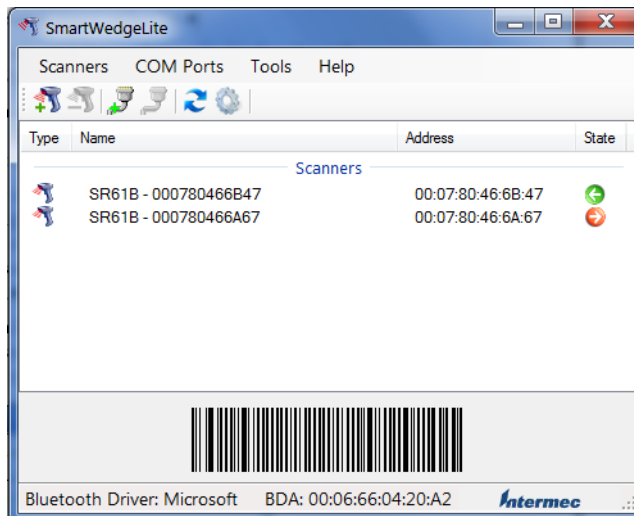

Connected scanners and connection statuses: Here, one operational incoming connection and one failing outgoing connection.

To disconnect your scanner, for example to connect it to an Intermeccomputer or to another Bluetooth-enabled host, click on **Scanners** > **Remove scanner** (or the  icon). You can also select the scanner in the list and press **Del**.



Note: For more information about SmartWedgeLite, see the application embedded help or online help at http://intermec.custhelp.com/app/answers/detail/a_id/13629/kw/smartwedgelite.

3

Configuring the SR61B

Use this chapter to understand how to configure the SR61B to communicate with your application. This chapter covers these topics:

- **Basic Setup with Configuration Bar Codes**
- **Configuring Your Scanner with EasySet**
- **Configuring your Scanner From Your Intermec Computer**

Basic Setup with Configuration Bar Codes

This section provides you with configuration bar codes for a basic setup of your scanner. It also gives the procedure for configuring your scanner offline or online using EasySet.

All default values are marked with (*).

Resetting Your Scanner

To reset your scanner, read the reset factory defaults configuration bar code.

Reset factory defaults



Setting an International Keyboard

By default the SR61B uses a North American keyboard layout. Use these configuration bar codes to select the keyboard for your country. Additional keyboards are available in EasySet (see [“Configuring Your Scanner with EasySet” on page 35](#)).

North American Windows (*)



French Windows



French Canadian Windows 95/98



French Canadian Windows XP/2000



German Windows



Spanish Windows



Italian Windows



UK English Windows



Japanese Windows



Brazilian Portuguese Windows



Czech Republic Windows



Slovakian Windows



Hungarian 101-key



Configuring the Postamble

The default postamble is <CR> <LF>. For certain applications or when using your scanner as an HID Bluetooth device you may need to change this setting. Use the following configuration bar codes to change the default postamble in your scanner.

Carriage Return + Line Feed (*)



None



Carriage Return



Enter



Configuring Your Scanner with EasySet

EasySet is an Intermec configuration application that provides you with two ways to configure your scanner.

- Online setup—send configuration commands from EasySet directly to the product.
- Offline setup—send configuration commands to a bar code setup sheet, print the setup sheet and use a connected scanner to scan the bar codes.

EasySet is available on the Intermec web site at www.intermec.com/EasySet. Simply download and install.

Online Setup with EasySet

Online setup with EasySet is available for your scanner only if it is connected to your host as an SPP Bluetooth device (*outgoing* connection).

To configure your scanner online by sending commands from EasySet

- 1 Connect the scanner as an SPP Bluetooth device to a host PC (see **“SPP Bluetooth Device Connection” on page 23**).
- 2 Start EasySet. The first time you start EasySet, the Select product dialog box appears.
If the Select product dialog box does not appear, choose **Product > Select** or click on the product icon in the upper left corner.
- 3 Select your product (SR61B).
- 4 Select **Communication > Select communication interface**. The Device Selection dialog box appears.
- 5 Select the communication interface that you are using for your scanner and click **OK**.
- 6 EasySet connects to your scanner and retrieves the current configuration. These configurations are indicated with a blue check mark or blue text. Open the folders to find the configuration commands needed. Double click each command to send it to the scanner.



Note: The scanner does not beep when you send configuration commands online from EasySet. It powers off when you select **Disconnect** from the **Communication** menu in Easyset.

Offline Setup with EasySet

To configure your scanner offline by scanning bar codes

- 1 Start EasySet. The first time you start EasySet, the Select product dialog box appears.
If the Select product dialog box does not appear, choose **Product > Select** or click on the product icon in the upper left corner.
- 2 Select your product (SR61B).
- 3 Open the folders to find the configuration commands needed. Double-click each command to send each command to the setup sheet.
- 4 Click on the print icon to print out the setup sheet and scan the commands.

Configuring your Scanner From Your Intermec Computer

You can configure many settings for the SR61B from your Intermec computer using Intermec Settings.

To configure the SR61B from your Intermec computer

- 1 Establish a Bluetooth connection with your Intermec computer (see [“Connecting the SR61B to an Intermec Computer” on page 19](#)).



Note: When you first connect to an Intermec computer, only SR61B settings common to the Intermec computer’s internal scanner settings are changed to the internal scanner’s default settings.

- 2 On your Intermec computer, start the Intermec Settings application.
- 3 Select **Data Collection > SR61 Scanner Bluetooth Address**, where *Bluetooth Address* is the Bluetooth address of your SR61B. The

SR61B Bluetooth address is located in the top right corner of the label on the side of the SR61.

- 4** Configure commands from the SR61 Scanner menu for your SR61B.
- 5** Select **File > Save Settings**. The SR61B is updated with the new configuration command settings.
- 6** Close Intermec Settings.

4

Troubleshooting and Maintaining the SR61B

Use this chapter to solve problems you may have while using the SR61B. This chapter contains these topics:

- **Troubleshooting the SR61B**
- **Maintaining the SR61B**

Troubleshooting the SR61B

If you have problems using the SR61B, use this chapter to find a possible solution.

Calling Product Support

To talk to an Intermec Product Support representative:

- In the U.S.A. and Canada, call **1-800-755-5505**
- Outside the U.S.A. and Canada, contact your local Intermec representative. For help, go to www.intermec.com > **About Us** > **Contact Us**.

Before you call Intermec Product Support, make sure you have the following information:

- SR61B firmware version
- SR61B decode version
- SR61B sub-system version

To get the firmware version and decode version

1 Run an application that can accept bar code information from the SR61B:

- If you are using your SR61B scanner as a keyboard (for example if it is connected through a SD61 Base Station with a USB Keyboard HID or keyboard wedge interface, or if it is connected to a Bluetooth device as an HID Bluetooth device), use Microsoft® Notepad.
- If you are using your SR61B scanner as a serial device (for example if it is connected through a SD61 Base Station with an RS-232 or USB Virtual Com interface, or if it is connected to a Bluetooth device as an SPP Bluetooth device), use the EasySet ISCP Terminal window.

2 Scan one of these bar codes:

Get firmware version



Get decode version



Get sub-system version



Problems and Possible Solutions

Use this section to find possible solutions to problems you may have.

Problems and Possible Solutions

Problem	Possible Solution
You pull the trigger, but nothing happens.	The SR61B is powered by a rechargeable lithium-ion battery. Make sure the battery is not fully discharged. Charge the battery then try scanning again. To recharge your SR61B scanner, see “Charging the Battery” on page 3.
The Status Light blinks red slowly.	The battery is low. Charge the battery. To recharge your SR61B scanner, see “Charging the Battery” on page 3.
You pull the trigger, the red scanning beam (1D) or laser framing (2D) turns on, but you cannot successfully scan a bar code.	Try these possible solutions: <ul style="list-style-type: none"> • Make sure that the SR61B is configured for the symbology you are scanning. • Make sure that the SR61B is at the appropriate scanning distance and angle from the bar code. Move the SR61B closer and farther away and tilt it up and down to find the appropriate distance and angle. • Make sure that the SR61B is configured for the type (1D, 2D) of bar code you are scanning. • Make sure the bar code you are trying to scan is not poorly printed or too small. Scan a known good bar code to make sure that the SR61B is working properly. For more information, see “Scanning Bar Codes” on page 8.

Problems and Possible Solutions (continued)

Problem	Possible Solution
You scan a bar code and the status light turns on, but the SR61B does not beep.	The beep duration, volume, frequency, and number may be configured so the SR61B does not beep. To reset the SR61B, scan this bar code: Reset factory defaults 
You scan a (configuration) bar code and the SR61B emits six very fast beeps.	The SR61B does not recognize or support the configuration bar code you scanned, or has lost connection with your host (out of range, low battery, disconnected SD61 Base Station cable...). Check that the SR61B supports the configuration bar code and try to re-establish the Bluetooth connection by: <ul style="list-style-type: none">• getting back into range, or• recharging your scanner, or• reconnecting the SD61 Base Station cable to your host, or• following the Bluetooth connection procedure from start (see “Connecting the SR61B” on page 17).
You scan a bar code, the SR61B beeps twice, and the status light blinks green twice, but the data is not transmitted to the host computer.	Try these possible solutions: <ul style="list-style-type: none">• Make sure that your data collection application is set up to receive data from the SR61B.• If you are using an SD61 Base Station connected to your host using an RS-232 cable, make sure that the serial parameters on the SR61B match the serial parameters of the host computer. The default serial parameters for the SR61B are: 19200 baud, 8 data bits, no parity, and 1 stop bit.

Problems and Possible Solutions (continued)

Problem	Possible Solution
<p>You cannot establish a Bluetooth connection with your scanner.</p>	<p>There might be a problem with your host Bluetooth interface. Try to:</p> <ul style="list-style-type: none"> • disable then enable your host Bluetooth radio from the Device Manager, or • unplug then plug again your Bluetooth adapter, if applicable, or • reset the SR61B by reading Reset factory defaults bar code.
<p>You are trying to establish a Bluetooth connection from a host device to your SR61B, but the host device cannot find it.</p>	<p>Try these possible solutions:</p> <ul style="list-style-type: none"> • Make sure that the SR61B is in a discoverable state. • Make sure the SR61B is not connected and paired to another Bluetooth device. <p>In both cases, read the Reset factory defaults bar code to reset the SR61B to its default settings and disconnect Bluetooth communications. Then try establishing a connection again.</p>
<p>You established a Bluetooth connection with an Intermec computer, and the settings on your SR61B were restored to their default values.</p>	<p>When you first connect to an Intermec computer, only SR61B settings common to the Intermec computer's internal scanner settings are changed to the internal scanner's default settings. Scan configuration bar codes, or use Intermec Settings on your Intermec computer to change your SR61B settings.</p>
<p>Your scanner is unresponsive.</p>	<p>Try to reset or rescue your scanner (see “Resetting the SR61B” on page 53).</p>
<p>You cannot scan the Firmware upgrade bar code on your computer screen.</p>	<p>Print out this bar code and scan it: Firmware upgrade</p> 

Maintaining the SR61B

To keep your SR61B in good working order, you may need to upgrade the SR61B firmware and clean the scanner window. Should you encounter any unresponsiveness, you can electrically reset the scanner.

Upgrading the SR61B

You may need to upgrade the SR61B firmware if there is an update that incorporates changes to a feature or adds functionality to the scanner. When you upgrade your scanner the current settings are erased and replaced with the default settings. You need to reestablish Bluetooth communications between your SR61B and other Bluetooth devices and applications in your data collection system.

The process of upgrading the SR61B takes about 5 minutes to complete.

To upgrade the SR61B you need:

- a Bluetooth interface with your host, such as an internal Bluetooth controller or a Bluetooth external adapter.
- Minimum PC operating system requirements are Microsoft® Windows® XP with SP2 or Microsoft Windows 2000 with SP4 or higher versions.
- EasySet version 5.6.5.3 (see **“Configuring Your Scanner with EasySet” on page 35**) or later with WinFlash.
- The firmware update file — .wbf, Winflash Binary File (formerly known as .bin or LDR files).



Note: Before you start the upgrade process, make sure that you are not using the selected COM port for any other application or you receive an error and cannot use the COM port.

Your scanner can be paired or not with your host prior to upgrading it. The following procedures cover both cases.

To upgrade the SR61B firmware when your scanner is already paired with your host

- 1 Download the latest SR61B firmware update package from the Intermec web site at www.intermec.com.
 - a Go to **Support > Downloads**.
 - b From the **Product Category** drop-down list, choose **Bar Code Scanners**.
 - c From the **Product Family** drop-down list, choose **Rugged**.
 - d From the **Product** drop-down list, choose **SR61B Handheld Scanner** and click **Submit**.
 - e Click the link to download the firmware upgrade package and save firmware upgrade file (.wbf) to your PC.
- 2 If your scanner is connected to your host, disconnect it by reading the Bluetooth Device Disconnect bar code.

Bluetooth Device Disconnect



- 3 If your host outgoing port is open, close it.
- 4 If your scanner is paired as an HID Bluetooth device, remove it from your host Bluetooth devices and follow the procedure for upgrading an unpaired scanner (see **“To upgrade the SR61B firmware when your scanner is not paired with your host” on page 48**).
- 5 Start EasySet version 5.6.5.3 or later. Make sure SR61B is selected as your product.
- 6 From the **Tools** menu, select **Upgrade product firmware** to start WinFlash.
- 7 If WinFlash is not already installed or if a more recent version is available you will be asked to install it. Click **Yes** and follow the installation instructions. After installing Winflash, start WinFlash from the **Tools** menu, select **Upgrade product firmware**.
- 8 Select SR61B 1D scanner or SR61B 2D scanner and click **Next**.

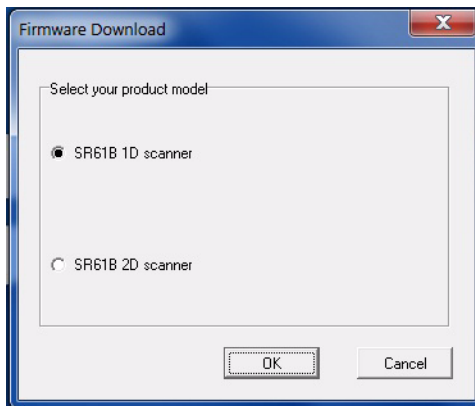

- 9 Use **Browse** to browse to the location of the firmware upgrade file (.wbf), select the file, and click **Open**. Click **Next**.

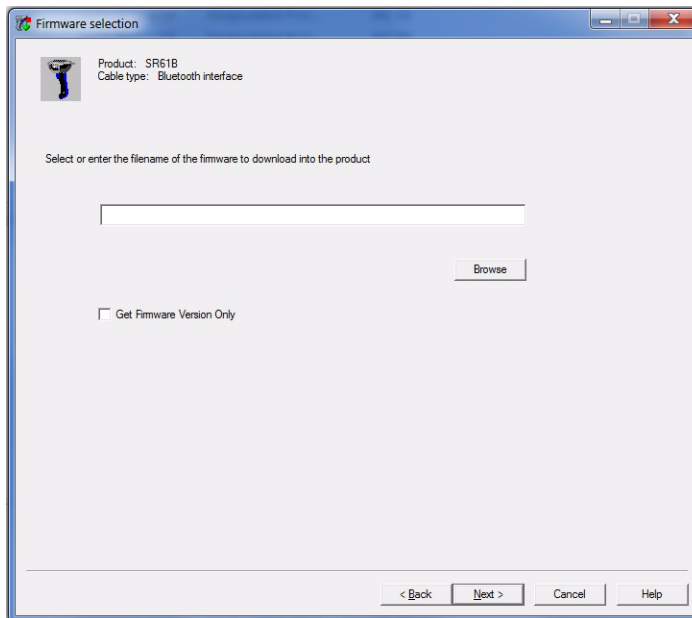

- 10** The Firmware upgrade bar code appears. Either read it on screen or read the following bar code, then click **OK**:

Firmware upgrade



- 11** Select the outgoing Com port. Click **Next**.

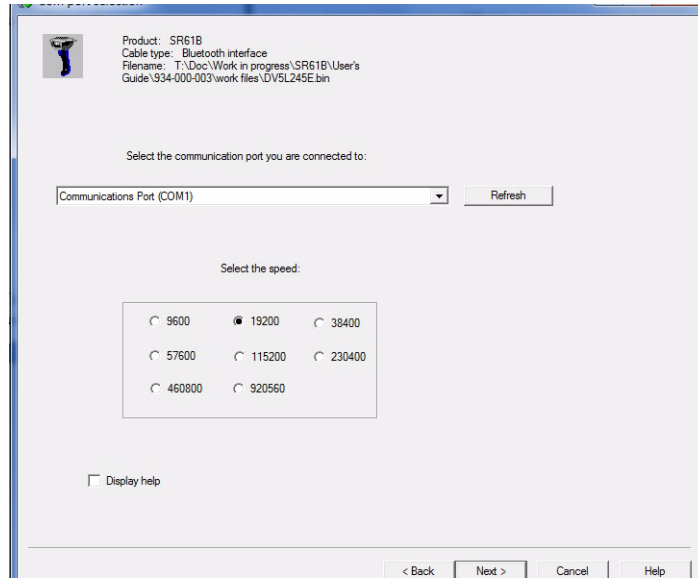

Note: To know which port is the outgoing port, check in the Bluetooth option settings or in **Windows Configuration Panel**, in the **Device Manager > Ports** section.

12 Click **Start download**.

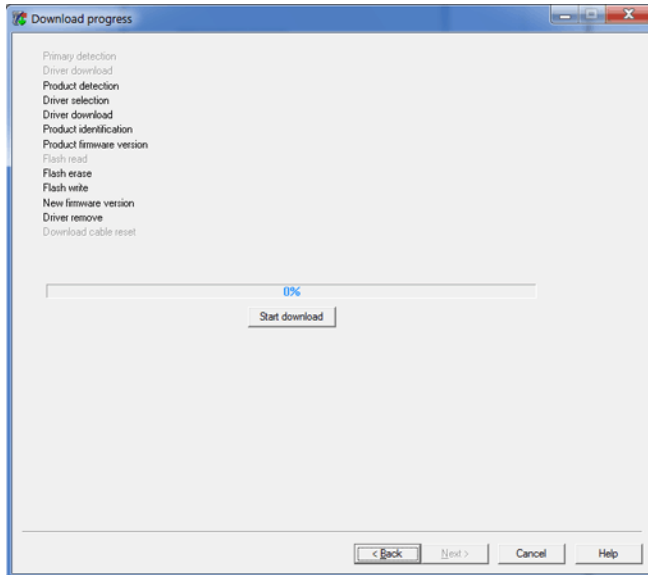

When the firmware download is complete, the “Operation successful” message appears.

13 Click **Finish**. You have successfully upgraded your scanner firmware.



Note: If the firmware download is not successful, you must restart the firmware download procedure.

To upgrade the SR61B firmware when your scanner is not paired with your host

- 1** Download the latest SR61B firmware update package from the Intermec web site at www.intermec.com.
 - a** Go to **Support > Downloads**.
 - b** From the **Product Category** drop-down list, choose **Bar Code Scanners**.
 - c** From the **Product Family** drop-down list, choose **Rugged**.

- d** From the **Product** drop-down list, choose **SR61 Handheld Scanner** (or other SR61 product) and click **Submit**.
- e** Click the link to download the firmware upgrade package and save firmware upgrade file (.wbf) to your PC.
- 2** Pair your scanner as an SPP Bluetooth device (see **“Pairing as an SPP Bluetooth Device” on page 24**).
- 3** Start EasySet version 5.6.5.3 or later. Make sure SR61B is selected as your product.
- 4** From the **Tools** menu, select **Upgrade product firmware** to start WinFlash.
- 5** If WinFlash is not already installed or if a more recent version is available you will be asked to install it. Click **Yes** and follow the installation instructions. After installing Winflash, start WinFlash from the **Tools** menu, select **Upgrade product firmware**.
- 6** Select SR61B 1D scanner or SR61B 2D scanner and click **Next**.

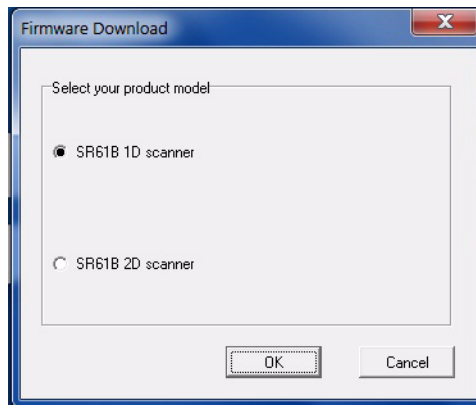

- 7** Use **Browse** to browse to the location of the firmware upgrade file (.wbf), select the file, and click **Open**. Click **Next**.

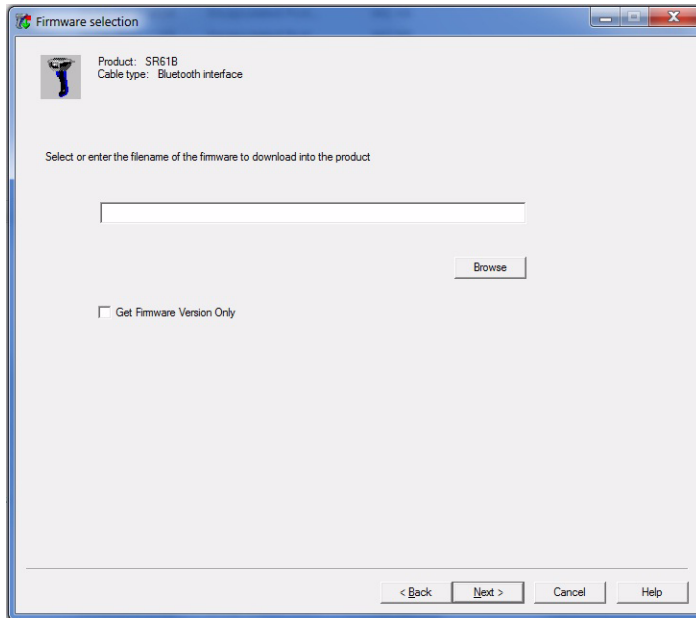

- 8 The Firmware upgrade bar code appears. Either read it on screen or read the following bar code:

Firmware upgrade



- 9 Select the outgoing Com port. Click **Next**.

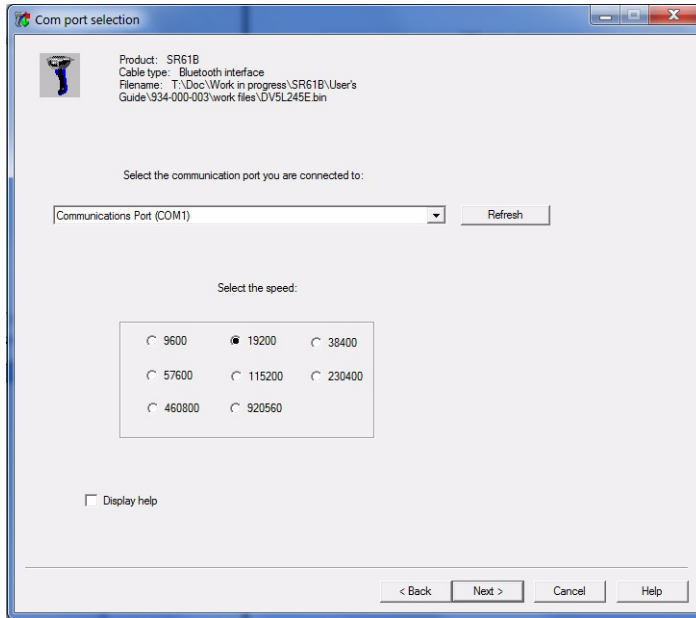

Note: To know which port is the outgoing port, check in the Bluetooth option settings or in **Windows Configuration Panel**, in the **Device Manager > Ports** section.

10 Click **Start download**.

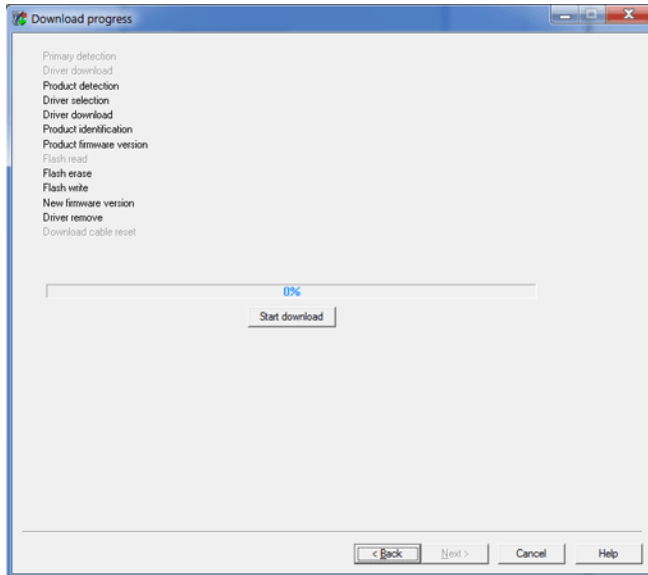

When the firmware download is complete, the “Operation successful” message appears.

11 Click **Finish**. You have successfully upgraded your scanner firmware.



Note: If the firmware download is not successful, you must restart the firmware download procedure.

Cleaning the SR61B

Clean the scanner window as often as needed for the environment in which you are using the SR61B. To clean the scanner window, you can use soapy water, a solution of ammonia and water, or isopropyl alcohol.



Caution

Opening the SR61B may cause damage to the internal components.

To clean the scanner window

- 1 Dip a clean towel or rag in soapy water, ammonia and water solution, or isopropyl alcohol and wring out the excess. Wipe the scanner window. Do not allow any abrasive material to touch the window.
- 2 Wipe dry with a lint-free cloth.

Recovering the SR61B

The following procedures describe how to reset your scanner when it is unresponsive and how to rescue it if you inadvertently set it up in a configuration that prevents any extra configuration.

Resetting the SR61B

If your SR61B does not respond when you pull the trigger, you can reset it. When you reset your SR61B, the scanner control firmware is restarted.

To reset your SR61B

- Remove and install again the battery from the SR61B.

If you have a Bluetooth connection, the SR61B disconnects from the host device. After a reset, the SR61B tries to reestablish a Bluetooth connection with the host device when you turn it on.

Rescuing the SR61B

If you cannot configure your SR61B anymore because it is in a locking configuration (for example, if you inadvertently disabled the trigger), you can rescue it. When you rescue your scanner, factory default settings are restored including custom default settings.

To rescue your SR61B

- 1 Reset your scanner by removing and installing again the battery.
- 2 Pull the trigger for 10 seconds approximately, until the red LED lights up.
- 3 Release the trigger then press it rapidly five times while the red LED is on (2 seconds).

The green LED stays on while the scanner beeps as a confirmation (six-beep melody), then the scanner powers off.



Note: If your scanner does not turn on despite a reset and/or rescue procedure, and despite using a correct AB3 battery (P/N 075082-xxx, at least partially charged), please contact your Intermec representative.

A

Specifications and Reading Distances

This appendix contains the technical specifications and reading distances for each scanner model.

Specifications

Use this section to find technical information about the SR61.

Physical Dimensions	
Length	19.4 cm (7.6 in)
Height	13.1 cm (5.2 in)
Width	7.2 cm (2.8 in)
Weight	304 g (10.7 oz) without the battery Battery = 100 g (3.5 oz)

Power and Electrical Specifications	
Operating	Rechargeable lithium-ion battery (2400 mAh)
Electrical rating	--- 5V, 1.7A
ESD sensitivity	± 8 kV (air discharge) ± 4 kV (contact discharge)

Temperature and Environmental Specifications	
Operating	-20°C to 50°C (-4°F to 122°F) @ 3.3V
Storage	-40°C to 70°C (-40°F to 158°F)
Charging	0°C to 35°C (32°F to 95°F)
Relative humidity	5 to 95% non-condensing
Shock	2000G, half sinus, 0.7 ms, 6 directions
Vibrations	8G, from 10Hz to 500Hz, 2hr/axis, 3 axes
Environmental rating	IP54
Ambient light	0 to 100 000 lux

Bluetooth Radio	
Radio Type	Bluetooth Class 1 version 2.1 + EDR

Bluetooth Radio

Frequency	2.4 GHz
-----------	---------

Scanning Performance

SR61B1D	Scan angle: 40° Minimum X dimension: 4 mils
SR61BL	Scan angle: 38° Min. X dimension: 4 mils
SR61BHP	Scan angles: 34.4° horizontal, 22.2° vertical Framing angles: 30° horizontal, 20° vertical Min. X dimension 1D: 4 mils Min. X dimension 2D: 6.6 mils
SR61BXR	Scan angles: 14° horizontal, 8.7° vertical, 16.4° diagonal Min. X dimension 1D: 3 mils Min. X dimension 2D: 6.8 mils
SR61BDPM	Scan angles: 34.4° horizontal, 22.2° vertical Framing angles: 30° horizontal, 20° vertical Min. X dimension 1D: 3 mils Min. X dimension 2D: 6.6 mils

Bar Code Symbolologies for 2D Models (SR61BHP and SR61BXR)

Australian Post	Infomail
Aztec	Intelligent mail
BPO	Interleaved 2 of 5
Canada Post	Japan Post
Codabar	Matrix 2 of 5
Codablock A	Maxicode
Codablock F	Micro PDF417
Code 11	MSI
Code 39	Muticode

Appendix A – Specifications and Reading Distances

Bar Code Symbolologies for 2D Models (SR61BHP and SR61BXR)

Code 93/93i	PDF417
Code 128 / GS1-128	Planet
DataMatrix	Plessey
Dutch Post	Postnet
EAN/UPC	QR Code
GS1 Composite	Standard 2 of 5
GS1 DataBar Expanded	Sweden Post
GS1 DataBar Limited	Telepen
GS1 DataBar Omni-Directional	TLC 39
GS1 DataBar Stacked	PDF417

Bar Code Symbolologies for 1D Models (SR61B1D and SR61BL)

Codabar	GS1 DataBar Omni-Directional*
Codablock A*	GS1 DataBar Stacked*
Codablock F*	Interleaved 2 of 5
Code 11	Matrix 2 of 5
Code 39	Micro PDF417*
Code 93/93i	MSI
Code 128 / GS1-128	PDF417*
EAN/UPC	Plessey
GS1 Composite*	Standard 2 of 5
GS1 DataBar Expanded*	Telepen
GS1 DataBar Limited*	TLC 39

* = These symbolologies are only available with SR61TL (laser scanner).

Reading Distances

The reading distances for each scanner are typical distances measured in an office environment with extended reading range activated by default (200 lux). Extended reading range is available for scanners with software version BF4_252 and later.



Note: Minimum distances depend on the number of characters encoded in the bar code.

SR61B1D

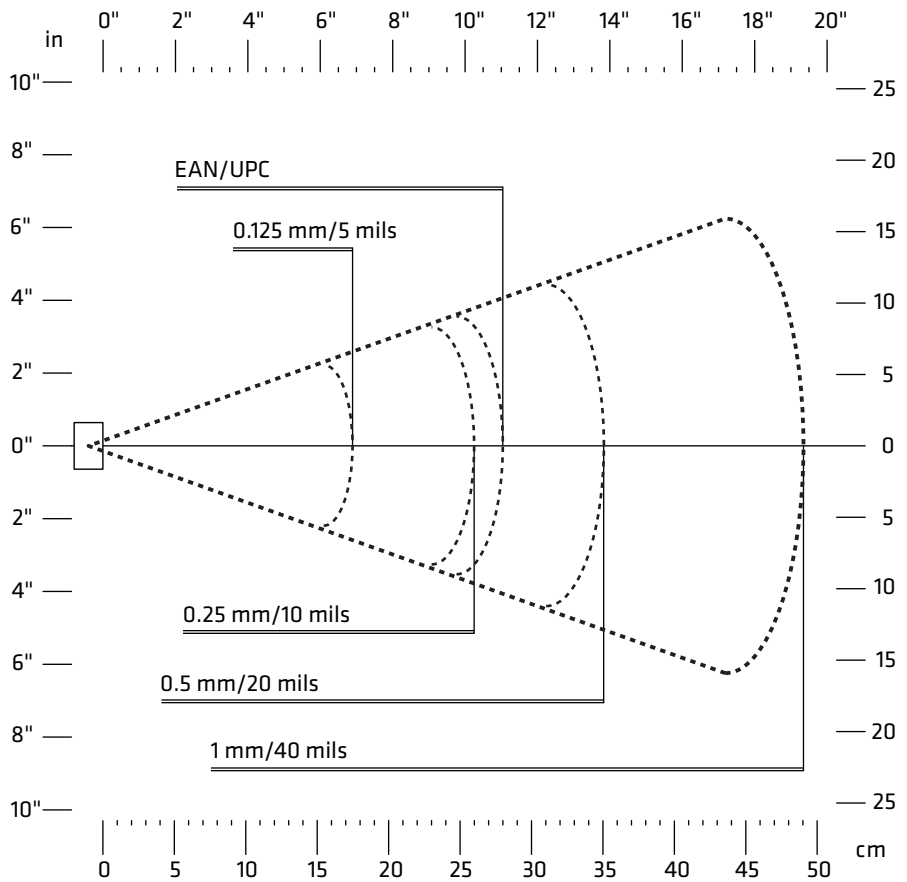

Symbology	Density	Minimum Distance	Maximum Distance
Code 39	0.1 mm (3.8 mils)	10 cm (3.94 in)	14 cm (5.51 in)
	0.125 mm (5 mils)	9 cm (3.54 in)	17.5 cm (6.89 in)
	0.25 mm (10 mils)	5.5 cm (2.17 in)	26 cm (10.24 in)
	0.5 mm (20 mils)	4 cm (1.57 in)	35 cm (13.78 in)
	1 mm (40 mils)	7.5 cm (2.95 in)	49 cm (19.29 in)
EAN/UPC	0.33 mm (13 mils)	5.2 cm (2.05 in)	28.5 cm (11.22 in)

SR61BL

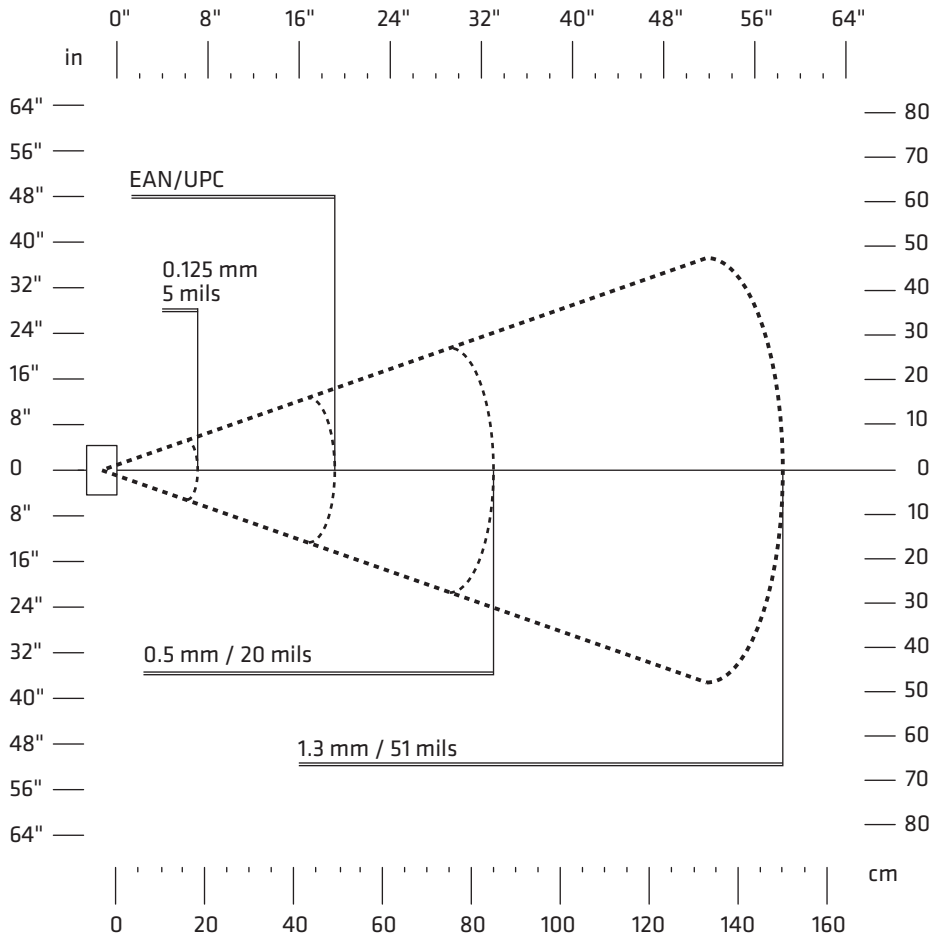

Symbology	Density	Minimum Distance	Maximum Distance
Code 39	0.125 mm (5 mils)	10 cm (3.94 in)	19.5 cm (7.68 in)
	0.5 mm (20 mils)	6 cm (2.36 in)	85 cm (33.46 in)
	1.3 mm (51 mils)	41 cm (16.14 in)	150 cm (59.1 in)
EAN/UPC	0.33 mm (13 mils)	4.5 cm (1.77 in)	49 cm (19.29 in)

SR61BHP

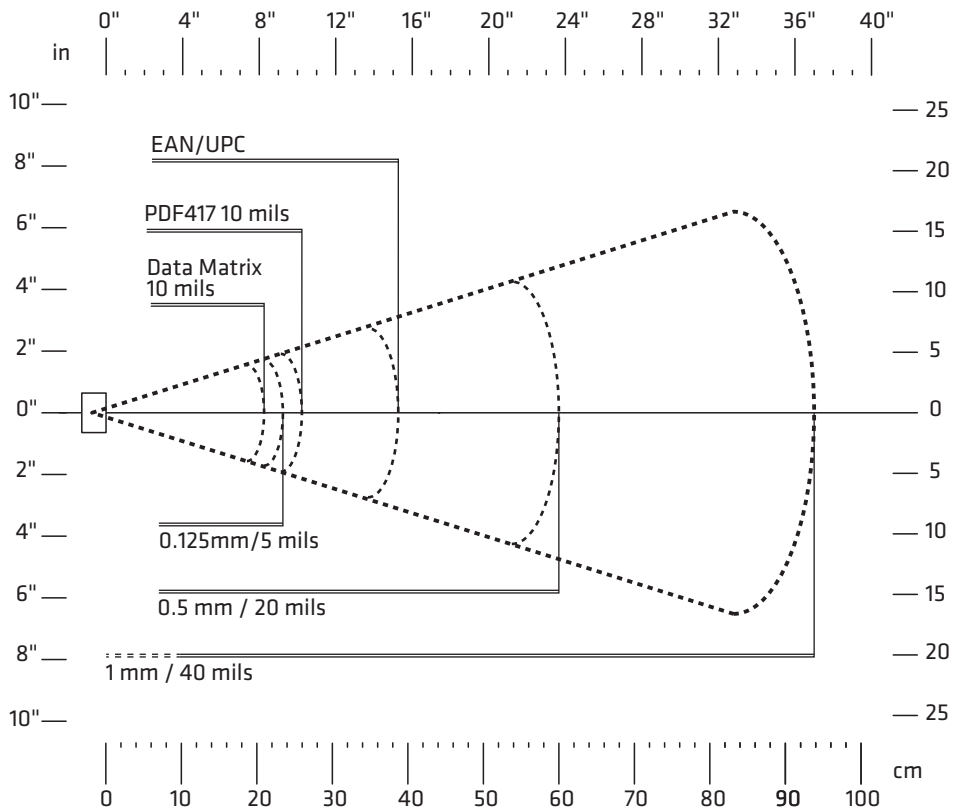

Symbology	Density	Minimum Distance	Maximum Distance
Code 39	0.125 mm (5 mils)	6.8 cm (2.68 in)	23.5 cm (9.25 in)
	0.5 mm (20 mils)	7 cm (2.76 in)	60 cm (23.62 in)
	1mm (40 mils)	9.5 cm (3.74 in)	93.6 cm (36.85 in)
EAN/UPC	0.33 mm (13 mils)	6 cm (2.36 in)	38.4 cm (15.12 in)
PDF417	0.25 mm (10 mils)	5.5 cm (2.17 in)	26 cm (10.24 in)
	0.38 (15 mils)	6.5 cm (2.56 in)	36 cm (14.17 in)
DataMatrix	.025 mm (10 mils)	6 cm (2.36 in)	21 cm (8.27 in)

SR61BXR

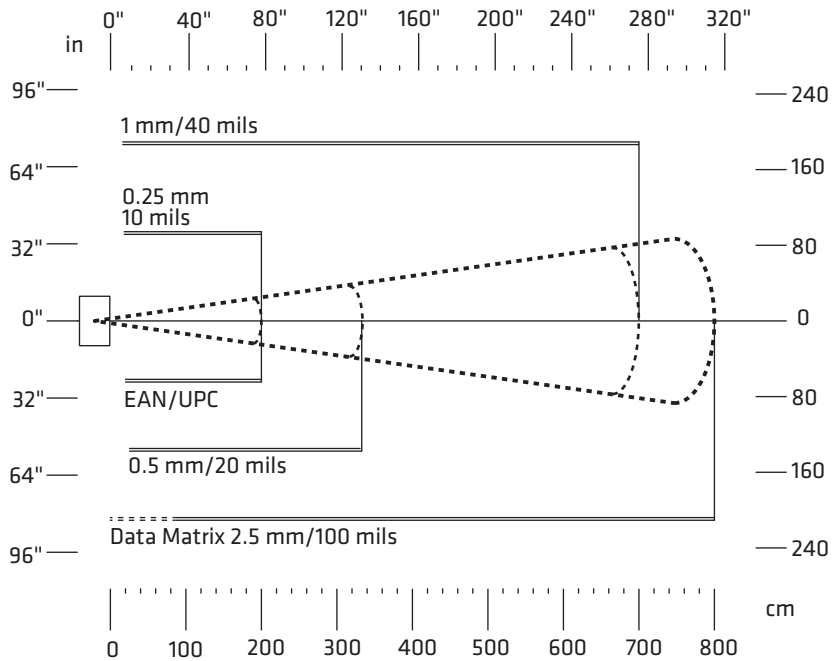

Symbology	Density	Minimum Distance	Maximum Distance
Code 39	0.25 mm (10 mils)	11 cm (in)	200 cm (6.6 ft)
	0.5 mm (20 mils)	16 cm (6.3 in)	330 cm (10.9 ft)
	1 mm (40 mils)	38 cm (14.9 in)	700 cm (23 ft)
EAN 100%	0.33 mm	20 cm (7.87 in)	200 cm (6.6 ft)
DataMatrix	0.25 mm (10 mils)	16 cm (6.3 in)	80 cm (2.6 ft)
	1.4 mm (55 mils)	depends on bar code length	400 cm (13.1 ft)
	2.5 mm (100 mils)	depends on bar code length	800 cm (26.2 ft)

SR61BDPM

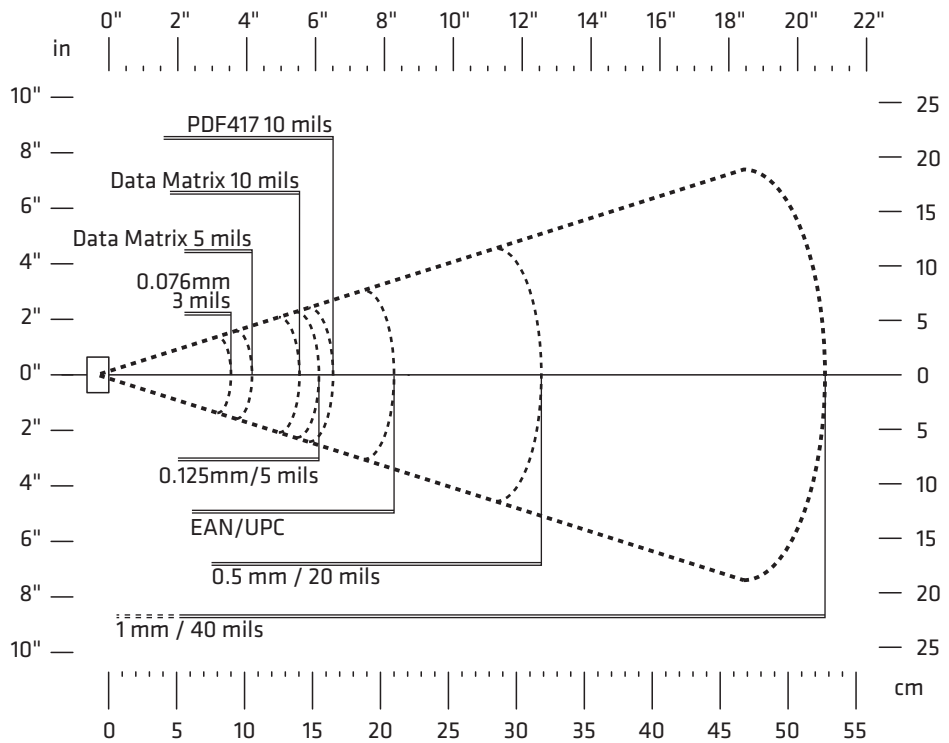

Symbology	Density	Minimum Distance	Maximum Distance
Code 39	0.076 mm (3 mils)	5.5 cm (2.17 in)	9 mm (3.54 in)
	0.1 mm (4 mils)	5 cm (1.97 in)	14.4 cm (5.67 in)
	0.125 mm (5 mils)	5 cm (1.97 in)	15.3 cm (6.02 in)
	0.5 mm (20 mils)	7.5 cm (2.95)	31.7 cm (12.48 in)
	1mm (40 mils)	depends on bar code length	52.8 cm (20.79 in)
EAN/UPC	0.33 mm (13 mils)	6 cm (2.36 in)	21.1 cm (8.31 in)
PDF417	0.125 mm (5 mils)	5 cm (1.97 in)	12.5 cm (4.92 in)
	0.25 mm (10 mils)	4 cm (1.57 in)	16.5 cm (6.50 in)
	0.38 (15 mils)	6 cm (2.36 in)	20.5 cm (8.07 in)
DataMatrix	0.125 mm (5 mils)	5.5 cm (2.17 in)	10.5 cm (4.13 in)
	.025 mm (10 mils)	4.5 cm (1.77 in)	14 cm (5.51 in)



Worldwide Headquarters
6001 36th Avenue West
Everett, Washington 98203
U.S.A.

tel 425.348.2600

fax 425.355.9551

www.intermec.com

© 2009-2012 Intermec Technology
Corporation. All rights reserved.

SR61B Cordless Scanner User's Guide



934-000-004