

Zebra® ZD510

Wristband Printer



User's Guide



ZEBRA

Copyright

© 2018 ZIH Corp and/or its affiliates. All rights reserved. ZEBRA and the stylized Zebra head are trademarks of ZIH Corp., registered in many jurisdictions worldwide. All other trademarks are the property of their respective owners.

COPYRIGHTS AND TRADEMARKS: For complete copyright and trademark information, go to www.zebra.com/copyright

WARRANTY: For complete warranty information, go to www.zebra.com/warranty

END USER LICENSE AGREEMENT: For complete EULA information, go to www.zebra.com/eula

Terms of Use

Proprietary Statement: This manual contains proprietary information of Zebra Technologies Corporation and its subsidiaries (“Zebra Technologies”). It is intended solely for the information and use of parties operating and maintaining the equipment described herein. Such proprietary information may not be used, reproduced, or disclosed to any other parties for any other purpose without the express, written permission of Zebra Technologies.

Product Improvements: Continuous improvement of products is a policy of Zebra Technologies. All specifications and designs are subject to change without notice.

Liability Disclaimer: Zebra Technologies takes steps to ensure that its published Engineering specifications and manuals are correct; however, errors do occur. Zebra Technologies reserves the right to correct any such errors and disclaims liability resulting therefrom.

Limitation of Liability: In no event shall Zebra Technologies or anyone else involved in the creation, production, or delivery of the accompanying product (including hardware and software) be liable for any damages whatsoever (including, without limitation, consequential damages including loss of business profits, business interruption, or loss of business information) arising out of the use of, the results of use of, or inability to use such product, even if Zebra Technologies has been advised of the possibility of such damages. Some jurisdictions do not allow the exclusion or limitation of incidental or consequential damages, so the above limitation or exclusion may not apply to you.

About

This guide is for integrators and operators of Zebra ZD510 Link-OS desktop printers. Use this guide to install, change configuration, operate, and physically support these printers.

Other Online resources are available to support this printer include:

- “How To” videos
- ZD510 Product page links for printer specifications
- Printer accessory, supplies, parts, and software links
- Various setup and configuration guides
- Programmer’s manuals,
- Printer Drivers (Windows, Apple, OPOS, etc.)
- Printer Firmware
- Printer Fonts
- Utilities
- Knowledge base and support contacts
- Printer warranty and repair links

Use these links to get to your Online printer support resources:

- ZD510 Wristband Printer — www.zebra.com/zd510-info

Other Valuable Printer Resources

Zebra has a large suite of free and fee based software, Apps (applications), and other technical resources for your Zebra Link-OS printer.

These are just some of the extensive software and resource areas available Online:

- Label (Wristband) Design software
- Printer Management tools
- Virtual Devices for legacy languages normally associated with other printer brands
- Cloud based Enterprise printer management and printing
- XML and PDF format file printing
- Oracle and SAP support
- IoT data tools (Savanna)
- A suite of Link-OS Mobile Apps (applications for phones, tablets, etc.)
- Link-OS software development kit (SDK)
- Additional Operating Systems (OS) and Service platforms

See ZebraLink, Zebra Link-OS, and Savanna from this Online link: www.zebra.com/software

Zebra OneCare Printer Service and Support

For maximum productivity, we can help your business ensure its Zebra printers are Online and ready for business. See the descriptions of the Zebra OneCare service and support options available for your printers Online at this link: www.zebra.com/zebraonecare

Using This Document and Its Internally Attached Files

This document is best used with Adobe Reader or Adobe DC. This user's guide includes attached User Programming Example Files for sample printer operations.

Go to the Adobe Web site to load Adobe Reader (for free at the release time of this publication): www.adobe.com

Document Conventions

The following graphic icons are used throughout the documentation set. These icons and their associated meanings are described below.



Caution • If the precaution is not heeded, the user could receive minor or moderate injury.



Eye Injury Caution • If the precaution is not taken, the user's eyes could be damaged. EXAMPLE: Wear protective eyewear when installing or removing E-rings, C-clips, snap rings, springs, and mounting buttons. These are under tension and could fly off.



Electrical Shock Caution • If the precaution is not taken, the user could receive an electrical shock. EXAMPLE: Turn OFF the printer and disconnect it from the power source before performing the following procedure.



Hot Surface Caution • If the precaution is not taken, the user could be burned. EXAMPLE: The printhead may be hot and could cause severe burns. Allow the printhead to cool.



Product Damage Caution • If the precaution is not taken, the product could be damaged. EXAMPLE: Unplugging the computer without properly shutting it down may corrupt the data on your hard drive.



ESD Caution • If the precaution is not taken, the product electronics could be damaged by an electrostatic discharge. EXAMPLE: Observe proper electrostatic safety precautions when handling static-sensitive components such as circuit boards and printheads.



Important • The text here indicates information that is important for the user to know. EXAMPLE: Run the setup.exe file for the product BEFORE connecting the product to your printer.



Note • The text here indicates information that is supplemental for the user to know and that is not required to complete a task. EXAMPLE: Refer to zebra.com for complete information on product warranties.

Contents

• About	3
Other Valuable Printer Resources	4
Zebra OneCare Printer Service and Support	4
Using This Document and Its Internally Attached Files	4
Document Conventions	5
• Introduction	9
ZD510	9
Common Link-OS Printer Features:	9
Zebra Label Printing Solution	10
What's in the Box?	11
Storage Environment Requirements	11
Unpack and Inspect the Printer	12
Shipping the Printer	12
Printer Features	13
Media Cartridge Features	17
Media Storage Tips	19
Opening the Upper Cover	20
Manual Cartridge Eject	21
Wristband Print Zone	23
Zebra Print Touch	24
• Controls and Indicators	25
Control Panel	26
Control Panel Indicators	26
Control Panel Buttons	26
Meaning of the Indicator Light Patterns	28
Wi-Fi Status - (Optional)	30
• Printer Setup	31
Printer Setup Overview	31
Select a Location for the Printer	32
Attaching Power	33
Loading the Media Cartridge	34

Contents

Test Printing with a Configuration Report	36
Connecting your Printer to a Computer	37
Interface Cable Requirements	37
Wi-Fi and Bluetooth Classic Wireless Connectivity Option	41
• Setup for Windows® OS	42
Windows to Printer Communication Setup (Overview)	42
Pre-install Windows® Printer Drivers	43
Setting Up the Wi-Fi Print Server Option	44
Configure Using the ZebraNet Bridge's Connectivity Wizard	45
Using a Configuration Script	51
Bluetooth Option Configuration	53
Connecting to a Windows Vista® SP2 or Windows 7® Master Device	55
Connecting the Printer to a Windows 8	58
Connecting the Printer to a Windows 10 PC	59
After Your Printer is Connected	62
• Advanced User Information	63
Accessing Printer Settings	64
Accessing the Printer's Web Pages	64
Changing and Restoring Printer Settings	67
Commonly Used ZD510 Printer Settings	67
Printer Fonts	71
Identifying Fonts in Your Printer	71
Localizing the Printer with Code Pages	71
Asian fonts and Other Large Font Sets	72
ZBI 2.0™ — Zebra Basic Interpreter	73
Additional Diagnostics Tools	74
Media Sensor Profile	74
Communications Diagnostics Test	75
Downloading Firmware	76
Manual 'Forced' Download	77
• Maintenance	78
Cleaning	78
Cleaning Supplies	78
Cleaning the Media Path	79
Using a Cleaning Card	79
Cleaning the Exterior of the Printer	82
Cleaning the Media Cartridge	83
Cleaning the Printer's Smart Chip Reader Contacts	84
Cleaning the Media Sensor	85
Printhead Replacement	88
Platen Replacement	93
Lubrication	96

Contents

RTC Battery	96
Fuses	96
• Troubleshooting	97
Resolving Alerts and Errors	97
Alert: Upper Cover Open	97
Alert: Media Out (while printing/feeding media)	98
Alert: Media Out (while loading media)	98
Alert: Operating Temp	99
Alert: Printhead Temp Shutdown	100
Alert: Memory Storage Exception	100
Resolving Print Issues	101
Issue: General Print Quality Issues	101
Issue: Labels Are Distorted in Size or Print Area Start Position Varies	102
Communication Issues	103
Issue: Label Job Sent, No Data Transfer	103
Issue: Label Job Sent, Data Transfers, But No Print	103
Miscellaneous Issues	104
Issue: Settings are Lost or Ignored	104
Issue: Printer Locks-Up	105
Miscellaneous Troubleshooting	106
Issue: Data Not Printing On First Part of the Wristband	106
Issue: Data Prints Poorly On Sections of the Wristband	106
Issue: Print On Wristband Is Unusually Dark	106
Issue: Printer Will Not Eject Media Cartridge	107
• USB Host Port and Link-OS Demonstration Examples	108
USB Host	108
Using USB Host for Firmware Updates	109
USB Host and Printer Usage Examples	110
Items Required for the USB Host Exercises	110
Files for Completing the Exercises	110
Exercise 1: Copy Files to a USB Flash Drive and Perform USB Mirror	112
Exercise 5: Enter Data for a Stored File with a Smart Device and Print a Label	114
• Dimensions	116
• Interface Connector Wiring - USB	120
Universal Serial Bus (USB) Interface	120
• ZPL Configuration	121
Managing the ZPL Printer Configuration	121
Configuration Setting to Command Cross-reference	123
Printer Memory Management and Related Status Reports	126
ZPL Programming for Memory Management	126

Introduction

This section introduces the Zebra® Link-OS thermal wristband and label printer, the ZD510 printer series.

ZD510

The Zebra® ZD510 offers a wide range of features.

- Quick and easy media cartridge loading.
- Automatic media loading — no user contact with the media during loading or removal.
- Direct thermal printing of barcodes, text, and graphics - no additional ink or transfer ribbon needed.
- 300 dpi (dots per inch) print resolution (approximately 12 dots / mm).
- Includes healthcare ready plastics that withstand common hospital cleaning chemicals, and a medical grade power supply.
- The printer supports ZPL™ Zebra printer programming language and a wide variety of other printer control languages via Link-OS Virtual Devices.

Common Link-OS Printer Features:

- Universal Serial Bus (USB) Host Port that can be used for easy firmware upgrades.
- Universal Serial Bus (USB) 2.0 interface
- 10/100 Ethernet (802.3 RJ-45) interface.
- Zebra's Link-OS - an open platform that connects operating systems for smart Zebra devices with powerful software apps (applications), making the devices easy to integrate, manage and maintain from any location.
- Bluetooth Low Power (BTLE) for Link-OS printer configuration and access for mobile devices.

Introduction

- On-the-fly OpenType and TrueType font scaling and import, Unicode, resident scalable font (Swiss 721 Latin 1 font), and a selection of resident bitmap fonts.
- On-board Real Time Clock (RTC).
- Backwards compatibility focused technology eases printer replacement:
 - Drop in replacement of legacy Zebra desktop printers.
 - Supports Link-OS virtual devices to interpret non-Zebra printer programming languages.
- XML-Enabled printing—allows XML communications for barcode label printing, eliminating license fees and print server hardware and lowering customization and programming costs.
- Zebra™ Global Printing Solution – supports Microsoft Windows keyboard encoding (and ANSI), Unicode UTF-8 and UTF 16 (Unicode Transformation Formats), XML, ASCII (7 and 8 bit used by legacy programs and systems), basic single and double byte font encoding, JIS and Shift-JIS (Japanese International Standards), Hexadecimal encoding, and custom character mapping (DAT table creation, font linking, and character remapping).
- Supports printer configuration via a setup utility running on mobile devices.
 - Zebra's Print Touch (Near Field Communication - NFC) 'tap' to pair devices, access printer information, and access mobile applications.
- Printhead maintenance reporting enabled and customizable by the user.
- Easy tool-less replacement of printhead and platen (driver) roller.
- A minimum of 64 MB of internal (E:) printer memory for storing forms, fonts, and graphics.

Zebra Label Printing Solution

The printer is just one of three (3) parts of a printing solution. To print; you need a printer (ZD510), compatible media (Zebra wristband cartridges), and software (driver, applications or programming) to tell the printer what to do and print. The printer can print without being connected to other devices or systems.

Zebra assists you with label design and print with the free label and form design software: ZebraDesigner™ for Windows PC operating systems.

Zebra provides a complete suite of free Link-OS software applications and drivers to configure printer settings, print labels and receipts, get printer status, import graphics and fonts, send programming commands, update firmware, and download files.

The Zebra web site or your reseller will be able to help you identify media for your desired use case.

What's in the Box?

After unpacking, make sure you have all parts shown below. Follow the procedures for inspecting the printer to familiarize yourself with printer parts so you can follow the instructions in this book.



Printer



USB Cable

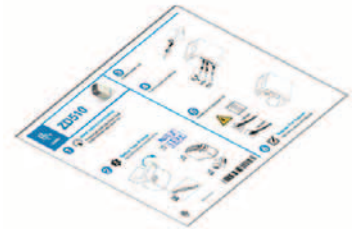

Printer Documentation



Power Supply



Power Cord
varies by locale or region

Storage Environment Requirements

If you are not placing the printer into immediate operation, repackage it using the original packing materials.

- **Storage Conditions:** Your printer is designed to function in a wide range of environments.
 - **Non-Operational Temperature:** -40° to 140°F (-40° to 60°C)
 - **Non-Operational Humidity:** 5 to 85% non-condensing

Unpack and Inspect the Printer

When you receive the printer, immediately unpack it and inspect for shipping damage.

- Save all packing materials.
- Check all exterior surfaces for damage.
- Open the printer and inspect the media compartment for damage to components.

If you discover shipping damage upon inspection:

- Immediately notify the shipping company and file a damage report. Zebra Technologies Corporation is not responsible for any damage to the printer incurred during shipment, and will not cover the repair of this damage under its warranty policy.
- Keep all packaging material for shipping company inspection.
- Notify your authorized Zebra[®] reseller.

See the Zebra Web site for 'How To' videos on packing and unpacking your printer. See [About](#) section for links to one of these 5 basic Link-OS printer variations.

Shipping the Printer

If you must ship the printer:

- Remove any media cartridges from the printer.
- Turn OFF the printer, and disconnect all cables.
- Carefully pack the printer into the original container or a suitable alternate container to avoid damage during transit.
- A shipping container can be purchased from Zebra if the original packaging has been lost or destroyed.

Printer Features

Figure 1 • Front of Printer



1	Media Cartridge Slot
2	Upper Cover
3	Upper Cover Release Button (one on each side)
4	Control Panel (see Controls and Indicators)
5	Media Exit Slot with Tear Edges
6	Print Touch Feature (see Zebra Print Touch)

Figure 2 • Rear of Printer



1	Power ON/OFF Button (in is On, out is Off)
2	Internal Ethernet Print Server (LAN, RJ-45 connector) — supports 10Base-T, 100Base-TX and fast Ethernet 10/100 auto-switching networks.
3	Universal Serial Bus (USB) 2.0 interface
4	Universal Serial Bus (USB) Host Port - Usable for easy firmware upgrades.
5	D/C power connector (24 VDC)

Figure 2 shows the data communication connectors on the rear of the printer, the power button, and the D/C power connector. For more information about the optional wired and wireless Ethernet print servers, see [Connecting your Printer to a Computer](#) and [Changing and Restoring Printer Settings](#).

Figure 3 • Media Cartridge Slot

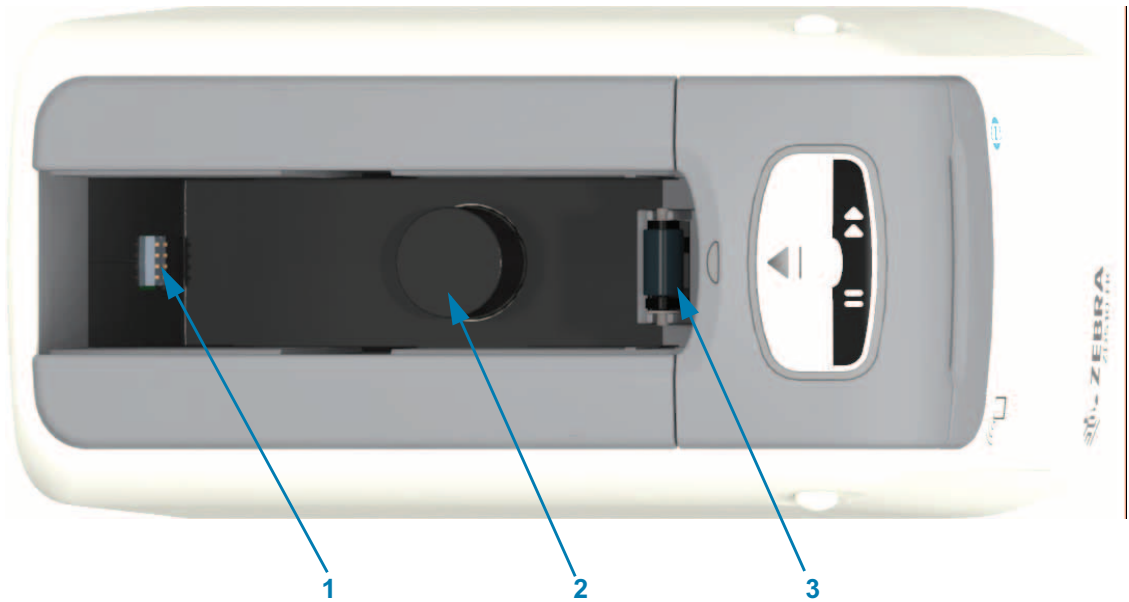

1	'Smart Card' Chip Reader
2	Cartridge Ejection Spring and Housing
3	Media Drive Roller

Figure 4 • Bottom of Printer - Manual Eject Slot



1	Manual Cartridge Eject Slot
---	-----------------------------

Introduction

Figure 5 • Interior of the Printer - User Accessible

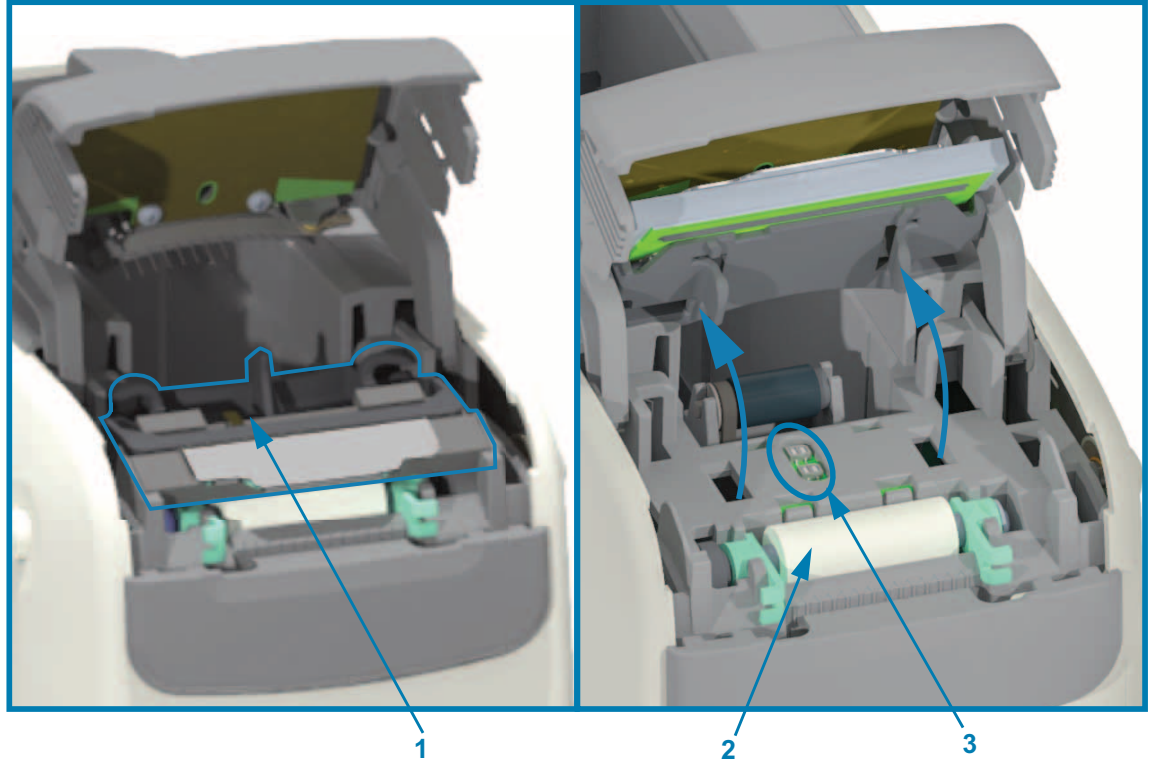

1	Printhead Assembly (Printhead cabling not shown)
2	Platen Roller Assembly
3	Dual Media Sensors

Media Cartridge Features

Zebra designed the media cartridge and printer for ease of use. Just insert a new cartridge into your printer and the printer performs several verification and setup operations. These include:

- Authenticates cartridge as genuine Zebra cartridge. This guarantees cartridge operation and print quality. Genuine Zebra media uses printer safe materials too.
- Checks media condition – how much media is in the cartridge
- Loads media (if present) automatically.
- Reads and sets the media based printing parameters – print speed, print darkness, print area and location, and media length.
- Programming and print format design are simpler without common media parameter setting provided by the cartridge.

Figure 6 •

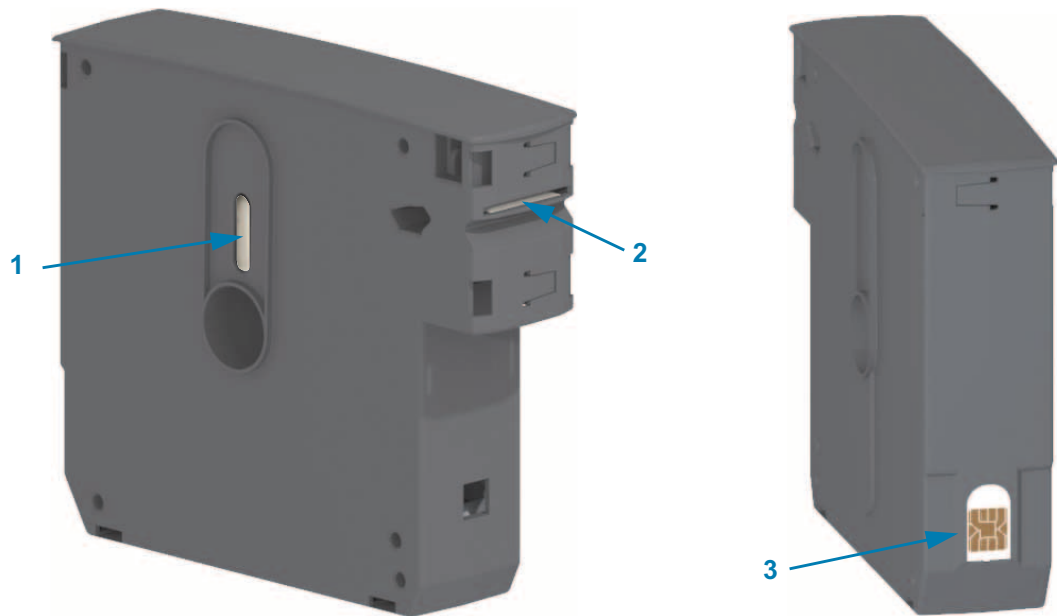

1	Media Window (for visual check of media)
2	Media Exit Slot
3	Cartridge Information Smart Chip (cartridge authentication and stored media data)

Go to the Zebra Web site for information for the latest information on media types for various uses and environments including antimicrobial coated wristbands. Different sizes, colors, and closure types of wristbands are available in recyclable media cartridges. Media cartridge support is also located on these web pages. Only Genuine Zebra™ supplies will work with your printer.

Get Genuine Zebra™ Supplies: www.zebra.com/supplies



Important • Media cartridges cannot be reused or refilled. Dispose of media cartridges in accordance with your local regulations or standards. For information on Zebra's recycling program, see <http://www.zebra.com/environment>.

Media Cartridge Handling and Use Cautions

The media in the cartridge is designed to only be accessed by the printer. The operator only needs to insert a new cartridge into the printer and the printer does the rest. The media is perforated between wristbands. The wristband will stop with perforation at the Media Exit's Tear Edge.

For best printer and media cartridge operation:

- Leave media in its protective packaging until you are ready to use it.
- Never touch the media until the printer has completed printing or feeding (advancing) media.
- Do not attempt to open the cartridge. You will permanently damage the cartridge.
- Do not attempt to pull media out of the cartridge. In many cases your cartridge will become permanently unusable.
- Do not attempt to pull media out of the printer (when the cartridge is in the printer).

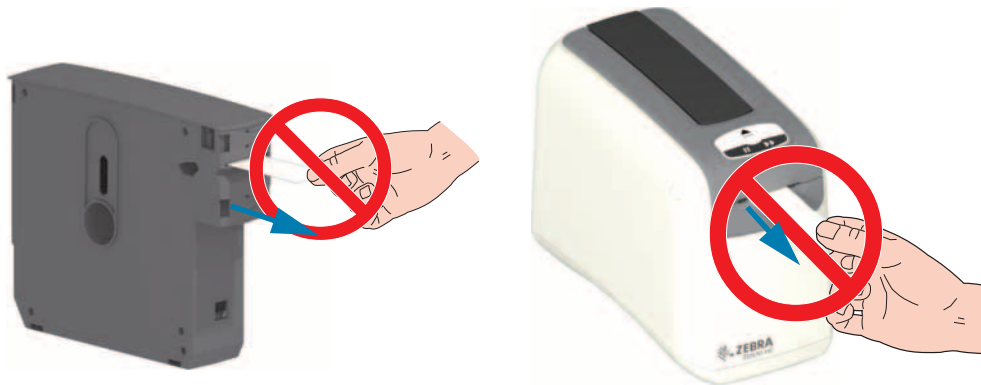

Important • Do not insert a media cartridge with media extending outside of the cartridge into your printer. Always remove the exposed media with scissors for a uniform cut. Insert the cartridge into the printer to see if the printer can recover the use of this cartridge.

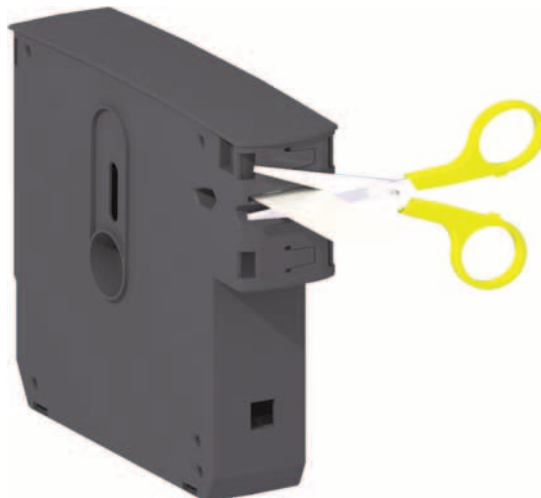

Media Storage Tips

- Store media in a clean, dry, cool, dark area. Direct thermal media is chemically treated to be heat sensitive. Direct sunlight or heat sources may 'expose' the media.
- Do not store media with chemicals or cleaning products.
- Leave media in its protective packaging until it is going to be put in the printer.
- Do not leave media cartridges loose. Place unused media cartridges back into cartridge packaging to protect it from damage or contamination. This protects the media from accidental damage and contamination to the Cartridge Information Smart Chip (and keeps people from handling loose media cartridges and damaging them).
- Many media types and adhesives have a 'shelf life' or expiration date. Always use the oldest, viable (non-expired) media first.

Opening the Upper Cover

The Upper Cover does not need to be opened during normal use and operation. Common reasons for opening are:

- **Printer Maintenance:** Cleaning the media path, sensor, printhead and platen roller.
 - **Troubleshooting:** The printer or cartridge had a fault where the cartridge media can not retract properly back into the cartridge for a normal cartridge eject.
 - **Accidental Immediate Cartridge Eject:** The PAUSE/FEED button was pressed for more than 6 seconds causing the cartridge to eject with the leading piece of media exposed. The Upper Cover must be opened to finish removing the cartridge. The PAUSE/FEED button feature is used by troubleshooting procedures. Always remove the exposed media with scissors for a uniform cut before re-inserting the media cartridge.
1. Press both Upper Cover Release buttons simultaneously. The Upper Cover springs open, partially.



2. **Partially Opened** — The printer is ready at this stage for removing the media cartridge with media or packaging material.
3. **Fully Opened** — Lift the Upper Cover up until it stops and tilt the Upper Cover back for better access. The media path, printhead, platen roller and media sensor are now accessible.

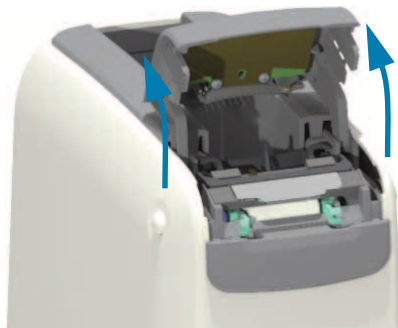

Manual Cartridge Eject

The printer is designed to allow you to remove a cartridge without power for shipping or troubleshooting operations. The cartridge can be removed using a flat blade screwdriver.



Electrical Shock Caution • Turn OFF the printer and disconnect it from the power source before performing the following procedure.

Eject Instructions

1. Turn OFF the printer and disconnect it from the power source before proceeding.
2. Insert the blade tip of a flat bladed screwdriver into the middle slot on the bottom of the printer. Place the screwdriver blade on the front half of the slot divided by the circular hole on the middle slot.
3. Push the side of the screwdriver blade into the hidden (black) release tab by pushing it towards the rear of the printer.
4. Flip the printer over and place it on you work surface. Verify the cartridge has released.

Figure 7 • Manual Cartridge Ejection

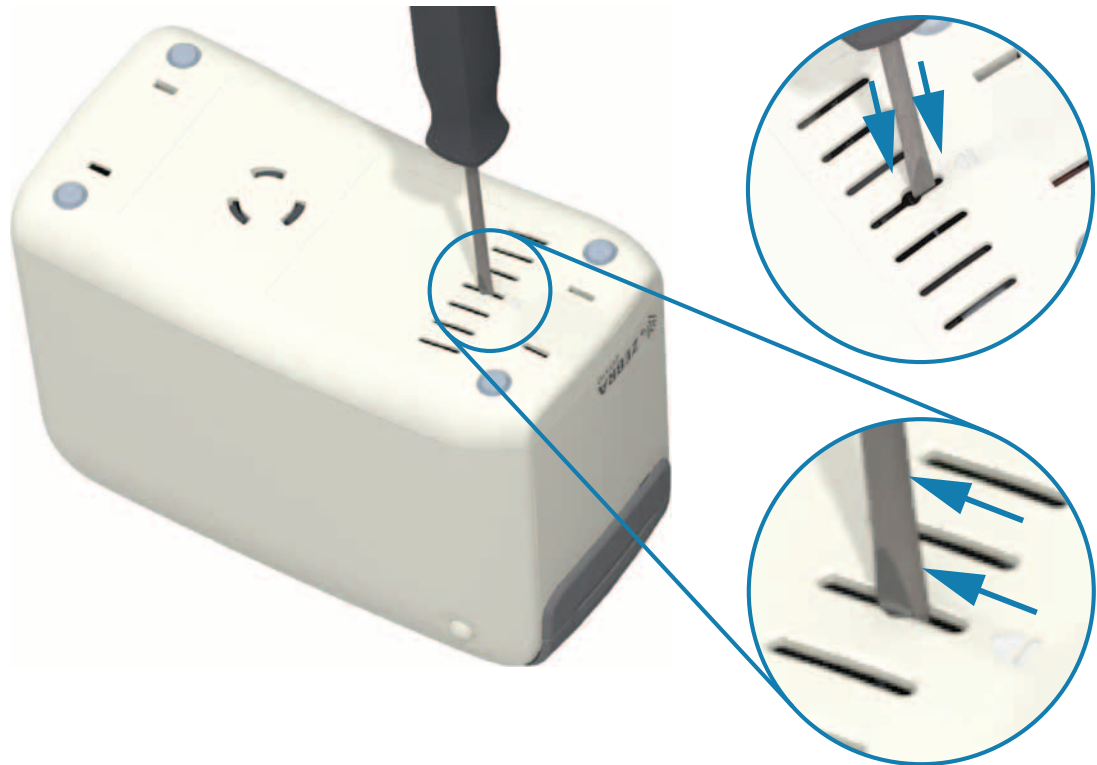

5. If media is stuck under the Upper Cover, press both of the Upper Cover Release Buttons to release the media. The Upper Cover will pop up and release the media cartridge's exposed media.

Figure 8 • Releasing Media Under the Upper Cover



6. Lift the media cartridge out of the printer.

Remove the exposed media coming out of the cartridge with scissors for a straight cut. This cartridge needs to be checked to see if it can load media properly after the media could not retract properly into the cartridge during normal operation.

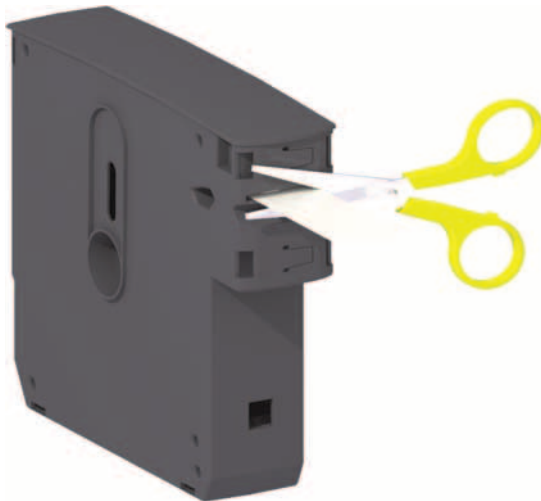

7. Press down on the Upper Cover to close the printer for use or reshipment.

Wristband Print Zone

The best area for printing varies by wristband type. For best results, design your wristband formats so that they print in the recommended print zone of the wristband (Figure 9). Avoid printing over the clip holes or the tamper-evident slits of these common types of wristbands sold by Zebra.

Figure 9 • Media Home Position and Recommended Print Zone

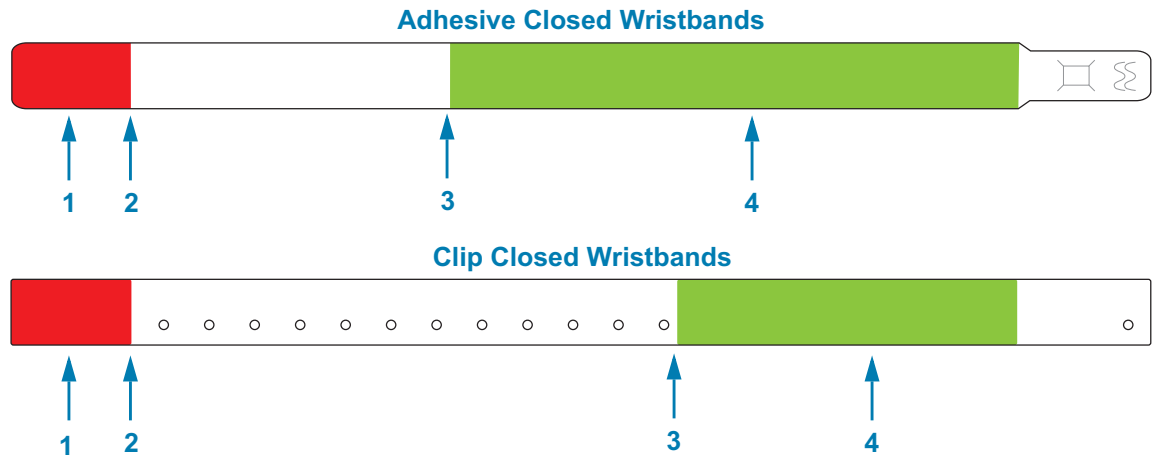

1	Non-printable area (shown in red)	You cannot print on approximately the first 25 mm (1 inch) of each wristband because the media does not backup into the printer.
2	Media home position	The media home position (0,0) occurs 25 mm (1 in.) from the leading edge of the wristband.
3	Recommended print start position	The start position from the leading edge of the wristband varies by wristband type (see Table 5-1).
4	Recommended print zone (shown in green)	This area is recommended for printing because it is visible on the patient after the wristband is secured.

Table 5-1 • Recommended Print Start Position by Wristband Type

Wristband Type/Style	Wristband Length	Start Position from the Leading Edge
Typical Adhesive Closed	279 mm (11 in.)	114 mm (4.5 in.)
	178 mm (7 in.)	64 mm (2.5 in.)
	152 mm (6 in.)	51 mm (2 in.)
Typical Clip Closed	279 mm (11 in.)	159 mm (6.25 in.)
	178 mm (7 in.)	83 mm (3.25 in.)

Zebra Print Touch

The Zebra Print Touch™ feature allows you to touch an Android™-based, Near Field Communication (NFC)-enabled device such as a smart phone or tablet to the printer's Print Touch logo to pair the device to the printer. This capability allows you to use your device to provide information for which you are prompted and then print a label using that information.



Important • Some mobile devices may not support NFC communication with the printer until you configure the required NFC settings in your device. If you encounter difficulties, consult your service provider or your smart device manufacturer for more information.



Data encoded into the tag includes:

- A URL for a Zebra QuickHelp style support web page
- The printer's unique Bluetooth Low Energy MAC address
- The printer's Bluetooth Classic MAC address (if present)
- The printer's Wi-Fi (WLAN) MAC address (if present)
- The printer's Ethernet (LAN) MAC address
- The printer SKU – ex. ZD42022-D01W01EZ
- The printer's unique serial number

The NFC tag can be used to:

- Facilitate Bluetooth pairing with a compatible mobile device
- Launch an application
- Launch a mobile browser to a web page

Controls and Indicators

The printer's operator interface has three (3) indicator groups and two (2) control buttons on the front of the printer, and a power switch in the rear of the printer. The indicators provide printer operating status and indicate printer alert and error conditions. The two (2) buttons and power switch can be used to operate the printer, assist in printer configuration, and control maintenance operations when used singularly or combined in various combinations.

Control Panel

The control panel is located on the top on the front of the printer. It is the majority of the printer's user interface.

Control Panel Indicators

The control panel has three indicator light groups that indicate: Media Status, Printer Status and (optional) WiFi Status (Figure 10).

Figure 10 • Control Panel Indicators

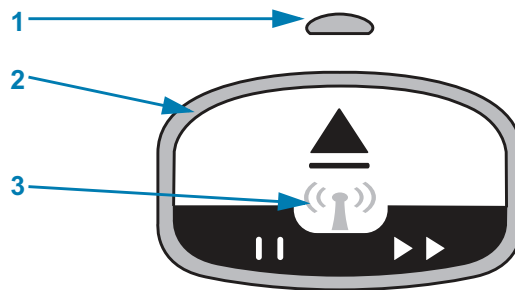

1	Media Status Indicator (see Meaning of the Indicator Light Patterns)
2	Printer Status Indicator (outer ring, see Meaning of the Indicator Light Patterns)
3	WiFi Status Indicator (see Wi-Fi Status - (Optional))

Control Panel Buttons

The control panel has two buttons (Figure 11). The action of pressing and then releasing a button will initiate the button's printer function.

Figure 11 • Control Panel Buttons

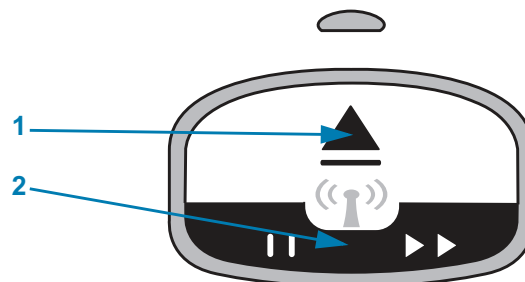

1	EJECT button
2	PAUSE/FEED button

Eject Button

This button functions only when the printer is idle or paused. The function depends on whether you press the button or press and hold it.

- **Pressing and releasing the EJECT button immediately** causes the printer to retract the current wristband and eject the media cartridge.
- **Pressing and holding the EJECT button for 6 seconds** force ejects the media cartridge without retracting the protruding wristband. This is used for troubleshooting wristband cartridge issues. See [Opening the Upper Cover](#).

Pause/Feed Button

PAUSE/FEED button has different functions depending the operating state and how long the button is pressed.

- **Pressing and releasing PAUSE/FEED** has two functions.
 - **Pause** — PAUSE/FEED functions as a Pause button when the printer is actively printing a wristband. While a wristband is printing, press the button to pause the printer before the next wristband starts printing. The printer remains paused until you press the button again.
 - **Feed (Advance)** — PAUSE/FEED functions as a Feed button to advance to the next wristband when the printer is idle. Press the button to 'feed' one blank wristband.
- **Pressing and holding the PAUSE/FEED button places the printer in User Configuration mode.** The printer status indicator lights blink orange in 2-second intervals, adding one blink each interval. Different actions take place depending on when you release PAUSE/FEED button is released:
 - **One orange blink** — A printer configuration wristband prints.
 - **Two orange blinks** — A media sensor profile prints.
 - **Three orange blinks** — The printer resets all print server parameters (wired Ethernet and wireless Ethernet) back to defaults. This is equivalent to sending the ZPL `^JUN^JUS` command.
 - **Four orange blinks** — The printer resets all printer parameters back to defaults. This is equivalent to sending the ZPL `^JUF^JUS` command.
 - **After four orange blinks, the printer exits User Configuration mode.** The printer status lights return to solid green. The printer feeds a wristband when you release PAUSE/FEED button.

Meaning of the Indicator Light Patterns

The Printer Status and Media Status indicators work together to inform the user about various printer operating conditions. The indicators may be OFF or ON in a variety of lighting patterns of green, orange and yellow. The status indicators can blink (flash), alternate between colors, alternate in patterns, or just remain on. The status information that these lighting patterns represent is detailed in this section.

Ready



The Ring Indicator is Solid Green: The printer is powered on and ready to print.

Paused



The Ring Indicator is Green with two (2) blinks OFF twice then a longer ON: The printer is paused. The operator must press the Pause button to resume print operations.

Media Low



The Ring Indicator is Solid Green. Media indicator is Orange: The media supply is low - 20 wristbands left is the default setting. Time to get new media.

Media Out



The Indicators blink ON and OFF Orange: Media has run out (typical), a media sensing error, or a cartridge error exists. Typically, replace the media cartridge to continue, otherwise refer to [Resolving Alerts and Errors](#).

Transferring Data



The Ring Indicator has a single rotating Green light: Data communications and processes are active

Upper Cover Open Alert/Media Path Error



The Upper Cover has been opened. Close the cover and press the Pause/Feed Button to reinitialize the installed cartridge, if present; otherwise refer to [Resolving Alerts and Errors](#).

Memory Storage Exception



A Orange Ring Indicator blinks OFF twice followed by a long ON - repeat: Data handling error (wrong file format, damaged data, programming syntax errors, etc.) or out of available memory for storing content (formats, graphics, fonts, etc.).

Operating Temp Alert



The Ring Indicator is Solid Orange. The internal printer operating range of temperature have been exceeded. The printer's operating environment may be too hot or cold to print properly - see [Operating Environment Conditions - Your printer is designed to function in a wide range of environments..](#) Let the printer sit to normalize to the specified operating temperature (and humidity) range.

If a print command or format/job is sent to the printer with a Operating Temp Alert, the printer will wait to begin printing if too hot, otherwise the printer will print. Printing begins when temperature drops to the safe to restart printing temperature.

Printhead Temp Shutdown



The Ring Indicator cycles Yellow lights ON one light at a time then turns OFF one light at a time, and repeats cycle. The printhead has reached thermal-shutdown to prevent damage. Let the printer cool. The printer will resume printing automatically.

Media Not Removed Alert



The Ring Indicator has a single rotating Orange light: Media has not been removed from the printer's Media Exit before beginning a new print or media Feed operation. Remove exposed media when the printer returns to a Ready condition and repeat printing (or Feed) operation.

Additional Printer Status Patterns

Printer maintenance, printer start-up, special functions, and test operations have indicator patterns not found during normal operations of the printer.

Wi-Fi Status - (Optional)

The Wi-Fi Status Indicator is located in the middle of the Control Panel. On printer's with the factory installed wireless communication option, the Wi-Fi Status indicator displays the connection state and quality of the wireless local area network (WLAN) connection.

Wi-Fi Associated to WLAN - Strong Signal



Wi-Fi Indicator is Solid Green: The printer is associated (or connected) with a wireless network. The signal strength is strong.

Wi-Fi Not Associated to WLAN - Strong Signal



Wi-Fi Indicator is Blinking Green: The printer is not NOT associated (or connected) with a wireless network. The signal strength is strong.

Wi-Fi Associated to WLAN - Weak Signal



Wi-Fi Indicator is Solid Orange: The printer is associated (or connected) with a wireless network. The signal strength is weak.

Wi-Fi Not Associated to WLAN - Weak Signal



Wi-Fi Indicator is Blinking Orange: The printer is not NOT associated (or connected) with a wireless network. The signal strength is weak.

Wi-Fi Not Associated WLAN - No Signal



Wi-Fi Indicator is OFF: The printer does not detect a wireless network, no signal.

Printer Setup

This section assists you in setting up and operating your printer for the first time. The setup process can be broken down into two (2) phases: hardware setup and host system (software/driver) setup. This section covers the physical hardware setup needed to print your first label.

Printer Setup Overview

- Place the printer in a safe location with access to power and where you can connect via a wired or wireless connection to your host system.
- Attach the printer and power supply to a grounded AC power source.
- Select a media cartridge for your printer.
- Turn the printer ON.
- Load the media.
- Print a 'Configuration Report' to verify basic printer operation.
- Turn the printer OFF.
- Choose method to communicate via a wired or wireless connection to your printer. Available wired local connections are:
 - USB port (Also used for wired and wireless Ethernet and Bluetooth setup)
 - Ethernet (LAN)
- Attach the printer cable to the network or host system (printer OFF).

Begin second phase of printer setup: typically [Setup for Windows® OS](#). This section provides instructions for setting up the printer, connecting it to your network, and preparing it for use.

Select a Location for the Printer

The printer and media need a clean safe area with moderate temperatures to have optimal print operations.

Select a location for the printer that meets these conditions:

- **Surface:** The surface where the printer will be located must be solid, level, and of sufficient size and strength to hold the printer with media.
- **Space:** The area where the printer will be located must include enough space for opening the printer (media access and cleaning), and for printer access to connectivity and power cords. To allow for proper ventilation and cooling, leave open space on all sides of the printer. Do not place objects on top of the printer or between the bottom of the printer and a solid flat work surface.



Important • Do not place any padding or cushioning material under or around the base of the printer because this restricts air flow and could cause the printer to overheat.

- **Power:** Put the printer close to an easily accessible power outlet.
- **Data Communication Interfaces:** Please ensure that cabling and Wi-Fi or Bluetooth radios do not exceed the maximum distance specified by the communication protocol standard or product data sheet for this printer. Radio signal strength can be reduced by physical barriers (objects, walls, etc.).
- **Data Cables:** Cables should not be routed with or near power cords or conduits, fluorescent lighting, transformers, microwave ovens, motors or other sources of electrical noise and interference. These interference sources may cause problems with communications, host system operation, and printer functionality.
- **Operating Environment Conditions** - Your printer is designed to function in a wide range of environments.
 - **Operational Temperature:** 32° to 104°F (0° to 40°C)
 - **Operational Humidity:** 20 to 85% non-condensing
 - **Non-Operational Temperature:** -40° to 140°F (-40° to 60°C)
 - **Non-Operational Humidity:** 5 to 85% non-condensing

Attaching Power



Caution • Never operate the printer and power supply in an area where they can get wet. Serious personal injury could result!



Note • Set up your printer so that you can handle the power cord easily if needed. Some processes for setup or troubleshooting issues may ask you to remove power. Separate the power cord from the power supply receptacle or AC electrical outlet to make certain the printer cannot carry electrical current.

1. Plug the power supply into the printer's DC power receptacle.
2. Insert the AC power cord into the power supply.
3. Plug the other end of the AC power cord into an appropriate AC electrical outlet. Please note that AC outlet end of the power cord's plug type can vary by region.
4. The active power light on the power supply will illuminate green if power is on at the AC outlet.

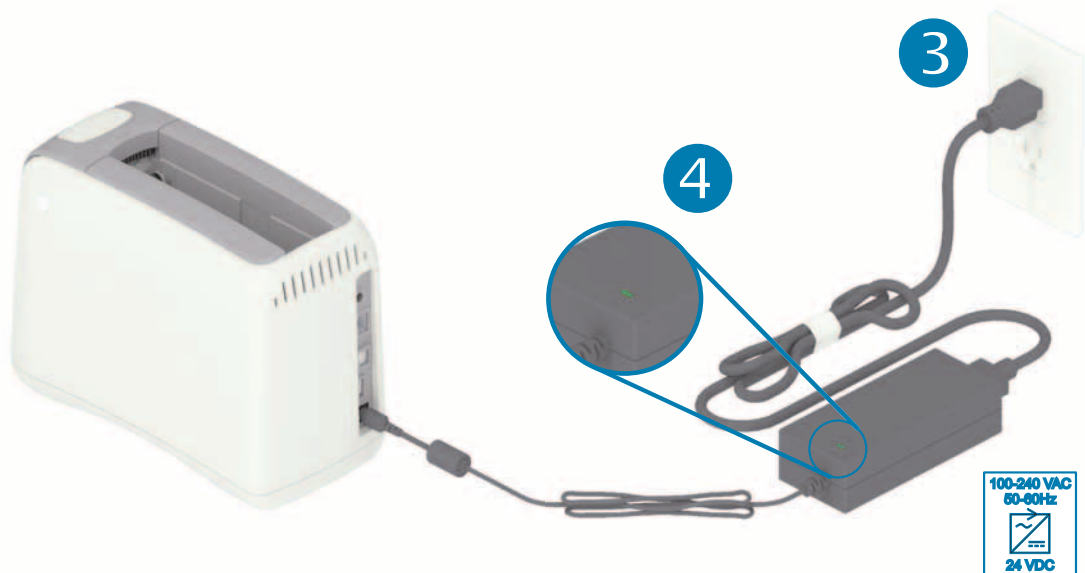
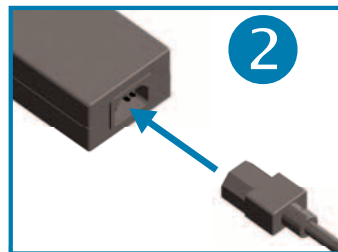
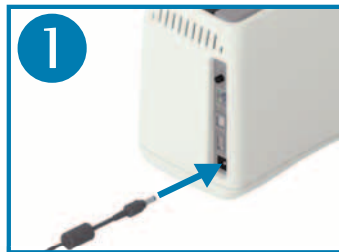

Important • Ensure the appropriate power cord with a three (3) prong plug and an IEC 60320-C13 connector are used at all times. These power cords must bear the relevant certification mark of the country in which the product is being used.

Loading the Media Cartridge

The Zebra media cartridge is a easy to load and use.

The printer only supports Zebra cartridge media. The media cartridge has a Smart Card chip that stores preset printing setting and media usage.

1. Turn the printer ON. Press the power button on the top of the printer's back panel.

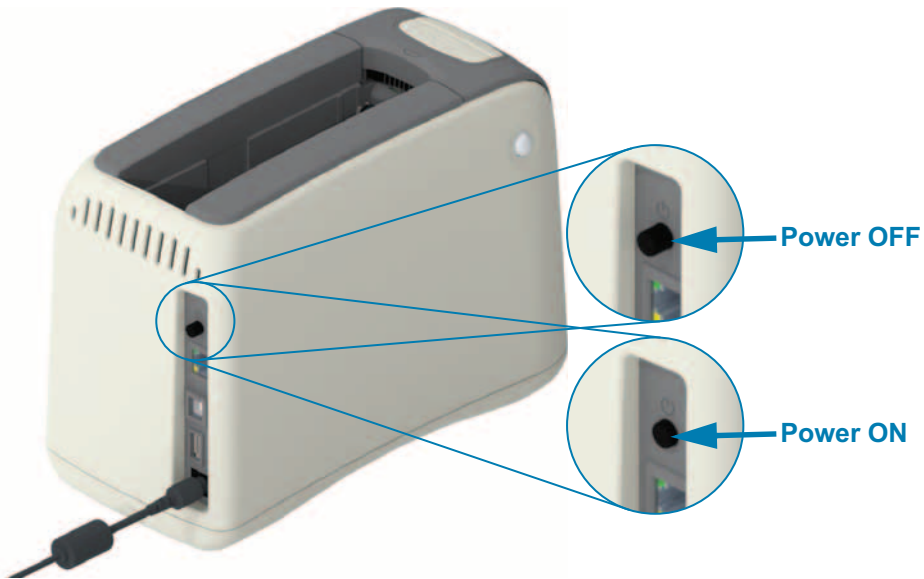

2. Wait while the printer performs a self-test and printer configuration. The control panel will cycle through various indicator light patterns. The printer will be ready for use when the media status indicator and the printer status indicator blink orange to indicate that there is no media in the printer.



Printer Setup

3. Orient the media cartridge and the printer as shown. Insert the cartridge into the printer. Press down in the middle of the cartridge (see arrow) until the cartridge locks with an audible click.



4. **Observe** - The printer prepares a wristband for printing, moves the media (wristband) to the Media Exit Slot (Ready to Print position), and reads the media cartridge's operating parameters and data.

Printer is Ready - The printer is 'Ready' to print when the Printer Status Indicator ring (1) turns green, and the Media Status Indicator (2) remains off. For other media conditions, see [Meaning of the Indicator Light Patterns](#).

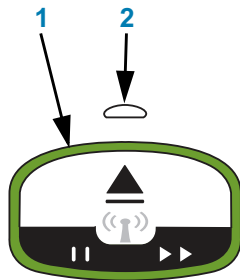

Important • Do Not Pull Media Out of the Cartridge. This can damage the cartridge. If media protrudes out of the cartridge, see [Media Cartridge Handling and Use Cautions](#).

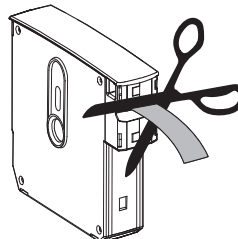
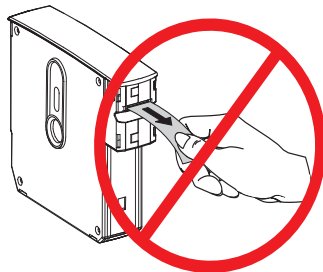

Test Printing with a Configuration Report

Perform the steps below to print a Configuration Report to verify basic printer operation. This report has some basic connectivity settings and the wristband tear-off position intended to assist setup.

Print a Configuration Report

1. Make sure that the printer is ON and ready to print.
2. Press and hold the PAUSE/FEED button. The green Printer Status Indicator will turn off, then blink orange ONCE. Immediately release PAUSE/FEED.
3. A printer Configuration Report prints.

Turn the printer off to continue printer setup.

Reading the printed ZD510 Configuration Report.

- **TEAR OFF ADJUST** - See the ZPL `~TA` command
- **USB COMM** - field shows if the printer is connected to a computer via the USB connector.
- **BLUETOOTH ADDRESS** - Displayed when the printer includes the factory installed Wireless Option.
- **FIRMWARE** - The printer's firmware (programming) version.
- **IP ADDRESS** and **MAC ADDRESS** - The IP ADDRESS field will have all zeros until the printer is associated/connected to a Ethernet network or manually assigned values. The printer's active (and primary) connection will be displayed for the IP ADDRESS (set automatically by DHCP networks or manually by the network administrator) and the corresponding MAC ADDRESS (of the wired or wireless hardware's interface/node) of printer and it's the internal print server. If you have both the wired and wireless Ethernet installed and connected, then the wired Ethernet is active by default. Note: use the SGD `ip.primary_network` command to change designated primary server to wireless.

Figure 12 • Sample Printer Configuration Report

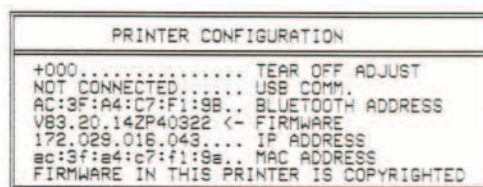

You can view all of the printer's settings and the full configuration report through:

- the printer's Print Server web pages
- or via programming using the ZPL `~HQ` command:
- Using Zebra Windows Driver, Zebra Setup Utilities, ZebraNet Bridge, or other developer programming tools by Zebra

Connecting your Printer to a Computer

The printer supports a variety of interface options and configurations. These include:

- Universal Serial Bus (USB 2.0) interface - Standard.
- Ethernet (LAN) - Standard.
- Internal Wi-Fi (802.11ac) and Bluetooth Classic 4.1 (3.0 Compatible) - Factory Installed Option.
- All models include Bluetooth Low Energy (BTLE) low speed wireless connection for printer configuration using an Android or iOS mobile device.

Pre-install Windows® Printer Drivers

Install the Zebra Setup Utilities (ZSU) before applying power to the printer connected to the PC. The utility installs the Zebra Windows drivers first. The ZSU installation wizard will then prompt you turn on the printer. Follow the instructions to complete your printer installation.

The Zebra Setup Utility is designed to assist you with installing your printer. The cabling and unique parameters for each of these physical printer communication interfaces is discussed in the following pages to assist you with making configuration setup choices prior to and immediately following applying power. The Zebra Setup Utilities configuration wizards will instruct you to turn the printer's power on at the appropriate time to complete the installation of your printer.

For more details on configuring network (Ethernet or Wi-Fi) and Bluetooth communication, see the following guides:

- Wired and Wireless Print Server User Guide
- Bluetooth Wireless Guide

Interface Cable Requirements

Data cables must be of fully shielded construction and fitted with metal or metalized connector shells. Shielded cables and connectors are required to prevent radiation and reception of electrical noise.

To minimize electrical noise pickup in the cable:

- Keep data cables as short as possible (1.83 m [6 foot] recommended).
- Do not tightly bundle the data cables with power cords.
- Do not tie the data cables to power wire conduits.



Important • This printer complies with FCC “Rules and Regulations,” Part 15, for Class B Equipment, using fully shielded data cables. Use of un-shielded cables may increase radiated emissions above the Class B limits.

USB Interface

Universal Serial Bus (version 2.0 compliant) provides a fast interface that is compatible with your existing PC hardware. USB's "plug and play" design makes installation easy. Multiple printers can share a single USB port/hub.

When using a USB cable, verify that the cable or cable packaging bears the "Certified USB™" mark (see below) to guarantee USB 2.0 compliance or higher.

Installation

1. Turn the printer power off.
2. Insert your USB cable into the printer

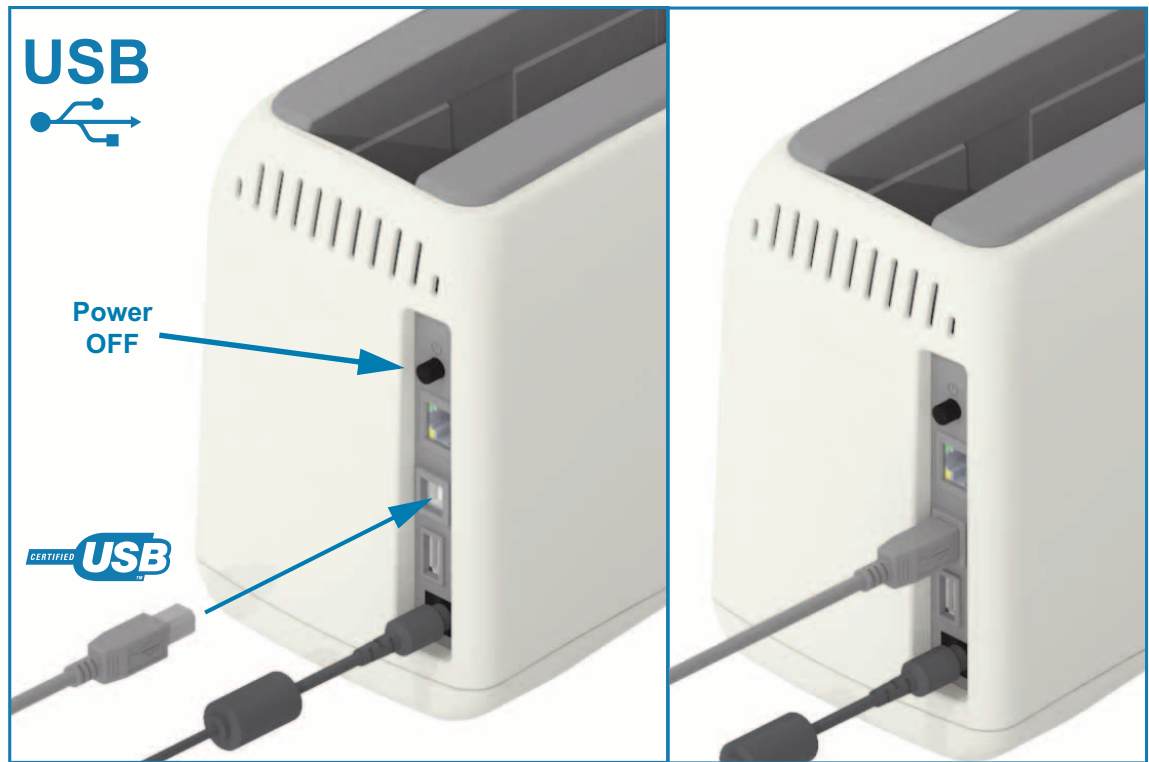

Ethernet (LAN, RJ-45)

The printer requires UTP RJ45 Ethernet cable rated CAT-5 or better.

The printer has a built-in network print server. For more information on configuring your printer to run on a compatible Ethernet based network, see the [Wired and Wireless Print Server users guide](#). The printer must be configured to run on your network. The print server on board your printer can be accessed through the printer's print server Web pages.

Installation

1. Insert your Ethernet cable into the printer

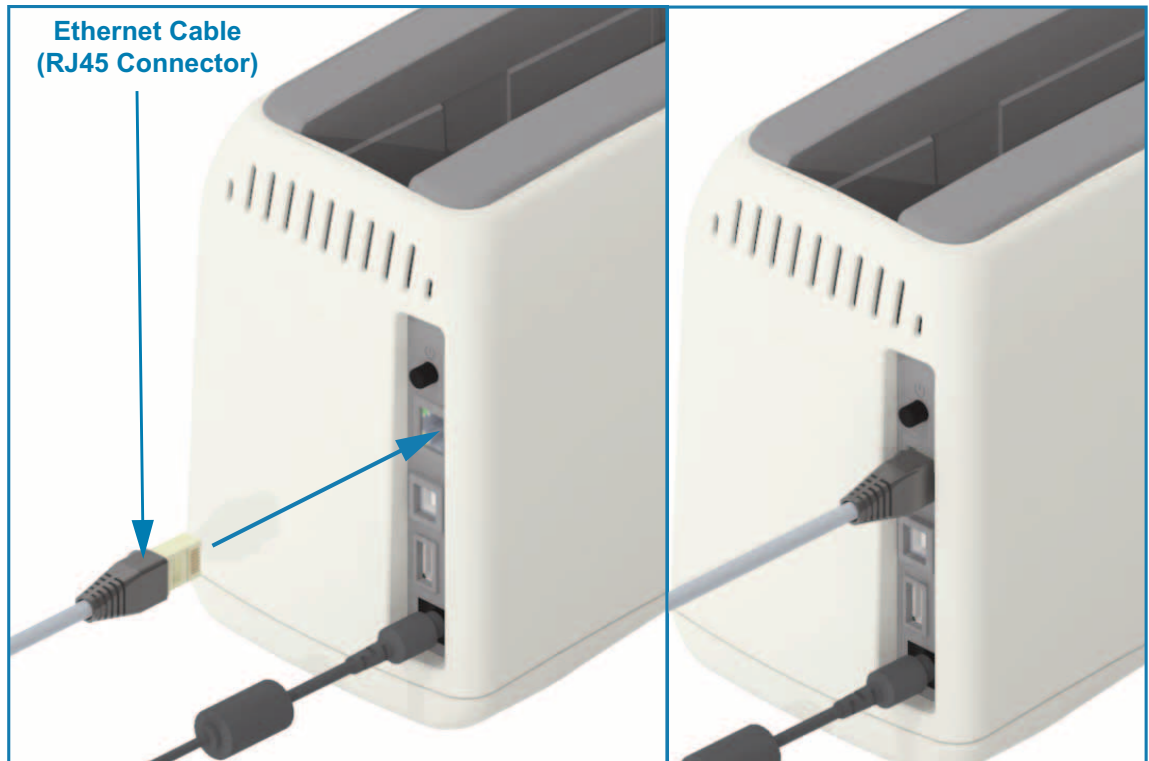

Ethernet Status/Activity Indicators

The Ethernet connector on the printer has two (2) status/activity indicators that are partially visible to provide interface status at the connector. The printer also has the user interface indicator lights for printer network operation status, see the [Wi-Fi Status - \(Optional\)](#) for more details.

LED Status	Description
Both OFF	No Ethernet link detected
Green	100 Mbps link detected
Green with the Amber flashing	100 Mbps link and Ethernet activity detected
Amber	10 Mbps link detected
Amber with the Green flashing	10 Mbps link and Ethernet activity detected

Assigning an IP Address for Network Access

All devices on an Ethernet network (LAN and WLAN) require a network IP (Internet Protocol) address. The printer's IP address is needed to access the printer for printing and printer configuration. The five different ways to assign an IP address are:

- DHCP (Dynamic Host Connection Protocol) - Default setting
- Zebra Setup Utilities (includes the ZebraDesigner Windows printer driver)
- Telnet
- Link-OS Mobile Apps
- ZebraNet Bridge

DHCP for Personal Networks

The printer by default is set to operate on a Ethernet LAN or Wi-Fi network with DHCP. This setting is intended primarily for personal networks or mixed DHCP and managed network addresses. The network automatically provides a new network IP address each time the printer is turned on when connected to that network. If an IP address is used to access the printer (instead of a printer's network name), the IP address will need to be changed for programs trying to access the printer. The newly DHCP assigned IP address is usually different each time the printer has been off a while.

Managed Networks

Using the printer in a structured network (LAN or Wi-Fi) requires a network administrator to assign the printer a Static IP address and other settings needed to operate on the network properly. The Windows printer driver allows you to use a Static IP address (or PERMANENT as identified in the printer's internal print server) to connect to the printer.

Accessing the Print Server via a web browser

The print server can be accessed via a web browser and the printer's IP address when connected to an Ethernet network. Verify the printer's IP Address by printing a Configuration Report, see [Test Printing with a Configuration Report](#) to print and view the primary Ethernet connection used by the printer.

- The printer has DHCP set by default, to allow your network to automatically assign the IP address for your printer.
- If an IP Address has not been assigned by any other means, such as a variety of Zebra tools, APPs, and utilities; then the an IP Address will need to be assigned

Print Server - Default User ID and Password

There are some features that require the default User ID and/or default password to access the printer's print server or if you have the Wi-Fi option in the printer. The Factory Default Values are shown below:

- **User ID:** [admin](#)
- **Password:** [1234](#)

Wi-Fi and Bluetooth Classic Wireless Connectivity Option

This guide covers basic configuration of your Internal Wi-Fi Print Server and Bluetooth Classic 4.X wireless connectivity option. This manual only covers installing the Wi-Fi as part of the Wi-Fi and Bluetooth Classic wireless connectivity option in the [Setting Up the Wi-Fi Print Server Option](#). See the Zebra Web site for **Wired and Wireless Print Server User Guide** for more information on the printer's Ethernet operation.

This manual only covers installing the Bluetooth as part of the Wi-Fi and Bluetooth Classic wireless connectivity option in the [Bluetooth Option Configuration](#). See the Zebra Web site for **Bluetooth Wireless Guide** for more information on the printer's Bluetooth operation.

Setup for Windows[®] OS

The section helps you setup communications between your printer and the Windows operating system environment.

Windows to Printer Communication Setup (Overview)

For supported Windows Operating systems (most common) with a Local (wired) connection:

- 1 • **Download the Zebra Setup Utilities** from the Zebra Web site.
ZD510 Wristband Printer — www.zebra.com/zd510-info
- 2 • **'Run' the Zebra Setup Utilities** from your Download directory.
- 3 • **Click on 'Install New Printer'** and run the install wizard.
- 4 • Select 'Install Printer'.and select your printer's model number from the list of ZDesigner printers.
- 5 • Select the USB port to connect to the PC. Use the interface to assist Wizard guided installation of networked or Bluetooth Classic (4.0).
- 6 • Turn the printer ON and configure printer communications for your interface type.
- 7 • Use the Windows driver to print a 'Test Print' to verify operation with Windows.

Pre-install Windows® Printer Drivers

Install the **Zebra Setup Utilities (ZSU)** **before** applying power to the printer connected to the PC (running a Zebra driver supported Windows operating system). The utility installs the Zebra Windows drivers first. The ZSU installation wizard will then prompt you to apply the printer power. Continue to follow the instructions to complete your printer installation.

The Zebra Setup Utility is designed to assist you setting up printer communication on a PC running the Windows operating system. The cabling and unique parameters for each of these physical printer communication interfaces is discussed in the following pages to assist you with making configuration setup choices prior to and immediately following applying power. The Zebra Setup Utilities configuration wizards will instruct you to turn the printer's power on at the appropriate time to complete the installation of your printer.

For more details on installing Ethernet (network) and Bluetooth interfaces:

- [Wired and Wireless Print Servers User Guide](#)
- [Bluetooth Wireless Guide](#)

Setting Up the Wi-Fi Print Server Option

This section covers basic configuration of your internal Wi-Fi Print Server option. For more detailed information, refer to the **Wired and Wireless Print Servers User Guide**.



Note • The wireless radio option, which includes Wi-Fi, Bluetooth classic and Bluetooth low energy, is only available as a factory installed configuration.

You may configure your printer for wireless operation in the following ways. This basic guide covers only the first option, the **Connectivity Wizard**.

- **Through the Connectivity Wizard**, which writes a ZPL script for you. On the last screen of the utility, you may choose to send the command directly to your printer, or you may choose to save the ZPL script to a file. The saved ZPL file has several purposes:
 - The file can be sent to the printer through any available connection (USB, or wired print server).
 - The file can be resent to the printer after the network settings have been restored to factory defaults.
 - The file can be sent to multiple printers that will use the same network settings.
- **Through ZPL** script that you write yourself. Use the `^WX` command to set the basic parameters for security type. You can send the command through any available connection (USB, or wired print server). Refer to the ZPL Programming Guide for more information on this option.
- **Through Set/Get/Do (SGD) commands** that you send to the printer. Begin with `wlan.security` to set the wireless security type. Depending on which security type that you select, other SGD commands will be necessary to specify other parameters. You can send the commands through any available connection (USB, or wired print server). Refer to the ZPL Programming Guide for more information on this option.

Configure Using the ZebraNet Bridge's Connectivity Wizard



Note • The preferred tool for connecting and configuring Link-OS printers to cloud, WLAN, and LAN; is now Link-OS Profile Manager. You can get Profile Manager and ZebraNet Bridge Enterprise (local and LAN configurations) utility is available through <http://www.zebra.com/software>. ZebraNet Bridge Enterprise version 1.2.5 or later is required to configure the printer correctly for use.

The Connectivity Wizard, which is part of this software, allows you to configure your printer easily for wireless operation by writing the appropriate ZPL script for you. Use this utility when you are first installing the wireless print server or after you set the network options back to factory defaults.



Note • You can only set up one print server at a time with the Connectivity Wizard. To configure multiple print servers (wired and wireless), run the program once for each print server.

To use the Connectivity Wizard, complete these steps:

1. If it is not already installed, install ZebraNet Bridge Enterprise on your computer.

You can get the program from the Zebra Web site at <http://www.zebra.com/software>.

2. Launch the ZebraNet Bridge Enterprise program.

If you are prompted for a serial number, you may click Cancel. You will still be able to use the Connectivity Wizard.

3. From the Menu bar, select Tools > Connectivity Wizard. The Connectivity Wizard opens.

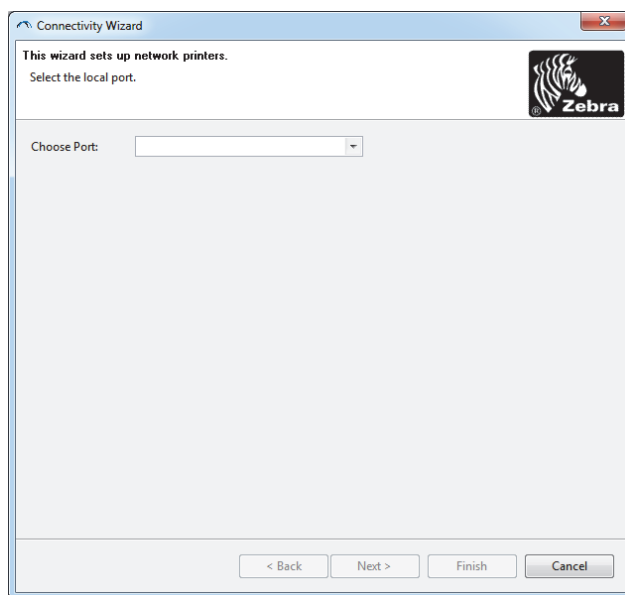

4. From the Choose Port list, select the port to which your printer is connected.
 - If you will save the file without sending it to the printer, you may select any available port.

- If you select File:, you will be asked to browse to the location of the file you want to save.



Note • If a port is in use by another device, it will not be included in the drop-down list.

5. Click Next.

The wizard prompts for the print server device to configure.

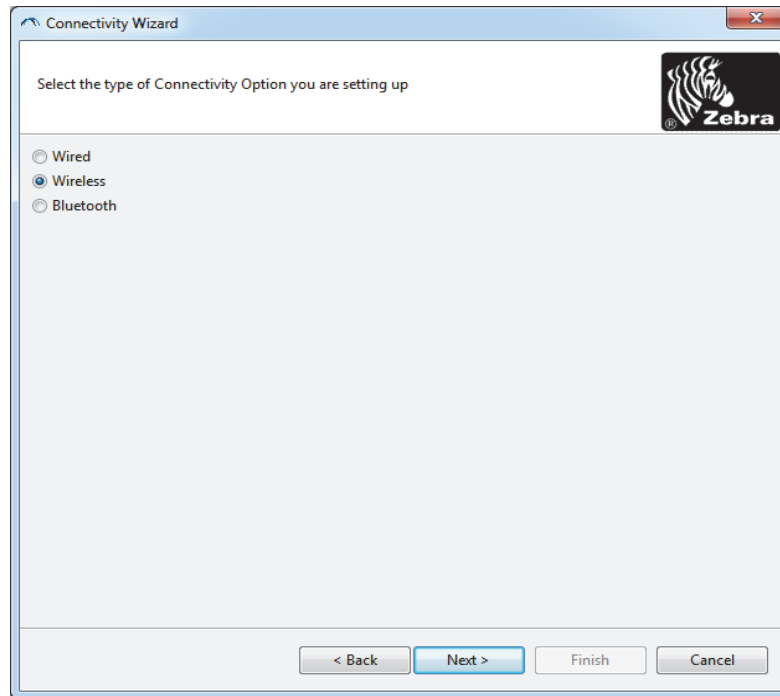

6. Select Wireless and then click Next.

The wizard prompts you for the type of printer you are using.

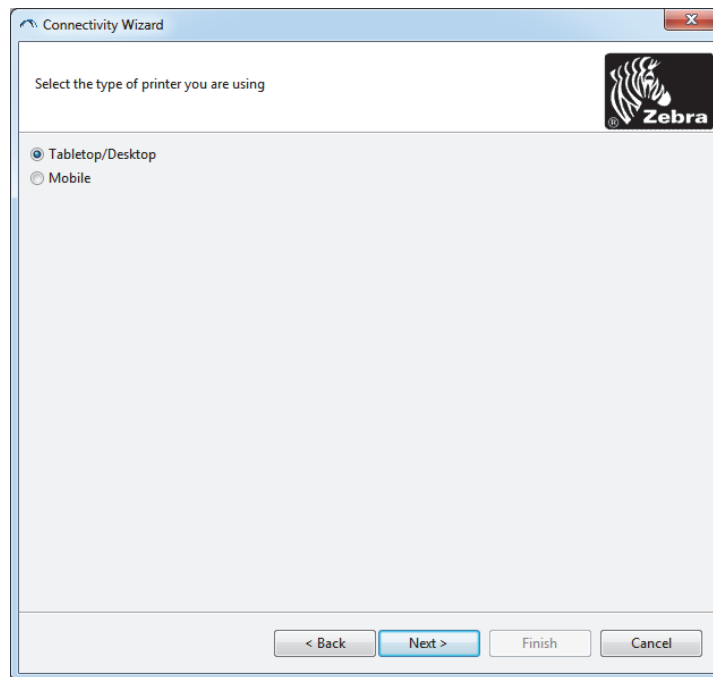

7. Select the type of printer you are using and then click Next.

The wizard prompts for the wireless IP information.

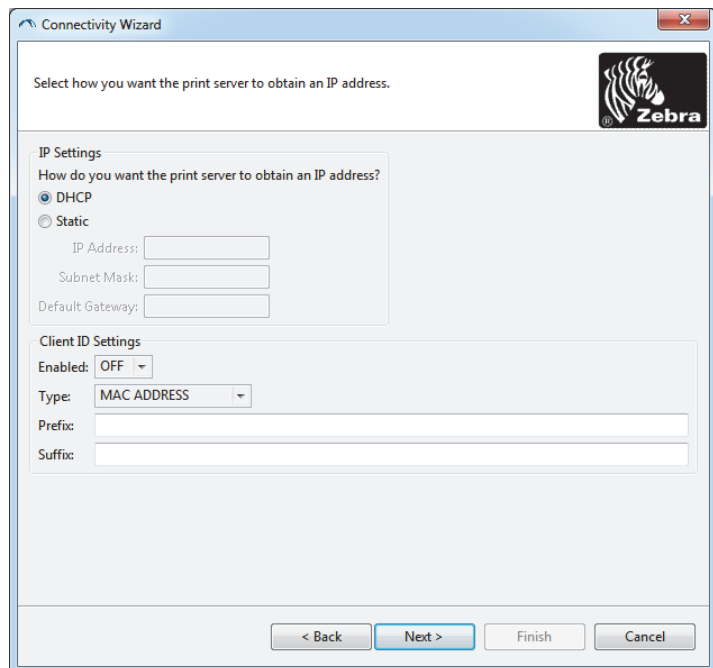

8. Enable the DHCP (dynamic) or static IP option.

If you will be using...	Complete the following steps...
DHCP	<ul style="list-style-type: none"> a. Select DHCP and click Next. b. Continue with step 9.
Static	<ul style="list-style-type: none"> c. Select Static. d. The IP settings fields are activated. e. Enter the IP Address, Default Gateway, and Subnet Mask for the wireless print server. Contact your network administrator for the correct values. f. Continue with step 9.

9. Click Next.

The Wireless Settings window opens.

10. Enter the ESSID.



Note • The ESSID and pass phrase, if used, must be set at your access point before completing these steps.

11. From the drop-down, select your Security Mode.

If you select...	Then...
None	Continue with step 12 .
WEP 40-Bit WEP 128-Bit	<p>a. In the WEP Options section of the window, enter the following values:</p> <ul style="list-style-type: none"> • Authentication type • WEP Index • Encryption Key Storage • WEP Keys <p>b. Click Next and continue with step 12.</p>
EAP-TLS EAP-TTLS EAP-FAST WPA-EAP-TLS	<p>In the EAP section of the window, if necessary:</p> <p>c. Enter the Optional Private Key.</p> <p>d. Click Next and continue with step 12.</p>
PEAP LEAP WPA-EAP-TTLS WPA-PEAP WPA-LEAP	<p>In the General Security section of the window:</p> <p>e. Enter the Security Username and Password.</p> <p>f. Click Next and continue with step 12.</p>
WPA-PSK	<p>In the WPA section of the window:</p> <p>g. Select the PSK Type.</p> <p>h. Enter the PSK Name.</p> <p>i. Click Next and continue with step 12.</p>
WPA-EAP-FAST	<p>j. In the General Security section of the window, enter the Security Username and Password.</p> <p>k. In the EAP section of the window, if necessary, enter the Optional Private Key.</p> <p>l. Click Next and continue with step 12.</p>
KERBEROS	<p>m. In the Kerberos Settings section of the window, enter the following values:</p> <ul style="list-style-type: none"> • Kerberos User • Kerberos Password • Kerberos Realm • Kerberos KDC <p>n. Click Next and continue with step 12.</p>



Note • KERBEROS is not supported on Internal Wireless Plus print servers or radio cards.

12. Click Advanced Options in the Wireless Settings window.

The Advanced Wireless Settings window opens.

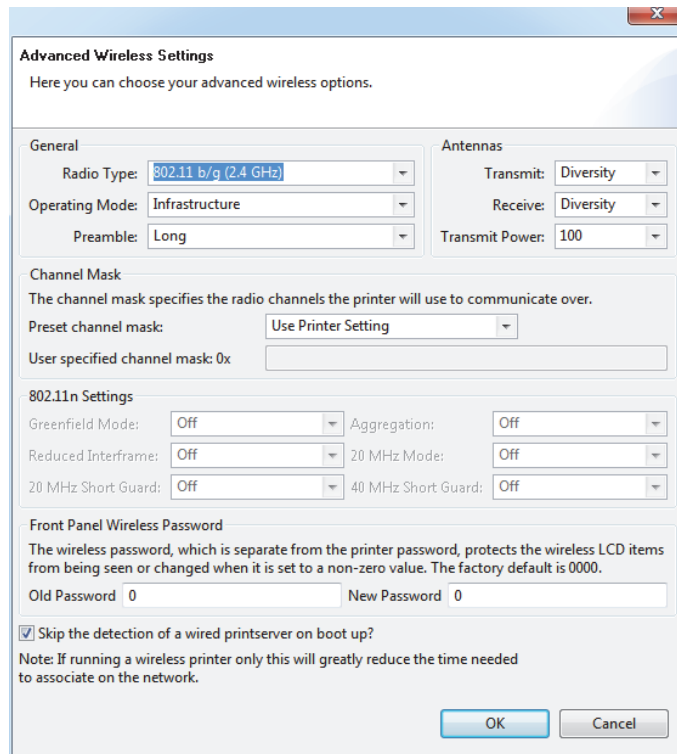

13. Review the settings in the Advanced Wireless Settings window. Change the settings as necessary, and then click OK.

The Wireless Settings window returns.

14. Click Next. Based on your selections in the Wireless Setup Wizard, the program writes the appropriate ZPL commands and displays them for your review. If you selected Tabletop/Desktop then the a dialog box similar to this displays.

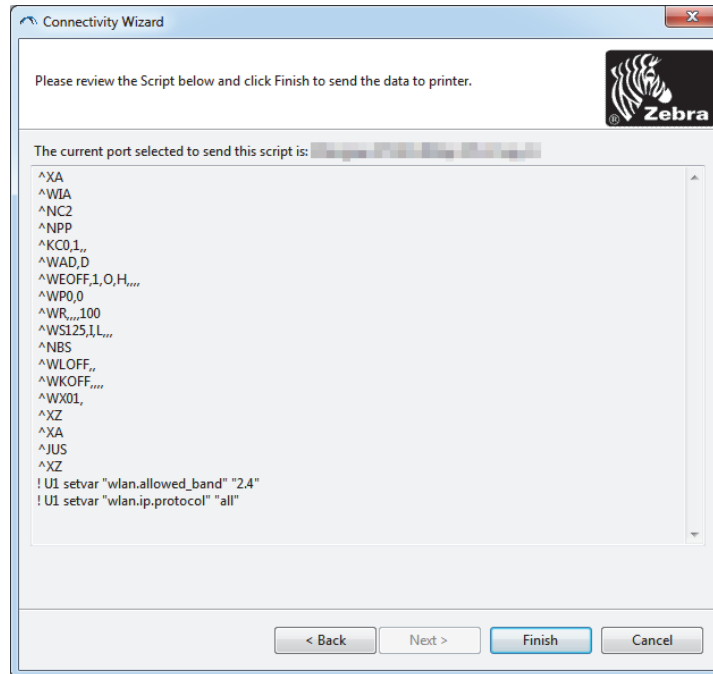

15. Determine if you will send the script immediately, or save it for use at a later time.

Using a Configuration Script

Complete setup by sending the ZPL script to the printer through the port selected at the beginning of this procedure

1. Verify that the printer is connected to the computer through the wired cable connection to USB port.
2. If you have not already done so, turn ON the printer.
3. On the Review and Send ZPL for Wireless window, click Finish.
4. The printer sends the ZPL script to the printer through the selected port. The Wireless Setup Wizard screen closes.
5. Turn the printer OFF and then back ON.

Saving a Configuration Script

Save the ZPL script to a file for use later or for use with other printers



Note • You can send the ZPL script file to multiple printers that use the same configuration, or you can send the file to a printer that had the network settings restored to the factory defaults. This saves you from having to go through the Wireless Setup Wizard more than once.

1. On the 'Review and Send ZPL for Wireless' window, highlight the script, right-click, and select Copy.
2. Open a text editor, such as Notepad, and paste the script into the application.
3. Save the script.
4. In the Connectivity Wizard, click Cancel to exit without sending the script at this time.
5. If you have not already done so, turn ON the printer.
6. Send the ZPL file to the printer through the connection of your choice.
7. Observe the wireless status on the printer's indicator lights, and confirm that you have set up your printer for wireless connectivity.

Bluetooth Option Configuration

The Zebra Setup Utilities provides a quick and easy way to configure a Bluetooth wireless connection with your printer.

1. Double-click the Zebra Setup Utilities icon on your desktop.
2. Connect a USB cable from your printer to your computer.
3. On the first ZSU screen, highlight the printer displayed in the window and click on the Configure Printer Connectivity where shown.
4. Select 'Bluetooth' on the Connectivity Type screen and click on the Next button.

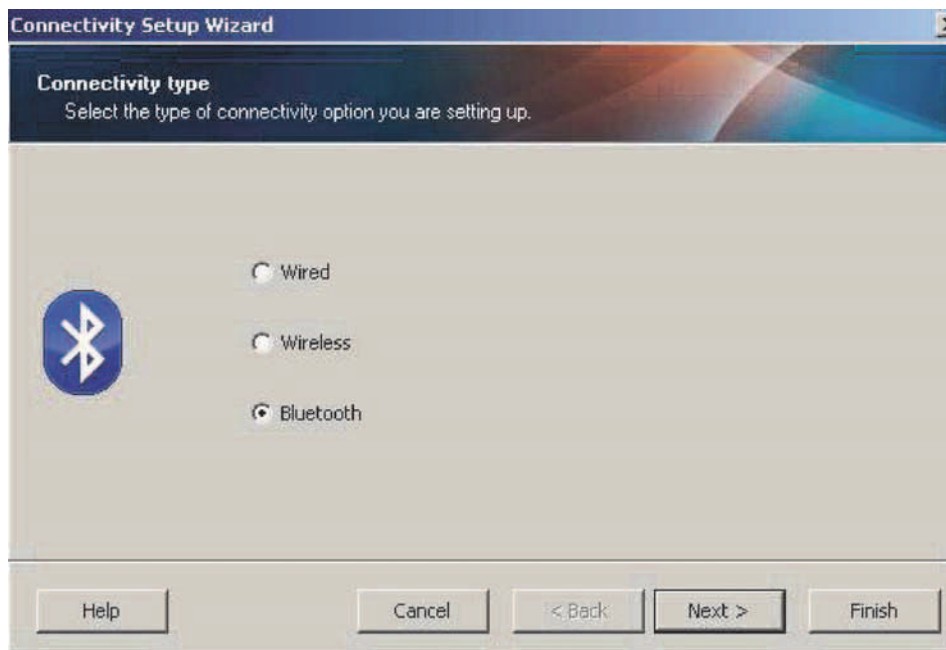

5. On the Bluetooth Settings screen, check "Enabled" to enable Bluetooth functionality.
6. In the Friendly Name text field, set the Bluetooth name of the device. This name appears during device discovery and the master device will label the printer with this name.
7. Set Discoverable to "On" or "Off" to set whether the device will appear when master devices are looking for new devices to pair with.
8. Set Authentication to "On." (Note: This setting does not exist in Link-OS, but you need to turn on if you want to enter a PIN in ZSU. Actual authentication setting on the printer is set in the Security Mode on the Advanced Settings menu.)
9. The values set in the Authentication PIN field will vary depending on the Bluetooth version of the master device. If the master uses BT v2.0 or older, enter a numeric value in this field. You will be prompted to enter this same value on the master device to verify pairing. Security Mode 2 or 3 in Advanced Settings should also be selected for PIN pairing.

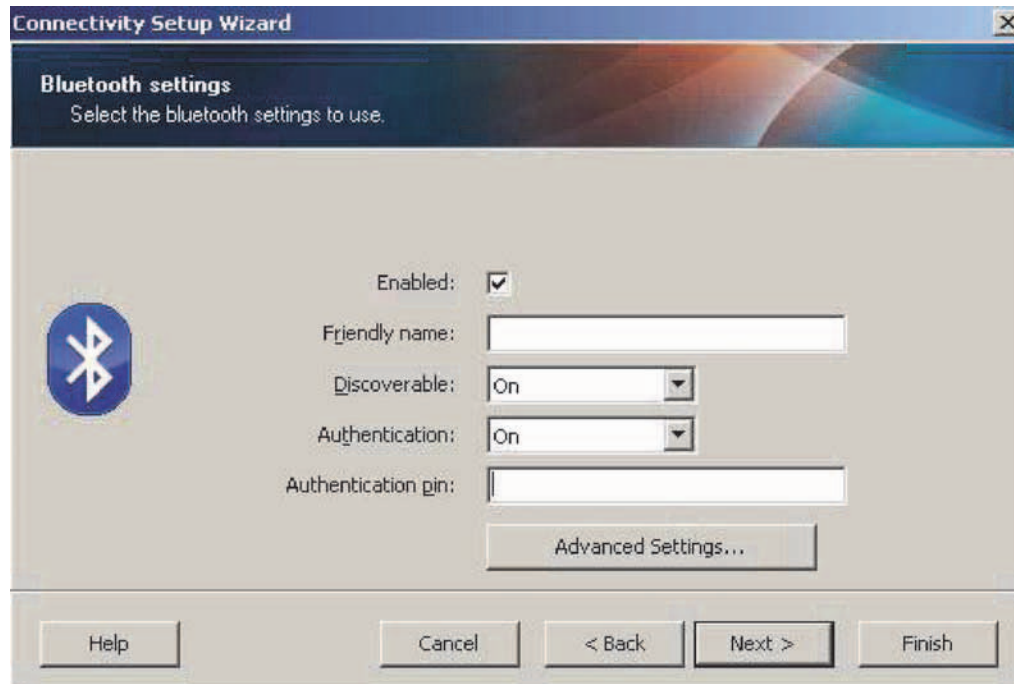

10. If the master device uses BT v2.1 or newer, this setting has no effect. BT v2.1 and newer uses Secure Simple Pairing (SSP) which does not require the use of a PIN.
11. Clicking on the Advanced Settings button will display the Advanced Bluetooth Settings window. For more information on Advanced Settings, refer to the **Wired and Wireless Print Server Guide**.
12. Click Next to continue configuring your printer.
13. The SGD commands to properly configure your printer will be displayed. Click Next to continue to the Send Data screen.
14. On the Send Data screen, click on the Printer that you want to send the commands to or click on the File button to save the commands to a file for reuse later.
15. To send the commands to the printer, click on the Finish button. The printer will update and then reboot. You may disconnect the USB interface from your printer now.
16. To complete the Bluetooth pairing process, enable Bluetooth device discovery on your master device and follow the directions provided with the master device.

Connecting to a Windows Vista® SP2 or Windows 7® Master Device

The Windows Vista (SP2 or higher) and Windows 7 Bluetooth install differs from the XP install.

- **Windows Vista:** Open the 'Add Printer' wizard by clicking the 'Start' button, clicking 'Control Panel', clicking 'Hardware and Sound', clicking 'Printers', and then clicking 'Add a printer'.
 - **Windows 7:** Open Devices and Printers by clicking the 'Start' button, and then, on the 'Start' menu, clicking 'Devices and Printers'
 - Some non-Microsoft Bluetooth dongles and built-in Bluetooth devices in the host PC's have marginal driver support for Secure Simple Paring (SSP) printing and may not complete the 'Add printer' wizard normally. You may need to go to the 'Bluetooth Devices' in the 'Control Panel' or from the system tray on the Windows 'Start' bar and activate SPP for the 'device', your Bluetooth printer you are installing. Install the printer to a local printer USB Port for your ZD510 printer) and then change the 'Port' after the install has completed to the SPP (virtual serial port) COM port.
1. Access the 'Devices and Printers' from the Windows Start menu.
 2. Check for Bluetooth devices in the 'Devices and Printers' window. Note the generic Windows Bluetooth icon below.

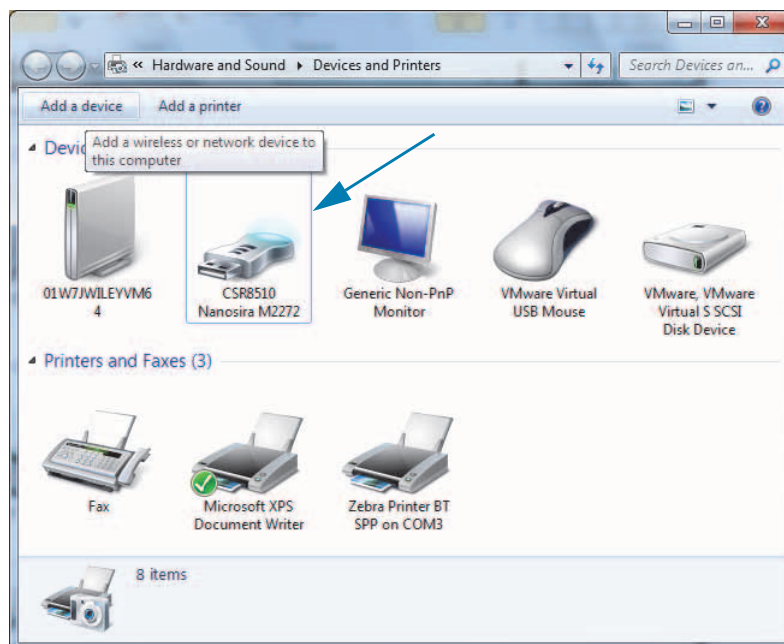

Setup for Windows® OS

3. Hover over the Bluetooth icon with the mouse pointer and the icon will highlight. Right-Click on the high-lighted Bluetooth icon. Select 'Bluetooth Settings' from the pop-up menu. Verify that both of the Connections check boxes are checked. Verify that the 'Turn off the Bluetooth adapter' is not checked. Click the 'Apply' button. Click the 'OK' button to close the window.

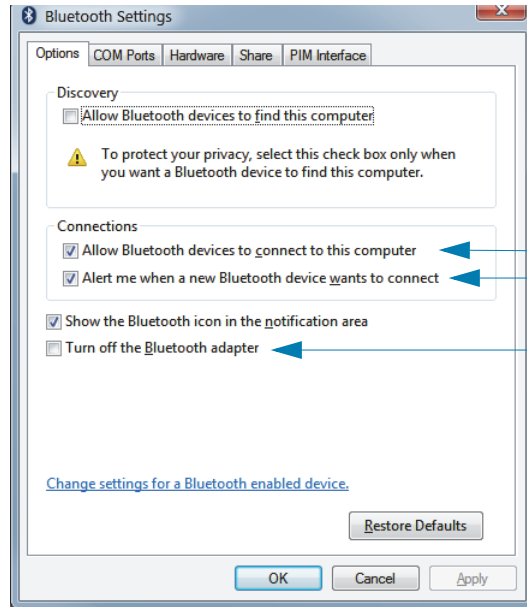

4. Click on the 'Add a device' in the top bar of the "Devices and Printers" window. The "Add a device" windows will populate with Bluetooth devices near you.
5. Turn the Bluetooth 4.0 (3.0 compatible) enabled Zebra printer on. After a few moments the "Add a device" windows will add your new printer. Click on the printer icon. Right-Click and select 'Add device'.

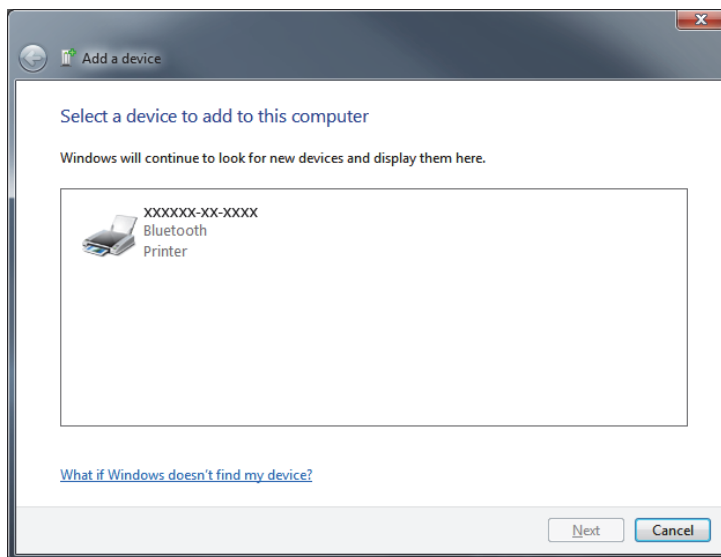

6. The printer will print a pairing code. Verify that the pairing numbers match with those on your display screen. If the numbers match, then press the 'Next button' in the 'Add a device' window.

Setup for Windows® OS

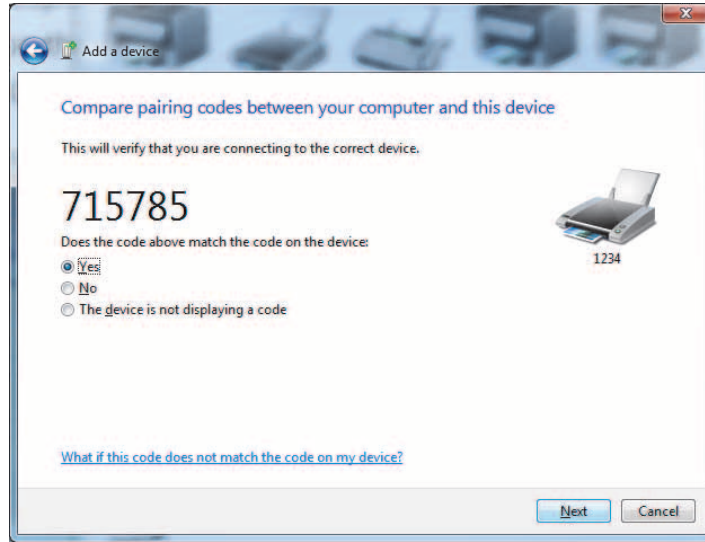

7. When the pairing process successfully completes, the following message will be displayed.

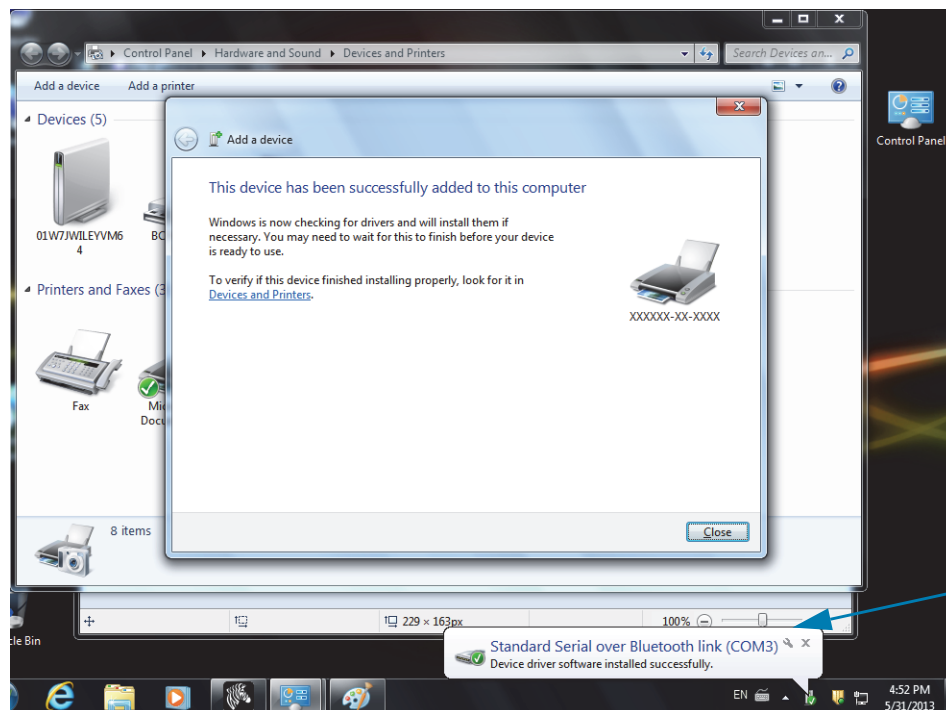

Note • The COM port number displayed in the task bar pop-up. It will only remain for a few seconds.

Connecting the Printer to a Windows 8

Before adding (also called pairing) a Bluetooth enabled device, make sure it is turned on and discoverable. As stated in the previous section under [Connecting to a Windows Vista® SP2 or Windows 7® Master Device](#), your Windows device may need a Bluetooth adapter to connect to Bluetooth device. Check with your device manufacturer's User Manual for further information.

1. Swipe in from the right edge of the screen or move your mouse towards the right edge of the screen, select **Settings**, and then select **Change PC Settings**.

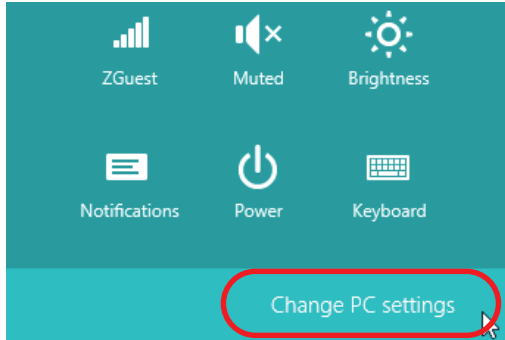

2. Select **PC and devices**, and then select **Bluetooth**. Once Windows displays the Bluetooth-enabled devices, select the device and click **Pair**.

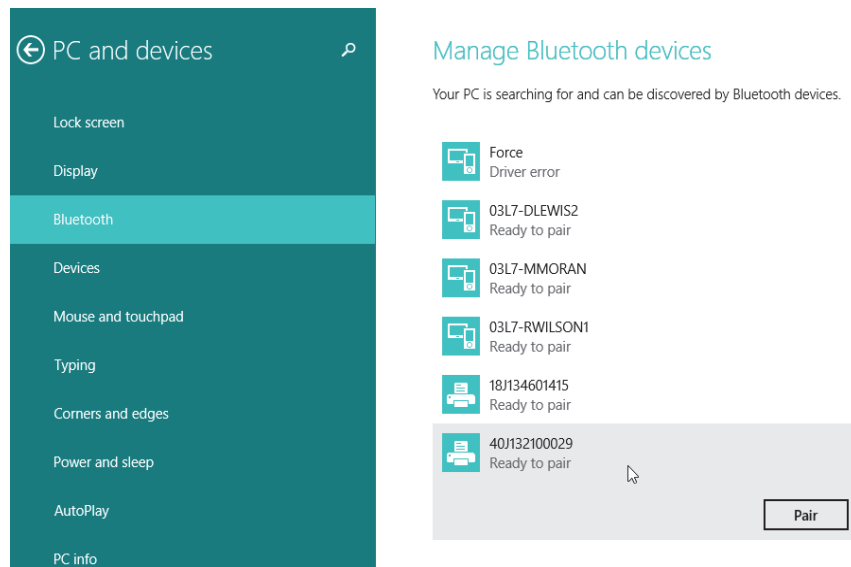

Note • Windows will display the pairing code for only 10 seconds, so complete this step quickly!

3. Follow the instructions on your screen to finish pairing your device.

Connecting the Printer to a Windows 10 PC

Before adding (also called pairing) a Bluetooth enabled device, make sure it is turned on and discoverable. As stated in the previous section under “Installing the Printer on a Windows 7 PC,” your Windows device may need a Bluetooth adapter to connect to Bluetooth device. Check with your device manufacturer’s User Manual for further information.

1. Open the Windows Start Menu by clicking on the Windows Start () button and select **Settings**.

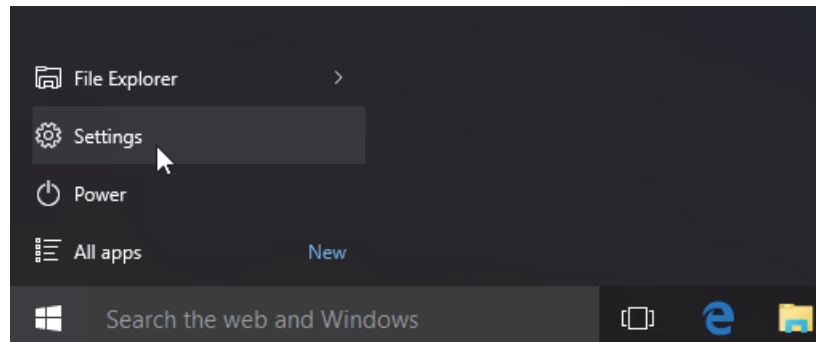

2. Click on the **Devices** category in the Settings window.

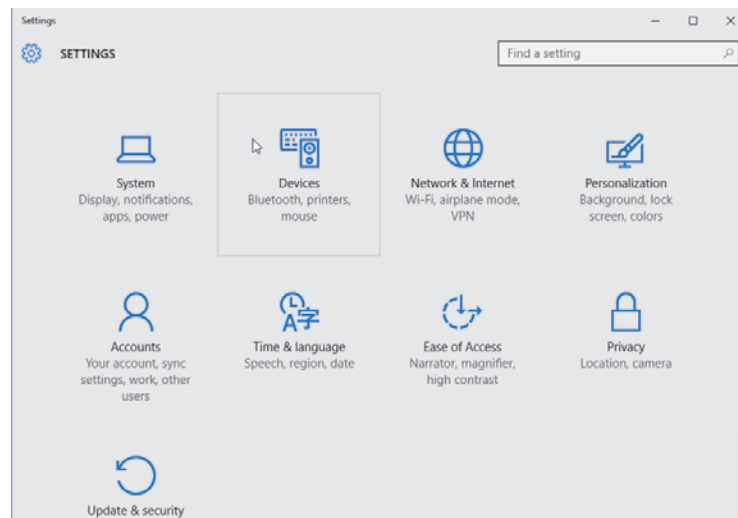

Setup for Windows® OS

3. Click on Bluetooth. If your PC doesn't have Bluetooth installed, the Bluetooth category will not be displayed in the list of device categories. The printer is identified by the serial number.

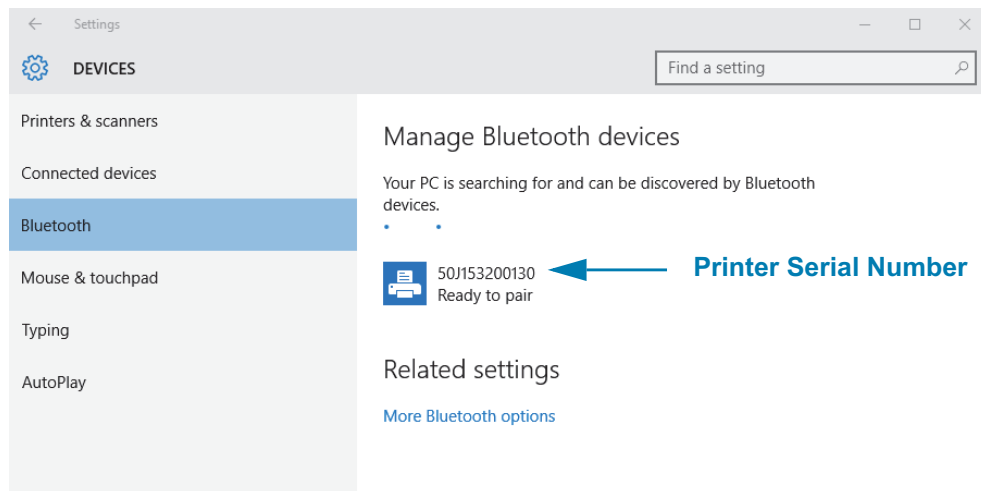

4. Click on the printer and then click on the 'pairing' button for the printer.

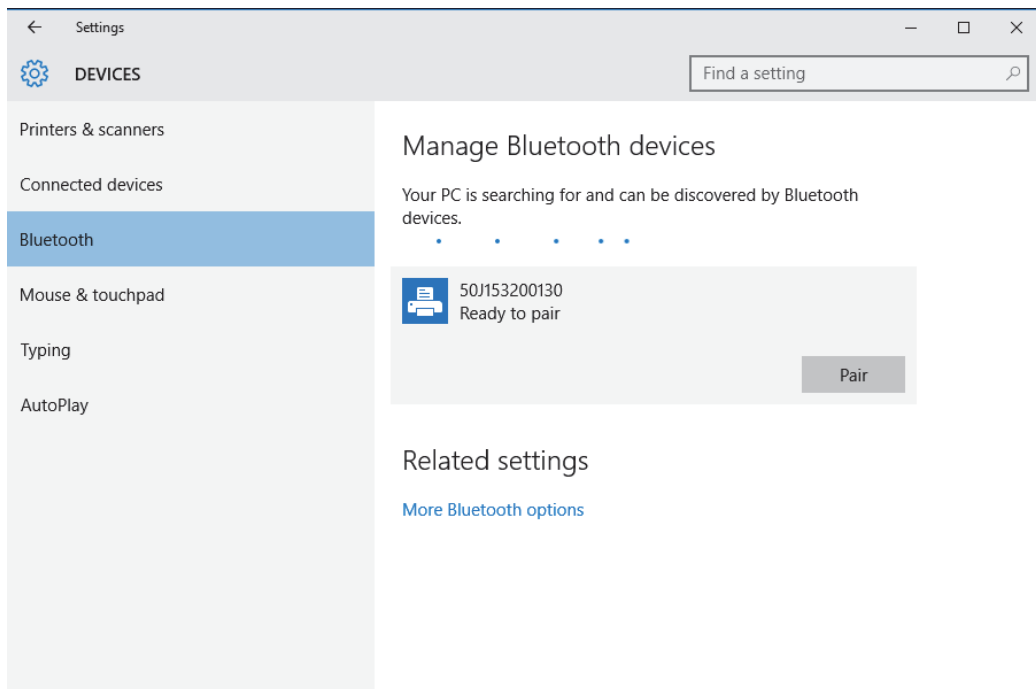

Setup for Windows® OS

- The printer will print a passcode. Compare that with the passcode showing on screen. Click 'Yes' if they match.

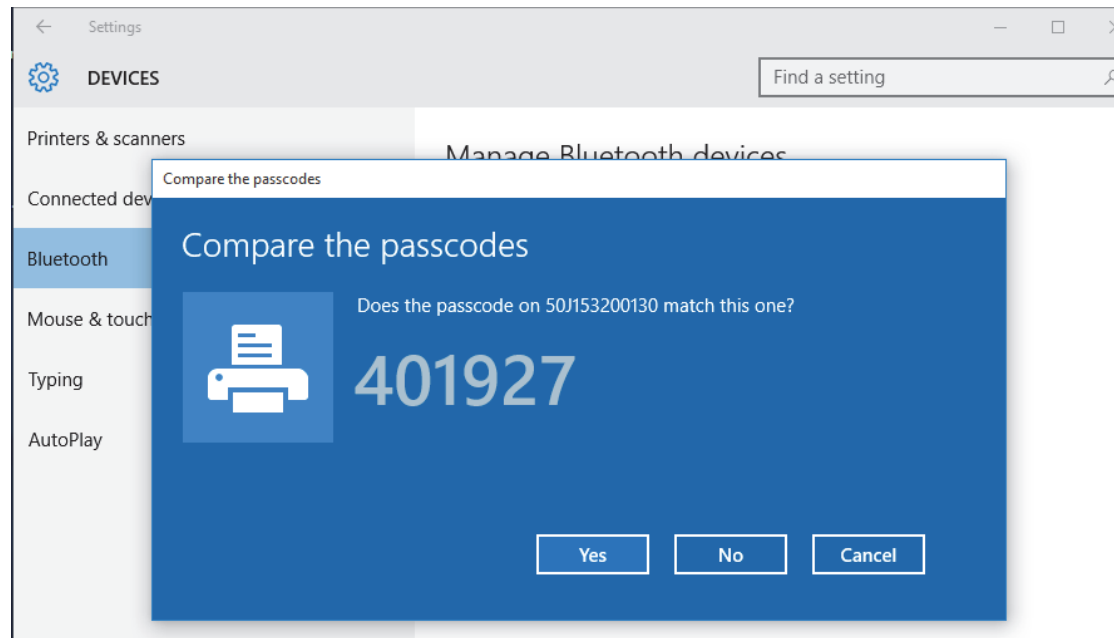

- The printer status changes to connected when pairing has completed.

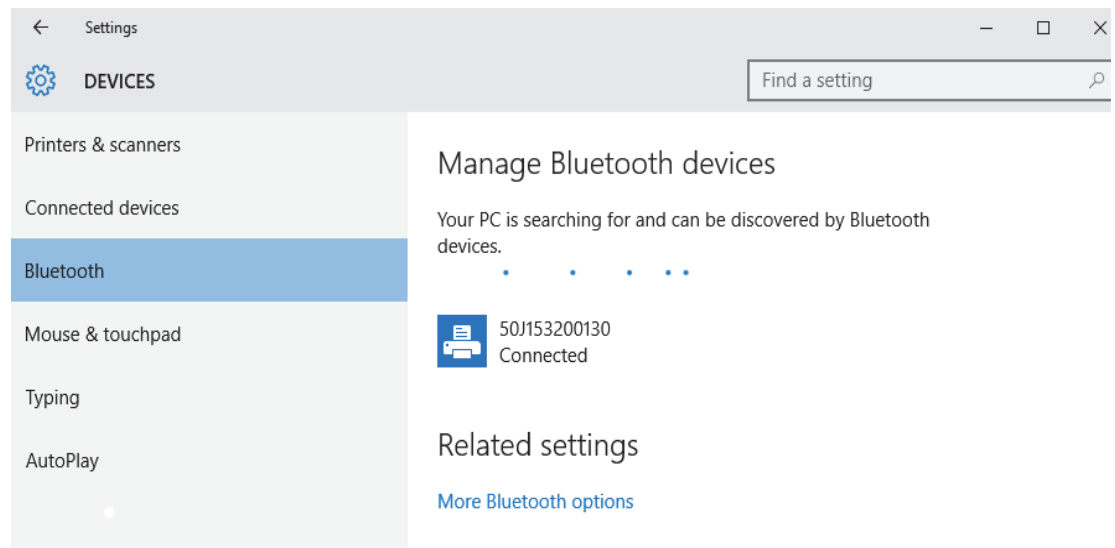

After Your Printer is Connected

Now that you have basic communication to your printer, you may want to test printer communications and then install other printer related applications, drivers or utilities.

Testing Communications by Printing

Verifying the print system's operation is a relatively simple process. For Windows operating systems, use the Zebra Setup Utility or the Windows 'Printers and Faxes' Control Panel to access and print a test label. For non-Windows operation systems, copy a basic ASCII text file with a single command (~WC) to print a configuration status label.

Test Printing with Zebra Setup Utility:

1. Open the Zebra Setup Utility.
2. Click on the newly installed printer's icon to select the printer and activate the printer configuration buttons below it in the window.
3. Click the 'Open Printer Tools' button.
4. In the 'Print' tab window, click on the 'Print configuration label' line and click on the 'Send' button. The printer should print a configuration report.

Test Printing with Windows 'Printer and Faxes' menu:

1. Click on the Windows 'Start' menu button, to access the 'Printers and Faxes' menu or 'Control Panel' to access the 'Printers and Faxes' menu. Open the menu.
2. Select the newly installed printer's icon to select the printer and right-click the mouse to access the printer 'Properties' menu.
3. From the printer's 'General' tab window, click on the 'Print Test Page' button. The printer should print a Windows test print page.

Test Print with an Ethernet printer connected to a network

Test Print on an Ethernet printer connected to a network (LAN or WLAN) with a (MS-DOS) 'Command Prompt' (or 'Run' from the Windows XP Start menu):

1. Create a text file with the following ASCII three characters: ~WC
2. Save the file as: **TEST.ZPL** (an arbitrary file name and extension name).
3. Read the IP address off the printer's Configuration Report's Network Status printout. On a system that is connected to the same LAN or WAN as the printer, type the following in the Web browser window's address bar and enter:
ftp (IP address)
(for IP address 123.45.67.01 it would be: **ftp 123.45.67.01**)
4. Type the word 'put' followed by the file name and enter. For this 'test print' file, it would be: **put TEST.ZPL**
The printer should print a new Print Configuration Report.

Advanced User Information

This section contains information and instructions that are intended only for advanced users or support personnel.

Accessing Printer Settings

The ZD510 Link-OS printer has many options for you to determine and set printer settings including the network configuration settings.

- The printer's integrated internal Print Server Web pages
- Zebra Setup Utility (Windows and Link-OS APPs)
- Zebra Windows Driver
- ZebraNet Bridge

The printer configuration wristband provides some basic information about the printer, particularly about the connectivity settings. If your printer has an active Ethernet wired or wireless connection, you can view all of the printer's settings through the printer's web pages.

Accessing the Printer's Web Pages

All ZD510 printers include an internal print server that can be accessed via the Ethernet connection (with the standard wired or the optional wireless option). A web browser that supports HTML v3.2 or higher is used to access the print server. Enter the printer's IP ADDRESS as displayed on the printer's Configuration Report printout (see [Test Printing with a Configuration Report](#)) in place of a web address name. The printer and accessing device (PC - personal computer, tablet, etc.) must be on the same LAN (local area network).

Figure 13 • ZD510 Print Server - Opening Screen

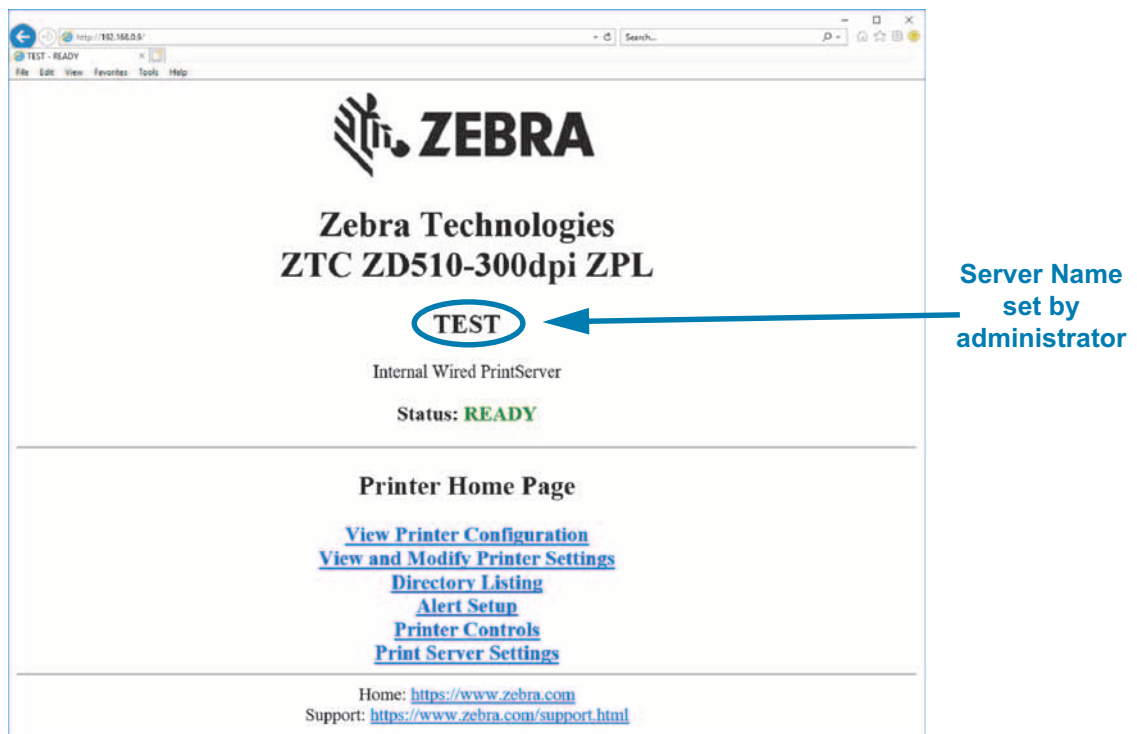

The View Printer Configuration web page is shown in [Figure 14](#). You can access this page for your printer by clicking **View Printer Configuration** on the printer home page. For more information about the web pages, see *Wired and Wireless Print Server manual*.

Figure 14 • View Printer Configuration Web Page (Printer Default Values Shown)

View Printer Configuration

+21.0	DARKNESS
CARTRIDGE	DARKNESS MODE
2.0 IPS	PRINT SPEED
+000	TEAR OFF ADJUST
TEAR OFF	PRINT MODE
MARK	MEDIA TYPE
REFLECTIVE	SENSOR SELECT
300	PRINT WIDTH
3147	LABEL LENGTH
39.0IN 988MM	MAXIMUM LENGTH
MAINT. OFF	EARLY WARNING
CONNECTED	USB COMM.
NORMAL MODE	COMMUNICATIONS
<~> 7EH	CONTROL PREFIX
<^> 5EH	FORMAT PREFIX
<,> 2CH	DELIMITER CHAR
ZPL II	ZPL MODE
INACTIVE	COMMAND OVERRIDE
+000	LABEL TOP
+0000	LEFT POSITION
DISABLED	REPRINT MODE
DPCSWFXM	MODES ENABLED
.....	MODES DISABLED
672 12/MM FULL	RESOLUTION
5.1	LINK-OS VERSION
V83.20.14ZP40363 <-	FIRMWARE
1.3	XML SCHEMA
6.5.0 0.13	HARDWARE ID
8192k.....R:	RAM
65536k.....E:	ONBOARD FLASH
NONE	FORMAT CONVERT
04/01/18	RTC DATE
14:14	RTC TIME
DISABLED	ZBI
2.1	ZBI VERSION
READY	ZBI STATUS
35 LABELS	NONRESET CNTR
35 LABELS	RESET CNTR1
35 LABELS	RESET CNTR2
866 IN	NONRESET CNTR
867 IN	RESET CNTR1
867 IN	RESET CNTR2
2,201 CM	NONRESET CNTR
2,201 CM	RESET CNTR1
2,201 CM	RESET CNTR2
0	MASS STORAGE COUNT
0	HID COUNT
OFF	USB HOST LOCK OUT



Note • If you select the 'Print on Label' option, a Printer Configuration Report wristband will print. It has a small subset of the information available on the Web page or accessed via software, see [Test Printing with a Configuration Report](#) to view a sample print.

To access printer settings through the web pages, complete these steps:

5. On the printer home page, click **View and Modify Printer Settings**.

The printer prompts for a password.

6. Enter the password for your printer. The default password is **1234**.

7. Click **Submit Changes**.

The following statement appears:

**Access Granted. This IP Address now has admin access to the restricted printer pages.
Please Click here to proceed**

8. Click on the statement.

The View and Modify Printer Settings page displays.

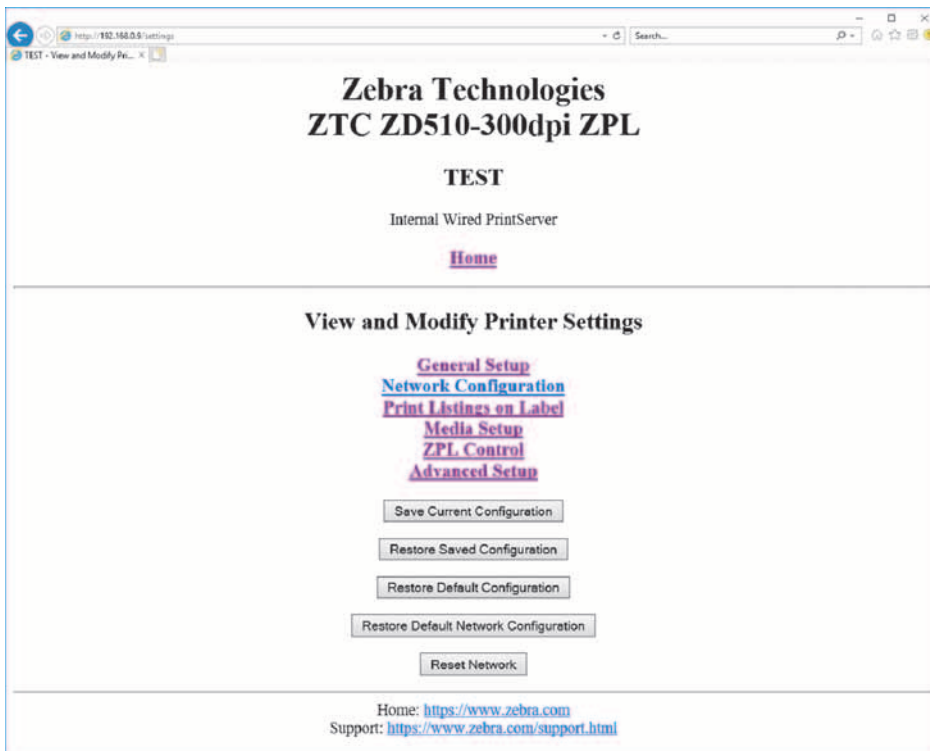

9. Modify the settings as needed.

For additional information, refer to the manuals for your wired or wireless print server. Copies of the manuals are available at: <http://www.zebra.com/manuals>

Changing and Restoring Printer Settings

The ZD510 Link-OS printer is designed to make printing as easy for the operator. The printer automatically adjusts the settings based on the type of media cartridge that you insert. You will not usually need to adjust these settings.

If necessary, you can adjust the printer settings to obtain optimal print quality or to change connectivity parameters. You do this through Zebra Programming Language commands, Set/Get/Do (SGD) commands, or through the printer's web pages. The printer requires an active wired or wireless Ethernet connection for you to access the printer's web pages.

For the ZPL commands and SGD commands, see the ZPL Programming Guide. A copy of this manual is available at: <http://www.zebra.com/manuals>

For instructions on accessing the printer's web pages, see [Accessing the Printer's Web Pages](#).

Commonly Used ZD510 Printer Settings

Use programming or the printer's print server web page to change or view these settings. These are a small subset of the command languages and commands available to configure your print. Creating print formats and printer customization requires programming or use of other software such as the free Zebra Label Designer software for Windows or the ZPL Programming Guide.

Darkness Mode Setting

Description: The printer has three darkness modes, which determine how the DARKNESS value is set.

Accepted values: [CARTRIDGE](#) (Default)

- [CARTRIDGE](#)—DARKNESS is set to the media cartridge default value. No changes are allowed, and the printer ignores ZPL commands that change the darkness value.
- [USER](#)—DARKNESS is set by the user, and the printer ignores the media cartridge default value. This darkness value is used for all media cartridges that are inserted into the printer.
- [RELATIVE](#)—DARKNESS is stored as the difference between the current darkness setting and the current media cartridge default value. The printer adds this difference to the default darkness value of any subsequent media cartridges.

Related ZPL command(s): [None](#)

SGD command used: [media.darkness_mode](#)

Print Server web page: [View and Modify Printer Settings](#) > [General Setup](#) > [Darkness](#)

Darkness Setting

Description: Set the print darkness to the lowest setting that provides good print quality. If you set the darkness too high, the image may not print clearly, barcodes may not scan correctly, or the printhead may wear prematurely.

Accepted values: Typically, the value is **21**. Range: **0.0** to **30.0** (available when the darkness mode is set to USER or RELATIVE; ignored when the darkness mode is set to CARTRIDGE)

Related ZPL command(s): ^MD, ~SD

SGD command used: `print.tone`

Print Server web page: [View and Modify Printer Settings > General Setup > Darkness](#)

Print Width Setting

Description: Set the print darkness to the lowest setting that provides good print quality. If you set the darkness too high, the image may not print clearly, barcodes may not scan correctly, or the printhead may wear prematurely.

Accepted values: Typically, the value is **21**. Range: **0.0** to **30.0** (available when the darkness mode is set to USER or RELATIVE; ignored when the darkness mode is set to CARTRIDGE)

Related ZPL command(s): The ^PW ZPL command is ignored.

SGD command used: `ezpl.print_width`

Print Server web page: [View and Modify Printer Settings > Media Setup > Print Width \(View Only\)](#)

Tear Off Setting

Description: This parameter adjusts the resting position of the wristband after printing. Higher numbers move the wristband farther out of the printer while lower numbers move the wristband farther inside the printer.

- Lower numbers move the media into the printer by the specified number of dots (the tear line moves closer to the edge of the label just printed).
- Higher numbers move the media out of the printer.

Accepted values: 0 to 120 Default: 0

Related ZPL command(s): ~TA

SGD command used: `ezpl.tear_off`

Print Server web page: [View and Modify Printer Settings > General Setup > Tear Off](#)

Label Top

Description: Shifts the position of the image vertically on the label if necessary.

- Positive number change moves the image closer to the leading edge of media as it exits the printer by the specified number of dots..
- Reducing numbers move the image away from the leading edge of media by the specified number of dots.

Accepted values: 0 to 120

Related ZPL command(s): ^LT

SGD command used: `media.printmode`

Print Server web page: [View and Modify Printer Settings](#) > [General Setup](#)

Load Defaults

Description: Restore specific printer, print server, and network settings back to the factory defaults. Use care when loading defaults because you will need to reload all settings that you changed manually.

Accepted values:

- **FACTORY**—Restores all printer settings other than the network settings back to the factory defaults. Use care when loading defaults because you will need to reload all settings that you changed manually.
- **NETWORK**—Reinitializes the printer's wired or wireless print server. With a wireless print server, the printer also reassociates with your wireless network.
- **LAST SAVED**—Loads settings from the last permanent save.

Related ZPL command(s):

- **FACTORY:** ^JUF
- **NETWORK:** ^JUN
- **LAST SAVED:** ^JUR
- **SAVE NETWORK SETTINGS:** ^JUR (needed to make changes permanent after changes)

SGD command used: `Not Applicable`

Print Server web page: [View and Modify Printer Settings](#) > [Calibration](#)

- **FACTORY:** [View and Modify Printer Settings](#) > [Restore Default Configuration](#)
- **NETWORK:** [Print Server Settings](#) > [Reset Print Server](#)
- **LAST SAVED:** [View and Modify Printer Settings](#) > [Restore Saved Configuration](#)

Left Position

Description: This parameter adjusts the print position horizontally on the wristband. Positive numbers adjust printing to the left by the specified number of dots. Negative numbers shift printing to the right

- Negative numbers move the left edge of the image toward the left edge of the label by the number of dots selected when viewed from the front of the printer.
- Positive numbers move the edge of the image toward the right edge of the label.

Accepted values: -9999 to 9999

Related ZPL command(s): ^LS

SGD command used: `zpl.left_position`

Print Server web page: [View and Modify Printer Settings > Advanced Setup](#)

Reprint Mode

Description: When reprint mode is enabled, you can reprint the last label printed by pressing FEED button.

Accepted values: ON or OFF (default)

Related ZPL command(s): ^JZ

SGD command used: `zpl.left_position`

Print Server web page: None

Printer Fonts

The ZD510 printer supports your language and font requirements. The ZPL™ programming language provides advanced font mapping and scaling technology to support outline fonts (TrueType™ or OpenType™) and Unicode character mapping as well as basic bitmapped fonts and character code pages.

The printer's font capabilities are programming language dependent. The ZPL programming guide describes and documents the fonts, code pages, character access, listing fonts, and limitations of use. See the printer programming guide for information on Text, Fonts and Character support.

Zebra has variety of utilities and application software that support font download to the printer



Important • Some factory installed ZPL fonts in your printer cannot be copied, cloned or restored to your printer by reloading or updating firmware. If these license restricted ZPL fonts are removed by an explicit ZPL object delete command, they must be repurchased and reinstalled via a font activation and installation utility.

Identifying Fonts in Your Printer

Fonts and memory are shared in the printer. Fonts can be loaded into various storage locations in the printer. See the respective programmer guides for more information on fonts and printer memory.

ZPL Fonts

- To manage and download fonts for ZPL print operation, use the Zebra Setup Utility or ZebraNet™ Bridge.
- To display all of the fonts loaded in your printer, send the printer the ZPL command `^WD`. See the ZPL Programmers Guide for details.
 - Bitmap fonts in the various printer memory areas are identified by the `.FNT` file extension in ZPL.
 - Scalable fonts are identified with the `.TTF`, `.TTE` or `.OTF` file extensions in ZPL.

Localizing the Printer with Code Pages

The ZD510 printer supports language, region and character sets for permanent fonts loaded into the printer for each printer programming language, ZPL and EPL. The printer supports localization with common international character map code pages.

- For Code Page support, including Unicode, see the `^CI` command in the ZPL programming guide.

Asian fonts and Other Large Font Sets

Asian language ideographic and pictographic fonts have large character sets with thousands of characters that support single language code page. In order to support the large Asian character sets, the industry adopted a double-byte (67840 maximum) character system instead of the single-byte characters (256 maximum) used by Latin based language characters to address large font sets. In order to address multiple languages with a single font set, Unicode was invented. A Unicode font supports one or more code points (relate these to code page character maps) and is accessed in a standard method that resolves character mapping conflicts. The ZPL programming language supports Unicode. Both of the printer's programming languages support the large pictographic double-byte character Asian font sets.

The number of fonts that can be downloaded is dependent upon the amount of available flash memory not already in use and the size of the font to be downloaded.

Some Unicode fonts are large such as MS (Microsoft) Arial Unicode font (23 MB) available from Microsoft or the Andale font (22 MB) offered by Zebra. These large font sets typically support a large number of languages as well.

Getting Asian Fonts

Asian bitmap font sets are downloaded into the printer by the user or integrator. The ZPL fonts are purchased separately from the printer. EPL Asian Fonts are available for free to download from the Zebra Web site.

- Simplified and Traditional Chinese
(The SimSun scalable font is pre-loaded onto printers sold with a Chinese power cord.)
- Japanese — JIS and Shift-JIS mappings
- Korean including Johab
- Thai

ZBI 2.0™ — Zebra Basic Interpreter

Customize and enhance your printer using the ZBI 2.0™ programming language. ZBI 2.0 allows Zebra printers to run applications and take input from scales, scanners and other peripherals without a PC or network connection. ZBI 2.0 works with the ZPL printer command language so that printers can understand non-ZPL data streams and convert them into labels. That means the Zebra printer can create barcodes and text from input received, non-ZPL label formats, sensors, keyboards and peripherals. Printers can also be programmed to interact with PC based database applications to retrieve information to be used on printed labels.

- ZBI 2.0 can be activated by ordering a ZBI 2.0 Key Kit, or activated by purchasing a key from Zebra.
- Use the ZBI Key Manager (also know as ZDownloader utility) to apply the key.

An intuitive ZBI-Developer™ is used to create, test and distribute ZBI 2.0 applications. The built-in "Virtual Printer" allows you to quickly create, test and prepare programs for use. ZBI-Developer is available at the Zebra Web site:

Go to the Zebra Web site and search for **Zebra Basic Interpreter 2.0**.
www.zebra.com/software

Additional Diagnostics Tools

The media sensor profile and the communications diagnostics test are available as diagnostic tools.

Media Sensor Profile

Use the media sensor profile to troubleshoot the following types of problems:

- If the media sensor experiences difficulty in determining where wristbands start and stop.
- If the media sensor incorrectly identifies a preprinted area on a wristband as the end of the wristband.

The media sensor readings are shown as peaks and flat areas on the media sensor profile (Figure 15). Two peaks appear when the sensors are operating properly, indicating that the sensors correctly detected the black mark on the back of the wristband. A media sensor profile prints on two wristbands.

Figure 15 • Media Sensor Profile



To print a media sensor profile, complete these steps:

1. Make sure that the printer is ON and ready to print.
2. Press and hold PAUSE/FEED until the green lights turn off on the printer status indicator and the orange lights blink once. Continue holding PAUSE/FEED until the orange lights blink twice. Release PAUSE/FEED and the media sensor profile prints.

Communications Diagnostics Test

The communication diagnostics test is a troubleshooting tool for checking the interconnection between the printer and the host computer.

When the printer is in diagnostics mode, it prints all data received from the host computer as straight ASCII characters with the hex values below the ASCII text. The printer prints all characters received, including control codes such as CR (carriage return). [Figure 16](#) shows a typical printout from this test. The actual format is modified to print on narrow wristbands.

Figure 16 • Communications Diagnostics Test Printout



To use communications diagnostics mode, complete these steps:

3. Set the printer to Diagnostics mode by sending the ZPL `~JD` command to the printer.

The printer enters Diagnostics mode and prints any data received from the host computer on a test printout.



Note • The PAUSE/FEED button will not advance a wristband while the printer is in Diagnostics mode. Exit Diagnostics mode to use the FEED button and feed a wristband.

4. Check the test printout for error codes. For any errors, check that your communication parameters are correct.

Errors show on the test printout as follows:

- FE indicates a framing error.
- OE indicates an overrun error.
- PE indicates a parity error.
- NE indicates noise.

5. Send the ZPL II `~JE` command to the printer to return to normal operation.

Downloading Firmware

Zebra periodically issues updated firmware to enhance the usability of its printers. You may download the latest ZD510 firmware to the printer at any time. For the latest firmware version and instructions for downloading it, go to <http://www.zebra.com/firmware>.



Important • DO NOT power cycle the printer while a firmware update is in progress. The printer's Printer Status Indicator turns to a steady half-orange and half-green while the printer updates your firmware.



Important • Zebra Technologies is aware that some safety and compliance organizations require specific tested and approved firmware versions for the total system that uses the wristband printer. Applying older firmware versions to newer printers may disable some printer functions, such as updates to support newer networking standards and security protocols.

There are several ways to download the firmware file to your printer.

- Windows Printer Driver - Open the Printer Preferences select **Tools>Send File**
- Zebra Setup Utilities - Select the printer then **Open Printer Tools>Action>Send File**
- USB Host Firmware Update - Ideal for updating printer firmware and content (formats, graphics, fonts, etc.) - see [Using USB Host for Firmware Updates](#).
- ZebrNet Bridge
- Manual 'Forced' Download - Used mainly for troubleshooting and non Windows environments.

You may choose to place the printer in forced download mode before downloading firmware. While in this mode, the printer does not accept wristband printing instructions or control panel button presses.

Manual 'Forced' Download

To place the printer in forced download mode, complete these steps:

1. Turn the printer OFF.
2. Press and hold PAUSE/FEED while turning ON the printer.

During the printer self test, the printer status indicator rapidly alternates between yellow and orange for 3 seconds.



3. Release PAUSE/FEED during this light sequence to enter forced download mode.

The printer status indicator alternates between green and orange lights.



4. Download firmware to the printer using any available connection.

As firmware is downloading, a green light rotates on the printer status indicator.



During the firmware download process, the printer status indicator turns to a steady half-orange and half-green as the printer writes to flash memory. Do NOT power cycle the printer during this phase.



When the firmware download process is complete, the printer returns to normal operation. See [Meaning of the Indicator Light Patterns](#) for more information on other indicator light patterns.

Maintenance

This section provides routine cleaning and maintenance procedures.

Cleaning

Your Zebra printer may require periodic maintenance to keep your printer functional and printing high quality labels, receipts, tags, etc.

Cleaning Supplies

The following printer cleaning supplies are recommended for use with your printer:

- **Cleaning Card** for simple operator media path and printhead cleaning.
- **99% pure Isopropyl Alcohol** (Use a labeled dispenser. Never re-moisten cleaning materials used to clean the printer).
- **Fiber-free Cleaning Swabs** for media path, guides, and sensors **and Cleaning Wipes** for media path and interior (for example Kimberly-Clark Kimwipes).
- Can of Compressed Air.



Important • Using too much alcohol can result in contamination of the electronic components requiring a much longer drying time before the printer will function properly.



Important • Do Not Use an air compressor in place of the can of compressed air. Air compressors have micro contaminants and particles that get into the air system and damage your printer.



Eye Injury Caution • Use eye protection to protect your eyes from flying particles and objects when using compressed air.

Get Zebra Supplies for Cleaning Your Printer

Go to the Zebra Web site: <http://www.zebra.com/parts>

Cleaning the Media Path

Interval: Clean the media path after every 5 media cartridges are printed.



Important • When cleaning other areas of the printer, clean the media path last.

Method: Zebra recommends cleaning the media path using a cleaning card. The cleaning card procedure gently cleans the media path including the printhead, platen roller and media feed roller. The printer will automatically clean the media path when using the cleaning card and this procedure,

Using a Cleaning Card

1. Remove the media cartridge, if present. Press the EJECT button to unload the media cartridge from the printer.
2. Turn OFF the printer power.
3. Press both Upper Cover Release buttons simultaneously. The Upper Cover springs open, partially.



4. Remove the cleaning card from its packaging.

Maintenance

- 5. From the back side of the printer:** Insert the cleaning card into the media input slot under the black printhead bracket and above the gray inner body as shown. Insert the cleaning card until it extends out of the front of the printer by roughly 1 cm or 0.25 inches.



- 6. Close the upper cover.**

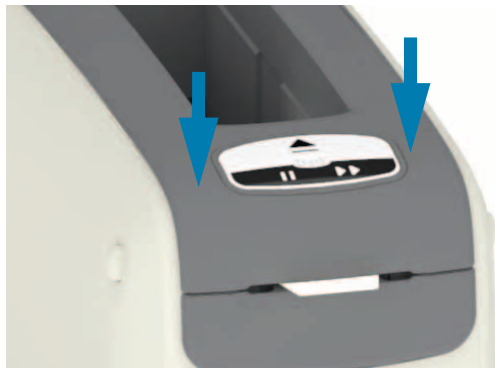

- 7. Press and hold EJECT button while turning ON the printer power.**
- 8. Hold EJECT for approximately 15 seconds while the printer powers up and performs a self-test.**
- 9. Release EJECT when the cleaning card begins moving. The printer uses the cleaning card to clean the media path.**

Maintenance

10. Cleaning is complete when the card stops moving and returns to its original position. Remove and dispose of the cleaning card.
11. Wait for the alcohol to evaporate approximately two (2) minutes.
12. Reinsert the media cartridge.



Caution • The cleaning card contains isopropyl alcohol, a flammable material. After use, discard according to your local regulations.

Cleaning the Exterior of the Printer

Interval: Clean as needed.

Method: Use a soft cloth or compressed air to wipe or blow dust and particles out of the media slot in the printer. The rest of the exterior of the printer can be cleaned using plain soap and water solutions to moisten a soft cloth. Only use the minimum amount of cleaning solutions to avoid getting solution in the printer or other areas. Do not clean connectors or interior of the printer with solution moistened materials (soap, chemicals, cloth, swab, etc.).

Healthcare Environments — This printer includes Ultra-Violet (UV) and disinfectant-ready plastics for hospital and other similar environments. The user control's are sealed so they can be cleaned with the rest of the printer's exterior. See the '**Guide To Disinfecting and Cleaning Zebra® Healthcare Printers**' on the Zebra Web site for the latest information on tested and approved cleaning materials, and cleaning methods.

Cleaning Instructions

1. With printer power ON, remove the media cartridge from the printer. Press the Eject button once and release immediately .
2. Turn OFF the printer power.
3. Disconnect the D/C power cord from the back of the printer. Disconnect any interface cables that are attached to the printer.
4. Lift the printer over a waste bin and turn it over to remove an loose foreign materials (paper pieces, dust, etc.) that may have fallen into the media cartridge slot.
5. Blow out any remaining dust in the media cartridge slot using a can of compressed air.
6. Wipe the moist cloth over the rest of the exterior of the printer. Never clean the connectors on the rear panel, Smart Chip reader contacts (in the Media Slot), or the Media Drive Roller (in the Media Slot).
7. Allow the printer to dry completely and reattach the power ([Attaching Power](#)) and interface connectors if any ([Connecting your Printer to a Computer](#)), and clean the media path ([Cleaning the Media Path](#)).

Cleaning the Media Cartridge

Interval: Clean as needed.

Method: The media cartridge can get dirty or contaminated from handling or not being properly stored in the media cartridge's carton. A dirty cartridge can spread contaminants to other areas in your work environment, cartridge, and printer. This includes a critical area of your media cartridge - Cartridge Information Smart Chip.

Use the fiber-free cleaning wipe or fiber-free cleaning swab from a Preventive Maintenance Kit dipped in a solution of isopropyl alcohol (minimum 99%).

To clean the smart card contacts and the media cartridge sensor pins, complete these steps:

1. With printer power ON, remove the media cartridge from the printer. Press the Eject button once and release immediately .
2. Using a fiber-free cloth or swab lightly moistened in the alcohol solution clean the exterior of the cartridge except the Cartridge Information Smart Chip on the back of the cartridge. clean the gold smart card contacts on the back of the media cartridge.
3. Using a new (clean) fiber-free cloth or swab lightly moistened in the alcohol solution, clean the gold card contacts on the Cartridge Information Smart Chip in the back of the media cartridge. Allow the solution to evaporate.

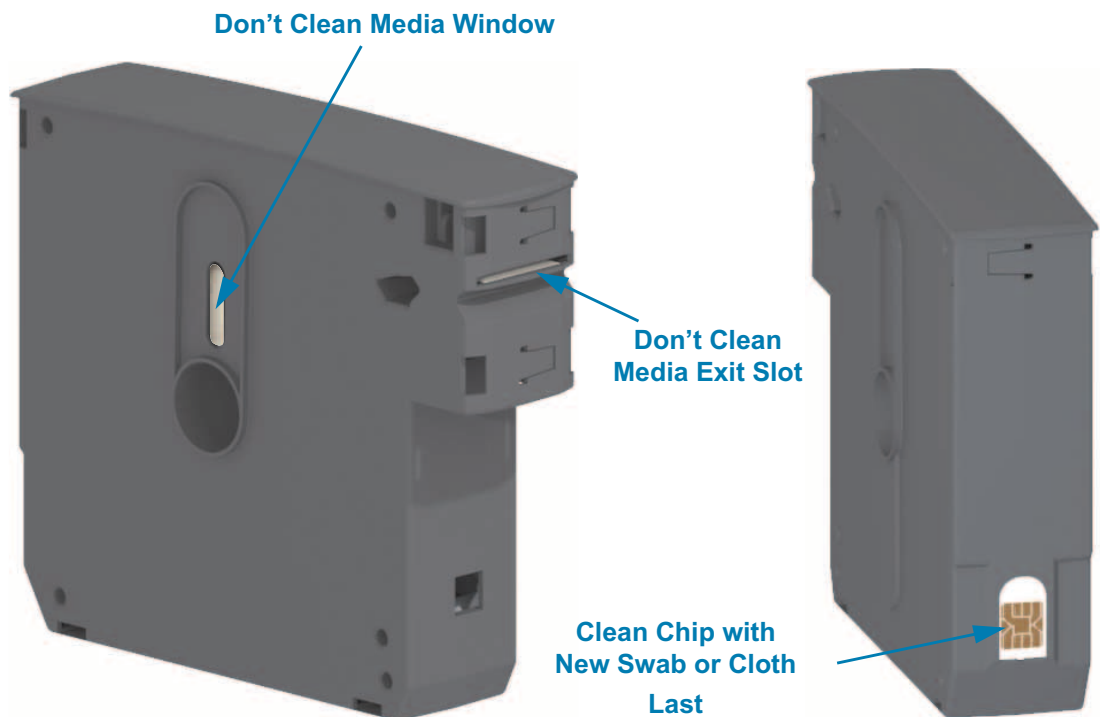

Cleaning the Printer's Smart Chip Reader Contacts

Interval: Clean as needed.

Method: Gently clean the contacts in the lower back wall of the Smart Chip contacts in the printer's Media Cartridge Slot.

To clean the printer's Smart Chip Reader pins, complete these steps:



Product Damage Caution • Use only vertical strokes to clean the media cartridge sensor pins. Using horizontal could strokes damage the pins.

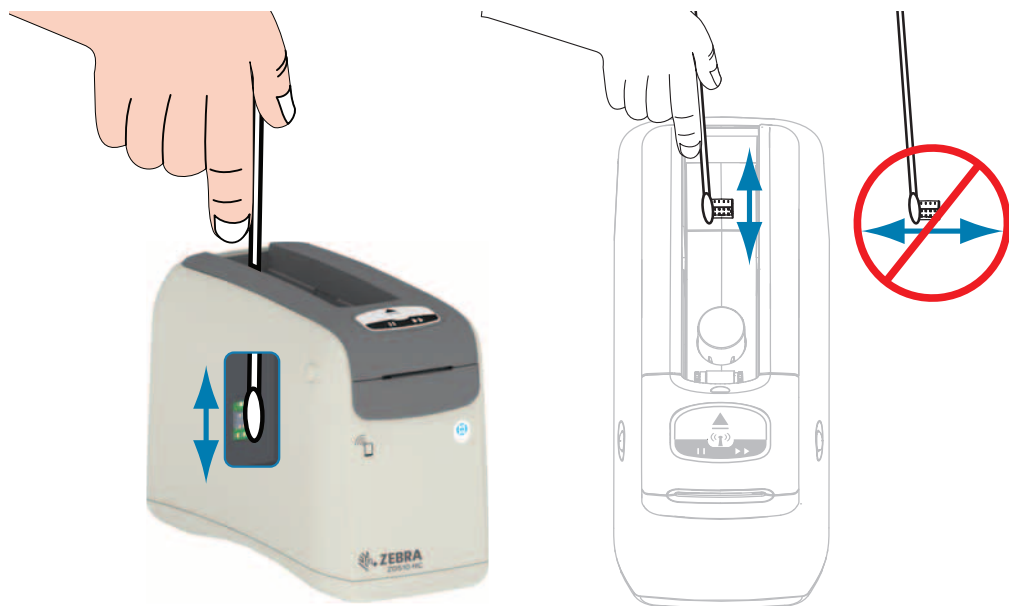

1. Using the fiber-free swab moistener in a solution of isopropyl alcohol (minimum 99%) and gentle vertical strokes, clean the gold Media cartridge sensor pins, which are visible at the back of the media cartridge slot. Discard the used swabs.
2. Allow the solution to evaporate.
3. Re-insert the D/C power cord into the printer D/C power connector on the back of the printer.
4. Turn ON the printer power.
5. Reinsert the media cartridge.

Cleaning the Media Sensor

Interval: Clean as needed.

Method: Clean the media sensor with a can of compressed air to remove particles. The media sensor is located under the Upper Cover and Printhead assembly. Do not clean with swabs. The components are easily damaged by scrubbing!



Caution • The printhead may be hot and could cause severe burns. Allow the printhead to cool before proceeding.



Caution • Before proceeding, discharge any built-up static electricity by touching the printer's metal back plate near its power switch or by using an anti-static wrist-strap and mat.



Caution • Remove all rings, watches, hanging necklaces, identification badges, or other metallic objects that could touch the printhead or drop into the media cartridge slot.

Media Sensor Cleaning Instructions

1. Press both Upper Cover Release buttons simultaneously. The Upper Cover springs open, partially.



Maintenance

2. Lift the Upper Cover up until it stops and tilt the Upper Cover back for better access. The media path, printhead, platen roller and media sensor are now accessible.

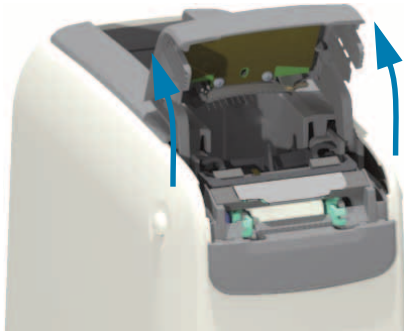

3. Lift the shiny aluminum metal tab on top of the Printhead assembly and lift it up. Lift the Printhead Assembly out and off the printer below it using the tab.



- 4.

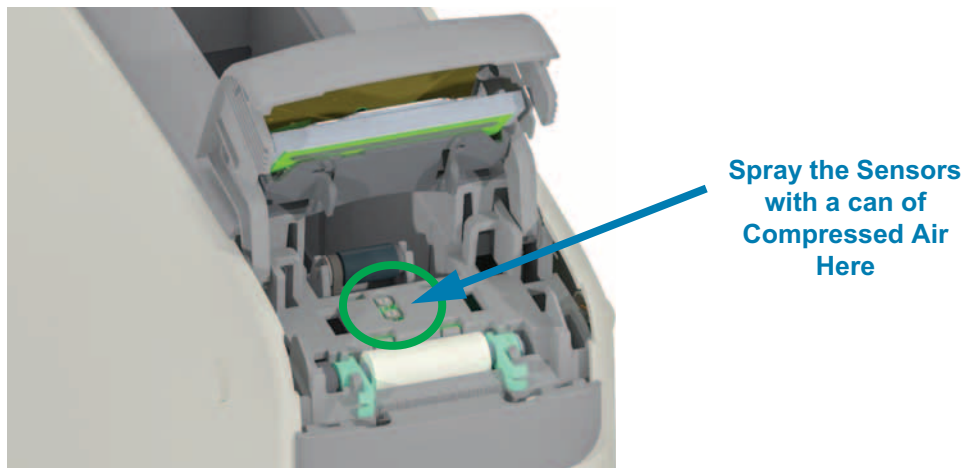

Maintenance

5. Replace the Printhead Assembly. Align the two (2) tabs on the bottom of the Printhead Assembly to the two (2) slots in the printer's inner frame and insert the Printhead Assembly.

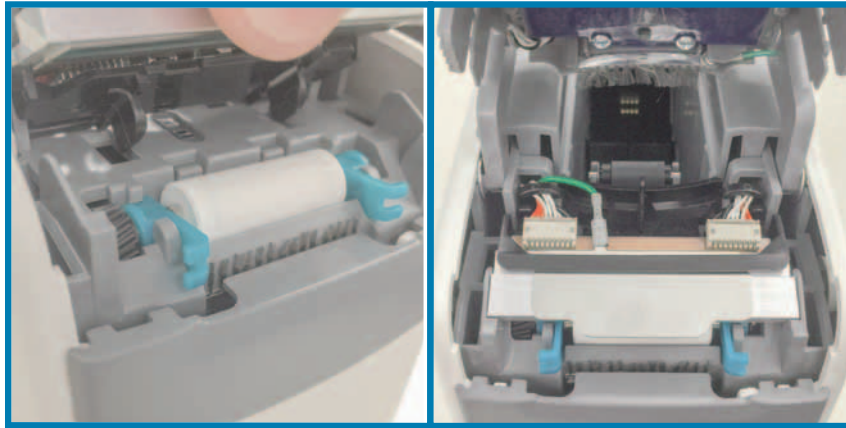

6. Close the Upper cover.
7. Turn the printer power on and clean the media path, see [Cleaning the Media Path](#).

Printhead Replacement

Interval: Replace as needed. The Printhead can get damaged or wear out from normal operation and use.



Caution • The Printhead may be hot and could cause severe burns. Allow the printhead to cool before proceeding.



ESD Caution • Prepare your work area by protecting against static discharge. Your work area must be static-safe and include a properly grounded conductive cushioned mat to hold the printer and a conductive wrist strap for yourself.



Caution • Remove all rings, watches, hanging necklaces, identification badges, or other metallic objects that could touch the printhead or drop into the media cartridge slot.

Printhead Removal

1. Press both Upper Cover Release buttons simultaneously. The Upper Cover springs open, partially.



2. Lift the Upper Cover up until it stops and tilt the Upper Cover back for better access. The media path, printhead, platen roller and media sensor are now accessible.

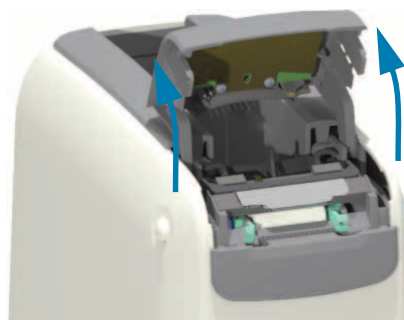

Maintenance

3. From the top side of the Printhead Assembly, pull the green ground wire off the metal tab.

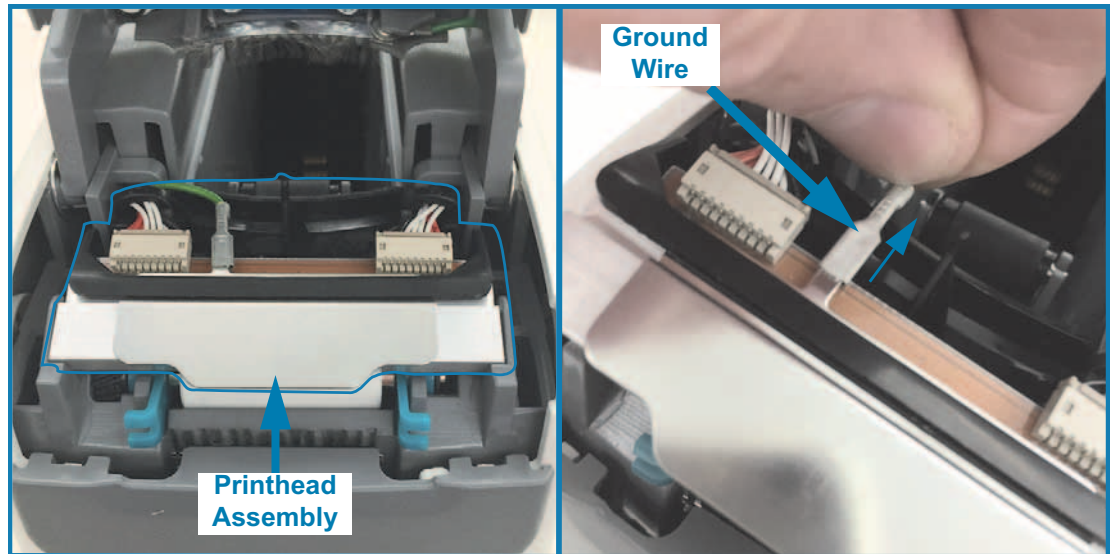

4. From the top side of the Printhead Assembly, use a finger nail or a small flat bladed screwdriver to gently pry the left side Printhead cable connector out of the printhead.

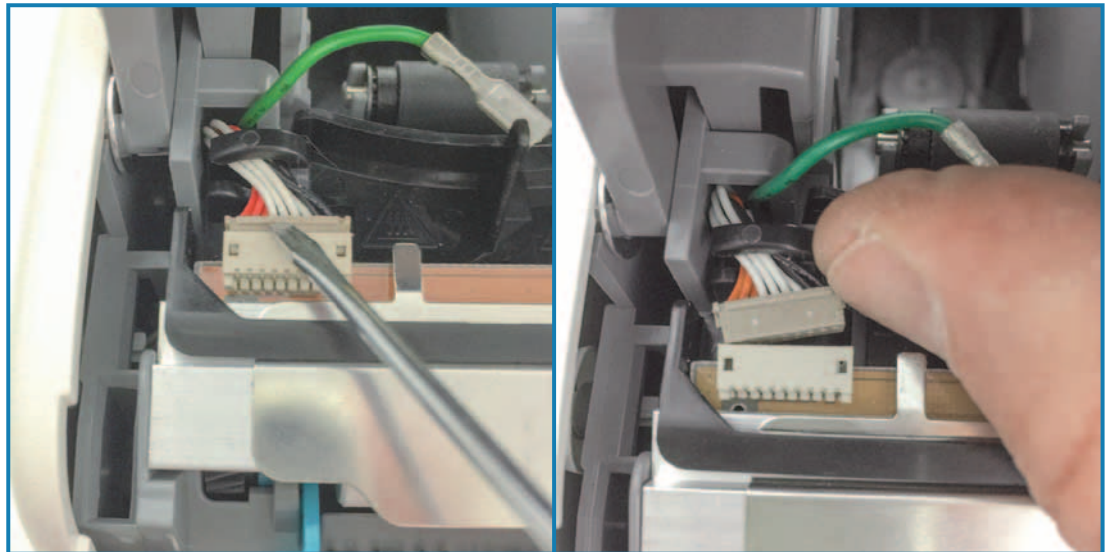

Maintenance

5. From the top side of the Printhead Assembly, use a finger nail or a small flat bladed screwdriver to gently pry the right side Printhead cable connector out of the printhead.

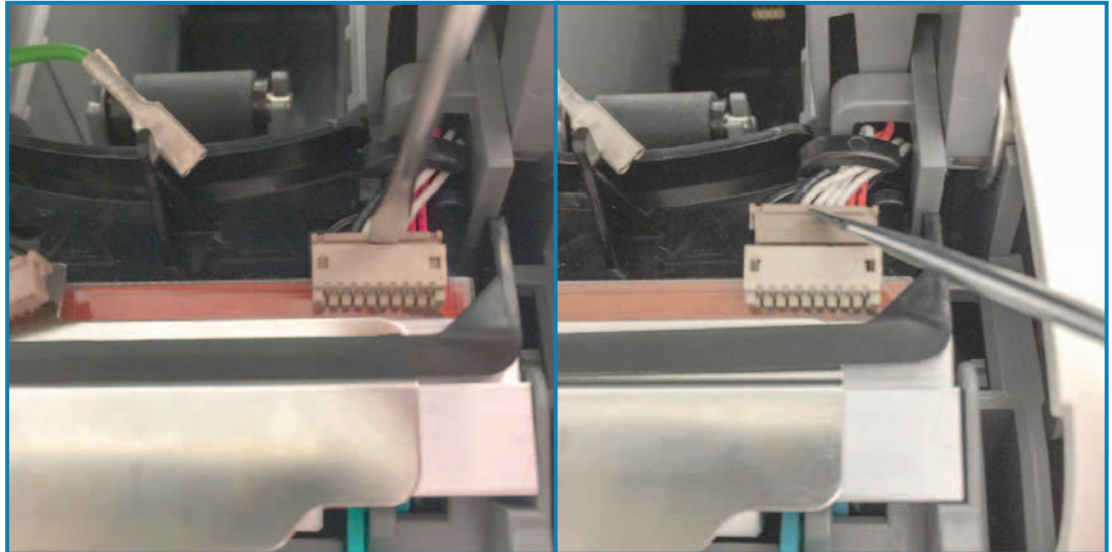

6. Lift the metal tab on top of the Printhead assembly to lift the Printhead Assembly up out of the printer 's chassis. Turn the Printhead Assembly counter clock-wise a little and pull the right side of printhead cable out of the open side of the 'C' cable retainer on the right side of the Printhead Assembly.

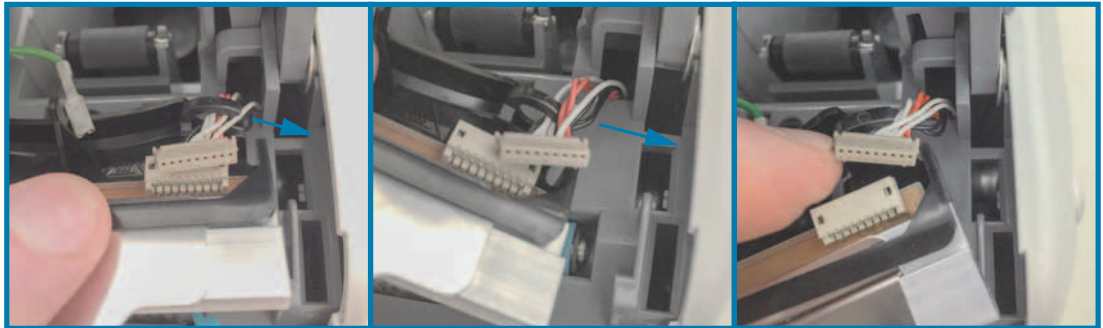

7. Turn the Printhead Assembly clock-wise a little and pull the left side printhead cable out of the open side of the 'C' cable retainer on the left side of the Printhead Assembly.

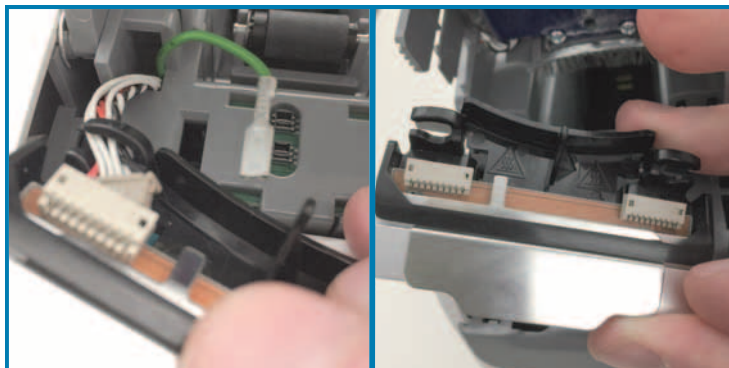

Printhead Replacement

1. Place the new Printhead Assembly close to the two (2) printhead connectors and ground wire. Connect the left side printhead cable to the left side printhead connector.

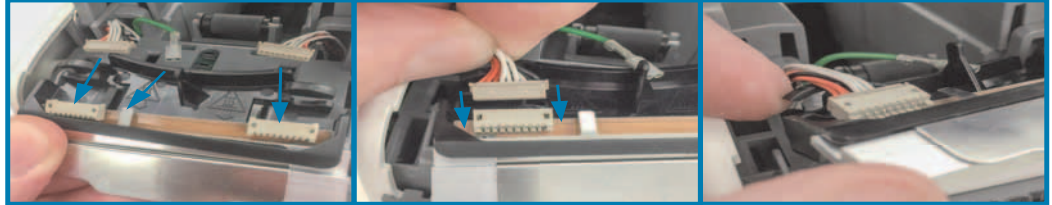

2. Swing the right side of the Printhead Assembly close to the right side printhead cable and plug it into the right side printhead connector.

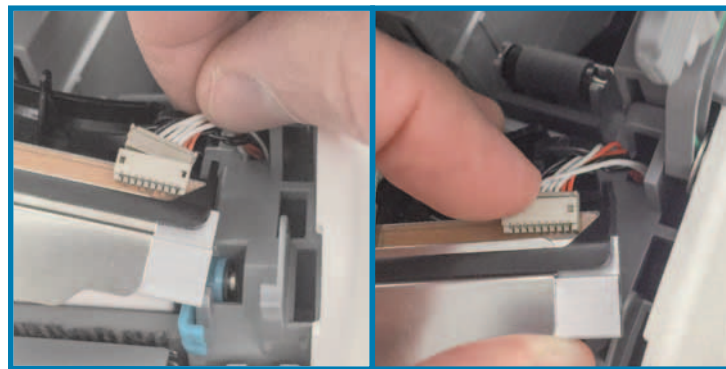

3. Connect the green ground wire to the metal tab on the next to the left printhead connector.

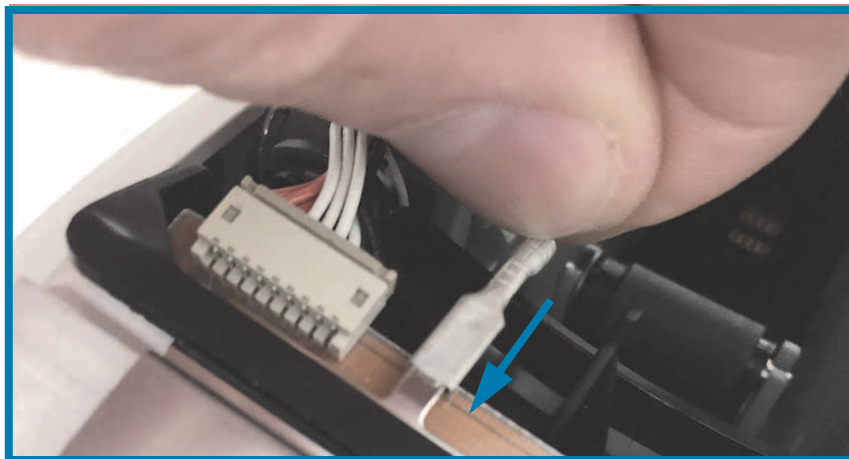

Maintenance

4. Insert the printhead cable bundles on the right and left side 'C' cable retainers on the back of the Printhead Assembly.

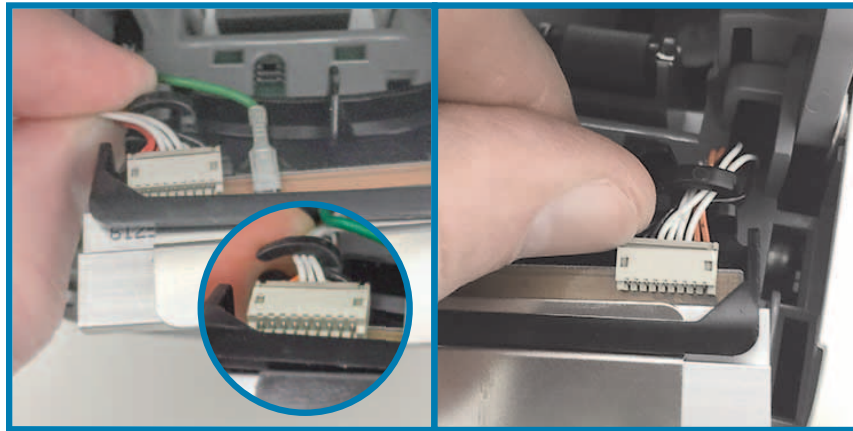

5. Place the Printhead Assembly In the printer chassis. Align the two (2) tabs on the bottom of the Printhead Assembly to the two (2) slots in the printer's inner frame and insert the Printhead Assembly.

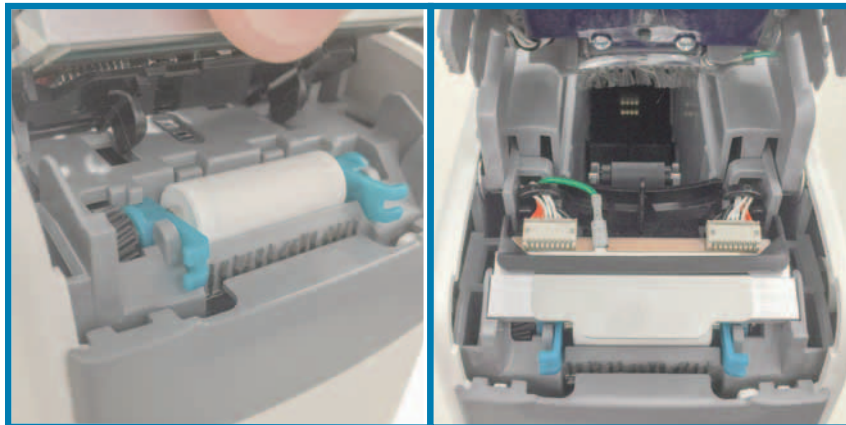

6. Close the Upper cover.
7. Turn the printer power on and clean the media path, see [Cleaning the Media Path](#).

Platen Replacement

Interval: Replace as needed. The platen roller components can get damaged or wear out from normal operation and use.



Caution • The printhead may be hot and could cause severe burns. Allow the printhead to cool before proceeding.



Caution • Before proceeding, discharge any built-up static electricity by touching the printer's metal back plate near its power switch or by using an anti-static wrist-strap and mat.



Caution • Remove all rings, watches, hanging necklaces, identification badges, or other metallic objects that could touch the printhead or drop into the media cartridge slot.

Platen Removal

1. Press both Upper Cover Release buttons simultaneously. The Upper Cover springs open, partially.



2. Lift the Upper Cover up until it stops and tilt the Upper Cover back for better access. The media path, printhead, platen roller and media sensor are now accessible.

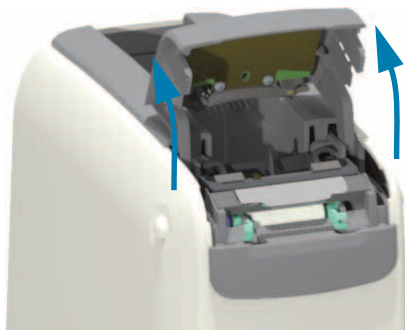

Maintenance

3. Lift the shiny aluminum metal tab on top of the Printhead assembly and lift it up. Lift the Printhead Assembly out and off the printer below it using the tab.



4. Rotate and lift the two (2) green arms on each side of the platen roller straight up. Holding the two (2) arms lift the Platen Roller Assembly out of the printer.

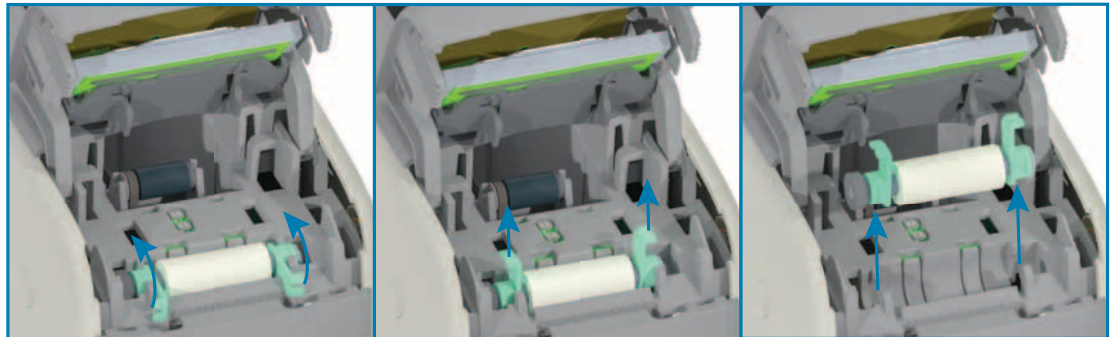

Platen Replacement

1. Align the new Platen Roller Assembly with the gear on the left side of the printer above the roller recess in the printer's inner frame. Slide the Platen Roller Assembly into the roller recess aligning the two green bearings with their arms up. Swing the arms down flat against the inner frame to lock them into place.

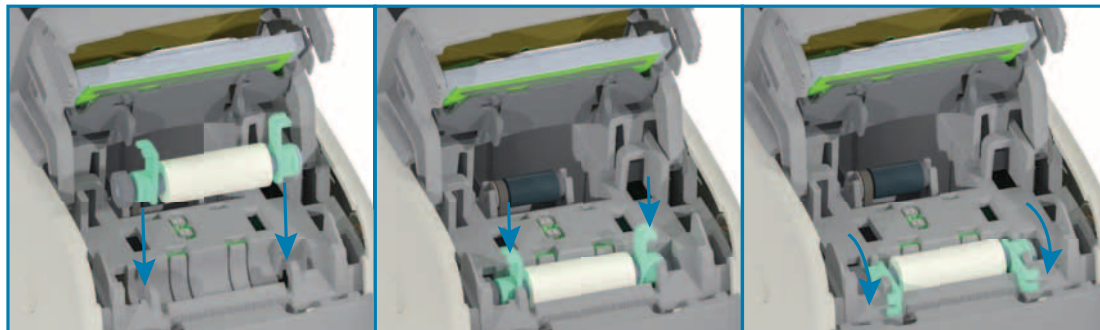

2. Replace the Printhead Assembly. Align the two (2) tabs on the bottom of the Printhead Assembly to the two (2) slots in the printer's inner frame and insert the Printhead Assembly.

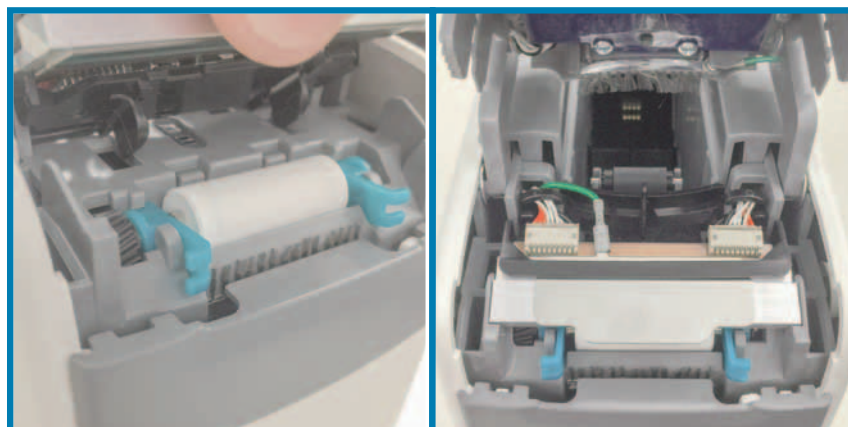

3. Close the Upper cover.
4. Turn the printer power on and clean the media path, see [Cleaning the Media Path](#).

Lubrication

No lubrication is needed for this printer.



Caution • Some commercially available lubricants will damage the finish and the mechanical parts if used on this printer.

RTC Battery

The RTC (Real-Time Clock) battery is not operator replaceable. See a Zebra authorized service technician to replace the battery.



Caution • The printer has a three volt lithium battery. You can discern a low or flat battery if the printer provides a consistently delayed date stamp. Battery replacement must be performed by a qualified service technician. Only use a Zebra approved replacement battery.



Important • Recycle batteries according to local your guidelines and regulations. Wrap the battery when disposing (or storing) to avoid a short circuit.

Important • **DO NOT** short circuit the battery. Short circuiting the battery may result in heat generation, fire or bursting.

Fuses

There are no replaceable fuses in the printer or power supply.

Troubleshooting

This section provides troubleshooting procedures and information.

Resolving Alerts and Errors

Alert: Upper Cover Open

A print command or a FEED button has been pressed and the printer has detected that the printhead (cover) is not closed.



Possible Cause #1 - Normal Operation

The cover is open or has not been closed properly.

Resolution

Close the Upper Cover. Push down on the front top corners of the printer's cover. You should normally hear and feel the cover latches snap in place to lock the cover closed for printing. See [Opening the Upper Cover](#).

Possible Cause #2

The switch to detect an Upper Cover Open needs service.

Resolution

Call a service technician.

Alert: **Media Out (while printing/feeding media)**

A print command/job has just been sent, a FEED button has been pressed, or you are printing; and the printer is stopped.



Possible Cause

The media cartridge is out of media while printing or moving media.

Resolution

Replace with a new or different cartridge with media to continue.

Alert: **Media Out (while loading media)**



Possible Cause #1

Installed cartridge was out of media, damaged, dirty, or defective. The printer does not move media when cartridge is inserted.

Resolution

Replace with a new or different cartridge with media to continue.

Possible Cause #2

Installed cartridge is damaged, dirty, or defective. The printer does not move media when cartridge is inserted. The printer is not detecting the “Smart Card” Chip on the media cartridge.

Resolution #1

The cartridge’s “Smart Card” Chip may be dirty. Inspect the cartridge - clean as necessary. See [Cleaning the Media Cartridge](#) and clean the whole cartridge.

Resolution #2

The cartridge may be damaged. Try a new media cartridge.

Resolution #3

The “Smart Card “ Chip Reader contacts may be dirty. Clean the reader’s contacts, see [Cleaning the Printer’s Smart Chip Reader Contacts](#).

Resolution #4

The “Smart Card “ Chip Reader may be damaged. Call a service technician.

Possible Cause #3

Media is not being sensed. The printer attempts to load media (moves media). An ejected cartridge may have some media protruding out of the cartridge.

Resolution #1

The media sensor may be dirty. See [Cleaning the Media Sensor](#).

Resolution #2

The media sensor may be damaged or defective. Call a service technician.

Possible Cause #4

Media cartridge has been refurbished or is not a Zebra cartridge.

Resolution #1

Only Genuine Zebra™ supplies will work with your printer. Cartridges can not be ‘reloaded’.

Alert: Operating Temp

The printer at rest or when attempting to move media (print or Feed), then displays this alert.



Possible Cause #1

The ambient temperature of the printer’s location exceeds the specified operating range.

Resolution

Move the printer to an operating environment that is well within the printer’s specified operating temperature range. Sometimes, ambient temperatures in the printer can be higher if it is in direct sunlight. Putting objects under the printer can restrict cooling air flow too.

Possible Cause #2

Printhead has had a critical temperature or power failure.

Resolution

1 — Turn the printer off by holding the power using the POWER button down for 5 seconds. Wait for the printer to shutdown completely. Turn the printer on.

2 — If the printer does not recover from this error, call a service technician. This is not a operator serviceable item.

Alert: Printhead Temp Shutdown

The printhead has reached thermal-shutdown to prevent damage. Let the printer cool. The printer will resume printing automatically.



Possible Cause #1

The printer has been printing a large amount of media in a short time.

Resolution

Printer is functioning normally to protect the printhead. Let the printer cool and it will continue printing when the printers cools sufficiently to resume safe printing.

Possible Cause #2

The printer's internal temperature is too high after printing a small amount of media. The work area has a high ambient temperature, it has blocked printer vents, or direct sunlight is increasing normal print temperatures.

Resolution

Reduce or eliminate environmental conditions closer to the middle of the printer's operating temperature range.

Alert: Memory Storage Exception

Can not store data in the printer in the specified memory location. There are different types of storage memory: Graphic, Format, and Font.



Possible Cause #1

There is not enough memory to store one of the following in the printer: graphic, format, or font.

Resolution

- 1 — Free up some of the printer's memory by adjusting the label format or printer parameters to make the print area smaller.
- 2 — Remove unused graphics, fonts, or formats.
- 3 — Ensure that the data is not directed to a device that is not installed or is unavailable.

Possible Cause #2

The programming commands sent to the printer have a syntax error(s).

Resolution

Verify programming, see the ZPL Programmer's Manual for proper syntax and requirements. See ZD510 Wristband Printer support web page — www.zebra.com/zd510-info, to access the programmer's manual.

Resolving Print Issues

This section helps you identify issues with printing or print quality, the possible causes, and the recommended solutions.

Issue: General Print Quality Issues

The printed image does not look right.

Possible Cause #1

The printhead or platen roller is dirty.

Resolution

Clean the the media path to clean the printhead or platen roller. See [Cleaning the Media Path](#).

Possible Cause #2

The platen roller is damaged or worn out.

Resolution

Replace the platen. See [Platen Replacement](#).

Possible Cause #3

The printhead has worn out. See [Printhead Replacement](#).

Resolution

Replace the printhead. See [Printhead Replacement](#).

Possible Cause #4

You may be using the wrong power supply.

Resolution

Verify you are using the power supply that came with this printer.

Issue: Labels Are Distorted in Size or Print Area Start Position Varies

Includes printed image that skips between labels (mis-registration).

Possible Cause #1

The media sensors are having trouble sensing black marks used to set media length.

Resolution

See [Media Sensor Profile](#).

Possible Cause #2

The platen (drive) roller is slipping or damaged.

Resolution

Clean or replace the platen. The platen can wear out or get damaged. See [Cleaning the Media Path](#) first, then try [Platen Replacement](#) second.

Possible Cause #3

The printer has communication issues with cables or communication settings.

Resolution

See [Communication Issues](#).

Communication Issues

This section identifies problems with communications, the possible causes, and the recommended solutions.

Issue: Label Job Sent, No Data Transfer

A label format was sent to the printer but was not recognized. The 'Transferring Data' Printer Status light pattern is not displayed.

Possible Cause

The communication parameters are incorrect.

Resolution #1

Check the printer driver or software communications settings (if applicable).

Issue: Label Job Sent, Data Transfers, But No Print

A label format was sent to the printer but was not recognized. The 'Transferring Data' Printer Status light pattern is displayed, but no printing occurs.

Possible Cause #1

The prefix and delimiter characters set in the printer do not match the ones in the label format.

Resolution

Verify the ZPL programmings prefix (COMMAND CHAR) and delimiter (DELIM./CHAR) characters. [Configuration Setting to Command Cross-reference](#).

Possible Cause #2

Incorrect data is being sent to the printer.

Resolution

Check the label format. See the ZPL Programmer's Manual for details on printer programming. For printer links to manuals, see the [About](#) section of this guide.

Miscellaneous Issues

This section identifies miscellaneous issues with the printer, the possible causes, and the recommended solutions.

Issue: Settings are Lost or Ignored

Some parameters are set incorrectly.

Possible Cause #1

Printer settings were changed without saving them.

Resolution

The ZPL `^JU` command was not used to save your configuration before turning the printer off. Cycle the printer OFF and then back ON to verify settings have been saved.

Possible Cause #2

The label format/form commands or commands sent directly to the printer have syntax errors or have been used incorrectly.

- A firmware command turned off the ability to change the parameter.
- A firmware command changed the parameter back to default setting.

Resolution

See the ZPL programmer's guide to verify command usage and syntax. See the [About](#) section for support links. to view the programmer' guide for your printer model.

Possible Cause #3

The prefix and delimiter characters set in the printer do not match the ones in the label format.

Resolution

Verify the ZPL programming settings of the Control, Command and Delimiter settings are correct for your system software environment. See [ZPL Configuration](#) section to verify settings.

Possible Cause #4

The Main Logic board may not be working properly. Firmware is corrupted or the Main Logic board needs service

Resolution

1 — Reset the printer to factory defaults. See [Changing and Restoring Printer Settings](#) or use the Zebra Setup Utility and **Open Printer Tools > Action > Load printer defaults.**

2 — Reload printer firmware. See [Downloading Firmware](#).

3 — If the printer does not recover from this error, call a service technician. This is not a user serviceable item.

Issue: **Printer Locks-Up**

All indicator lights are on and the printer locks up or the printer locks up while restarting.

Possible Cause #1

The printer memory has been corrupted by an unknown event.

Resolution - 1

1 — Reset the printer to factory defaults. See [Changing and Restoring Printer Settings](#) or use the Zebra Setup Utility and **Open Printer Tools > Action > Load printer defaults**.

2 — Reload printer firmware. See [Downloading Firmware](#).

3 — If the printer does not recover from this error, call a service technician. This is not a user serviceable item.

Miscellaneous Troubleshooting

This section has troubleshooting situations that are not necessarily shown by the status indicators.

Issue: Data Not Printing On First Part of the Wristband

Possible Cause

You cannot print on the leading edge of each wristband.

Resolution

Redesign your wristband format so that it fits in the recommended print zone. See [Wristband Print Zone](#).

Issue: Data Prints Poorly On Sections of the Wristband

Possible Cause

Printing on uncoated areas, over holes, or over scores affects print quality.

Resolution

Redesign your wristband format so that it fits in the recommended print zone. See [Wristband Print Zone](#).

Issue: Print On Wristband Is Unusually Dark

Possible Cause

Because direct thermal media is sensitive to temperature, this problem can occur in environments with high ambient temperature and high relative humidity.

Resolution

Use a lower darkness value while extreme high temperature or humidity conditions exist.

5. Set the darkness mode to USER or RELATIVE. See [Darkness Mode Setting](#).
6. Set the print darkness value to a lower value. See [Darkness Setting](#).

Issue: Printer Will Not Eject Media Cartridge

The cartridge can not be ejected by the pressing the EJECT button., pressing the EJECT button for six (6) seconds to cause a 'forced eject', or other command or software methods including resetting the printer.

Possible Cause

Printer component failure

Resolution #1

Turn the printer off and back on. Retry eject after the printer is Ready.

Resolution #2

Pressing the EJECT button for six (6) seconds to cause a 'forced eject'.

Resolution #3

Turn the printer off and perform a manual cartridge eject. See [Manual Cartridge Eject](#).

If the printer still has a problem when the power is turned on and a different or new cartridge is used, then the printer need service.

USB Host Port and Link-OS Demonstration Examples

This section has information on using the printer's USB Host port along with Link-OS features and Apps (applications).

USB Host

The USB host port allows you to connect USB devices — such as a keyboard, scanner, or USB Flash (memory) drive — to the printer.

USB Host Port Uses

- Firmware updates,
- File transfers and management
- A port for low power USB data entry devices (keyboards, scales, scanners, and other wedge devices).

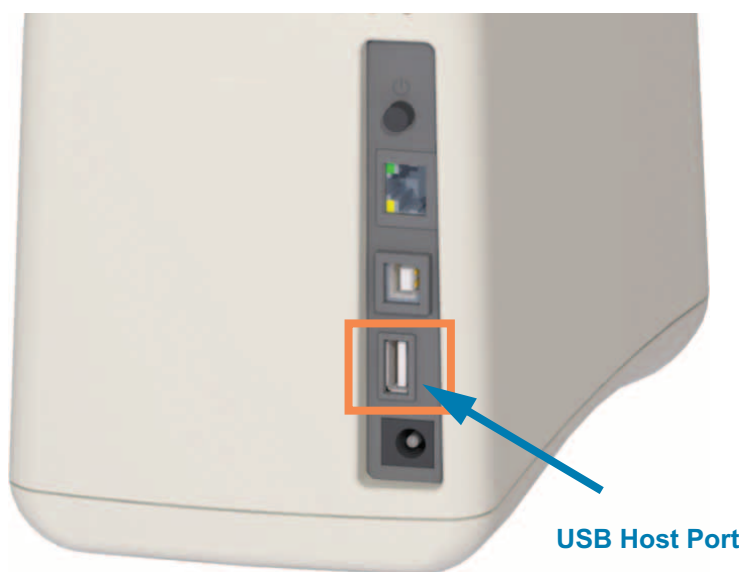

Important • The USB Flash drive must be formatted with the FAT file system. Filenames may be 1 to 16 alphanumeric characters (A, a, B, b, C, c, ..., 0, 1, 2, 3, ...) only. Only use ASCII characters. Do not use Asian characters, Cyrillic characters, or accented characters in file names. Some functions may not work properly if there are underscores in a file name. Use periods instead.

Using USB Host for Firmware Updates

The USB host port allows you to connect an USB Flash drive to the printer to perform firmware updates.

This is an example of using the powerful printer management, Zebra Mirror functions. See the printer ZPL programming manual — **Mirror** and **Set-Get-Do** (SGD) `usb.mirror` commands operation.



Note • See [About](#) section for information and support links for your specific printer model.



Important • Supports USB Flash drives (or “thumb drive” or “memory stick”) up to 1 Terabyte (TB). The printer will not recognize drives larger than 1 TB.

Flash Drive Preparation and Firmware Update

1. On your USB Flash Drive, create the following:
 - a folder called Zebra
 - in that folder, create three sub-directories:
 - appl
 - commands
 - files

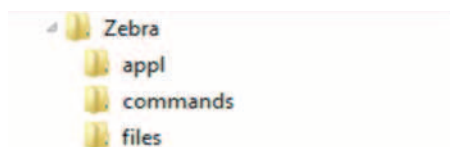

2. In the **/appl** folder, place a copy of the latest firmware for your printer.
3. Load the printer with media. See [Loading the Media Cartridge](#).
4. Insert the USB Flash drive into the USB host port on your printer.
5. Observe the user interface and wait.

If the firmware version on the USB Flash drive is different than the version installed on the printer, the firmware will download to the printer. The Printer Status Indicator will indicate firmware is being transferred to the printer - rotating single green light) to begin the firmware upgrade process. The printer will restart with all indicators flashing. When the firmware update has completed, the STATUS indicator will display solid Green as the firmware is validated and installed.
6. Print a Configuration Report (see [Test Printing with a Configuration Report](#)) to verify the firmware update has been completed.
7. Remove the USB Flash drive from the printer.

USB Host and Printer Usage Examples

The exercises in this section will teach you how to perform USB mirror (using an alternate firmware update procedure), how to transfer files to and from the printer, and how to provide information for which you are prompted and then print a label using that information.

Items Required for the USB Host Exercises

To perform the exercises in this document, you will need the following:

- USB Flash drive up to 1 Terabyte (TB). The printer will not recognize drives larger than 1 TB.
- USB keyboard.
- Various files referenced below (from files attached inside this PDF file).
- Free Zebra Utilities app for your smart phone (search for Zebra Tech in the Google Play store).

Files for Completing the Exercises

Most of the actual files that you need to complete the exercises in these section are attached here in the PDF file. Copy these files to your computer before you begin the exercises. Where possible, the contents of the files are shown. The contents of files that contain coded content, which cannot be viewed as text or as an image, are not included.

File 1: ZEBRA.BMP



File 2: SAMPLELABEL.TXT

```
^XA  
^F0100,75^XGE:zebra.bmp^FS  
^F0100,475^A0N,50,50^FDMirror from USB Completed^FS  
^XZ
```

This simple label format prints the Zebra logo and a line of text at the end of the mirroring exercise.

File 3: LOGO.ZPL

Uses the Zebra logo bitmap file.

File 4: USBSTOREDFILE.ZPL

```
CT~CD,~CC^~CT~
^XA~TA012~JSN^LT0^LH0,0^JMA^PR4,4~SD15^LRN^CI0^XZ
~DG000.GRF,07680,024,,[image data]
^XA
^LS0
^SL0
^BY3,3,91^FT35,250^BCN,,Y,N^FC%,{,#{^FD%d/%m/%Y^FS
^FT608,325^XG000.GRF,1,1^FS
^FT26,75^A0N,28,28^FH\^FDThis label was printed from a format stored^FS
^FT26,125^A0N,28,28^FH\^FDon a USB Flash Memory drive. ^FS
^BY3,3,90^FT33,425^BCN,,Y,N
^FD>:Zebra Technologies^FS
^PQ1,0,1,Y^XZ
^XA^ID000.GRF^FS^XZ
```

This label format prints an image and text. This file will be stored on the USB memory device at the root level so that it can be printed.

File 5: SMARTDEVINPUT.ZPL

```
^XA
^CI28
^BY2,3,91^FT38,184^BCN,,Y,N^FC%,{,#{^FD%d/%m/%Y^FS
^F0385,75^XGE:zebra.bmp^FS
^FT40,70^A0N,28,28^FH\^FDThis label was printed using a smart device input.
^FS
^FT35,260^A0N,28,28^FH\^FDThis label was printed by:^FS
^FT33,319^A0N,28,28^FN1"Enter Name"^FS^XZ
```

The same label format as the previous label, only with different text printing. This format is used for the smart device input exercise.

Exercise 1: Copy Files to a USB Flash Drive and Perform USB Mirror

8. On your USB Flash Drive, create the following:



- a folder called **Zebra**
- in that folder, three subfolders:
 - **appl**
 - **commands**
 - **files**

1. In the **/appl** folder, place a copy of the latest firmware for your printer.



Note • Some functions may not work properly if there are underscores in a file name. Use periods instead.

2. In the **/files** folder, place the following file:

- **File 1: ZEBRA.BMP**

3. In the **/commands** folder, place the following files:

- **File 2: SAMPLELABEL.TXT**
- **File 3: LOGO.ZPL**

4. Insert the USB Flash drive into a USB host port on your printer.

5. Observe the user interface and wait. The following should happen:

- If the firmware on the USB Flash drive is different than what is on the printer, the firmware downloads to the printer. The printer then restarts and prints a printer configuration label. (If there is no firmware on the USB Flash drive or if the firmware version is the same, the printer skips this action.)
- The printer downloads the files in the **/files** folder and briefly shows the names of the files that are downloading on the display.
- The printer executes any files in the **/commands** folder.
- The printer restarts and then displays the message **MIRROR PROCESSING FINISHED.**

6. Remove the USB Flash drive from the printer.

Exercise 1: Advanced User Information

See the ZPL Programming Guide for more information about these commands.

Enable/disable mirroring:

```
! U1 setvar "usb.mirror.enable" "value" – Values: "on" or "off"
```

Enable/disable automatic mirroring that occurs when a USB Flash drive is inserted into the USB host port:

```
! U1 setvar "usb.mirror.auto" "value" – Values: "on" or "off"
```

Mirror Operation Retry Number — Specify the number of times that the mirror operation will be repeated if it fails:

```
! U1 setvar "usb.mirror.error_retry" "value" – Values: 0 to 65535
```

Change File Path FROM USB — Reprogram the file location the printer searches to retrieve files from the USB memory during Mirror operations.

```
! U1 setvar "usb.mirror.appl_path" "new_path" – Default: "zebra/appl"
```

Change File Path TO USB — Reprogram the file location the printer places files into USB memory during Mirror operations.

```
! U1 setvar "usb.mirror.path" "path" – Default: "zebra"
```

Enable/disable the USB Host port

```
! U1 setvar "usb.host.lock_out" "value" – Values: "on" or "off"
```

Exercise 5: Enter Data for a Stored File with a Smart Device and Print a Label



Note • The steps in this exercise may vary somewhat based on your smart device, on your service provider, or on whether you already have the free Zebra Utilities app installed on your smart device.

Refer to the Zebra Bluetooth User Guide for specific instructions for configuring your printer to use a Bluetooth interface. A copy of this manual is available at: <http://www.zebra.com/manuals>.

1. If you do not have the Zebra Utilities APP installed on your device, go to the APP store for your device, search for the Zebra Utilities app, and install it.
2. Pair your smart device with the printer by holding the smart device next to the Zebra Print Touch icon on the printer.
 - a. If necessary, access the Bluetooth information about your printer using your smart device. For instructions, refer to the manufacturer's documentation for your device.
 - b. If necessary, select the Zebra printer's serial number to pair it with the device.



The printer and your device are paired.

3. Start the Zebra Utilities APP on your device.

The Zebra Utilities main menu displays.



USB Host Port and Link-OS Demonstration Examples

4. Perform these steps if you have an Apple device:
 - a. Tap the Settings icon in the lower-right corner.
 - b. Change the setting for **Get Labels From Printer** to **ON**.
 - c. Tap Done.
5. Tap Files.

The smart device gets data from the printer and displays it.



Note • This retrieval process may take a minute or more to complete.

6. Scroll through the formats shown and select **E:SMARTDEVINPUT.ZPL**.

Based on the ^FN field in the label format, the smart device prompts you for your name.

7. Enter your name at the prompt.
8. Change the quantity of labels to print, if desired.
9. Tap PRINT to print the label.

Dimensions

This section provides external printer dimensions. for the following printers:

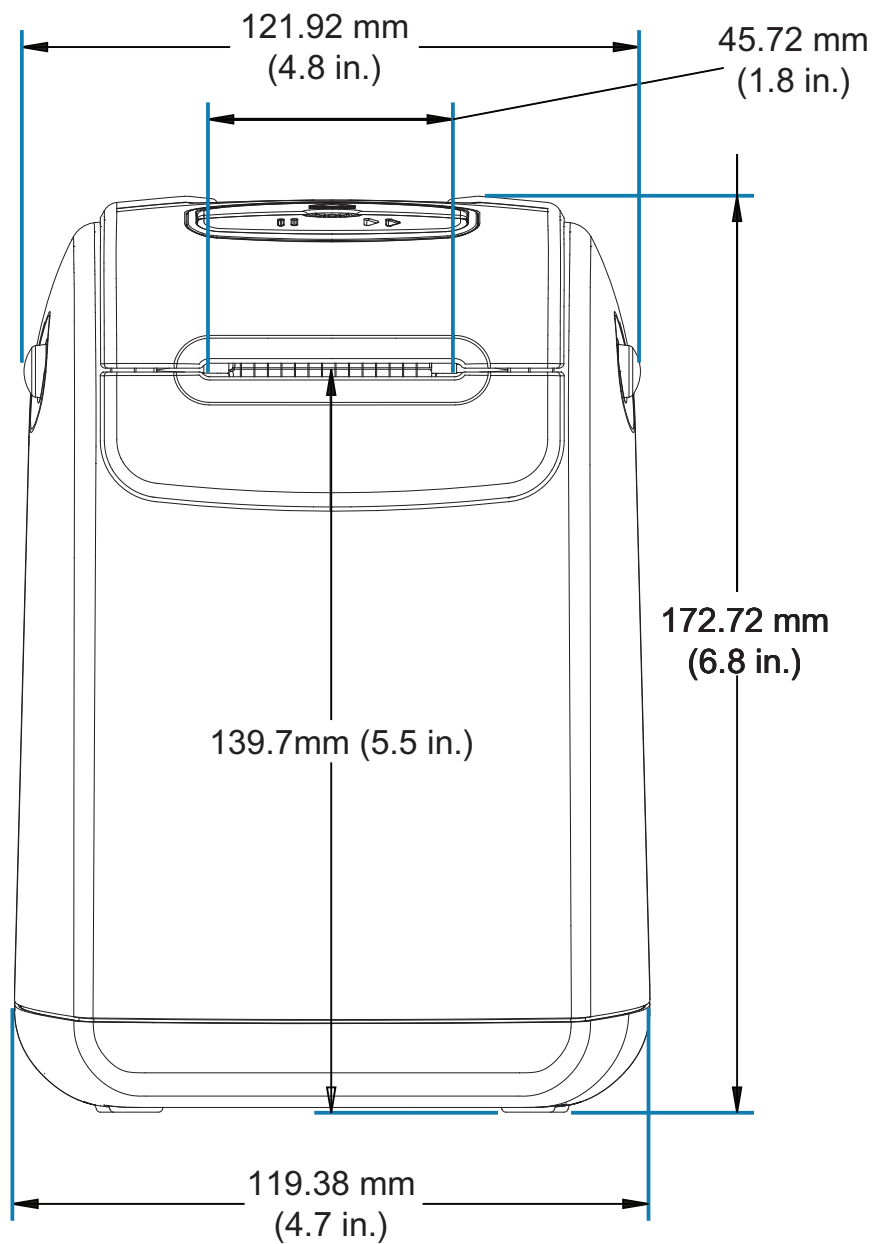

Dimensions

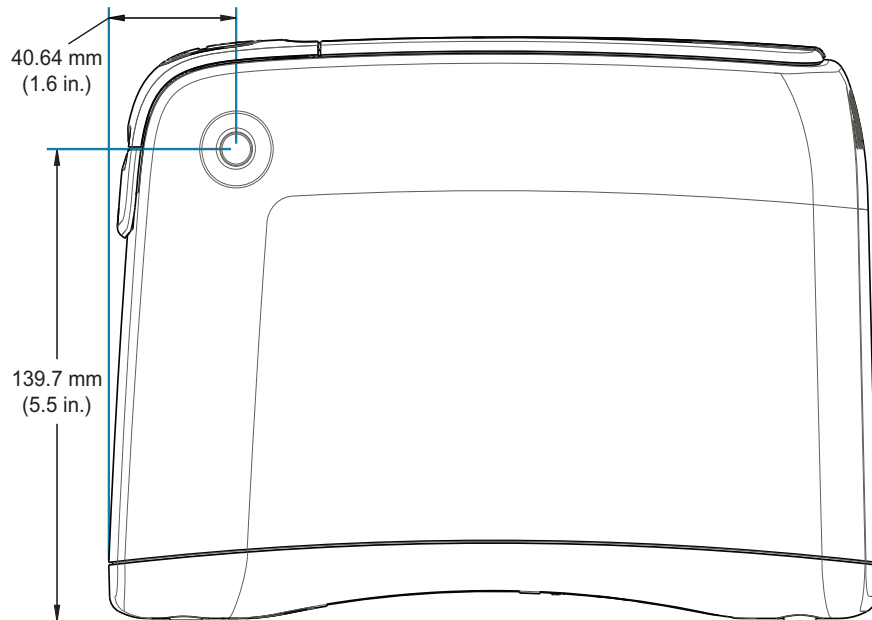
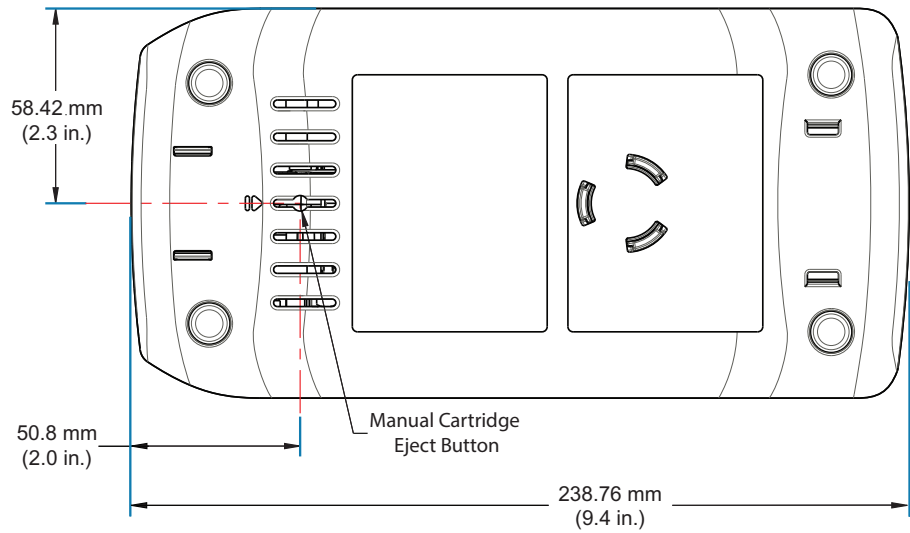
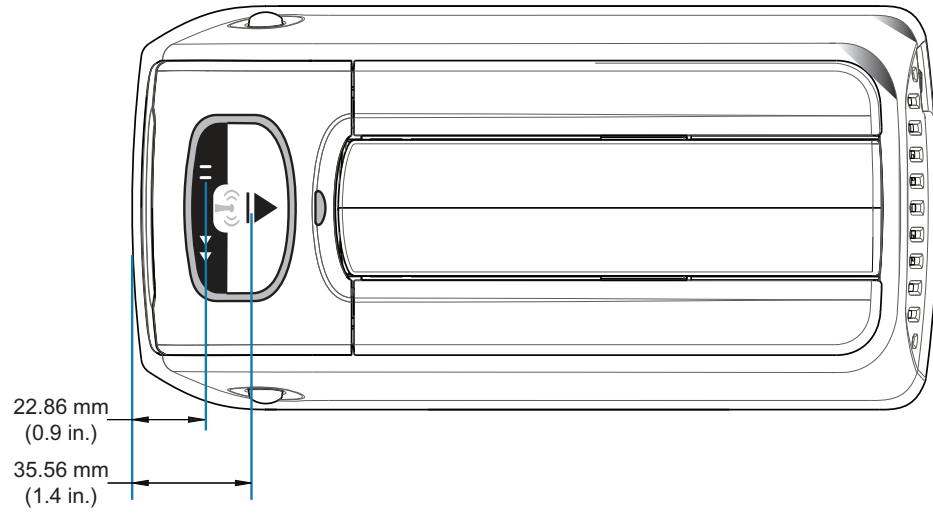

Dimensions

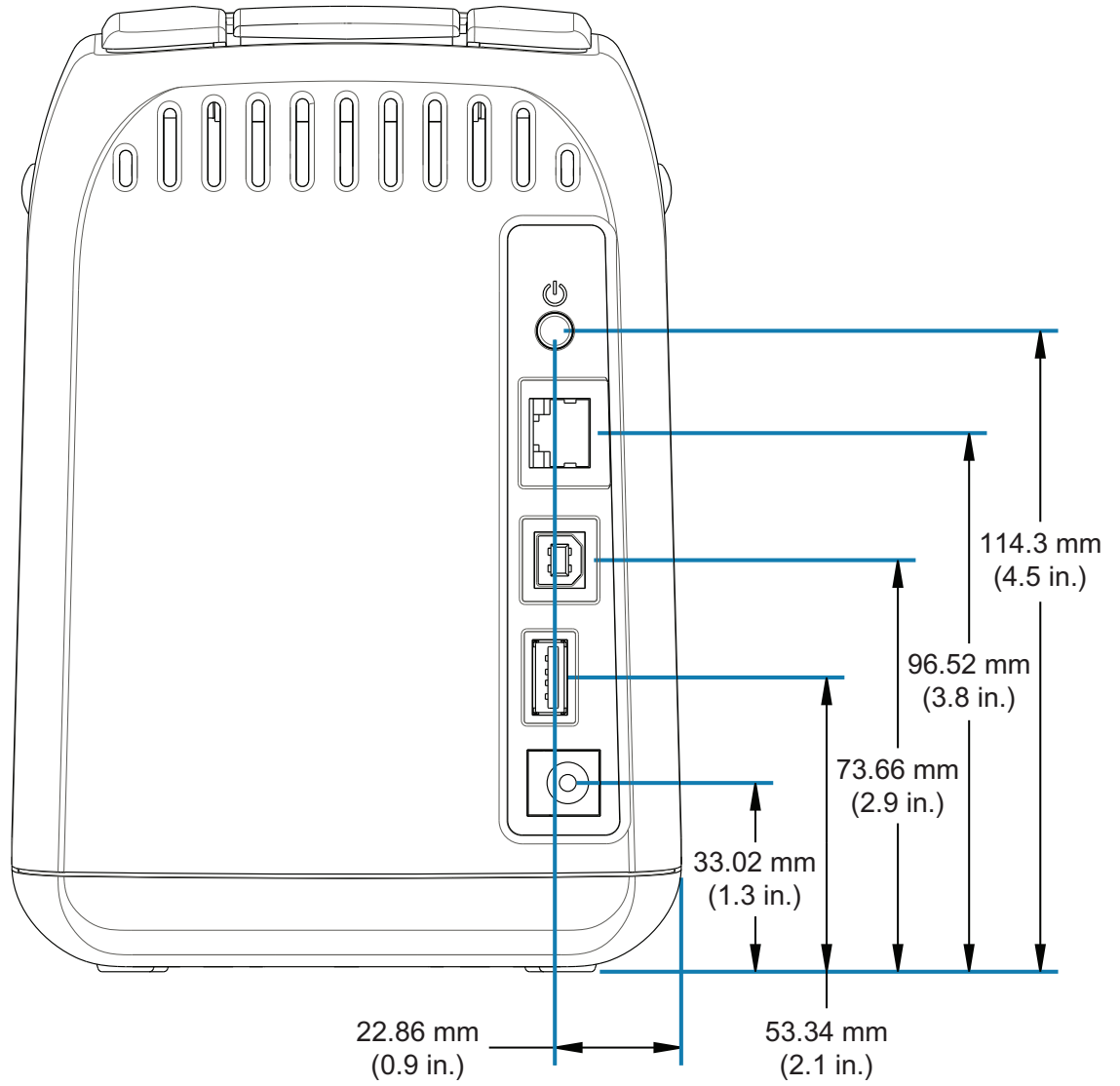

Dimensions

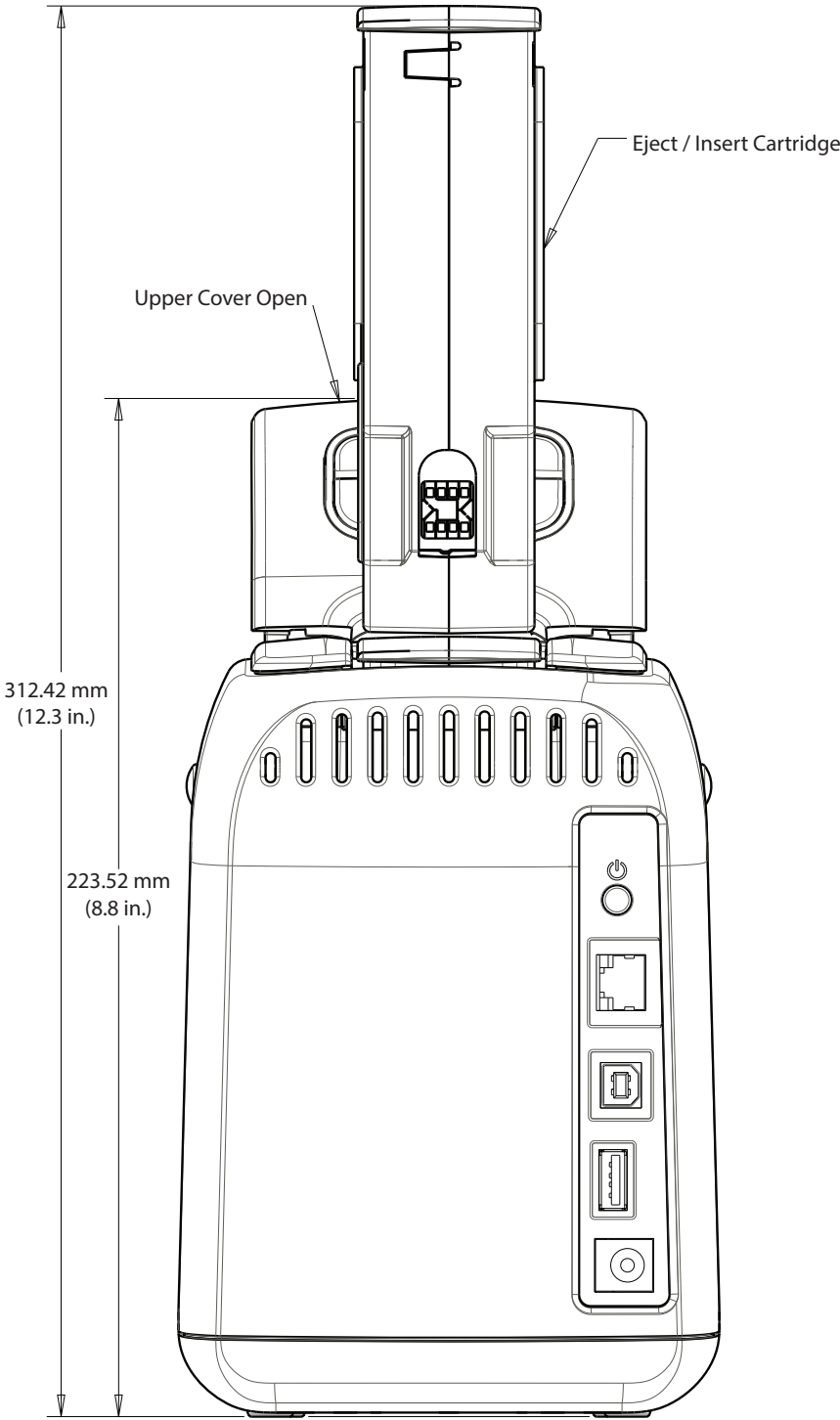

Interface Connector Wiring - USB

Universal Serial Bus (USB) Interface

The figure below displays the cable wiring required to use the printer's USB two interfaces.



Important • When using third party cables, the printer requires USB cables or the cable packaging that bears the “Certified USB™” mark to guarantee USB 2.0 compliance.

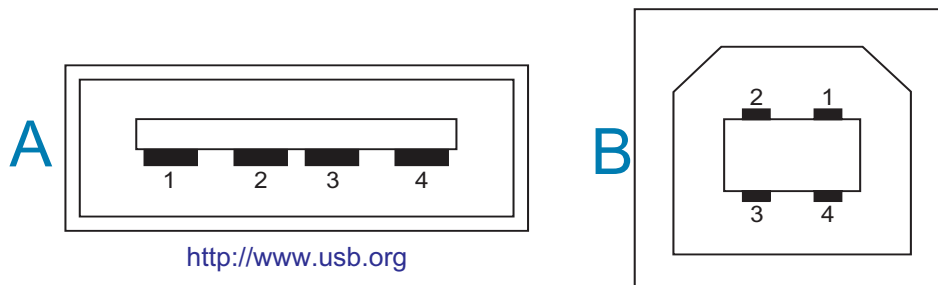

Wiring - USB Connector “A” Style for “connecting to” the printer or device

Pin 1 — Vbus (+5VDC). (Pin 2 — D- (Data Signal, Negative Side)
Pin 3 — D+ (Data Signal, Positive Side)
Pin 4 — Shell (Shield/Drain Wire) Shell

Wiring - USB Connector “B” Style for “connecting to” the printer or device

Pin 1 — Vbus (Not Connected)
Pin 2 — D- (Data Signal, Negative Side)
Pin 3 — D+ (Data Signal, Positive Side)
Pin 4 — Shell (Shield/Drain Wire) Shell



Important • USB Host +5 VDC power source for supplying phantom power. It is limited to 0.5mA per USB Specification and with on-board current limiting. The maximum current available through the USB ports will not exceed a total of 0.75 Amps.

ZPL Configuration

This section provides an overview of managing printer configuration, the Configuring Status Report, and Printer and Memory Printouts.

Managing the ZPL Printer Configuration

The ZPL printer is designed to allow you to change printer settings dynamically for fast first label out printing. Printer parameters that are persistent will be retained for future formats to use. Those settings will remain in effect until they are changed by subsequent commands, the printer is reset, power is cycled, or when you restore a parameter that has a factory default by resetting the printer to factory defaults. The ZPL Configuration Update command (^JU) saves and restores printer configurations to initialize (or re-initialize) the printer with pre-configured settings.

- To keep settings after a power cycle or printer reset, a ^JUS can be sent to the printer to save all current persistent settings.
- The values are recalled with a ^JUR command to restore the last saved values to the printer.

ZPL stores all parameters at once with a single command mentioned above.

The ZD510 Link-OS printer has many options for you to view ALL your printer's settings including:

- The printer's integrated internal Print Server Web pages
- Zebra Setup Utility (Windows and Link-OS APPs)
- Zebra Windows Driver
- ZebraNet Bridge
- ZebraDesigner

The printer configuration report wristband only provides some basic information about the printer, particularly about the connectivity settings. If your printer has an active Ethernet wired or wireless connection, you can view ALL of the printer's settings through the printer's web pages or those other software and driver methods which are not discussed here.

The Configuration Report lists operating parameters, sensor settings, and printer status, see [Accessing the Printer's Web Pages](#).

ZPL Printer Configuration Format

Managing more than one printer can be done by creating a printer configuration programming file to send to one or more printers or ZebraNet™ Bridge can be used to clone a printer's setup. The ZD510 Link-OS printer can also be managed using a USB stick and the USB Host port, see [USB Host Port and Link-OS Demonstration Examples](#).

Figure 1 below shows the basic structure of a ZPL programming configuration file.

See the ZPL programmer's guide and the [Configuration Setting to Command Cross-reference](#) to create a programming file. The Zebra Setup Utility (ZSU) can be used to send programming files to the printer. Windows Notepad (text editor) can be used to create programming files.

Figure 1 • Configuration Parameter Format Structure

^XA — Start Format Command

Format Commands are order sensitive

- a) General Print and command settings
- b) Media handling and behaviors
- c) Media print size

^JUS command to save

^XZ — End Format Command

Configuration Setting to Command Cross-reference

The Printer Configuration Report, shown below, provides a listing of a majority of the configurations settings that can be set by ZPL command, see [Accessing the Printer's Web Pages](#) to view.

Figure 2 • Print Server Web Configuration Report

View Printer Configuration

+21.0	DARKNESS
CARTRIDGE	DARKNESS MODE
2.0 IPS	PRINT SPEED
+000	TEAR OFF ADJUST
TEAR OFF	PRINT MODE
MARK	MEDIA TYPE
REFLECTIVE	SENSOR SELECT
300	PRINT WIDTH
3147	LABEL LENGTH
39.0IN 988MM	MAXIMUM LENGTH
MAINT. OFF	EARLY WARNING
CONNECTED	USB COMM.
NORMAL MODE	COMMUNICATIONS
<~> 7EH	CONTROL PREFIX
<^> 5EH	FORMAT PREFIX
<, > 2CH	DELIMITER CHAR
ZPL II	ZPL MODE
INACTIVE	COMMAND OVERRIDE
+000	LABEL TOP
+0000	LEFT POSITION
DISABLED	REPRINT MODE
DPCSWFXM	MODES ENABLED
.....	MODES DISABLED
672 12/MM FULL	RESOLUTION
5.1	LINK-OS VERSION
V83.20.14ZP40363 <-	FIRMWARE
1.3	XML SCHEMA
6.5.0 0.13	HARDWARE ID
8192k.....R:	RAM
65536k.....E:	ONBOARD FLASH
NONE	FORMAT CONVERT
04/01/18	RTC DATE
14:14	RTC TIME
DISABLED	ZBI
2.1	ZBI VERSION
READY	ZBI STATUS
35 LABELS	NONRESET CNTR
35 LABELS	RESET CNTR1
35 LABELS	RESET CNTR2
866 IN	NONRESET CNTR
867 IN	RESET CNTR1
867 IN	RESET CNTR2
2,201 CM	NONRESET CNTR
2,201 CM	RESET CNTR1
2,201 CM	RESET CNTR2
0	MASS STORAGE COUNT
0	HID COUNT
OFF	USB HOST LOCK OUT

ZPL Configuration

Table 1 • ZPL Commands and Configuration Report Callout Cross-Reference

Command	Listing Name	Description
~SD	DARKNESS	Default: 10.0
-	DARKNESS MODE	CARTRIDGE (Default), USER, or RELATIVE
^PR	PRINT SPEED	Set by media cartridge
~TA	TEAR OFF	Default: +000
^MN	MEDIA TYPE	MARK for Black Mark - Ignored by ZD510 printer
^PW	PRINT WIDTH	Default: 300 dots for 300 dpi
^LL	LABEL LENGTH	Set by media cartridge
^ML	MAXIMUM LENGTH	Default: 39.0IN 989MM
-	USB COMM.	Connection Status: Connected / Not Connected
— SGD —**	COMMUNICATIONS	Default: NORMAL MODE
^CT / ~CT	CONTROL CHAR	Default: <~> 7EH
^CC / ~CC	COMMAND CHAR	Default: <^> 5EH
^CD / ~CD	DELIM./CHAR	Default: <, > 2CH
^SZ	ZPL MODE	Default: ZPL II
— SGD —**	COMMAND OVERRIDE	Default: INACTIVE
^LT	LABEL TOP	Default: +000
^LS	LEFT POSITION	Default: +0000
~JD / ~JE	HEXDUMP	Default: NO (~JE)
	REPRINT MODE	Default: DISABLED
^MP	MODES ENABLED	Default: DPCWFXM (See ^MP Command)
	MODES DISABLED	Default: (nothing set)
^JM	RESOLUTION	Default: 672 12/mm FULL (300 dpi)
-	FIRMWARE	Lists ZPL Firmware Version
-	XML SCHEMA	1.3
-	HARDWARE ID	Lists Firmware Boot-block Version
	LINK-OS VERSION	Lists Link-OS Version
-	RAM	81924k..... R:
-	ONBOARD FLASH	665536k.....E:
^MU	FORMAT CONVERT	NONE
	RTC DATE	Date Displayed
	RTC TIME	Time Displayed
^JI / ~JI	ZBI	DISABLED (Requires key to enable)
—	ZBI VERSION	2.1 (Displayed if installed)
—	ZBI STATUS	READY

ZPL Configuration

Command	Listing Name	Description
^JH ^MA ~R0	LAST CLEANED	X,XXX IN
	HEAD USAGE	X,XXX IN
	TOTAL USAGE	X,XXX IN
	RESET CNTR1	X,XXX IN
	RESET CNTR2	X,XXX IN
	NONRESET CNTR0 (1, 2)	X,XXX IN
	RESET CNTR1	X,XXX IN
	RESET CNTR2	X,XXX IN
	MASS STORAGE COUNT	0
	HID COUNT	0
	USB HOST LOCK OUT	OFF /ON

The printer has the ability to set a command or a group of commands once for all formats and print jobs that follow. Those settings will remain in effect until they are changed by subsequent commands, the printer is reset, or you restore factory defaults.

Printer Memory Management and Related Status Reports

To help you manage printer resources, the printer supports a variety of format commands to manage memory, transfer objects (between memory areas, import and export), object naming, and provide various printer operating status reports. They are very similar to the old DOS commands like DIR (directory listing) and DEL (delete file). The most common reports are also part of the Zebra Setup Utility and ZebraDesigner™ Windows driver.

It is recommended that a single command be processed within this type of format (form). A single command is easily reused as a maintenance and development tool.

^XA — Start Format Command

A Single Format Command is recommended for purposes of reuse

^XZ — End Format Command

Many of the commands that transfer objects, manage and report on memory are control (~) commands. They do not need to be within a format (form). They will be processed immediately upon receipt by the printer whether in a format (form) or not.

ZPL Programming for Memory Management

ZPL has various printer memory locations that are used to run the printer, assemble the print image, store formats (forms), graphics, fonts and configuration settings.

- ZPL treats Formats (Forms), Fonts, and Graphics like files; and memory locations like disk drives in the DOS operating system environment:
 - Memory Object Naming: Up to sixteen (16) alphanumeric characters followed by a three (3) alphanumeric character file extension, for example: **123456789ABCDEF.TTF**
Legacy ZPL printers with V60.13 firmware and earlier can only use the 8.3 file name format versus today's 16.3 file name format.
- Allows moving objects between memory locations and deleting objects.
- Supports DOS directory style file list reports as printouts or status to the host.
- Allows use of 'wild cards' (*) in file access

ZPL Configuration

Table 2 • Object Management and Status Report Commands

Command	Name	Description
^WD	Print Directory Label	Prints a list of objects and resident barcodes and fonts in all addressable memory locations
~WC	Print Configuration Label	Prints a configuration Status Receipt (Label) Same as FEED Button mode one flash routine
^ID	Object Delete	Deletes objects from printer memory
^TO	Transfer Object	Used to copy an object or group of objects from one memory area to another.
^CM	Change Memory Letter Designation	Reassigns a letter designation to a printer memory area.
^JB	Initialize Flash memory	Similar to formatting a disk - erases all objects from the specified memory locations B: or E:.
~JB	Reset Optional Memory	Similar to formatting a disk - erases all objects from the B: memory (factory option).
~DY	Download Objects	Downloads and installs wide variety of printer usable programming objects: fonts (OpenType and TrueType), graphics, and other object data types. Recommendation: Use ZebraNet™ Bridge for downloading graphics and fonts in the printer.
~DG	Download Graphic	Downloads an ASCII Hex representation of a graphic image. This is used by ZebraDesigner™ (label creation application) for graphics.
^FL	Font Linking	Appends secondary TrueType font or fonts to the primary TrueType font to add glyphs (characters).
^LF	List Font Links	Prints a list of the linked fonts
^CW	Font Identifier	Assigns a single alphanumeric character as an alias to a font stored in memory.



Important • Some factory installed ZPL fonts in your printer cannot be copied, cloned or restored to your printer by reloading or updating firmware. If these license restricted ZPL fonts are removed by an explicit ZPL object delete command, they must be repurchased and reinstalled via a font activation and installation utility. EPL fonts do not have this restriction.