



**HP Ink Tank Wireless 410 series**



---

# Table of contents

<b>1 HP Ink Tank Wireless 410 series Help</b> .....	<b>1</b>
<b>2 Get started</b> .....	<b>2</b>
Printer parts .....	3
Get to know the ink tank system .....	5
Control panel features .....	6
Control panel lights and display icons status .....	8
Load media .....	18
Change the default paper size detected by printer .....	22
Load an original on the scanner glass .....	23
Paper basics .....	24
Open the HP printer software (Windows) .....	26
Use the HP Smart app to print, scan, and troubleshoot from an iOS, Android, or Windows 10 device .....	27
Sleep mode .....	28
Quiet Mode .....	29
Auto-Off .....	30
<b>3 Print</b> .....	<b>31</b>
Print using the HP Smart app .....	32
Print from your computer .....	33
Print with mobile devices .....	38
Tips for print success .....	39
<b>4 Use Web Services</b> .....	<b>42</b>
What are Web Services? .....	43
Set up Web Services .....	44
Print with HP ePrint .....	45
Use the HP Connected website .....	46
Remove Web Services .....	47

<b>5 Copy and scan .....</b>	<b>48</b>
Copy documents .....	49
Scan using the HP Smart app .....	50
Scan using the HP printer software .....	52
Scan using Webscan .....	56
Tips for copy and scan success .....	57
<b>6 Manage ink and printhead .....</b>	<b>58</b>
Ink levels .....	59
Refill ink tanks .....	60
Order ink supplies .....	63
Print with black ink only .....	64
Tips for working with ink and printhead .....	65
Move printer .....	66
<b>7 Connect your printer .....</b>	<b>67</b>
Connect your printer to a wireless network with a router .....	68
Connect wirelessly to the printer without a router .....	71
Connect your printer by using the HP Smart app .....	74
Wireless settings .....	75
Connect your printer to your computer with a USB cable (non-network connection) .....	76
Change from a USB connection to a wireless network .....	77
Advanced printer management tools (for networked printers) .....	78
Tips for setting up and using a networked printer .....	80
<b>8 Solve a problem .....</b>	<b>81</b>
Jams and paper-feed issues .....	82
Printhead issues .....	89
Printing issues .....	95
Copy issues .....	104
Scan issues .....	105
Network and connection issues .....	106
Get help from the HP Smart app .....	108
Printer hardware issues .....	109
Control panel error codes .....	110
HP support .....	111
<b>Appendix A Technical information .....</b>	<b>113</b>
HP Company notices .....	114
Specifications .....	115

Regulatory notices ..... 117  
Environmental product stewardship program ..... 124

**Index ..... 131**



---

# 1 HP Ink Tank Wireless 410 series Help

Learn how to use your printer.

- [Get started on page 2](#)
- [Print on page 31](#)
- [Use Web Services on page 42](#)
- [Copy and scan on page 48](#)
- [Manage ink and printhead on page 58](#)
- [Connect your printer on page 67](#)
- [Solve a problem on page 81](#)
- [Technical information on page 113](#)

---

## 2 Get started

- [Printer parts](#)
- [Get to know the ink tank system](#)
- [Control panel features](#)
- [Control panel lights and display icons status](#)
- [Load media](#)
- [Change the default paper size detected by printer](#)
- [Load an original on the scanner glass](#)
- [Paper basics](#)
- [Open the HP printer software \(Windows\)](#)
- [Use the HP Smart app to print, scan, and troubleshoot from an iOS, Android, or Windows 10 device](#)
- [Sleep mode](#)
- [Quiet Mode](#)
- [Auto-Off](#)



# Printer parts

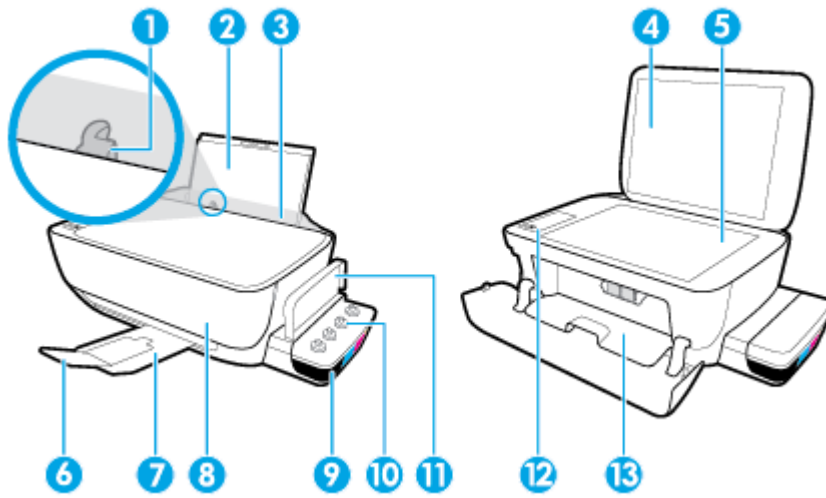

1	Paper-width guide
2	Input tray
3	Input tray shield
4	Scanner lid
5	Scanner glass
6	Output tray extender (also referred to as the tray extender)
7	Output tray
8	Front door
9	Ink tank
10	Ink tank caps
11	Ink tank lid
12	Control panel
13	Printhead access door

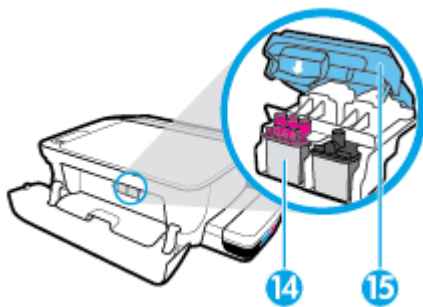

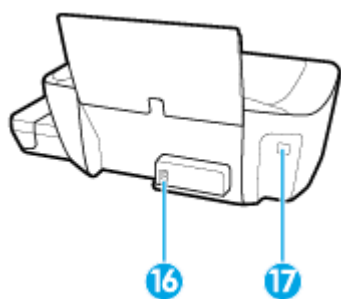

14	Printheads
15	Printhead latch

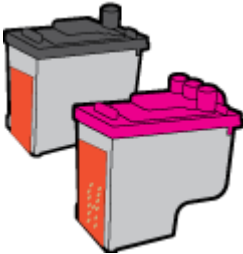
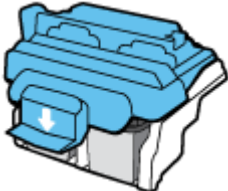

<b>16</b>	Power connection
<b>17</b>	USB port

# Get to know the ink tank system

Term	Definition
Printheads	<p>The printheads are the components in the print mechanism that apply ink to the paper. There are two printheads: a black ink printhead and a tri-color ink printhead.</p> <p><b>CAUTION:</b> After the printheads are installed and primed with ink, do not open the printhead latch unless you are installing new printheads or moving the printer outside your home or office.</p> 
Printhead latch	<p>The printhead latch on the carriage secures the printheads in the carriage. Make sure the printhead latch is properly closed to avoid problems such as carriage jams.</p> <p><b>CAUTION:</b> After the printheads are installed and primed with ink, do not open the printhead latch unless you are installing new printheads or moving the printer outside your home or office.</p> 
Ink tanks	<p>Ink tanks are external ink reservoirs located at the right side of the printer. There are four ink tanks. Each ink tank corresponds to an individual color: black, cyan, magenta, and yellow.</p> 
Ink tank caps	<p>Ink tank caps are rubber plugs that seal each ink tank.</p>
Priming	<p>Priming is the process of filling the ink supply tubes that run between the ink tanks and the printheads. This process occurs when you install new printheads and start the priming process from the control panel. For more information about priming, see <a href="#">Printhead priming and alignment icons on page 12</a>.</p>
Alignment	<p>Alignment is a process of aligning the printheads to improve print quality. For more information about alignment, see <a href="#">Printhead priming and alignment icons on page 12</a>.</p>

# Control panel features

## Overview of buttons and lights

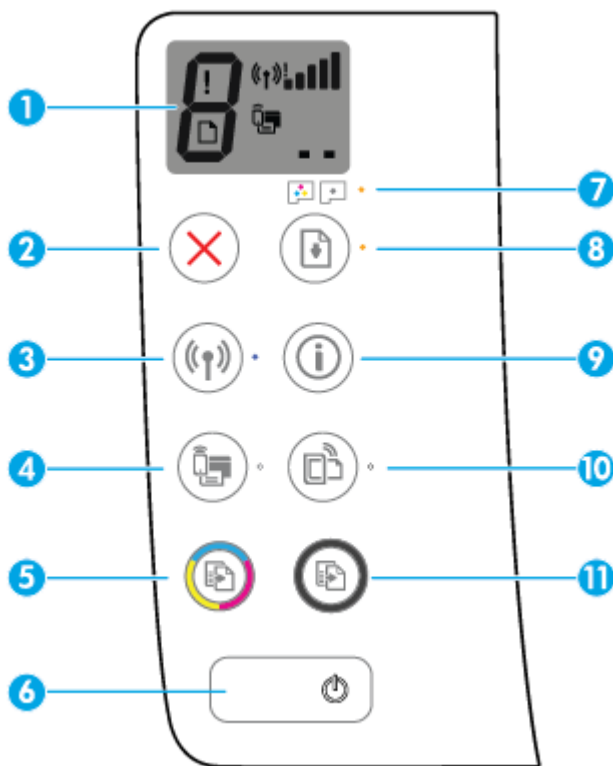



Feature	Description
1	<b>Control Panel Display</b> : Indicates number of copies, printhead priming status, media errors, wireless status and signal strength, Wi-Fi Direct status, and printhead problems.
2	<b>Cancel</b> button: Stops the current operation.
3	<b>Wireless</b> button: Turns on or off the printer wireless capabilities. <b>Wireless</b> light: Indicates whether the printer is connected to a wireless network.
4	<b>Wi-Fi Direct</b> button: Turns on or off Wi-Fi Direct. <b>Wi-Fi Direct</b> light: Indicates the on or off status of Wi-Fi Direct.
5	<b>Color Copy</b> button: Starts a color copy job. To increase the number of color copies, press the button multiple times. Copying will start two seconds after the last button press. <b>NOTE:</b> You can generate a print quality diagnostics report by pressing and holding the <b>Color Copy</b> button for three seconds.
6	<b>Power</b> button: Turns the printer on or off.
7	<b>Printhead Alert</b> light: Indicates printhead problems.
8	<b>Resume</b> button: Resumes a job after a disruption (for example, after loading paper or clearing a paper jam). <b>Resume</b> light: Indicates the printer is in a warning or error state.

Feature	Description
9	<b>Information</b> button: Prints out a printer information page. Press the button in combination with the <b>Wireless</b> button, the Wi-Fi Direct button, or the HP ePrint button to get more specific help pages tied to each of those buttons.
10	<b>HP ePrint</b> button: Turns HP ePrint on or off.  <b>HP ePrint</b> light: Indicates the on or off status of HP ePrint. A blinking light indicates a problem with the connection to Web Services.
11	<b>Black Copy</b> button: Starts a black-and-white copy job. To increase the number of black-and-white copies, press the button multiple times. Copying will start two seconds after the last button press.

## Control panel display icons



Icon	Description
	<b>Number of copies</b> icon: Shows the number of copies when you are copying documents, changes to the letter P when the printer needs priming, and alternates between the letter E and a number when the printer is in an error state.
	<b>Error</b> icon: Indicates an error.
	<b>Paper Error</b> icon: Indicates a paper-related error.
	<b>Wireless</b> status icons: Show the status of a wireless connection.  The wireless status icons consist of three icons, the <b>Wireless</b> icon (  ) , the <b>Wireless Attention</b> icon (  ) , and the <b>Signal Bars</b> icon (  ) .
	<b>Wi-Fi Direct</b> icon: Indicates Wi-Fi Direct is on or is in the process of being connected.
	<b>Printhead</b> icons: The left printhead icon flashing shows an error related to the tri-color printhead, and the right icon flashing shows an error related to the black printhead.

## Control panel lights and display icons status

- [Power button light](#)
- [Wireless light and icons](#)
- [Wi-Fi Direct light and icon](#)
- [HP ePrint light](#)
- [Printhead icons and Printhead Alert light](#)
- [Printhead priming and alignment icons](#)
- [Error icon, Paper Error icon, and Resume light](#)
- [Number of copies icon](#)
- [Ink system maintenance icon](#)

### Power button light









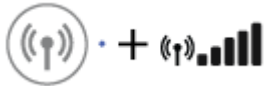

Status	Description
On	The printer is on.
Off	The printer is powered off.
Dimmed	Indicates the printer is in Sleep mode. The printer automatically enters Sleep mode after 5 minutes of inactivity. After 2 hours of inactivity, the printer automatically turns off if not connected to a wireless network or computer.
Blinking	The printer is processing a job. To cancel the job, press the <b>Cancel</b> button (✖).
Fast blinking	If the printhead access door is open, close it. If the printhead access door is closed and the light is blinking fast, the printer is in an error state that you can resolve by following the on-screen messages from the computer. If you do not see any on-screen messages, try printing a document to generate an on-screen message.

### Wireless light and icons

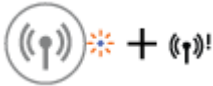
The **Wireless** light next to the **Wireless** button (() and the wireless status icons on the control panel display work together to indicate the status of a wireless connection.

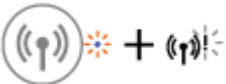
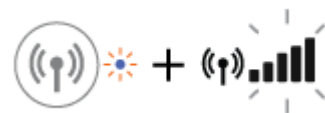
The **Wireless** light and **Wireless** status icons will only light up after alignment is completed during initial setup.



Status	Description
The <b>Wireless</b> light, the <b>Wireless</b> icon, and the <b>Signal Bars</b> icon are on.	The printer is connected to a wireless network.
	
The <b>Wireless</b> light is off.	The wireless capability of the printer is off. To turn on the wireless capability, press the <b>Wireless</b> button (  ).
	
The <b>Wireless</b> light is blinking, the <b>Wireless</b> icon is on, and the <b>Signal Bars</b> icon are cycling.	The printer is in Auto-wireless connect (AWC) mode.
	
The <b>Wireless</b> light blinks for three seconds and then turns off.	The wireless capability of the printer is disabled.
	Change the wireless settings. For more information, see <a href="#">Wireless settings on page 75</a> .
The <b>Wireless</b> light is blinking, and the <b>Wireless</b> icon and <b>Wireless Attention</b> icon are on.	There is no wireless signal. <ul style="list-style-type: none"> <li>• Make sure your wireless router or access point is powered on.</li> <li>• Move the printer closer to the wireless router.</li> </ul>
	
The <b>Wireless</b> light is blinking, the <b>Wireless</b> icon is on, and the <b>Wireless Attention</b> icon is blinking.	One of the following might have occurred. <ul style="list-style-type: none"> <li>• The printer has a problem connecting to the wireless network.</li> <li>• An error occurs or an overlap session is detected when using WPS.</li> </ul>
	Press the <b>Wireless</b> button (  ) and the <b>Information</b> button (  ) together to run the wireless test, and then review the test report for information on how to solve the problem.
The <b>Wireless</b> light is blinking, the <b>Wireless</b> icon is on, and the <b>Signal Bars</b> are blinking together.	The printer is in the Wi-Fi Protected Setup (WPS) push mode.
	

Status	Description
<p>The <b>Wireless</b> light is blinking, and the <b>Wireless</b> icon is on.</p> 	<p>The wireless capability of the printer is on, but has not been configured.</p>
<p>The <b>Wireless</b> light is blinking, the <b>Wireless</b> icon is on, the <b>Signal Bars</b> are cycling, and the <b>Wireless Attention</b> light is on.</p> 	<p>The wireless capability of the printer is on and has been configured before, and the printer is trying to connect to the network.</p>

## Wi-Fi Direct light and icon







The **Wi-Fi Direct** light and **Wi-Fi Direct** status icon will only light up after alignment is completed during initial setup.

Status	Description
<p>The <b>Wi-Fi Direct</b> light and icon are on.</p>	<p>Wi-Fi Direct is turned on and ready to use.</p> <p>To learn how to connect to your printer using Wi-Fi Direct, see <a href="#">Connect wirelessly to the printer without a router on page 71</a>.</p>
<p>The <b>Wi-Fi Direct</b> light and icon are off.</p>	<p>Wi-Fi Direct is off.</p> <p>To turn on Wi-Fi Direct, press the <b>Wi-Fi Direct</b> button .</p>
<p>The <b>Wi-Fi Direct</b> light is blinking.</p>	<p>The printer is connecting to a mobile device in the Wi-Fi Protected Setup (WPS) push mode. Press the <b>Wi-Fi Direct</b> button  to finish connecting.</p>
<p>The <b>Wi-Fi Direct</b> light blinks fast for three seconds, and then stays on.</p>	<p>The printer already has the maximum number of Wi-Fi Direct connection and another device is trying to connect to the printer with Wi-Fi Direct.</p>
<p>The <b>Wi-Fi Direct</b> light blinks fast for three seconds, and then turns off.</p>	<p>Wi-Fi Direct is disabled. For more information, contact the person who set up the printer.</p>

## HP ePrint light





Status	Description
The <b>HP ePrint</b> light is on.	The HP ePrint feature is on and ready to use. For more information, see <a href="#">Print with HP ePrint on page 45</a> .
The <b>HP ePrint</b> light is off.	The HP ePrint feature is off. To turn on HP ePrint, press the <b>HP ePrint</b> button (  )
The <b>HP ePrint</b> light blinks for three seconds, and then turns off.	One of the following might have occurred. <ul style="list-style-type: none"> <li>The Web Services have not been setup up.</li> <li>A mandatory update for the printer is available but has not been installed.</li> <li>The HP ePrint feature has been disabled.</li> </ul> Press the <b>HP ePrint</b> button (  ) and the <b>Information</b> button (  ) at the same time to print a diagnostic page, and then follow the instructions on the page.
The <b>HP ePrint</b> light keeps blinking.	The HP ePrint feature is turned on, but the printer is not connected to the Web Services server. Press the <b>HP ePrint</b> button (  ) and the <b>Information</b> button (  ) at the same time to print a diagnostic page, and then follow the instructions on the page.

## Printhead icons and Printhead Alert light

- The **Error** icon, one of the **Printhead** icons, and the **Printhead Alert** light are blinking.



Cause	Solution
One of the following might have occurred. <ul style="list-style-type: none"> <li>The corresponding printhead is missing.</li> <li>The corresponding printhead is installed incorrectly.</li> <li>The corresponding printhead still has orange plastic tape or the plug on it.</li> </ul>	<ul style="list-style-type: none"> <li>If one of the printheads is missing, insert the corresponding printhead.</li> <li>If both printheads are installed in the printer, remove the corresponding printhead, make sure there is no plug or plastic tape on it, and then reinsert the printhead securely.</li> </ul> <p><b>CAUTION:</b> These instructions are only applicable when you install printheads during initial printer setup. If printheads have been primed with ink, do not open the printhead latch unless installing new printheads or moving the printer outside your home or office.</p> <p>For more information, see <a href="#">Fix printhead problems on page 89</a>.</p>

- The **Error** icon, both **Printhead** icons, and the **Printhead Alert** light are blinking.



Cause	Solution
<p>One of the following might have occurred.</p> <ul style="list-style-type: none"> <li>Both printheads are missing.</li> <li>Both printheads are installed incorrectly.</li> <li>Both printheads still have orange plastic tapes or plugs on them.</li> <li>Both printheads are incompatible or damaged.</li> </ul>	<ul style="list-style-type: none"> <li>If there are no printheads installed in the printer, install the printheads.</li> <li>If both printheads are installed in the printer, remove the printheads, make sure there is no plug or plastic tape on them, and then reinsert the printheads securely.</li> </ul> <p><b>CAUTION:</b> These instructions are only applicable when you install printheads during initial printer setup. If printheads have been primed with ink, do not open the printhead latch unless installing new printheads or moving the printer outside your home or office.</p> <ul style="list-style-type: none"> <li>Make sure that you are using the correct HP printheads for your printer.</li> <li>If the error persists, contact HP Support for help.</li> </ul>

## Printhead priming and alignment icons

### Printheads ready for priming

- The **Number of copies** icon changes to a blinking P during initial printer setup. At the same time all other icons on the control panel display are turned off.



Cause	Solution
<p>During initial setup, the printer detects that the new printheads are installed and the ink system is ready for priming.</p>	<p>Make sure all ink tanks are filled above the minimum line, and the printhead latch is closed firmly. Press and hold the <b>Resume</b> button (  ) for three seconds to start ink priming.</p> <p><b>NOTE:</b> Priming will occur in the background and will not block printing, copying, or scanning.</p>

### Alignment status icon

- The **Number of copies** icon becomes a blinking A.



Cause	Solution
The alignment page is printing and waiting to scan.	Place the alignment page print side down on the scanner glass, and then press the <b>Color Copy</b> button (  ) on the control panel to align.  <b>NOTE:</b> When scan starts, blinking "A" changes to solid "A". Alignment is complete after the scan.  — If alignment event occurs as part of the priming process during initial printer setup, the solid "A" changes to "0" once alignment is complete.  — If alignment event occurs after initial printer setup, the control panel display returns to normal state once alignment is complete.

### Priming in progress

- Printhead priming is in progress.

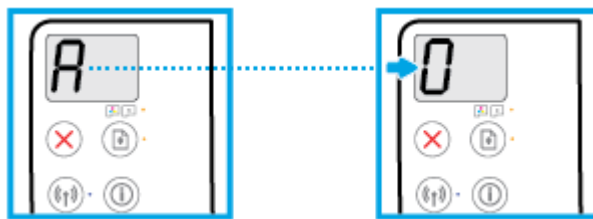

Cause	Solution
Printhead priming is in progress.	Priming can take place in the background when the printer is idle. Priming is complete when the display shows "0".  When priming is in progress, you can still print, scan, or copy.

### Error icon, Paper Error icon, and Resume light

- The **Error** icon, the **Paper Error** icon, and the **Resume** light are on.



Cause	Solution
There is no paper in the input tray.	Load paper in the input tray.  For information about how to load paper, see <a href="#">Load media on page 18</a> .

- The **Error** icon, the **Paper Error** icon, and the **Resume** light are blinking.





Cause	Solution
The printer receives a printing job, and detects that there is no paper in the input tray.	Load paper, and then press the <b>Resume</b> button (  ) to continue printing.  For information about how to load paper, see <a href="#">Load media on page 18</a> .

## Number of copies icon

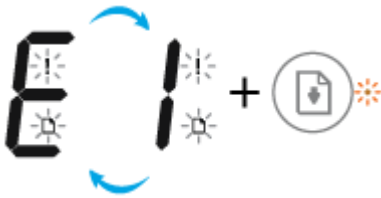
- The **Number of copies** icon is alternating between the letter E and the number 1. At the same time, the **Error** icon, the **Paper Error** icon, and the **Resume** light are blinking.



Cause	Solution
The printer receives a printing job, starts feeding paper, and detects that the paper width for the printing job is bigger than the width of the loaded paper.	Press either the <b>Resume</b> button (  ) or the <b>Cancel</b> button (  ) to cancel the printing job and eject paper.  To avoid the paper size mismatch problem, do one of the following before printing. <ul style="list-style-type: none"> <li>— Change the paper size setting for the printing job to match the paper loaded.</li> <li>— Remove all paper from the input tray, and then load paper that matches the paper size setting for the printing job.</li> </ul> <b>TIP:</b> You can change the default paper size automatically detected by the printer. For more information, see <a href="#">Change the default paper size detected by printer on page 22</a> .

- The **Number of copies** icon is alternating between the letter E and the number 2. The **Resume** light is off.



Cause	Solution
The printer receives a single-page printing job, detects that the paper length for the printing job does not match the length of the loaded paper, and then prints out the page with errors.	<p>To clear the error, press any button on the control panel or wait for two minutes.</p> <p>To avoid the paper length mismatch problem, do one of the following before printing.</p> <ul style="list-style-type: none"> <li>Change the paper size setting for the printing job to match the paper loaded.</li> <li>Remove all paper from the input tray, and then load paper that matches the paper size setting for the printing job.</li> </ul> <p><b>TIP:</b> You can change the default paper size automatically detected by the printer. For more information, see <a href="#">Change the default paper size detected by printer on page 22</a>.</p>

- The **Number of copies** icon is alternating between the letter E and the number 2. At the same time, the **Error** icon, the **Paper Error** icon, and the **Resume** light are blinking.



Cause	Solution
The printer receives a multi-page printing job, detects that the paper length for the printing job does not match the length of the loaded paper, and then prints out the first page of the job with errors.	<ul style="list-style-type: none"> <li>To cancel the printing job, press the <b>Cancel</b> button (✖).</li> <li>To continue printing the remaining pages, press the <b>Resume</b> button (⏪). The remaining pages will have the same errors as the first page.</li> </ul> <p><b>TIP:</b> You can change the default paper size automatically detected by the printer. For more information, see <a href="#">Change the default paper size detected by printer on page 22</a>.</p>

- The **Number of copies** icon is alternating between the letter E and the number 3. At the same time, the **Resume** light is blinking, and the **Power** button light is on.



Cause	Solution
The carriage inside the printer has stalled.	Open the printhead access door, make sure the printhead latch is properly closed and the print carriage is not obstructed. Move the carriage to the right, close the printhead access door, and then press the <b>Resume</b> button (  ) to continue printing.  See <a href="#">Jams and paper-feed issues on page 82</a> for more information.  <b>CAUTION:</b> Do not open the printhead latch unless you are installing new printheads or moving the printer outside your home or office.

- The **Number of copies** icon is alternating between the letter E and the number 4. At the same time, the **Error** icon, the **Paper Error** icon, and the **Resume** light are blinking.

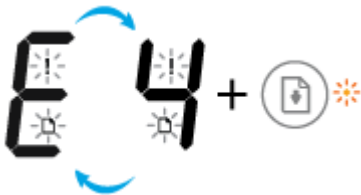

Cause	Solution
There is a paper jam.	Clear the jam, and then press the <b>Resume</b> button (  ) to continue printing.  For more information, see <a href="#">Jams and paper-feed issues on page 82</a> .

- The **Number of copies** icon is alternating between the letter E and the number 5. At the same time, all lights on the control panel are blinking.



Cause	Solution
The scanner is not working.	Turn off and turn on the printer.  If the problem persists, contact HP. The printer still prints even if the scanner is not working.

- The **Number of copies** icon is alternating between the letter E and the number 6.



Cause	Solution
The printer is in an error state.	Reset the printer. <ol style="list-style-type: none"> <li>1. Turn off the printer.</li> <li>2. Unplug the power cord.</li> <li>3. Wait a minute, and then plug the power cord back in.</li> <li>4. Turn on the printer.</li> </ol> If the problem persists, contact HP.

## Ink system maintenance icon

The **Number of copies** icon is alternating between the letter E and the number 9.



Cause	Solution
The printer detects that ink system maintenance is required.	Open the printhead access door completely, and then close it immediately. This process helps remove ink buildup and maintains the best print quality throughout the life of the printer. <p><b>CAUTION:</b> Do not open the printhead latch during this process unless you are installing new printheads or moving the printer outside your home or office.</p>

## Load media

Select a paper size to continue.

### To load full-size paper

1. Raise the input tray.

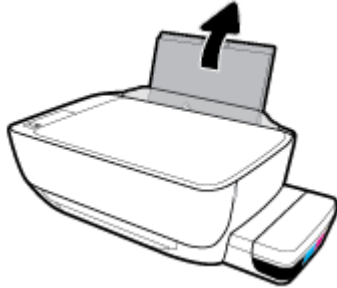

2. Slide the paper-width guide to the left.

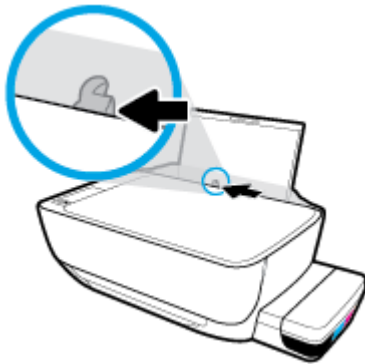

3. Insert a stack of paper into the input tray with the short edge down and the print side up, and slide the stack of paper down until it stops.

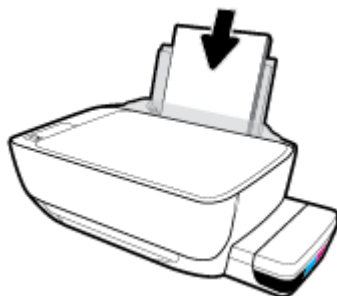



4. Slide the paper-width guide to the right until it stops at the edge of the paper.

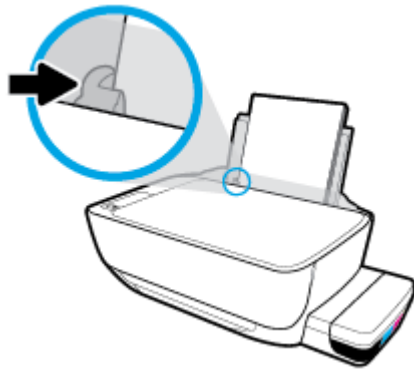

5. Pull out the output tray and the tray extender.



#### To load small-size paper

1. Raise the input tray.

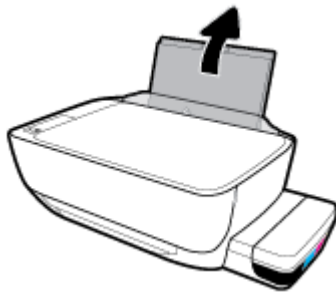

2. Slide the paper-width guide to the left.

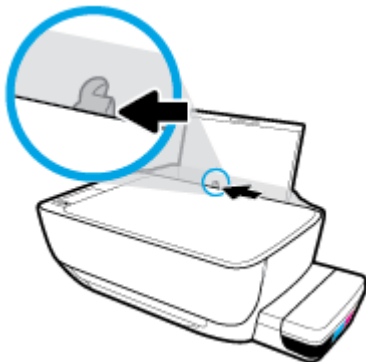

3. Insert a stack of small-size paper (like photo paper) into the far-right side of the input tray with the short edge down and the print side up, and slide the stack of paper down until it stops.



4. Slide the paper-width guide to the right until it stops at the edge of the paper.

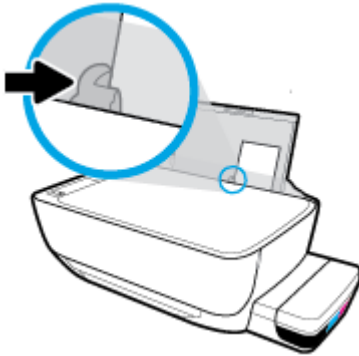

5. Pull out the output tray and the tray extender.



### To load envelopes

1. Raise the input tray.

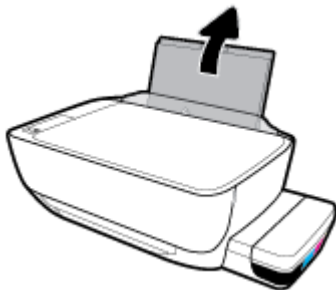

2. Slide the paper-width guide to the left.

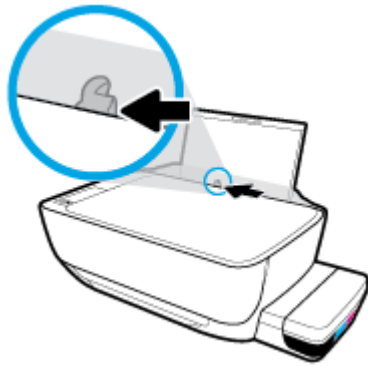

3. Insert one or more envelopes into the far-right side of the input tray and slide the stack of envelopes down until it stops.

The side to be printed on should face up. For envelope with flap on the long edge, insert the envelope vertically with the flap on the left side and facing down. For envelope with the flap on the short edge, insert the envelope vertically with the flap on the top and facing down.

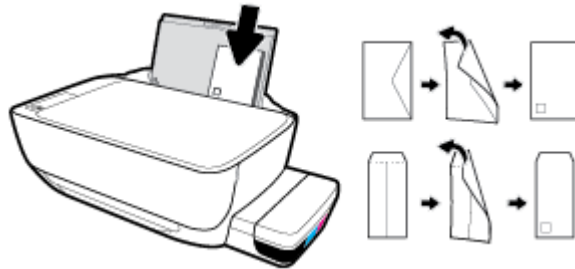

4. Slide the paper-width guide to the right against the stack of envelopes until it stops.

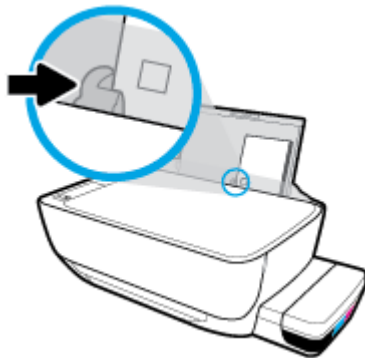

5. Pull out the output tray and the tray extender.



## Change the default paper size detected by printer

The printer can automatically detect whether the input tray is loaded with paper and also detect whether the loaded paper width is large, small, or medium. You can change the default large, medium, or small paper size detected by the printer.

### To change the default paper size detected by the printer

1. Open the embedded web server (EWS). For more information, see [Open the embedded web server on page 78](#).
2. Click the **Settings** tab.
3. In the **Preferences** section, click **Tray and Paper Management**, and then select the desired option.
4. Click **Apply**.

# Load an original on the scanner glass

## To load an original on the scanner glass

1. Lift the scanner lid.



2. Load the original print-side down on the right corner of the scanner glass.



3. Close the scanner lid.



## Paper basics

The printer is designed to work well with most types of office paper. It is best to test a variety of print paper types before buying large quantities. Use HP paper for optimum print quality. Visit the HP website at [www.hp.com](http://www.hp.com) for more information about HP paper.



HP recommends plain papers with the ColorLok logo for printing everyday documents. All papers with the ColorLok logo are independently tested to meet high standards of reliability and print quality, and produce documents with crisp, vivid color, bolder blacks, and that dry faster than ordinary plain papers. Look for papers with the ColorLok logo in a variety of weights and sizes from major paper manufacturers.

This section contains the following topics:

- [Recommended papers for printing](#)
- [Order HP paper supplies](#)

### Recommended papers for printing

If you want the best print quality, HP recommends using HP papers that are specifically designed for the type of project you are printing.

Depending on your country/region, some of these papers might not be available.

#### Photo printing

- **HP Premium Plus Photo Paper**

HP Premium Plus Photo Paper is HP's highest-quality photo paper for your best photos. With HP Premium Plus Photo Paper, you can print beautiful photos that are instant-dry so you can share them right off the printer. It is available in several sizes, including A4, 8.5 x 11 inches, 4 x 6 inches (10 x 15 cm), 5 x 7 inches (13 x 18 cm), and in two finishes - glossy or soft gloss (semi-gloss). Ideal for framing, displaying, or gifting your best photos and special photo projects. HP Premium Plus Photo Paper delivers exceptional results with professional quality and durability.

- **HP Advanced Photo Paper**

This glossy photo paper features an instant-dry finish for easy handling without smudging. It resists water, smears, fingerprints, and humidity. Your prints have a look and feel comparable to a store-processed photo. It is available in several sizes, including A4, 8.5 x 11 inches, 10 x 15 cm (4 x 6 inches), 13 x 18 cm (5 x 7 inches). It is acid-free for longer lasting documents.

- **HP Everyday Photo Paper**

Print colorful, everyday snapshots at a low cost, using paper designed for casual photo printing. This affordable photo paper dries quickly for easy handling. Get sharp, crisp images when you use this paper with any inkjet printer. It is available in glossy finish in several sizes, including A4, 8.5 x 11 inches, 5 x 7 inches, and 4 x 6 inches (10 x 15 cm). It is acid-free for longer lasting documents.

- **HP Photo Value Packs**

HP Photo Value Packs conveniently package original HP ink cartridges and HP Advanced Photo Paper to save you time and take the guesswork out of printing affordable, lab-quality photos with your HP

printer. Original HP inks and HP Advanced Photo Paper have been designed to work together so your photos are long lasting and vivid, print after print. Great for printing out an entire vacation's worth of photos or multiple prints to share.

### Business documents

- **HP Premium Presentation Paper 120g Matte or HP Professional Paper 120 Matt**

This paper is a heavy two-sided matte paper perfect for presentation, proposals, reports, and newsletters. It is heavyweight for an impressive look and feel.

- **HP Brochure Paper 180g Glossy or HP Professional Paper 180 Glossy**

These papers are glossy-coated on both sides for two-sided use. They are the perfect choice for near-photographic reproductions and business graphics for report covers, special presentations, brochures, mailers, and calendars.

- **HP Brochure Paper 180g Matte or HP Professional Paper 180 Matte**

These papers are matte-coated on both sides for two-sided use. They are the perfect choice for near-photographic reproductions and business graphics for report covers, special presentations, brochures, mailers, and calendars.

### Everyday printing

All the papers listed for everyday printing feature ColorLok Technology for less smearing, bolder blacks, and vivid colors.

- **HP Bright White Inkjet Paper**

HP Bright White Inkjet Paper delivers high-contrast colors and sharp text. It is opaque enough for two-sided color usage with no show-through, which makes it ideal for newsletters, reports, and flyers.

- **HP Printing Paper**

HP Printing Paper is a high-quality multifunction paper. It produces documents that look and feel more substantial than documents printed on standard multipurpose or copy paper. It is acid-free for longer lasting documents.

- **HP Office Paper**

HP Office Paper is a high-quality multifunction paper. It is suitable for copies, drafts, memos, and other everyday documents. It is acid-free for longer lasting documents.

- **HP Office Recycled Paper**

HP Office Recycled Paper is a high-quality multifunction paper made with 30% recycled fiber.

## Order HP paper supplies

The printer is designed to work well with most types of office paper. Use HP paper for optimum print quality.

To order HP papers and other supplies, go to [www.hp.com](http://www.hp.com). At this time, some portions of the HP website are available in English only.

HP recommends plain papers with the ColorLok logo for printing and copying of everyday documents. All papers with the ColorLok logo are independently tested to meet high standards of reliability and print quality, and produce documents with crisp, vivid color, bolder blacks and shorter dry-time than ordinary plain papers. Look for papers with the ColorLok logo in a variety of weights and sizes from major paper manufacturers.

## Open the HP printer software (Windows)

After installing the HP printer software, double-click the printer icon on the desktop or do one of the following to open the printer software:

- **Windows 10:** From the computer desktop, click **Start**, select **HP** from the app list, and then select the icon with the printer name.
- **Windows 8.1:** Click the down arrow in lower left corner of the Start screen, and then select the printer name.
- **Windows 8:** Right-click an empty area on the Start screen, click **All Apps** on the app bar, and then select the printer name.
- **Windows 7, Windows Vista, and Windows XP:** From the computer desktop, click **Start**, select **All Programs**, click **HP**, click the folder for the printer, and then select the icon with the printer name.



### NOTE:

- If you have not installed the HP printer software, enter [123.hp.com](http://123.hp.com) in a web browser on your computer to download and install the HP printer software.
  - You can also use the HP printer software CD, or download the HP printer software at [www.support.hp.com](http://www.support.hp.com).
-



# Use the HP Smart app to print, scan, and troubleshoot from an iOS, Android, or Windows 10 device

HP Smart (formerly known as HP All-in-One Printer Remote) helps you to set up, scan, print, share, and manage your HP printer. You can share documents and images through email, text messages, and popular cloud and social media services (such as iCloud, Google Drive, Dropbox, and Facebook). You can also set up new HP printers, as well as monitor and order supplies.

---

 **NOTE:** The HP Smart app might not be available in all languages. Some features might not be available with all printer models.

---

## To install the HP Smart app

- ▲ The HP Smart app is supported on iOS, Android, and Windows 10 devices. To install the app on your device, go to [123.hp.com](https://123.hp.com) and follow the onscreen instructions to access your device's app store.

## To open the HP Smart app on a Windows 10 computer

- ▲ After installing the HP Smart app, from the device desktop, click **Start**, and then select **HP Smart** from the app list.

## Connect to your printer

- ▲ Make sure that the printer is turned on and is connected to the same network as your device. Then HP Smart will automatically detect the printer.

## Get more information about the HP Smart app

For basic instructions on how to print, scan, and troubleshoot using HP Smart, see [Print using the HP Smart app on page 32](#), [Scan using the HP Smart app on page 50](#) and [Get help from the HP Smart app on page 108](#).

For more information about using HP Smart for printing, scanning, accessing printer features, and troubleshooting issues, go to:

- **iOS/Android:** [www.hp.com/go/hpsmart-help](https://www.hp.com/go/hpsmart-help)
- **Windows:** [www.hp.com/go/hpsmartwin-help](https://www.hp.com/go/hpsmartwin-help)

## Sleep mode

- Power usage is reduced while in Sleep mode.
- After initial setup of printer, the printer will enter Sleep mode after 5 minutes of inactivity.
- The **Power** button light is dimmed and the printer control panel display is off in Sleep mode.
- Pressing any button on the control panel, or sending a print or scan job can wake up the printer from sleep mode.

### To change the Sleep mode settings

1. Open the embedded web server (EWS). For more information, see [Open the embedded web server on page 78](#).
2. Click the **Settings** tab.
3. In the **Power Management** section, click **Energy Save Mode**, and select the desired option.
4. Click **Apply**.

# Quiet Mode

Quiet Mode slows down printing to reduce overall noise without affecting print quality. Quiet Mode only works for printing with **Normal** print quality on plain paper. To reduce printing noise, turn on Quiet Mode. To print at normal speed, turn Quiet Mode off. Quiet Mode is off by default.

---

 **NOTE:** In Quiet Mode, if you print on plain paper with the **Draft** or **Best** print quality, or if you print photos or envelopes, the printer works in the same way as when Quiet Mode is off.

---

## To turn Quiet Mode on or off from the printer software (Windows)

1. Open the HP printer software. For more information, see [Open the HP printer software \(Windows\) on page 26](#).
2. Click the **Quiet Mode** tab.
3. Click **On** or **Off**.
4. Click **Save Setting**.

## To turn Quiet Mode on or off from the printer software (OS X and macOS)

1. Open HP Utility.



---

**NOTE:** HP Utility is located in the **HP** folder in the **Applications** folder.

---

2. Select the printer.
3. Click **Quiet Mode**.
4. Select **On** or **Off**.
5. Click **Apply Now**.

## To turn Quiet Mode on or off from the Embedded Web Server (EWS)

1. Open the EWS. For more information, see [Open the embedded web server on page 78](#).
2. Click the **Settings** tab.
3. In the **Preferences** section, select **Quiet Mode**, and then select **On** or **Off**.
4. Click **Apply**.

## Auto-Off

This feature turns the printer off after 2 hours of inactivity to help reduce energy use. **Auto-Off turns the printer off completely, so you must use the Power button to turn the printer back on.** If your printer supports this energy saving feature, Auto-Off is automatically enabled or disabled depending on printer capabilities and connection options. Even when Auto-Off is disabled, the printer enters Sleep mode after 5 minutes of inactivity to help reduce energy use.

- Auto-Off is enabled when the printer is turned on, if the printer does not have network or fax capability, or is not using these capabilities.
- Auto-Off is disabled when a printer's wireless or Wi-Fi Direct capability is turned on or when a printer with fax, USB, or Ethernet network capability establishes a fax, USB, or Ethernet network connection.

---

# 3 Print

- [Print using the HP Smart app](#)
- [Print from your computer](#)
- [Print with mobile devices](#)
- [Tips for print success](#)

## Print using the HP Smart app

This section provides basic instructions for using the HP Smart app to print from your Android, iOS, or Windows 10 device. For more information about using the HP Smart app, go to:

- **iOS/Android:** [www.hp.com/go/hpsmart-help](http://www.hp.com/go/hpsmart-help)
- **Windows:** [www.hp.com/go/hpsmartwin-help](http://www.hp.com/go/hpsmartwin-help)

### To print from a Windows 10 device

1. Load paper in the input tray. For more information, see [Load media on page 18](#).
2. Open HP Smart. For more information, see [Use the HP Smart app to print, scan, and troubleshoot from an iOS, Android, or Windows 10 device on page 27](#).
3. On the HP Smart Home screen, make sure your printer is selected.

---

 **TIP:** If you want to select a different printer, click or tap the Printer icon on the toolbar at the left side of the screen, and then select **Select a Different Printer** to view all available printers.

---
4. At the bottom of the Home screen, click or tap **Print**.
5. Select **Print Photo**, locate a photo you want to print, and then click or tap **Select Photos to Print**.  
Select **Print Document**, locate a PDF document you want to print, and then click or tap **Print**.
6. Select the appropriate options. To view more settings, click or tap **More settings**. For more information about printing settings, see [Tips for print success on page 39](#).
7. Click or tap **Print** to begin printing.

### To print from an Android or iOS device

1. Open the HP Smart app.
2. Tap the Plus icon if you need to change to a different printer, or add a new printer.
3. Tap a printing option (for example, **Print Photos** or **Print Facebook Photos**, etc.). You can print photos and documents from your device, cloud storage, or social media sites.
4. Select the photo or document you want to print.
5. Tap **Print**.

# Print from your computer

- [Print documents](#)
- [Print photos](#)
- [Print envelopes](#)
- [Print using the maximum dpi](#)

## Print documents

Before printing documents, make sure you have paper loaded in the input tray and the output tray is open. For more information about loading paper, see [Load media on page 18](#).

### To print a document (Windows)

1. From your software, select **Print**.
2. Make sure your printer is selected.
3. Click the button that opens the **Properties** dialog box.

Depending on your software application, this button might be called **Properties**, **Options**, **Printer Setup**, **Printer Properties**, **Printer**, or **Preferences**.

4. Select the appropriate options on the **Printing Shortcuts** or **Printing Shortcut** tab.

To change other print settings, click the other tabs.

For more printing tips, see [Printer settings tips on page 40](#).



---

**NOTE:** If you change the paper size, be sure to load the correct paper in the input tray and set the paper size on the printer control panel.

---

5. Click **OK** to close the **Properties** dialog box.
6. Click **Print** or **OK** to begin printing.

### To print documents (OS X and macOS)

1. From the **File** menu in your software, choose **Print**.
2. Make sure your printer is selected.
3. Set the print options.

If you do not see options on the Print dialog, click **Show Details**.

- Choose the appropriate paper size in the **Paper Size** pop-up menu.



---

**NOTE:** If you change the paper size, ensure that you have loaded the correct paper.

---

- Select the orientation.
  - Enter the scaling percentage.
4. Click **Print**.

### To print on both sides of the page (Windows)

1. From your software, select **Print**.
2. Make sure your printer is selected.
3. Click the button that opens the **Properties** dialog box.

Depending on your software application, this button might be called **Properties**, **Options**, **Printer Setup**, **Printer Properties**, **Printer**, or **Preferences**.

4. On the **Printing Shortcuts** or **Printing Shortcut** tab, select the **Two-sided (Duplex) Printing** shortcut, and then select an option from the **Print On Both Sides Manually** drop-down list.

To change other print settings, click the other tabs.

For more printing tips, see [Printer settings tips on page 40](#).



---

**NOTE:** If you change the paper size, be sure to load the correct paper in the input tray and set the paper size on the printer control panel.

---

5. Click **OK** to close the **Properties** dialog box.
6. Click **Print** or **OK** to begin printing.

### To print on both sides of the page (OS X and macOS)

1. From the **File** menu in your software, choose **Print**.
2. In the Print dialog, choose **Paper Handling** from the pop-up menu and set **Page Order** to **Normal**.
3. Set **Pages to Print** to **Odd Only**.
4. Click **Print**.
5. After all of the odd numbered pages have printed, remove the document from the output tray.
6. Reload the document so that the end that came out of the printer is now going into the printer and the blank side of the document is facing toward the front of the printer.
7. In the Print dialog, return to the **Paper Handling** pop-up menu and set the page order to **Normal** and the pages to print to **Even Only**.
8. Click **Print**.

## Print photos

Before printing photos, make sure you have photo paper loaded in the input tray and the output tray is open. For more information about loading paper, see [Load media on page 18](#).

### To print a photo on photo paper (Windows)

1. From your software, select **Print**.
2. Make sure your printer is selected.
3. Click the button that opens the **Properties** dialog box.

Depending on your software application, this button might be called **Properties**, **Options**, **Printer Setup**, **Printer Properties**, **Printer**, or **Preferences**.



4. Select the appropriate options on the **Printing Shortcuts** or **Printing Shortcut** tab.

To change other print settings, click the other tabs.

For more printing tips, see [Printer settings tips on page 40](#).



---

**NOTE:** If you change the paper size, be sure to load the correct paper in the input tray and set the paper size on the printer control panel.

---

5. Click **OK** to close the **Properties** dialog box.
6. Click **Print** or **OK** to begin printing.



---

**NOTE:** After the printing is finished, remove unused photo paper from the input tray. Store the photo paper so it does not start to curl, which could reduce the quality of your printout.

---

### To print a photo from the computer (OS X and macOS)

1. From the **File** menu in your software, choose **Print**.
2. Make sure your printer is selected.
3. Set the print options.

If you do not see options on the Print dialog, click **Show Details**.

- Choose the appropriate paper size in the **Paper Size** pop-up menu.



---

**NOTE:** If you change the paper size ensure that you have loaded the correct paper.

---

- Select the orientation.
4. From the pop-up menu, choose **Paper Type/Quality**, and then choose the following settings:
    - **Paper Type:** The appropriate photo paper type
    - **Quality:** Select the option that provides the best quality or maximum dpi.
    - Click the **Color Options** disclosure triangle, and then choose the appropriate **Photo Fix** option.
      - **Off:** applies no changes to the image.
      - **On:** automatically focuses the image; moderately adjusts image sharpness.
  5. Select any other print settings you want, and then click **Print**.

## Print envelopes

Before printing envelopes, make sure you have envelopes loaded in the input tray and the output tray is open. You can load one or more envelopes into the input tray. Do not use shiny or embossed envelopes or envelopes that have clasps or windows. For more information about loading envelopes, see [Load media on page 18](#).



---

**NOTE:** For details on how to format text for printing on envelopes, refer to the documentation of the application that you are using.

---

### To print an envelope (Windows)

1. On the **File** menu in your software, click **Print**.
2. Make sure your printer is selected.
3. Click the button that opens the **Properties** dialog box.

Depending on your software application, this button might be called **Properties**, **Options**, **Printer Setup**, **Printer Properties**, **Printer**, or **Preferences**.

4. Select the appropriate options on the **Printing Shortcuts** or **Printing Shortcut** tab.

To change other print settings, click the other tabs.

For more printing tips, see [Printer settings tips on page 40](#).



---

**NOTE:** If you change the paper size, be sure to load the correct paper in the input tray and set the paper size on the printer control panel.

---

5. Click **OK** to close the **Properties** dialog box.
6. Click **Print** or **OK** to begin printing.

### To print envelopes (OS X and macOS)

1. From the **File** menu in your software, choose **Print**.
2. Make sure your printer is selected.
3. Select the appropriate envelope size from the **Paper Size** pop-up menu.

If you do not see options on the Print dialog, click **Show Details**.



---

**NOTE:** If you change the paper size, ensure that you have loaded the correct paper.

---

4. From the pop-up menu, choose **Paper Type/Quality**, and verify the paper type setting is set to **Plain Paper**.
5. Click **Print**.

## Print using the maximum dpi

Use maximum dots per inch (dpi) to print high-quality, sharp images on photo paper.

Printing in maximum dpi takes longer than printing with other settings and requires a large amount of disk space.

For supported print resolutions, visit [the printer support website at www.support.hp.com](http://www.support.hp.com).

### To print in maximum dpi mode (Windows)

1. From your software, select **Print**.
2. Make sure your printer is selected.
3. Click the button that opens the **Properties** dialog box.

Depending on your software application, this button might be called **Properties**, **Options**, **Printer Setup**, **Printer Properties**, **Printer**, or **Preferences**.

4. Select the appropriate options.

#### Windows 10, Windows 8.1, and Windows 8

- Click the **Paper/Quality** tab. From the **Paper Size** drop-down list, select the appropriate paper size. From the **Paper Type** drop-down list, select the appropriate paper type.
- Click the **Advanced** tab, and then select **Print in Max DPI**.

#### Windows 7, Windows Vista, and Windows XP

- Click the **Paper/Quality** tab. From the **Media** drop-down list, select the appropriate paper type.
- Click the **Advanced** button. Select the appropriate paper size from the **Paper Size** drop-down list. In the **Printer Features** area, select **Yes** from the **Print in Max DPI** drop-down list. Then click **OK** to close the **Advanced Options** dialog.

For more printing tips, see [Printer settings tips on page 40](#).

5. Confirm the orientation on the **Layout** tab, and then click **OK** to print.

#### To print using maximum dpi (OS X and macOS)

1. From the **File** menu in your software, choose **Print**.
2. Make sure your printer is selected.
3. Set the print options.

If you do not see options on the Print dialog, click **Show Details**.

- Choose the appropriate paper size in the **Paper Size** pop-up menu.



---

**NOTE:** If you change the paper size ensure that you have loaded the correct paper.

---

- Select the orientation.
4. From the pop-up menu, choose **Paper Type/Quality**, and then choose the following settings:
    - **Paper Type:** The appropriate paper type
    - **Quality: Maximum dpi**
  5. Select any other print settings that you want, and then click **Print**.

# Print with mobile devices

## Print from mobile devices

You can print documents and photos directly from your mobile devices, including iOS, Android, Windows Mobile, Chromebook and Amazon Kindle.

---

 **NOTE:** You can also use the HP Smart app to print from mobile devices. For more information, see [Print using the HP Smart app on page 32](#).

---

### To print from mobile devices

1. Make sure your printer is connected to the same network as your mobile device.

 **TIP:** If you want to print without connecting to a router, use Wi-Fi Direct to print from mobile device. For more information, see [Connect wirelessly to the printer without a router on page 71](#).

---

2. Enable printing on your mobile device:

- **iOS:** Use the **Print** option from the **Share** menu.

---

 **NOTE:** Devices running iOS 4.2 or later have AirPrint® preinstalled.

---

- **Android:** Download the HP Print Service Plugin (supported by most Android devices) from the Google Play Store and enable it on your device.

---

 **NOTE:** Devices running Android 4.4 or later are supported by the HP Print Service Plugin. Devices running Android 4.3 or earlier can print using the HP ePrint app, available in the Google Play Store.

---

- **Windows Mobile:** Tap **Print** from the **Device** menu. No setup is required since the software is preinstalled.

---

 **NOTE:** If your printer is not listed, you might need to do a one-time setup of the printer using the **Add Printer** wizard.

---

- **Chromebook:** Download and install the **HP Print for Chrome** app from the Chrome Web Store to enable both Wi-Fi and USB printing.
- **Amazon Kindle Fire HD9 and HDX:** The first time you select **Print** on your device, the HP Print Service Plugin is automatically downloaded to enable mobile printing.

---

 **NOTE:** For detailed information about enabling printing from your mobile devices, visit the HP Mobile Printing website ( [www.hp.com/go/mobileprinting](http://www.hp.com/go/mobileprinting) ). If a local version of this website is not available in your country/region or language, you might be directed to the HP Mobile Printing website in another country/region or language.

---

3. Make sure the loaded paper matches the paper settings of the printer (see [Load media on page 18](#) for more information). Accurately setting the paper size for the paper that is loaded enables your mobile device to know what paper size it is printing.

## Tips for print success

- [Printhead and ink tips](#)
- [Paper loading tips](#)
- [Printer settings tips](#)

To print successfully, the HP printheads should be functioning properly, the ink tanks should be filled with sufficient ink, the paper should be loaded correctly, and the printer should have the appropriate settings.

Print settings do not apply to copying or scanning.

### Printhead and ink tips

- Use original HP printheads.
- Install both the black and tri-color printheads correctly.  
For more information, see [Fix printhead problems on page 89](#).
- Check the ink levels on the ink tanks to make sure there is sufficient ink.  
For more information, see [Ink levels on page 59](#).
- If the print quality is not acceptable, see [Printing issues on page 95](#) for more information.



**NOTE:** Original HP printheads and ink are designed and tested with HP printers and papers to help you easily produce great results, time after time.

HP cannot guarantee the quality or reliability of non-HP supplies. Product service or repairs required as a result of using a non-HP supply will not be covered under warranty.

### Paper loading tips

- Load a stack of paper (not just one page). All of the paper in the stack should be in the same size and type to avoid a paper jam.
- Load the paper with side to be printed on facing up.
- Ensure that paper loaded in the input tray lays flat, and the edges are not bent or torn.
- Adjust the paper-width guide in the input tray to fit snugly against all paper. Make sure the paper-width guide does not bend the paper in the input tray.  
For more information, see [Load media on page 18](#).

## Printer settings tips

### Printer settings tips (Windows)

- To change default print settings, open the HP printer software, click **Print & Scan**, and then click **Set Preferences**. For information how to open the printer software, see [Open the HP printer software \(Windows\) on page 26](#).
- You can use printing shortcuts to save time setting desired printing preferences. A printing shortcut stores the settings that are appropriate for a particular type of job, so that you can set all the options with a single click. To use a shortcut, go to the **Printing Shortcuts** or **Printing Shortcut** tab, select the desired shortcut, and then click **OK**.

To add a new printing shortcut, set the desired printing preferences on the **Paper/Quality**, **Layout**, or **Advanced** tab, select the **Printing Shortcuts** or **Printing Shortcut** tab, click **Save As** and enter a name, and then click **OK**.

To delete a printing shortcut, select it, and then click **Delete**.



---

**NOTE:** You cannot delete the default printing shortcuts.

---

- To understand paper and paper tray settings:
  - **Paper Size:** Select the paper size you loaded in the input tray.
  - **Paper Source:** Select the paper tray you loaded the paper into.
  - **Paper Type** or **Media:** Select the paper type you are using.
- To understand color or black and white settings:
  - **Color:** Uses ink from all cartridges for full color prints.
  - **Black & White** or **Black Ink Only:** Uses the black ink only for normal or lower quality black and white prints.
  - **High Quality Grayscale:** Uses ink from both the color and black cartridges to produce a wider range of black and grey tones for high quality black and white prints.
- To understand print quality settings:

The print quality is measured in print resolution dots per inch (dpi). Higher dpi produces clearer and more detailed prints, but slows print speed and might use more ink.

  - **Draft:** Lowest dpi typically used when ink levels are low or when high quality prints are not needed.
  - **Normal:** Suitable for most print jobs.
  - **Best:** Better dpi than **Normal**.
  - **Print in Max DPI:** Highest dpi setting available for print quality.
  - **HP Real Life Technologies:** This feature smooths and sharpens images and graphics for improved print quality.
- To understand page and layout settings:

- **Orientation:** Select **Portrait** for vertical prints or **Landscape** for horizontal prints.
- **Print on Both Sides Manually:** Manually flip the pages after one side of the paper prints out so that you can print on both sides of the paper.
  - **Flip on Long Edge:** Select it if you want to flip pages by the long edge of the paper when printing on both sides of the paper.
  - **Flip on Short Edge:** Select it if you want to flip pages by the short edge of the paper when printing on both sides of the paper.
- **Booklet Layout or Booklet:** Allows you to print a multiple-page document as a booklet. It places two pages on each side of a sheet that can then be folded into a booklet in half size of the paper.
  - **Left binding or Booklet-LeftBinding:** The binding side after folded into a booklet appears at the left side. Select this option if your reading habit is from left to right.
  - **Right binding or Booklet-RightBinding:** The binding side after folded into a booklet appears at the right side. Select this option if your reading habit is from right to left.
- **Borderless or Page Borders:** Allows you to add or remove borders to the pages if you print the document with two or more pages per sheet.
- **Pages per Sheet Layout:** Helps you specify the order of the pages if you print the document with more than two pages per sheet.
- **Pages to Print:** Allows you to print the odd pages only, print the even pages only, or print all pages.
- **Reverse page order or Page Order:** Allows you to print pages from front to back or in reverse order.

### Printer settings tips (OS X and macOS)

- On the Print dialog, use the **Paper Size** pop-up menu to select the size of paper loaded in the printer.
- On the Print dialog, choose the **Paper Type/Quality** pop-up menu and select the appropriate paper type and quality.
- To print a black and white document using only black ink, choose the **Paper Type/Quality** from the pop-up menu and choose **Grayscale** from the Color pop-up menu.

---

# 4 Use Web Services

- [What are Web Services?](#)
- [Set up Web Services](#)
- [Print with HP ePrint](#)
- [Use the HP Connected website](#)
- [Remove Web Services](#)



## What are Web Services?

### HP ePrint

- HP ePrint is a free service from HP that allows you to print to your HP ePrint-enabled printer anytime, from any location. It's as simple as sending an email to the email address assigned to your printer when you enable Web Services on the printer. No special drivers or software are needed. If you can send an email, you can print from anywhere, using HP ePrint.

Once you have signed up for an account on HP Connected ( [www.hpconnected.com](http://www.hpconnected.com) ) that might not be available in all countries/regions, you can sign in to view your HP ePrint job status, manage your HP ePrint printer queue, control who can use your printer's HP ePrint email address to print, and get help for HP ePrint.

# Set up Web Services

Before you set up Web Services, make sure your printer is connected to the Internet using a wireless connection.

## To set up Web Services

1. Open the embedded web server (EWS). For more information, see [Open the embedded web server on page 78](#).
2. Click the **Web Services** tab.
3. In the **Web Services Settings** section, click **Setup**, click **Continue**, and follow the onscreen instructions to accept the terms of use.
4. If prompted, choose to allow the printer to check for and install printer updates.



**NOTE:** If a printer update is available, the printer downloads and installs the update, and then restarts. Repeat the instructions from step 1 to set up Web Services.



**NOTE:** If prompted for proxy settings and if your network uses proxy settings, follow the on-screen instructions to set up a proxy server. If you do not have the proxy details, contact your network administrator or the person who set up the network.

---

5. When the printer is connected to the server, the printer prints an information page. Follow the instructions on the information page to finish the setup.

# Print with HP ePrint



HP ePrint allows you to print to your HP ePrint-enabled printer anytime, from any location.

Before you can use HP ePrint, make sure the printer is connected to an active network providing Internet access.

## To print a document using HP ePrint

1. Make sure you have set up Web Services.

For more information, see [Set up Web Services on page 44](#).

2. Press the **HP ePrint** button () and the **Information** button () at the same time to print an information page, and then find the email address for your printer from the page.
3. Email your document to the printer.

- a. On your computer or mobile device, open your email application.

---

 **NOTE:** For information about using the email application on your computer or mobile device, see the documentation provided with the application.

---

- b. Create a new email and attach the document to print.
- c. Send the email to the printer email address.

The printer prints the attached document.

---

 **NOTE:** Enter only the HP ePrint email address in the "To" field. Do not enter any additional email addresses in the other fields. The HP ePrint server does not accept email print jobs if there are multiple addresses in the "To" field or any address in the "Cc" field."

 **NOTE:** The email will be printed once it is received. As with any email, there is no guarantee when or whether it will be received. You can check the print status on HP Connected ([www.hpconnected.com](http://www.hpconnected.com)). This site might not be available in all countries/regions.

 **NOTE:** Documents printed with HP ePrint may appear different from the original. Style, formatting, and text flow may differ from the original document. For documents that need to be printed with a higher quality (such as legal documents), we recommend that you print from the software application on your computer, where you will have more control over what your printout looks like.

---

## To turn off HP ePrint

- ▲ From the printer control panel, press the **HP ePrint** button ()

---

 **NOTE:** To remove all Web Services, see [Remove Web Services on page 47](#).

---

 [Click here to go online for more information.](#)

## Use the HP Connected website

Use HP's free HP Connected website to set up increased security for HP ePrint, and specify the email addresses that are allowed to send email to your printer. You can also get product updates, and other free services.

Go to the HP Connected website (might not be available in all countries/regions) for more information and specific terms and conditions: [www.hpconnected.com](http://www.hpconnected.com).

## Remove Web Services

To remove Web Services, complete the following steps:

1. Open the embedded web server (EWS). For more information, see [Open the embedded web server on page 78](#).
2. Click the **Web Services** tab, and then click **Remove Web Services** in the **Web Services Settings** section.
3. Click **Remove Web Services**.
4. Click **Yes** to remove Web Services from your printer.

---

# 5 Copy and scan



- [Copy documents](#)
- [Scan using the HP Smart app](#)
- [Scan using the HP printer software](#)
- [Scan using Webscan](#)
- [Tips for copy and scan success](#)

# Copy documents

 **NOTE:** All documents are copied in normal quality print mode. You cannot change the print mode quality when copying.

You can also use the HP Smart app to copy from your mobile device. For information about this app, see [Use the HP Smart app to print, scan, and troubleshoot from an iOS, Android, or Windows 10 device on page 27.](#)

## To copy documents

1. Load paper in the input tray.  
For information about how to load paper, see [Load media on page 18.](#)
2. Load the original print side down on the right front corner of the scanner glass.  
For more information, see [Load an original on the scanner glass on page 23.](#)
3. Press either the **Black Copy** button () or the **Color Copy** button () to make a copy.

Copying will start two seconds after the last button press.

 **TIP:** You can increase the number of copies by pressing the button multiple times.

## Scan using the HP Smart app

You can use the HP Smart app to scan documents or photos from the printer's scanner, and you can also scan using your device camera. HP Smart includes editing tools that allow you to adjust the scanned image before saving or sharing. You can print, save your scans locally or in cloud storage, and share them via email, SMS, Facebook, Instagram, etc. To scan with HP Smart, follow the instructions provided in the appropriate section below, depending on the type of device you are using.

- [Scan from a Windows 10 device](#)
- [Scan from an Android or iOS device](#)

This section provides basic instructions for using the HP Smart app to scan from your Android, iOS, or Windows 10 device. For more information about using the HP Smart app, go to:

- **iOS/Android:** [www.hp.com/go/hpsmart-help](http://www.hp.com/go/hpsmart-help)
- **Windows:** [www.hp.com/go/hpsmartwin-help](http://www.hp.com/go/hpsmartwin-help)

### Scan from a Windows 10 device

#### To scan a document or photo using the printer scanner

1. Load the original print side down on the right front corner of the scanner glass.
2. Open HP Smart. For more information, see [Use the HP Smart app to print, scan, and troubleshoot from an iOS, Android, or Windows 10 device on page 27](#).
3. Select **Scan**, and then select **Scanner**.
4. Click or tap the Settings icon to modify the basic settings.  
Select Glass from the **Source** drop-down list.
5. Click or tap the Preview icon to preview and adjust the image if necessary.
6. Click or tap the Scan icon.
7. Make other adjustments if necessary:
  - Click or tap **Add** to add more documents or photos.
  - Click or tap **Edit** to rotate or crop the document or image, or adjust its contrast, brightness, saturation, or angle.
8. Select the file type you want, and then click or tap the Save icon to save it or click or tap the Share icon to share it with others.

#### To scan a document or photo using the device camera

If your device has a camera, you can use the HP Smart app to scan a printed document or photo with the device camera. You can then use HP Smart to edit, save, print or share the image.

1. Open HP Smart. For more information, see [Use the HP Smart app to print, scan, and troubleshoot from an iOS, Android, or Windows 10 device on page 27](#).
2. Select **Scan**, and then select **Camera**.



3. Put a document or photo in front of the camera, and then click or tap the round button at the bottom of the screen to take an image.
4. Adjust boundaries if needed. Click or tap the Apply icon.
5. Make other adjustments if necessary:
  - Click or tap **Add** to add more documents or photos.
  - Click or tap **Edit** to rotate or crop the document or image, or adjust its contrast, brightness, saturation, or angle.
6. Select the file type you want, and then click or tap the Save icon to save it or click or tap the Share icon to share it with others.

### To edit a previously scanned document or photo

HP Smart provides editing tools, such as crop and rotate, which you can use to adjust a previously scanned document or photo on your device.

1. Open HP Smart. For more information, see [Use the HP Smart app to print, scan, and troubleshoot from an iOS, Android, or Windows 10 device on page 27](#).
2. Select **Scan**, and then select **Import Local**.
3. Select the document or photo that you want to adjust, and then click or tap **Open**.
4. Adjust boundaries if needed. Click or tap the Apply icon.
5. Make other adjustments if necessary:
  - Click or tap **Add** to add more documents or photos.
  - Click or tap **Edit** to rotate or crop the document or image, or adjust its contrast, brightness, saturation, or angle.
6. Select the file type you want, and then click or tap **Save** or **Share** to save the file or share it with others.

## Scan from an Android or iOS device

### To scan from an Android or iOS device

1. Open the HP Smart app.
  2. Tap the Plus icon if you need to change to a different printer, or add a new printer.
  3. Tap the scanning option you want to use.
    - If you select to scan using the camera, the built-in camera will open. Scan your photo or document using the camera.
    - If you select to scan using the printer scanner, tap the Settings icon to select the input source and change the scan settings, and then tap the Scan icon.
- 
-  **NOTE:** Be sure to select the correct input source if your printer supports scan from both the document feeder and scanner glass.
- 
4. When you have finished adjusting the scanned document or photo, save, share, or print it.

# Scan using the HP printer software

- [Scan from a computer](#)
- [Change scan settings \(Windows\)](#)
- [Create a new scan shortcut \(Windows\)](#)

## Scan from a computer

Before scanning from a computer, make sure you have already installed the HP recommended printer software. The printer and computer must be connected and turned on.

### To scan a document or photo to a file (Windows)

1. Load the original print side down on the right front corner of the scanner glass.
2. Double-click the printer icon on the desktop or do one of the following to open the printer software:
  - **Windows 10:** From the computer desktop, click **Start**, select **All apps**, click **HP**, and then select the icon with the printer name.
  - **Windows 8.1:** Click the down arrow in lower left corner of the Start screen, and then select the printer name.
  - **Windows 8:** Right-click an empty area on the Start screen, click **All Apps** on the app bar, and then select the printer name.
  - **Windows 7, Windows Vista, and Windows XP:** From the computer desktop, click **Start**, select **All Programs**, click **HP**, click the folder for the printer, and then select the icon with the printer name.
3. In the printer software, click **Scan**, and then click **Scan a Document or Photo**.
4. Select the type of scan you want and then click **Scan**.
  - Choose **Save as PDF** to save the document (or photo) as a PDF file.
  - Choose **Save as JPEG** to save the photo (or document) as an image file.



**NOTE:** Click the **More** link at the top right corner of the Scan dialog to review and modify settings for any scan.

For more information, see [Change scan settings \(Windows\) on page 53](#).

If **Show Viewer After Scan** is selected, you can make adjustments to the scanned image in the preview screen.

### To scan a document or photo to email (Windows)

1. Load the original print side down on the right front corner of the scanner glass.
2. Double-click the printer icon on the desktop or do one of the following to open the printer software:
  - **Windows 10:** From the computer desktop, click **Start**, select **All apps**, click **HP**, and then select the icon with the printer name.
  - **Windows 8.1:** Click the down arrow in lower left corner of the Start screen, and then select the printer name.

- **Windows 8:** Right-click an empty area on the Start screen, click **All Apps** on the app bar, and then select the printer name.
  - **Windows 7, Windows Vista, and Windows XP:** From the computer desktop, click **Start**, select **All Programs**, click **HP**, click the folder for the printer, and then select the icon with the printer name.
3. In the printer software, click **Scan** , and then click **Scan a Document or Photo** .
  4. Select the type of scan you want and then click **Scan** .

Choose **Email as PDF** or **Email as JPEG** to open your email software with the scanned file as an attachment.



**NOTE:** Click the **More** link at the top right corner of the Scan dialog to review and modify settings for any scan.

For more information, see [Change scan settings \(Windows\) on page 53](#).

If **Show Viewer After Scan** is selected, you can make adjustments to the scanned image in the preview screen.

### To scan an original from HP printer software (OS X and macOS)

1. Open HP Easy Scan.  
HP Easy Scan is located in the **Applications** folder.
2. Choose the type of scan profile you want.
3. Click **Scan**.

[Go online to learn more about using the HP Scan software](#) to learn how to:

- customize scan settings, such as image file type, scan resolution, and contrast levels.
- preview and adjust images before scanning.

## Change scan settings (Windows)

You can modify any of the scan settings either for a singular use or save the changes to use permanently. These settings include options such as page size and orientation, scan resolution, contrast, and the folder location for saved scans.

1. Load the original print side down on the right front corner of the scanner glass.
2. Double-click the printer icon on the desktop or do one of the following to open the printer software:
  - **Windows 10:** From the computer desktop, click **Start**, select **All apps**, click **HP**, and then select the icon with the printer name.
  - **Windows 8.1:** Click the down arrow in lower left corner of the Start screen, and then select the printer name.
  - **Windows 8:** Right-click an empty area on the Start screen, click **All Apps** on the app bar, and then select the printer name.
  - **Windows 7, Windows Vista, and Windows XP:** From the computer desktop, click **Start**, select **All Programs**, click **HP**, click the folder for the printer, and then select the icon with the printer name.

3. In the printer software, click **Scan** , and then click **Scan a Document or Photo** .
4. Click the **More** link in the top right corner of the HP Scan dialog.

The detailed settings pane appears on the right. The left column summarizes the current settings for each section. The right column allows you to change the settings in the highlighted section.

5. Click each section at the left of the detailed settings pane to review the settings in that section.

You can review and change most settings using drop-down menus.

Some settings allow greater flexibility by displaying a new pane. These are indicated by a + (plus sign) at the right of the setting. You must either click **OK** to accept or click **Cancel** to cancel any changes on this pane to return to the detailed settings pane.

6. When you have finished changing settings, do one of the following.
  - Click **Scan** . You are prompted to save or reject the changes to the shortcut after the scan is finished.
  - Click the save icon to the right of the shortcut, and then click **Scan** .

 Learn more about using the HP Scan software. [Click here to go online for more information](#). At this time, this website might not be available in all languages.

- customize scan settings, such as image file type, scan resolution, and contrast levels.
- preview and adjust images before scanning.

## Create a new scan shortcut (Windows)

You can create your own scan shortcut to make scanning easier. For example, you might want to regularly scan and save photos in PNG format, rather than JPEG.

1. Load the original print side down on the right front corner of the scanner glass.
2. Double-click the printer icon on the desktop or do one of the following to open the printer software:
  - **Windows 10:** From the computer desktop, click **Start**, select **All apps**, click **HP**, and then select the icon with the printer name.
  - **Windows 8.1:** Click the down arrow in lower left corner of the Start screen, and then select the printer name.
  - **Windows 8:** Right-click an empty area on the Start screen, click **All Apps** on the app bar, and then select the printer name.
  - **Windows 7, Windows Vista, and Windows XP:** From the computer desktop, click **Start**, select **All Programs**, click **HP**, click the folder for the printer, and then select the icon with the printer name.
3. In the printer software, click **Scan** , and then click **Scan a Document or Photo** .
4. Click **Create New Scan Shortcut** .

5. Enter a descriptive name, choose an existing shortcut on which to base your new shortcut, and then click **Create** .

For example, if you are creating a new shortcut for photos, choose either **Save as JPEG** or **Email as JPEG** . This makes available the options for working with graphics when scanning.

6. Change the settings for your new shortcut to meet your needs, and then click the save icon to the right of the shortcut.



**NOTE:** Click the **More** link at the top right corner of the Scan dialog to review and modify settings for any scan.

For more information, see [Change scan settings \(Windows\) on page 53](#).

---

## Scan using Webscan

Webscan is a feature of the embedded web server that lets you scan photos and documents from your printer to your computer using a web browser.

This feature is available even if you did not install the printer software on your computer.



---

**NOTE:** By default, Webscan is off. You can enable this feature from the EWS.

If you are unable to open Webscan in the EWS, your network administrator might have turned it off. For more information, contact your network administrator or the person who set up your network.

---

### To enable Webscan

1. Open the embedded web server. For more information, see [Open the embedded web server on page 78](#).
2. Click the **Settings** tab.
3. In the **Security** section, click **Administrator Settings**.
4. Select **Webscan** to enable Webscan.
5. Click **Apply**.

### To scan using Webscan

Scanning using Webscan offers basic scan options. For additional scan options or functionality, scan from the HP printer software.

1. Load the original print side down on the right front corner of the scanner glass.  
For more information, see [Load an original on the scanner glass on page 23](#).
2. Open the embedded web server. For more information, see [Open the embedded web server on page 78](#).
3. Click the **Scan** tab.
4. Click **Webscan** in the left pane, change any settings, and then click **Start Scan**.

## Tips for copy and scan success

Use the following tips to copy and scan successfully:

- Keep the glass and the back of the lid clean. The scanner interprets anything it detects on the glass as part of the image.
- Load your original, print side down, on the right front corner of the glass.
- To make a large copy of a small original, scan the original into the computer, resize the image in the scanning software, and then print a copy of the enlarged image.
- To avoid incorrect or missing scanned text, make sure the brightness is set appropriately in the software.
- You can also use the HP Smart app to scan from your mobile device. For information about this app, see [Use the HP Smart app to print, scan, and troubleshoot from an iOS, Android, or Windows 10 device on page 27](#).

---

# 6 Manage ink and printhead

This section contains the following topics:

- [Ink levels](#)
- [Refill ink tanks](#)
- [Order ink supplies](#)
- [Print with black ink only](#)
- [Tips for working with ink and printhead](#)
- [Move printer](#)



## Ink levels

Use the ink level lines on the ink tanks to determine when to fill the tanks and how much ink should be added.

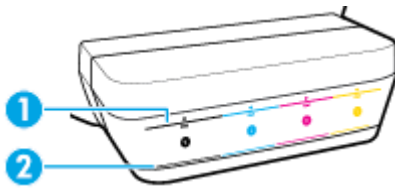

1	Maximum line: The actual ink level should not be higher than the maximum line.
2	Minimum line: The actual ink level should not be lower than the minimum line.

Match the color of the ink bottle to the color on the tank when you fill the tanks, and seal the rubber ink tank caps properly after that.

The ink level in each tank will be a little bit below the maximum fill line when you first fill the tanks.

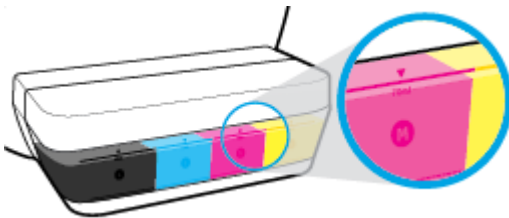

If you notice any ink level reaches the minimum line during daily printing, refill that tank with correct ink. Printing with ink level below the minimum line may cause damage to your printer.

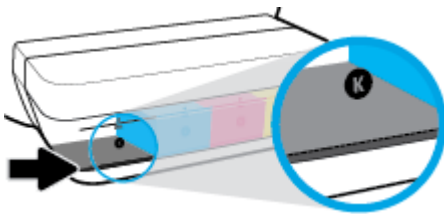

When you refill the ink tanks, fill the ink to the maximum lines only. Any ink level above the maximum line may cause ink leakage.

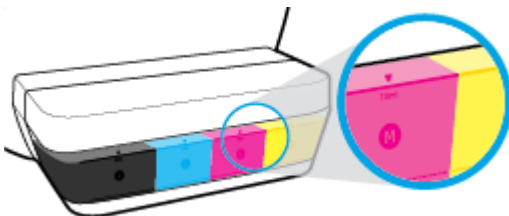

 **NOTE:** Product service or repairs required as a result of filling the ink tanks improperly and/or using non-HP ink will not be covered under warranty.

# Refill ink tanks

## To refill the ink tanks

1. Lift the ink tank lid.

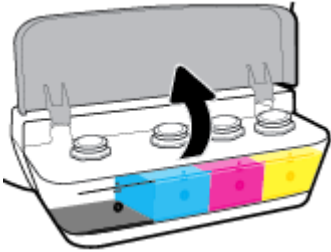

2. Remove the cap of the ink tank you plan to refill.

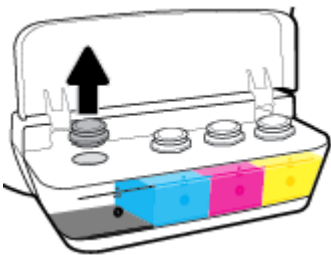

3. Twist to remove the cap of the ink bottle, remove the seal from the bottle, install the cap back onto the bottle, and then pull open the top part of the cap.

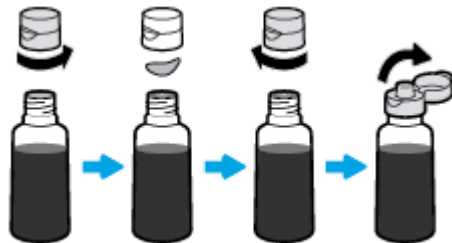

4. Hold the ink bottle on tank nozzle and refill the ink tank to the maximum line only. If ink doesn't drain immediately, remove and reinsert bottle on tank.

**CAUTION:** You should not squeeze the ink bottle during this process.

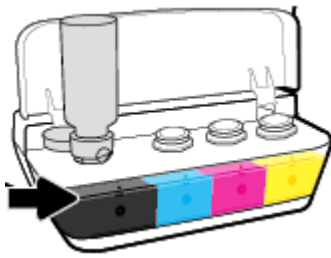

**NOTE:** Some ink will remain in the bottle after filling the tank to the maximum level line. Store the bottle in an upright position in a cool and dry location.



5. Close the ink tank cap securely.

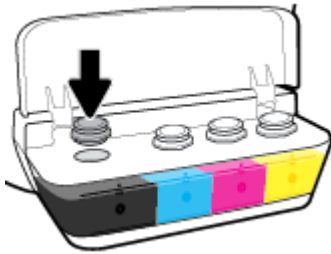

6. Repeat steps 2 to 5 to refill other ink tanks.

7. Close the ink tank lid.

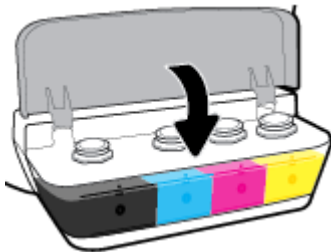

### Precautions for working with ink bottles

Use the following tips to work with ink bottles:

- Keep the ink bottles beyond the reach of children.
- Open the ink bottle only when you plan to fill the ink tanks.

- Do not tilt, shake, or squeeze the ink bottle when it is open to prevent ink leaks.
- Store the ink bottles in a cool, dark place.

## Order ink supplies

Before ordering ink bottles, visually check the labels on the ink bottles to locate the ink bottle numbers.

To order original HP supplies for the printer, go to [www.hp.com/buy/supplies](http://www.hp.com/buy/supplies) . If prompted, choose your country/region, and then follow the prompts to find the right ink bottles for your printer.



**NOTE:** Ordering ink bottles online is not supported in all countries/regions. If it is not available in your country/region, you may still view supplies information and print a list for reference when shopping at a local HP reseller.

---

## Print with black ink only

Before printing with black ink only, make sure the actual ink levels in all tanks are no lower than the minimum ink lines. Printing with any ink level lower than the minimum line may cause damage to your printer.

### To print with black ink only (Windows)

1. From your software, select **Print**.
2. Make sure your printer is selected.
3. Click the button that opens the **Properties** dialog box.

Depending on your software application, this button might be called **Properties**, **Options**, **Printer Setup**, **Printer Properties**, **Printer**, or **Preferences**.

4. Select the appropriate options.

#### Windows 10, Windows 8.1, and Windows 8

- Click **Paper/Quality** tab.
- Under **Print in Grayscale**, select **Black Ink Only** from the list, and then click **OK**.

#### Windows 7, Windows Vista, and Windows XP

- On the **Layout** or **Paper/Quality** tab, click the **Advanced** button to open the **Advanced Options** dialog box.
- From the **Print in Grayscale** drop-down list, select **Black Ink Only**, and then click **OK**.

### To print with black ink only (OS X and macOS)

1. From the **File** menu in your software, choose **Print**.
2. Make sure your printer is selected.
3. Set the print options.

If you do not see options on the Print dialog, click **Show Details**.



---

**NOTE:** Locations for the options can vary from one application to another.

---

4. From the pop-up menu, choose **Paper Type/Quality**.
5. From the Color pop-up menu, choose **Grayscale**, and then click **Print**.

# Tips for working with ink and printhead

## Printhead tips

Use the following tips to work with printheads:

- To protect the printheads from drying out, always turn the printer off using the **Power** button, and wait until the **Power** button light goes out.
- Do not open or untape printheads until you are ready to install them. Leaving tape on the printheads reduces ink evaporation.
- Insert the new printheads into the correct slots. Match the color and icon of each printhead to the color and icon for each slot. Make sure the printheads snap into place, and then close the printhead latch. After new printheads are installed and primed with ink, do not open the printhead latch unless installing new printheads or moving the printer outside your home or office.
- Align the printer for best print quality. See [Printing issues on page 95](#) for more information.
- If you remove a printhead from the printer for any reason, try to replace it again as soon as possible. Outside of the printer, if unprotected, the printhead may begin to dry out.

## Ink tips

Use the following tips to work with ink:

- Make sure the ink tanks are filled with ink and the ink levels are above the minimum line before printing.
- Refill the ink tanks when the ink level reaches the minimum line. Printing with the ink level below the minimum line may cause damage to your printer.
- Do not make the ink level be above the maximum line by overfilling the ink tanks or tilting the printer. The ink level higher than the maximum line can cause ink leaks and ink mixing.

## Move printer

When moving the printer, follow the guidelines provided with the printer to prevent ink leakage.

For more information, refer to the documentation provided in the printer box, or download the latest version of this user guide from [www.hp.com/support](http://www.hp.com/support).



---

# 7 Connect your printer

- [Connect your printer to a wireless network with a router](#)
- [Connect wirelessly to the printer without a router](#)
- [Connect your printer by using the HP Smart app](#)
- [Wireless settings](#)
- [Connect your printer to your computer with a USB cable \(non-network connection\)](#)
- [Change from a USB connection to a wireless network](#)
- [Advanced printer management tools \(for networked printers\)](#)
- [Tips for setting up and using a networked printer](#)

## Connect your printer to a wireless network with a router

 **TIP:** To print a wireless quick start guide, press the **Information** button () for three seconds.

- [Connect your printer to a wireless network using Wi-Fi Protected Setup \(WPS\)](#)
- [Connect your printer to a wireless network using HP printer software](#)

### Connect your printer to a wireless network using Wi-Fi Protected Setup (WPS)

Before connecting your printer to a wireless network using WPS, make sure you have the following:

- A wireless 802.11b/g/n network that includes a WPS-enabled wireless router or access point.

 **NOTE:** The printer only supports connections using 2.4GHz.

- A computer that is already connected to the wireless network that you want to use to connect your printer. Be sure you have installed the HP printer software on the computer.

If you have a WPS router with a WPS push button, follow the **Push Button method**. If you are not certain your router has a push button, follow the **PIN method**.

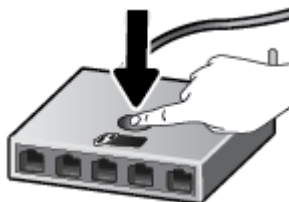

#### To use the Push Button Configuration (PBC) method

1. Press and hold the **Wireless** button () on the printer for more than three seconds to start WPS push mode. The **Wireless** light starts blinking.
2. Press the WPS button on your router.



 **NOTE:** The product begins a timer for approximately two minutes while a wireless connection is established.

#### To use the PIN method

1. Press the **Wireless** button () and **Information** button () at the same time to print the network configuration page, and then locate a WPS PIN.  
The WPS PIN is printed at the top of the printed information page.
2. Press and hold the **Wireless** button () from the printer control panel for more than three seconds.  
The wireless light starts blinking.
3. Open the configuration utility or software for the wireless router or wireless access point, and then enter the WPS PIN.

---

 **NOTE:** For more information about using the configuration utility, see the documentation provided with the router or wireless access point.

---

Wait for about two minutes. If the printer connects successfully, the **Wireless** light stops blinking but remains lit.

## Connect your printer to a wireless network using HP printer software

To connect the printer to an integrated wireless WLAN 802.11 network, make sure you have the following:

- A wireless 802.11b/g/n network that includes a wireless router or access point.

---

 **NOTE:** The printer only supports connections using 2.4GHz.

---

- A computer that is already connected to the wireless network that you want to use to connect your printer.
- Network name (SSID).
- WEP key or WPA Passphrase (if needed).

### To connect your printer using HP printer software (Windows)

1. Depending on whether you have installed the HP printer software or not, do one of the following:

#### If you have not installed the HP printer software on your computer

- a. Insert the printer software CD in your computer.

---

 **NOTE:** During the software installation, a USB cable might be required for temporary connection between the printer and the computer. Do not connect the USB cable until the printer software prompts to do so.

---

- b. When you are prompted, select **Wireless**, and then follow the on-screen instructions.

#### If you have the HP printer software installed on your computer

- a. Open the printer software. For more information, see [Open the HP printer software \(Windows\) on page 26](#).
- b. In the printer software, click **Tools**.
- c. Click **Device Setup & Software**.
- d. Click **Connect a new device**, click **Wireless**, and then follow the onscreen instructions.

2. After the printer connects successfully, the blue **Wireless** light stops blinking and remains on.

### To connect your printer using HP printer software (OS X and macOS)

1. Depending on whether you have installed the HP printer software or not, do one of the following:

#### If you have not installed the HP printer software on your computer

- a. Insert the printer software CD in your computer.
- b. Double-click the HP Installer icon on the software CD, and then follow the onscreen instructions.

### If you have the HP printer software installed on your computer

- a. Double-click HP Utility in the **HP** folder in the **Applications** folder.
  - b. On the menu bar at the top of the screen, choose **Setup New Device** from the Devices menu, and then follow the onscreen instructions.
2. After the printer connects successfully, the blue **Wireless** light stops blinking and remains on.

### To connect a new printer (Windows)

1. Open the printer software. For more information, see [Open the HP printer software \(Windows\) on page 26](#).
2. In the printer software, click **Tools**.
3. Select **Device Setup & Software**.
4. Select **Connect a new device**. Follow the onscreen instructions.

### To connect a new printer (OS X and macOS)

1. Open **System Preferences**.
2. Depending on your operating system, click **Printers & Scanners**.
3. Click + below the list of printers at the left.
4. Select the new printer from the list.

# Connect wirelessly to the printer without a router

With Wi-Fi Direct, you can print wirelessly from a computer, smart phone, tablet, or other wireless-capable device—without connecting to an existing wireless network.

## Guidelines for using Wi-Fi Direct

- Make sure Wi-Fi Direct for your printer is turned on.
- Make sure your computer or mobile device has the necessary software.
  - If you are using a computer, make sure you have installed the printer software provided with the printer.



If you have not installed the HP printer software on the computer, connect your computer to Wi-Fi Direct for your printer first and then install the printer software. Select **Wireless** when prompted by the printer software for a connection type.
  - If you are using a mobile device, make sure you have installed a compatible printing app.
- Up to five computers and mobile devices can use the same Wi-Fi Direct connection.
- Wi-Fi Direct can be used while the printer is also connected either to a computer using a USB cable or to a network using a wireless connection.
- Wi-Fi Direct cannot be used to connect a computer, mobile device, or printer to the Internet.

## To turn Wi-Fi Direct on or off

On the printer control panel, press the **Wi-Fi Direct** button (.

- When Wi-Fi Direct is turned on, the **Wi-Fi Direct** light is on steady. To find the Wi-Fi Direct name and password, press the **Information** button () to print a printer information page.



**NOTE:** When you turn on Wi-Fi Direct the first time, the printer automatically prints a Wi-Fi Direct guide. The guide provides instructions about how to use Wi-Fi Direct. After that, you can press the **Wi-Fi Direct** button () and the **Information** button () together to print the Wi-Fi Direct guide. The guide may not be available in all languages.

- When Wi-Fi Direct is turned off, the **Wi-Fi Direct** light is off.
- For more information about the Wi-Fi Direct light status, see [Control panel lights and display icons status on page 8](#).

## To print from a wireless-capable mobile device that supports Wi-Fi Direct

For Google Android devices, make sure you have installed the latest version of HP Print Service Plugin on your mobile device. You can download this plugin from the Google Play application store.

1. Make sure you have turned on Wi-Fi Direct on the printer.
2. Turn on Wi-Fi Direct on your mobile device. For more information, see the documentation provided with the mobile device.

3. From your mobile device, select a document from a print enabled application, and then select the option to print the document.

The list of available printers appears.

4. From the list of available printers, choose the Wi-Fi Direct name shown such as DIRECT-\*\*-HP Ink Tank Wireless (where \*\* are the unique characters to identify your printer).
  - If the Wi-Fi Direct connection security for the printer is **Automatic** (the default setting), the mobile device will connect to the printer automatically and send the print job.
  - If the Wi-Fi Direct connection security for the printer is set to **Manual**, do one of the following to connect to the printer and print.
    - If the Wi-Fi Direct light on the printer control panel keeps blinking, press the **Wi-Fi Direct** button (). The light will stop blinking and stay on.
    - If the printer prints out a page with a PIN code, follow the instruction on the page.

---

 **TIP:** You can change the Wi-Fi Direct connection security setting for the printer from the embedded web server (EWS). For more information, see [Open the embedded web server on page 78](#).

---

#### To print from a wireless-capable mobile device that does not support Wi-Fi Direct

1. Make sure you have installed a compatible printing app on your mobile device. For more information, visit [www.hp.com/global/us/en/eprint/mobile\\_printing\\_apps.html](http://www.hp.com/global/us/en/eprint/mobile_printing_apps.html).
2. Make sure you have turned on Wi-Fi Direct on the printer.
3. Turn on the wireless (Wi-Fi) connection on your mobile device. For more information, see the documentation provided with the mobile device.
4. From the mobile device, connect to a new network. Use the process you normally use to connect to a new wireless network or hotspot. Choose the Wi-Fi Direct name from the list of wireless networks shown such as DIRECT-\*\*-HP Ink Tank Wireless (where \*\* are the unique characters to identify your printer).
5. Enter the Wi-Fi Direct password of your printer when prompted.
6. Print your document.

#### To print from a wireless-capable computer (Windows)

1. Make sure you have turned on Wi-Fi Direct on the printer.
2. Turn on the computer's Wi-Fi connection. For more information, see the documentation provided with the computer.

---

 **NOTE:** If your computer does not support Wi-Fi, you are not able to use Wi-Fi Direct.

---

3. From the computer, connect to a new network. Use the process you normally use to connect to a new wireless network or hotspot. Choose the Wi-Fi Direct name from the list of wireless networks shown such as DIRECT-\*\*-HP Ink Tank Wireless (where \*\* are the unique characters to identify your printer).

Enter the Wi-Fi Direct password when prompted.

4. Proceed to step 5 if the printer has been installed and connected to the computer over a wireless network. If the printer has been installed and connected to your computer with a USB cable, follow the steps below to install the printer software using the Wi-Fi Direct connection.
  - a. Depending on your operating system, do one of the following:
    - **Windows 10:** From the computer desktop, click **Start**, select **All apps**, click **HP**, and then select the icon with the printer name.
    - **Windows 8.1:** Click the down arrow in lower left corner of the Start screen, and then select the printer name.
    - **Windows 8:** Right-click an empty area on the Start screen, click **All Apps** on the app bar, and then select the printer name.
    - **Windows 7, Windows Vista, and Windows XP:** From the computer desktop, click **Start**, select **All Programs**, click **HP**, click the folder for the printer, and then select the icon with the printer name.
  - b. In the printer software, click **Tools**.
  - c. Click **Device Setup & Software**, and then select **Connect a new device**.
  - d. When the **Connection Options** software screen appears, select **Wireless**.  
Select your HP printer from the list of detected printers.
  - e. Follow the onscreen instructions.
5. Print your document.

#### To print from a wireless-capable computer (OS X and macOS)

1. Make sure you have turned on Wi-Fi Direct on the printer.
2. Turn on Wi-Fi on the computer.  
For more information, see the documentation provided by Apple.
3. Click the Wi-Fi icon and choose the Wi-Fi Direct name, such as DIRECT-\*\*-HP Ink Tank Wireless (where \*\* are the unique characters to identify your printer).  
If Wi-Fi Direct is turned on with security, enter the password when prompted.
4. Add the printer.
  - a. Open **System Preferences** .
  - b. Depending on your operating system, click **Printers & Scanners** .
  - c. Click + below the list of printers at the left.
  - d. Select the printer from the list of detected printers (the word “Bonjour” is listed the right column beside the printer name), and click **Add**.

# Connect your printer by using the HP Smart app

## To set up using the HP Smart app

You can use the HP Smart app to set up the printer on your wireless network. The HP Smart app is supported on iOS, Android, and Windows devices. For information about this app, see [Use the HP Smart app to print, scan, and troubleshoot from an iOS, Android, or Windows 10 device on page 27](#).

1. If you are using an iOS or Android mobile device, make sure that Bluetooth is turned on. (HP Smart uses Bluetooth to make the setup process faster and easier on iOS and Android mobile devices.)



---

**NOTE:** HP Smart uses Bluetooth for printer setup only. Printing using Bluetooth is not supported.

2. Open the HP Smart app.
3. **Windows:** On the home screen, click or tap **Setup a new printer** and follow the onscreen instructions to add a printer to your network.

**iOS/Android:** On the home screen, tap the Plus icon and then tap **Add Printer**. Follow the onscreen instructions to add a printer to your network.



# Wireless settings

You can set up and manage your printer wireless connection and perform a variety of network management tasks. This includes printing information about network settings, turning the wireless function on or off, and changing wireless settings.

## To turn on or off the wireless capability of the printer

Press the **Wireless** button () to turn on or off the printer wireless capabilities.

- If the printer has an active connection to a wireless network, the **Wireless** light is on solid blue, and the printer display shows the **Wireless** icon and the **Signal Bars** icon.
- If wireless is turned off, the **Wireless** light is off.
- For more information about the wireless status, see [Control panel lights and display icons status on page 8](#).

## To print the wireless network test report and network configuration page

Press the **Wireless** button () and the **Information** button () at the same time.

- The wireless network test report shows the diagnostics results for the status of the wireless network, wireless signal strength, detected networks, and more.
- The network configuration page shows the network status, hostname, network name, and more.

## To change wireless settings (Windows)

This method is available if you have already installed the printer software.

 **NOTE:** This method requires a USB cable. Do not connect the USB cable until prompted to do so.

1. Open the HP printer software. For more information, see [Open the HP printer software \(Windows\) on page 26](#).
2. In the printer software, click **Tools**.
3. Click **Device Setup & Software**.
4. Select **Reconfigure Wireless Settings**. Follow the onscreen instructions.

## To restore network settings to default settings

- Press the **Wireless** button () and the **Cancel** button () from the printer control panel at the same time, and then hold them for three seconds.

# Connect your printer to your computer with a USB cable (non-network connection)

The printer supports a rear USB 2.0 High Speed port for connection to a computer.

## To connect the printer with the USB cable

1. Insert the printer software CD in the computer CD-ROM drive.



---

**NOTE:** Do not connect the USB cable to the printer until you are prompted to do so.

---

2. Follow the on-screen instructions. When you are prompted, connect the printer to the computer by selecting **USB** on the **Connection Options** screen.
3. Follow the onscreen instructions.

If the printer software has been installed, the printer will operate as a plug-and-play device. If the software has not been installed, insert the CD that came with the printer and follow the on-screen instructions.

# Change from a USB connection to a wireless network

If you first set up your printer and installed the software with a USB cable, directly connecting the printer to your computer, you can easily change to a wireless network connection. You will need a wireless 802.11b/g/n network that includes a wireless router or access point.

---

 **NOTE:** The printer only supports wireless connections using 2.4GHz.

---

Before changing from a USB connection to a wireless network, make sure that:

- The printer is connected to your computer with the USB cable until you are prompted to disconnect the cable.
- Your computer is already connected to the wireless network that you want to connect the printer.

## Change from a USB connection to a wireless network (Windows)

1. Open the HP printer software. For more information, see [Open the HP printer software \(Windows\) on page 26](#).
2. In the printer software, click **Tools**.
3. Click **Device Setup & Software**.
4. Select **Convert a USB connected device to wireless**. Follow the onscreen instructions.

## To change from a USB connection to a wireless connection (OS X and macOS)

1. Remove the USB cable from the printer.
2. Restore the printer to its network defaults. For more information, see [Wireless settings on page 75](#).
3. Download the most recent version of HP Easy Start from 123.hp.com.
4. Open HP Easy Start and follow the onscreen instructions to connect your printer.

## To change from a USB connection to a wireless network using the HP Smart app on a Windows 10 computer (Windows)

1. Before you proceed, make sure your computer and printer meet the following requirements:
  - Your printer is currently connected to your computer through USB.
  - Your computer is currently connected to a wireless network.
2. Open the HP Smart app. For information about how to open the app on a Windows 10 computer, see [Use the HP Smart app to print, scan, and troubleshoot from an iOS, Android, or Windows 10 device on page 27](#).
3. Make sure your printer is selected.

---

 **TIP:** If you want to select a different printer, click the Printer icon on the toolbar at the left side of the screen, and then select **Select a Different Printer** to view all available printers.

---

4. Click **Learn More** when you see “Make printing easier by connecting your printer wirelessly” on top of the home page of the app.

## Advanced printer management tools (for networked printers)

When the printer is connected to a network, you can use the embedded web server (EWS) to view status information, change settings, and manage the printer from your computer.

 **NOTE:** You can open and use the EWS without being connected to the Internet. However, some features are not available.



 **NOTE:** To view or change some settings, you might need a password.

- [Open the embedded web server](#)
- [About cookies](#)

### Open the embedded web server

You can use one of the following ways to open the embedded web server.

#### To open the embedded web server through a network

1. From the printer control panel, press the **Wireless** button () and the **Information** button () together to print the network configuration page.
2. Find out the IP address or hostname of the printer from the network configuration page.



 **NOTE:** The printer must be on a network and must have an IP address.

3. In a supported web browser on your computer, type the IP address or hostname assigned to the printer.  
For example, if the IP address is 192.168.0.12, type the following address into a Web browser: `http://192.168.0.12`.

#### To open the embedded web server from the HP printer software (Windows)

1. Open the printer software. For more information, see [Open the HP printer software \(Windows\) on page 26](#).
2. Click **Print & Scan**, and then click **Printer Home Page (EWS)**.

#### To open the embedded web server through Wi-Fi Direct

1. If the Wi-Fi Direct light is off, press the **Wi-Fi Direct** button () to turn it on. To find the Wi-Fi Direct name and password, press the **Information** button () to print a printer information page.
2. From your wireless computer, turn wireless on, search for and connect to the Wi-Fi Direct name, for example: DIRECT-\*\*-HP Ink Tank Wireless. Enter the Wi-Fi Direct password when prompted.
3. In a supported web browser on your computer, type the following address: `http://192.168.223.1`.

### About cookies

The embedded Web server (EWS) places very small text files (cookies) on your hard drive when you are browsing. These files let the EWS recognize your computer the next time you visit. For example, if you have configured the EWS language, a cookie helps remember which language you have selected so that the next

time you access the EWS, the pages are displayed in that language. Some cookies (such as the cookie that stores customer-specific preferences) are stored on the computer until you clear them manually.

You can configure your browser to accept all cookies, or you can configure it to alert you every time a cookie is offered, which allows you to decide which cookies to accept or refuse. You can also use your browser to remove unwanted cookies.



**NOTE:** Depending on your printer, if you disable cookies, you also disable one or more of the following features:

---

- Starting where you left the application (especially useful when using setup wizards)
- Remembering the EWS browser language setting
- Personalizing the EWS Home page

For information about how to change your privacy and cookie settings and how to view or delete cookies, see the documentation available with your Web browser.

## Tips for setting up and using a networked printer

Use the following tips to set up and use a networked printer:

- When setting up the wireless networked printer, make sure your wireless router or access point is powered on. The printer searches for wireless routers, then lists the detected network names on the computer.
- If your computer is connected to a Virtual Private Network (VPN), you need to disconnect from the VPN before you can access any other device on your network, including the printer.
- Learn more about configuring your network and the printer for wireless printing. [Click here to go online for more information.](#)
- Learn how to find your network security settings. [Click here to go online for more information.](#)
- Learn about the HP Print and Scan Doctor. [Click here to go online for more information.](#)



**NOTE:** This utility is only available for Windows operation system.

---

- Learn how to change from a USB to wireless connection. [Click here to go online for more information.](#)
- Learn how to work with your firewall and antivirus programs during printer setup. [Click here to go online for more information.](#)

---

# 8 Solve a problem

This section contains the following topics:

- [Jams and paper-feed issues](#)
- [Printhead issues](#)
- [Printing issues](#)
- [Copy issues](#)
- [Scan issues](#)
- [Network and connection issues](#)
- [Get help from the HP Smart app](#)
- [Printer hardware issues](#)
- [Control panel error codes](#)
- [HP support](#)

# Jams and paper-feed issues

What do you want to do?

## Clear a paper jam

[Solve paper jam issues.](#)

Use an HP online troubleshooting wizard

Get step-by-step instructions for clearing paper jams and resolving issues with paper or the paper feed.



**NOTE:** The HP online troubleshooting wizards may not be available in all languages.

## Read general instructions in the Help for clearing paper jams

Paper jams can occur in several locations.

### To clear a paper jam from the input tray

1. Press the **Cancel** button (✘) to try to clear the jam automatically. If this does not work, complete the following steps to clear the jam manually.
2. Pull the paper gently out of the input tray.



3. Make sure there is no foreign object in the paper path, and then reload paper.



**NOTE:** The input tray shield can prevent foreign debris from falling into the paper path and causing serious paper jams. Do not take down the input tray shield.

4. Press the **Resume** button (⏪) on the control panel to continue the current job.

### To clear a paper jam from the output tray

1. Press the **Cancel** button (✘) to try to clear the jam automatically. If this does not work, complete the following steps to clear the jam manually.





2. Pull the paper gently out of the output tray.



3. Press the **Resume** button (  ) on the control panel to continue the current job.

### To clear a paper jam from the printhead access area

1. Press the **Cancel** button (  ) to try to clear the jam automatically. If this does not work, complete the following steps to clear the jam manually.
2. Remove the jammed paper.
  - a. Press the **Power** button (  ) to turn off the printer.
  - b. Close the output tray extender, and then rotate the output tray clockwise to stow it in the printer.



- c. Open the front door of the printer.

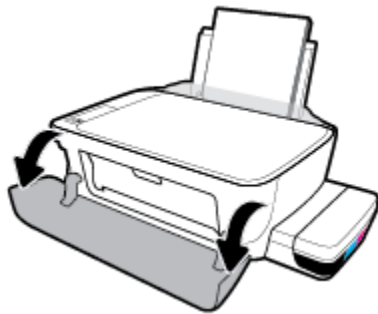

- d. Open the printhead access door.

- e. Make sure the printhead latch is properly closed and the print carriage is not obstructed. If the print carriage is in the center of the printer, slide it to the right.

**CAUTION:** Do not open the printhead latch unless you are installing new printheads or moving the printer outside your home or office.

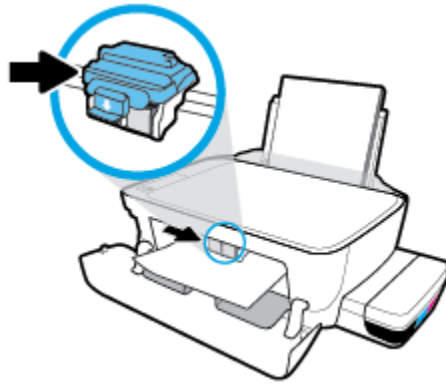

- f. Remove the jammed paper.

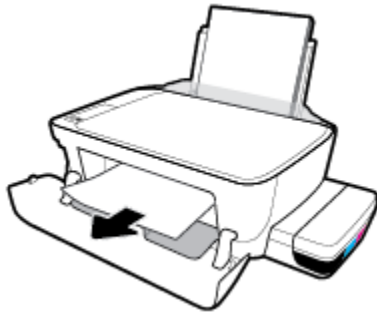

- g. Close the printhead access door, and then close the front door.

- h. Pull out the output tray and the tray extender.



- 3. Press the **Power** button (⏻) to turn on the printer.

## To clear a paper jam inside of the printer

 **NOTE:** To prevent ink from leaking, make sure the ink tank caps are firmly closed.

1. Press the **Cancel** button (✘) to try to clear the jam automatically. If this does not work, complete the following steps to clear the jam manually.
2. Press the **Power** button (⏻) to turn off the printer.
3. Gently turn the printer to the side, locate the cleanout door on the bottom of the printer, and then pull both tabs on the cleanout door to open it.

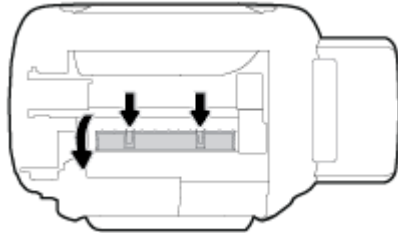

4. Remove the jammed paper.

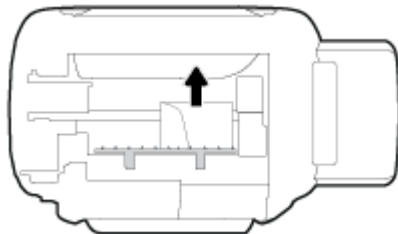

5. Close the cleanout door. Gently push the door towards the printer until both latches snap into place.

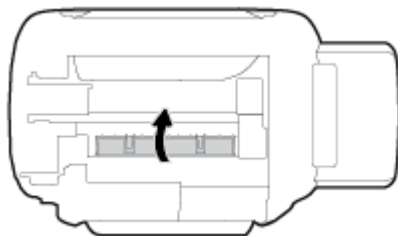

6. Turn the printer upright, and then press the **Power** button (⏻) to turn on the printer.

## Clear a print carriage jam

[Resolve a print carriage jam.](#)

Use an HP online troubleshooting wizard

If something is blocking the print carriage or it does not move easily, get step-by-step instructions.

 **NOTE:** The HP online troubleshooting wizards may not be available in all languages.

## Read general instructions in the Help for clearing a print carriage jam

Remove any objects, such as paper, that are blocking the print carriage. For more information, see "To clear a paper jam from the printhead access area" from "[Clear a paper jam on page 82](#)".



**NOTE:** Do not use any tools or other devices to remove jammed paper. Always use caution when removing jammed paper from inside the printer.

---

## Learn how to avoid paper jams

To help avoid paper jams, follow these guidelines.

- Do not overfill the input tray, but make sure that you have at least 5 pages loaded, for best results.
- Keep your printer free of dust and debris by removing paper and closing the input tray when not in use.
- Remove printed papers from the output tray frequently.
- Ensure that paper loaded in the input tray lays flat, and the edges are not bent or torn.
- Do not combine different paper types and paper sizes in the input tray; the entire stack of paper in the input tray must be the same size and type.

Use HP paper for optimum performance. See [Paper basics on page 24](#) for more information about HP paper.

- Adjust the paper-width guide in the input tray to fit snugly against all paper. Make sure the paper-width guide does not bend the paper in the input tray.
- Do not force paper too far down in the input tray.
- Do not add paper while the printer is printing. If the printer is about to run out of paper, wait until the out of paper message appears before adding paper.





## Solve paper-feed problems

What kind of problem are you having?

- **Paper is not picked up from the input tray**
  - Make sure paper is loaded in the input tray. For more information, see [Load media on page 18](#).
  - Adjust the paper-width guide in the input tray to fit snugly against all paper. Make sure the paper-width guide does not bend the paper in the input tray.
  - Make sure paper in the input tray is not curled. Uncurl paper by bending it in the opposite direction of the curl.
  - Clean the paper rollers.
- **Pages are skewing**
  - Make sure the paper is loaded in the far-right side of the input tray and the paper-width guide is fit against the left side of the paper.
  - Load paper into the printer only when it is not printing.
- **Multiple pages are being picked up**

- Adjust the paper-width guide in the input tray to fit snugly against all paper. Make sure the paper-width guide does not bend the paper in the input tray.
- Make sure the input tray is not overloaded with paper.
- Make sure the pieces of the loaded paper are not sticking together.
- Use HP paper for optimum performance and efficiency.
- Clean the paper rollers.

### To clean the paper rollers using an automated tool

1. Press the **Power** button () to turn on the printer.
2. Remove paper from the input tray.
3. Press and hold the **Power** button () , press the **Cancel** button () three times, press the **Color Copy** button () seven times, and then release the **Power** button () .

The printer makes some noise for approximately one minute. Wait until the printer stops making noises before you proceed.

4. Try to print. If the problem persists, proceed to clean the paper rollers manually.

### To clean the paper rollers manually

1. Gather the following materials:
  - A long, lint-free cotton swab
  - Distilled, filtered, or bottled water (tap water might damage the printer)
2. Press the **Power** button () to turn off the printer.
3. Disconnect the power cord from the rear of the printer.
4. Disconnect the USB cable, if it is not already disconnected.
5. Raise the input tray.
6. Lift and hold the input tray shield.

---

 **NOTE:** Do not remove the input tray shield. The input tray shield prevents foreign debris from falling into the paper path and causing paper jams.

---

7. Look down through the open input tray and find the gray paper pick rollers. You might need a flashlight to illuminate the area.
8. Dampen a long cotton swab with bottled or distilled water, and then squeeze any excess water from the cloth.
9. Press the swab against the rollers, and then rotate them upward with your fingers. Apply a moderate amount of pressure to remove dust or dirt buildup.
10. Lower the input tray shield.

11. Allow the rollers to dry for 10 or 15 minutes.
12. Reconnect the power cord to the rear of the printer.
13. Reconnect the USB cable to the printer if necessary.
14. Press the Power button to turn on the printer.

# Printhead issues

## Identify whether a printhead has a problem

To identify whether printhead has a problem, check the status of the **Printhead Alert** light and the corresponding **Printhead** icon. For more information, see [Control panel lights and display icons status on page 8](#).



## Fix printhead problems

**CAUTION:** The instructions in this section are only applicable when you install printheads during initial printer setup. If printheads have been primed with ink, do not open the printhead latch unless you are installing new printheads or moving the printer outside your home or office.

If an error occurs after a printhead is installed, or if a message indicates a printhead problem, try removing the printhead, verifying the protective piece of plastic tape and plug have been removed from each printhead and then reinserting the printhead. If this does not work, clean the printhead contacts. If the problem is still not resolved, contact HP Support for assistance.

### To verify the printhead installed properly

1. Make sure the printer is turned on.
2. Close the output tray extender, and then rotate the output tray clockwise to stow it in the printer.



3. Remove and reinsert the printhead.
  - a. Open the front door of the printer.

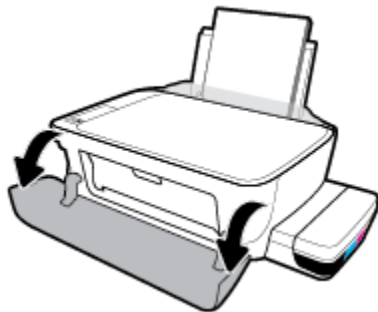

- b. Open the printhead access door. Press and hold the **Black Copy** button for about three seconds, until the print carriage starts moving.

**CAUTION:** The instructions in this section are only applicable when you install printheads during initial printer setup. If printheads have been primed with ink, do not open the printhead latch unless you are installing new printheads or moving the printer outside your home or office.

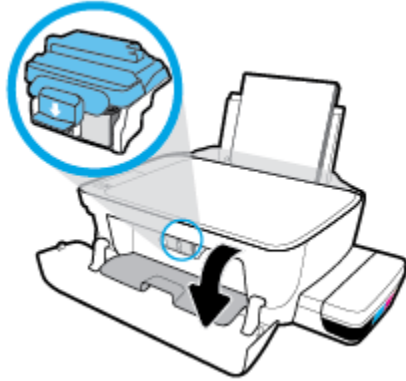

- c. Push down to open the printhead latch.

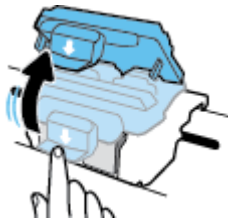

- d. Remove the printhead from the carriage.

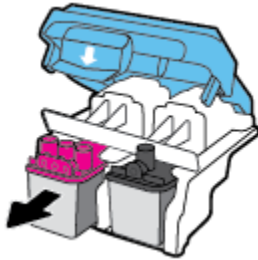

- e. Check if there is a plug on top of the printhead or plastic tape on the printhead contacts. If there is, remove the plug from top of the printhead and the plastic tape from contacts.

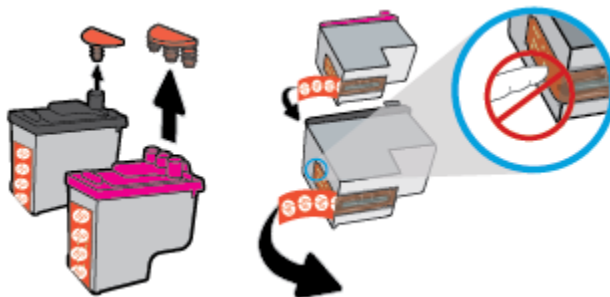

**NOTE:** Do not touch the electrical contacts on the printhead.



- f. Slide the printhead into the slot until it clicks into place.

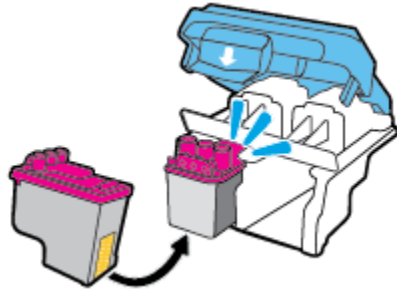

- g. Firmly close the printhead latch. Make sure the printhead latch is properly closed to avoid problems such as carriage jams.

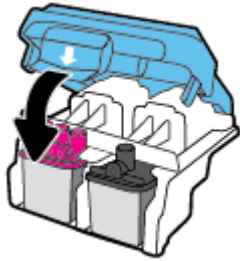

- h. Close the printhead access door.

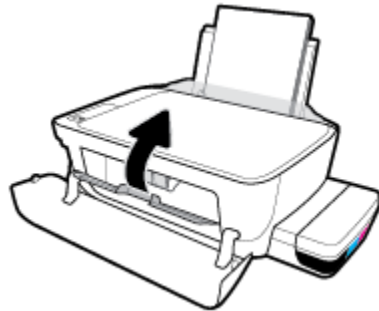

- i. Close the front door of the printer.

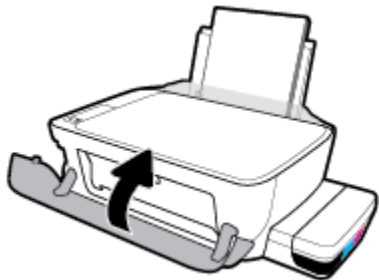

4. Pull out the output tray and the tray extender.



### To clean printhead contacts

**⚠ CAUTION:**

- Open the printhead latch and clean printhead contacts only when necessary; for example, if a printhead cannot be detected.

The instructions here are only applicable in this section. If printheads have been primed with ink, do not open the printhead latch unless installing new printheads or moving the printer outside your home or office.

- The cleaning procedure should take only a few minutes. Make sure that the printheads are reinstalled in the printer as soon as possible. It is not recommended to leave the printheads outside of the printer longer than 30 minutes. This could result in damage to the printhead.

1. Check that power is on.
2. Close the output tray extender, and then rotate the output tray clockwise to stow it in the printer.



3. Open the front door of the printer.

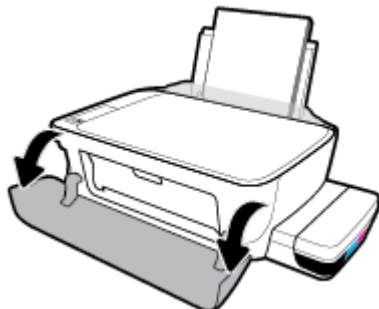

4. Open the printhead access door. Press and hold the **Black Copy** button for about three seconds, until the print carriage starts moving.

**CAUTION:** The instructions here are only applicable in this section. If printheads have been primed with ink, do not open the printhead latch unless installing new printheads or moving the printer outside your home or office.

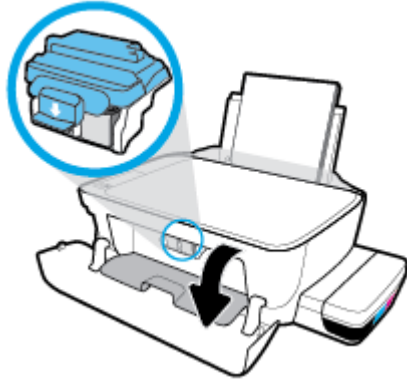

5. Push down to open the printhead latch.

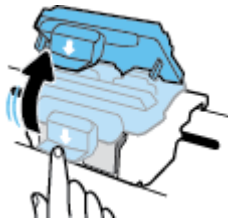

6. Remove the printhead indicated in the error message.

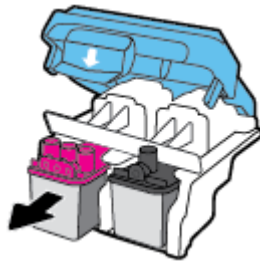

7. Clean the printhead contacts and printer contacts.

- a. Hold the printhead by its sides with the bottom pointing up and locate the electrical contacts on the printhead.

The electrical contacts are the small gold-colored dots on the printhead.

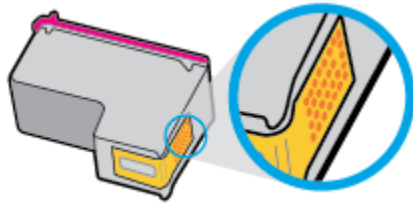

- b. Wipe only the contacts with a dry swab or lint-free cloth.

---

**⚠ CAUTION:** Be careful to wipe only the contacts, and do not smear any of the ink or other debris elsewhere on the printhead.

---

- c. On the inside of the printer, locate the contacts for the printhead.

The printer contacts are the set of gold-colored bumps positioned to meet the contacts on the printhead.

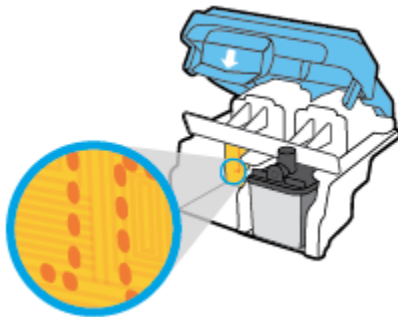

- d. Use a dry swab or lint-free cloth to wipe the contacts.

- 8. Reinstall the printhead.

- 9. Firmly close the printhead latch. Make sure the printhead latch is properly closed to avoid problems such as carriage jams.

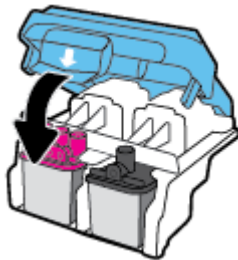

- 10. Close the printhead access door, and then close the front door.

- 11. Check if the error message has gone away. If you still receive the error message, turn the printer off, and then on.

# Printing issues

What do you want to do?

## Fix problems with page not printing (unable to print)

<a href="#">HP Print and Scan Doctor</a>	The HP Print and Scan Doctor is a utility that will try to diagnose and fix the issue automatically. <b>NOTE:</b> This utility is only available for Windows operation system.
<a href="#">Troubleshoot problems with print jobs not printing.</a>	Use an HP online troubleshooting wizard Get step-by-step instructions if the printer is not responding or printing.



**NOTE:** The HP Print and Scan Doctor and the HP online troubleshooting wizards may not be available in all languages.

## Read general instructions in the Help for unable to print issues

### To resolve print issues (Windows)

Make sure that the printer is turned on and that there is paper in the input tray. If you are still unable to print, try the following in order:

1. Check for error messages from the printer software and resolve them by following the on-screen instructions.
2. If your computer is connected to the printer with a USB cable, disconnect and reconnect the USB cable. If your computer is connected to the printer with a wireless connection, confirm that the connection is working.
3. Verify that the printer is not paused or offline.

### To verify that the printer is not paused or offline

- a. Depending upon your operating system, do one of the following:
  - **Windows 10:** From the Windows **Start** menu, click **All apps**, select **Windows System, Control Panel**, and then click **View devices and printers** under **Hardware and Sound** menu.
  - **Windows 8.1 and Windows 8:** Point to or tap the upper-right corner of the screen to open the Charms bar, click the **Settings** icon, click or tap **Control Panel**, and then click or tap **View devices and printers**.
  - **Windows 7:** From the Windows **Start** menu, click **Devices and Printers**.
  - **Windows Vista:** From the Windows **Start** menu, click **Control Panel**, and then click **Printers**.
  - **Windows XP:** From the Windows **Start** menu, click **Control Panel**, and then click **Printers and Faxes**.
- b. Either double-click or right-click the icon for your printer and select **See what's printing** to open the print queue.

- c. On the **Printer** menu, make sure there are no check marks next to **Pause Printing** or **Use Printer Offline**.
  - d. If you made any changes, try to print again.
4. Verify that the printer is set as the default printer.

#### To verify that the printer is set as the default printer

- a. Depending upon your operating system, do one of the following:
    - **Windows 10:** From the Windows **Start** menu, click **All apps**, select **Windows System, Control Panel**, and then click **View devices and printers** under **Hardware and Sound** menu.
    - **Windows 8.1 and Windows 8:** Point to or tap the upper-right corner of the screen to open the Charms bar, click the **Settings** icon, click or tap **Control Panel**, and then click or tap **View devices and printers**.
    - **Windows 7:** From the Windows **Start** menu, click **Devices and Printers**.
    - **Windows Vista:** From the Windows **Start** menu, click **Control Panel**, and then click **Printers**.
    - **Windows XP:** From the Windows **Start** menu, click **Control Panel**, and then click **Printers and Faxes**.
  - b. Make sure the correct printer is set as the default printer.

The default printer has a check mark in a black or green circle next to it.
  - c. If the wrong printer is set as the default printer, right-click the correct printer and select **Set as Default Printer**.
  - d. Try using your printer again.
5. Restart the print spooler.

#### To restart the print spooler

- a. Depending upon your operating system, do one of the following:

##### Windows 10

- i. From the Windows **Start** menu, click **All apps**, and then click **Windows System**.
- ii. Click **Control Panel, System and Security**, and then click **Administrative Tools**.
- iii. Double-click **Services**.
- iv. Right-click the **Print Spooler**, and then click **Properties**.
- v. On the **General** tab, next to **Startup type**, make sure that **Automatic** is selected.
- vi. If the service is not already running, under **Service status**, click **Start**, and then click **OK**.

##### Windows 8.1 and Windows 8

- i. Point to or tap the upper-right corner of the screen to open the Charms bar, and then click the **Settings** icon.
- ii. Click or tap **Control Panel**, and then click or tap **System and Security**.

- iii. Click or tap **Administrative Tools**, and then double-click or double-tap **Services**.
- iv. Right-click or touch and hold **Print Spooler**, and then click **Properties**.
- v. On the **General** tab, next to **Startup type**, make sure that **Automatic** is selected.
- vi. If the service is not already running, under **Service status**, click or tap **Start**, and then click or tap **OK**.

#### Windows 7

- i. From the Windows **Start** menu, click **Control Panel, System and Security**, and then **Administrative Tools**.
- ii. Double-click **Services**.
- iii. Right-click the **Print Spooler**, and then click **Properties**.
- iv. On the **General** tab, next to **Startup type**, make sure that **Automatic** is selected.
- v. If the service is not already running, under **Service status**, click **Start**, and then click **OK**.

#### Windows Vista

- i. From the Windows **Start** menu, click **Control Panel, System and Maintenance, Administrative Tools**.
- ii. Double-click **Services**.
- iii. Right-click the **Print Spooler service**, and then click **Properties**.
- iv. On the **General** tab, next to **Startup type**, make sure that **Automatic** is selected.
- v. If the service is not already running, under **Service status**, click **Start**, and then click **OK**.

#### Windows XP

- i. From the Windows **Start** menu, right click **My Computer**.
  - ii. Click **Manage**, and then click **Services and Applications**.
  - iii. Double-click **Services**, and then select **Print Spooler**.
  - iv. Right-click **Print Spooler**, and click **Restart** to restart the service.
- b.** Make sure the correct printer is set as the default printer.
- The default printer has a check mark in a black or green circle next to it.
- c.** If the wrong printer is set as the default printer, right-click the correct printer and select **Set as Default Printer**.
  - d.** Try using your printer again.
- 6.** Restart the computer.
- 7.** Clear the print queue.

#### To clear the print queue

- a.** Depending upon your operating system, do one of the following:

- **Windows 10:** From the Windows **Start** menu, click **All apps**, select **Windows System, Control Panel**, and then click **View devices and printers** under **Hardware and Sound** menu.
  - **Windows 8.1 and Windows 8:** Point to or tap the upper-right corner of the screen to open the Charms bar, click the **Settings** icon, click or tap **Control Panel**, and then click or tap **View devices and printers**.
  - **Windows 7:** From the Windows **Start** menu, click **Devices and Printers**.
  - **Windows Vista:** From the Windows **Start** menu, click **Control Panel**, and then click **Printers**.
  - **Windows XP:** From the Windows **Start** menu, click **Control Panel**, and then click **Printers and Faxes**.
- b. Double-click the icon for your printer to open the print queue.
  - c. On the **Printer** menu, click **Cancel all documents** or **Purge Print Document**, and then click **Yes** to confirm.
  - d. If there are still documents in the queue, restart the computer and try printing again after the computer has restarted.
  - e. Check the print queue again to make sure it is clear, and then try to print again.

### To resolve print issues (OS X and macOS)

1. Check for error messages and resolve.
2. Disconnect and reconnect the USB cable.
3. Verify that the product is not paused or offline.

#### To verify that the product is not paused or offline

- a. In **System Preferences**, click **Printers & Scanners**.
- b. Click the **Open Print Queue** button.
- c. Click a print job to select it.

Use the following buttons to manage the print job:

- **Delete:** Cancel the selected print job.
  - **Hold:** Pause the selected print job.
  - **Resume:** Continue a paused print job.
  - **Pause Printer:** Pause all print jobs in the print queue.
- d. If you made any changes, try to print again.
4. Restart the computer.

## Fix print quality issues

---

[Step-by-step instructions for resolving most print quality issues.](#)

Troubleshoot print quality issues online

---



## Read general instructions in the Help for resolving print quality issues



**NOTE:** To protect the printheads from drying out, always turn the printer off using the **Power** button, and wait until the **Power** button light goes out.

---

### To improve print quality

1. Make sure you are using original HP printheads and ink.
  - Make sure all ink tanks are filled above the minimum line.
  - Consider refilling the ink tanks if the ink is reaching the minimum line.
2. Check the paper type.
  - For best print quality, use high quality HP paper, or papers that adhere to the ColorLok® standard. For more information, see [Paper basics on page 24](#).
  - Always make sure the paper you are printing on is flat. For best results when printing images, use HP Advanced Photo Paper.
  - Store specialty paper in its original packaging inside a resealable plastic bag on a flat surface in a cool, dry place. When you are ready to print, remove only the paper you plan to use immediately. When you have finished printing, return any unused photo paper to the plastic bag. This prevents the photo paper from curling.
3. Check the printer software to see that the print settings are appropriate for the paper type you are using. For more information about print settings, see [Printer settings tips on page 40](#).
4. Press and hold the **Color Copy** button () on the control panel for three seconds to print a diagnostics page.

- Review the Cyan, Magenta, Yellow, and Black Boxes along with other content on the diagnostics page.

### Print Quality Diagnostics

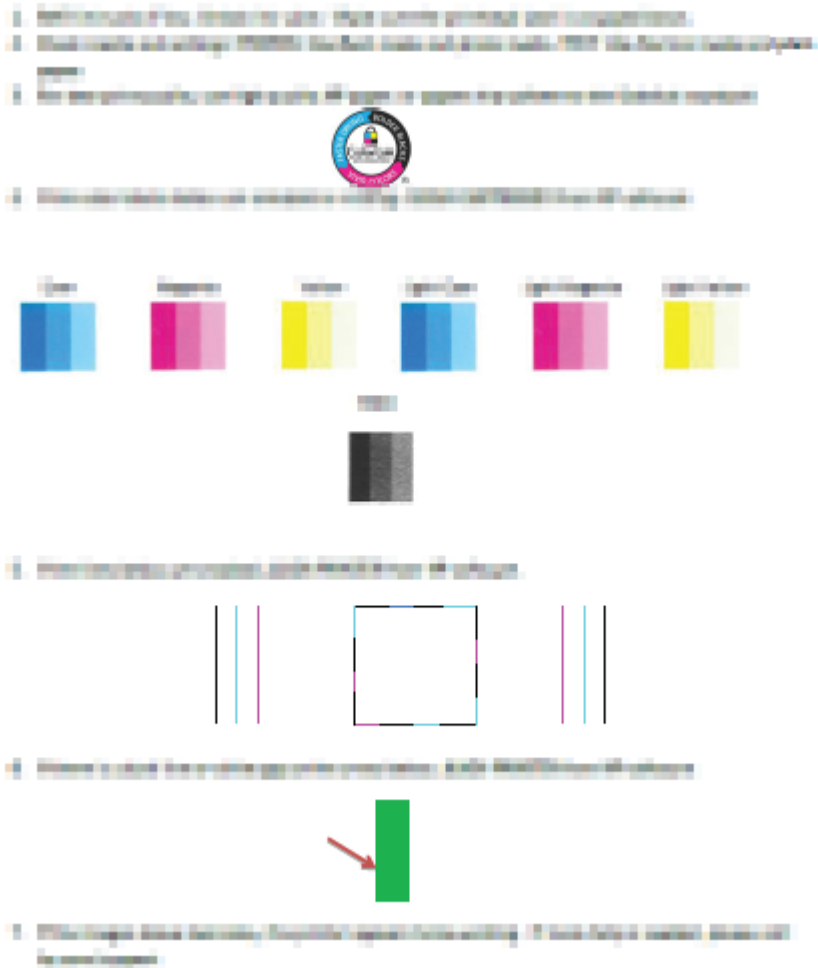

- Clean the printheads (cartridges), if the diagnostic page shows steaks or missing portions of the color and black boxes.
- Align the printheads (cartridges) if straight lines appear jagged on printouts, or if the diagnostic page indicates aligning printheads might help.
- If print quality problems persist after cleaning and aligning printheads (cartridges), contact HP support.

#### To clean the printheads (cartridges) (Windows)

**CAUTION:** Clean the printheads (cartridges) only when necessary. Unnecessary cleaning wastes ink and shortens the life of the printheads (cartridges).

- Load letter or A4 unused plain white paper into the input tray.
- Open the printer software. For more information, see [Open the HP printer software \(Windows\) on page 26](#).

3. In the printer software, click **Print & Scan** and then click **Maintain Your Printer** to access the **Printer Toolbox**.
4. Click **Clean Cartridges** on the **Device Services** tab. Follow the onscreen instructions.

#### To align the printheads (cartridges) (Windows)

1. Load letter or A4 unused plain white paper into the input tray.
2. Open the printer software. For more information, see [Open the HP printer software \(Windows\) on page 26](#).
3. In the printer software, click **Print & Scan** and then click **Maintain Your Printer** to access the printer toolbox.

The printer toolbox appears.

4. Click **Align Cartridges** on the **Device Services** tab.

The printer prints an alignment page.

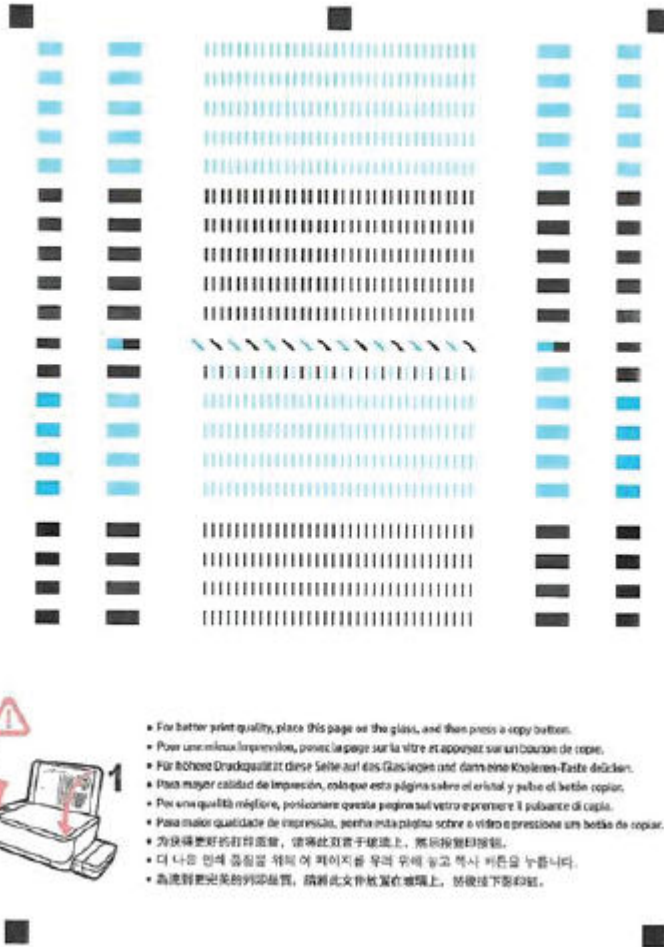

5. Follow the onscreen instructions to load the printhead alignment page print side down on the scanner glass, and then click **Scan** to scan the alignment page.

The printer aligns the printheads. Recycle or discard the printhead alignment sheet.

### To clean the printheads (cartridges) (OS X and macOS)

**CAUTION:** Clean the printheads only when necessary. Unnecessary cleaning wastes ink and shortens the life of the printheads.

1. Load Letter or A4 plain, white paper in the input tray.
2. Open HP Utility.

**NOTE:** HP Utility is located in the **HP** folder in the **Applications** folder.

3. Select your printer from the list of devices at the left of the window.

4. Click **Clean Printheads**.
5. Click **Clean**, and follow the onscreen instructions.

---

 **CAUTION:** Clean the printhead only when necessary. Unnecessary cleaning wastes ink and shortens the life of the print head.

 **NOTE:** If print quality still seems poor after you complete cleaning, try aligning the printhead. If print quality problems persist after cleaning and aligning, contact HP support.

---

6. Click **All Settings** to return to the **Information and Support** pane.

### To align the printheads (cartridges) (OS X and macOS)

1. Load Letter or A4 plain, white paper in the input tray.
2. Open HP Utility.

---

 **NOTE:** HP Utility is located in the **HP** folder in the **Applications** folder.

---

3. Select your printer from the list of devices at the left of the window.
4. Click **Align**.
5. Click **Align** and follow the onscreen instructions.
6. Click **All Settings** to return to the **Information and Support** pane.

## Copy issues

---

[Troubleshoot copy problems.](#)

Use an HP online troubleshooting wizard

Get step-by-step instructions if the printer does not create a copy, or if your printouts are low quality.

---



**NOTE:** The HP online troubleshooting wizards may not be available in all languages.

---

[Tips for copy and scan success on page 57](#)

## Scan issues

<a href="#">HP Print and Scan Doctor</a>	The HP Print and Scan Doctor is a utility that will try to diagnose and fix the issue automatically. <b>NOTE:</b> This utility is only available for Windows operation system.
<a href="#">Solve scan problems</a>	Use an HP online troubleshooting wizard  Get step-by-step instructions if you cannot scan or if your scans are low quality.



**NOTE:** The HP Print and Scan Doctor and the HP online troubleshooting wizards may not be available in all languages.

[Tips for copy and scan success on page 57](#)

# Network and connection issues

What do you want to do?

## Fix wireless connection



Choose one of the following troubleshooting options.

<a href="#">HP Print and Scan Doctor</a>	The HP Print and Scan Doctor is a utility that will try to diagnose and fix the issue automatically. <b>NOTE:</b> This utility is only available for Windows operation system.
Use an HP online troubleshooting wizard	<ul style="list-style-type: none"><li>• <a href="#">Troubleshoot your wireless problem</a>, whether your printer has never been connected or it was connected and is no longer working.</li><li>• <a href="#">Troubleshoot a firewall or antivirus issue</a>, if you suspect that it is preventing your computer from connecting to the printer.</li></ul>



**NOTE:** The HP Print and Scan Doctor and the HP online troubleshooting wizards may not be available in all languages.

## Read general instructions in the Help for wireless troubleshooting

- ▲ Press the **Wireless** button () and the **Information** button () at the same time to print the wireless network test report and network configuration page.

## Find network settings for wireless connection

Choose one of the following troubleshooting options.

<a href="#">HP Print and Scan Doctor</a>	The HP Print and Scan Doctor is a utility that can tell you the network name (SSID) and password (network key). <b>NOTE:</b> This utility is only available for Windows operation system.
<a href="#">Use an HP online troubleshooting wizard</a>	Learn how to find your network name (SSID) and wireless password.



**NOTE:** The HP Print and Scan Doctor and the HP online troubleshooting wizards may not be available in all languages.

## Fix Wi-Fi Direct connection

<a href="#">Use an HP online troubleshooting wizard</a>	Troubleshoot your Wi-Fi Direct problem or learn how to configure Wi-Fi Direct.
---	--



**NOTE:** The HP online troubleshooting wizards may not be available in all languages.



## Read general instructions in the Help for Wi-Fi Direct troubleshooting

1. Make sure that the **Wi-Fi Direct** light on the printer control panel is on. If the light is off, press the **Wi-Fi Direct** button () to turn it on.
2. From your wireless computer or mobile device, turn on the wireless (Wi-Fi) connection, and then search for and connect to the Wi-Fi Direct name of your printer.
3. Enter the Wi-Fi Direct password when prompted.
4. If you are using a mobile device, make sure you have installed a compatible printing app. For more information about mobile printing, visit [www.hp.com/global/us/en/eprint/mobile\\_printing\\_apps.html](http://www.hp.com/global/us/en/eprint/mobile_printing_apps.html).

## Convert USB connection to wireless

Choose one of the following troubleshooting options.

<a href="#">HP Print and Scan Doctor</a>	The HP Print and Scan Doctor is a utility that will try to diagnose and fix the issue automatically. <b>NOTE:</b> This utility is only available for Windows operation system.
<a href="#">Use an HP online troubleshooting wizard</a>	Convert a USB connection to wireless or Wi-Fi Direct.

 **NOTE:** The HP Print and Scan Doctor and the HP online troubleshooting wizards may not be available in all languages.

[Change from a USB connection to a wireless network on page 77](#)

## Get help from the HP Smart app

The HP Smart app provides alerts for printer issues (jams and other problems), links to help content, and options to contact support for additional assistance.

# Printer hardware issues

## Close printhead access door

- Printhead door must be closed to begin printing.

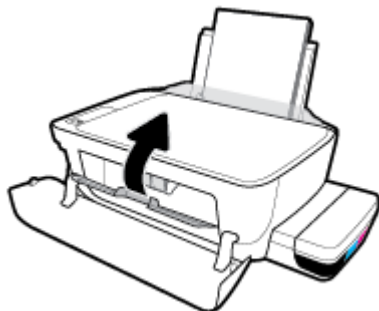

## The printer shuts down unexpectedly

- Check the power and power connections.
- Make sure the printer's power cord is connected firmly to a functioning power outlet.



**NOTE:** When Auto-Off is enabled, the printer will automatically turn off after 2 hours of inactivity to help reduce energy use. For more information, see [Auto-Off on page 30](#).

## Resolve printer failure

- Turn the printer off, then on. If that does not resolve the problem, contact HP.

## Control panel error codes

If the **Number of copies** icon on the printer display is alternating between the letter E and a number, it indicates the printer is in an error state. The letter E and the number work as error codes. For example, if the **Number of copies** icon is alternating between the letter E and the number 4, it indicates that a paper jam has occurred.

To identify the error code and its corresponding solutions, see the information about the **Number of copies** icons in [Control panel lights and display icons status on page 8](#).

# HP support

For the latest product updates and support information, visit [the printer support website at www.support.hp.com](http://www.support.hp.com). HP online support provides a variety of options for help with your printer:



**Drivers & downloads:** Download software drivers and updates, as well as product manuals and documentation that came in the box with your printer.



**HP support forums:** Visit HP Support Forums for answers to common questions and issues. You can view questions posted by other HP customers, or sign in and post your own questions and comments.



**Troubleshooting:** Use HP online tools to detect your printer and find recommended solutions.



**NOTE:** You can also use the HP Smart app to check printer errors and get troubleshooting assistance. For information about this app, see [Use the HP Smart app to print, scan, and troubleshoot from an iOS, Android, or Windows 10 device on page 27](#).

## Contact HP

If you need help from an HP technical support representative to solve a problem, visit the [Contact Support website](#). The following contact options are available at no cost for in-warranty customers (HP agent-assisted support for out-of warranty customers may require a fee):



Chat with an HP support agent online.



Call an HP support agent.

When contacting HP support, be prepared to provide the following information:

- Product name (Located on the printer, such as HP Ink Tank Wireless 410)
- Product number (located inside the front door)



- Serial number (located on the back or bottom of the printer)

## Register printer

By taking just a few quick minutes to register, you can enjoy quicker service, more efficient support, and product support alerts. If you did not register your printer while installing the software, you can register now at <http://www.register.hp.com>.

## Additional warranty options

Extended service plans are available for the printer at additional costs. Go to [www.hp.com/support](http://www.hp.com/support), select your country/region and language, then explore the extended warranty options available for your printer.

---

# A Technical information

This section provides technical specifications and regulatory information for the printer. The information here is subject to change without notice.

This section contains the following topics:

- [HP Company notices](#)
- [Specifications](#)
- [Regulatory notices](#)
- [Environmental product stewardship program](#)

## HP Company notices

The information contained herein is subject to change without notice.

All rights reserved. Reproduction, adaptation, or translation of this material is prohibited without prior written permission of HP, except as allowed under the copyright laws. The only warranties for HP products and services are set forth in the express warranty statements accompanying such products and services. Nothing herein should be construed as constituting an additional warranty. HP shall not be liable for technical or editorial errors or omissions contained herein.

© Copyright 2017 HP Development Company, L.P.

Microsoft and Windows are either registered trademarks or trademarks of Microsoft Corporation in the United States and/or other countries.



# Specifications

For more product specifications, see the Product Data Sheet at [www.hp.com/support](http://www.hp.com/support) .

## System requirements

- Software and system requirements can be found in the Readme file, which is available on the HP printer software CD provided with your printer.
- For information about future operating system releases and support, visit the HP online support website at [www.hp.com/support](http://www.hp.com/support) .

## Environmental specifications

- Recommended operating temperature range: 15°C to 30°C (59°F to 86°F)
- Allowable operating temperature range: 5°C to 40°C (41°F to 104°F)
- Humidity: 15% to 80% RH non-condensing; 28°C maximum dewpoint
- Nonoperating (Storage) temperature range: -40°C to 60°C (-40°F to 140°F)
- In the presence of high electromagnetic fields, it is possible the output from the printer may be slightly distorted
- HP recommends using a USB cable less than or equal to 3 m (10 feet) in length to minimize injected noise due to potential high electromagnetic fields

## Input tray capacity

- Plain paper sheets (80 g/m<sup>2</sup> [20lb]): Up to 60
- Envelopes: Up to 5
- Index cards: Up to 20
- Photo paper sheets: Up to 20

## Output tray capacity

- Plain paper sheets (80 g/m<sup>2</sup> [20lb]): Up to 25
- Envelopes: Up to 5
- Index cards: Up to 10
- Photo paper sheets: Up to 10

## Paper size

- For a complete list of supported media sizes, see the printer software.

## Paper weights

- Plain Paper: 64 to 90 g/m<sup>2</sup> (16 to 24 lb)
- Envelopes: 75 to 90 g/m<sup>2</sup> (20 to 24 lb)

- Cards: Up to 200 g/m<sup>2</sup> (110-lb index maximum)
- Photo Paper: Up to 280 g/m<sup>2</sup> (75 lb)

### Print specifications

- Print speeds vary according to the complexity of the document
- Method: drop-on-demand thermal inkjet
- Language: PCL3 GUI

### Copy specifications

- Resolution: up to 600 x 300 dpi optical
- Digital image processing
- Copy speeds vary according to the complexity of the document and model

### Scan specifications

- Resolution: up to 1200 x 1200 ppi optical  
For more information about ppi resolution, see the scanner software.
- Color: 24-bit color, 8-bit grayscale (256 levels of gray)
- Maximum scan size from glass: 21.6 x 29.7 cm (8.5 x 11.7 inches)

### Print resolution

- For supported print resolutions, visit [the printer support website at www.support.hp.com](http://www.support.hp.com).

### Acoustic information

- If you have Internet access, you can access acoustic information from the [HP website](#).

# Regulatory notices

The printer meets product requirements from regulatory agencies in your country/region.

This section contains the following topics:

- [Regulatory model identification number](#)
- [FCC statement](#)
- [VCCI \(Class B\) compliance statement for users in Japan](#)
- [Notice to users in Japan about the power cord](#)
- [Notice to users in Korea](#)
- [Noise emission statement for Germany](#)
- [European Union Regulatory Notice](#)
- [Declaration of conformity](#)
- [Regulatory wireless statements](#)

## Regulatory model identification number

For regulatory identification purposes, your product is assigned a Regulatory Model Number. The Regulatory Model Number for your product is SNPRH-1506-01. This regulatory number should not be confused with the marketing name (HP Ink Tank Wireless 410 series, etc.) or product numbers (Z4B53A, Z4B54A, etc.).

## FCC statement

The United States Federal Communications Commission (in 47 CFR 15.105) has specified that the following notice be brought to the attention of users of this product.

This equipment has been tested and found to comply with the limits for a Class B digital device, pursuant to Part 15 of the FCC Rules. These limits are designed to provide reasonable protection against harmful interference in a residential installation. This equipment generates, uses and can radiate radio frequency energy and, if not installed and used in accordance with the instructions, may cause harmful interference to radio communications. However, there is no guarantee that interference will not occur in a particular installation. If this equipment does cause harmful interference to radio or television reception, which can be determined by turning the equipment off and on, the user is encouraged to try to correct the interference by one or more of the following measures:

- Reorient or relocate the receiving antenna.
- Increase the separation between the equipment and the receiver.
- Connect the equipment into an outlet on a circuit different from that to which the receiver is connected.
- Consult the dealer or an experienced radio/TV technician for help.

For further information, contact: Manager of Corporate Product Regulations, HP Inc. 1501 Page Mill Road, Palo Alto, CA 94304, U.S.A.

Modifications (part 15.21)

The FCC requires the user to be notified that any changes or modifications made to this device that are not expressly approved by HP may void the user's authority to operate the equipment.

This device complies with Part 15 of the FCC Rules. Operation is subject to the following two conditions: (1) this device may not cause harmful interference, and (2) this device must accept any interference received, including interference that may cause undesired operation.

## VCCI (Class B) compliance statement for users in Japan

この装置は、クラス B 情報技術装置です。この装置は、家庭環境で使用することを目的としていますが、この装置がラジオやテレビジョン受信機に近接して使用されると、受信障害を引き起こすことがあります。取扱説明書に従って正しい取り扱いをして下さい。

VCCI-B

## Notice to users in Japan about the power cord

製品には、同梱された電源コードをお使い下さい。

同梱された電源コードは、他の製品では使用出来ません。

## Notice to users in Korea

B급 기기

(가정용 방송통신기자재)

이 기기는 가정용(B급) 전자파적합기기로서 주로 가정에서 사용하는 것을 목적으로 하며, 모든 지역에서 사용할 수 있습니다.

## Noise emission statement for Germany

Geräuschemission

LpA < 70 dB am Arbeitsplatz im Normalbetrieb nach DIN 45635 T. 19

## European Union Regulatory Notice



Products bearing the CE marking comply to applicable EU Directives and related European Harmonised Standards. The full Declaration of Conformity can be found at the following website:

[www.hp.eu/certificates](http://www.hp.eu/certificates) (Search with the product model name or its Regulatory Model Number (RMN), which may be found on the regulatory label.)

The point of contact for regulatory matters is HP Deutschland GmbH, HQ-TRE, 71025, Boeblingen, Germany.

## Products with wireless functionality

### EMF

- This product meets international guidelines (ICNIRP) for exposure to radio frequency radiation.

If it incorporates a radio transmitting and receiving device that in normal use, a separation distance of 20 cm ensures that radio frequency exposure levels comply with EU requirements.

### Wireless functionality in Europe

- For products with 802.11 b/g/n or Bluetooth radio:
  - This product operates on radio frequency between 2400 MHz and 2483.5 MHz, with a transmit power of 20 dBm (100 mW) or less.
- For products with 802.11 a/b/g/n radio:
  -  **CAUTION:** IEEE 802.11x wireless LAN with 5.15-5.35 GHz frequency band is restricted for **indoor use only** in all European Union member states, EFTA (Iceland, Norway, Liechtenstein) and most other European countries (e.g. Switzerland, Turkey, Republic of Serbia). Using this WLAN application outdoor might lead to interference issues with existing radio services.
  - This product operates on radio frequencies between 2400 MHz and 2483.5 MHz, and between 5170 MHz and 5710 MHz, with a transmit power of 20 dBm (100 mW) or less.

## Declaration of conformity



### DECLARATION OF CONFORMITY according to ISO/IEC 17050-1 and EN 17050-1

DoC #: SNPRH-1506-01- R6 Original/en

**Manufacturer's Name:** HP Inc.  
**Manufacturer's Address:** HP Singapore (Private) Limited, 1 Depot Close, Singapore 109841

**declare, under its sole responsibility that the product**

**Product Name and Model:**<sup>2)</sup> HP DeskJet GT 5820 All-in-One Printer Series  
HP Ink Tank Wireless 410 Series  
HP Smart Tank Wireless 450 Series

**Regulatory Model Number:**<sup>1)</sup> SNPRH-1506-01  
**Product Options:** Please See ANNEX I

**conforms to the following Product Specifications and Regulations:**

#### Safety

IEC 60950-1:2005 +A1:2009 +A2:2013  
EN 60950-1:2006 +A11:2009 +A1:2010  
+A12:2011 +A2:2013  
EN 62479:2010  
EN 62311:2008

#### EMC

EN 55032:2012 / EN 55032:2012 Class B  
CISPR 24:2010 / EN 55024:2010  
EN 61000-3-2:2014  
EN 61000-3-3:2013  
FCC CFR 47 Part 15  
ICES-003, Issue 6  
EN 301 489-1 V2.1.1:2017  
EN 301 489-17 V3.1.1:2017

#### Spectrum

EN 300 328 V2.1.1:2016

#### Ecodesign

Regulation (EC) No. 1275/2008  
ENERGY STAR® Qualified Imaging Equipment Operational Mode (OM) Test Procedure  
EN 50564:2011  
IEC 62301:2011

#### RoHS

EN 50581:2012

The product herewith complies with the requirements of the Radio Equipment Directive 2014/53/EU, the Ecodesign Directive 2009/125/EC, the RoHS Directive 2011/65/EU and carries the **CE**-marking accordingly.

This device complies with part 15 of the FCC Rules. Operation is subject to the following two conditions:  
(1) This device may not cause harmful interference, and (2) this device must accept any interference received, including interference that may cause undesired operation.

#### Additional Information:

- 1) This product is assigned a Regulatory Model Number which stays with the regulatory aspects of the design. The Regulatory Model Number is the main product identifier in the regulatory documentation and test reports, this number should not be confused with the marketing name or the product numbers.
- 2) This product was tested in a typical HP environment, in conjunction with an HP host system.
- 3) This product uses a radio module with Regulatory Model Number SDGOB-1392 as needed to meet technical regulatory requirements for the countries/regions where this product will be sold.

Vancouver, WA  
13-05-2017

Uwe Voigt, Manager

Customer Assurance, Inkjet Business and Platform

#### Local contact for regulatory topics only:

EU: HP Deutschland GmbH, HP HQ-TRE, 71025 Boeblingen, Germany  
U.S.: HP Inc., 1501 Page Mill Road, Palo Alto 94304, U.S.A. 650-857-1501

<http://www.hp.eu/certificates>

**DECLARATION OF CONFORMITY**  
according to ISO/IEC 17050-1 and EN 17050-1

**ANNEX I**

**Regulatory Model Number: SNPRH-1506-01**

**OPTIONS**

DESCRIPTION:*	OPTION RMN.:
Power Supply (World Wide, except China and India)	F5S43-64001

**For non-EU countries only:**

DESCRIPTION:*	OPTION RMN.:
Power Supply (World Wide, except China and India)	F5S43-64001
Power Supply (China and India)	F5S43-64002

\* Where X represents any alpha numeric character.

## Regulatory wireless statements

This section contains the following regulatory information pertaining to wireless products:

- [Exposure to radio frequency radiation](#)
- [Notice to users in Brazil](#)
- [Notice to users in Canada](#)
- [Notice to users in Taiwan](#)
- [Notice to users in Mexico](#)
- [Notice to users in Japan](#)
- [Notice to users in Korea](#)

### Exposure to radio frequency radiation

---

**⚠ CAUTION:** The radiated output power of this device is far below the FCC radio frequency exposure limits. Nevertheless, the device shall be used in such a manner that the potential for human contact during normal operation is minimized. This product and any attached external antenna, if supported, shall be placed in such a manner to minimize the potential for human contact during normal operation. In order to avoid the possibility of exceeding the FCC radio frequency exposure limits, human proximity to the antenna shall not be less than 20 cm (8 inches) during normal operation.

---

### Notice to users in Brazil

Este equipamento opera em caráter secundário, isto é, não tem direito à proteção contra interferência prejudicial, mesmo de estações do mesmo tipo, e não pode causar interferência em sistemas operando em caráter primário.

### Notice to users in Canada

Under Industry Canada regulations, this radio transmitter may only operate using an antenna of a type and maximum (or lesser) gain approved for the transmitter by Industry Canada. To reduce potential radio interference to other users, the antenna type and its gain should be so chosen that the equivalent isotropically radiated power (e.i.r.p.) is not more than that necessary for successful communication.

This device complies with Industry Canada licence-exempt RSS standard(s). Operation is subject to the following two conditions: (1) this device may not cause interference, and (2) this device must accept any interference, including interference that may cause undesired operation of the device.

**WARNING!** Exposure to Radio Frequency Radiation The radiated output power of this device is below the Industry Canada radio frequency exposure limits. Nevertheless, the device should be used in such a manner that the potential for human contact is minimized during normal operation.

To avoid the possibility of exceeding the Industry Canada radio frequency exposure limits, human proximity to the antennas should not be less than 20 cm (8 inches).

Conformément au Règlement d'Industrie Canada, cet émetteur radioélectrique ne peut fonctionner qu'avec une antenne d'un type et d'un gain maximum (ou moindre) approuvé par Industrie Canada. Afin de réduire le brouillage radioélectrique potentiel pour d'autres utilisateurs, le type d'antenne et son gain doivent être choisis de manière à ce que la puissance isotrope rayonnée équivalente (p.i.r.e.) ne dépasse pas celle nécessaire à une communication réussie.



Cet appareil est conforme aux normes RSS exemptes de licence d'Industrie Canada. Son fonctionnement dépend des deux conditions suivantes : (1) cet appareil ne doit pas provoquer d'interférences nuisibles et (2) doit accepter toutes les interférences reçues, y compris des interférences pouvant provoquer un fonctionnement non souhaité de l'appareil.

AVERTISSEMENT relatif à l'exposition aux radiofréquences. La puissance de rayonnement de cet appareil se trouve sous les limites d'exposition de radiofréquences d'Industrie Canada. Néanmoins, cet appareil doit être utilisé de telle sorte qu'il doive être mis en contact le moins possible avec le corps humain.

Afin d'éviter le dépassement éventuel des limites d'exposition aux radiofréquences d'Industrie Canada, il est recommandé de maintenir une distance de plus de 20 cm entre les antennes et l'utilisateur.

## Notice to users in Taiwan

低功率電波輻射性電機管理辦法

第十二條

經型式認證合格之低功率射頻電機，非經許可，公司、商號或使用者均不得擅自變更頻率、加大功率或變更設計之特性及功能。

第十四條

低功率射頻電機之使用不得影響飛航安全及干擾合法通信；經發現有干擾現象時，應立即停用，並改善至無干擾時方得繼續使用。

前項合法通信，指依電信法規定作業之無線電通信。低功率射頻電機須忍受合法通信或工業、科學及醫藥用電波輻射性電機設備之干擾。

## Notice to users in Mexico

La operación de este equipo está sujeta a las siguientes dos condiciones: (1) es posible que este equipo o dispositivo no cause interferencia perjudicial y (2) este equipo o dispositivo debe aceptar cualquier interferencia, incluyendo la que pueda causar su operación no deseada.

Para saber el modelo de la tarjeta inalámbrica utilizada, revise la etiqueta regulatoria de la impresora.

## Notice to users in Japan

この機器は技術基準適合証明又は工事設計認証を受けた無線設備を搭載しています。

## Notice to users in Korea

해당 무선설비는 전파혼신 가능성이 있으므로 인명안전과 관련된 서비스는 할 수 없음

(무선 모듈이 탑재된 제품인 경우)

## Environmental product stewardship program

HP is committed to providing quality products in an environmentally sound manner. Design for recycling has been incorporated into this product. The number of materials has been kept to a minimum while ensuring proper functionality and reliability. Dissimilar materials have been designed to separate easily. Fasteners and other connections are easy to locate, access, and remove using common tools. High priority parts have been designed to access quickly for efficient disassembly and repair.

For more information, visit HP's Commitment to the Environment Web site at:

[www.hp.com/hpinfo/globalcitizenship/environment](http://www.hp.com/hpinfo/globalcitizenship/environment)

- [Eco-Tips](#)
- [European Union Commission Regulation 1275/2008](#)
- [Paper](#)
- [Plastics](#)
- [Safety data sheets](#)
- [Recycling program](#)
- [HP inkjet supplies recycling program](#)
- [Power consumption](#)
- [Disposal of waste equipment by users](#)
- [Waste disposal for Brazil](#)
- [Chemical substances](#)
- [Declaration of the Presence Condition of the Restricted Substances Marking \(Taiwan\)](#)
- [The Table of Hazardous Substances/Elements and their Content \(China\)](#)
- [Restriction of hazardous substance \(India\)](#)
- [Restriction of hazardous substance \(Ukraine\)](#)
- [Restriction on hazardous substances statement \(Turkey\)](#)
- [EPEAT](#)
- [SEPA Ecolabel User Information \(China\)](#)
- [China Energy Label for Printer, Fax and Copier](#)

### Eco-Tips

HP is committed to helping customers reduce their environmental footprint. Please visit the HP Environmental Programs and Initiatives website for more information on HP's environmental initiatives.

[www.hp.com/hpinfo/globalcitizenship/environment/](http://www.hp.com/hpinfo/globalcitizenship/environment/)

## European Union Commission Regulation 1275/2008

For product power data, including the power consumption of the product in networked standby if all wired network ports are connected and all wireless network ports are activated, please refer to section P14 'Additional Information' of the product IT ECO Declaration at [www.hp.com/hpinfo/globalcitizenship/environment/productdata/itecodesktop-pc.html](http://www.hp.com/hpinfo/globalcitizenship/environment/productdata/itecodesktop-pc.html).

## Paper

This product is suited for the use of recycled paper according to DIN 19309 and EN 12281:2002.

## Plastics

Plastic parts over 25 grams are marked according to international standards that enhance the ability to identify plastics for recycling purposes at the end of product life.

## Safety data sheets

Safety Data Sheets, product safety and environmental information are available at [www.hp.com/go/ecodata](http://www.hp.com/go/ecodata) or on request.

## Recycling program

HP offers an increasing number of product return and recycling programs in many countries/regions, and partners with some of the largest electronic recycling centers throughout the world. HP conserves resources by reselling some of its most popular products. For more information regarding recycling of HP products, please visit:

[www.hp.com/hpinfo/globalcitizenship/environment/recycle/](http://www.hp.com/hpinfo/globalcitizenship/environment/recycle/)

## HP inkjet supplies recycling program

HP is committed to protecting the environment. The HP Inkjet Supplies Recycling Program is available in many countries/regions, and lets you recycle used print cartridges and ink cartridges free of charge. For more information, go to the following website:

[www.hp.com/hpinfo/globalcitizenship/environment/recycle/](http://www.hp.com/hpinfo/globalcitizenship/environment/recycle/)

## Power consumption

HP printing and imaging equipment marked with the ENERGY STAR® logo is certified by the U.S. Environmental Protection Agency. The following mark will appear on ENERGY STAR certified imaging products:



Additional ENERGY STAR certified imaging product model information is listed at: [www.hp.com/go/energystar](http://www.hp.com/go/energystar)

## Disposal of waste equipment by users



This symbol means do not dispose of your product with your other household waste. Instead, you should protect human health and the environment by handing over your waste equipment to a designated collection point for the recycling of waste electrical and electronic equipment. For more information, please contact your household waste disposal service, or go to <http://www.hp.com/recycle>.

## Waste disposal for Brazil



Não descarte o produto eletrônico em lixo comum

Este produto eletrônico e seus componentes não devem ser descartados no lixo comum, pois embora estejam em conformidade com padrões mundiais de restrição a substâncias nocivas, podem conter, ainda que em quantidades mínimas, substâncias impactantes ao meio ambiente. Ao final da vida útil deste produto, o usuário deverá entregá-lo à HP. A não observância dessa orientação sujeitará o infrator às sanções previstas em lei.

Após o uso, as pilhas e/ou baterias dos produtos HP deverão ser entregues ao estabelecimento comercial ou rede de assistência técnica autorizada pela HP.

Para maiores informações, inclusive sobre os pontos de recebimento, acesse:

[www.hp.com.br/reciclar](http://www.hp.com.br/reciclar)

## Chemical substances

HP is committed to providing our customers with information about the chemical substances in our products as needed to comply with legal requirements such as REACH (*Regulation EC No 1907/2006 of the European Parliament and the Council*). A chemical information report for this product can be found at: [www.hp.com/go/reach](http://www.hp.com/go/reach).

## Declaration of the Presence Condition of the Restricted Substances Marking (Taiwan)

限用物質含有情況標示聲明書

Declaration of the Presence Condition of the Restricted Substances Marking

單元 Unit	限用物質及其化學符號					
	Restricted substances and its chemical symbols					
	鉛 Lead (Pb)	汞 Mercury (Hg)	鎘 Cadmium (Cd)	六價鉻 Hexavalent chromium (Cr <sup>6+</sup> )	多溴聯苯 Polybrominated biphenyls (PBB)	多溴二苯醚 Polybrominated diphenyl ethers (PBDE)
外殼和紙匣 (External Casings and Trays)	0	0	0	0	0	0
電線 (Cables)	0	0	0	0	0	0
印刷電路板 (Printed Circuit Boards)	—	0	0	0	0	0
列印引擎(Print Engine)	—	0	0	0	0	0
列印機組件 (Print Assembly)	—	0	0	0	0	0
噴墨印表機墨水匣 (Print Supplies)	0	0	0	0	0	0
列印機配件 (Print Accessory)	—	0	0	0	0	0

備考 1. “超出 0.1 wt %” 及 “超出 0.01 wt %” 係指限用物質之百分比含量超出百分比含量基準值。

Note 1: “Exceeding 0.1 wt %” and “exceeding 0.01 wt %” indicate that the percentage content of the restricted substance exceeds the reference percentage value of presence condition.

備考 2. “0” 係指該項限用物質之百分比含量未超出百分比含量基準值。

Note 2: “0” indicates that the percentage content of the restricted substance does not exceed the percentage of reference value of presence.

備考 3. “—” 係指該項限用物質為排除項目。

Note 3: The “—” indicates that the restricted substance corresponds to the exemption.

若要存取產品的最新使用指南或手冊，請前往 [www.support.hp.com](http://www.support.hp.com)。選取搜尋您的產品，然後依照畫面上的指示繼續執行。

To access the latest user guides or manuals for your product, go to [www.support.hp.com](http://www.support.hp.com). Select **Find your product**, and then follow the onscreen instructions.

## The Table of Hazardous Substances/Elements and their Content (China)

产品中有害物质或元素的名称及含量

根据中国《电器电子产品有害物质限制使用管理办法》



部件名称	有害物质					
	铅 (Pb)	汞 (Hg)	镉 (Cd)	六价铬 (Cr(VI))	多溴联苯 (PBB)	多溴二苯醚 (PBDE)
外壳和托盘	0	0	0	0	0	0
电线	0	0	0	0	0	0
印刷电路板	X	0	0	0	0	0
打印系统	X	0	0	0	0	0
显示器	X	0	0	0	0	0
喷墨打印机墨盒	0	0	0	0	0	0
驱动光盘	X	0	0	0	0	0
扫描仪	X	0	0	0	0	0
网络配件	X	0	0	0	0	0
电池板	X	0	0	0	0	0
自动双面打印系统	0	0	0	0	0	0
外部电源	X	0	0	0	0	0

本表格依据 SJ/T 11364 的规定编制。

0：表示该有害物质在该部件所有均质材料中的含量均在 GB/T 26572 规定的限量要求以下。

X：表示该有害物质至少在该部件的某一均质材料中的含量超出 GB/T 26572 规定的限量要求。

此表中所有名称中含“X”的部件均符合欧盟 RoHS 立法。

注：环保使用期限的参考标识取决于产品正常工作的温度和湿度等条件。

## Restriction of hazardous substance (India)

This product, as well as its related consumables and spares, complies with the reduction in hazardous substances provisions of the "India E-waste Rule 2016." It does not contain lead, mercury, hexavalent chromium, polybrominated biphenyls or polybrominated diphenyl ethers in concentrations exceeding 0.1 weight % and 0.01 weight % for cadmium, except where allowed pursuant to the exemptions set in Schedule 2 of the Rule.

## Restriction of hazardous substance (Ukraine)

### Технічний регламент щодо обмеження використання небезпечних речовин (Україна)

Обладнання відповідає вимогам Технічного регламенту щодо обмеження використання деяких небезпечних речовин в електричному та електронному обладнанні, затвердженого постановою Кабінету Міністрів України від 3 грудня 2008 № 1057

## Restriction on hazardous substances statement (Turkey)

Türkiye Cumhuriyeti: EEE Yönetmeliğine Uygundur

## EPEAT

Most HP products are designed to meet EPEAT. EPEAT is a comprehensive environmental rating that helps identify greener electronics equipment. For more information on EPEAT go to [www.epeat.net](http://www.epeat.net). For information on HP's EPEAT registered products go to [www.hp.com/hpinfo/globalcitizenship/environment/pdf/epeat\\_printers.pdf](http://www.hp.com/hpinfo/globalcitizenship/environment/pdf/epeat_printers.pdf).

## SEPA Ecolabel User Information (China)

### 中国环境标识认证产品用户说明

噪声大于 63.0 dB(A) 的办公设备不宜放置于办公室内，请在独立的隔离区域使用。

如需长时间使用本产品或打印大量文件，请确保在通风良好的房间内使用。

如您需要确认本产品处于零能耗状态，请按下电源关闭按钮，并将插头从电源插座断开。

您可以使用再生纸，以减少资源耗费。

## China Energy Label for Printer, Fax and Copier

### 复印机、打印机和传真机能源效率标识实施规则

依据“复印机、打印机和传真机能源效率标识实施规则”，该打印机具有中国能效标识。标识上显示的能效等级和操作模式值根据“复印机、打印机和传真机能效限定值及能效等级”标准（“GB 21521”）来确定和计算。

#### 1. 能效等级

产品能效等级分 3 级，其中 1 级能效最高。能效限定值根据产品类型和打印速度由标准确定。能效等级则根据基本功耗水平以及网络接口和内存等附加组件和功能的功率因子之和来计算。

#### 2. 能效信息

##### 喷墨打印机

- 操作模式功率

睡眠状态的能耗按照 GB 21521 的标准来衡量和计算。该数据以瓦特 (W) 表示。

- 待机功率

待机状态是产品连接到电网电源上功率最低的状态。该状态可以延续无限长时间，且使用者无法改变此状态下产品的功率。对于“成像设备”产品，“待机”状态通常相当于“关闭”状态，但也可能相当于“准备”状态或者“睡眠”状态。该数据以瓦特 (W) 表示。

- 睡眠状态预设延迟时间

出厂前由制造商设置的时间决定了该产品在完成主功能后进入低耗模式（例如睡眠、自动关机）的时间。该数据以分钟表示。

- 附加功能功率因子之和

网络接口和内存等附加功能的功率因子之和。该数据以瓦特 (W) 表示。

标识上显示的能耗数据是根据典型配置测量得出的数据，此类配置包含登记备案的打印机依据复印机、打印机和传真机能源效率标识实施规则所选的所有配置。因此，该特定产品型号的实际能耗可能与标识上显示的数据有所不同。

要了解规范的更多详情，请参考最新版的 GB 21521 标准。



---

# Index

## B

buttons, control panel 6

## C

carriage

clear carriage jams 85

control panel

buttons 6

features 6

status icons 7

copy

specifications 116

customer support

warranty 112

## E

embedded web server

opening 78

Webscan 56

environment

Environmental product

stewardship program 124

environmental specifications

115

## J

jams

clear 82

## M

multi-feeds, troubleshoot 86

## N

network connection

wireless connection 68

networks

view and print settings 75

## O

operating systems supported 115

## P

paper

clear jams 82

HP, order 25

skewed pages 86

troubleshoot feeding 86

paper-feed problems, troubleshoot

86

power

troubleshoot 109

print

specifications 116

troubleshoot 109

printer software (Windows)

opening 26

## R

recycle

ink cartridges 125

regulatory notices 117

regulatory model identification

number 117

wireless statements 122

## S

scan

from Webscan 56

scan specifications 116

skew, troubleshoot

print 86

software

Webscan 56

specifications

system requirements 115

status icons 7

system requirements 115

## T

technical information

copy specifications 116

environmental specifications

115

print specifications 116

scan specifications 116

trays

clear paper jams 82

troubleshoot feeding 86

troubleshoot

HP Smart 108

multiple pages are picked 86

paper not picked up from tray

86

paper-feed problems 86

power 109

print 109

skewed pages 86

## V

view

network settings 75

## W

warranty 112

Webscan 56

Windows

system requirements 115