



User Guide

© Copyright 2018 HP Development Company, L.P.

Chrome and Google Cloud Print are trademarks of Google Inc.

The information contained herein is subject to change without notice. The only warranties for HP products and services are set forth in the express warranty statements accompanying such products and services. Nothing herein should be construed as constituting an additional warranty. HP shall not be liable for technical or editorial errors or omissions contained herein.

First Edition: February 2018

Document Part Number: L13106-001

Product notice

This guide describes features that are common to most models. Some features may not be available on your computer.

Software terms

By installing, copying, downloading, or otherwise using any software product preinstalled on this computer, you agree to be bound by the terms of the HP End User License Agreement (EULA). If you do not accept these license terms, your sole remedy is to return the entire unused product (hardware and software) within 14 days for a full refund subject to the refund policy of your seller.

For any further information or to request a full refund of the price of the computer, please contact your seller.

Safety warning notice

 **WARNING!** To reduce the possibility of heat-related injuries or of overheating the computer, do not place the computer directly on your lap or obstruct the computer air vents. Use the computer only on a hard, flat surface. Do not allow another hard surface, such as an adjoining optional printer, or a soft surface, such as pillows or rugs or clothing, to block airflow. Also, do not allow the AC adapter to come into contact with the skin or a soft surface, such as pillows or rugs or clothing, during operation. The computer and the AC adapter comply with the user-accessible surface temperature limits defined by the International Standard for Safety of Information Technology Equipment (IEC 60950).

Table of contents

1 Getting to know your computer	1
Right side	1
Left side	3
Display	4
TouchPad	5
Button	6
Bottom	7
Labels	8
2 Navigating the screen	9
Using TouchPad and touch screen gestures	9
Tapping	9
Scrolling (TouchPad only)	10
One-finger scrolling (touch screen only)	11
One-finger swipe (touch screen only)	12
Two-finger pinch zoom (touch screen only)	12
3 Using the action keys	13
Using the action keys	13
4 Power and battery	14
Factory-sealed battery	14
Charging the battery	14
5 Printing	15
Printing from the Google Chrome browser	15
Printing with Google Cloud Print web printing service	15
6 More HP resources	16
More HP resources	16
7 Electrostatic Discharge	17
8 Accessibility	18
Supported assistive technologies	18





Contacting support 18

Index **19**

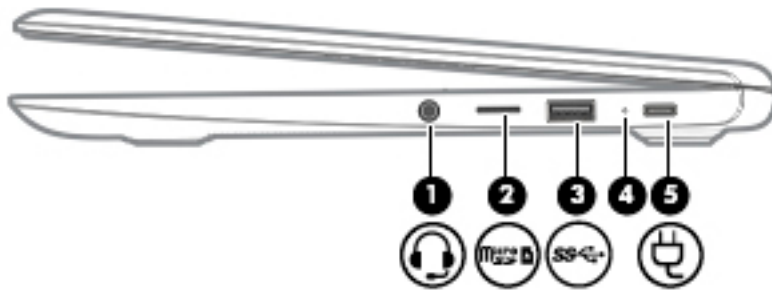
1 Getting to know your computer

Right side





Component	Description
(1) 	<p>Audio-out (headphone)/Audio-in (microphone) combo jack</p> <p>Connects optional powered stereo speakers, headphones, earbuds, a headset, or a television audio cable. Also connects an optional headset microphone. This jack does not support optional microphone-only devices.</p> <p>WARNING! To reduce the risk of personal injury, adjust the volume before putting on headphones, earbuds, or a headset. For additional safety information, refer to the <i>Regulatory, Safety, and Environmental Notices</i>.</p> <p>This guide is provided in the box.</p> <p>NOTE: When a device is connected to the jack, the computer speakers are disabled.</p>
(2) 	<p>MicroSD memory card reader</p> <p>Reads optional memory cards that store, manage, share, or access information.</p> <p>To insert a card:</p> <ol style="list-style-type: none">1. Hold the card label-side up, with connectors facing the computer.2. Insert the card into the memory card reader, and then press in on the card until it is firmly seated. <p>To remove a card:</p> <ul style="list-style-type: none">▲ Pull out the card.
(3) 	<p>USB 3.x SuperSpeed port</p> <p>Connects a USB device, such as a cell phone, camera, activity tracker, or smartwatch, and provides high-speed data transfer.</p>
(4) 	<p>AC adapter and battery light</p> <ul style="list-style-type: none">• White: The AC adapter is connected and the battery is charged.• Amber: The AC adapter is connected and the battery is charging.

Component	Description
(5)	<ul style="list-style-type: none">• Off: The computer is using battery power.
	USB Type-C power connector and charging port Connects an AC adapter that has a USB Type-C connector, supplying power to the computer and, if needed, charging the computer battery.

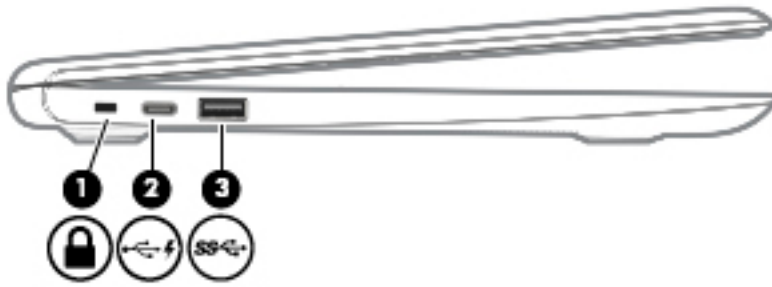
Left side



Component	Description
(1) 	Nano security cable slot Attaches an optional security cable to the computer. NOTE: The security cable is designed to act as a deterrent, but it may not prevent the computer from being mishandled or stolen.
(2) 	USB Type-C power connector and charging port Connects an AC adapter that has a USB Type-C connector, supplying power to the computer and, if needed, charging the computer battery. Also connects a USB device with a Type-C connector and can charge products such as cell phones, laptops, tablets, and MP3 players, even when the computer is off.
(3) 	USB 3.x SuperSpeed port Connects a USB device, such as a cell phone, camera, activity tracker, or smartwatch, and provides high-speed data transfer.

Display

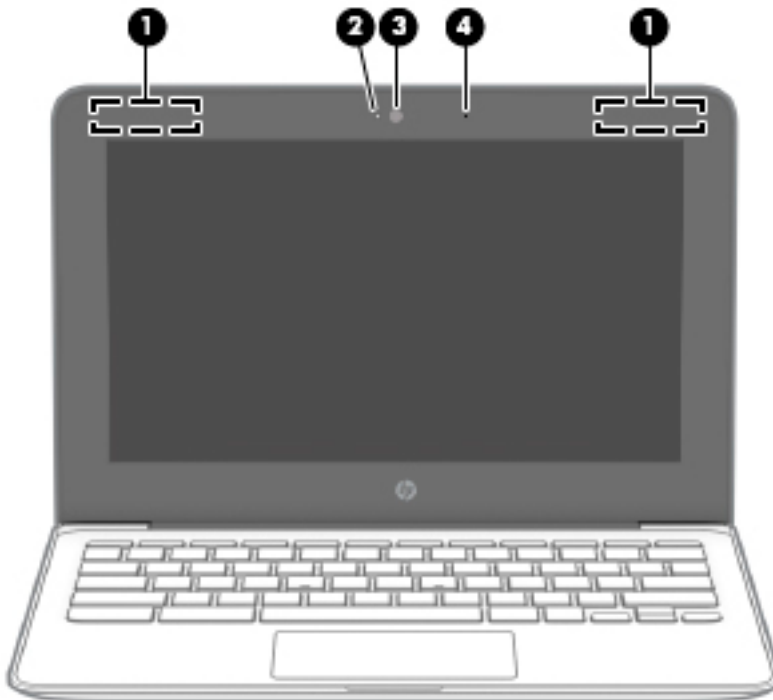

Component		Description
(1)	WLAN antennas*	Send and receive wireless signals to communicate with wireless local area networks (WLANs). NOTE: The position of the WLAN antennas may differ, depending on the product.
(2)	Camera light	On: The camera is in use.
(3)	Camera	Records video, captures still photographs, and allows video conferences and online chat by means of streaming video.
(4)	Internal microphone	Records sound.

*The antennas are not visible from the outside of the computer, and antenna location varies. For optimal transmission, keep the areas immediately around the antennas free from obstructions.

For wireless regulatory notices, see the section of the *Regulatory, Safety, and Environmental Notices* that applies to your country or region.

This guide is provided in the box.

TouchPad

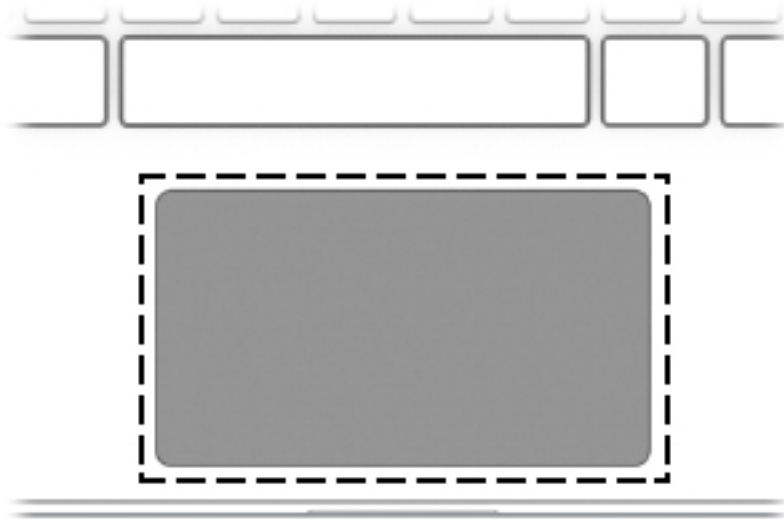

Component	Description
TouchPad zone	Moves the on-screen pointer and selects or activates items on the screen. NOTE: For more information, see Using TouchPad and touch screen gestures on page 9 .

Button

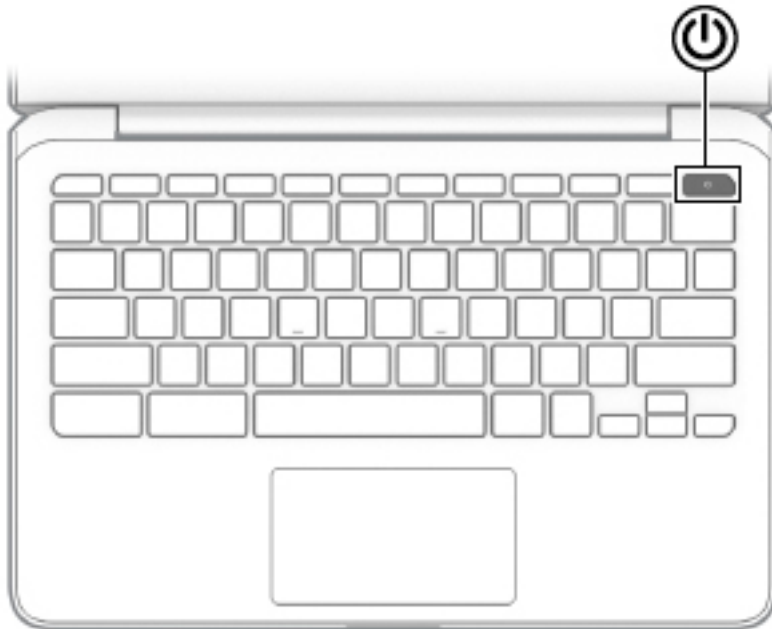

Component	Description
 Power button	<ul style="list-style-type: none">• When the computer is off, press the button to turn on the computer.• When the computer is in the Sleep state, press the button briefly to exit Sleep.• When the computer is on and you want to lock the screen, press the button until you see the sign-in screen appear. Pressing the power button during screen-lock mode turns off the computer.• When the computer is on and you want to turn it off, press and hold the button to lock the screen, and then continue to press the button until the computer turns off.

Bottom



Component	Description
Speakers (2)	Produce sound.

Labels

The labels affixed to the computer provide information you may need when you troubleshoot system problems or travel internationally with the computer.

 **IMPORTANT:** All labels described in this section will be affixed to the bottom of the computer.

- Service label—Provides important information to identify your computer. When contacting support, you will probably be asked for the serial number, and possibly for the product number or the model number. Locate these numbers before you contact support.

Your service label will resemble one of the examples shown below. Refer to the illustration that most closely matches the service label on your computer.



Component

- | | |
|-----|-------------------------------------|
| (1) | Serial number |
| (2) | Product number |
| (3) | Warranty period |
| (4) | Model number (select products only) |
-

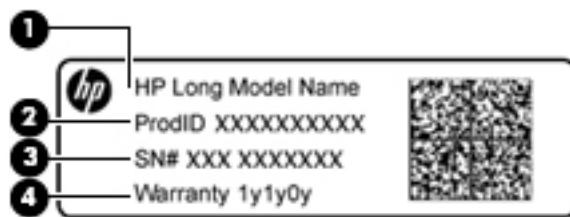

Component

- | | |
|-----|-----------------------------------|
| (1) | Model name (select products only) |
| (2) | Product number |
| (3) | Serial number |
| (4) | Warranty period |
-

- Regulatory label(s)—Provide(s) regulatory information about the computer.
- Wireless certification label(s)—Provide(s) information about optional wireless devices and the approval markings for the countries or regions in which the devices have been approved for use.

2 Navigating the screen

You can navigate the screen in the following ways:

- Use touch gestures directly on the computer screen (select products only).
- Use touch gestures on the TouchPad.

Using TouchPad and touch screen gestures

The TouchPad supports a variety of gestures that let your fingers tap and scroll to manipulate items on the desktop. To navigate a touch screen (select products only), touch the screen directly using gestures described in this chapter.

Tapping

Tap one finger on the TouchPad zone or touch screen to make a selection.



Tap two fingers on the TouchPad zone or touch screen to bring up a context-sensitive menu.



Scrolling (TouchPad only)

Scrolling is useful for moving up, down, or sideways on a page or image. Scrolling to the left or the right with two fingers will scroll the screen, if there is more content viewable to either side, or will move back and forth through web browser history.

To scroll, place two fingers slightly apart on the TouchPad, and then drag them across the TouchPad in an up, down, left, or right motion.

 **NOTE:** Scrolling speed is controlled by finger speed.



To scroll between open tabs in Chrome, slide three fingers left or right on the TouchPad.



One-finger scrolling (touch screen only)

Scrolling to the left or the right with one finger will move back and forth through web browser history.

To scroll, place fingers on the touch screen, and then drag it across the touch screen in a left or right motion.

 **NOTE:** Scrolling speed is controlled by finger speed.



One-finger swipe (touch screen only)

Swiping up with one finger will hide or show your shelf. The shelf contains a list of popular shortcuts to apps so that you can find them easily.

To swipe, place your finger on the bottom of the screen, quickly slide your finger up a short distance, and then lift it.

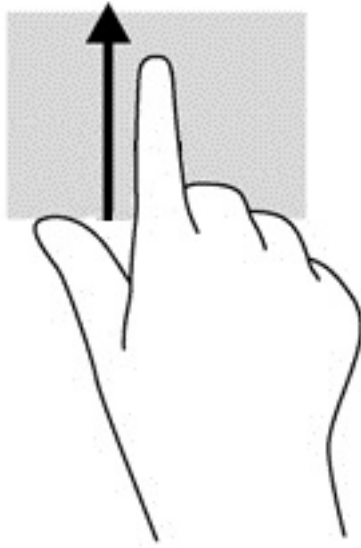

Two-finger pinch zoom (touch screen only)

Use the two-finger pinch zoom to zoom out or in on images or text.



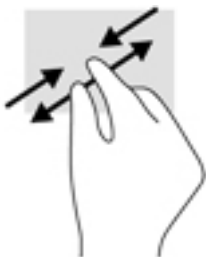









- Zoom out by placing two fingers apart on the touch screen and then moving your fingers together.
- Zoom in by placing two fingers together on the touch screen and then moving your fingers apart.



3 Using the action keys

Using the action keys

For more information on action keys and keyboard shortcuts, go to <https://support.google.com/chromebook/answer/183101>. Select your language at the bottom of the page.

Icon	Key	Description
	<code>esc</code>	Activates certain computer functions when pressed in combination with other keys, such as tab or shift.
	Back	Displays the previous page in your browser history.
	Forward	Displays the next page in your browser history.
	Reload	Reloads your current page.
	Full screen	Opens your page in full-screen mode.
	Display apps	Displays open apps. NOTE: Pressing this button in conjunction with <code>ctrl</code> takes a screenshot.
	Brightness down	Decreases the screen brightness incrementally as long as you hold down the key.
	Brightness up	Increases the screen brightness incrementally as long as you hold down the key.
	Mute	Mutes speaker sound.
	Volume down	Decreases speaker volume incrementally as long as you hold down the key.
	Volume up	Increases speaker volume incrementally as long as you hold down the key.
<code>alt+</code> 	Keyboard backlight brightness up	Increases the keyboard backlight brightness.
<code>alt+</code> 	Keyboard backlight brightness down	Decreases the keyboard backlight brightness.

4 Power and battery

Factory-sealed battery

The battery[ies] in this product cannot be easily replaced by users themselves. Removing or replacing the battery could affect your warranty coverage. If a battery is no longer holding a charge, contact support. When a battery has reached the end of its useful life, do not dispose of the battery in general household waste. Follow the local laws and regulations in your area for battery disposal.

Charging the battery

1. Connect the power adapter to the computer.
2. Verify that the battery is charging by checking the AC adapter light. This light is located on the computer's left side, next to the power connector.

AC adapter light	Status
White	The AC adapter is connected and the battery is charged.
Amber	The AC adapter is connected and the battery is charging.
Off	The computer is using battery power.

3. While the battery is charging, keep the AC adapter connected until the AC adapter light turns white.

5 Printing

Use one of the following methods to print from your computer:

- Print from the Google Chrome™ browser
- Print with Google Cloud™ Print web printing service



NOTE: If you use HP Print for Chrome, the printer cannot be registered with Google Cloud Print.

Printing from the Google Chrome browser

To print from the Google Chrome browser, use the HP Print for Chrome app. You can install the HP Print for Chrome app from the Chrome Web Store. For more information, see the HP website.

1. Go to <http://support.hp.com/us-en/document/c04683559?openCLC=true>.
2. Select your country.
3. Select your language, and then follow the on-screen instructions.

Printing with Google Cloud Print web printing service

Google Cloud Print web printing service is a free service that allows you to print documents and photos securely from your computer. For information about prerequisites and steps for using Google Cloud Print, see the HP website.

1. Go to <http://support.hp.com/us-en/document/c02817255?openCLC=true>.
2. Select your country.
3. Select your language, and then follow the on-screen instructions.

6 More HP resources

More HP resources

To locate resources that provide product details, how-to information, and more, use this table.

Resource	Contents
<i>Setup Instructions</i>	<ul style="list-style-type: none">• How to set up the computer• Help to identify computer components
HP website To access the latest user guide, go to http://www.hp.com/support , and follow the instructions to find your product. Then select User Guides .	<ul style="list-style-type: none">• Support information• Ordering parts and finding additional help• Accessories available for the device
Worldwide support To get support in your language, go to http://www.hp.com/support , and select your country.	<ul style="list-style-type: none">• Online chat with an HP technician• Support telephone numbers• HP service center locations
<i>Safety & Comfort Guide</i> Go to http://www.hp.com/ergo .	<ul style="list-style-type: none">• Proper workstation setup• Guidelines for posture and work habits that increase comfort and decrease risk of injury• Electrical and mechanical safety information
<i>Regulatory, Safety and Environmental Notices</i> This guide is provided in the box.	<ul style="list-style-type: none">• Regulatory and safety information• Battery disposal information
<i>Limited Warranty*</i> Go to http://www.hp.com/go/orderdocuments .	<ul style="list-style-type: none">• Warranty information

*You can find your HP Limited Warranty located with the user guides on your product and/or on the CD or DVD provided in the box. In some countries or regions, HP may provide a printed warranty in the box. For countries or regions where the warranty is not provided in printed format, you can request a copy from <http://www.hp.com/go/orderdocuments>. For products purchased in Asia Pacific, you can write to HP at POD, PO Box 161, Kitchener Road Post Office, Singapore 912006. Include your product name, and your name, phone number, and postal address.

7 Electrostatic Discharge

Electrostatic discharge is the release of static electricity when two objects come into contact—for example, the shock you receive when you walk across the carpet and touch a metal door knob.

A discharge of static electricity from fingers or other electrostatic conductors may damage electronic components.

To prevent damage to the computer, damage to a drive, or loss of information, observe these precautions:

- If removal or installation instructions direct you to unplug the computer, first be sure that it is properly grounded.
- Keep components in their electrostatic-safe containers until you are ready to install them.
- Avoid touching pins, leads, and circuitry. Handle electronic components as little as possible.
- Use nonmagnetic tools.
- Before handling components, discharge static electricity by touching an unpainted metal surface.
- If you remove a component, place it in an electrostatic-safe container.

8 Accessibility

HP designs, produces, and markets products and services that can be used by everyone, including people with disabilities, either on a stand-alone basis or with appropriate assistive devices.

Supported assistive technologies

HP products support a wide variety of operating system assistive technologies and can be configured to work with additional assistive technologies. Use the Search feature on your device to locate more information about assistive features.

 **NOTE:** For additional information about a particular assistive technology product, contact customer support for that product.

Contacting support

We are constantly refining the accessibility of our products and services and welcome feedback from users. If you have an issue with a product or would like to tell us about accessibility features that have helped you, please contact us at +1 (888) 259-5707, Monday through Friday, 6 a.m. to 9 p.m. North American Mountain Time. If you are deaf or hard-of-hearing and use TRS/VRS/WebCapTel, contact us if you require technical support or have accessibility questions by calling +1 (877) 656-7058, Monday through Friday, 6 a.m. to 9 p.m. North American Mountain Time.

 **NOTE:** Support is in English only.

Index

A

- AC adapter light 1
- accessibility 18
- action keys
 - back 13
 - brightness down 13
 - brightness up 13
 - esc 13
 - forward 13
 - full screen 13
 - mute 13
 - next window 13
 - volume down 13
 - volume up 13
- actions keys
 - reload 13
- audio-in (microphone) jack, identifying 1
- audio-out (headphone) jack, identifying 1

B

- back action key 13
- battery
 - charging 14
 - factory sealed 14
 - light 1
- Bluetooth label 8
- bottom 8
- brightness down action key 13
- brightness up action key 13
- buttons, power 6

C

- camera light, identifying 4
- camera, identifying 4
- components
 - bottom 7
 - buttons 6
 - display 4
 - left side 3
 - right side 1
- connector, power 2

E

- electrostatic discharge 17
- esc key, identifying 13

F

- forward action key 13
- full screen action key 13

H

- headphone (audio-out) jack 1

I

- internal microphone, identifying 4

J

- jacks
 - audio-in (microphone) 1
 - audio-out (headphone) 1

K

- keyboard backlight, identifying 13

L

- labels
 - Bluetooth 8
 - regulatory 8
 - serial number 8
 - service 8
 - wireless certification 8
 - WLAN 8
- lights
 - AC adapter and battery 1
 - camera 4

M

- memory card, identifying 1
- microphone (audio-in) jack, identifying 1
- microSD memory card reader, identifying 1
- mute action key 13

N

- nano security cable slot, identifying 3

- next window action key 13

P

- ports
 - USB 3.x SuperSpeed port 3
 - USB 3.x SuperSpeedport 1
 - USB Type-C power connector and charging port 3
- power button, identifying 6
- power connector, identifying 2
- printing 15
- product name and number, computer 8

R

- regulatory information
 - regulatory label 8
 - wireless certification labels 8
- reload action key 13
- resources 16

S

- scrolling touch screen gesture 11
- scrolling TouchPad gesture 10
- serial number 8
- serial number, computer 8
- service labels, locating 8
- slots
 - microSD memory card reader 1
 - nano security cable 3
- speaker, identifying 7
- support 16
- swiping touch screen gesture 12

T

- tapping gestures 9
- touch screen gestures
 - one-finger scrolling 11
 - one-finger swipe 12
 - two-finger pinch zoom 12
- TouchPad and touch screen gestures, tapping 9
- TouchPad gestures, scrolling 10
- TouchPad zone, identifying 5
- traveling with the computer 8

two-finger pinch zoom touch screen
gesture 12

U

USB 3.x SuperSpeed port,
identifying 1, 3

USB Type-C power connector and
charging port 3

USB Type-C power connector and
charging port, identifying 2

V

volume down action key 13

volume up action key 13

W

wireless certification label 8

WLAN antennas, identifying 4

WLAN device 8

WLAN label 8