



Intel® Data Center Blocks for Cloud – Microsoft Windows Server* 2016

System Deployment and Configuration Guide

A document to provide guidance for initial system setup and OS installation and identification of available system options

Revision 1.0

October 2016

Intel® Server Products and Solutions

<This page is intentionally left blank.>

Document Revision History

Date Published	Revision	Revision Change Description
October 2016	1.0	Initial Public Release

Disclaimers

No license (express or implied, by estoppel or otherwise) to any intellectual property rights is granted by this document.

Intel technologies' features and benefits depend on system configuration and may require enabled hardware, software or service activation. Performance varies depending on system configuration. All information provided here is subject to change without notice.

The products and services described may contain defects or errors known as errata which may cause deviations from published specifications. Current characterized errata are available on request.

You may not use or facilitate the use of this document in connection with any infringement or other legal analysis concerning Intel products described herein. You agree to grant Intel a non-exclusive, royalty-free license to any patent claim thereafter drafted which includes subject matter disclosed herein.

Intel and the Intel logo are trademarks of Intel Corporation in the U.S. and/or other countries.

*Other names and brands may be claimed as the property of others.

© Intel Corporation

Table of Contents

1	INTRODUCTION.....	1
2	MICROSOFT WINDOWS SERVER* 2016 INSTALLATION REQUIREMENTS	4
	APPENDIX A - SYSTEM CONFIGURATION OPTIONS	5
	INTEL® SERVER SYSTEM MCB2224THY1	5
	INTEL® SERVER SYSTEM MCB2312WHY2.....	6
	INTEL® SERVER SYSTEM MCB2224TAF3	7
	INTEL® SERVER SYSTEM MCB2208WAF4	8
	INTEL® SERVER SYSTEM MCB2208WAF5	9
	RAIL KIT OPTIONS.....	10
	LOCKING FRONT BEZEL ACCESSORY KIT OPTION.....	11
	APPENDIX B – DRIVE INSTALLATION INSTRUCTIONS.....	13

Tables

Table 1. Certified Hard Drives for Hybrid Configurations	3
Table 2. Specified Boot Drives for OS Installation – Certification Requirement	4
Table 3. Intel® Rail Kit Accessory Kit Options.....	10
Table 4. Intel® Locking Front Bezel Accessory Kit Option	11

Figures

Figure 1. Intel® Server System MCB2224THY1 – Multi-Node SATA Hybrid (SAS HDD + SATA SSD).....	1
Figure 2. Intel® Server System MCB2312WHY2 – Single Node SATA Hybrid (SAS HDD + SATA SSD)	1
Figure 3. Intel® Server System MCB2224TAF3 – Multi-Node SATA SSD.....	1
Figure 4. Intel® Server System MCB2208WAF4 – Single Node SATA SSD + NVMe SSD	1
Figure 5. Intel® Server System MCB2208WAF5 – Single Node SATA SSD + NVMe SSD	2
Figure 6. 2U Front Bezel Accessory With Snap-on Options	12
Figure 7. 2U Front Bezel Accessory - ID Badge Option Mechanical Drawings	12
Figure 8. Installing Hot-swap storage devices – 2.5" carrier extraction	13
Figure 9. 2.5" Storage Device Installation – Remove the drive blank.....	13
Figure 10. 2.5" Storage Device Installation – Mounting drive to carrier.....	14
Figure 11. 2.5" Storage Device Installation – Inserting 2.5" drive assembly	14
Figure 12. Installing Hot-swap storage devices – 3.5" carrier extraction.....	15
Figure 13. 3.5" Hard Disk Drive Installation – Remove the drive blank	15
Figure 14. 3.5" Hard Disk Drive Installation – Mounting drive to carrier.....	16
Figure 15. Hard Disk Drive Installation – Inserting 3.5" HDD assembly	16

1 Introduction

The Intel® Data Center Blocks for Cloud (Intel® DCB for Cloud) – Microsoft Windows Server* 2016 includes both single node and multi-node server systems.

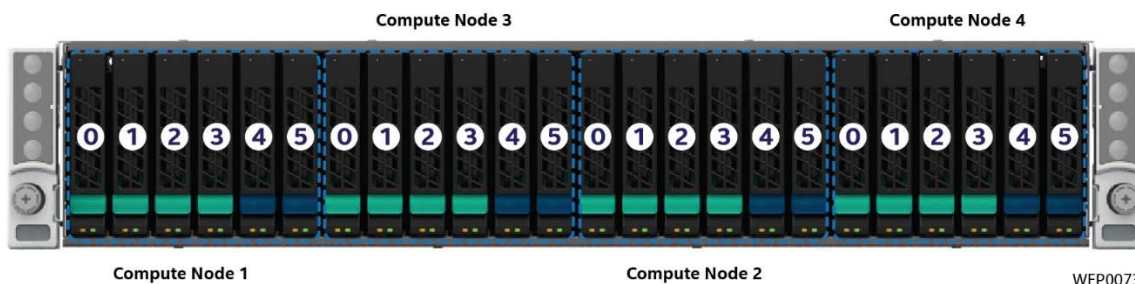

Figure 1. Intel® Server System MCB2224THY1 – Multi-Node SATA Hybrid (SAS HDD + SATA SSD)

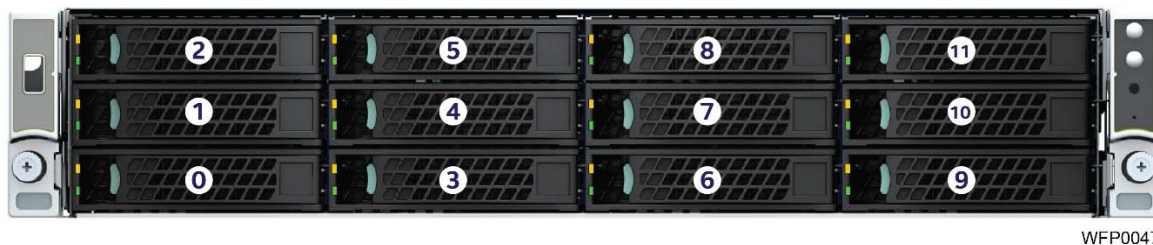

Figure 2. Intel® Server System MCB2312WHY2 – Single Node SATA Hybrid (SAS HDD + SATA SSD)

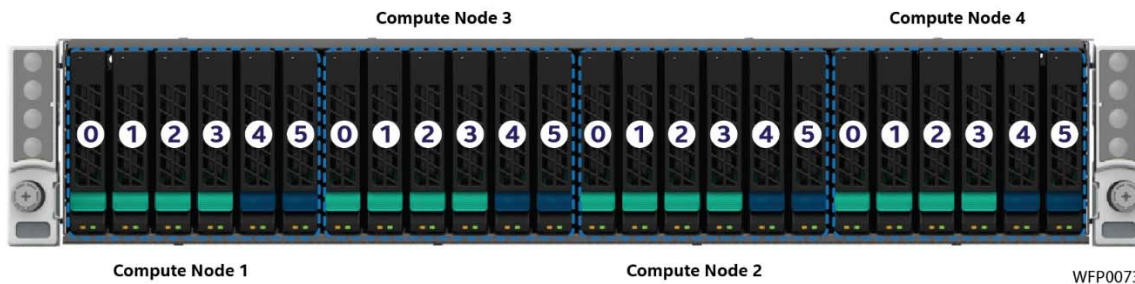

Figure 3. Intel® Server System MCB2224TAF3 – Multi-Node SATA SSD

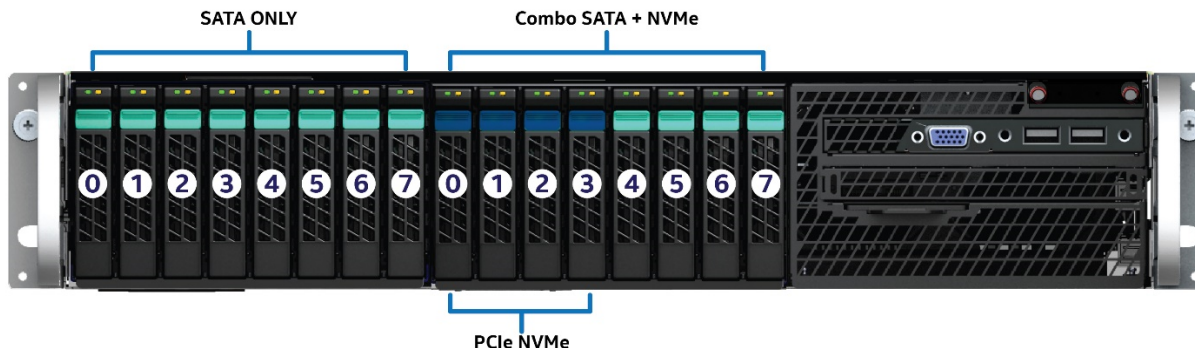

Figure 4. Intel® Server System MCB2208WAF4 – Single Node SATA SSD + NVMe SSD

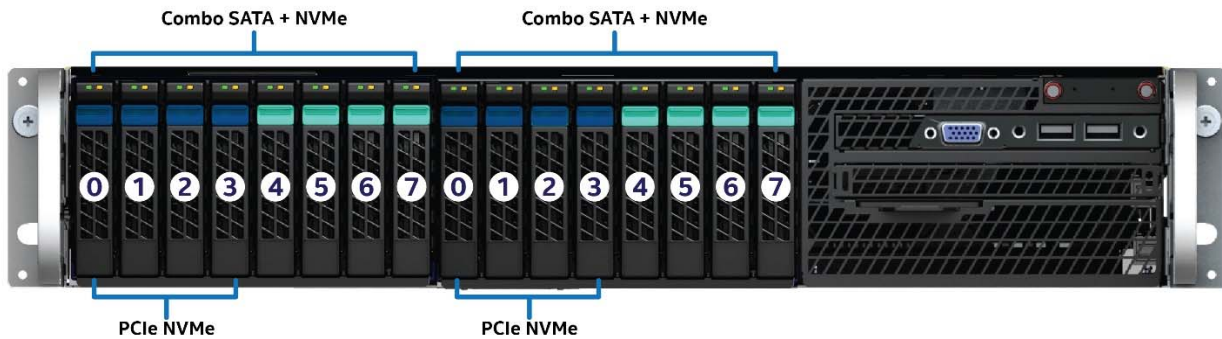

Figure 5. Intel® Server System MCB2208WAF5 – Single Node SATA SSD + NVMe SSD

Server systems within this product family were specifically created to offer Intel customers with pre-configured systems that are Microsoft Windows Server* 2016 certified. Intel has extensively tested these systems to ensure best operation and reliability with the Microsoft Windows operating environment.

To maintain Microsoft Windows Server 2016 certification, no changes can be made to the predefined system configuration. Changing the pre-configured system configuration may invalidate the Microsoft Windows Server 2016 certification performed by Microsoft and Intel.

Changes to the system that may impact Microsoft certification include the following:

- Updating the factory installed system software stack with revisions that are not Microsoft certified. The system software stack includes: system BIOS, BMC Firmware and ME Firmware ¹
- Adding or changing processors
- Adding or changing the system memory
- Adding or changing I/O devices such as add-in PCIe cards or modules
- Adding or changing non-matching (different manufacturer, and/or different model number) storage devices such as Hard Drives and any type of SSDs, than those shipped in the original system configuration ²

Notes:

1 – For its standard server boards and systems, Intel releases updates to the system software stack via System Update Packages (SUP), which can be downloaded from the Intel web site. However, since the Intel® DCB for Cloud server systems are Microsoft certified, the pre-installed system software stack should not be changed unless updated to another system software stack that has passed Microsoft certification for the specified system configuration. Intel customers of Intel® DCB for Cloud server systems should NOT update the system software stack unless a downloaded SUP identifies that it is Microsoft certified for Intel® DCB for Cloud server systems. This information will be communicated via the README file included with every posted SUP for the given server product family.

2 – Adding or swapping like storage devices (Same Manufacturer and Part Number) as shipped in the original system configuration is permitted and will not invalidate the Microsoft certification.

Hard Drives for Hybrid configurations are **not** included and must be purchased separately. Only certified hard drives can be added to hybrid system configuration to maintain Microsoft certification. The following table identifies certified hard drives that can be added to Hybrid system configurations and still maintain Microsoft certification. Intel preinstalls certified boot and cache tier drives in all slots not identified in the table below.

Table 1. Certified Hard Drives for Hybrid Configurations

Model	Vendor	Model Number	Description	Quantity	Install Location
MCB2224THY1	Seagate*	ST2000NX0433	2.5" HDD, 12Gb/s SAS 512E 2TB	16	Slots: CM1: 2, 3, 4, 5 CM2: 2, 3, 4, 5 CM3: 2, 3, 4, 5 CM4: 2, 3, 4, 5
MCB2312WHY2	Seagate	ST4000NM0034	3.5" HDD, 6Gb/s SATA 4TB	8	Slots: 4, 5, 6, 7, 8, 9, 10, 11

See Appendix B for Drive Installation Instructions.

2 Microsoft Windows Server* 2016 Installation Requirements

This section provides information necessary to appropriately install the Microsoft Windows Server 2016 operating environment on to your Intel® DCB for Cloud server system. To maintain and be compliant with the Microsoft Windows Server 2016 certification, the installation steps should be followed as specified. Deviating from the documented OS installation requirements may invalidate the Microsoft Windows Server 2016 certification performed by Microsoft and Intel.

1. Acquire the appropriate Software License from your Microsoft partner or authorized Microsoft distributor/reseller
2. Attach the installation media which holds the Operating System Installation Image to the server system
3. Identify the required boot device. (See Note Below)

NOTE: In order to maintain Microsoft certification for any of the Intel® DCB for Cloud server systems, Microsoft Windows Server 2016 must be installed to a specific storage device within the specific Intel® DCB for Cloud server system configuration. The following table identifies the required boot device to install Microsoft Windows Server 2016 to for each Intel® DCB for Cloud server system configuration.

Table 2. Specified Boot Drives for OS Installation – Certification Requirement

System Model	Storage Device Vendor	Storage Device Model Number	Storage Device Location within the server system
MCB2224THY1 MCB2224TAF3	Intel	Intel® SSD SC P3500 Series (340 GB, 2.5in, M.2)	Installed on the AXXKPTPM2IOM I/O carrier in each node.
MCB2312WHY2 MCB2208WAF4 MCB2208WAF5	Intel	Intel® SSD SC S3710 Series (200 GB, 2.5in, SATA)	Installed in the rear drive bay.

4. Power on the Server and access the <F2> BIOS Setup Utility to configure the primary boot device to the device identified in Step 3.
5. Save Changes and Exit <F2> BIOS Setup Utility
6. Install Microsoft Windows Server 2016 on to the specified boot device
7. Follow the Microsoft Installation wizard
8. After the installation has concluded, restart the server
9. Follow remaining Microsoft instructions to complete your installation

Appendix A - System Configuration Options

Intel® Server System MCB2224THY1

<p>Intel Product Code (iPC): MCB2224THY1</p>  <p>Fully integrated 2U, 4-Node system including: CPUs and Memory and SATA SSDs</p>	<p>Order Information: MM#: 952399 UPC: 735858327169 EAN: 5032037093569</p> <p>Product Type: Fully Integrated Server System Chassis Form Factor: 2U rack mount Chassis Dimensions: L=733mm, W=438mm, H=86.9mm Outer Box Dimensions: L=983mm, W=577mm, H=266mm</p>
<p>Intel product code MCB2224THY1 includes the following:</p> <ul style="list-style-type: none">(1) – 2U Chassis with Quick Reference Label affixed to top cover(1) - Pre-installed Standard Control Panel assembly (board only) – iPC FH2000FPANEL2(1) - Power Distribution Board – iPC FXXCRPSPDB2(1) – Power Interposer Board – iPC FXXCRPSPIB(2) - 1600W 80 PLUS Platinum PSUs – iPC FXX1600PCRPS(1) – 24 x 2.5 Drive bay with 24 hot swap drive carriers and drive blanks (6 drive carriers per node), includes:<ul style="list-style-type: none">• (1) 12 Gb SAS/SATA backplane – iPC FHW24X25HS12G• (16) 2.5" hot swap drive carriers (Green Button)– iPC FXX25HSCAR2• (8) 2.5" hot swap drive carriers – (Blue Button)(1) – Basic rack rail – iPC AXXELVRAIL <p>NOTE: The rail kit only supports specific rack type with 3/8" square and 7.1mm round holes</p> <ul style="list-style-type: none">(8) – DIMM slot blanks – iPN H43597-00x(2) – Chassis handles (1 set) installed – iPN H19171-00x(2) – AC Power Cord retention strap assembly – iPN H23961-00x <p>Spares for each screw type included</p> <ul style="list-style-type: none">(4) – Compute Modules w/TPM – iPC HNS2600TP24STR(8) – Intel® Xeon® Processor E5-2620 v4 – 2.1 GHz - iPC CM8066002032201(8) – CPU heatsinks – iPC FXXCA84X106HS(4) – Intel® Remote Management Module Lite 2 accessory key – iPC AXXRMM4LITE2(32) – Micron* RDIMM 16GB – DDR4, 288-pin, 2400MHz (8 DIMMs per node/32 DIMMs per system) - MTA36ASF2G72PZ-2G3B1(4) – Intel® SSD DC S3500 Series (340 GB, 2.5in, M.2) – (Boot Drive) - iPC SSDSCKHB340G401(8) – Intel® SSD DC S3710 Series (400 GB, 2.5in, SFF) – (Cache Tier) - iPC SSDSC2BA400G401 <p>The following components are system certified ingredients that are customer supplied and do not ship with the Intel® DCB for Cloud server system purchase:</p> <ul style="list-style-type: none">(16) – Seagate* 2TB SAS 2.5" HDD – ST2000NX0433	

NOTE: Systems shipped to the US & Canada will include two North American power cords.

For a complete list of available FRU replacement parts, refer to the Intel® Server Board S2600TP Product Family Configuration Guide at the following Intel web site:

<http://www.intel.com/content/www/us/en/motherboards/server-motherboards/server-board-s2600tp.html?wapkw=s2600tp&wapkwg=featured>

Intel® Server System MCB2312WHY2

<p>Product Code (iPC): MCB2312WHY2</p>  <p>Fully integrated 2U, 1-Node system including: CPUs, Memory and SATA SSDs</p>	<p>Order Information MM#: 952397 UPC: 735858327190 EAN: 5032037093590</p> <p>Product Type: Fully Integrated Server System Chassis Form Factor: 2U rack mount Chassis Dimensions: L=712mm, W=439mm, H=89mm Outer Box Dimensions: L=983mm, W=577mm, H=260mm</p>
<p>Intel product code MCB2312WHY2 includes the following:</p> <p>(1)– 2U Chassis with Quick Reference Label affixed to top cover (1) – Intel® Server Board S2600WT w/ Dual 1GbE – iPC S2600WT2R (1) – Air duct (6) – Hot swap system fans – iPC FR2UFAN60HSW (2) – Chassis Handles (1 set) installed, with Integrated control panel & USB Port - iPC A2UHANDLKIT (1) – 12 x 3.5" Drive bay with 12 hot swap drive carriers and drive blanks, includes:<ul style="list-style-type: none">• (1) 12 Gb SAS backplane – iPC F2U12X35S3HSBP – (SAS Data cables sold separately)• (12) 3.5" hot swap drive carriers (Green Button) – iPC FXX35HSCAR(1) – Backplane I2C cable – iPN G92510-00x (1) – Backplane power cable – iPN G92685-00x (1) – Internal fixed mount SSD power cable – iPN H23901-00x (2) – CPU heatsinks – iPC FXXCA84X106HS (16) – DIMM slot blanks – iPN G75158-00x (2) – Riser Card mounting brackets supporting up to 3 riser cards<ul style="list-style-type: none">• Includes (2) 3-slot PCIe* riser cards – iPC A2UL8RISER2(2) – 1100W 80 PLUS Platinum AC Power Supply Module – iPC AXX1100PCRPS (1) – 3x RMFBU Mounting Bracket – iPN H18238-00x (2) – AC Power Cord retention strap assembly – iPN H23961-00x Spares for each screw type included</p> <p>(1) - Rear Hot-Swap Dual Drive Cage Upgrade Kit – iPC A2UREARHSDK (2) – Intel® Xeon® Processor E5-2660 v4 – 2.0 GHz – iPC CM8066002031201 (1) – Intel® Remote Management Module Lite 2 accessory key – iPC AXXRMLITE2 (1) – TPM Module 2.0 (TPM6) – iPC AXXTPE6 (1) – Intel® RAID Expander – iPC RES3FV288 (1) – Intel® RAID Controller(IT Mode) – iPC RS3UC080J (1) – Mellanox* RDMA NIC – 2x10GB SFP+ - MCX312B-XCCT (16) – Micron* RDIMM 16GB – DDR4, 288-pin, 2400MHz - MTA36ASF2G72PZ-2G3B1 (4) - Intel® SSD DC S3710 Series (800 GB, 2.5in, SFF) – (Cache Tier) – iPC SSDSC2BA800G401 (1) - Intel® SSD DC S3710 Series (200 GB, 2.5in, SATA) – (Boot Device) – iPC SSDSC2BA200G401 (1) – Cable Kit – iPC AXXCBL800HDHD (1) – Cable Kit – iPC AXXCBL875HDHD (1) – Cable Kit – iPC AXXCBL950HDHD</p> <p>The following components are system certified ingredients that are customer supplied and do not ship with the Intel® DCB for Cloud server system purchase:</p> <p>(8) – Seagate* 4TB SAS 3.5" HDD - ST4000NM0034</p>	

NOTE: Systems shipped to the US & Canada will include two North American power cords.

For a complete list of available FRU replacement parts, refer to the Intel® Server Board S2600WT Product Family Configuration Guide at the following Intel web site:

<http://www.intel.com/content/www/us/en/motherboards/server-motherboards/server-board-s2600wt.html?wapkw=s2600wt&wapkgw=featured>

Intel® Server System MCB2224TAF3

<p>Product Code (iPC): MCB2224TAF3</p>  <p>Fully integrated 2U, 4-Node system including: CPUs, Memory and SATA SSDs</p>	<p>Order Information MM#: 952398 UPC: 735858327176 EAN: 5032037093576</p> <p>Product Type: Fully Integrated Server System Chassis Form Factor: 2U rack mount Chassis Dimensions: L=733mm, W=438mm, H=86.9mm Outer Box Dimensions: L=983mm, W=577mm, H=266mm</p>
<p>Intel product code MCB2224TAF3 includes the following:</p> <p>(1) – 2U Chassis with Quick Reference Label affixed to top cover (1) - Pre-installed Standard Control Panel assembly (board only) – iPC FH2000FPANEL2 (1) - Power Distribution Board – iPC FXXCRPSPDB2 (1) – Power Interposer Board – iPC FXXCRPSPIB (2) - 1600W 80 PLUS Platinum PSUs – iPC FXX1600PCRPS (1) – 24 x 2.5" Drive bay with 24 hot swap drive carriers and drive blanks (6 drive carriers per node), includes:<ul style="list-style-type: none">• (1) 12 Gb SAS/SATA backplane – iPC FHW24X25HS12G• (16) 2.5" hot swap drive carriers (Green Button) – iPC FXX25HSCAR2• (8) 2.5" hot swap drive carriers – (Blue Button) (1) – Basic rack rail – iPC AXXELVRAIL NOTE: The rail kit only supports specific rack types with 3/8" square and 7.1mm round holes (8) – DIMM slot blanks – iPN H43597-00x (2) – Chassis handles (1 set) installed – iPN H19171-00x (2) – AC Power Cord retention strap assembly – iPN H23961-00x Spares for each screw type included</p> <p>(4) – Compute Modules w/TPM – iPC HNS2600TP24STR (8) – Intel® Xeon® Processor E5-2650 v4 – 2.2 GHz - iPC CM8066002031103 (8) – CPU heatsinks – iPC FXXCA84X106HS (4) – Intel® Remote Management Module Lite 2 accessory key – iPC AXXRMM4LITE2 (64) – Micron* RDIMM 16GB – DDR4, 288-pin, 2400MHz (16 DIMMs per node/64 DIMMs per system) - MTA36ASF2G72PZ-2G3B1 (16) – Intel® SSD DC S3520 Series (1.6TB, 2.5in, SFF) – (Capacity Tier) - iPC SSDSC2BB016T7ES (4) – Intel® SSD DC S3500 Series (340 GB, 2.5in, M.2) – (Boot Drive) - iPC SSDSCKHB340G401 (8) – Intel® SSD DC P3700 Series (400 GB, 2.5in, SFF) (Cache Tier) - iPC SSDPE2MD400G401 (4) – Mellanox* RDMA NIC, 2x10GB SFP+ - MCX312B-XCCT</p>	

NOTE: Systems shipped to the US & Canada will include two North American power cords.

For a complete list of available FRU replacement parts, refer to the Intel® Server Board S2600TP Product Family Configuration Guide at the following Intel web site:

<http://www.intel.com/content/www/us/en/motherboards/server-motherboards/server-board-s2600tp.html?wapkw=s2600tp&wapkwg=featured>

Intel® Server System MCB2208WAF4

Product Code (iPC): MCB2208WAF4



**Fully Integrated 2U, 1-Node system including:
CPUs, Memory and SATA + NVMe SSDs**

Order Information

MM#: 952639
UPC: 735858327206
EAN: 5032037093606

Product Type: Fully Integrated Server System
Chassis Form Factor: 2U rack mount
Chassis Dimensions: L=712mm, W=439mm, H=89mm
Outer Box Dimensions: L=983mm, W=577mm, H=260mm

Intel product code MCB2208WAF4 includes the following:

- (1) – 2U Chassis with Quick Reference Label affixed to top cover
 - (1) – Intel® Server Board S2600WT w/ Dual **1GbE** – iPC **S2600WT2R**
 - (2) – 1100W 80 PLUS Platinum AC Power Supply Modules – iPC **AXX1100PCRPS**
 - (2) – AC Power Cord retention strap assembly – iPN H23961-00x
 - (2) – PCIe Riser card brackets
 - Includes (2) 3-slot PCIe* riser cards – iPC **A2UL8RISER2**
 - Includes (1) 2-slot low profile PCIe* riser card – iPC **A2UX8X4RISER**
 - (1) – Air duct
 - (6) – Hot swap system fans – iPC **FR2UFAN60HSW**
 - (1) – Standard control panel assembly (board only – iPC **FXXFPANEL**)
 - (1) – Front I/O Panel assembly (1 x VGA and 2 x USB)
 - (1) – SATA Optical drive bay with filler panel – (optical drive sold separately)
 - Includes optical drive mounting latch kit – iPN H19168-00x
 - Includes 300mm optical drive / internal mount SSD power cable – iPN H23901-00x
 - (1) – 8 x 2.5" Drive bay with 8 hot swap drive carriers and drive blanks, includes:
 - (1) 12Gb SAS backplane – iPC **A2U8X25S3HSDK**
 - (8) 2.5" hot swap drive trays (Green Button) – iPC **FXX25HSCAR2**
 - (2) – Multiport 730mm SAS/SATA data cables – iPC **AXXCBL730HDHD**
 - (1) – Backplane 250mm I2C cable – iPN G41809-00x
 - (1) – Backplane power cable – iPN H23927-00x
 - (2) – CPU heatsinks – iPC **FXXCA84X106HS**
 - (8) – DIMM slot blanks – iPN G75158-00x
 - (2) – Chassis handle (1 set) installed – iPN H18229-xxx
 - (1) – 3x RMFBU Mounting Bracket – iPN H18238-00x
- Spares for each screw type included
- (1) – 2U Drive Cage Upgrade Kit (4x NVMe) (8x 2.5") – iPC **A2U44X25NVMEDK**
 - (4) 2.5" hot swap drive carriers (Green Button) – iPC **FXX25HSCAR2**
 - (4) 2.5" hot swap drive carriers (Blue Button)
 - (1) - Rear Hot-Swap Dual Drive Cage Upgrade Kit – iPC **A2UREARHSDK**
 - (2) – Intel® Xeon® Processor E5-2680 v4 – 2.4 GHz – iPC **CM8066002031501**
 - (2) – CPU heatsinks – iPC **FXXCA84X106HS**
 - (1) – Intel® Remote Management Module Lite 2 accessory key – iPC **AXXRMLITE2**
 - (1) – TPM Module 2.0 (TPM6) – iPC **AXXTPME6**
 - (1) – Intel® RAID Expander – iPC **RES3TV360**
 - (1) – Intel® RAID Controller(IT Mode) – iPC **RS3UC080J**
 - (1) – Mellanox® RDMA NIC – 2x10GB SFP+ - **MCX312B-XCCT**
 - (16) – Micron® RDIMM 16GB – DDR4, 288-pin, 2400MHz - **MTA36ASF2G72PZ-2G3B1**
 - (2) - Intel® SSD DC P3700 Series (800 GB, 2.5in, U.2/NVMe) – (Cache Tier) – iPC **SSDPE2MD800G401**
 - (1) - Intel® SSD DC S3710 Series (200 GB, 2.5in, SATA) – (Boot Device) – iPC **SSDSC2BA200G401**
 - (12)- Intel® SSD DC S3520 Series (1.2 TB, 2.5in, SATA) – (Capacity Tier) – iPC **SSDSC2BB012T7ES**

NOTE: Systems shipped to the US & Canada will include two North American power cords.

For a complete list of available FRU replacement parts, refer to the Intel® Server Board S2600WT Product Family Configuration Guide at the following Intel web site:

<http://www.intel.com/content/www/us/en/motherboards/server-motherboards/server-board-s2600wt.html?wapkw=s2600wt&wapkwg=featured>

Intel® Server System MCB2208WAF5

Product Code (iPC): MCB2208WAF5



**Fully Integrated 2U, 1-Node system including:
CPUs, Memory and SATA + NVMe SSDs**

Order Information

MM#: 952638
UPC: 735858327183
EAN: 5032037093583

Product Type: Fully Integrated Server System
Chassis Form Factor: 2U rack mount
Chassis dimensions: L=712mm, W=439mm, H=89mm
Outer Box Dimensions: L=983mm, W=577mm, H=260mm

Intel product code MCB2208WAF5 includes the following:

- (1) – 2U Chassis with Quick Reference Label affixed to top cover
 - (1) – Intel® Server Board S2600WT w/ Dual **1GbE** – iPC **S2600WT2R**
 - (2) – 1100W 80 PLUS Platinum AC Power Supply Modules – iPC **AXX1100PCRPS**
 - (2) – AC Power Cord retention strap assembly – iPN H23961-00x
 - (2) – PCIe Riser card brackets
 - Includes (2) 3-slot PCIe* riser cards – iPC **A2UL8RISER2**
 - Includes (1) 2-slot low profile PCIe* riser card – iPC **A2UX8X4RISER**
 - (1) – Air duct
 - (6) – Hot swap system fans – iPC **FR2UFAN60HSW**
 - (1) – Standard control panel assembly (board only – iPC **FXXFPANEL**)
 - (1) – Front I/O Panel assembly (1 x VGA and 2 x USB)
 - (1) – SATA Optical drive bay with filler panel – (optical drive sold separately)
 - Includes optical drive mounting latch kit – iPN H19168-00x
 - Includes 300mm optical drive / internal mount SSD power cable – iPN H23901-00x
 - (2) – 8 x 2.5" Drive bays with 8 hot swap drive carriers and drive blanks, includes:
 - (1) 12Gb SAS backplane – iPC **A2U8X25S3HSDK**
 - (2) – Multiport 730mm SAS/SATA data cables – iPC **AXXCBL730HDHD**
 - (1) – Backplane 250mm I2C cable – iPN G41809-00x
 - (1) – Backplane power cable – iPN H23927-00x
 - (2) – CPU heatsinks – iPC **FXXCA84X106HS**
 - (8) – DIMM slot blanks – iPN G75158-00x
 - (2) – Chassis handle (1 set) installed – iPN H18229-xxx
 - (1) – 3x RMFBU Mounting Bracket – iPN H18238-00x
- Spares for each screw type included
- (2) – 2U Drive Cage Upgrade Kit (4x NVMe) (8 x 2.5") – iPC **A2U44X25NVMEDK2**
 - Includes (8) 2.5" hot swap drive bays (Green Button) – iPC **FXX25HSCAR2**
 - Includes (8) 2.5" hot swap drive bays (Blue Button)
 - (1) – Rear Hot-Swap Dual Drive Cage Upgrade Kit – iPC **A2UREARHSDK**
 - (2) – Intel® Xeon® Processor E5-2695 v4 – 2.1 GHz – iPC **CM8066002023801**
 - (2) – CPU heatsinks – iPC **FXXCA84X106HS**
 - (1) – Intel® Remote Management Module Lite 2 accessory key – iPC **AXXRMLITE2**
 - (1) – TPM Module 2.0 (TPM6) – iPC **AXXTPME6**
 - (1) – Mellanox* RDMA NIC – 2x40GB QSFP - **MCX314A-BCCT**
 - (24) – Micron* RDIMM 16GB – DDR4, 288-pin, 2400MHz - **MTA36ASF2G72PZ-2G3B1**
 - (2) – Intel® SSD DC P3700 Series (800 GB, 2.5in, U.2/NVMe) – (Cache Tier) – iPC **SSDPE2MD800G401**
 - (1) – Intel® SSD DC S3710 Series (200 GB, 2.5in, SATA) – (Boot Device) – iPC **SSDSC2BA200G401**
 - (6) – Intel® SSD DC P3520 Series (2TB, 2.5in, U.2/NVMe) – (Capacity Tier) – iPC **SSDPE2MX020T701**
 - (1) – Cable Kit – iPC **AXXCBL800HDHD**

NOTE: Systems shipped to the US & Canada will include two North American power cords.

For a complete list of available FRU replacement parts, refer to the Intel® Server Board S2600WT Product Family Configuration Guide at the following Intel web site:

<http://www.intel.com/content/www/us/en/motherboards/server-motherboards/server-board-s2600wt.html?wapkw=s2600wt&wapkwg=featured>

Rail Kit Options

To install a rack mount server system into a rack, a rail mounting kit must be installed.

Intel® DCB for Cloud server system models **MCB2224THY1** and **MCB2224TAF3** include the following Intel Rail Kit option in the shipping product: Intel® Enhanced Value Rail Kit **AXXELVRAIL**. Supported premium feature rail kits must be ordered separately. Available premium feature rail kits are listed in the following table.

All other available Intel® DCB for Cloud server system models do not include rail kits in the shipping product. Rail kits for these systems must be ordered separately. All supported rail kits are listed in the following table.

Table 3. Intel® Rail Kit Accessory Kit Options

iPC – Intel Product Code	Product Order Information	Product Details
iPC – AXXELVRAIL 	MM# – 920970 UPC – 00735858244367 EAN – 5032037038980 MOQ - 1	Enhanced Value Rail Kit <ul style="list-style-type: none"> Works for all 438mm wide Intel® Rack Chassis 1U, 2U, 4U Adjustment within 609.6mm~765mm to fit difference depth rack 424.2mm maximum travel length 2/3 extension from rack 130 lbs (59 kgs) max support weight Tool-less chassis attach Tools required to attach to rails to rack Note: No Cable Management Arm (CMA) support.
iPC - AXXSHRTRAIL	MM# – 939210 UPC – 00735858291996 EAN – 5032037070553 MOQ – 1	2U+ Premium quality rails with no CMA support. <ul style="list-style-type: none"> Travel distance 780mm Tool-less installation Full extension from rack Max support weight - TBD Kit includes: Rails, screws, installation manual
iPC – AXXFULLRAIL	MM# –939209 UPC –00735858291989 EAN –5032037070546 MOQ – 1	2U+ Premium quality rails with CMA support. <ul style="list-style-type: none"> Travel distance 780mm Tool-less installation Full extension from rack Max support weight - TBD Kit includes: Rails, screws, installation manual For Cable Management arm – order iPC AXXCMA2
iPC – AXXCMA2	MM# – 939211 UPC –00735858292009 EAN –5032037070560 MOQ – 1	Cable management arm <ul style="list-style-type: none"> Compatible with AXXFULLRAIL only

Advisory Note: Available rack and cabinet mounting kits are not designed to support shipment of the server system while installed in a rack. If you chose to do so, Intel advises you verify your shipping configuration with appropriate shock and vibration testing before shipment. Intel does not perform shipping tests which cover the complex combination of unique rack offerings and custom packaging options.

Caution: Exceeding the specified maximum weight limit of a given rail kit or misalignment of the server in the rack may result in failure of the rack rails, causing damage to the system or personal injury. Using two people or the use of a mechanical assist tool to install and align the server into the rack is highly recommended.

Locking Front Bezel Accessory Kit Option

The optional front bezel is made of Black molded plastic and uses a snap-on design. When installed, its design allows for maximum airflow to maintain system cooling requirements. The front bezel includes a keyed locking mechanism which can be used to prevent unauthorized access to installed storage devices and front I/O ports.

Table 4. Intel® Locking Front Bezel Accessory Kit Option

iPC - Intel Product Code	Product Order Information	Product Details
<p>iPC – A2UBEZEL</p> 	<p>MM# – 918086 UPC – 735858241137 EAN – 5032037035880 MOQ – 1</p>	<p>2U Front Bezel Accessory Kit Kit Includes: (1) 2U locking bezel (1) Front Panel Window Insert (1 Set) Bezel branding inserts – two ID badges, one wave (1 Set) Keys</p>

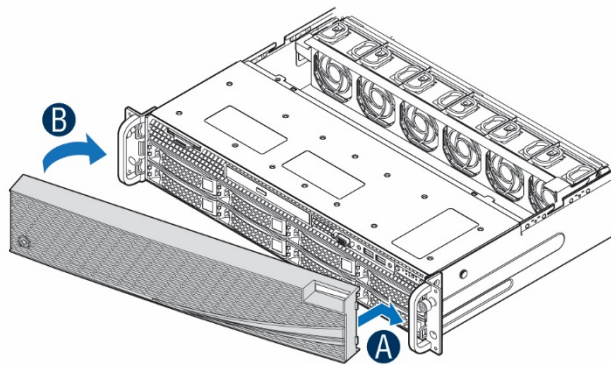

AF006243

The face of the bezel assembly includes snap-in identification badge options and a wave feature option to allow for customization.

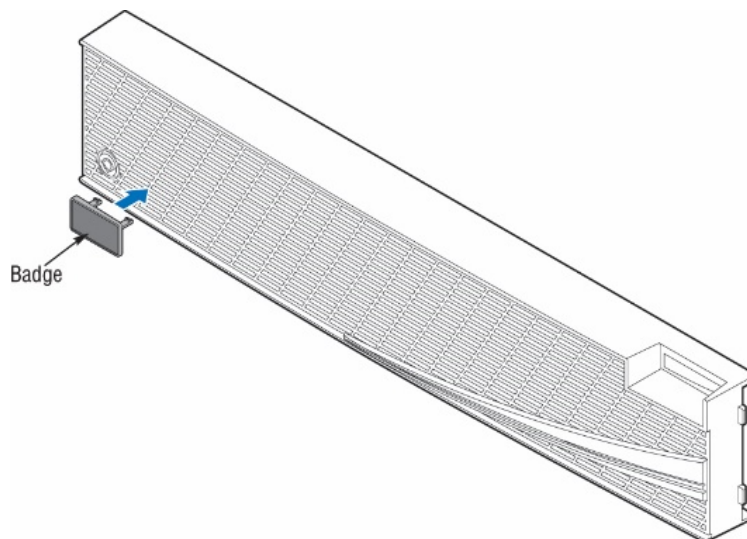

AF005159

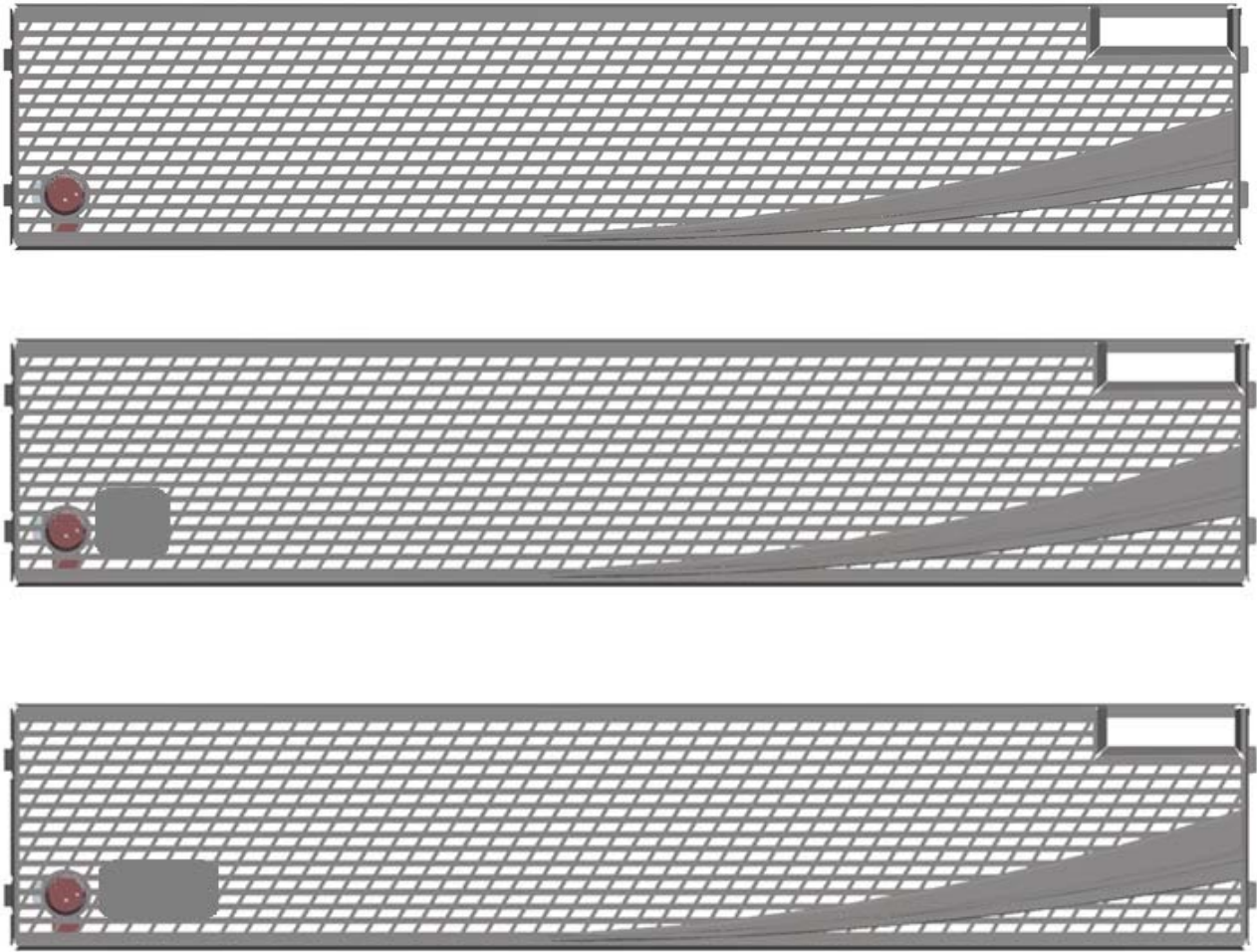

Figure 6. 2U Front Bezel Accessory With Snap-on Options

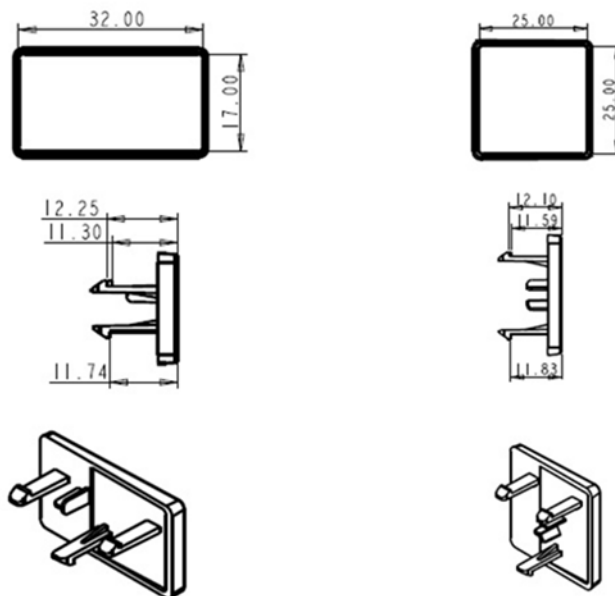

Figure 7. 2U Front Bezel Accessory - ID Badge Option Mechanical Drawings

Appendix B – Drive Installation Instructions

NOTE: To maintain proper system cooling, all externally accessible drive bays must be populated with a drive carrier. Each drive carrier must have a hard disk drive (HDD), Solid State Device (SSD), or a supplied drive blank installed.

2.5" Drive Carriers

2.5" Drive Carrier Extraction

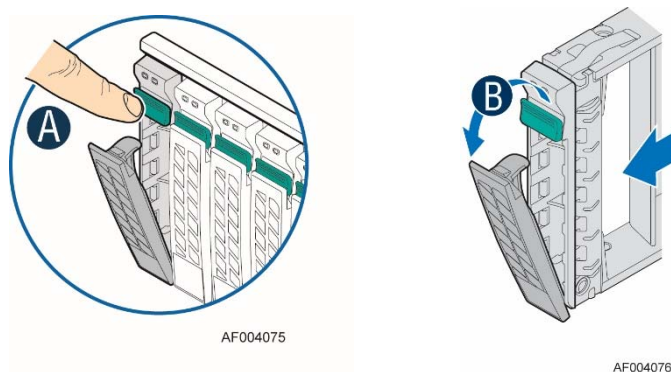

Figure 8. Installing Hot-swap storage devices – 2.5" carrier extraction

- Remove the drive carrier from the chassis by pressing the green button and pulling open the lever (see letter 'A')
- Pull the carrier out of the drive bay (see letter 'B')

2.5" Hard Disk Drive (HDD) / Solid State Device (SSD) Installation

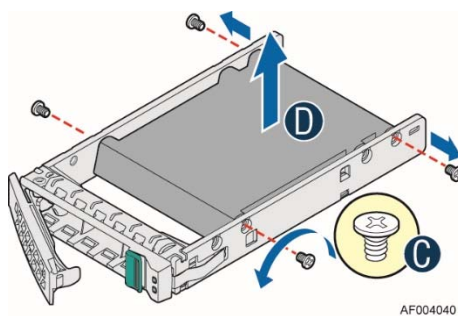

Figure 9. 2.5" Storage Device Installation – Remove the drive blank

- Remove the four screws securing the plastic drive blank to the carrier (see letter 'C')
- Remove the drive blank from the carrier (see letter 'D')

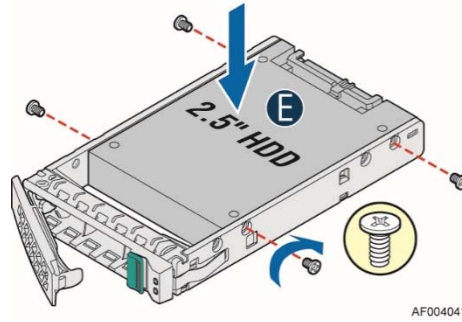

Figure 10. 2.5" Storage Device Installation – Mounting drive to carrier

- Install the storage device into the carrier. Verify the connector end of the drive is located towards the back of the carrier (see letter 'E').
- Secure the drive to the carrier using four screws

2.5" Drive Carrier Insertion

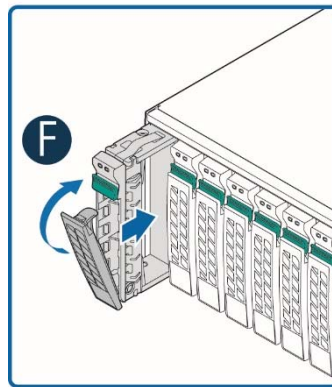

Figure 11. 2.5" Storage Device Installation – Inserting 2.5" drive assembly

- With the lever open, insert the drive assembly into the chassis
- Push in the lever to lock it into place (see letter 'F')

3.5" Drive Carriers

3.5" Drive Carrier Extraction

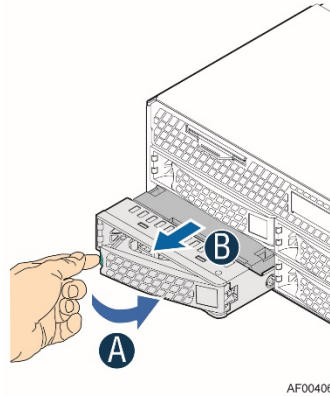

Figure 12. Installing Hot-swap storage devices – 3.5" carrier extraction

- Remove the drive carrier from the chassis by pressing the green button and pulling open the lever (see letter 'A')
- Pull the carrier out of the drive bay (see letter 'B')

3.5" Hard Disk Drive Installation

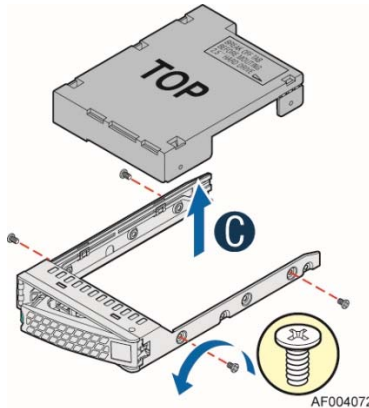

Figure 13. 3.5" Hard Disk Drive Installation – Remove the drive blank

- Remove the four screws securing the plastic drive blank to the carrier
- Remove the drive blank from the carrier (see letter 'C')

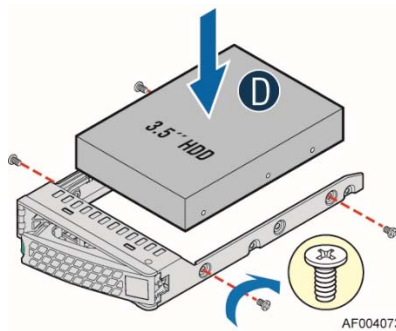

Figure 14. 3.5" Hard Disk Drive Installation – Mounting drive to carrier

- Install the drive into the carrier. Verify the connector end of the drive is located towards the back of the carrier (see letter 'D')
- Secure the drive to the carrier using four screws

3.5" Drive Carrier Insertion

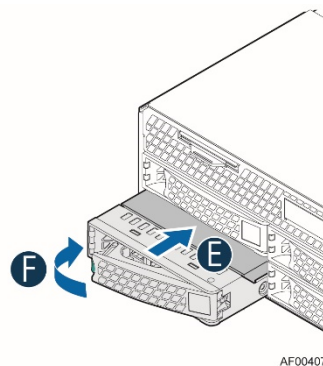

Figure 15. Hard Disk Drive Installation – Inserting 3.5" HDD assembly

- With the lever open, insert the drive assembly into the drive bay (see letter 'E')
- Push in the lever to lock it into place (see letter 'F')