

Contents

Getting started

Appearance	1
Pairing and connecting	1
Wearing the watch	2
Buttons and gestures	3
Syncing your HUAWEI ID	5
Gestures	5
Measuring your body temperature	6
Emergency SOS	7
Connecting your watch to the Internet	7
Charging	9

Calling

Support for the eSIM service	11
Activating the eSIM service	11
Changing the eSIM Service	13
Changing the eSIM number or the watch	13
Using your watch to make calls	13

Health management

Heart rate measurement	15
Measuring blood oxygen levels (SpO2)	17
Tracking sleep	17
Testing stress levels	18
Breathing exercises	19
Activity reminder	19
Adding emergency information	20

Workout modes

Starting a workout	21
Running courses	21
Creating a training plan	21
Smart companion	22
Route back	22
Viewing workout records	22
Workout status	23
Recording daily activities	23
Auto-detecting workouts	23

Handy features

Assistant·TODAY	24
Remote shutter	24

Voice notes	24
Voice assistant	25
Connecting to Bluetooth earphones	26
Music	27
Viewing the calendar	27
Using alarms	28
Viewing weather information	28
Compass	29
Stopwatch	29
Timers	29
Barometer	30
Finding your phone	30

More guides

Managing apps	31
Adjusting and changing the strap	32
Setting time and language	33
Managing watch faces	33
Configuring Gallery	34
Using Huawei Share OneHop for watch faces	35
Locking or unlocking the watch	35
Sound settings	36
Adjusting the screen brightness	36
Customizing the function of the Down button	37
Ultra-long Battery Life mode	37
Accessibility operations	37
Watch updates	38
Powering on and off, restarting, and restoring to factory settings	38
Viewing the Bluetooth name, MAC address, SN, model, and version number	39
Cleaning and maintenance	39

Getting started

Appearance

The watch adopts a combination of pressable buttons, a rotatable Up button, and a color touchscreen. The color touchscreen provides a broader field of view and the rotatable Up button allows for more convenient operations.

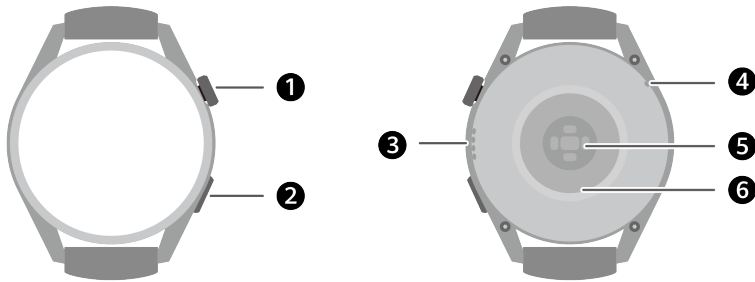

Table 1-1 Items on the watch

No.	Item
1	Up button
2	Down button
3	Speaker
4	Microphone
5	Monitoring unit area
6	Charging area

Pairing and connecting

The device is ready to be paired via Bluetooth by default after it is powered on for the first time. Download and install the latest version of the Health app.

- i** Ensure that you are using one of the following devices on which Bluetooth and location services have been enabled:

Phones: HarmonyOS 2/Android 6.0/iOS 9.0 or later

HarmonyOS/Android users

- 1 Open the Health app and go to **Devices > ADD**. The app will then automatically search for the devices that it can connect to. Touch the **LINK** next to the target device and follow the onscreen instructions to finish pairing.
 - i** If the target device is not in the list of devices that can be connected to automatically, touch **ADD**, select the target device, touch **PAIR**, and follow the onscreen instructions to finish pairing.

- 2 When a pairing request is displayed on the device screen, touch ✓ to start pairing. Confirm the pairing on your phone as well.

iOS users

- 1 Open the Health app, go to **Device** > **ADD**, select the device you want to pair with, and touch **PAIR**.
 - 2 For some device models, you need to pair your device with the phone via Bluetooth. Follow the onscreen instructions to select your device from the Bluetooth settings screen. When a pairing request is displayed on your device, touch ✓. After the pairing is complete, touch **Next**.
 - 3 Open the Health app, touch **Next**, and follow the onscreen instructions to finish pairing.
- Your device will display an icon on the screen to inform you that pairing was successful. It will then return to the home screen and receive information (such as the date and time). Otherwise, your device will display an icon on the screen to inform you that pairing was unsuccessful. It will then return to the startup screen.

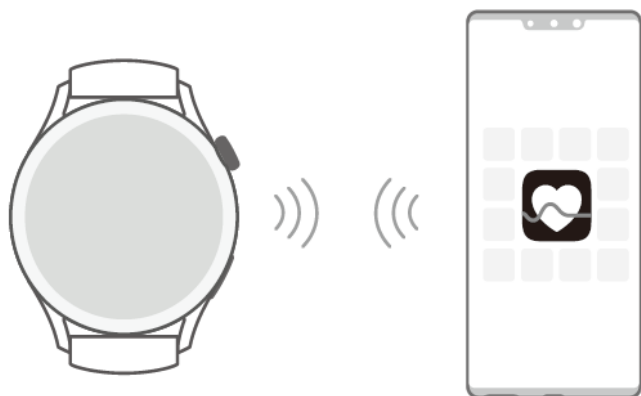

Wearing the watch

Ensure that the rear cover of the watch is clean, dry, and free of foreign objects. Attach the monitoring area of the watch to your wrist and make sure it feels comfortable. Do not attach a protective film to the rear of the watch. The rear cover of the watch has sensors that can identify signals from the human body. If the sensors are blocked, the identification will be inaccurate or fail and the watch won't be able to record the heart rate, SpO2, and sleep data. To ensure the accuracy of measurements, avoid wearing the strap more than one finger width away from your wrist bone. Ensure that the strap is worn relatively tightly and ensure it is secure during workouts.

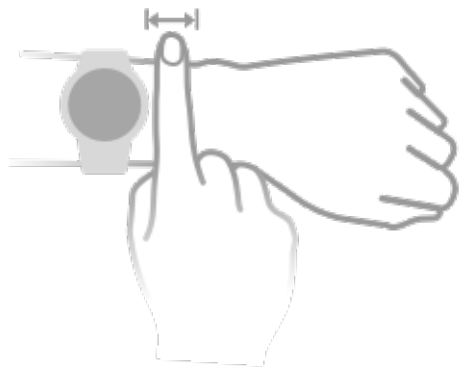

- i** • The device is made of materials that are safe to use. If you experience skin discomfort when wearing the device, take it off and consult a doctor.

Buttons and gestures

The watch is equipped with a color touchscreen that is highly touch-responsive and can be swiped in different directions.

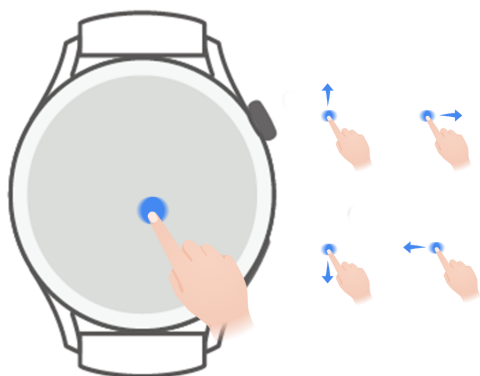

Up button

Operation	Function	Remarks
Rotate	<ul style="list-style-type: none"> In Grid mode, zoom in and out on an app on the app list screen. In List mode, swipe up and down on the app list screen or the details screen. Scroll up and down the screen after you enter an app. <p>i Go to Settings > Watch face & launcher > Launcher and then select Grid or List.</p>	There are certain exceptions such as for calls and workouts.
Press	<ul style="list-style-type: none"> Turn on the screen. Open the app list screen from the home screen. Return to the home screen. 	

Operation	Function	Remarks
Double-press or press multiple times	<ul style="list-style-type: none"> • Double-press the button to view all running apps when the screen is on. • Press five times consecutively to launch emergency SOS. 	
Press and hold	<ul style="list-style-type: none"> • Power on the watch. • Access the restart/power-off screen when the watch is powered on. • Forcibly restart the watch by pressing and holding the button for more than 12 seconds. 	



Down button

Operation	Function	Remarks
Press	<ul style="list-style-type: none"> • Open the Workout app. • Access the set customized feature. 	There are certain exceptions such as for calls and workouts.
Press and hold	<ul style="list-style-type: none"> • Wake up the voice assistant. 	-

Gestures

Operation	Function
Touch	Confirm your selection.
Touch and hold	Change the watch face.
Swipe up	View notifications.
Swipe down	View the shortcut menu.
Swipe left or right	View watch feature cards.
Swipe right	Return to the previous screen.

Turning on the screen

- Press the Up button.
- Raise or rotate your wrist inwards.
 -  To turn on the screen by raising your wrist, open the watch's app list, go to **Settings** > **Accessibility features** > **Gestures**, and enable **Raise to wake**.
- Swipe down on the home screen to open the shortcut menu. Enable **Show Time** for the screen to stay on for five minutes.
 -  Go to **Settings** > **Display & Brightness** > **Screen time** and set a different duration for the screen to stay on.

Turning off the screen

Perform no operations for a period of time after you turn on the screen by pressing the button or raising your wrist.

Cover the entire screen to turn off the screen.

- Go to **Settings > Display & Brightness > Sleep** and set a duration for the screen to stay off.
- Go to **Settings > Watch face & launcher** and enable **Always On Display**. The watch face and some app screens will stay on.

Syncing your HUAWEI ID

Sync your HUAWEI ID from your phone to the watch. You will then be able to use apps such as HUAWEI Music, and MeeTime on your watch. Before syncing, sign in to the Health app and finish pairing. During syncing, the watch and phone must be connected and the network connection must be working normally.

After you finish pairing, your HUAWEI ID will be automatically synced to your watch. You can also go to **Settings > Account > Sync** to sync your HUAWEI ID from your phone to the watch.

- HUAWEI ID syncing is not supported on an iOS phone.
- After pairing is completed for the first time, touch **Agree** to automatically sync your HUAWEI ID to the watch.

Gestures

Gesture tutorials

To avoid misoperations, open the watch's app list, go to **Settings > Accessibility features > Gestures**, touch **Tutorials**, and select the desired gesture tutorial.

Answering a call

Open the watch's app list, go to **Settings > Accessibility features > Gestures**, and touch **Answer calls gesture**.

After this feature is enabled, with the screen facing up and your palm facing down, quickly clench and release your fist to answer a call.

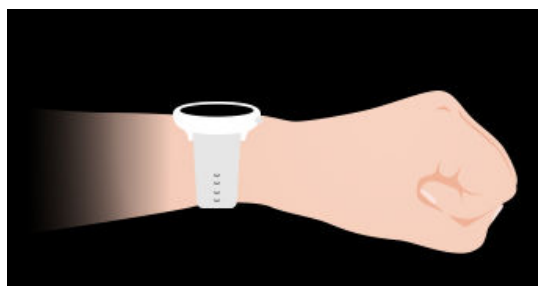

Muting an incoming call

Open the watch's app list, go to **Settings > Accessibility features > Gestures**, and enable **Mute incoming calls gesture**.

After this feature is enabled, with the screen facing up and your palm facing down, quickly rotate your wrist outwards by 90 degrees and rotate back to mute an incoming call.

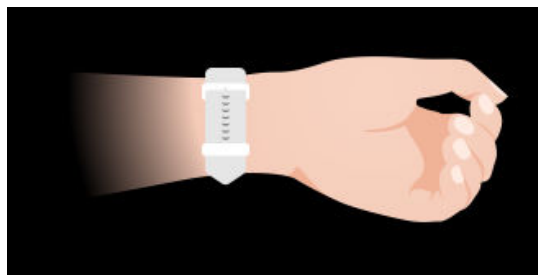

Measuring your body temperature

Body temperature measurements are mainly used to monitor the changes in the wrist skin temperature during and after exercise. After you enable a continuous skin temperature measurement, your skin temperature will be continuously measured and a measurement curve will be generated.

- i • The product is not a certified medical device. Body temperature measurements are mainly used to monitor the changes in the wrist skin temperature of healthy people over the age of 18 during and after exercise. Results are for reference only and should not be used as a basis for medical diagnosis or treatment.
- During the measurement, wear the device relatively tightly for more than 10 minutes and stay in a relaxed environment at room temperature (about 25°C). Ensure that there are no water stains or alcohol on your wrist. Do not start a measurement in an environment with direct sunlight, wind, or cold/heat sources.
- After you exercise, shower, or switch between outdoor and indoor environments, wait 30 minutes before you start a measurement.

Single measurement

In the watch's app list, go to **Skin temperature > Measure** to start measuring your temperature.

Continuous measurement

- 1** Open the Health app, touch **Devices** and then the device name, go to **Health monitoring**, and enable **Continuous skin temperature measurement**.
- 2** In the watch's app list, touch **Skin temperature** to view the measurement curve.

Emergency SOS

The watch will trigger emergency services when the Fall detection feature is enabled and the watch detects a serious fall. To prevent false alarms, emergency contacts are given priority for SOS emergency calls. If no emergency contact has been set, you will need to manually select a public emergency number.

- You can only send help messages when the watch is connected to the Health app.
 - Sending help messages is not supported on an iOS phone.

Automatically initiating an SOS request

- 1 On the watch's menu, go to **Settings > Security & privacy > SOS** and enable **Fall detection**.
- 2 After the watch detects a fall:
 - If emergency contacts have been set, the system will automatically call the first emergency contact and send an SMS message containing your current location to all emergency contacts when you do not select an emergency contact or you select to make an emergency call within 60 seconds.
 - If no emergency contact has been set, public emergency call numbers will be displayed for you to select one.

Manually initiating an SOS request

If emergency contacts have been set, press the Up button five times consecutively to initiate an SOS request.

- If **Fall detection** is disabled, your watch will not make emergency calls after it detects a serious fall. In this case, you can press the Power button five times consecutively to make an emergency call.
 - If the watch is connected to the phone via Bluetooth, you can make calls on the phone. If they are not connected, you can only make calls and send SMS messages after enabling the eSIM service on your watch.

Connecting your watch to the Internet

The watch can access the Internet via a WLAN, via a connected phone, or via an eSIM mobile network if the eSIM service is enabled. The watch will switch between these methods in the following order to use the best possible network:

- 1 If the watch is connected to the phone via Bluetooth, the watch will use the phone's network to save battery power.
- 2 If the Bluetooth connection fails or disconnects, the watch will use the connected WLAN.

- 3** If the Bluetooth connection between the watch and the phone disconnects and the WLAN is unavailable, the watch will then use the eSIM mobile network.



Connecting to the Internet via Bluetooth

If the watch is connected to the phone using the Health app and the app is running in the background, the watch will use the phone's network by default.

i This feature is not supported on an iOS phone.

Connecting to the Internet via a WLAN

If the watch is connected to the Internet via a WLAN, you can use an app on your watch to make MeeTime calls when you are not carrying the phone.

- 1** Press the Up button on your watch to open the app list, go to **Settings** > **WLAN**, and turn on the WLAN switch. The watch will then automatically scan for available WLANs.
- 2** Touch the WLAN you want to connect to, enter the password, and touch **Connect**.

Connecting to the Internet via an eSIM

i To connect to the Internet via an eSIM, you need to enable the eSIM service first.

Press the Up button on your watch to open the app list, go to **Settings** > **Mobile network** > **Mobile data**, and turn on the switch for **Mobile data**.

Ignoring the connected WLAN

- 1** Press the Up button on your watch to open the app list and then go to **Settings** > **WLAN**.
- 2** Select the connected WLAN and touch **Forget**.

Airplane mode

When taking a flight, enable **Airplane mode** as required by the airline. After **Airplane mode** is enabled, your watch will disable Bluetooth, WLAN, and the mobile network.

You can enable or disable **Airplane mode** using either of the following methods:

- Swipe down from the top of the home screen to open the shortcut menu, and touch the Airplane mode icon to turn it on or off.
- Press the Up button on your watch to open the app list, go to **Settings** > **Mobile network**, and enable or disable **Airplane mode**.

Charging

Charging

- 1 Connect the charging cradle to a power adapter and then connect the power adapter to a power supply.

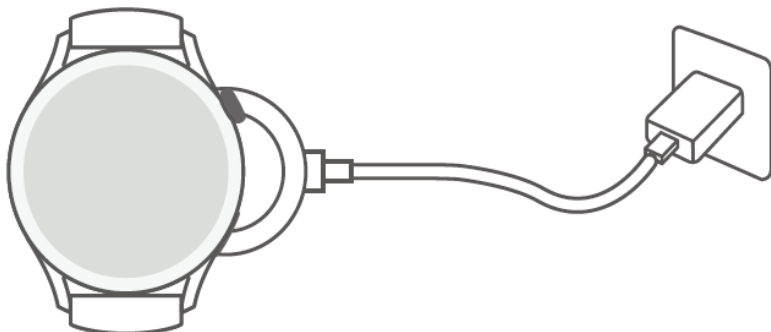

- 2 Rest your watch on top of the charging cradle and align the metal contacts on your watch to those of the charging cradle until a charging icon appears on the watch screen.
- 3 After the watch is fully charged, the charging indicator will display 100%. When your watch is fully charged, it will automatically stop charging.

- i • You are advised to use a Huawei power adapter, a USB port of a computer, or a non-Huawei power adapter that complies with corresponding regional or national laws and regulations as well as regional and international safety standards to charge your watch. Other chargers and power banks that do not meet corresponding safety standards may cause issues such as slow charging and overheating. Exercise caution when using them. It is recommended that you purchase a Huawei power adapter from an official Huawei sales outlet.
- Keep the charging port dry and clean to prevent short circuits or other risks.
- When wireless charging is used for your watch, use the dedicated charging cradle and make sure that the watch coil is aligned with that of the charging cradle. If a non-dedicated charging cradle is used and the watch coil is not aligned with that of the charging cradle, the charging efficiency will deteriorate and issues such as overheating will occur.
- can be charged by Huawei phones that support reverse wireless charging.
- The charging cradle tends to attract metal objects due to it being magnetic. Therefore, it is necessary to check and clean the charging cradle before use. Do not expose the charging cradle to high temperatures for a long time, as this may cause the charging cradle to demagnetize or cause other exceptions.

Charging time

It takes about 120 minutes to fully charge the battery. Disconnect the device from the power supply once it is fully charged.

 It takes about 180 minutes to fully charge the HUAWEI WATCH 3 Pro.

To protect the battery, the charging current will be reduced if the ambient temperature is low. This will prolong the charging time without affecting the battery lifespan.

Checking the battery level

Method 1: Swipe down from the top of the home screen to check the battery level.

Method 2: Connect your watch to a power supply and check the battery level on the charging screen.

Method 3: View the battery level on a watch face that supports displaying the battery level.

Method 4: Check the battery level on the device details screen in the Health app.

 If the remaining battery level is 10%, a charging reminder will be displayed. Charge your watch promptly and avoid using it when the battery level is low.

Calling

Support for the eSIM service

The watch supports the eSIM service (One Number Service). This service allows you to add the watch as an eSIM auxiliary device of your phone and enables the watch to share your phone's number (primary number), voice plan, and data plan. You will then be able to make calls and surf the Internet on the watch and phone separately without having to worry about missing important information when you don't have your phone with you.

 The eSIM service type depends on the specified carrier.

For the latest service support from carriers, visit the Huawei official website and go to **Watches > HUAWEI WATCH 3 Series > Product Support**.

Activating the eSIM service

Requirements

- Your SIM card must be the primary card (default card) in order for it to be enabled with the eSIM service.
- The watch must be connected to your phone via Bluetooth and your phone can access the Internet.
- The battery level of the watch is higher than 30%.
- If you are using an iOS phone, connect the watch to a WLAN first.

Activation

- 1** Connect the watch to your phone using the Health app.
- 2** Touch **Devices** and then your device name, go to **eSIM management > ACTIVATE NOW**, select the SIM card to be enabled with the eSIM, and touch **CONTINUE**.

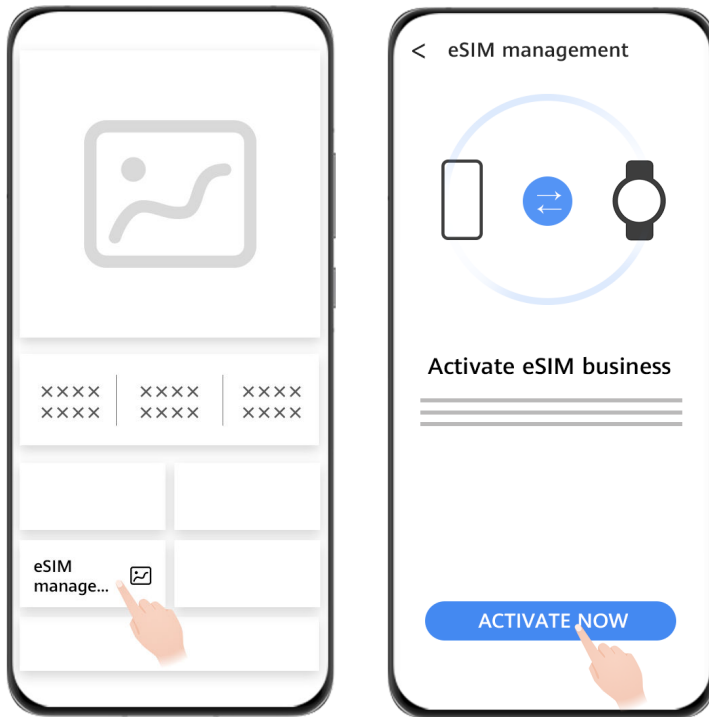

3 Follow the onscreen instructions to activate the service online or by scanning the QR code of your carrier. Enter the verification code sent by your carrier if necessary.

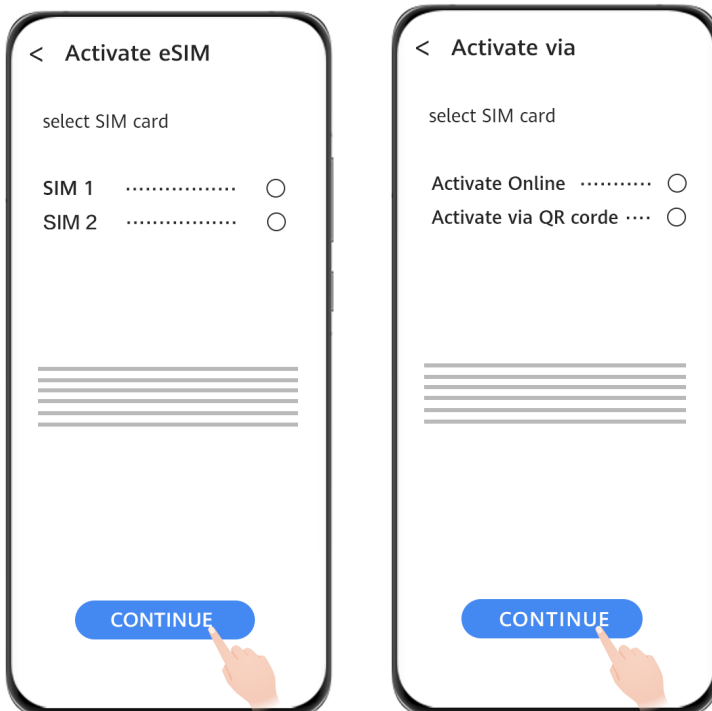

4 The eSIM service will be automatically activated after the account information is downloaded and configured for the first time.

i Do not perform any operations on the watch during activation.

Changing the eSIM Service

Only one eSIM can be activated for your device. To change the service, you need to reset the service on the **eSIM management** screen of the watch and activate another service. Resetting the service will remove the eSIM information from your watch but will not deregister from your carrier's service. To deregister from your carrier's service, contact your carrier.

Changing the eSIM number or the watch

Changing the eSIM number after the eSIM service has been activated on the watch

- 1 Deregister the eSIM number and remove the eSIM from the watch.
- 2 Use a new phone number to activate the eSIM service on the watch.

Replacing watch A (enabled with the eSIM service) with watch B

- 1 Deregister from the eSIM service on watch A and remove the eSIM from watch A.
- 2 Activate the eSIM service on watch B.

Using your watch to make calls

The watch supports making Bluetooth calls and eSIM calls to meet call requirements in different scenarios.

When the watch is connected to your phone via Bluetooth, you can use the watch to make or answer calls through the primary number of your phone.

If the Bluetooth connection disconnects and the eSIM service is enabled on the watch, you can make or answer calls through the eSIM number that has been activated on the watch.

Answering or rejecting a call on your watch

When you receive an incoming call, the watch will notify you and display the caller's information. You can choose to answer or reject the call.

Making a call on your watch

-  MeeTime is only supported on phones running HarmonyOS 2/EMUI 11.0 or later. MeeTime is only supported in certain countries or regions. For details, contact the official customer service.

You can make a call in one of the following ways:

- Using the voice assistant: Press and hold the Down button on your watch to wake up the voice assistant and say:
 - "Call Zichen."
 - "Dial 950800."

- Press the Up button on your watch to open the app list, touch **Contacts**, and select the contact you want to call.
 - Making a MeeTime call: Touch the connected device of the contact you want to call to initiate an HD voice call via the Internet.
 - Making a call: Touch **Call** to make a call to the contact.
- Press the Up button on your watch to open the app list and then select **Phone**. You can choose one of the following methods to make a call:
 - Touch **Call logs** and touch a call record to call back.
 - Touch **Keypad**, enter the number you want to call, and touch the Dial icon to make a call.
 - Touch **MeeTime** (if you are using this feature for the first time, follow the onscreen instructions to activate it), select a contact you want to call, and touch the connected device of the contact to make an HD voice call via the Internet.
 - Touch **Contacts** and then a contact to make a call.

Configuring settings during a call

To meet your different calling requirements, you can configure the settings during a call:

- Adjust the call volume by rotating the Up button. Mute a call by touching the Mute icon.
- Enter numbers by touching the More icon and then the Keyboard icon.

Switching calls between your phone and watch

When the watch is connected to your phone via Bluetooth, you can switch between the two devices on your phone during a call.

On the call screen of your phone, touch the Bluetooth button in the lower right corner and switch audio to your phone, watch, or earphones.

Viewing your call logs

Press the Up button on your watch to open the app list and then go to **Phone > Call logs** to view your call logs (including incoming, outgoing, and missed calls).

Syncing contacts to your watch

When the watch is connected to your phone via Bluetooth, your watch will automatically sync contacts from your phone.

Press the Up button on your watch to open the app list and then touch **Contacts** to view your contacts.

Health management

Heart rate measurement

- To guarantee a more accurate heart rate measurement, wear the watch correctly and ensure the strap is fastened. Make sure that your watch is secure on your wrist. Ensure that the monitoring module is in direct contact with your skin without any obstructions.

Individual heart rate measurement

- 1 Open the Health app, touch **Devices** then your device name, go to **Health monitoring > Continuous heart rate monitoring**, and disable **Continuous heart rate monitoring**.
- 2 Access the app list and select **Heart rate** to measure your heart rate.

- This measurement may also be affected by some external factors such as low blood perfusion, tattoos, a lot of hair on your arm, a dark complexion, lowering or moving your arm, or low ambient temperatures.
- Your watch can measure heart rates between 37 bpm and 209 bpm.

Heart rate measurement for a workout

During a workout, the device displays your real-time heart rate and heart rate zone, and notifies you when your heart rate exceeds the upper limit. For better training results, you are advised to do a workout based on your heart rate zone.

- Heart rate zones can be calculated based on the maximum heart rate percentage or HRR percentage. To choose the calculation method, open the Health app, go to **Me > Settings > Workout settings > Exercise heart rate settings** and set **Calculation method** to either **Maximum heart rate percentage** or **HRR percentage**.
- If you select **Maximum heart rate percentage** as the calculation method, the heart rate zone for different types of workout activities (Extreme, Anaerobic, Aerobic, Fat-burning, and Warm-up) is calculated based on your maximum heart rate ("220 minus your age" by default).
- If you select HRR percentage as the calculation method, the heart rate interval for different types of workout activities (Advanced anaerobic, Basic anaerobic, Lactic acid, Advanced aerobic, and Basic aerobic) is calculated based on your heart rate reserve (HRmax - HRrest).
- Heart rate measurement during a workout: The real-time heart rate can be displayed on the device when you start a workout.

- After completing your workout, you can check your average heart rate, maximum heart rate, and heart rate zone on the workout results screen.
- Your heart rate will not be displayed if you remove the device from your wrist during the workout. However, it will continue to search for your heart rate signal for a while. The measurement will resume once you put the device back on.

Continuous heart rate monitoring

Open the Health app, touch **Devices** then your device name, go to **Health monitoring** > **Continuous heart rate monitoring**, and enable **Continuous heart rate monitoring**. Once this feature is enabled, your watch can measure your real-time heart rate.

Resting heart rate measurement

Resting heart rate refers to your heart rate measured when you are still, awake, and at rest. The best time to measure your resting heart rate is immediately after you wake up in the morning.

Open the Health app, touch **Devices** then your device name, go to **Health monitoring** > **Continuous heart rate monitoring**, and enable **Continuous heart rate monitoring**. The device will then measure your resting heart rate automatically.

- If you disable **Continuous heart rate monitoring** after checking your resting heart rate, the resting heart rate displayed in the Health app will remain the same.
- The resting heart rate data on the device will be cleared on its own at 00:00 AM.

Heart rate alerts

After you start a workout using your watch, your watch will vibrate to alert you that your heart rate value has exceeded the upper limit for more than 10 seconds.

Perform the following to set a **heart rate upper limit**:

- For iOS users: Open the Health app, touch **Device** and your device name, go to **Heart rate limit interval and warning** > **Heart rate limit warning**, and set an upper limit that is suitable for you.
- For HarmonyOS/Android users: Open the Health app, go to **Me** > **Settings** > **Workout settings** > **Exercise heart rate settings**, touch **Heart rate limit**, and set an upper limit that is suitable for you.

Resting heart rate alerts

To enable **High heart rate alerts**, touch **Devices** and your device name. Go to **Health monitoring** > **Continuous heart rate monitoring**, enable **Continuous heart rate monitoring**, set an upper heart rate limit, and then touch **OK**. When you are not doing a workout, you will receive an alert when your resting heart rate stays above your set limit for more than 10 minutes.

To enable **Low heart rate alerts**, touch **Devices** and your device name. Go to **Health monitoring** > **Continuous heart rate monitoring**, enable **Continuous heart rate**

monitoring, set a lower heart rate limit, and then touch **OK**. When you are not doing a workout, you will receive an alert when your resting heart rate stays below your set limit for more than 10 minutes.

Measuring blood oxygen levels (SpO2)

- To ensure the accuracy of the SpO2 measurement, wear the watch properly and ensure the strap is fastened. Ensure that the monitoring module is in direct contact with your skin without any obstructions.

Single SpO2 measurement

- 1 Wear your watch correctly and keep your arm still.
- 2 From the home screen, press the Up button, swipe on the screen, and touch **SpO2**.
- 3 Touch **Measure**.
- 4 Keep your body still during the SpO2 measurement.

Automatic SpO2 measurement

- 1 Open the Health app, touch **Devices** and then your device name, go to **Health monitoring**, and enable **Automatic SpO2 measurement**. The device automatically measures and records your SpO2 when it detects that you are still.
 - 2 Touch **Low SpO2 alert** to set the lower limit of your SpO2 for you to receive an alert when you are not asleep.
- Swipe right on the watch screen to stop measuring. The measurement will run in the background if there is a notification for an incoming call or alarm.
 - An SpO2 measurement will take around one minute. Data provided is for reference only and not for medical use. Consult a doctor as soon as possible if you feel uncomfortable.
 - During the SpO2 measurement, the watch will also measure your heart rate.
 - Your watch will automatically measure your SpO2 during the workout session after you have enabled **Mountain hike, Skiing, Snowboarding, Cross-country skiing, Hike, or Trail run**. Swipe up and down on the watch screen to view your SpO2 data.
 - This measurement may also be affected by some external factors such as low blood perfusion, tattoos, a lot of hair on your arm, a dark complexion, lowering or moving your arm, or low ambient temperatures.

Tracking sleep

Regular sleep data

Your watch collects sleep data and identifies your sleep status when you are wearing it correctly while asleep. It can automatically detect when you fall asleep and wake up and

whether you are in a light or deep sleep. You can sync and view your detailed sleep data in the Health app.

- If you slept during the day and for less than 3 hours, it will be recorded as a nap. If you slept for a short time, such as less than 30 minutes, or if your wrist moves a lot when asleep, the watch may not detect that you are sleeping. In this case, it will not record any sleep data.
- The sleep data on your watch will be updated at 24:00 (midnight) every day. Historical data will be stored on your watch. Please sync the data to the Health app in a timely manner to prevent historical data from being cleared.

HUAWEI TruSleep™

Open the Health app, touch **Devices** then your device name, go to **Health monitoring** > **HUAWEI TruSleep™**, and enable **HUAWEI TruSleep™**.

After you enable **HUAWEI TruSleep™**, your watch will collect your sleep data, detect when you fall asleep, wake up, whether you are in a light, deep, or REM sleep, and identify the times when you wake up and your breathing quality to provide you with sleep quality analysis and suggestions to help you understand and improve your sleep quality.

- Power consumption increases after HUAWEI TruSleep™ is enabled. It is recommended that the battery level of your watch is at least 30% before you go to sleep.

Viewing your sleep data

The measurement period lasts 24 hours, from 20:00 on the first day to 20:00 on the second day. If you sleep for 11 hours from 19:00 to 06:00, your watch will count the duration you slept before 20:00 during the first day as well as the rest of the time that you were asleep during the second day.

You can use either of the following methods to view your sleep data:

- To view the sleep data of the current day on your watch, press the Up button on your watch to access the app list. Touch **Sleep** and swipe up on the screen to view the sleep duration at night and the amount of naps.
- To view the historical sleep data in the Health app, touch the **Sleep** card on the home screen of the Health app to view your daily, weekly, monthly, and yearly sleep data.

Testing stress levels

You can use your watch to test your stress level on a one-off or periodic basis.

- To measure your stress level on a one-off basis: Open the Health app, touch the **Stress** card, and touch **Stress test** to start a single stress test. When using the stress test function for the first time, follow the onscreen instructions in the Health app to calibrate your stress level.

- To measure your stress level on a periodic basis: Open the Health app and touch **Devices** and then your device name. Touch **Health monitoring**, enable **Automatic stress test**, and follow the onscreen instructions to calibrate the stress level. Wear your watch correctly for the periodic stress test to start automatically.

You can view stress data on your watch or in the Health app.

- To view stress data on the watch: Press the Up button to access the app list, swipe up or down until you find **Stress**, and touch it to view the graph indicating changes to your stress level, the stress bar chart, stress levels, and stress intervals.
- To view stress data in the Health app: Open the Health app, then touch the **Stress** card to view your latest stress level, daily, weekly, monthly, and yearly stress curves, and corresponding advice.
-  During a stress test, wear your watch correctly and keep still. The watch will not test your stress level when you are doing a workout or when you move your wrist too frequently.
 - The accuracy of the stress test may be affected if the user has just taken substances with caffeine, nicotine, or alcohol, or psychoactive drugs. It may also be affected when the user suffers from heart disease or asthma, has been exercising, or is wearing the watch incorrectly.

Breathing exercises

Enter the app list on your device and touch **Breathing exercises**, set the duration and rhythm, touch the breathing exercises icon on the screen, and follow the onscreen instructions to do the breathing exercises.

-  You can set the duration to **1 min**, **2 min**, or **3 min** and the rhythm to **Fast**, **Moderate**, or **Slow**. After the exercise is finished, the screen will display the training effects, heart rate before the exercise, training duration, and evaluation.

Activity reminder

When **Activity reminder** is enabled, your watch will monitor your activity within a specified period of time (set to one hour by default). To make sure that you get the right balance between resting and being active, your watch will vibrate and turn on its screen to remind you to move around if you did not move around during the set period.

To disable **Activity reminder**, open the Health app, touch **Devices** then your device name, touch **Health monitoring**, and turn off the switch for **Activity reminder**.

-  Your device will not vibrate to remind you to move around if you have enabled **Do Not Disturb** on it.
- Your device will not vibrate when you are asleep.
- Your device will only send activity reminders between 08:00 and 12:00 and between 14:30 and 21:00.

Adding emergency information

The watch provides the medical first aid card for first aid personnel to quickly obtain your health information (such as blood type, allergy information, drug status, precautions, and emergency contacts) in emergencies (such as when you are in physical discomfort, fainting, ill, or have had an accident) and then take corresponding first aid measures.

Setting emergency information

- 1** Open the Health app, go to **Me > Profile > Emergency information**, and fill in your personal information.
- 2** Go to **Emergency contacts > Add emergency contacts** and select an emergency contact you want to add.



Viewing emergency information

Method 1: On your watch, go to **Settings > Security & privacy > SOS emergency help > Emergency information** to view your emergency information and directly call an emergency contact.

Method 2: If you have set a PIN for your watch, touch the Call icon in the lower left corner of the screen to view your emergency information and directly call an emergency contact.

Method 3: Open the Health app and go to **Me > Profile > Emergency information** to view your emergency information.

Editing emergency information

- 1** Open the Health app, go to **Me > Profile > Emergency information**, and edit information such as your name, address, and medical information.
 - 2** Go to **Emergency information > Emergency contacts** and touch the Edit icon in the upper right corner to enter the page for editing an emergency contact.
 - Touch  next to an emergency contact to delete the contact.
 - Touch **Add emergency contacts** and follow the onscreen instructions to add an emergency contact.
-  If you have updated your emergency information on the phone, it will need to be synced to your watch again the next time you pair your watch via Bluetooth.

Workout modes

Starting a workout

Starting a workout using your watch

- 1 Enter the app list of your watch and touch **Workout**.
- 2 Swipe up or down and select the workout you want to do or your preferred running course. Alternatively, swipe up on the screen and touch **Custom** to add other workout modes.
- 3 Touch the Start icon to start a workout session. (For outdoor workouts, ensure that GPS positioning is working before you start.)
- 4 To end a workout session, press the Up button and touch the Stop icon, or press and hold the Up button.
In the app list, touch **Workout records** to view detailed workout records data including the general data, speed, steps, climbed distance, heart rate graph, heart rate zones, cadence graph, pace graph, and VO2Max.

Starting a workout using the Health app

To start a workout using the Health app, move your phone and watch close to each other to ensure that they are connected.

- 1 Open the Health app, touch **Exercise**, choose a workout mode, and touch the Start icon to start a workout.
- 2 Once you have started a workout, your watch will sync and display your workout heart rate, speed, and time. Your workout data, such as the workout time, will be displayed in the Health app.

Running courses

Your watch comes with a variety of running courses that can guide you and record your workouts and fitness training. It can also work with voice prompts to help you complete the courses, allowing you to stay more active in daily life.

- 1 On the device, enter the app list and touch **Workout**.
- 2 Swipe up or down on the screen, then select .
- 3 Choose a course and follow the onscreen instructions to start the workout.
 Running courses: Choose a course and follow the onscreen instructions to start the workout.

Creating a training plan

Running plans can only be created and started using the Health app. To create a new plan, end the existing plan and then create a new one.

Creating a training plan:

Open the Health app, go to **Exercise**, select a training plan, and then follow the onscreen instructions to finish creating it.

Ending a training plan:

Touch the created training plan under **MY PLANS**, touch the Settings icon in the upper right corner of the screen, and select **End plan**.

Smart companion

After Smart companion is enabled on your watch, your watch will send you real-time voice guidance during a running session, such as guidance about your workout intensity, running duration, and heart rate.

- 1 Press the Up button to access the app list and go to **Workout > Outdoor run**.
- 2 Touch the Settings icon to the right of **Outdoor run** and enable **Smart companion**.
- 3 Return to the app list and touch **Outdoor run** to start running.

-  Smart companion is currently only available for Outdoor run. If you have set your workout goal, your smart companion won't provide you with any voice guidance. After **Smart companion** is enabled, it will be used instead of the Reminders feature. Smart companion only provides voice guidance in English.

Route back

When you start an outdoor workout and enable the Route back feature, the watch will record the route you took and provide you with navigation services. After reaching your destination, you can use this feature to find out how to return to where you came from.

On your watch, enter the app list, then swipe until you find **Workout** and touch it. Start an individual outdoor workout session. Swipe left on the screen and select **Route back** or **Straight line** to return to the starting point.

Viewing workout records

Viewing workout records on the device

- 1 On the device, enter the app list and touch **Workout records**.
- 2 Select a record and view the corresponding details. The device will display different data types for different workouts.

Viewing workout records in the Health app

You can also view detailed workout data under **Exercise records** on the **Health** screen in the Health app.

Workout status

Enter the watch's app list and touch **Workout status**. Swipe up on the screen to view data including your training load, and VO2Max.

- Your training load from the last seven days can be viewed to determine your level based on your fitness status. The watch collects your training load from workout modes that track your heart rate, such as running, walking, cycling, and climbing.
- VO2Max data can be obtained from outdoor running workouts. The requirements for the watch to obtain the VO2Max change trends are as follows:

At least one outdoor running session is done every week (15 minutes of running at a constant speed and an average pace greater than 7.2 km/h).

Recording daily activities

Wear your watch correctly for it to automatically record data relating to calories, distance, climbing stairs, steps, duration of moderate to high intensity activities, and other activities. You can view your workout data in either of the following ways:

- On your watch: Press the Up button to access the app list, swipe until you find **Activity records**, touch it, and then swipe up or down to view data relating to calories, distance, climbing stairs, steps, duration of moderate to high intensity activities, and other activities.
- In the Health app: Ensure that your watch is connected to the app for you to view your activity records on the home screen of the app.

Auto-detecting workouts

The watch can automatically identify your workout status. Update the watch to the latest version first.

Go to **Settings > Workout settings** and enable **Auto-detect workouts**. After this feature is enabled, the watch will remind you to start a workout when it detects increased activity. You can ignore the notification or choose to start the corresponding workout.

Currently, the following workout modes are supported: indoor walk, outdoor walk, indoor run, outdoor run, elliptical trainer, and rowing machine.

Handy features

Assistant·TODAY

On the Assistant·TODAY screen, you can view the weather forecast, wake up the voice assistant, access running apps, and view push messages from the calendar and AI Tips conveniently.

-  AI Tips push messages are only supported when the device is paired with a Huawei phone.



Swipe right on the home screen of your watch to enter Assistant·TODAY.

Remote shutter

When the watch is connected to your phone, you can remotely control your phone to take photos and record videos. You can also preview the photos and videos on the watch, which helps you take better photos.

-  This feature is only available with phones running HarmonyOS 2 or later.

Remotely controlling your phone to take photos or record videos

- 1 Press the Up button on the watch to open the app list and then touch **Remote shutter** to enable the camera of your phone.
- 2 Select **Photo**, **30s video**, or **2s delay** on the top of the watch's camera screen.
 -  You can adjust the focal length by rotating the Up button or pinching two fingers together.
 - You can switch between the front and rear cameras on the watch.
- 3 After previewing the photo or video on your watch, touch  to finish and touch  to start recording a video.

Viewing photos



After a photo is taken, touch the thumbnail in the lower left corner to view the most recent photo on your watch. You can also rotate the Up button or pinch two fingers together to zoom in or out on the photo.

Voice notes

The watch supports recording your voice in the form of notes, which will then be automatically synced to Notes on the connected phone.



-  The voice notes can only be automatically synced to phones running HarmonyOS 2 or later.

Recording a voice note

- 1 Press the Up button on the watch to open the app list and then touch **Notepad**.
- 2 Touch . Recording starts when a timer is displayed.
- 3 Touch  to stop recording.
 -  The automatic syncing of voice notes to your phone's **Notepad** is enabled by default and can be manually disabled.

Viewing voice notes



Method 1: On the watch

- 1 Press the Up button on the watch to open the app list and then touch **Notepad**.
- 2 Touch the name of a voice note to enter the details screen.
- 3 Touch  to play the voice note and touch  to adjust the volume.

Method 2: On your phone

Touch **Notepad** on your phone and touch the name of a voice note to play it.

Deleting voice notes

- 1 Press the Up button on the watch to open the app list and then touch **Notepad**.
- 2 Touch the name of a voice note to enter the details screen.
- 3 Touch  to delete the voice note. If the automatic syncing of voice notes to your phone's **Notepad** is enabled, the voice note will be automatically deleted from your phone.
 -  . In the voice note list, touch and hold a voice note. You will then be able to select multiple notes and delete them in batches.
 - If you delete a voice note from your phone, it will not be automatically deleted from the watch.

Voice assistant

The watch allows you to wake up the voice assistant to make calls, play music, start workout sessions, set alarms, view your heart rate, open apps, and control your smart home when the watch is connected to your phone using the Health app.

-  This feature is only supported in certain countries or regions. For details, contact the official customer service.

Using the voice assistant

- 1 Press and hold the Down button to wake up the voice assistant.
- 2 Give a voice command on the displayed screen, such as "What's the weather like today?"



More settings

Go to **Settings > HUAWEI Assistant > AI Voice** and configure settings.

- **Wake by voice:** This feature is disabled by default. After it is enabled, you can say **Hey Celia** to wake up the voice assistant.
- **Wake by press:** This feature is enabled by default. After it is enabled, press and hold the Down button to wake up the voice assistant.
- **Broadcast:** This feature is enabled by default. After it is disabled, the watch will not broadcast voice messages.

Connecting to Bluetooth earphones

After the watch is connected to your Bluetooth earphones, you will be able to use the Bluetooth earphones to answer calls or listen to music.



Connecting to Bluetooth earphones

- 1 Put your Bluetooth earphones in pairing mode.
- 2 Press the Up button on the watch to open the app list and then go to **Settings > Bluetooth > Scan for devices**.
- 3 Select the name of the Bluetooth earphones to be paired from the scan results and then follow the onscreen instructions to finish pairing.

Using your Bluetooth earphones to make or answer calls

- Use your Bluetooth earphones to answer calls in one of the following ways:
 - Pair your Bluetooth earphones with your phone and answer calls on the phone.

- Enable the eSIM service on the watch, pair the watch with your Bluetooth earphones, and answer calls on the watch.
- If your phone can be connected to two audio devices at the same time, connect your phone to both the watch and Bluetooth earphones. When you receive an incoming call, answer or reject it on either your phone or the watch.
 - If you answer or make a call on your phone, the sound will come from the Bluetooth earphones.
 - If you answer or make a call on the watch and touch the Earphone icon on the watch screen, the sound will come from the Bluetooth earphones. If there is no such icon on the watch screen, the sound will come from the watch.

Music

The watch supports playing online and offline music. You can still enjoy listening to music even if you do not have your phone with you. When the watch is connected to your phone, your favorites will be automatically synced to your watch.

 Syncing your favorites to the watch is only available with Huawei phones.

Playing music

- 1 Press the Up button on the watch to open the app list and then touch **Music**.
- 2 Play songs in one of the following ways.
 - a Touch **Search** to search by song name.
 - b Touch **Recommend** to play songs by category.
 - c Touch **Playlists** and select a song in the playlist. To use this feature, you need to create a playlist in HUAWEI Music on your phone first.
 - d Touch **Favorites**. To use this feature, you need to add songs being played to the **Favorites** list on the watch or add songs you like on your phone.
 - e Touch **Songs**. To use this feature, you need to add local songs to HUAWEI Music on your phone first.

Controlling the music on your phone

When the watch is connected to your phone and music is being played on your phone, you can use your watch to start or pause music playback, play the previous or next song, and adjust the volume.

 Controlling the music on phones is only available for HarmonyOS/Android users.

Viewing the calendar

After you create an event on your phone, it will be synced to your watch when you open the calendar on the watch.



Press the Up button on your watch to open the app list and then touch **Calendar** to view the current date and upcoming events.

-  Viewing the calendar is only available with phones running HarmonyOS 2/EMUI 10.0 or later.

Using alarms

The watch supports alarms to give you reminders at the exact time, assist in time management, and help you get a good work-life balance.

Setting an alarm

- 1 Open the app list on the watch, select **Alarm**, and touch  to add an alarm.
- 2 Set the alarm time and repeat cycle and then touch **OK**.
 -  If you do not set the repeat cycle, the alarm will be a one-time alarm.

Editing an alarm

- 1 Open the app list on the watch and select **Alarm**.
- 2 Touch the alarm you want to edit. On the displayed screen, edit the alarm's name, time, and repeat cycle as required.

Deleting an alarm

- 1 Open the app list on the watch and select **Alarm**.
- 2 Touch the target alarm. On the displayed screen, touch **Delete** to delete the alarm.

Syncing alarms from your phone

When the watch is connected to your phone, the alarms on your phone will be synced to the watch.

-  Syncing alarms is only available with phones running HarmonyOS 2/EMUI 8.0 or later.

Viewing weather information

After your watch is connected to the Internet and positioning is enabled, you will be able to view the temperature and weekly weather forecast for your current location.

Viewing weather information

Method 1: On the Assistant·TODAY screen

- 1 Swipe right on the watch face screen to enter Assistant·TODAY.
- 2 Touch the weather area to view details about the weather.

Method 2: On the watch face

Switch to a watch face that can display weather information.

Method 3: In the Weather app

Press the Up button on the watch to open the app list and then touch **Weather**.

Compass

The compass displays the direction, longitude, and latitude of the watch, helping you get your bearings in unfamiliar environments such as when you are outdoors or traveling.



Open the app list on the watch, touch **Compass**, and follow the onscreen instructions to slowly rotate the watch and finish calibrating. After the calibration is complete, you will then be able to use the compass.

-  During the calibration, avoid sources of magnetic field interference, such as phones, tablets, and computers. Otherwise, the calibration accuracy may be affected.



Stopwatch

The watch supports normal and segment-based timing in Stopwatch, helping you with activities that require accurate timing, such as sports and competitions.

Starting the stopwatch

- 1 Press the Up button on the watch to open the app list and then touch **Stopwatch**.
- 2 Touch  to start timing.
- 3 Touch  to start segment-based timing.

Pausing or resetting the stopwatch

Touch  to pause the stopwatch and touch  to reset the stopwatch.

Timers

The watch supports quick timers (with preset durations such as 1 minute, 3 minutes, and 5 minutes) and customized timers to help you complete tasks with specified durations.

Setting a quick timer

- 1 Press the Up button on the watch to open the app list and then touch **Timer**.
- 2 Select a duration and start timing.
- 3 After the timer expires, the watch will vibrate. You can touch **X** to exit or touch the icon in the lower right corner to repeat the last quick timer.

Setting a customized timer

- 1 Press the Up button on the watch to open the app list and then touch **Timer**.
- 2 Swipe up on the screen and touch **Custom**.

3 Select the hour, minute, and second and then touch  to start timing.

Pausing, resetting, and exiting the timer

Touch  to pause, touch  to reset, and touch  to exit.

Barometer

Barometer on the watch automatically measures the altitude and air pressure of the current location and records the measurement data of the current day in a waveform graph.

Viewing the altitude and air pressure

- 1** Press the Up button on the watch to open the app list and then touch **Barometer**.
- 2** Swipe up or down on the screen to view the altitude and air pressure.

Finding your phone

Swipe down on the watch face screen to enter the shortcut menu and touch **Find phone**. The Find phone animation will then be played on the screen. If your watch and phone are within the Bluetooth connection range, the phone will play a ringtone (even in Vibrate or Silent mode) to notify you of its whereabouts.

Touch your watch screen or unlock your phone screen to stop finding your phone.

 This feature will only work when your phone and watch are connected.

More guides

Managing apps

Installing and uninstalling apps

- 1 Press the Up button on the watch to open the app list and then select **AppGallery**.
- 2 Search for an app or select an app from the list of recommended apps and then touch the Download icon on the right to download the app.
- 3 After the installation is complete, touch the app to open or uninstall it.

Managing apps running in the background

- Press the Up button twice and swipe left or right on the screen to view apps running in the background.
- Touch an app tab to switch to the app.
- Swipe up on the app tab to close it.
- Touch the Delete icon to stop all apps running in the background.

Managing installed apps

- 1 Press the Up button on the watch to open the app list and then select **AppGallery**.
- 2 Swipe up on the screen to update or view installed apps.

Viewing or setting apps

- 1 Press the Up button on the watch to open the app list and then go to **Settings > Apps > Apps**.
- 2 Touch an app to view its permission and storage information. You can configure settings as required.

Adjusting the sequence of apps in the app list

Press the Up button on your watch to open the app list and then drag an app up or down. Alternatively, touch and hold an app while rotating the watch crown.

Restoring system apps

If you accidentally uninstall system apps, such as the alarm clock and stopwatch, perform the following steps to restore them:

- 1 Press the Up button on the watch to open the app list and then go to **Settings > Apps > Apps > System processes**.
- 2 Touch **Restore system apps**, select the apps, and follow the onscreen instructions to finish restoring them.

Adjusting and changing the strap

Adjusting the strap

Three-bead metal strap

- 1 To remove the strap, push the lever in the direction indicated by arrow 1 and then remove the chain in the direction indicated by arrow 2.

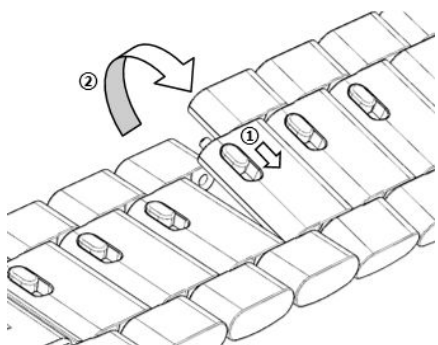

- 2 To install a strap, push the lever in the direction indicated by arrow 1 and then install the chain in the direction indicated by arrow 2.

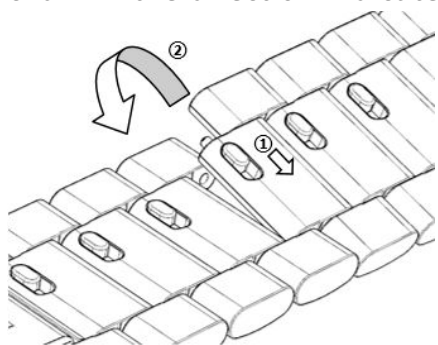

Changing the strap

- If you are using a non-metal strap, perform the following steps to remove it and install a new strap in the reverse order.

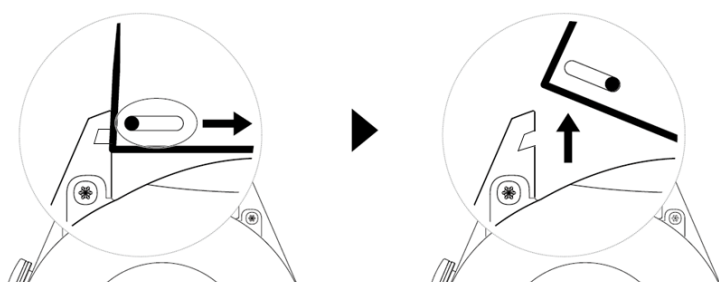

- To remove and install a metal strap, perform the following steps:
 - Removal:
 - Watch case with one guide slot on a lug:

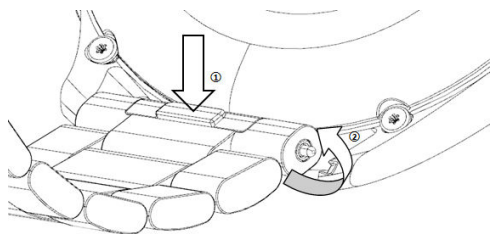

- Watch case with two guide slots on a lug:

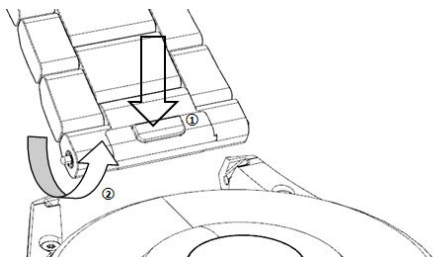

- Installation:
 - If the watch case has one guide slot on a lug, insert the left spring bar of the watch strap into the bar hole on the watch case and then press the right spring bar through the guide slot.
 - If the watch case has two guide slots on a lug, press the left and right spring bars of the watch strap through the two guide slots.
-  The leather strap is not waterproof. Please keep it dry and remove any sweat and other liquids in a timely manner.

Setting time and language

After you have synced data between your device and phone, the system language will be synced to your device as well.



If you change the language and region or change the time, the changes will automatically sync to the device as long as it is connected to your phone via Bluetooth.

Managing watch faces

Watch Face Store provides a diverse range of watch faces for you to choose from. To download or delete watch faces, update the watch and the Health app to the latest versions.

Changing a watch face on your watch



- 1 Touch and hold the watch face screen or go to **Settings > Watch face & launcher > Watch faces**.
- 2 Swipe left or right to select a watch face you like.

-  Some watch faces can be customized. You can touch  under a watch face to customize its display content.

Installing and changing the watch face on your phone

- 1 Open the Health app, touch **Devices** and the device name, and go to **Watch faces > More**.
- 2 Select a watch face.
 - a If the watch face has not been installed, touch **Install**. After the installation is complete, your watch will automatically use this new watch face.
 - b If the watch face has been installed, touch **SET AS DEFAULT** to use the selected watch face.
 -  . Paid watch faces cannot be refunded. If you cannot find watch faces in Watch Face Store that you have already purchased, contact the customer service hotline.

Deleting a watch face

- 1 Open the Health app, touch **Devices** and the device name, and go to **Watch faces > More**.
- 2 Select an installed watch face and touch  to delete it.
 -  . Gallery or video watch faces cannot be deleted.
 - You do not need to purchase a watch face again after deleting it from Watch Face Store. You will only need to reinstall it.

Configuring Gallery

One or more photos can be used as watch faces. Update the watch and the Health app to the latest versions.

-  . Before using this feature, update the Health app and device to the latest versions.

Choosing photos from Gallery



- 1 Open the Health app, touch **Devices** and then your device name, and go to **Watch faces > More > Me > Gallery** to access the Gallery settings screen.
- 2 Touch **+** and select either **Camera** or **Gallery** as the method for uploading a photo.
- 3 Select a photo or take a new one and then touch **Save**. Your watch will then display the customized photo as the watch face.

Other settings

On the Gallery settings screen:

- Touch **Style** to set the font and color of the time and date displayed on Gallery watch faces.
- Touch **Location** to set the locations of the time and date displayed on Gallery watch faces.
- Touch **Function** to set functions displayed on watch faces.
- Touch the Cross icon in the upper right corner of a selected photo to delete it.

Using Huawei Share OneHop for watch faces

-  • Update the Health app to the latest version and ensure that the wearable device is connected to your phone.
 - This feature is only supported by NFC-capable phones running HarmonyOS 2/EMUI 11.0 or later.
- 1** Press the Up button on the watch to open the app list and then go to **Settings > NFC** to enable NFC.
- 2** Enable NFC on your phone, open Gallery, select images, and place the NFC area against the watch screen.
- 3** After the transfer is complete, switch between the images to select a watch face.
 -  • You can't use OneHop to transfer images saved on the cloud. To transfer these images, download these images first then use OneHop to transfer them.
 - A maximum of 20 images can be transferred at a time. If the number of images exceeds 20, the earliest transferred images will be overwritten.

Locking or unlocking the watch

You can set a PIN on the watch to bolster your privacy. After you have set a PIN and enabled Auto-lock, you will need to enter the PIN to unlock the watch and enter the home screen.

Setting a PIN

- 1** Set a PIN.

Swipe down on the watch's home screen, go to **Settings > PIN > Set PIN**, and follow the onscreen instructions to set a PIN.
 - 2** Enable Auto-lock.

Swipe down on the watch's home screen, go to **Settings > PIN**, and enable **Auto-lock**.
-  If you forget the PIN, you will be required to restore the device to its factory settings.

Changing the PIN

Swipe down on the device's home screen, go to **Settings > PIN > Change PIN**, and follow the onscreen instructions to change the PIN.

Disabling the PIN

Swipe down on the device's home screen, go to **Settings > PIN > Disable PIN**, and follow the onscreen instructions to disable the PIN.

-  If the watch is linked to a bank card, disabling the PIN will remove the bank card.

Forgot the PIN

If you have forgotten the PIN, restore the watch to its factory settings and try again.

Open the Health app, touch **Devices** and your device name, and select **Restore factory settings**.

-  . Once you have restored your device to its factory settings, all of its data will be cleared, so please proceed with caution.
 - If you have added a transportation card or an access card to the watch, the data of these cards will be deleted once you have restored the watch to its factory settings.

Sound settings

Setting the ring volume

- 1 Press the Up button on the watch to open the app list and then go to **Settings > Sounds & vibration > Ring volume**.
- 2 Swipe up or down to adjust the ring volume.

Setting the ringtone

- 1 Press the Up button on the watch to open the app list and then go to **Settings > Sounds & vibration > Ringtone**.
- 2 Swipe up or down to select a ringtone.

Muting and unmuting

- 1 Press the Up button on the watch to open the app list and then go to **Settings > Sounds & vibration**.
- 2 Enable or disable **Mute**.

Setting the vibration mode

- 1 Press the Up button on the watch to open the app list and then go to **Settings > Sounds & vibration**.
- 2 Enable or disable **Vibrate for calls** or **Vibrate when muted**. Both are enabled by default.

System haptics

- 1 Press the Up button on the watch to open the app list and then go to **Settings > Sounds & vibration**.
- 2 Enable or disable **System haptics**. When this feature is enabled and you rotate the watch crown, you will feel the rotation.

Adjusting the screen brightness

- 1 Press the Up button on the watch to open the app list and then go to **Settings > Display & brightness**.

- 2 If **Automatic** is enabled, disable it.
- 3 Touch **Brightness** to adjust the screen brightness.

Customizing the function of the Down button

- 1 Press the Up button to open the app list and then go to **Settings > Down button**.
- 2 Select an app and customize the function of the Down button.
After you have finished customizing the function, return to the home screen and press the Down button to open the current app. If the function has not been customized, the **Workout** app will be opened by default.

Ultra-long Battery Life mode

After **Ultra-long Battery Life** is enabled, only certain features will be available and the mobile network, WLAN, and Assistant•TODAY will be disabled.

Enabling Ultra-long Battery Life mode

Press the Up button to open the app list, go to **Settings > Battery**, swipe up on the screen, and enable **Ultra-long Battery Life**.

Exiting Ultra-long Battery Life mode

Swipe down on the home screen, touch **Exit Ultra Power**, and follow the onscreen instructions to finish exiting this mode.

 To exit Ultra-long Battery Life mode, you will need to restart the watch.

Accessibility operations

Zoom-in gesture

Open the app list on the watch, go to **Settings > Accessibility features > Accessibility**, and enable **Zoom-in gesture**.

After Zoom-in gesture is enabled, touch the screen three times consecutively to zoom in on the screen, and touch the screen three times consecutively again to exit.



Pressing the Up button to end calls

Open the app list on the watch, go to **Settings > Accessibility features > Accessibility**, and enable **Press Up to end calls**.

Watch updates

- 1 Connect the watch to a network, press the Up button to open the app list, and go to **Settings > System & updates > Software update**.
- 2 Touch **Check for updates** and follow the onscreen instructions to finish updating.

Powering on and off, restarting, and restoring to factory settings

Powering on

- Press and hold the Up button.
- Charge the device.



Powering off

- Press and hold the Up button and then touch **Power off**.
- Press the Up button to open the app list and then go to **Settings > System & updates > Power off**.
- If the battery level is critically low, the device will vibrate and then automatically power off.

Restarting

- Press and hold the Up button and then touch **Restart**.
- Press the Up button to open the app list and then go to **Settings > System & updates > Restart**.

Force restarting

Press and hold the Up button for at least 12 seconds.

Restoring to factory settings

Method 1: Press the Up button on the watch to open the app list, go to **Settings > System & updates > Reset**, and follow the onscreen instructions to restore the device to its factory settings.

Method 2: Open the Health app, touch **Devices** and your device name, and then select **Reset**.

- ⓘ After you restore the device to its factory settings, data of all cards, system, and apps (including data of linked bank cards, access cards, and the eSIM) in your account and wallet will be removed from your device. Please exercise caution when performing this operation.

Viewing the Bluetooth name, MAC address, SN, model, and version number

Viewing the Bluetooth name:

- Press the Up button on the device and go to **Settings > About** to view the Bluetooth name of the connected device.
- Alternatively, open the Health app and touch **Devices** then your device name to view the Bluetooth name of the connected device.

Viewing the MAC address:

Press the side button on the device and go to **Settings > About** to view the MAC address of your device.

Viewing the SN:

Press the side button and go to **Settings > About** to view the SN of your device.

Viewing the model:

- Press the side button and go to **Settings > About** to view the model of your device.
- The laser-engraved characters after the word "MODEL" on the back of the device indicate the model name.

Viewing the version number:

- Press the side button and go to **Settings > About** to view the version number of your device.
- Open the Health app, touch **Devices** then your device name, and touch **Firmware update** to view the version number of your device.

Cleaning and maintenance

Keep the device and strap clean and dry to extend their service life. You can use a piece of paper or soft cloth dipped in clean water to wipe the surface of your watch. When cleaning the watch, pay attention to the following:

- Before cleaning the device, disconnect the device from the power adapter.
- After you exercise, remove any sweat or stains from the surface of the device and the strap.
- When at room temperature, do not place the device in a liquid other than water or immerse the device in liquid for a long time.
- To prevent corrosion and damage to the device, do not use chemical products or detergent to clean the device or its accessories.
- After cleaning the device, use a piece of dry cloth or cotton paper to clean the device to prevent the remaining water from condensing inside the device and damaging the device.
- To prevent discoloration, avoid letting the light-colored strap come into contact with dark colored clothing. If the light color strap accidentally gets dirty, dip a soft brush in clean water and gently wipe the strap dry.
- Once you have done a lot of workouts, please clean the strap in a timely manner to avoid the accumulation of sweat, which may cause bacteria to build up. After cleaning the strap, dry it in a well-ventilated and dry place. Do not wear it when wet.