



# **Intel® Server System R2000WF Product Family**

## ***System Integration and Service Guide***

A guide providing instructions for the insertion and extraction of system components and available Intel accessories and spares

**Revision 1.0**

**July 2017**

Intel® Server Products and Solutions

**<This page is intentionally left blank.>**

## Document Revision History

Date	Revision Number	Modifications
July 2017	1.0	Production Release

## Disclaimers

No license (express or implied, by estoppel or otherwise) to any intellectual property rights is granted by this document.

Intel disclaims all express and implied warranties, including without limitation, the implied warranties of merchantability, fitness for a particular purpose, and non-infringement, as well as any warranty arising from course of performance, course of dealing, or usage in trade.

The products and services described may contain defects or errors known as errata which may cause deviations from published specifications. Current characterized errata are available on request.

You may not use or facilitate the use of this document in connection with any infringement or other legal analysis concerning Intel products described herein. You agree to grant Intel a non-exclusive, royalty-free license to any patent claim thereafter drafted which includes subject matter disclosed herein.

Intel, the Intel logo, are trademarks of Intel Corporation in the U.S. and/or other countries.

\*Other names and brands may be claimed as the property of others.

© Intel Corporation.



# Safety Information

## **Important Safety Instructions**

Read all caution and safety statements in this document before performing any of the instructions. See also Intel Server Boards and Server Chassis Safety Information at

<http://www.intel.com/support/motherboards/server/sb/cs-010770.htm>.

## **Wichtige Sicherheitshinweise**

Lesen Sie zunächst sämtliche Warnund Sicherheitshinweise in diesem Dokument, bevor Sie eine der Anweisungen ausführen. Beachten Sie hierzu auch die Sicherheitshinweise zu Intel-Serverplatinen und Servergehäusen auf der

<http://www.intel.com/support/motherboards/server/sb/cs-010770.htm>.

## **Consignes de sécurité**

Lisez attention toutes les consignes de sécurité et les mises en garde indiquées dans ce document avant de suivre toute instruction. Consultez Intel Server Boards and Server Chassis Safety Information sur le site

<http://www.intel.com/support/motherboards/server/sb/cs-010770.htm>.

## **Instrucciones de seguridad importantes**

Lea todas las declaraciones de seguridad y precaución de este documento antes de realizar cualquiera de las instrucciones. Vea Intel Server Boards and Server Chassis Safety Information en

<http://www.intel.com/support/motherboards/server/sb/cs-010770.htm>.

## **重要安全指导**

在执行任何指令之前，请阅读本文档中的所有注意事项及安全声明。和/或

<http://www.intel.com/support/motherboards/server/sb/cs-010770.htm> 上的 *Intel® Server Boards and Server Chassis Safety Information*（《Intel 服务器主板与服务器机箱安全信息》）。

## Warnings

**Heed safety instructions:** Before working with your server product, whether you are using this guide or any other resource as a reference, pay close attention to the safety instructions. You must adhere to the assembly instructions in this guide to ensure and maintain compliance with existing product certifications and approvals. Use only the described, regulated components specified in this guide. Use of other products/components will void the UL listing and other regulatory approvals of the product and will most likely result in noncompliance with product regulations in the region(s) in which the product is sold.

**System power on/off:** The power button DOES NOT turn off the system AC power. To remove power from the system, you must unplug the AC power cord from the wall outlet. Make sure the AC power cord is unplugged before you open the chassis, add, or remove any components.

**Hazardous conditions, devices and cables:** Hazardous electrical conditions may be present on power, telephone, and communication cables. Turn off the server and disconnect the power cord, telecommunications systems, networks, and modems attached to the server before opening it. Otherwise, personal injury or equipment damage can result.

**Installing or removing jumpers:** A jumper is a small plastic encased conductor that slips over two jumper pins. Some jumpers have a small tab on top that you can grip with your fingertips or with a pair of fine needle nosed pliers. If your jumpers do not have such a tab, take care when using needle nosed pliers to remove or install a jumper; grip the narrow sides of the jumper with the pliers, never the wide sides. Gripping the wide sides can damage the contacts inside the jumper, causing intermittent problems with the function controlled by that jumper. Take care to grip with, but not squeeze, the pliers or other tool you use to remove a jumper, or you may bend or break the pins on the board.

**Slide / Rail mounted equipment is not to be used as a shelf or a work space**



### Electrostatic Discharge (ESD)

Electrostatic discharge can cause damage to your computer or the components within it. ESD can occur without the user feeling a shock while working inside the system chassis or while improperly handling electronic devices like processors, memory or other storage devices, and add-in cards.



Intel recommends the following steps be taken when performing any procedures described within this document or while performing service to any computer system.

- Where available, all system integration and/or service should be performed at a properly equipped ESD workstation
- Wear ESD protective gear like a grounded antistatic wrist strap, sole grounders, and/or conductive shoes
- Wear an anti-static smock or gown to cover any clothing that may generate an electrostatic charge
- Remove all jewelry
- Disconnect all power cables and cords attached to the server before performing any integration or service
- Touch any unpainted metal surface of the chassis before performing any integration or service
- Hold all circuit boards and other electronic components by their edges only
- After removing electronic devices from the system or from their protective packaging, place them component side up on to a grounded anti-static surface or conductive foam pad. Do not place electronic devices on to the outside of any protective packaging.

# Preface

## About this document

This document is written for system integrators and service technicians who are responsible for system assembly, server upgrades, server repair, and component replacement.

This document is divided into two major sections. The first half of the document provides detailed instructions on how to assemble a system from the bare chassis to a functional server. It will guide you through the installation of system components and available accessories. The second half of the document is focused on system service. It provides many reference diagrams used to identify all key physical features of the system. It also provides detailed instructions for the replacement of field replaceable components.

For the latest revision of this document, go to <http://www.intel.com/support>

## Document Organization

### System Integration

**Chapter 1 — Server Building Block System Integration** – provides grounds up assembly instructions for the integration of individual server building blocks, starting with a bare chassis option and installing all the system boards and major server components, including power supply and system fans. This chapter can be skipped if the server board and other major components are pre-installed in the system.

**Chapter 2 – Essential System Component Integration and Service** – provides instructions for adding essential system components required to complete the integration of the server system. This includes installation of Processors, Memory, Add-in Cards, and storage devices

**Chapter 3 – Options and Accessory Kit Integration and Service** – provides instructions for adding and removing various system options and available accessory option kits that maybe installed in the system.

**Chapter 4 – System Software Updates and Configuration** - provides instructions for completing the integration of the server system by updating the system software and accessing the BIOS Setup utility to configure various system settings.

**Chapter 5 – System Packaging Assembly** – Provides package assembly instructions when re-using the Intel packaging the system was originally shipped in.

### System Service

**Chapter 6 - System Features Overview** – provides a high level overview of the Intel® Server System R2000WF product family. In this chapter, you will find a list of the server system features and illustrations identifying the major system components.

**Chapter 7 – FRU Replacement** – provides guidance for the replacement of system components considered as field replaceable units (FRUs).

**Appendix A – Getting Help**

**Appendix B – System Status LED Operating States and Definition**

**Appendix C – POST Code Diagnostic LED Decoder Table**

**Appendix D – POST Code Error**

## Additional Information and Software

For additional information about this family of products or any of their supported accessories, refer to the following resources available at: <http://www.intel.com/support>

**Table 1. Server System References**

For this information or software	Use this Document or Software
For in-depth technical information about this product family	<ul style="list-style-type: none"> <li>Intel® Server Board S2600WF Technical Product Specification</li> <li>Intel® Server System R2000WF Product Family Technical Product Specification</li> <li>Intel® Remote Management Module 4 (Intel® RMM4) and Integrated BMC User Guide</li> <li>Intel® Remote Management Module 4 Technical Product Specification</li> <li>Intel® Server System BIOS Setup Utility Guide</li> <li>Product Safety and Regulatory Compliance - Intel® Xeon® processor Scalable Family</li> </ul>
For system integration instructions and service guidance	<ul style="list-style-type: none"> <li>Intel® Server System R2000WF Product Family System Integration and Service Guide</li> </ul>
For server configuration guidance and compatibility	<ul style="list-style-type: none"> <li>Intel® S2600WF Product Family Configuration Guide</li> <li>Intel on-line Server Configurator Tool</li> </ul>
For system power budget guidance	Intel® Server Board S2600WF Product Family Power Budget Tool and Thermal Configuration Guide
For system firmware updates, onboard device drivers, and software to manage your Intel® Server System	<a href="http://downloadcenter.intel.com/">http://downloadcenter.intel.com/</a> .
For a complete list of supported processors, memory, add-in cards, and peripherals	Intel online Server Configurator Tool

The server system has support for several software utilities which can be used to configure system parameters and aid in troubleshooting system issues. All available utilities can be downloaded from the following Intel web site: <http://downloadcenter.intel.com/>.

**Table 2. System Utility Software**

To do this:	Use this utility:
To obtain full system information	Intel® SYSINFO Utility – Various OS support
To read System Event Log (SEL)	Intel® SELVIEW Utility – Various OS support
Configure, Save and Restore various system options	Intel® SYSCFG Utility – Various OS support
Test onboard feature functionality	Intel® Platform Confidence Test (PCT) – uEFI only
To update system software	<ul style="list-style-type: none"> <li>System Update Package (SUP) – uEFI only</li> <li>Intel® One Boot Flash Update (OFU) – Various OS Support</li> </ul>
To configure and manage Intel® RAID Controllers	Intel® RAID Web Console 2 Utility – Various OS support
Server Management Software	Intel® Active System Console

# Table of Contents

<b>1</b>	<b>Server Building Block System Integration</b>	<b>17</b>
1.1	Intel® Server Chassis Identification	18
1.1.1	Chassis Component Identification	18
1.2	Prepare Chassis for Assembly	19
1.3	System Assembly	21
1.3.1	8 x 2.5" Front Drive Bay Module Installation (Intel® Server Chassis R2000WFxxx and Intel® Server System R2208WFxxxx)	22
1.3.2	Internal Cable Routing and Connections	24
1.3.3	PCIe NVMe Support	30
1.3.4	Riser Card Assembly	30
1.3.5	Power Supply Installation	31
<b>2.</b>	<b>Essential System Component Installation and Service</b>	<b>32</b>
2.1	Internal Cable Routing Channels	33
2.2	System Cover Removal / Installation	34
2.2.1	System Cover Removal	34
2.2.2	System Cover Installation	34
2.3	Air Duct Removal / Installation	35
2.3.1	Air Duct Removal	35
2.3.2	Air Duct Installation	35
2.4	System Fan Module Removal / Installation	36
2.4.1	System Fan Module Removal	36
2.4.2	System Fan Module Installation	37
2.5	Processor Assembly, Installation, and Replacement	38
2.5.1	PHM Assembly	39
2.5.2	Processor Installation	41
2.5.3	Processor Replacement	44
2.6	Memory Module (DIMM) Installation and Replacement	46
2.6.1	DDR4 DIMM Installation	48
2.6.2	DDR4 DIMM Replacement	48
2.7	Drive Carrier Extraction, Installation, and Assembly	49
2.7.1	Drive Carrier Extraction	49
2.7.2	Drive Carrier Installation	49
2.7.3	2.5" HDD / SSD Drive Carrier Assembly	50
2.7.4	3.5" HDD/SSD Drive Carrier Assembly	51
2.7.5	2.5" SSD into a 3.5" Drive Carrier Assembly	52
2.8	Internal Fixed Mount SATA SSD – Installation / Removal	55
2.8.1	Internal Fixed Mount Solid State Drive Installation	55
2.8.2	Internal Fixed Mount Solid State Drive Removal	56
2.9	Riser Card Bracket Assembly - Removal / Integration / Installation	57
2.9.1	Riser Card Bracket Removal	57

2.9.2	PCI Add-in Card Installation .....	58
2.9.3	Riser Card Bracket Installation .....	59
2.10	PCIe* NVMe SSD Support.....	60
2.10.1	Installing the Intel® VROC Upgrade Key .....	61
2.10.2	Removing the Intel® VROC Upgrade Key.....	61
2.10.3	NVMe* Drive Population Rules for Intel® VROC .....	61
<b>3.</b>	<b>Configuration Options and Accessory Kit Integration and Service.....</b>	<b>66</b>
3.1	Power Supply Module – Installation / Removal .....	67
3.1.1	2 <sup>nd</sup> Power Supply Module Installation .....	67
3.1.2	Power Supply Module Removal.....	67
3.1.3	Power Cord Retention Strap Installation .....	68
3.2	ESRT2 SATA RAID 5 Upgrade Key – Installation / Removal.....	69
3.2.1	ESRT2 SATA RAID 5 Upgrade Key Installation .....	69
3.2.2	ESRT2 SATA RAID 5 Upgrade Key Removal .....	69
3.3	Intel® Remote Management Module 4 Lite Key – Installation / Removal.....	70
3.3.1	Intel® RMM4 Lite Key Installation .....	70
3.3.2	Intel® RMM4 Lite Key Removal .....	70
3.4	Trusted Platform Module (TPM) Installation.....	71
3.5	M.2 Memory Devices.....	71
3.5.1	M.2 Installation.....	71
3.5.2	M.2 Removal.....	72
3.6	OCP Expansion Module – Installation / Removal .....	73
3.6.1	OCP Expansion Module Installation.....	73
3.6.2	OCP Expansion Module Removal.....	74
3.7	Intel® SAS RAID Module Installation/Removal.....	75
3.7.1	Intel® SAS RAID Module Installation .....	75
3.7.2	Intel® SAS RAID Module Removal.....	75
3.8	Intel® RAID Maintenance Free Backup Unit (RMFBU) – Mounting Bracket Installation .....	76
3.9	Intel® Omni-Path IFT Carrier Accessory Kit Installation.....	77
3.9.1	Intel® Omni-path IFT Carrier Kit (iPC AWF1PFABKITM) – Installation .....	77
3.9.2	Intel® Omni-path IFT Carrier Kit (iPC AWF1PFABKITP) – Installation .....	79
3.10	2 x 2.5” Rear Mount Backplane Module Accessory Kit (iPC- A2UREARHSDK1).....	82
3.11	Intel® SAS Expander Card Installation.....	85
3.11.1	2.5” Front Drive Bay Support .....	85
3.11.2	3.5” Front Drive Bay Support .....	86
3.11.3	Intel® RAID Expander Card Cabling Overview .....	86
3.12	R2208WF Upgrade to 16 Drive Configuration.....	87
3.13	24 Drive Upgrade Option.....	88
<b>4.</b>	<b>System Software Updates and Configuration.....</b>	<b>93</b>
4.1	Updating the System Software Stack.....	93
4.2	Using the BIOS Setup Utility.....	93
4.2.1	Entering BIOS Setup .....	93

4.2.2	No Access to the BIOS Setup Utility.....	93
4.2.3	Navigating the BIOS Setup Utility.....	94
<b>5.</b>	<b>System Packaging Assembly Instructions .....</b>	<b>96</b>
<b>6.</b>	<b>System Service- System Features Overview .....</b>	<b>101</b>
6.1	System Feature Reference Diagrams.....	101
6.1.1	Front Drive Bay Options .....	102
6.1.2	Control Panel Features .....	103
6.1.3	Front I/O Features (Non-Storage Systems).....	104
6.1.4	Back Panel Features.....	105
6.1.5	Server Board Features.....	105
6.2	System Configuration and Recovery Jumpers .....	107
6.2.1	BIOS Default Jumper Block .....	108
6.2.2	Password Clear Jumper Block.....	108
6.2.3	Management Engine (ME) Firmware Force Update Jumper Block.....	109
6.2.4	BMC Force Update Jumper Block .....	109
6.2.5	BIOS Recovery Jumper .....	110
6.2.6	Serial Port 'A' Configuration Jumper .....	111
<b>7.</b>	<b>System Service - FRU Replacement .....</b>	<b>112</b>
7.1	System Fan Replacement.....	113
7.1.1	To remove a failed system fan.....	113
7.1.2	To install a new system fan.....	113
7.2	Replacing the System Battery.....	114
7.3	Standard Rack Handle – Installation / Removal.....	115
7.3.1	Standard Rack Handle Installation .....	115
7.3.2	Standard Rack Handle Removal .....	115
7.4	Standard Front Control Panel Replacement (R2308WFxxx) .....	116
7.4.1	Standard Front Control Panel Removal (R2308WFxxx).....	116
7.4.2	Standard Front Control Panel Installation (R2308WFxxx).....	117
7.5	Standard Front Control Panel Replacement (R2208WFxxx) .....	119
7.5.1	Standard Front Control Panel Removal (R2208WFxxx).....	119
7.5.2	Standard Front Control Panel Installation (R2208WFxxx).....	120
7.6	Replacing the Server Board .....	122
7.6.1	Server Board Removal .....	122
7.6.2	Server Board Installation .....	123
<b>Appendix A.</b>	<b>Getting Help .....</b>	<b>125</b>
<b>Appendix B.</b>	<b>System Status LED Operating States and Definition .....</b>	<b>126</b>
<b>Appendix C.</b>	<b>POST Code Diagnostic LED Decoder Table .....</b>	<b>128</b>
<b>Appendix D.</b>	<b>POST Code Errors .....</b>	<b>134</b>

## List of Figures

Figure 1. Intel® Server Chassis R2000WFxxx – No Installed Front Drive Accessory Kit Options.....	18
Figure 2. Chassis Components .....	18
Figure 3. Chassis Cover Removal.....	19
Figure 4. System Fan Module Removal.....	20
Figure 5. Server Board Installation .....	21
Figure 6. Air Duct Side Wall Installation .....	22
Figure 7. R2000WFxxx Drive Bay Retention Bracket Removal.....	22
Figure 8. Drive Bay Filler Panel Removal.....	23
Figure 9. 8 x 2.5" Drive Bay Module Installation.....	23
Figure 10. Drive Bay Retention Bracket Installation .....	24
Figure 11. Internal Cable Routing Channels .....	25
Figure 12. Front Control Panel and Front I/O Internal Cable Connections .....	26
Figure 13. Hot Swap Backplane Connectors .....	27
Figure 14. 2.5" Drive Module Hot Swap Backplane Power Cable .....	27
Figure 15. HSBP POWER Connector .....	27
Figure 16. I <sup>2</sup> C cable.....	28
Figure 17. Hot Swap Backplane I <sup>2</sup> C Internal Cable Connector.....	28
Figure 18. Dual 8x2.5" Hot Swap Backplane I <sup>2</sup> C Jumper Cable Installation.....	29
Figure 19. SATA Cable.....	29
Figure 20. Onboard Connectors for Embedded SATA Support (S2600WFT and S2600WF0 only).....	30
Figure 21. Riser Card Assembly.....	30
Figure 22. Power Supply Installation .....	31
Figure 23. Internal Cable Routing Channels .....	33
Figure 24. System Cover Removal .....	34
Figure 25. System Cover Installation .....	34
Figure 26. Air Duct Removal .....	35
Figure 27. Air Duct Installation .....	35
Figure 28. System Fan Module Removal.....	36
Figure 29. System Fan Module Installation.....	37
Figure 30. Processor Heat Sink Module (PHM) Reference Diagram.....	38
Figure 31. Processor Heat Sink Handling.....	39
Figure 32. PHM Assembly – Heat Sink Orientation.....	39
Figure 33. Processor Carrier Clip Assembly.....	40
Figure 34. Processor Carrier Clip Sub-Assembly.....	40
Figure 35. Processor Clip Sub-assembly to Heat Sink Orientation .....	41
Figure 36. Processor Heat Sink Module (PHM).....	41
Figure 37. Plastic processor socket cover removal .....	42
Figure 38. Processor Installation Alignment Features.....	42
Figure 39. PHM Alignment to Bolster Plate.....	43
Figure 40. Correct PHM Placement .....	43



Figure 41. Installing the PHM .....	44
Figure 42. Uninstalling the Processor Heat Sink Module (PHM) .....	44
Figure 43. Plastic Processor Socket Cover Installation .....	45
Figure 44. PHM Disassembly .....	45
Figure 45. Releasing the Processor Carrier Clip from the Heat Sink .....	46
Figure 46. Releasing Processor from Processor Clip .....	46
Figure 47. DIMM Blank .....	47
Figure 48. Memory Slot Population Requirements – 8x2.5, 16x2.5, 8x3.5 Front Drive Configurations .....	47
Figure 49. Memory Slot Population Requirements – 24x2.5, 12x3.5 Front Drive Configurations .....	47
Figure 50. DIMM Installation .....	48
Figure 51. DIMM Removal .....	48
Figure 52. Drive Carrier Extraction from Chassis .....	49
Figure 53. Drive Carrier into Chassis Installation .....	49
Figure 54. 2.5" Drive Carrier Assembly – Drive / Drive Blank Removal .....	50
Figure 55. 2.5" Drive Carrier Assembly – Drive Installation to Carrier .....	50
Figure 56. 2.5" Drive Carrier Assembly – Alignment Features .....	51
Figure 57. 3.5" Drive Carrier Assembly - Drive / Drive Blank Removal .....	51
Figure 58. 3.5" Drive Carrier Assembly – Drive Installation to Carrier .....	52
Figure 59. 3.5" Drive Carrier Assembly – Drive Blank Removal .....	52
Figure 60. 3.5" Drive Carrier to 2.5" SSD Bracket – Tab Removal .....	53
Figure 61. 3.5" Drive Carrier to 2.5" SSD Bracket – Mount SSD to Bracket .....	53
Figure 62. 3.5" Drive Carrier to 2.5" SSD Bracket – Mount Bracket Assembly to Carrier .....	54
Figure 63. 3.5" Drive Carrier to 2.5" SSD Bracket – Secure SSD to Carrier .....	54
Figure 64. Peripheral Device Power Cable .....	55
Figure 65. Onboard Peripheral Power and SATA Connectors for Internal SSD support .....	55
Figure 66. Internal Fixed Mount SSD Placement .....	56
Figure 67. Internal Fixed Mount SSD Removal .....	56
Figure 68. Riser Card Brackets .....	57
Figure 69. Riser Card Bracket Removal .....	57
Figure 70. PCI Add-In Card Installation .....	58
Figure 71. Riser Card Bracket Installation .....	59
Figure 72. Installing the Intel® VROC Upgrade Key .....	61
Figure 73. Backplane Cabling from Two PCIe Sources .....	62
Figure 74. Power Supply Module Installation .....	67
Figure 75. Power Supply Module Removal .....	67
Figure 76. Power Cord Retention Strap Installation .....	68
Figure 77. Plugging the Power Cable .....	68
Figure 78. SATA RAID 5 Upgrade Key Installation .....	69
Figure 79. Intel® RMM4 Lite Key Installation .....	70
Figure 80. Trusted Platform Module (TPM) Installation .....	71
Figure 81. M.2 SSD Connector Locations .....	71
Figure 82. M.2 Device Installation .....	72

Figure 83. M.2 Device Removal .....	72
Figure 84. OCP Expansion Module Installation .....	73
Figure 85. OCP Expansion Module Removal .....	74
Figure 86. Intel® SAS RAID Module Installation.....	75
Figure 87. Intel® RMFBU Installation .....	76
Figure 88. IFT Carrier Mezzanine Card Assembly.....	77
Figure 89. IFT Mezzanine Card Installation .....	78
Figure 90. Fabric Processor Cable Installation .....	78
Figure 91. Onboard Omni-path Sideband Signal Connectors.....	79
Figure 92. IFT Carrier Add-in Card Assembly.....	80
Figure 93. IFT Carrier Add-in Card Installation.....	80
Figure 94. Fabric Processor Cable Installation .....	81
Figure 95. 2 x 2.5" Rear Mount Backplane Module Installation.....	82
Figure 96. Rear HSBP Power Cable.....	82
Figure 97. Rear HSBP I2C Cable.....	82
Figure 98. Rear HSBP SATA & SGPIO Cable Bundle.....	83
Figure 99. Rear Backplane Cable Connectors .....	83
Figure 100. SAS Expander Mezzanine Card Installation.....	85
Figure 101. 12 Gb Intel® RAID Expander Card RES3FV288 Connector Identification.....	86
Figure 102. Internal 12 Gb Intel® RAID Expander Card RES3TV360 - Connector Identification Block Diagram .....	86
Figure 103. Standard Rack Handle Removal .....	88
Figure 104. Drive Bay Disassembly – Retention Bracket Removal.....	89
Figure 105. Drive Bay Disassembly – Module Removal .....	90
Figure 106. Storage Rack Handle Installation .....	90
Figure 107. Server Board USB 2.0 Header.....	91
Figure 108. Installing the 8 x 2.5" Drive Bay Module(s).....	91
Figure 109. Installing Drive Bay Retention Bracket.....	92
Figure 110. Intel® Server System R2000WF Features Overview.....	101
Figure 111. No Drives – Chassis only building block (Intel® Server Chassis R2000WFXXX).....	102
Figure 112. 8 x 3.5" Drive Bay Configuration (Intel® Server System R2308WF....) .....	102
Figure 113. 12 x 3.5" Drive Bay Configuration (Intel® Server System R2312WF... – Storage System) .....	102
Figure 114. 8 x 2.5" Drive Bay Configuration (Intel® Server System R2208WF....) .....	102
Figure 115. 16 x 2.5" Drive Bay Configuration (Intel® Server System R2208WF.... + 8x2.5" drive option) .....	103
Figure 116. 24 x 2.5" Drive Bay Configuration (Intel® Server System R2224WF.... – Storage System) .....	103
Figure 117. Control Panel Features.....	103
Figure 118. Front I/O Panel Features.....	104
Figure 119. Hot Swap Drive Carrier LED Identification .....	104
Figure 120. Back Panel Features.....	105
Figure 121. Server Board Feature Identification .....	105
Figure 122. Intel® Light-Guided Diagnostic LEDs - Server Board .....	106
Figure 123. DIMM Fault LEDs .....	107

Figure 124. System Configuration and Recovery Jumpers .....	107
Figure 125. System Fan Removal .....	113
Figure 126. Replacing the Backup Battery.....	114
Figure 127. Standard Rack Handle Installation .....	115
Figure 128. Standard Rack Handle Removal .....	115
Figure 129. Removing the Drive Bay Module .....	116
Figure 130. Control Panel Board Removal .....	117
Figure 131. Control Panel Board Installation .....	117
Figure 132. 3.5"x8 Drive Bay Module Installation .....	118
Figure 133. 3.5"x8 Drive Bay Module Retention Clip Installation.....	118
Figure 134. I/O Bay Module Remova .....	120
Figure 135. Control Panel Board Installation .....	120
Figure 136. I/O Bay Module Installation .....	121
Figure 137. Retention Bracket Installation .....	121
Figure 138. Server Board Removal .....	122
Figure 139. Server Board Installation .....	123
Figure 140. Air Duct Sidewall Installation.....	124
Figure 141. POST Diagnostic LED Location .....	128

## List of Tables

Table 1. Server System References.....	8
Table 2. System Utility Software.....	8
Table 3. BIOS Setup: Keyboard Command Bar .....	94
Table 4. System Status LED State Definitions.....	126
Table 5. POST Progress Code LED Example.....	128
Table 6. MRC Progress Codes.....	129
Table 7. MRC Fatal Error Codes .....	130
Table 8. POST Progress Codes.....	131
Table 9. POST Error Messages and Handling.....	135
Table 10. POST Error Beep Codes.....	139
Table 11. Integrated BMC Beep Codes .....	139

# 1 Server Building Block System Integration

---

## Purpose

This chapter provides instructions for the integration of the following Intel server building blocks:

### Intel® Server Chassis R2000WFxxx

- + Any server board from the Intel® Server Board S2600WF product family
- + Available 2.5" drive bay options

If your system came with the server board pre-installed in the chassis, you can skip this chapter and proceed to *Chapter 2 - Essential System Component Installation and Service* to continue the system integration.

In addition to the Intel Server building blocks defined above, the following system components (Sold Separately) will also be needed to complete the full system integration:

- Appropriate SAS/SATA Data Cables
- Appropriate PCIe OCuLink Data Cables for NVMe support
- Appropriate Riser Card(s)
- Appropriate Power Supply Module(s)
- Processor(s) – Intel® Xeon® processor Scalable family
- Memory - DDR4 DIMMs
- Appropriate Power Cable(s)
- Storage Devices – HDDs, SSDs, M.2
- PCIe Add-in Cards
- Optional Server System Accessories

Reference the *Intel® Server S2600WF Product Family Configuration Guide* for a complete list of available accessories and spares

## Before You Begin

Before working with your server product, observe the safety and ESD precautions found in the Warnings section at the beginning of this manual.

### Tools and Supplies Needed

- Anti-static wrist strap and conductive foam pad (recommended)
- Phillips\* (cross head) screwdriver (#1 and #2 bits)
- Torx 30 screwdriver

### System Reference

All references to left, right, front, top, and bottom assume the reader is facing the front of the chassis.

### Instruction Format

Each procedure described in this chapter will follow an illustration first format. This format will give the reader the option to follow a quicker path to system integration by first seeing an illustration of the intended procedure. If necessary, the reader can then follow the step-by-step instructions that will accompany each procedure.

## System Integration Advisory Note

It is highly recommended that the system integration process defined in the following sections within this chapter be performed in the order specified. Following these instructions will result in the proper installation of critical system components and provide recommended cable routing. Deviating from the prescribed process may result in improper system assembly, a longer integration process, and a less than desired system appearance.

## 1.1 Intel® Server Chassis Identification



Figure 1. Intel® Server Chassis R2000WFxxx – No Installed Front Drive Accessory Kit Options

### 1.1.1 Chassis Component Identification

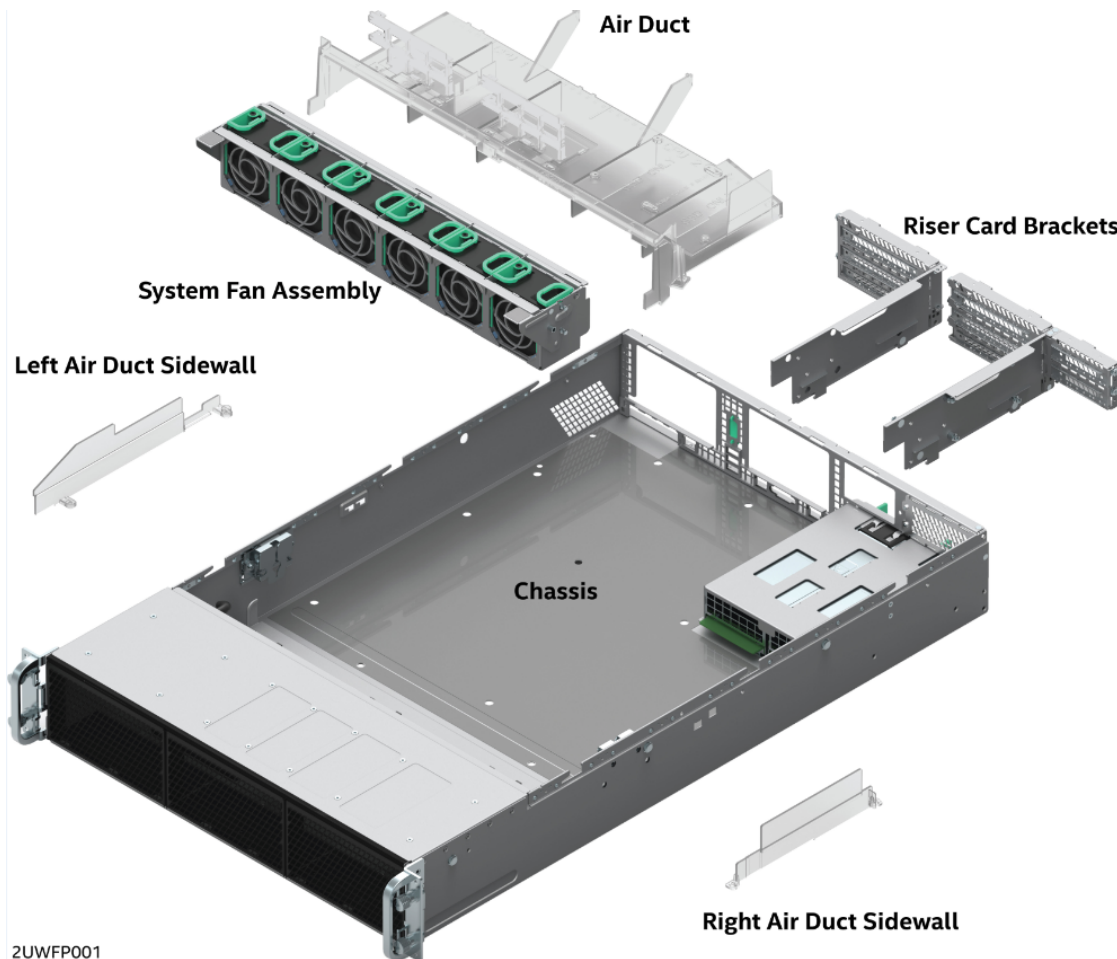


Figure 2. Chassis Components

## 1.2 Prepare Chassis for Assembly

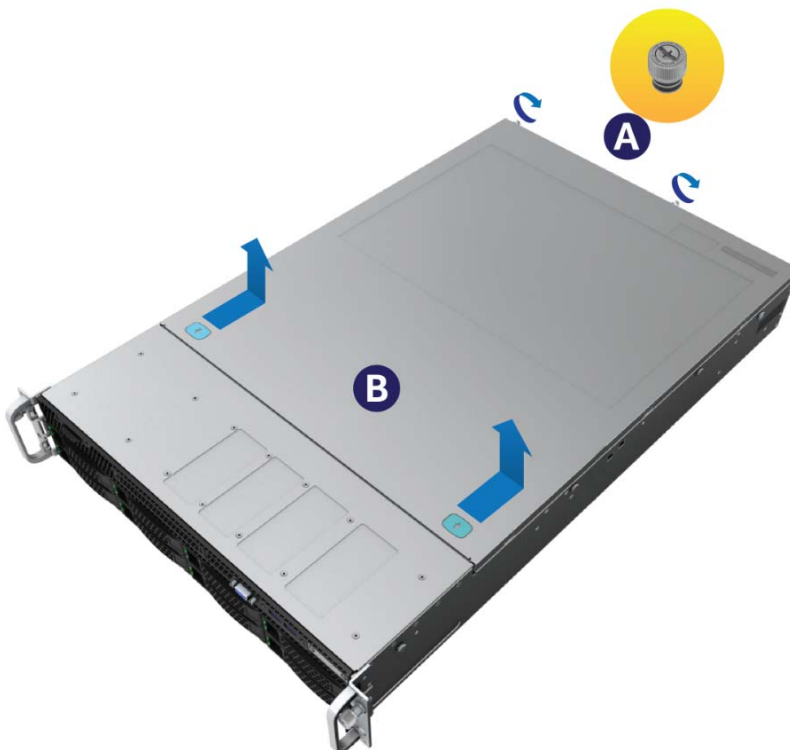
As received, the Intel Server Chassis will include several components within a boxed accessory kit or placed within the chassis.

1. Remove the System Cover

---

**Note:** A non-skid surface or a stop behind the server system may be needed to prevent the server system from sliding on your work surface

---



**Figure 3. Chassis Cover Removal**

- a) Loosen the two captive thumb screws located on the back edge of the system cover (See letter "A")  
Note: New chassis as shipped from Intel will require a screw driver to loosen the thumb screws securing the top cover to the chassis.
- b) Slide cover back and lift upward (see letter "B").

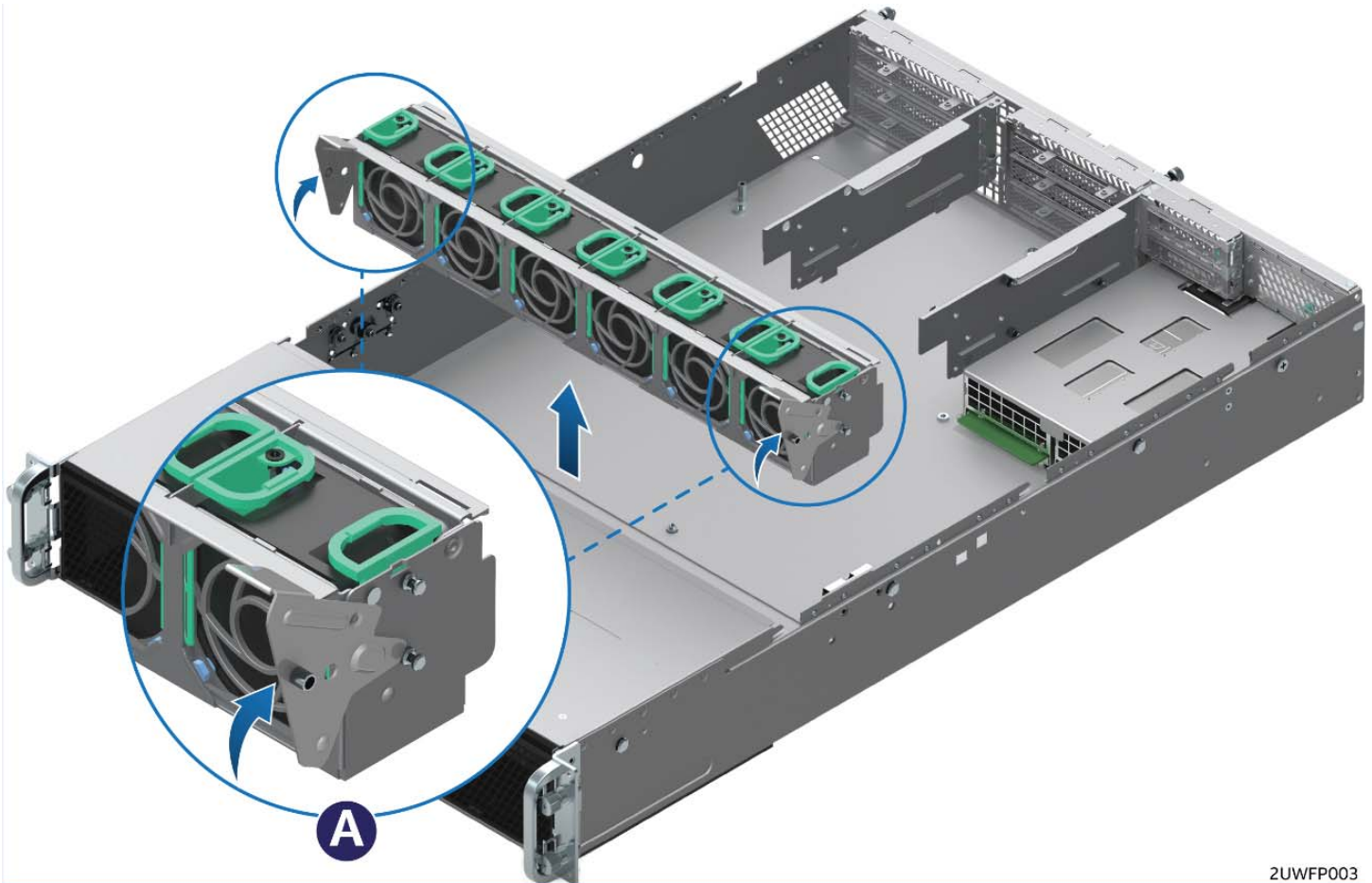
The accessory kit and or system packaging will include the following components:

- The left and right black plastic air duct sidewalls
- Separate bags of screws for mounting the server board and riser card module
- RAID Maintenance Free Backup Unit (RMFBU) mounting plate and screws
- DIMM Blanks
- Black Mylar "No CPU" processor socket spacers

The following components will be found inside the chassis. Each should be removed:

- Clear plastic air duct and sidewalls
- A box with two processor heat sinks
- Two riser card brackets
- The system fan module

2. Remove the System Fan Module



2UWFP003

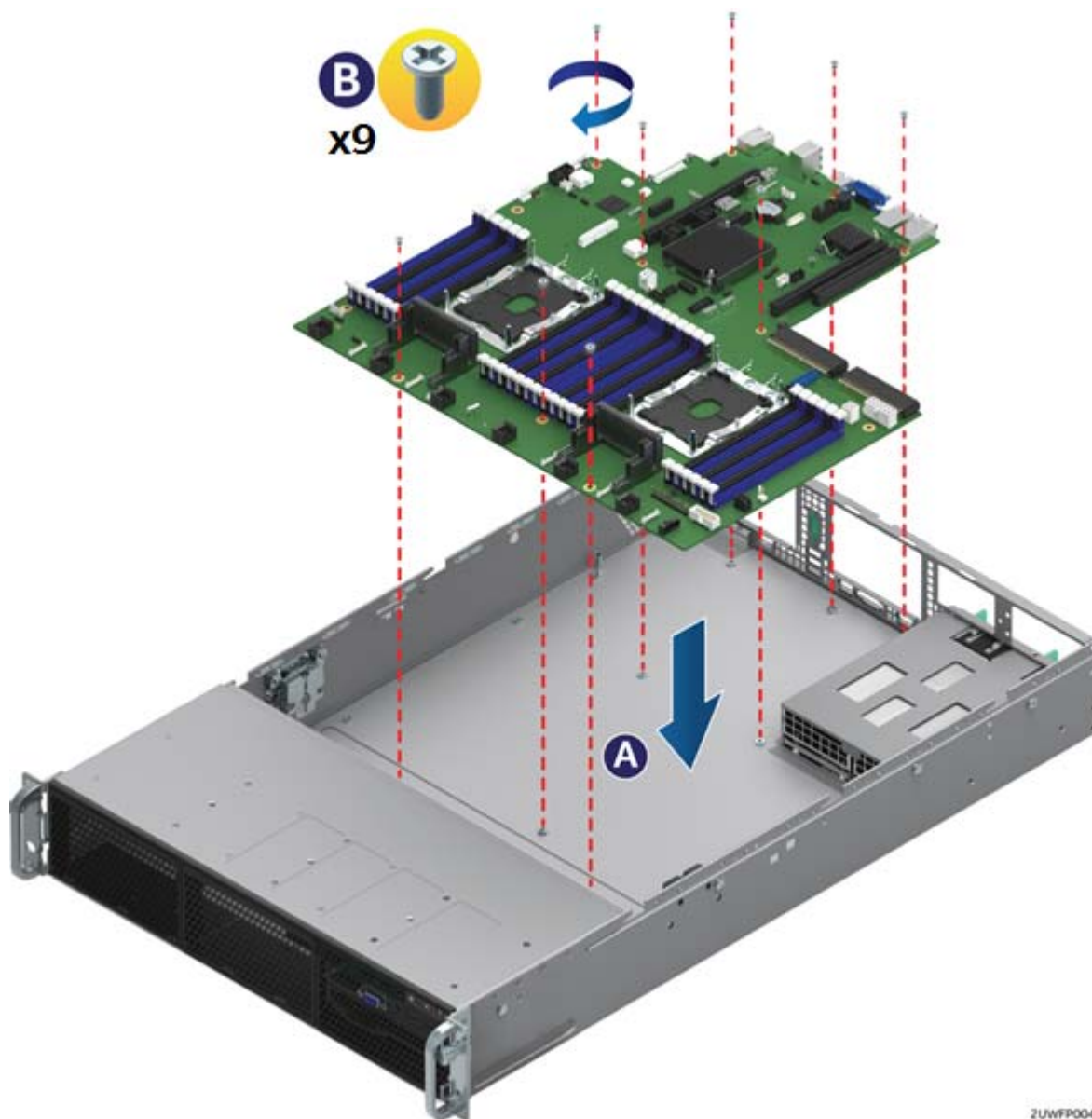
**Figure 4. System Fan Module Removal**

- a) Lift the latches located on each end of the fan module until each latch is fully disengaged from the latch receivers on the chassis side wall.
- b) Grasp each end of the fan module and pull straight up until the module is fully disengaged from the module receivers on the chassis side wall.
- c) Carefully place the fan module face down onto a flat surface. Do NOT rest the fan module on the fan connectors located on the bottom side of the fan module, doing so may damage the connectors.



## 1.3 System Assembly

### 1. Install the Server Board

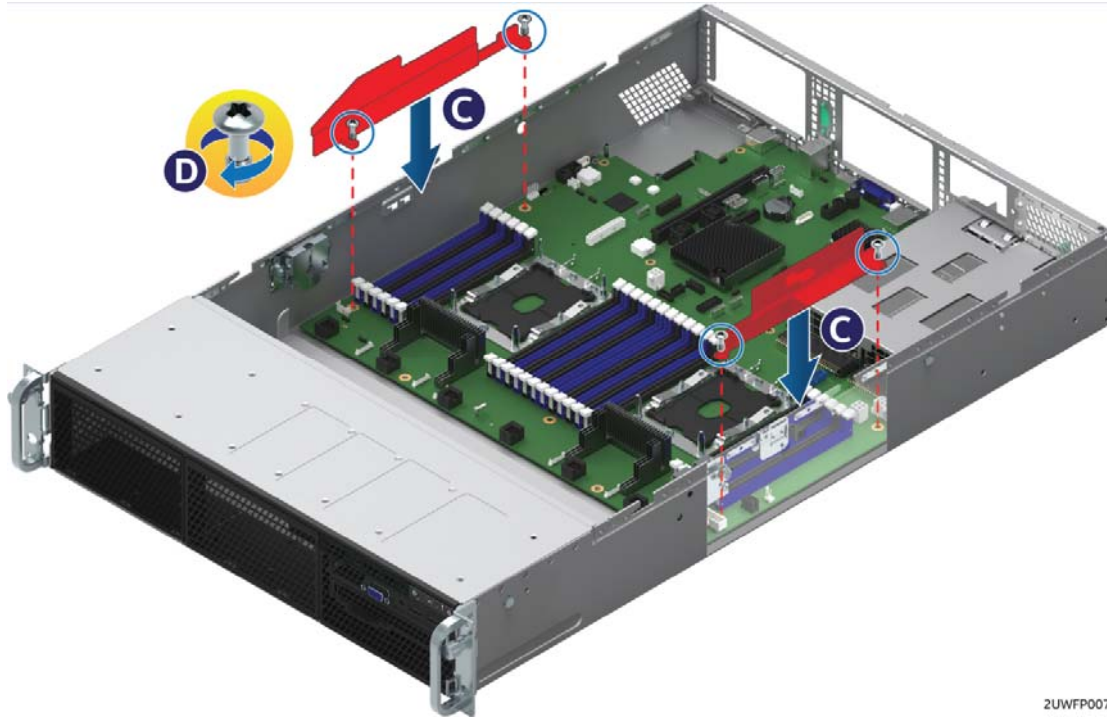


2UWFP004

**Figure 5. Server Board Installation**

- Clear the area for server board placement by carefully moving aside any cables that may be taped to the chassis base.
- Remove power supplies if present.
- Remove the server board from its anti-static bag.
- Holding the server board by its edges, carefully lower the server board into the chassis so that the rear I/O connectors of the server board align with and are fully seated into the matching cut outs on the chassis back panel and each server board mounting hole is aligned with a threaded chassis standoff. (See letter "A")
- The server board is accurately placed when the two end screw holes nearest the front edge of the server board sit securely onto the shouldered chassis standoffs.
- Using 8 in-lb torque, fasten down the server board with 9 screws (See letter "B")

2. Install the Air Duct Side Walls



**Figure 6. Air Duct Side Wall Installation**

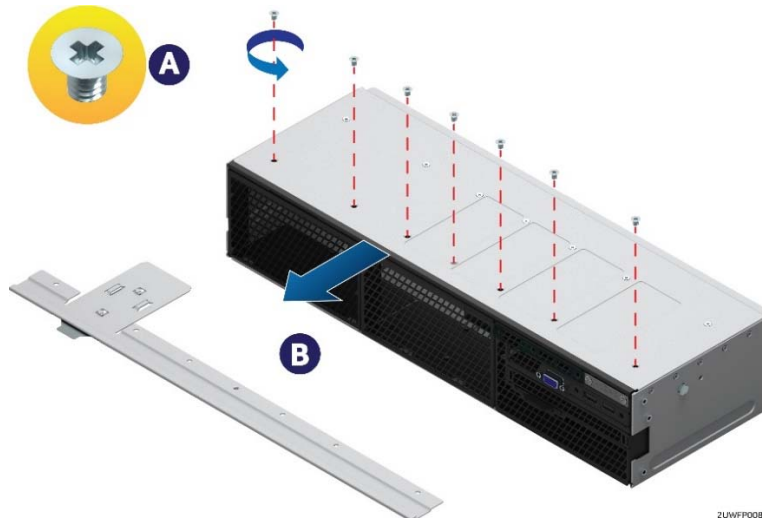
- a) Locate the two black plastic air duct sidewalls from the chassis accessory kit
- b) Following the illustration above, fasten down the appropriate air duct side wall onto each side of the server board using 8 in/lbf torque for each screw. (See Letter “C”)

**1.3.1 8 x 2.5” Front Drive Bay Module Installation (Intel® Server Chassis R2000WFxxx and Intel® Server System R2208WFxxxx)**

Continue with the instructions in this section for installation of several available 8 x 2.5” front drive bay accessory kits into the system. If the final system configuration does not include front drive support, proceed to section 1.3.2

1. Remove the Drive Bay Retention Bracket

The Drive Bay Retention Bracket must be removed in order to remove the Drive Bay Filler Panels.

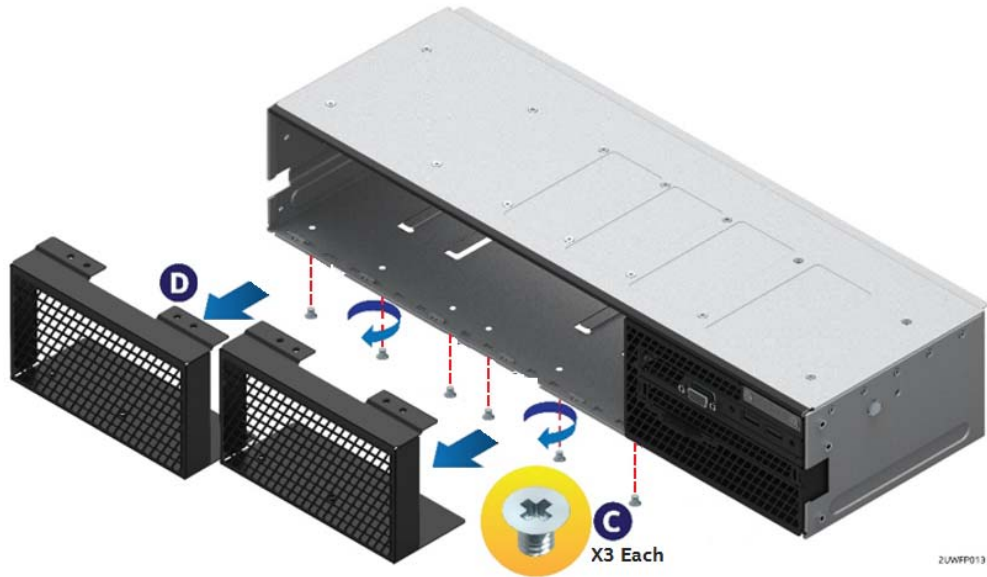


**Figure 7. R2000WFxxx Drive Bay Retention Bracket Removal**

- a) Remove the six (6) screws from the top front edge of the drive bay
- b) Pull the metal bracket straight out.
- c) Set aside the retention bracket and screws for re-installation at a later time.

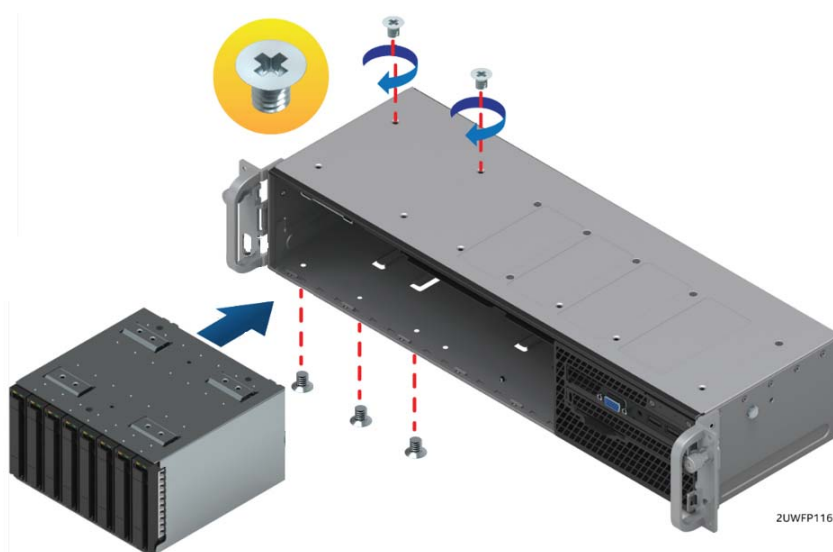
2. Remove Drive Bay Filler Panel(s)

The chassis includes a drive bay filler panel for each drive bay location that doesn't have a drive bay pre-installed. Remove the filler panel for each 8 x 2.5" drive bay module to be installed.



**Figure 8. Drive Bay Filler Panel Removal**

- a) Carefully turn the chassis onto its side, exposing the bottom side of the chassis.
  - b) From the bottom of the chassis, remove the three (3) screw securing the given drive bay filler panel (see Letter 'C').
  - c) Carefully return the chassis to its original position.
  - d) Slide out the drive bay filler panel (see Letter 'D').
3. Insert 8 x 2.5" Drive Bay Module

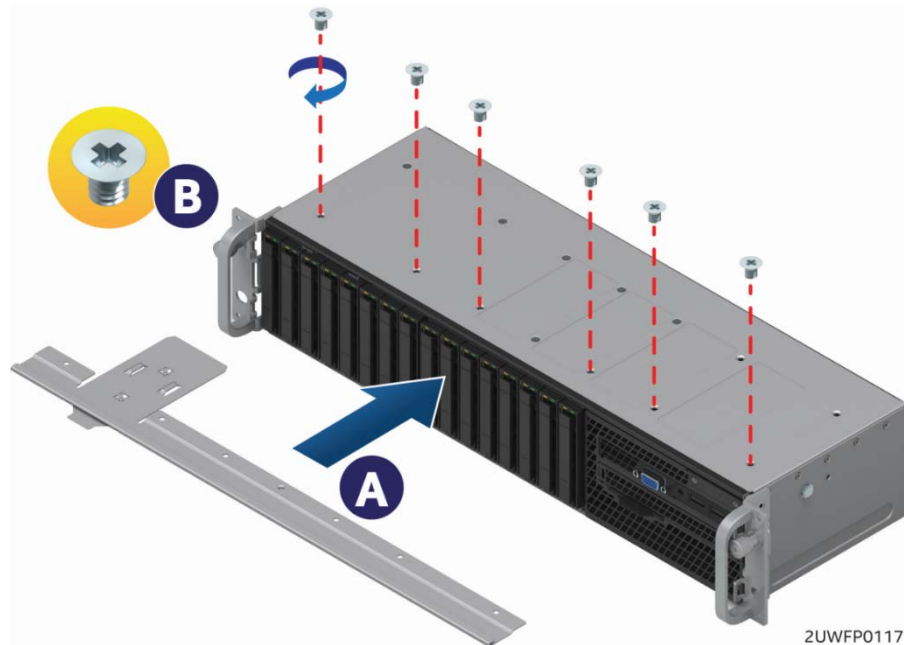


**Figure 9. 8 x 2.5" Drive Bay Module Installation**

- a) Carefully unpack the 8 x 2.5" drive bay module from the accessory kit.
- b) Slide the 8 x 2.5" drive bay module into the server chassis

- c) Using two screws on the top back edge of the drive bay, secure the drive bay to the chassis. (8 in/lbf torque for each screw).
- d) Repeat steps 1-3 for the second drive bay module (if applicable).
- e) Carefully place the chassis on its side, and secure each installed drive bay module with three (3) additional screws on the bottom of the chassis (8 in/lbf torque for each screw).
- f) Carefully return the chassis to its original position.

#### 4. Install Drive Bay Retention Bracket

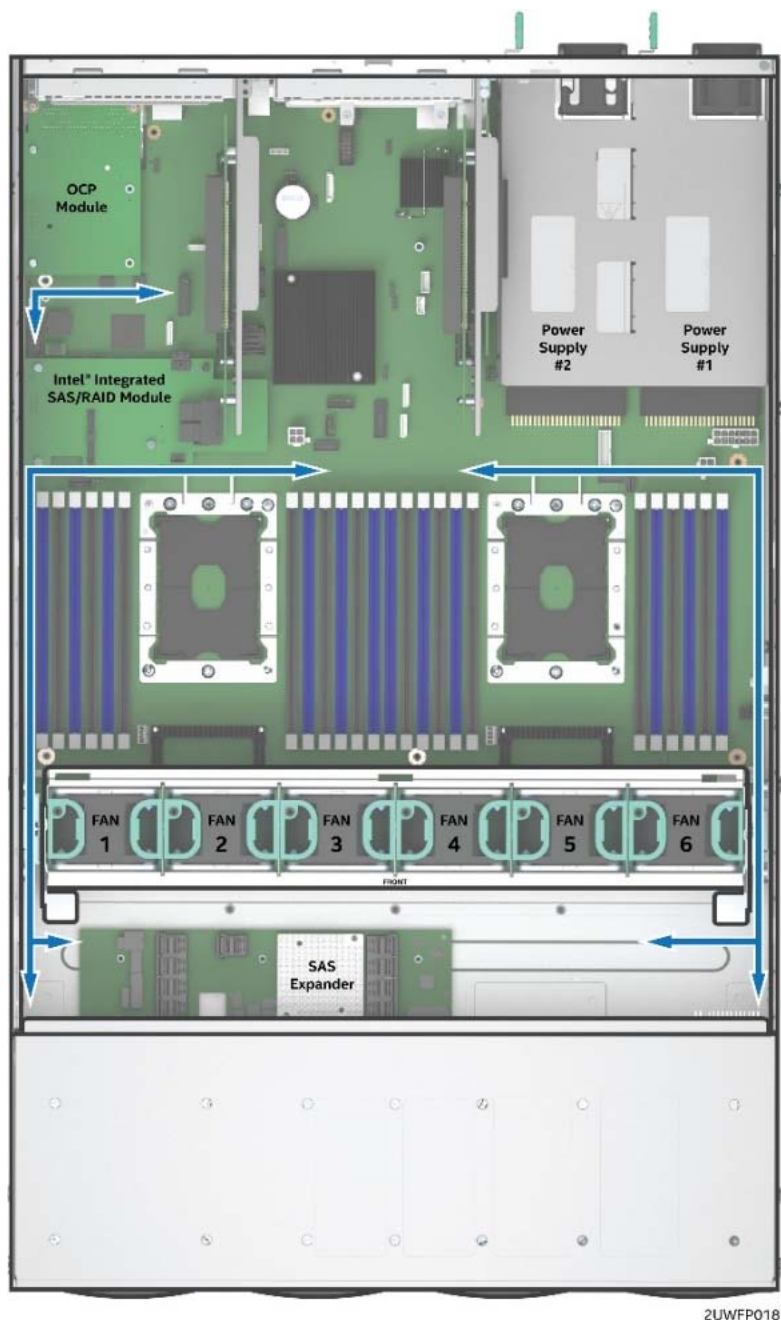


**Figure 10. Drive Bay Retention Bracket Installation**

- a) Locate the drive bay retention bracket and screws.
- b) Carefully slide the drive bay retention bracket straight into the gap between the top of the drive bay module(s) and the underside of the chassis sheet metal. (See Letter 'A').
- c) Secure the retention bracket with six screws (see Letter 'B'). (8 in/lbf torque for each screw).

### 1.3.2 Internal Cable Routing and Connections

All cables in the system that need to be routed from front-to-back, should be routed using the cable channels between the chassis sidewalls and the air duct sidewalls as shown in the following illustration. When routing cables front-to-back, none should be routed through the center of the system or in the area between the system fans and the DIMM slots. Cable connection instructions provided in this section are presented in the recommended order in which they should be installed. See **Error! Reference source not found.** for additional System Cable routing illustrations.

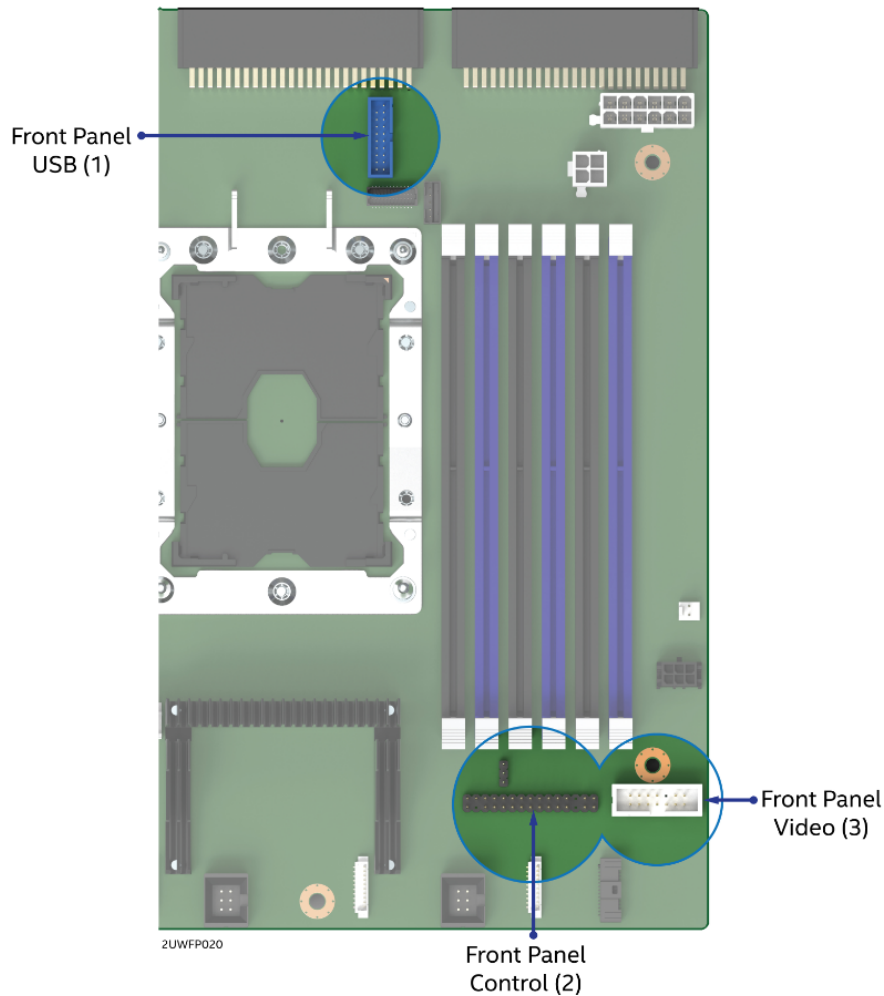


**Figure 11. Internal Cable Routing Channels**

1. Connect Internal Cables for Front Control Panel and Front I/O Module

This system includes front panel USB, Video, Control Buttons, and various LED features that must be cabled to the appropriate connectors on the server board. Cables should be routed in the following order: (1) Front Panel USB, (2) Front Control Panel, and (3) Front Panel Video.





**Figure 12. Front Control Panel and Front I/O Internal Cable Connections**

- a) Route the black round USB cable to the blue 20-pin connector on the server board labeled “FP\_USB2\_11\_13”. The cable should be routed as close to the chassis side wall as possible.
- b) Route the folded 30-pin gray ribbon cable to the matching 30-pin header on the server board labeled “SSI\_FRONT\_PANEL”.
- c) Route the 14-pin gray folded ribbon cable to the 14-pin black shrouded connector on the server board labeled “FP\_VIDEO”.

---

**Note:** With the system fan module assembly removed from the chassis, all three front panel cables should be routed beneath the fan module receiver feature on the right chassis sidewall.

---

System configurations with no front drive bay, can proceed to section 1.3.4

2. Connect the Hot Swap Backplane Power Cable and I<sup>2</sup>C Cables

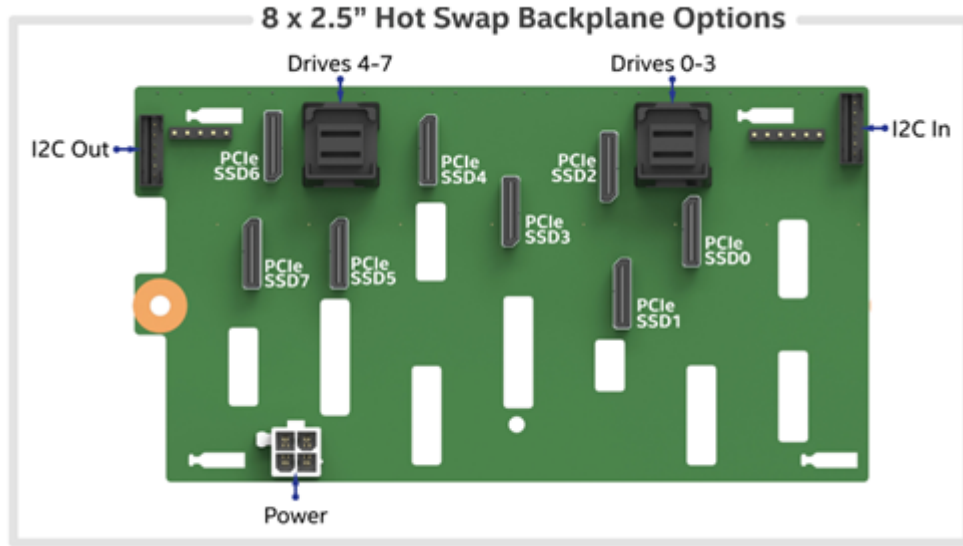


Figure 13. Hot Swap Backplane Connectors

a) Locate the backplane power cable.

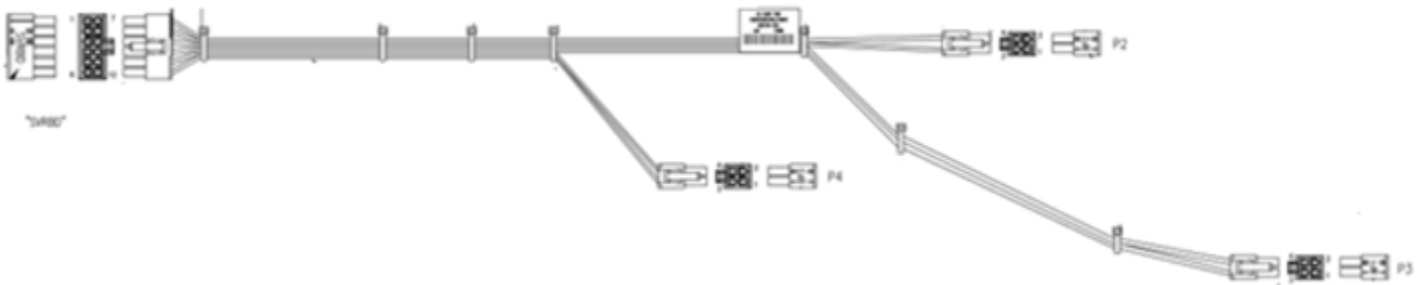


Figure 14. 2.5" Drive Module Hot Swap Backplane Power Cable

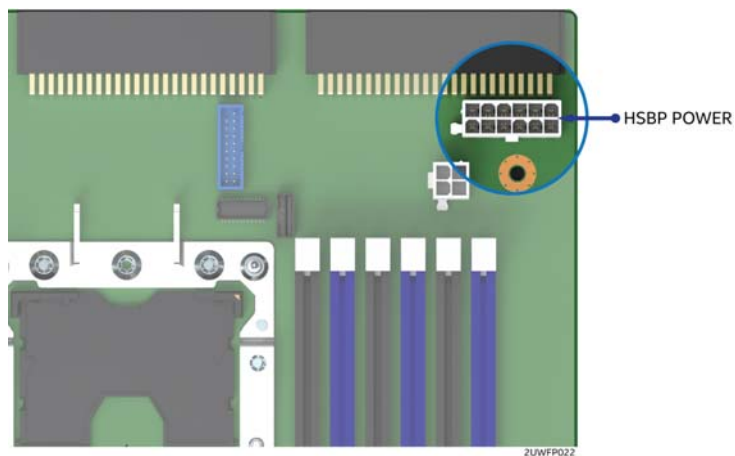


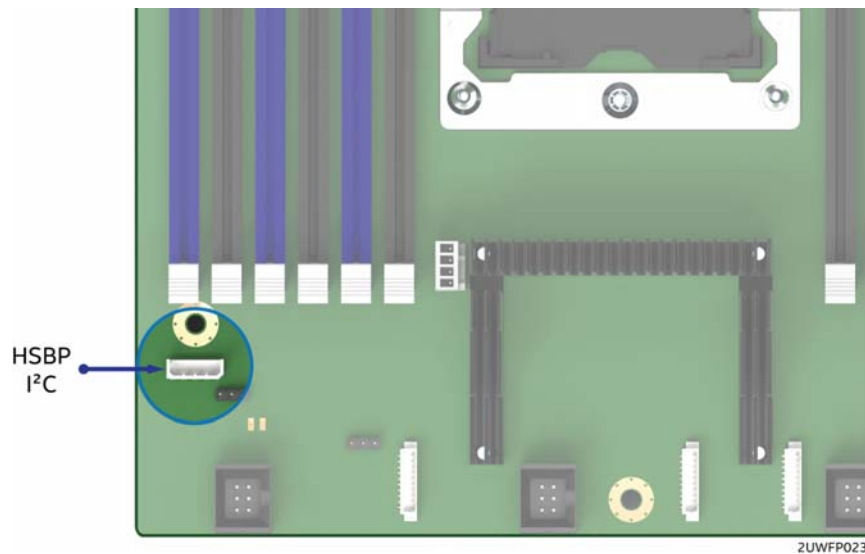
Figure 15. HSBP POWER Connector

b) Connect the 2x6 pin cable connector (labeled "SVRBRD") to the matching 2x6 white power connector on the server board (silk screened "HSBP PWR")

- c) Route the backplane power cable along the chassis sidewall, to the area behind the drive bay.
- d) Connect the white 2x2 pin cable connector(s) (labeled 'P#') to the matching white 2x2 power connector(s) on the backplane (silk screened 'PWR').
- e) Once the cable is attached on both ends, carefully press the cable as low as possible into the cable routing channel.
- f) Locate the backplane I2C cable.



**Figure 16. I<sup>2</sup>C cable**

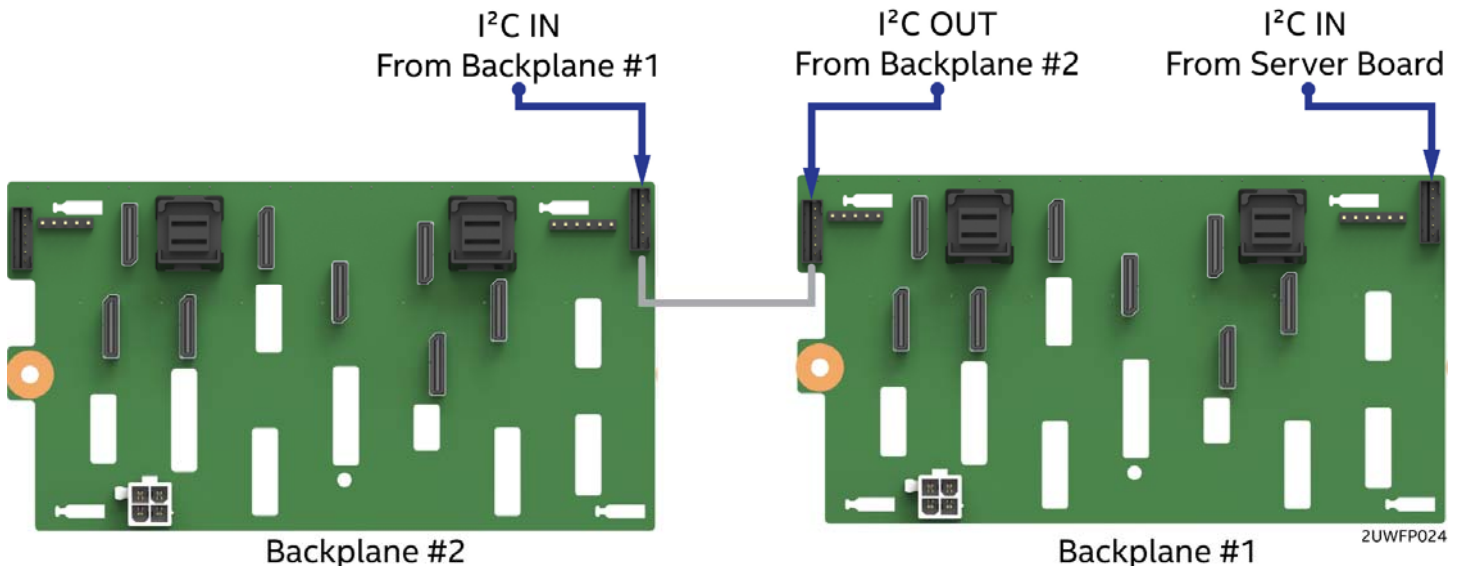


**Figure 17. Hot Swap Backplane I<sup>2</sup>C Internal Cable Connector**

- g) Attach the connector (labeled "HSBP") of the I2C cable to the matching HSBP pin connector (silk screened "HSBP I2C") on the backplane.
- h) Route the backplane I2C cable next to the nearest chassis sidewall and connect the other end of the I2C cable to the 1x4 pin connector (silk screened "HSBP I2C") on the server board.



If more than one 8 x 2.5" backplane is being installed, locate the I<sup>2</sup>C jumper cable and connect one end of the cable to the I<sup>2</sup>C -OUT connector of backplane #1 and the other end of the cable to the I<sup>2</sup>C - IN connector of backplane #2.

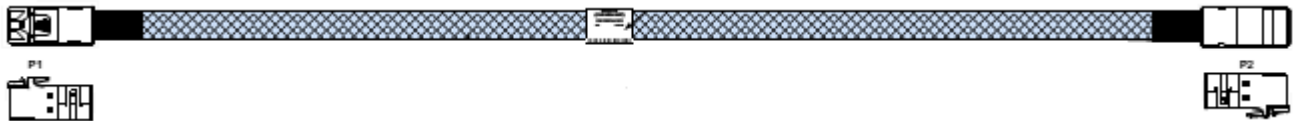


**Figure 18. Dual 8x2.5" Hot Swap Backplane I<sup>2</sup>C Jumper Cable Installation**

3. Connect the SAS/SATA Data Cable(s)

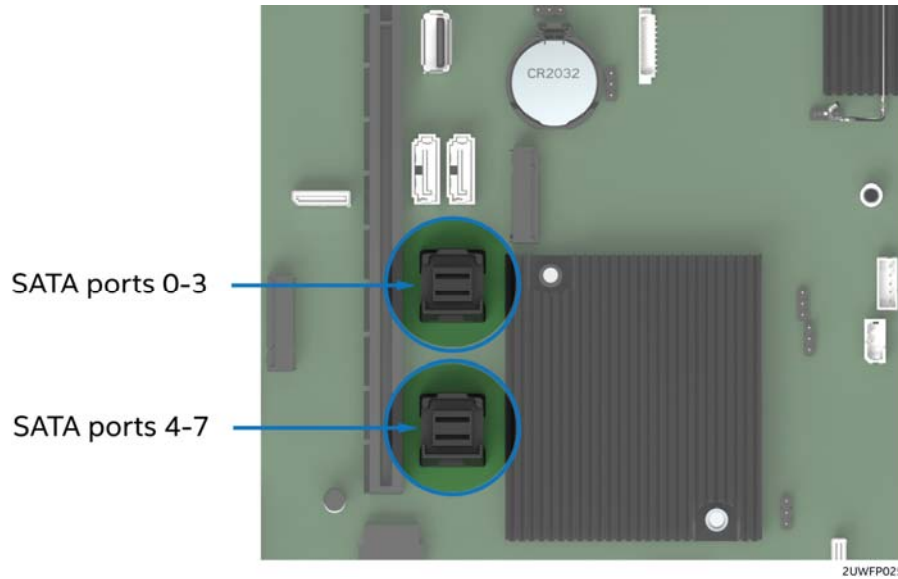
SAS/SATA Data cable connections will vary depending on the system configuration. This section will only describe cable connections when using the onboard SATA controllers. For other add-in storage options, refer to the appropriate option installation sections available in this document.

- a) Locate the appropriate SAS/SATA Data cables.



**Figure 19. SATA Cable**

- b) Attach one side of the SAS/SATA Data cables to the mini-SAS HD connectors on the backplane.
- c) Route the SAS/SATA DATA cables from the backplane to the back of the system via the cable channels next to the chassis sidewalls.



**Figure 20. Onboard Connectors for Embedded SATA Support (S2600WFT and S2600WF0 only)**

- d) Attach the P2 end of the SATA Data cables to the on-board Mini-SAS HD connectors for embedded SATA support (see Figure 20).

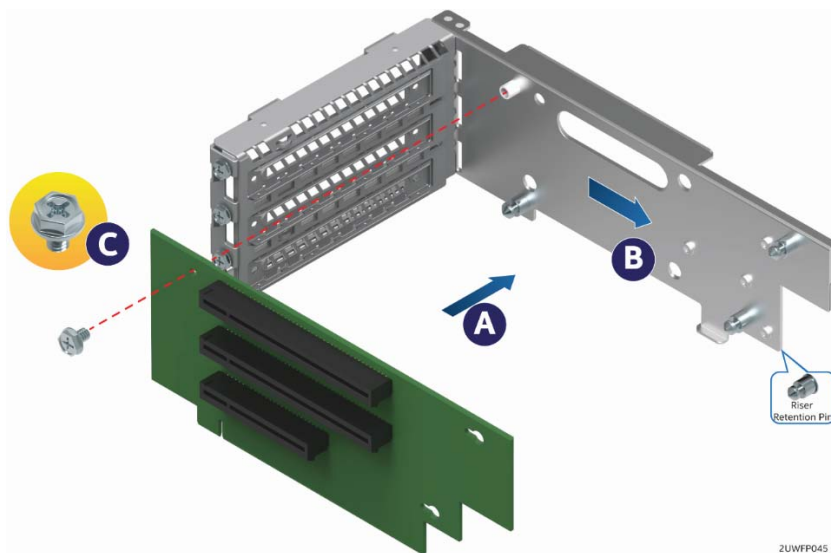
### 1.3.3 PCIe NVMe Support

See Section 2.10

### 1.3.4 Riser Card Assembly

The server system can support up to three (3) PCIe riser cards via the two riser card brackets. This section will provide instructions for mounting of a riser card option to the bracket only. Add-in card installation and system integration procedures for the riser card assemblies are continued in Chapter 2 after the installation of other required system components has been performed.

1. Attach Riser Card(s) to Riser Card Bracket(s)



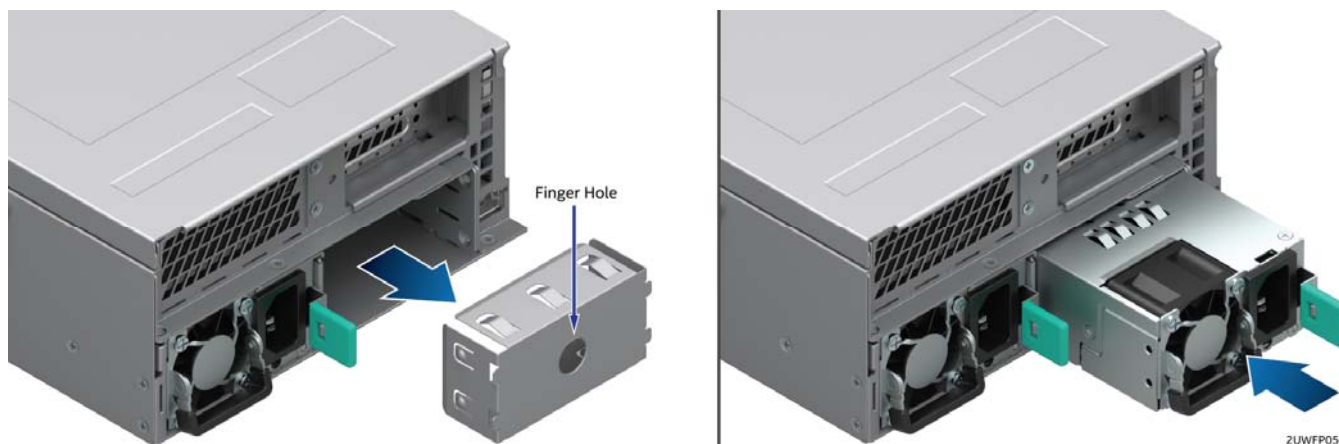
**Figure 21. Riser Card Assembly**

- a) Locate the screw from chassis accessory kit
- b) Locate and remove the riser card from its packaging
- c) Position the mounting key holes of the riser card over the riser bracket mounting studs (see letter "A") and slide back (see letter "B")
- d) Using the screw from the chassis accessory kit, secure the riser card to the bracket (see Letter "C").
- e) See Section 0 for PCIe add-in card installation procedure

### 1.3.5 Power Supply Installation

The server system can support 1 or 2 power supply modules. Single power supply configurations must have the power supply bay insert installed when the system is operational.

1. Install the Power Supply Module(s)



**Figure 22. Power Supply Installation**

- a) Insert the 1<sup>st</sup> power supply into the left most power supply bay until it clicks and locks into place.
- b) (Optional) To install a 2<sup>nd</sup> power supply, remove the insert from the 2<sup>nd</sup> chassis power supply bay
- c) (Optional) Install the 2<sup>nd</sup> power supply

---

Note: A single power supply configuration requires that the power supply bay insert be installed when the system is operational.

---

Continue on to Chapters 2 and 3 for installation of processors, memory, add-in cards, storage devices, and other supported options.

## 2. Essential System Component Installation and Service

---

### Purpose

This chapter provides instructions for the installation and removal of essential system components including processors, memory, storage devices, and add-in cards.

If you are continuing the system integration from the previous chapter, you may skip ahead to section 2.5.

### Before You Begin

Before working with your server product, observe the safety and ESD precautions found in the Warnings section at the beginning of this manual.

### Tools and Supplies Needed

- T-30 Torx screwdriver
- Flat head screwdriver
- Adequate ESD protective gear (wrist strap, ESD mat)

### System Reference

All references to left, right, front, top, and bottom assume the reader is facing the front of the chassis.

### Instruction Format

Each procedure described in this section will follow an illustration first format. This format will give the reader the option to follow a quicker path to system integration by first seeing an illustration of the intended procedure. If necessary, the reader can then follow the step-by-step instructions that will accompany each procedure.

## 2.1 Internal Cable Routing Channels

The system fan module must be removed when routing cables from front-to-back. All cables should be routed using the cable channels in between the chassis sidewalls and the air duct side walls, as shown in the following illustration. When routing cables front-to-back, none should be routed through the center of the system or in the area between the system fans and the DIMMs slots.

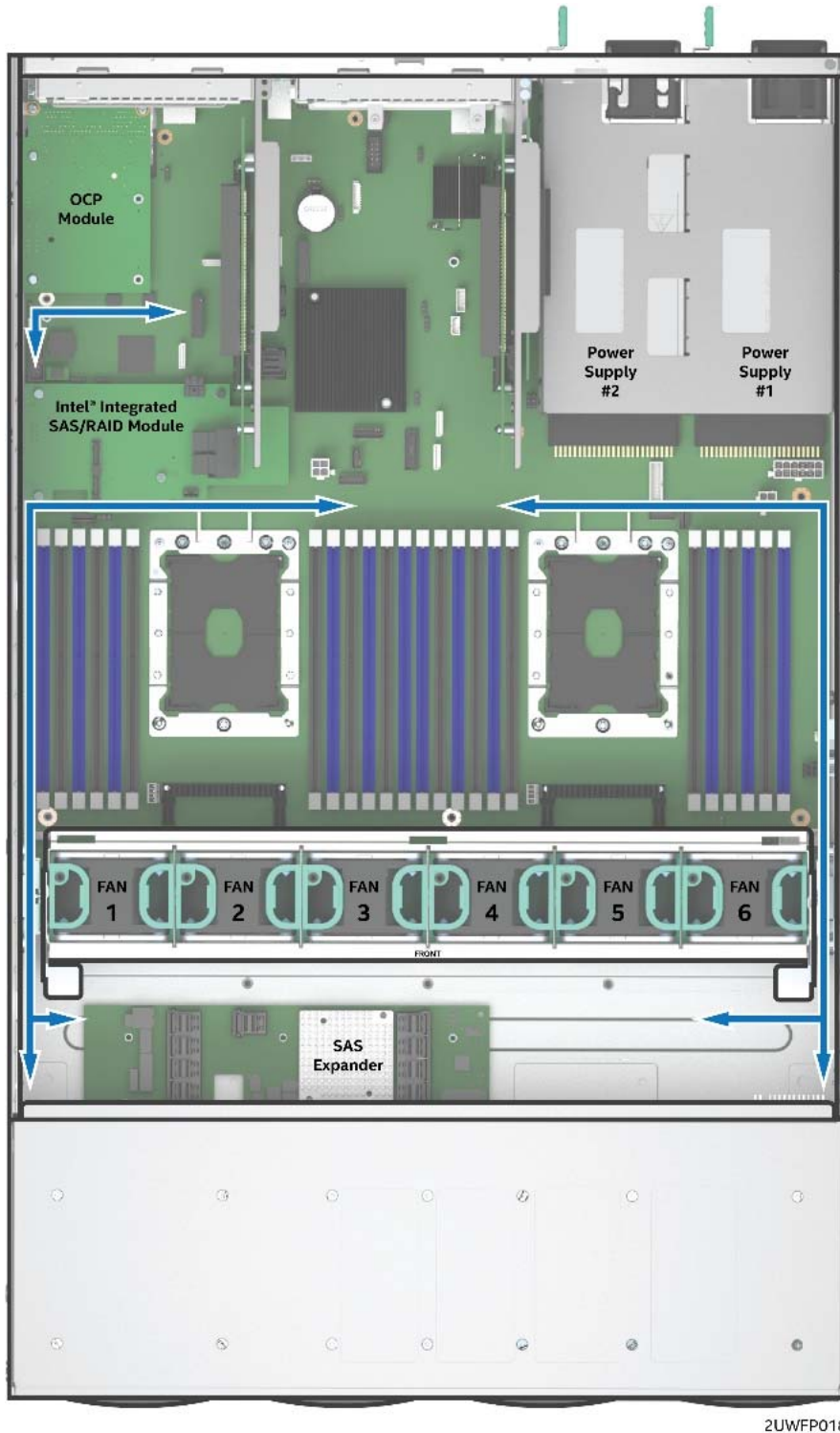


Figure 23. Internal Cable Routing Channels

## 2.2 System Cover Removal / Installation

### 2.2.1 System Cover Removal

The server system must be operated with the system cover in place to ensure proper cooling. The top cover must be removed to add or replace components inside of the system. Before removing the top cover, power down the system and unplug all peripheral devices and the power cable(s).

---

**Note:** A non-skid surface or a stop behind the server system may be needed to prevent the server system from sliding on your work surface. A screw driver may be needed to loosen the top cover thumb screws.

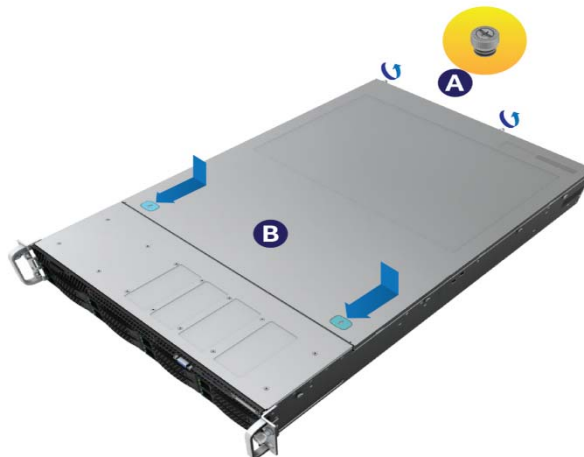
---



**Figure 24. System Cover Removal**

1. Loosen the two captive thumb screws located on the back edge of the system cover (See Letter 'A')
2. Slide cover back and lift upward (see Letter 'B').

### 2.2.2 System Cover Installation



**Figure 25. System Cover Installation**

1. Place the system cover onto the chassis and slide forward until the front edge of the system cover is pressed up against the back edge of the front drive bay. (See letter 'B')
2. Hand tighten the two captive thumb screws at the back of the chassis (see letter 'A')

---

**Note:** For safety after performing service inside of the system, the top cover must be reinstalled and the thumbscrews tightened to 8in/lb torque or to where the use of a tool is required to re-enter the server.

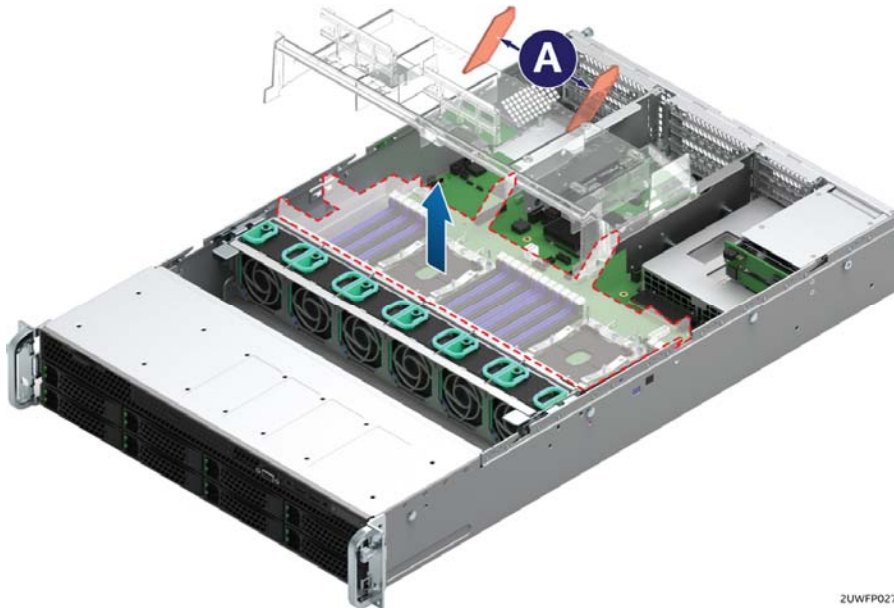
---



## 2.3 Air Duct Removal / Installation

Always operate your server system with the air duct in place. The air duct is required for proper airflow within the server system.

### 2.3.1 Air Duct Removal

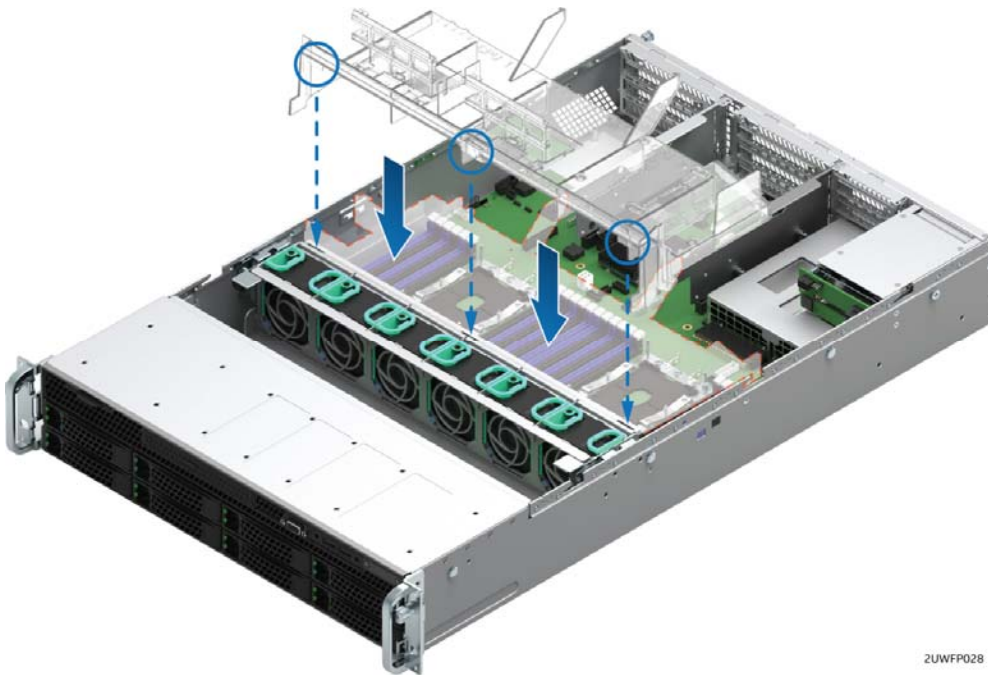


2UWFP027

**Figure 26. Air Duct Removal**

1. To remove the air duct, unlatch the rear tabs 'A' from underneath each riser card module.
2. Using rear tab posts, lift the air duct straight up until tabs on the front edge of the air duct are free from the fan module.

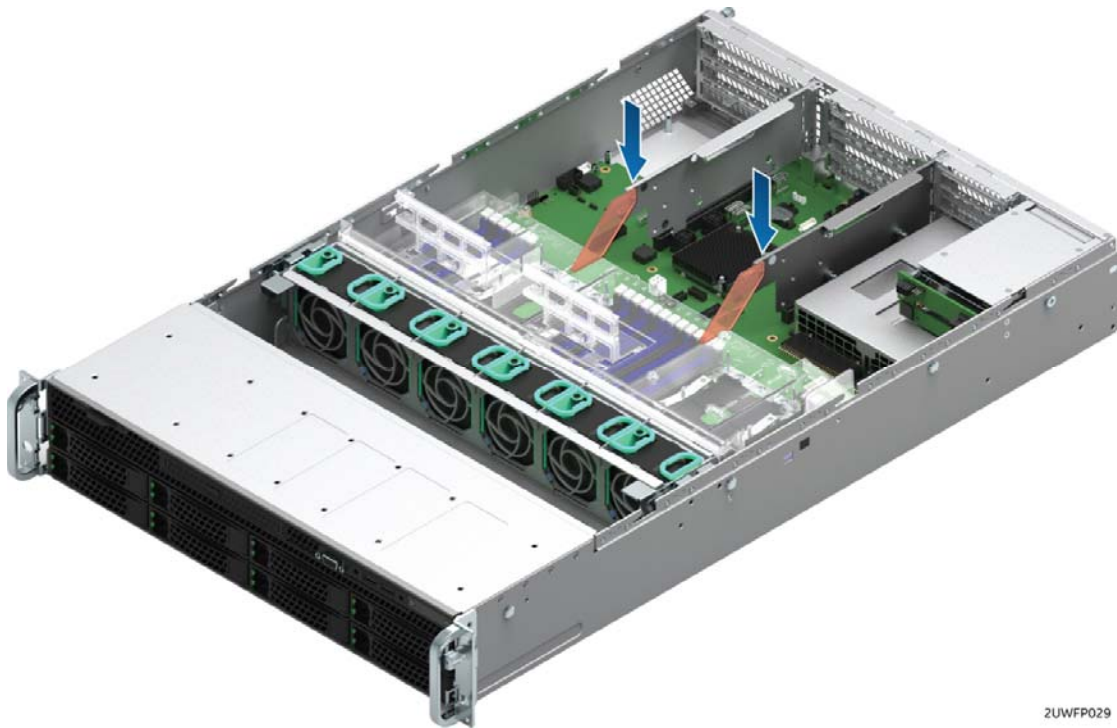
### 2.3.2 Air Duct Installation



2UWFP028

**Figure 27. Air Duct Installation**

1. Align the three tabs on the front edge of the air duct with the matching slots on the fan module.
2. Lower the air duct into the system ensuring the three tabs are securely installed in the fan module.



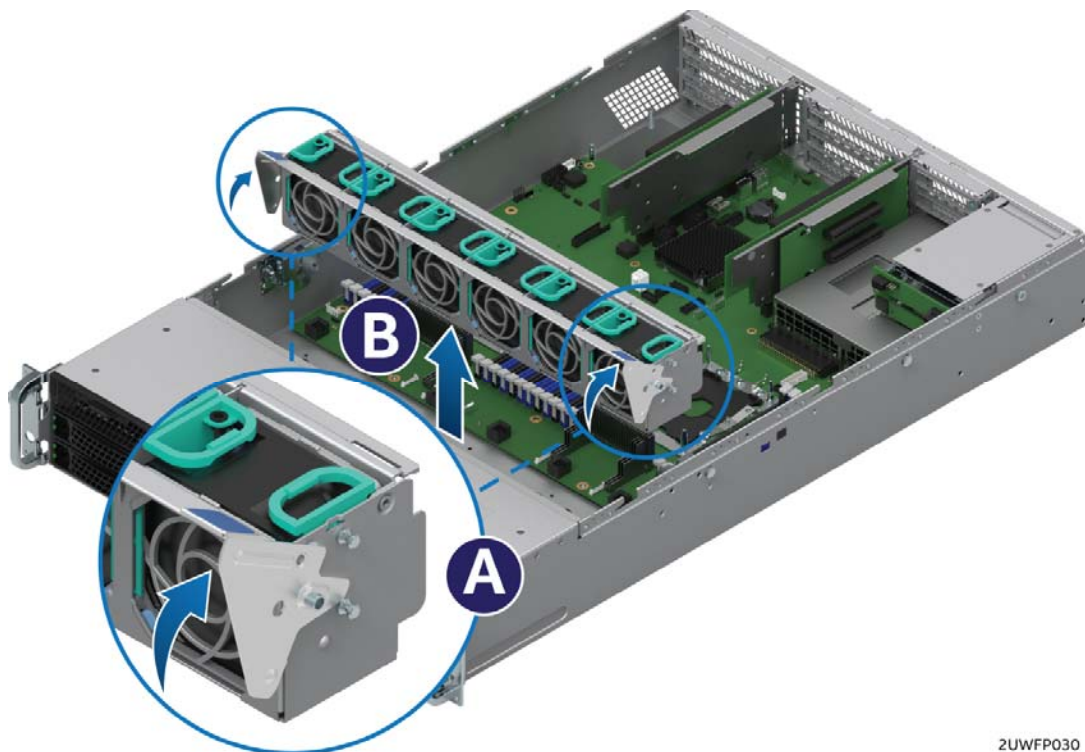
2UWFP029

3. Press down on the back edge of the air duct so that the tabs at the end of each air duct post snaps underneath the top edge of the riser card assemblies. The air duct should lay/be flat and secure.

## 2.4 System Fan Module Removal / Installation

System fan module removal is required whenever routing cables inside the chassis from back to front or from front to back, or when server board replacement is necessary.

### 2.4.1 System Fan Module Removal



2UWFP030

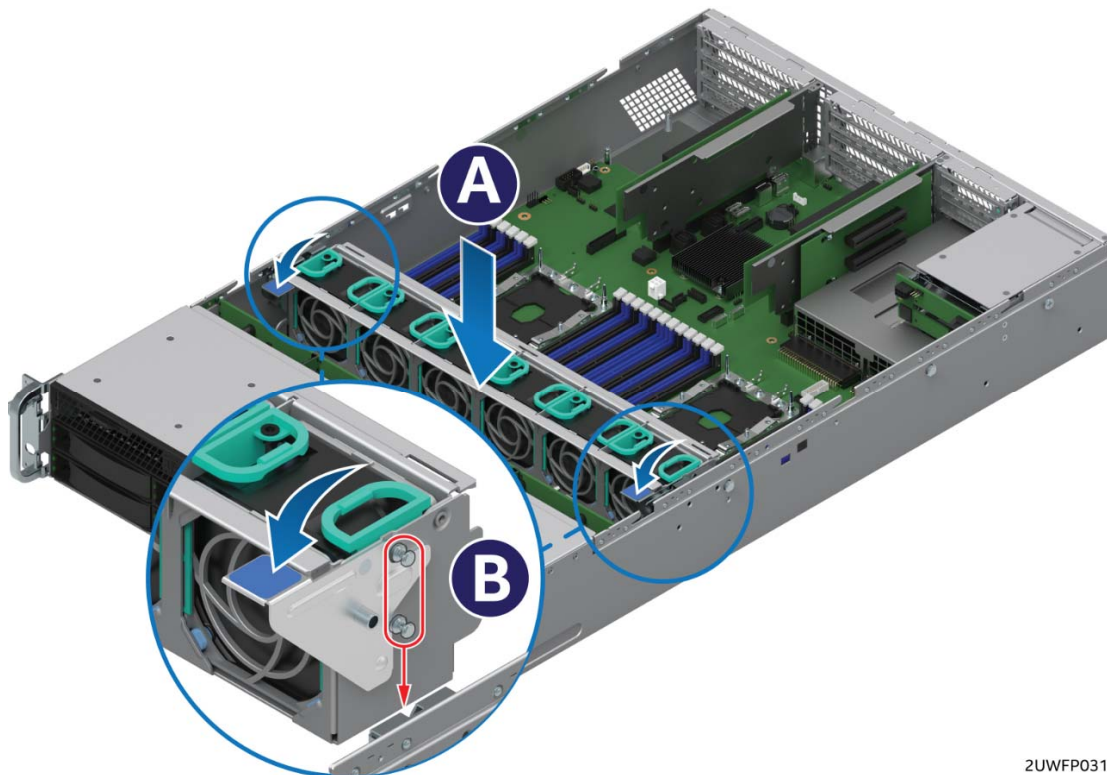
Figure 28. System Fan Module Removal



To remove the system fan module:

1. Lift the latches located on each end of the fan module until each latch is fully disengaged from the latch receivers on the chassis side wall. (see Letter 'A')
2. Grasp each end of the fan module and pull straight up (see Letter 'B')
3. Carefully place the fan module face down onto a flat surface. Do NOT rest the fan module on the fan connectors located on the bottom side of the fan module, doing so may damage the connectors.

## 2.4.2 System Fan Module Installation



2UWFP031

**Figure 29. System Fan Module Installation**

To install the system fan module:

1. Ensure that all cables are clear of the fan module keep out area on the base of the chassis.
2. Ensure the latches on both sides of the fan module are fully rotated up.
3. Position the fan module over the chassis so that the latches are oriented toward the front of the chassis (see letter 'A').
4. Align the two guide pins on each side of the fan module with the latch receivers located on each chassis sidewall (see letter 'B').
5. Carefully lower the fan module into the latch receivers.
6. Push down on both ends of the fan module until fully seated.
7. Rotate each latch down to lock the fan module in place.

## 2.5 Processor Assembly, Installation, and Replacement

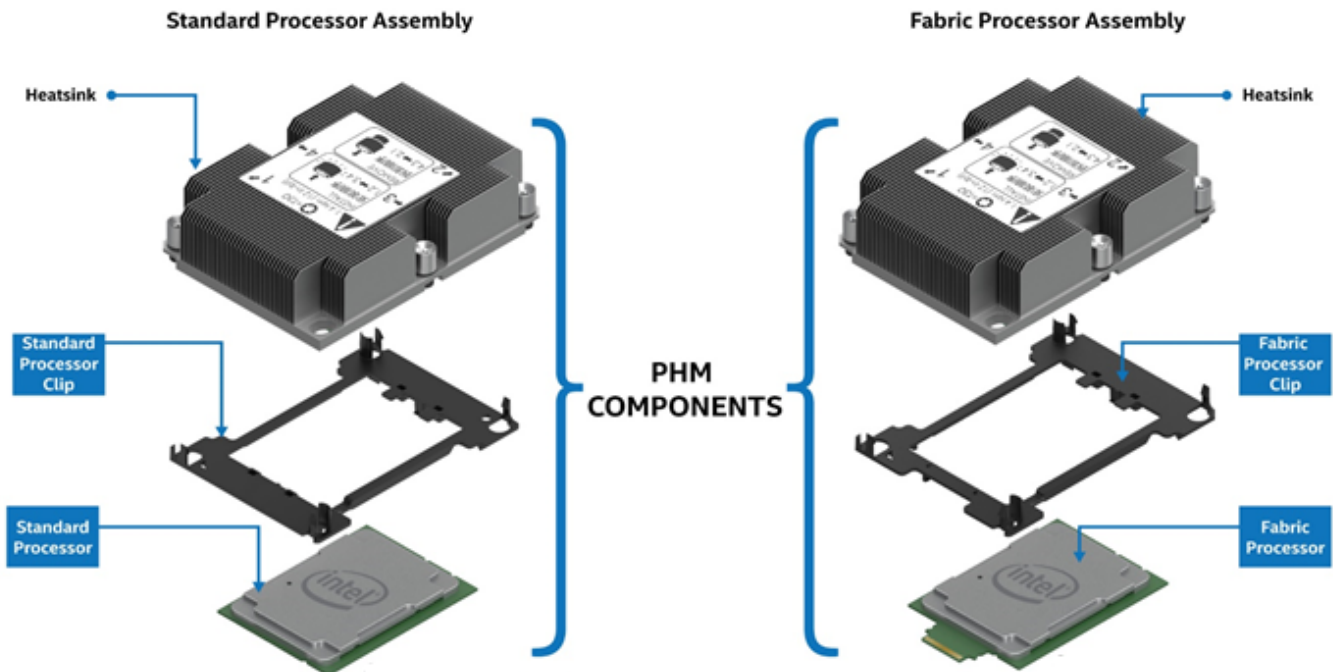
### Components Required:

- 1 or 2 Intel® Xeon® processor Scalable family
- 1 or 2 processor clips – Standard and/or Fabric
- 2 Processor Heat Sink(s)

### Tools Required:

- T-30 Torx screwdriver
- Flat head screwdriver
- Adequate ESD protective gear (wrist strap, ESD mat)

This generation of Intel Server Systems requires that the processor be attached to the heat sink prior to installation on to the server board. The processor / heat sink assembly is referred to as the processor heat sink module, or PHM.



**Figure 30. Processor Heat Sink Module (PHM) Reference Diagram**

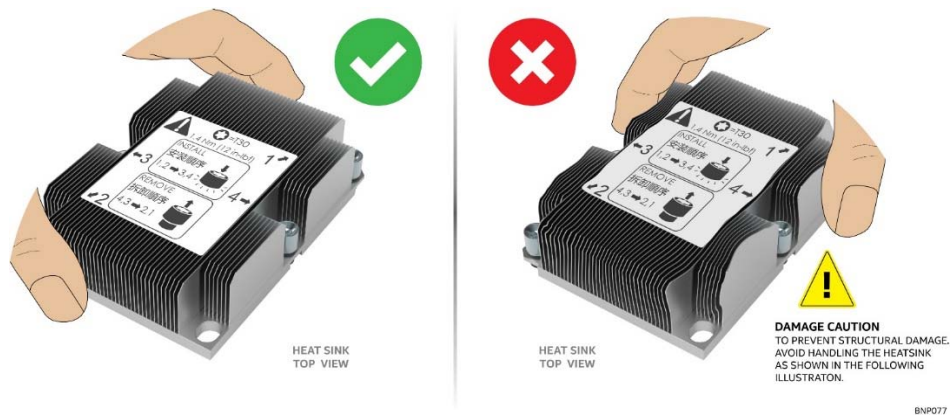
To properly assemble the PHM and install it to the server board, the procedures described in the following sections must be followed in the order specified. These instructions assume that all the PHM components are new and the Thermal Interface Material (TIM) is already applied to the bottom of the heat sink.

**Note:** Intel Server Systems include two processor clips to support standard Intel® Xeon processors. For Intel® Xeon® processors that include an Intel® Omni-path host interface connector, a Fabric processor clip must be used in place of the standard processor clip. Fabric processor clips are included with the following Intel Fabric processor accessory kits: **AWF1PFABKITM** or **AWF1PFABKITP**

**WARNING:** Attempting to use a Standard CPU Clip with a Fabric supported CPU may result in component damage and/or induce improper assembly of the PHM.

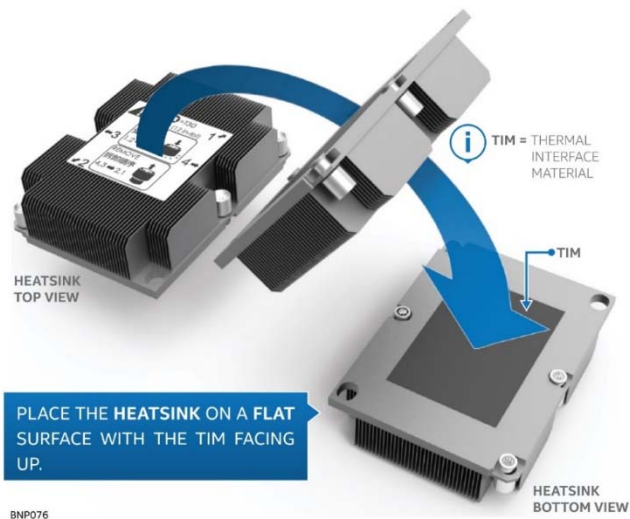
## 2.5.1 PHM Assembly

1. Remove the heat sink from its packaging. To avoid damage to the heat sink, grasp it by its narrower, top and bottom edges, as shown below.



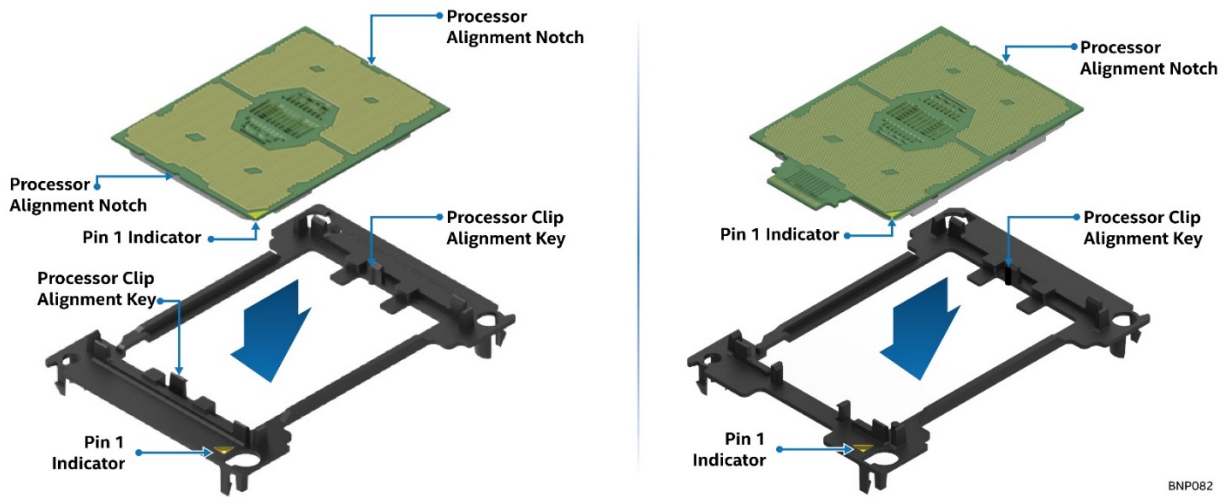
**Figure 31. Processor Heat Sink Handling**

2. Place the heat, sink bottom side up, on to a flat surface as shown.



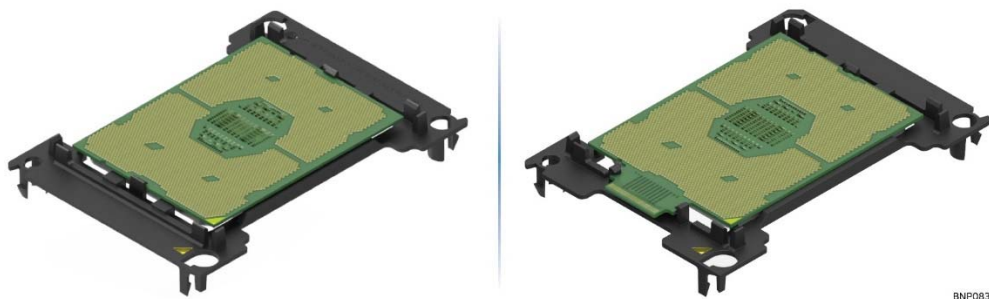
**Figure 32. PHM Assembly – Heat Sink Orientation**

3. If present, carefully remove the plastic protective cover from the bottom side of the processor to expose the Thermal Interface Material (TIM)
4. Locate the processor clip and place it on to a flat non-skid surface with corner latch pins facing down
5. Carefully remove the processor from its packaging. **A processor should only be grasped by its edges. Do not touch any part of the component side of the processor with your fingers.**



**Figure 33. Processor Carrier Clip Assembly**

6. Orient the processor, component side up, so that all alignment features match those of the processor clip as shown.



**Figure 34. Processor Carrier Clip Sub-Assembly**

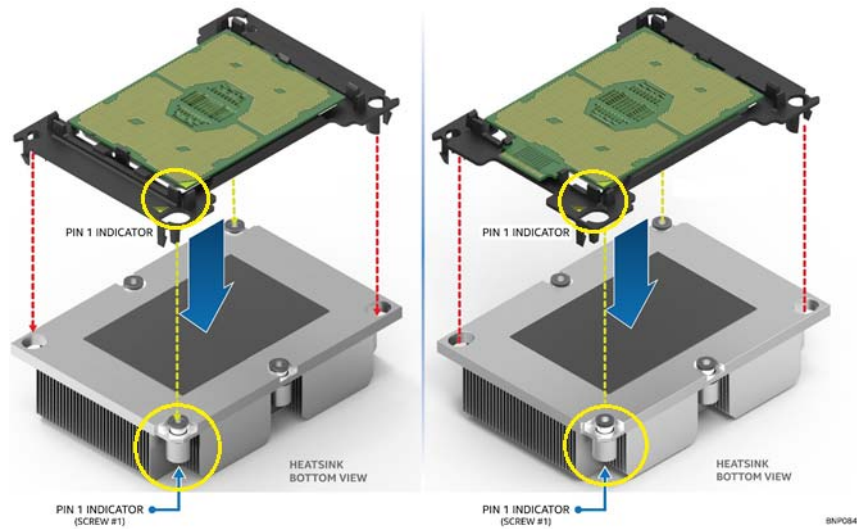
7. Install the processor into the processor clip until it snaps into place.

---

**CAUTION:** To prevent the processor from falling out of the processor clip, the processor / clip assembly should only be grasped by its shorter edges.

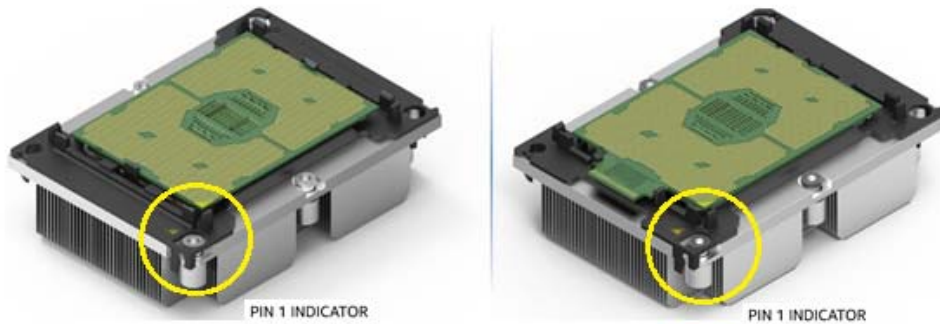
**CAUTION:** Do not touch the sensitive contacts on the bottom side of the processor at any time during PHM assembly or installation. In addition, the pins inside the processor socket are extremely sensitive. A damaged processor socket may produce unpredictable system errors

---



**Figure 35. Processor Clip Sub-assembly to Heat Sink Orientation**

8. Orient the processor clip sub-assembly over the processor heat sink so that all corner features are in alignment. **Ensure Pin 1 indicators are aligned** as shown in the following figures.



**Figure 36. Processor Heat Sink Module (PHM)**

9. Push the processor clip sub-assembly down on to the processor heat sink until it snaps into place, ensuring all four corners are secure. Processor clip sub assembly should sit flat on top of the heat sink.

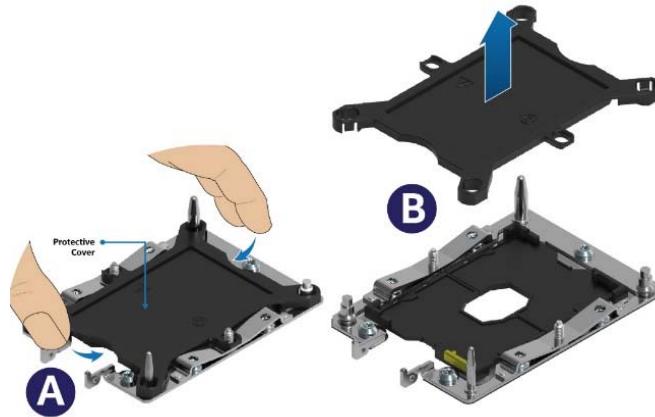
### 2.5.2 Processor Installation

Intel server systems support the installation of 1 or 2 processors. For the server to be operational, CPU #1 must be installed. The installation of CPU #2 is optional, however, to ensure proper airflow when the server system is operational, the CPU #2 heat sink must be installed at all times. When no processor is installed in a socket, one of the provided black Mylar spacers should be installed between the processor heat sink and the processor socket. This is a serviceability feature that identifies that a socket has no processor present when only a heat sink is installed





1. Remove the plastic cover from the processor socket on the server board



**Figure 37. Plastic processor socket cover removal**

- a) Grasp the processor cover as shown (see Letter A)
- b) Carefully pull it up away from the processor socket, ensuring no contact is made with any of the pins within the socket. (see Letter B)

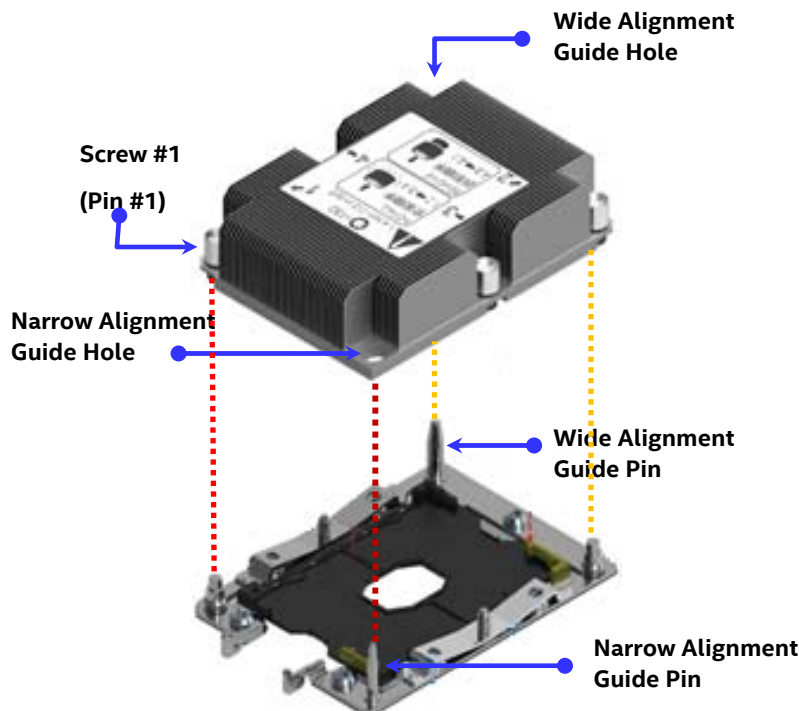
---

**NOTE:** The processor socket cover should be saved for future use.

**CAUTION:** When re-installing the socket cover, make sure it properly snaps into place. Improper installation will cause it to become loose and damage the processor socket.

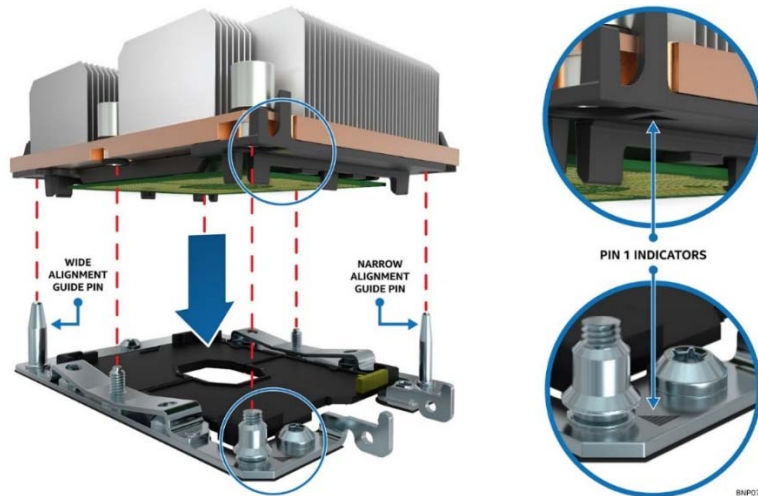
---

The assembled PHM and the processor socket include several alignment features to ensure the PHM can only be installed one way. Care should be taken to ensure components are accurately assembled and the PHM is oriented correctly to the processor socket prior to placement onto the server board.



**Figure 38. Processor Installation Alignment Features**

2. Install PHM assembly to the processor socket on the server board



**Figure 39. PHM Alignment to Bolster Plate**

- a) Align the mounting holes of the PHM (located on diagonal corners) to the guide pins of the processor socket as shown in the following figure.

3. Lower the PHM onto the processor socket assembly

---

**CAUTION:** Processor socket pins are delicate and bend easily. Use extreme care when placing the PHM onto the processor socket, do not drop it.

---

The PHM assembly is properly installed when seated flat and evenly upon the processor socket assembly



**Figure 40. Correct PHM Placement**

---

**NOTE:** The PHM is NOT installed properly if it does not sit level with the processor socket assembly. Improperly installed PHMs cannot be fastened down. PHMs can only be fastened down if correctly installed.

---

- 4. Secure PHM to the processor socket assembly
  - a) Using a T30 Torx bit screwdriver, securely tighten (12 in-lb) each fastener in the sequence shown on the label located on the top of the heat sink



Figure 41. Installing the PHM

**CAUTION:** Failure to tighten the heat sink screws in the specified order may cause damage to the processor socket assembly. Each heat sink screw should be fully tightened to 12 in-lb torque before securing the next screw in the sequence.

- For a second processor, repeat the processor installation instructions above, ensuring the proper processor heatsink and processor carrier clip are used for the installation.

For single processor configurations, where a 2<sup>nd</sup> processor is not installed, install the CPU#2 heat on to the CPU #2 socket to ensure proper air flow when the system is operational.

See section 3.9 for installation instructions related to fabric processor accessory kits.

### 2.5.3 Processor Replacement

- Remove Processor from Server Board

**WARNING:** Processor heat sinks can become extremely hot during normal system operation. Before attempting to remove the processor from the server board, allow the processor heat sinks to fully cool.

*Failing to follow the indicated disassembly sequence, may cause damage*

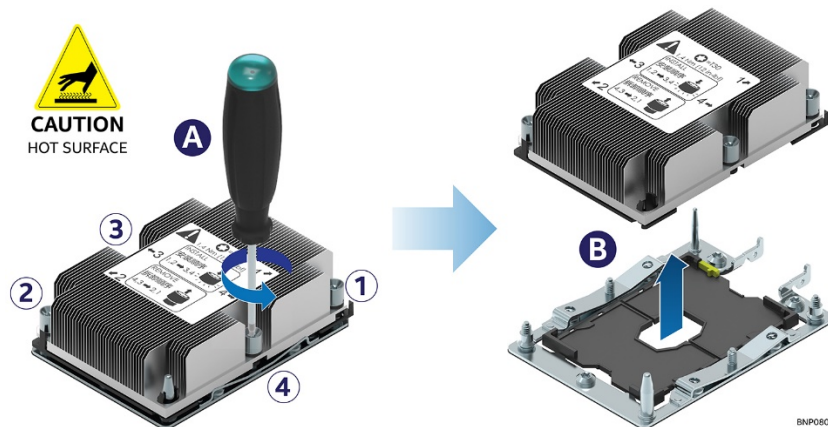


Figure 42. Uninstalling the Processor Heat Sink Module (PHM)

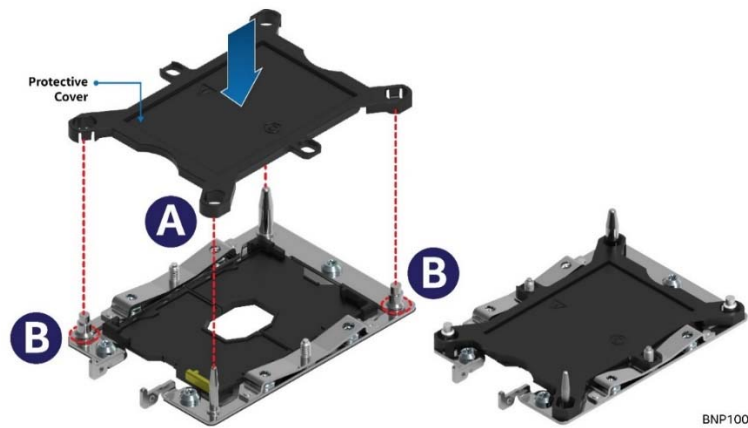


- a) Using a T30 Torx bit screwdriver, loosen each heat sink fastener in the sequence shown on the label located on the top of the heat sink (see Letter A)
- b) Lift the PHM straight up from the server board until it is free from the processor socket bolster plate guide pins (see Letter B)

---

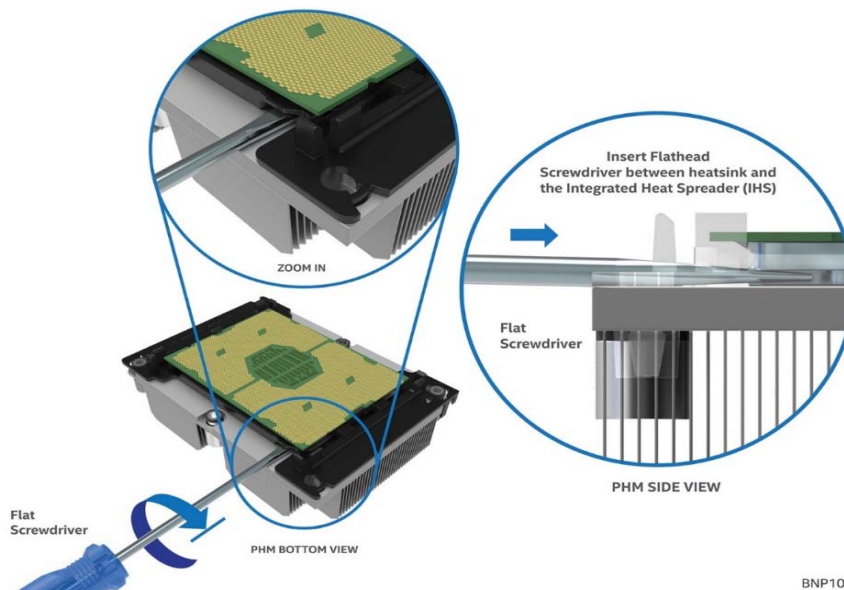
Note: to prevent possible damage to the processor socket, re-install the original plastic cover to the processor socket.

---



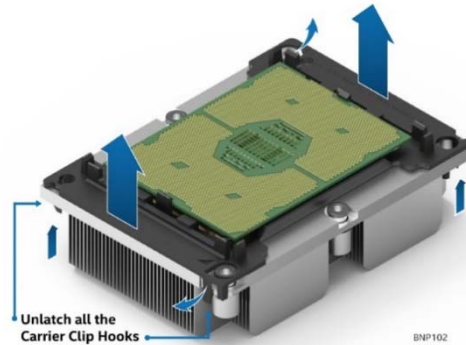
**Figure 43. Plastic Processor Socket Cover Installation**

2. With the heat sink facing down, place the Processor Heat Sink Module (PHM) onto a flat non-conductive surface
3. Remove the processor clip sub-assembly from the heat sink:
  - a) Insert the head of a flat head screw driver in-between the heat sink and the processor clip assembly (as shown below) and gently twist until the bond between heat sink and the processor is broken.



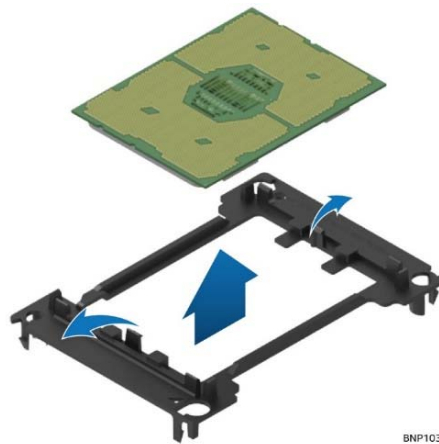
**Figure 44. PHM Disassembly**

- b) Unlatch the hooks on each corner of the processor clip to free the processor from the heat sink



**Figure 45. Releasing the Processor Carrier Clip from the Heat Sink**

- c) Carefully lift the processor sub-assembly from the heat sink
4. Remove the processor from the processor clip by carefully pushing back one of the latches located on the ends of the processor and rotating the processor up and out of the processor clip



**Figure 46. Releasing Processor from Processor Clip**

For processor assembly and installation, see sections 2.5.1 and 2.5.2

## 2.6 Memory Module (DIMM) Installation and Replacement

### **Components Required:**

- Up to 24 DDR4 DIMMs

### **General Memory Population Rules:**

Memory channels for each processor are identified as A – F. Each memory channel includes two DIMM slots identified as 1 and 2. On the server board, each DIMM slot is identified by Processor #, Channel Identifier, and DIMM Slot #.

Examples)


CPU1\_DIMM\_A1  
 CPU1\_DIMM\_A2  
 CPU2\_DIMM\_A1  
 etc....

**BLUE DIMM** Slots identify DIMM 1 for each memory channel.

To maintain required air flow within the system, certain memory slots **MUST** be populated with a DIMM or supplied DIMM blank. DIMM blanks should only be removed when installing a DIMM in the same DIMM slot.



Figure 47. DIMM Blank

**NOTE:** To maintain system thermals while the system is operational, DIMM slots identified with  must be populated with a DIMM or supplied DIMM blank

**FOR SYSTEMS WITH THE FOLLOWING FRONT DRIVE BAY CONFIGURATIONS:  
8x2.5", 16x2.5" 8x3.5"**

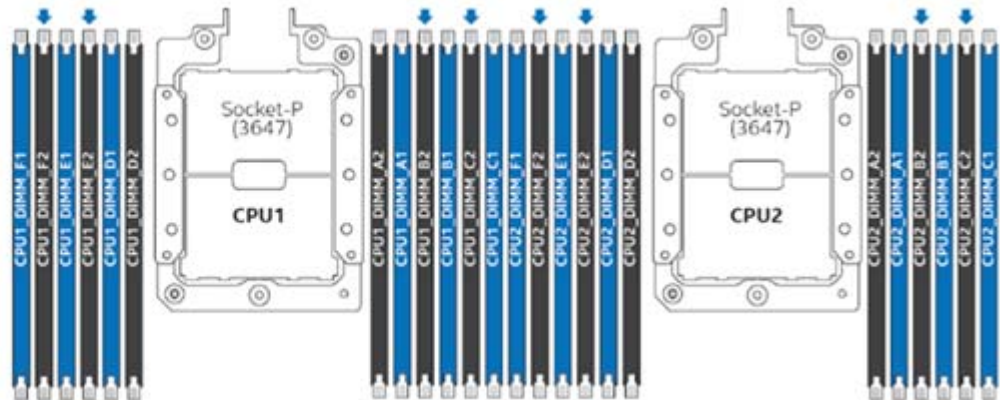


Figure 48. Memory Slot Population Requirements – 8x2.5, 16x2.5, 8x3.5 Front Drive Configurations

**FOR SYSTEMS WITH THE FOLLOWING FRONT DRIVE BAY CONFIGURATIONS:  
24x2.5", 12x3.5"**

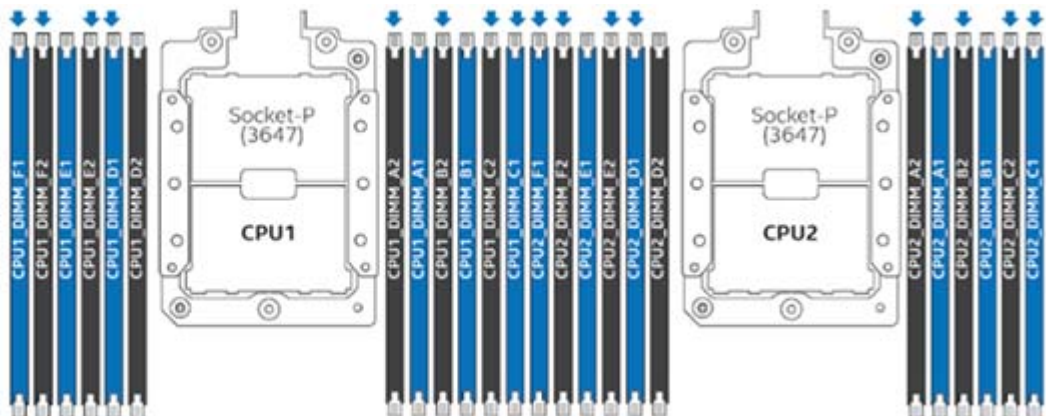


Figure 49. Memory Slot Population Requirements – 24x2.5, 12x3.5 Front Drive Configurations

For best performance, DIMMs should be populated using the following guidelines:

- Each installed processor should have matching DIMM configurations
- The following DIMM population guidelines should be followed for each installed processor
  - **1 DIMM to 3 DIMM Configurations** – DIMMs should be populated to DIMM Slot 1 (**Blue Slot**) of Channels A thru C
  - **4 DIMM Configurations** – DIMMs should be populated to DIMM Slot 1 (**Blue Slot**) of Channels A, B, D, and E
  - **5 DIMM Configurations – NOT Recommended.** This is an unbalanced configuration which will yield less than optimal performance
  - **6 DIMM Configurations** – DIMMs should be populated to DIMM Slot1 (**Blue Slot**) of all Channels
  - **7 DIMM Configurations – NOT Recommended.** This is an unbalanced configuration which will yield less than optimal performance
  - **8 DIMM Configurations** – DIMMs should be populated to DIMM Slots 1 and 2 of Channels A, B, D, and E

- **9 DIMM, 10, DIMM, and 11 DIMM Configurations - NOT Recommended.** These are an unbalanced configurations which will yield less than optimal performance
- **12 DIMM Configurations** – DIMMs are populated to ALL DIMM Slots

Note: DIMM populations noted as “Not Recommended” are fully functional configurations. However, they will not yield the best possible system performance.

### 2.6.1 DDR4 DIMM Installation

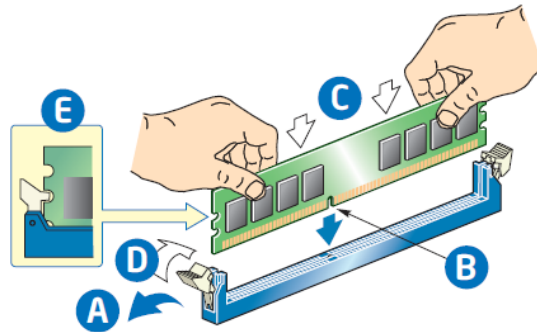


Figure 50. DIMM Installation

1. Locate the DIMM sockets. Make sure the clips at either end of the DIMM socket(s) are pushed outward to the open position (see letter 'A').
2. Holding the DIMM by the edges, remove it from its anti-static package. Position the DIMM above the socket. Align the notch on the bottom edge of the DIMM with the key in the DIMM socket (see letter 'B').
3. Insert the bottom edge of the DIMM into the socket (see letter 'C'). When the DIMM is inserted, push down on the top edge of the DIMM until the retaining clips snap into place (see letter 'D'). Make sure the clips are firmly in place (see letter 'E').

### 2.6.2 DDR4 DIMM Replacement

1. Locate the DIMM socket for service. Ensure that the retaining clips of adjacent slots are closed.
2. Open the DIMM slot latches at either end of the selected DIMM socket (see Letter A in Figure 51. DIMM Removal). The DIMM will lift up from the socket connectors.
3. Holding the DIMM by its edges, lift it away from the socket (see Letter B)

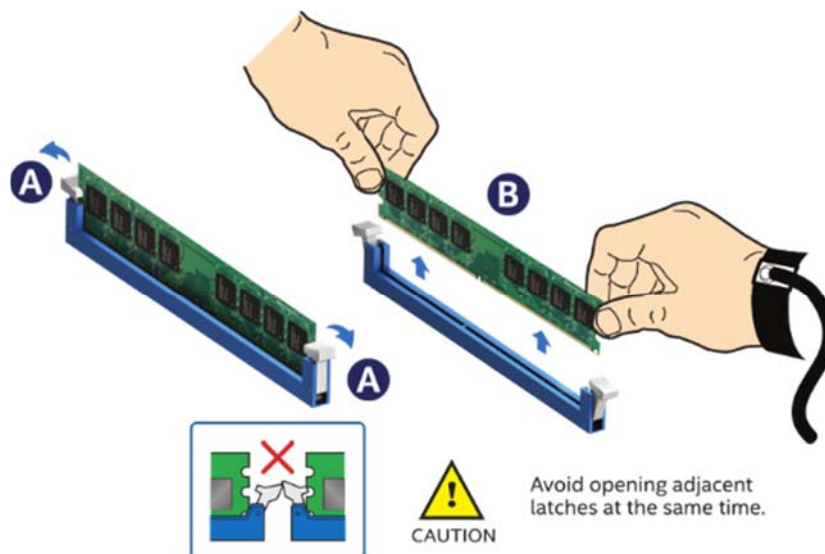


Figure 51. DIMM Removal

BNP053-02

## 2.7 Drive Carrier Extraction, Installation, and Assembly

The 2U server product family has front drive bay chassis options that support 2.5" form factor drives (Hard Disk Drives or Solid State Drives) or 3.5" form factor hard disk drives with the option to support 2.5" SSDs. This section provides instruction for drive extraction from the chassis, drive installation into the chassis, and drive assembly.

---

**Note:** To maintain proper system cooling, all externally accessible drive bays must be populated with a drive carrier. Each drive carrier must have a hard disk drive (HDD), Solid State Device (SSD), or a supplied drive blank installed.

---

### 2.7.1 Drive Carrier Extraction

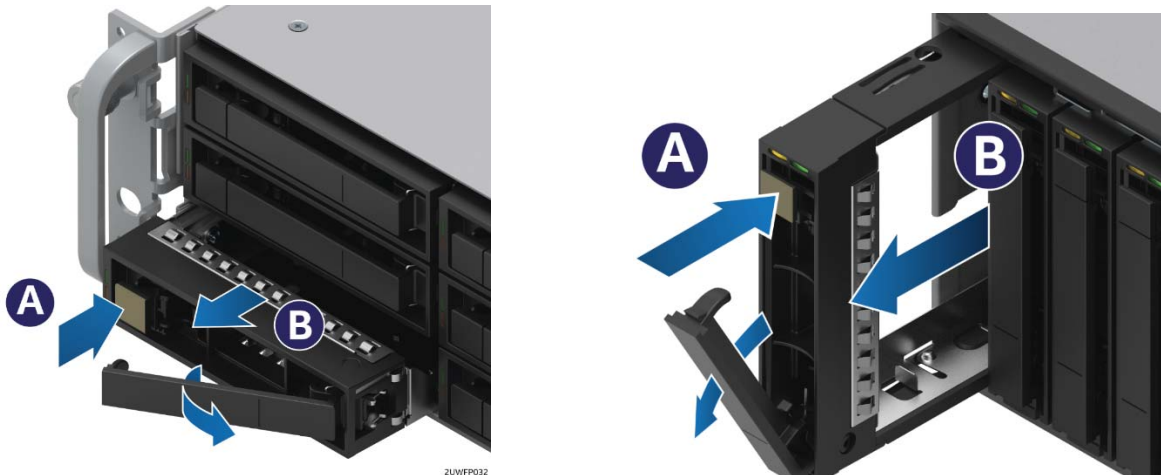


Figure 52. Drive Carrier Extraction from Chassis

1. Remove the drive carrier from the chassis by first pressing the button on the carrier face plate to release the lever (see Letter "A").
2. Using the lever, pull the carrier from the drive bay (see Letter "B").

### 2.7.2 Drive Carrier Installation

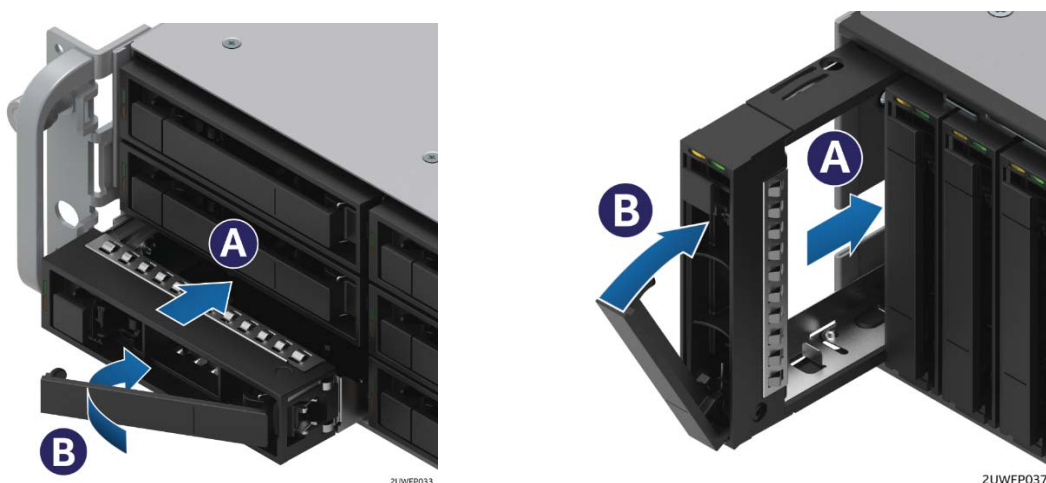
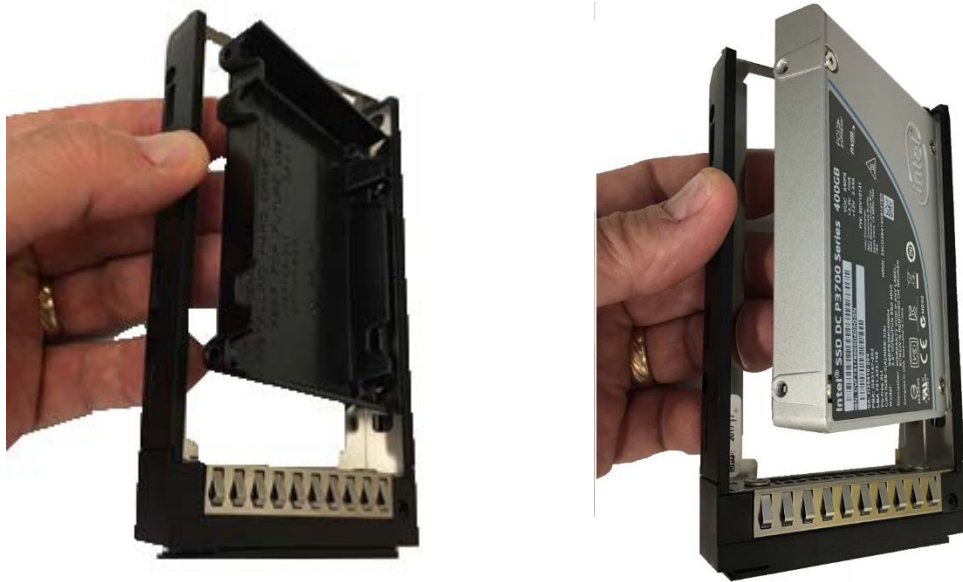


Figure 53. Drive Carrier into Chassis Installation

1. Align the drive assembly with the open drive bay
2. With the lever in the open position, insert the drive assembly into the drive bay (See letter "A") and push forward until the drive makes contact with the backplane
3. Complete the drive installation by closing the drive assembly lever until it locks into place (See letter "B")

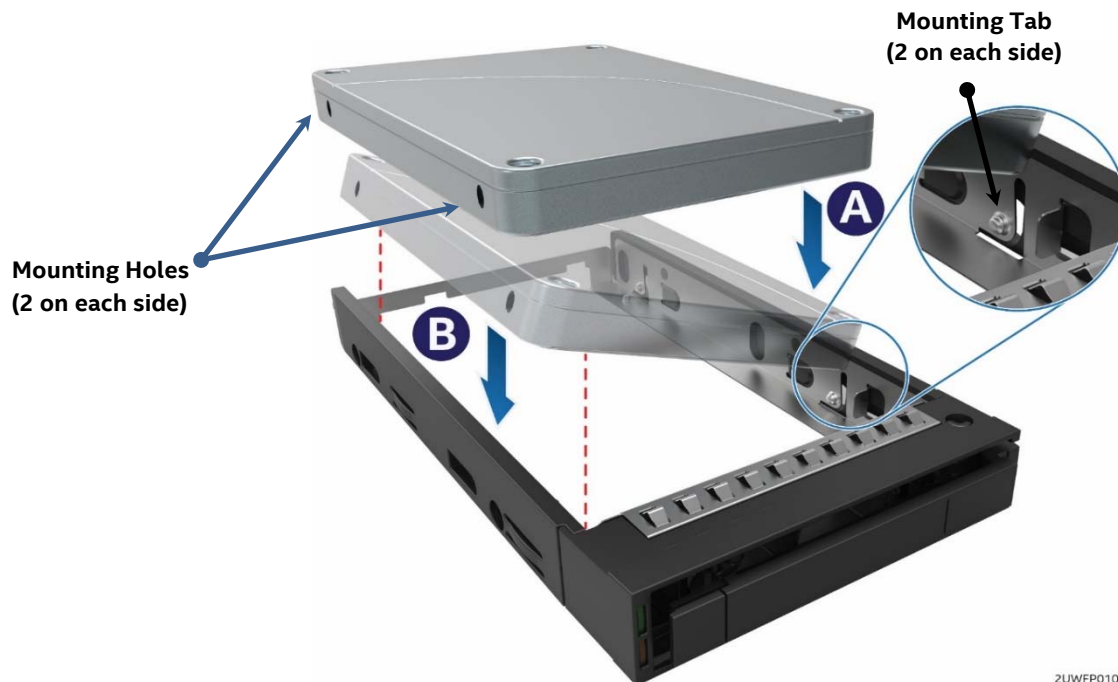


### 2.7.3 2.5" HDD / SSD Drive Carrier Assembly



**Figure 54. 2.5" Drive Carrier Assembly – Drive / Drive Blank Removal**

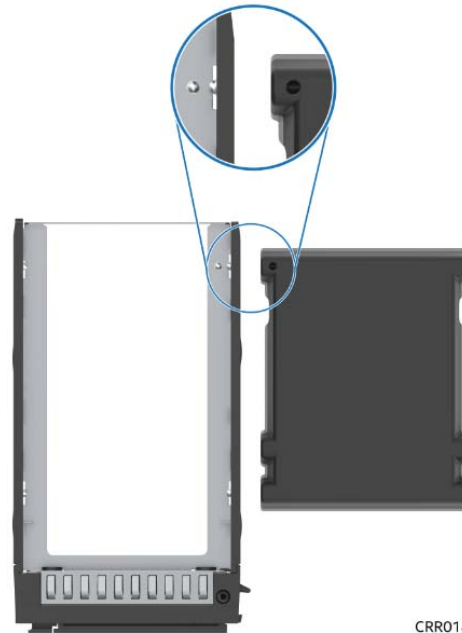
1. Remove the drive or drive blank from the carrier by gently rotating the top edge of a carrier rail outwards while at the same time pushing the drive or drive blank up from the bottom (as shown above).



**Figure 55. 2.5" Drive Carrier Assembly – Drive Installation to Carrier**

2. With the rear drive connector positioned towards the back of the drive carrier, align and position the mounting holes on one side of the drive over the mounting tabs located on the drive carrier side rail (See letter "A")
3. Lower the other side of the drive into the carrier (See letter "B") and press down on the drive until all mounting tabs are locked in place.

Note: The 2.5" drive blank and drive carrier each have an alignment feature (shown above) to ensure proper assembly. When re-installing a drive blank in to the drive carrier, ensure the features are aligned prior to installation. Failure to properly install a drive blank may result with the carrier assembly not fitting properly in to the chassis drive bay.



CRR018

Figure 56. 2.5" Drive Carrier Assembly – Alignment Features

#### 2.7.4 3.5" HDD/SSD Drive Carrier Assembly

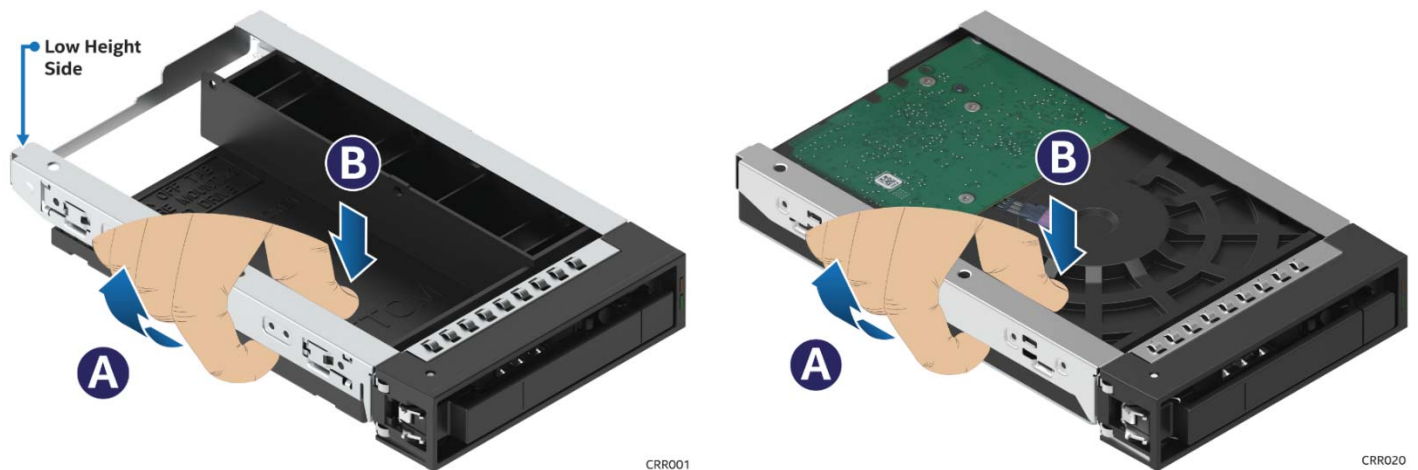
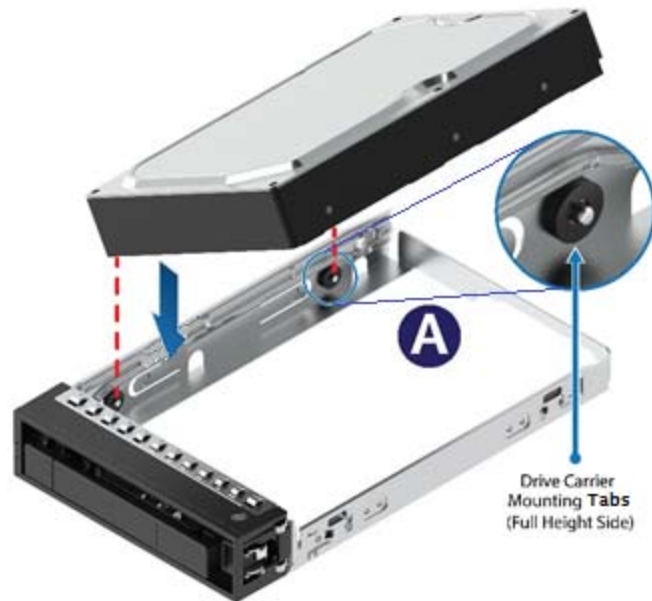


Figure 57. 3.5" Drive Carrier Assembly - Drive / Drive Blank Removal

1. Remove the drive or drive blank from the carrier by holding the carrier assembly top side down in your right hand. Using your left hand, gently rotate the bottom edge of the left rail upwards (see Letter "A") while at the same time pushing the drive or drive blank down away from the carrier (see Letter "B").



**Figure 58. 3.5" Drive Carrier Assembly – Drive Installation to Carrier**

2. With the rear drive connector positioned towards the back of the drive carrier, align and position the mounting holes on the left side of the drive over the mounting tabs located on the drive carrier side rail (See letter "A")
3. Lower the other side of the drive into the carrier and press down until all mounting tabs lock in place.

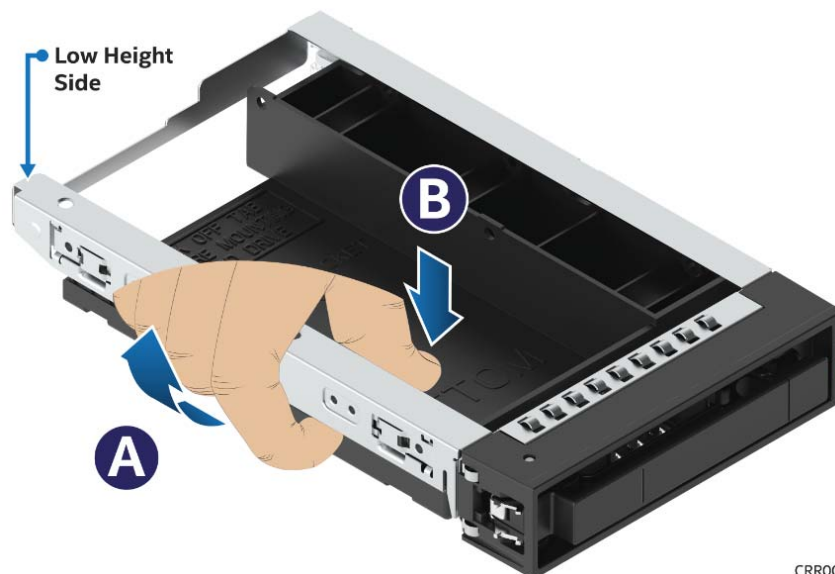
### 2.7.5 2.5" SSD into a 3.5" Drive Carrier Assembly

The 3.5" drive blank can be used as a 2.5" SSD bracket.

---

**Note:** Due to degraded performance and reliability concerns, the use of the 3.5" drive blank as a 2.5" drive bracket is intended to support SSD type storage devices only. Installing a 2.5" hard disk drive into the 3.5" drive blank is not supported.

---

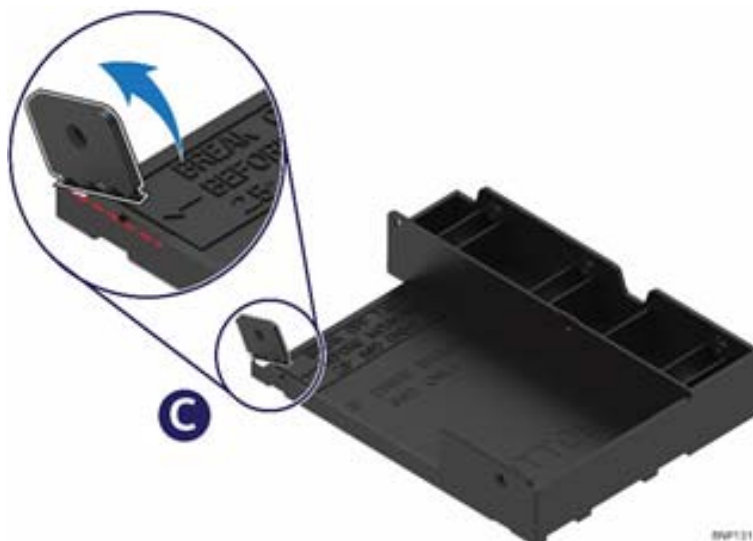


CRR001

**Figure 59. 3.5" Drive Carrier Assembly – Drive Blank Removal**



1. Remove the drive blank from the carrier by holding the carrier assembly top side down in your right hand. Using your left hand, gently rotate the bottom edge of the left rail upwards (see Letter "A") while at the same time pushing the drive blank down away from the carrier (see Letter "B").



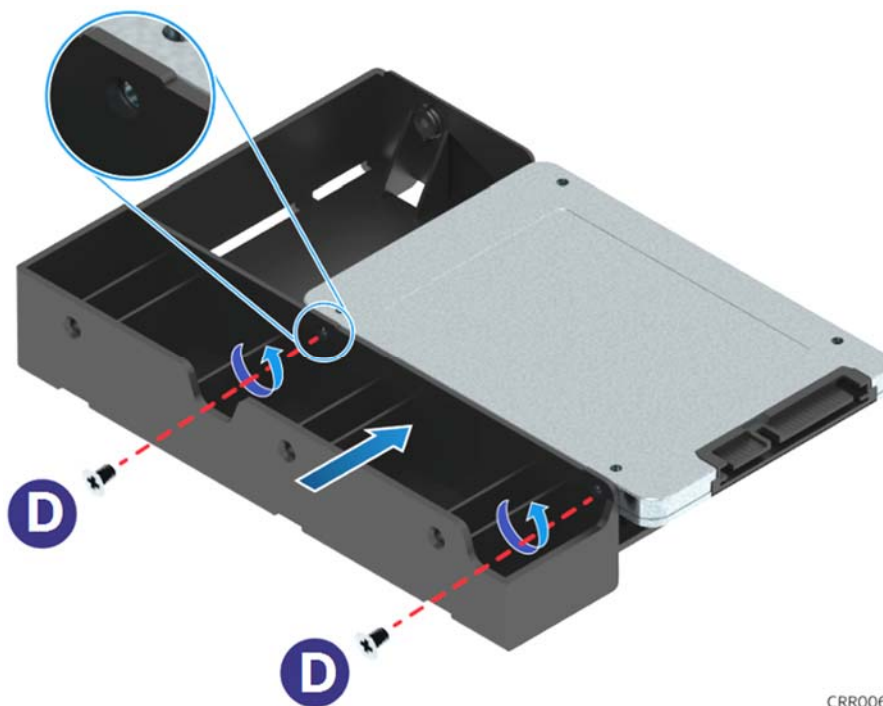
**Figure 60. 3.5" Drive Carrier to 2.5" SSD Bracket – Tab Removal**

2. Break off the small side tab from the side of the drive blank, making the drive blank into a 2.5" drive bracket (see Letter "C").

---

Note: Once the side tab is removed, it cannot be re-attached to the drive blank

---



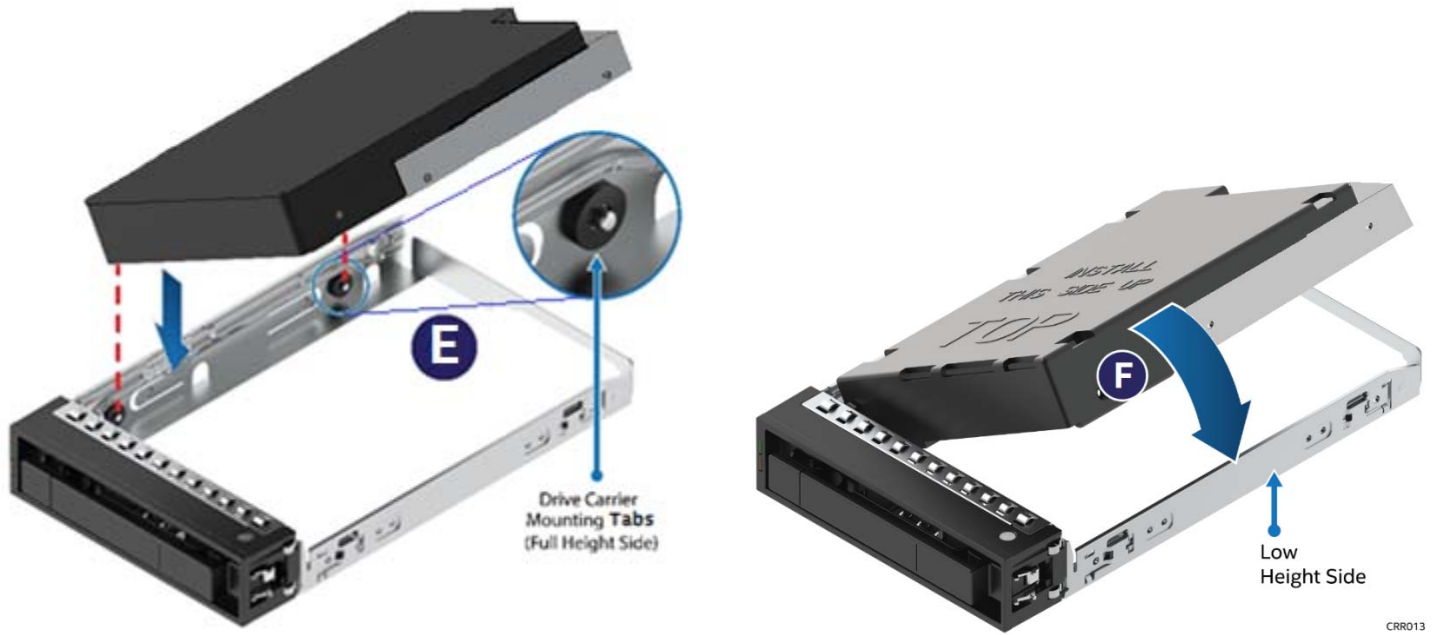
**Figure 61. 3.5" Drive Carrier to 2.5" SSD Bracket – Mount SSD to Bracket**

3. Mount and secure a 2.5" SSD to the drive bracket using two screws at the locations shown above (See letter "D").

---

Note – New drive carriers with drive blanks installed, will include a bag containing four (4) mounting screws.

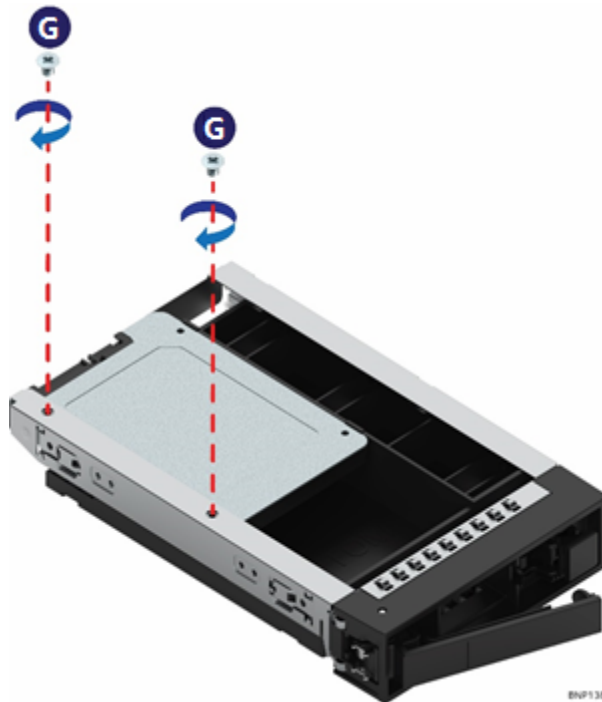
---



CRR013

**Figure 62. 3.5" Drive Carrier to 2.5" SSD Bracket – Mount Bracket Assembly to Carrier**

4. With the rear drive connector positioned towards the back of the drive carrier, align and position the mounting holes on the left side of the drive bracket over the mounting tabs located on the drive carrier side rail (See letter "E")
5. Lower the other side of the drive into the carrier and press down until all mounting tabs lock in place. (See letter 'F')
6. Turn the drive assembly over.



BNP138

**Figure 63. 3.5" Drive Carrier to 2.5" SSD Bracket – Secure SSD to Carrier**

7. Using two (2) screws, secure the SSD to the carrier side rail (See letter "G")

## 2.8 Internal Fixed Mount SATA SSD – Installation / Removal

The system has support for up to two internal fixed mounted SATA Solid State Devices (SSDs). SSD's can be mounted to either of the two available air duct options (Standard or High Air Flow). SSD installation and removal procedures are the same for both air ducts.

### 2.8.1 Internal Fixed Mount Solid State Drive Installation

1. From the system's accessory kit, locate the peripheral device power cable.

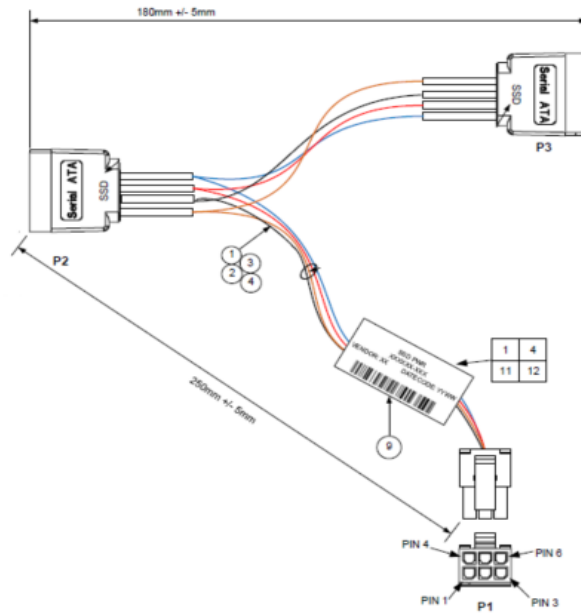


Figure 64. Peripheral Device Power Cable

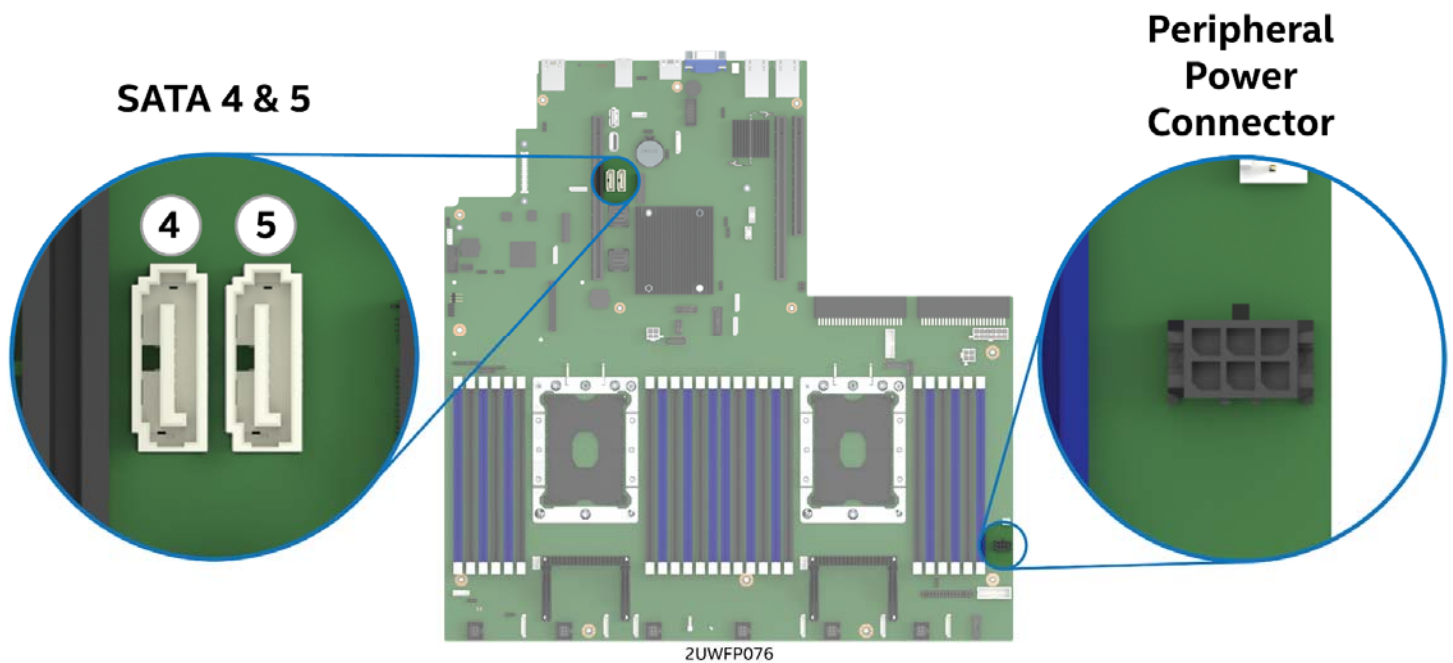
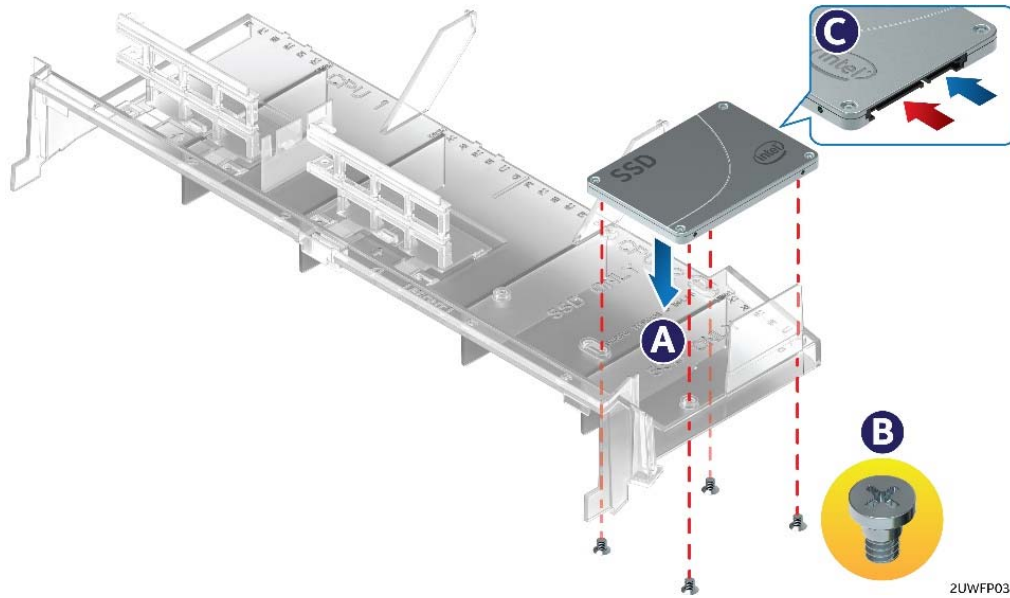


Figure 65. Onboard Peripheral Power and SATA Connectors for Internal SSD support

2. Connect the 2x3 cable connector (labeled "SB") to the server board "Peripheral PWR" connector
3. Locate the SATA cable and install it to either the "SATA 4" or "SATA 5" ports on the server board

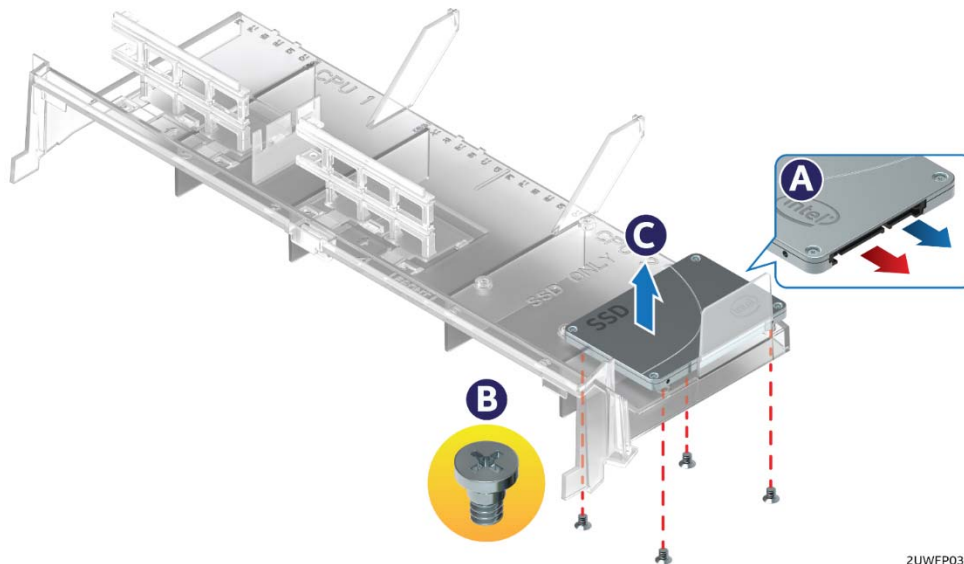


**Figure 66. Internal Fixed Mount SSD Placement**

1. Place the Solid State Drive onto the air duct (see Letter 'A').
2. Secure the Solid State Drive with four screws (see Letter 'B').
3. Install the air duct (see Section 2.3.2).
4. Attach the SATA and Power cables to the SSD (see Letter 'C').

## 2.8.2 Internal Fixed Mount Solid State Drive Removal

**Note:** The internal fixed mount SSDs are NOT hot-swappable. Before removing or replacing the drive, you must first take the server out of service, turn off all peripheral devices connected to the system, turn off the system by pressing the power button, and unplug the power cord from the system or wall outlet.



**Figure 67. Internal Fixed Mount SSD Removal**

1. Remove the system cover (see Section 2.2.1).
2. Detach the SATA and Power cables from the back of the SSD (see Letter 'A').
3. Remove the air duct from the system (see Section 2.3.1)
4. Remove the four screws to release the Solid State Drive (see Letter 'B').
5. Remove the SSD from the air duct (see Letter 'C').

## 2.9 Riser Card Bracket Assembly - Removal / Integration / Installation

The server system can support up to three (3) PCIe riser cards via the two riser card brackets. This section will provide instructions for the removal and installation of the riser card assemblies from/to the system, and installation of an add-in card into the riser assembly.

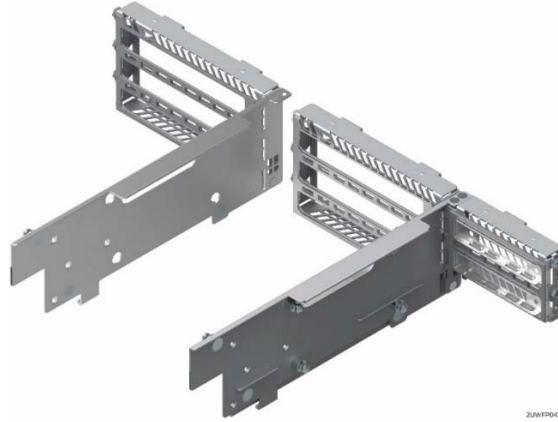


Figure 68. Riser Card Brackets

### 2.9.1 Riser Card Bracket Removal

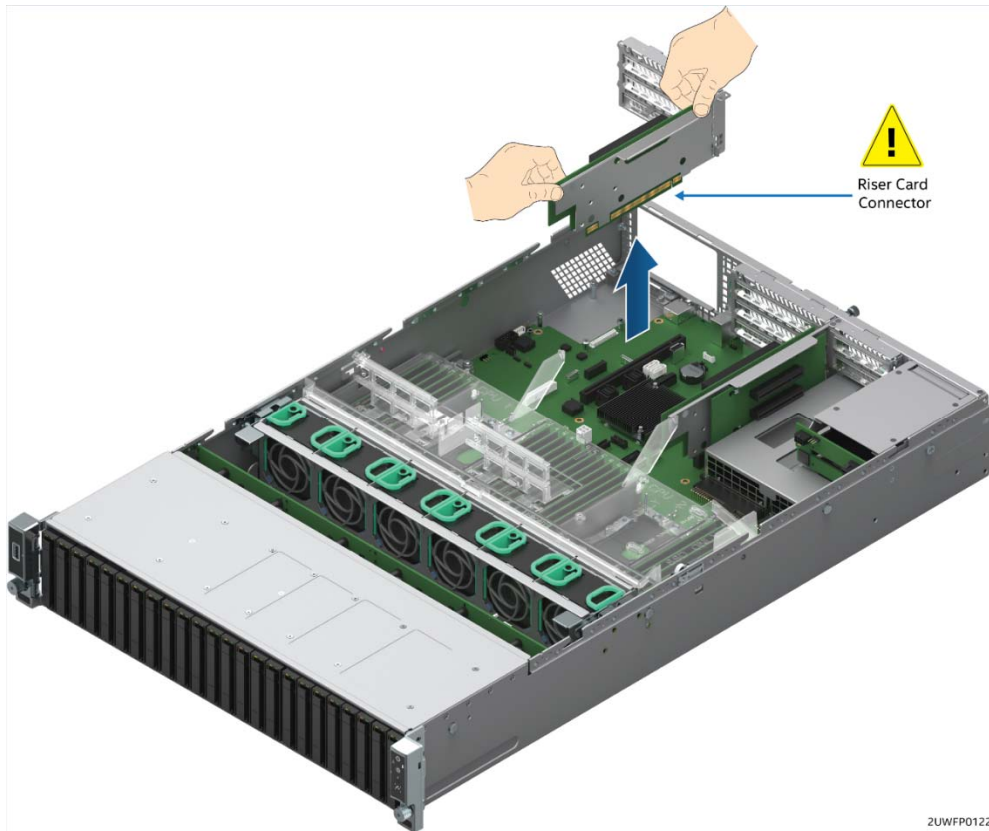


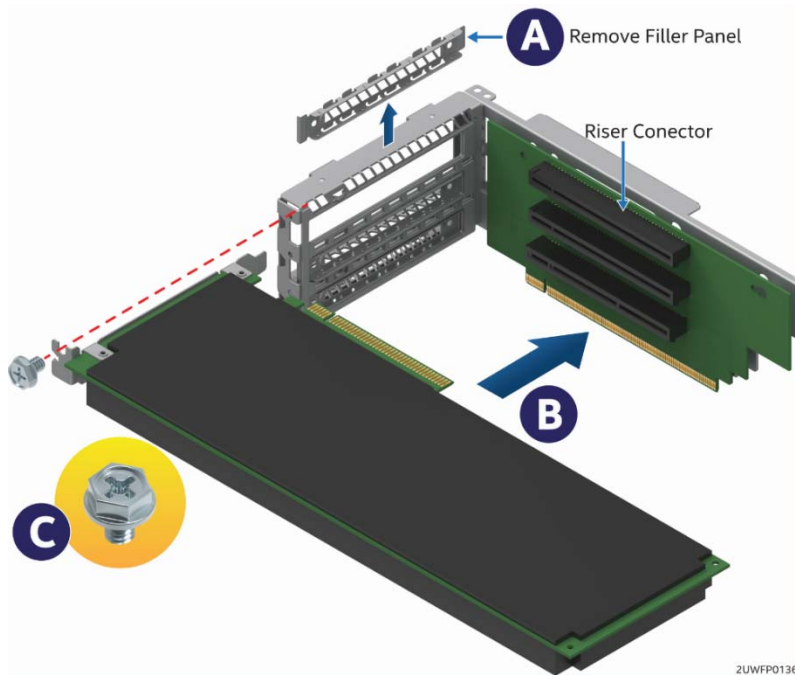
Figure 69. Riser Card Bracket Removal

Disconnect all cables attached to any add-in cards. Grasp the riser assembly with both hands and pull up to remove from the system.



## 2.9.2 PCI Add-in Card Installation

1. Remove the PCI riser assembly from the system. (see Section 2.9.1.)



**Figure 70. PCI Add-In Card Installation**

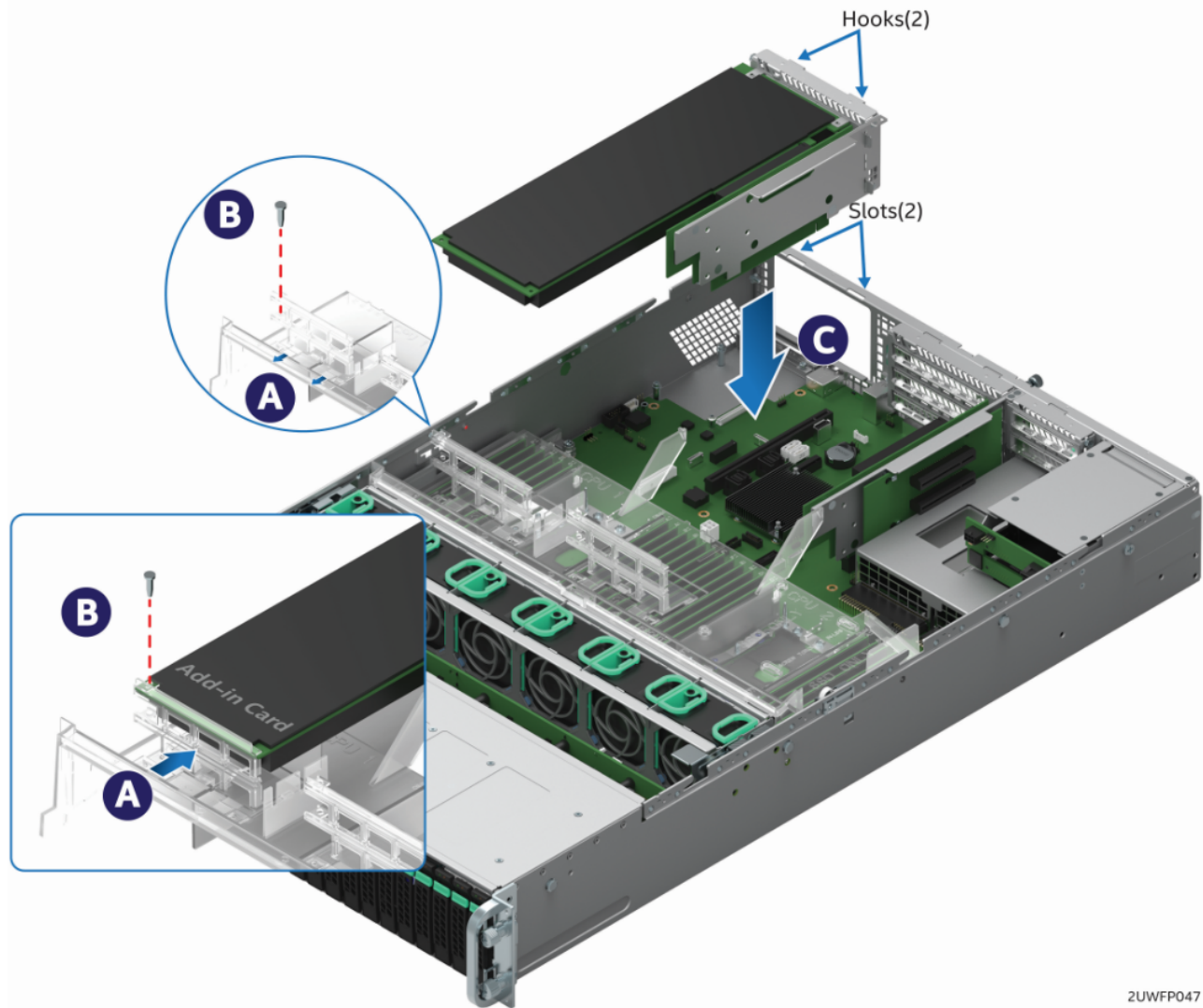
2. Remove the filler panel from the add-in card slot and remove the fastener screw (see Letter 'A').
3. Insert the add-in card until it is fully seated inside the PCI slot on the riser card (see Letter 'B').
4. Secure the add-in card to the riser bracket with the fastener screw using a 12in/lb torque (see Letter 'C').

---

**Note:** For add-in cards with internal cable connectors, it may be necessary to connect cables before installing the riser card assembly into the system.

---

### 2.9.3 Riser Card Bracket Installation



2UWFP047

**Figure 71. Riser Card Bracket Installation**

**Note:** Steps 1, 2, 5, 6, and 7 highlighted below are only needed when a full-length PCIe card is installed on the riser assembly.

1. Slide back the blue card guide on the air duct (see Letter 'A').
2. If installed, remove the blue plastic pin from the card guide (see Letter 'B').
3. Position the riser card's edge connector over the riser slot on the server board and align the two hooks on the back edge of the riser assembly with the slots on the back of the chassis.
4. Once aligned, press the riser assembly straight down into the riser slot (see Letter 'C').
5. Slide forward the card guide to lock in the back edge of the full-length add-in card (see Letter 'A').
6. Locate the blue plastic pin to secure the back edge of the full-length add-in card to the card guide.
7. Insert the blue plastic pin into the card guide and through the matching hole in the add-in card (see Letter 'B').
8. Connect any cables to the add-in cards that require them. See your add-in card documentation for additional information.

## 2.10 PCIe\* NVMe SSD Support

The following 2U backplane options have support for 2.5" small form factor PCIe NVMe SSDs.

- 2.5" x 8 Combo Backplane (iPC – F2U8X25S3PHS) – Support for up to eight (8) NVMe SSDs per installed backplane
- 3.5 x 12 Backplane (iPC – F2U12X35S3PH) – Support for up to two (2) NVMe SSDs

Available options to provide the necessary PCIe data signals to support each installed NVMe drive include:

- Up to Four (4) PCIe OCuLink connectors on the server board
- 4-port PCIe X8 Switch Add-in Card – Accessory Option (iPC AXXP3SWX08040)
- 8-port PCIe X8 Switch Add-in Card – Accessory Option (iPC AXXP3SWX08080)

Accessory kits for the PCIe Switches, and available PCIe OCuLink cables are sold separately from the system. Reference the *Intel® Server S2600WF Product Family Configuration Guide* to determine appropriate cables necessary to match the desired NVMe drive configuration to a specified PCIe source. Cables identified in the Configuration Guide are optimized to provide the cleanest cable routing.

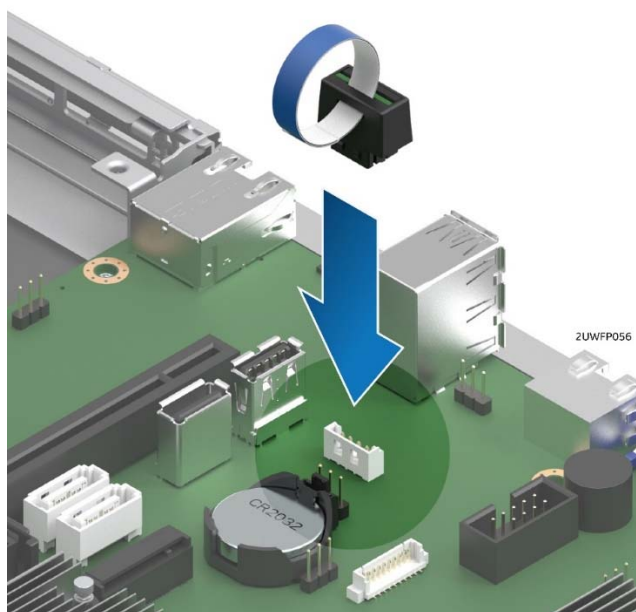
The following procedure should be followed when installing data cables from a backplane to a PCIe source.

1. If installed, removed the system fan assembly module (See section 2.4.1)
2. Locate the PCIe OCuLink cable that supports the desired NVMe drive configuration and PCIe source:
  - a. **Onboard OCuLink connectors** – One (1) NVMe drive per cable (1 connector at each end of the cable)
  - b. **PCIe Switch Add-in Card** – Four (4) NVMe drives per cable (4 connectors at each end of the cable)
3. Attach one end of the cable (1 connector or 4 connectors) to matching PCI\_SSD OCuLink connector(s) on the backplane
4. Route the cable to the nearest chassis sidewall and carefully position it within the cable routing channel along the sidewall
5. Connect the other end of the PCIe OCuLink cable to the appropriate PCIe source (Onboard OCuLink or Add-in Switch card)
6. Repeat steps for each OCuLink cable to be installed
7. If no more cables are to be installed, re-install the system fan module (See section 2.4.2)

The following sections provide information necessary to support NVMe RAID and NVMe Management features. They include instructions for the installation of an Intel® VROC Upgrade Key accessory and associated drive population / support rules when VROC management features are enabled.



### 2.10.1 Installing the Intel® VROC Upgrade Key



**Figure 72. Installing the Intel® VROC Upgrade Key**

1. Remove the Intel® VROC Key from its packaging.
2. Locate the white 4-pin key connector above the CR2032 battery on the back edge of the server board.
3. To install the key, place it over the connector and confirm the orientation of the key matches that of the connector.
4. Press the key down onto the connector.

### 2.10.2 Removing the Intel® VROC Upgrade Key

1. Power off the system and disconnect the power cable(s).
2. Remove the system cover (see Section 2.2.1).
3. Using the key pull tab, pull the key up until it disengages from the connector.

### 2.10.3 NVMe\* Drive Population Rules for Intel® VROC

In order to support NVMe RAID and NVMe Management features, the optional Intel® VROC Key must be installed on to the server board. With the Intel VROC key installed, specific drive population rules exist and must be followed for proper support of the NVMe management features.

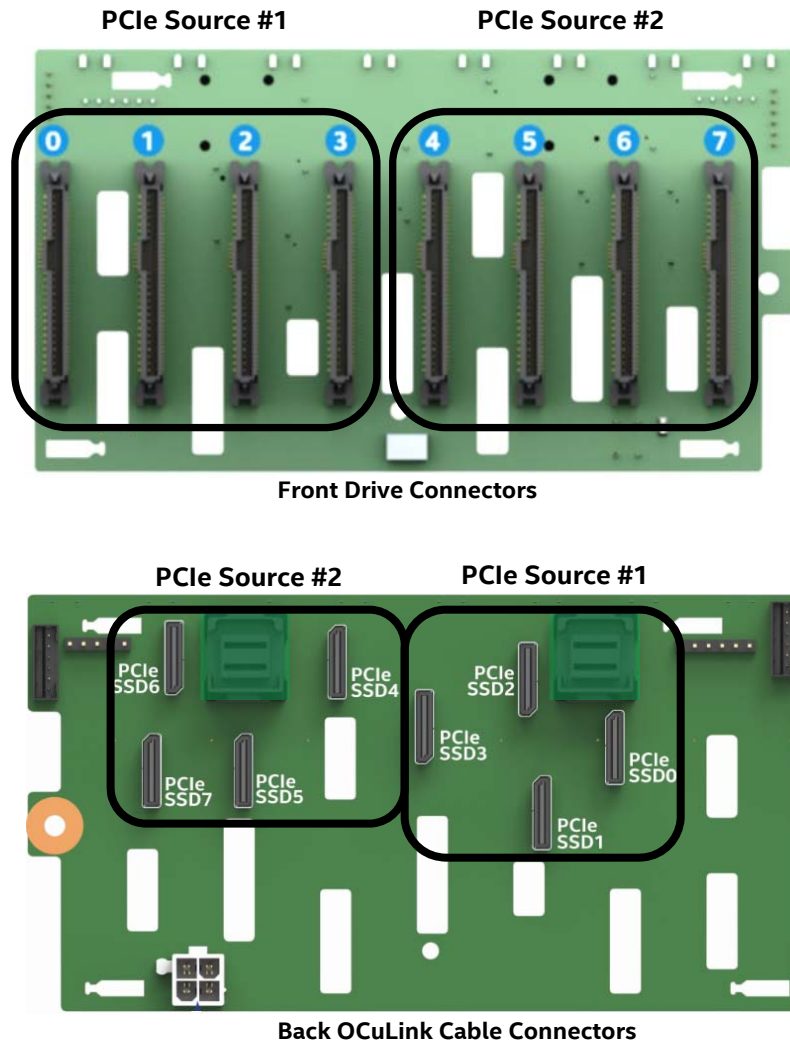
The backplane can support PCIe interfaces from the onboard OCuLink connectors on the server board, and/or optional add-in Intel Tri-Mode RAID modules and/or PCIe Switch cards. When cabling the PCIe interfaces from two different PCIe interface sources to the backplane, the cables from each source must be connected in defined drive sets of four (0,1,2,3) & (4,5,6,7) as shown in the following diagrams.

---

Note: OCuLink connectors on the server board (one or all) routed to the backplane is considered a single source.

Routing OCuLink cables from two or more PCIe sources to a defined drive set is not supported.

---



**Figure 73. Backplane Cabling from Two PCIe Sources**

When cabling the backplane from two different PCIe sources, no other drive set combinations beyond those defined above are supported.

Drive population rules will differ depending on the source of the PCIe interface to the backplane. In addition, specific drive population limits exist when populating a backplane with both NVMe and SAS/SATA drive types.

The following sections define the drive population rules for each installed 2.5" x 8 combo backplane when cabled to a specific PCIe source.

---

NOTE: When connecting the backplane to two different PCIe sources, the defined population rules for each PCIe source are applied to the drive set connected to it

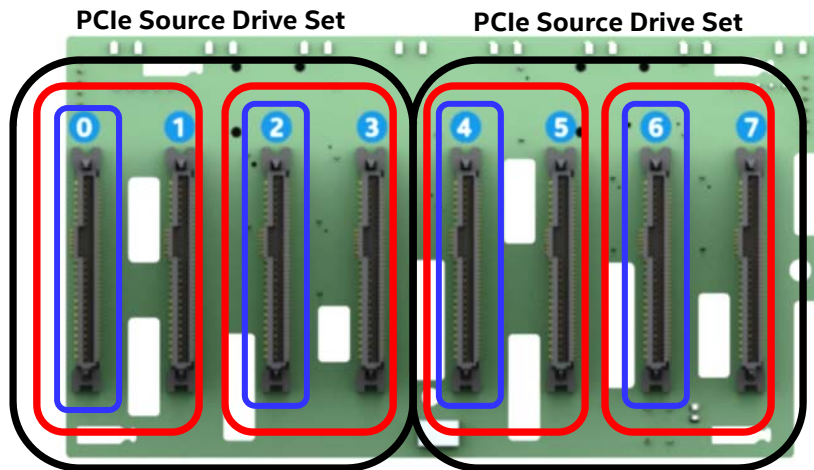
---

### 2.10.3.1 Onboard PCIe OCuLink Connectors and / or Intel Tri-mode RAID module to 8 x 2.5" Combo Backplane

The following information is applicable when PCIe signals to the 8x2.5" combo backplane are cabled from the PCIe OCuLink connectors located on the server board and/or an optionally installed Intel® Tri-mode RAID Module.

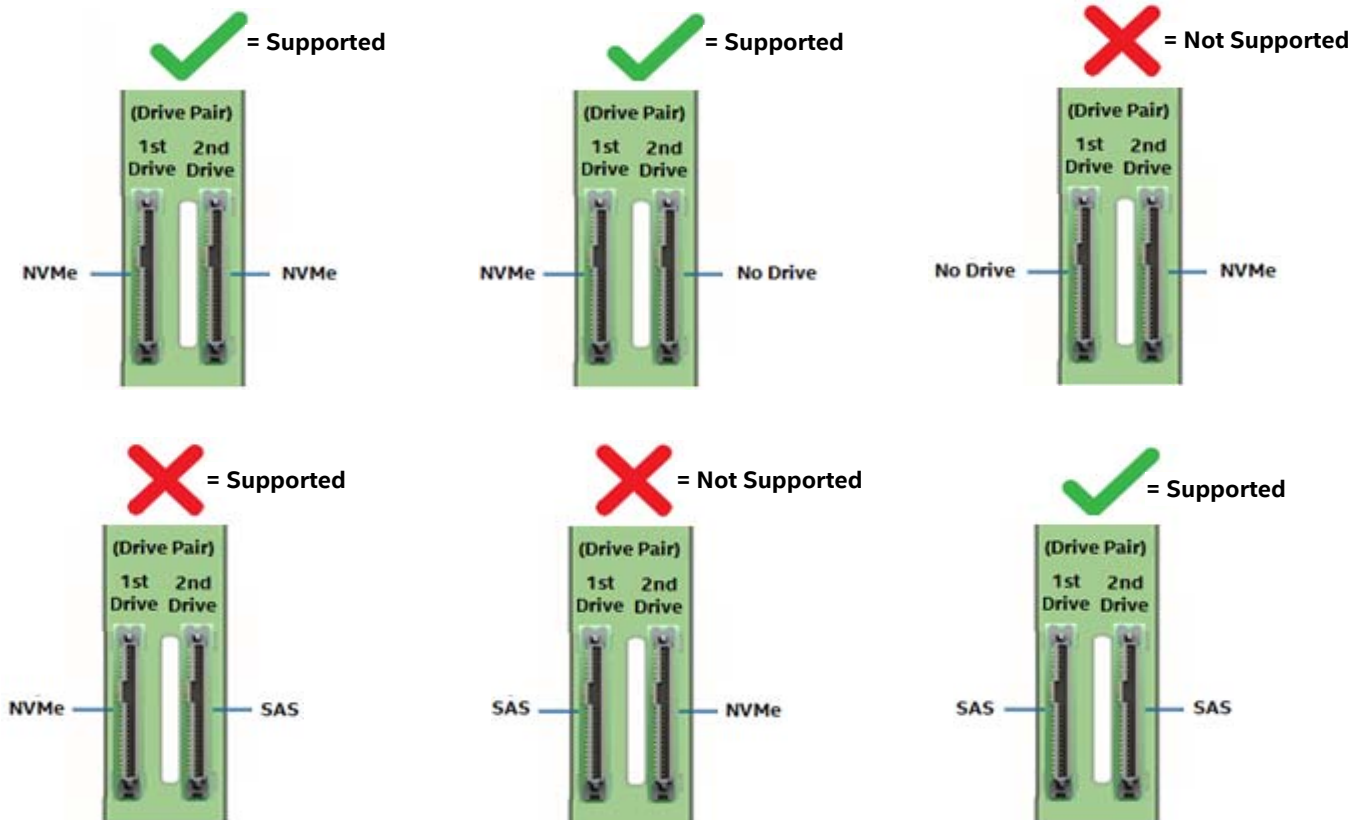
- OCuLink connectors on the server board are considered a single PCIe source to the backplane, and therefore can only be connected in defined drive sets: PCIe\_SSD **(0-3) or (4-7)**

- NVMe drive management sideband signals on the backplane are routed between drive connector pairs: **(0,1) (2,3) (4,5) and (6,7)**
- In order to support NVMe drive management within a defined drive pair, an NVMe drive MUST be populated in the first drive connector of the given pair (drives **0, 2, 4, or 6**)



- Combining an NVMe drive with a SAS/SATA drive within a defined drive pair is NOT supported. Example) In order to support NVMe management features within a given drive set, with an NVMe drive installed to drive connector 0, drive connector 1 cannot be populated with a SAS/SATA drive. The same rule applies to ALL other drive pairs on the backplane.

The following illustrations identify supported and unsupported drive populations associated with any defined drive pair of the 8x2.5" combo backplane when Intel VROC is used for NVMe drive management.

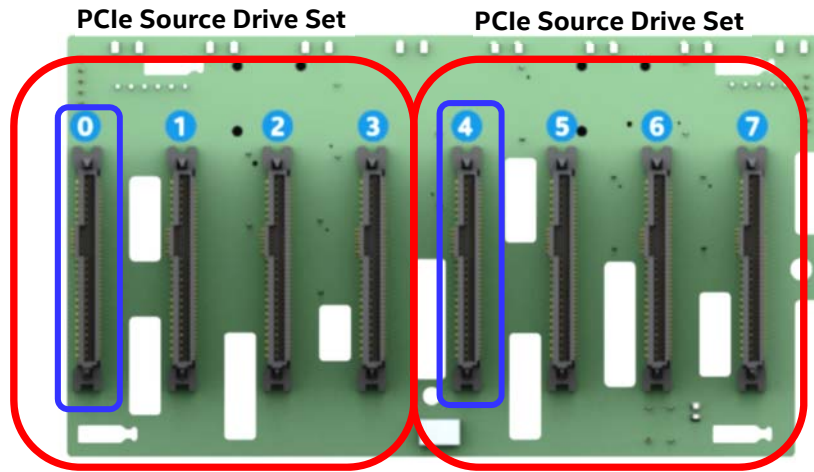


Where 1<sup>st</sup> Drive = drive connectors 0, 2, 4, or 6 and 2<sup>nd</sup> Drive = drive connectors 1, 3, 5, or 7

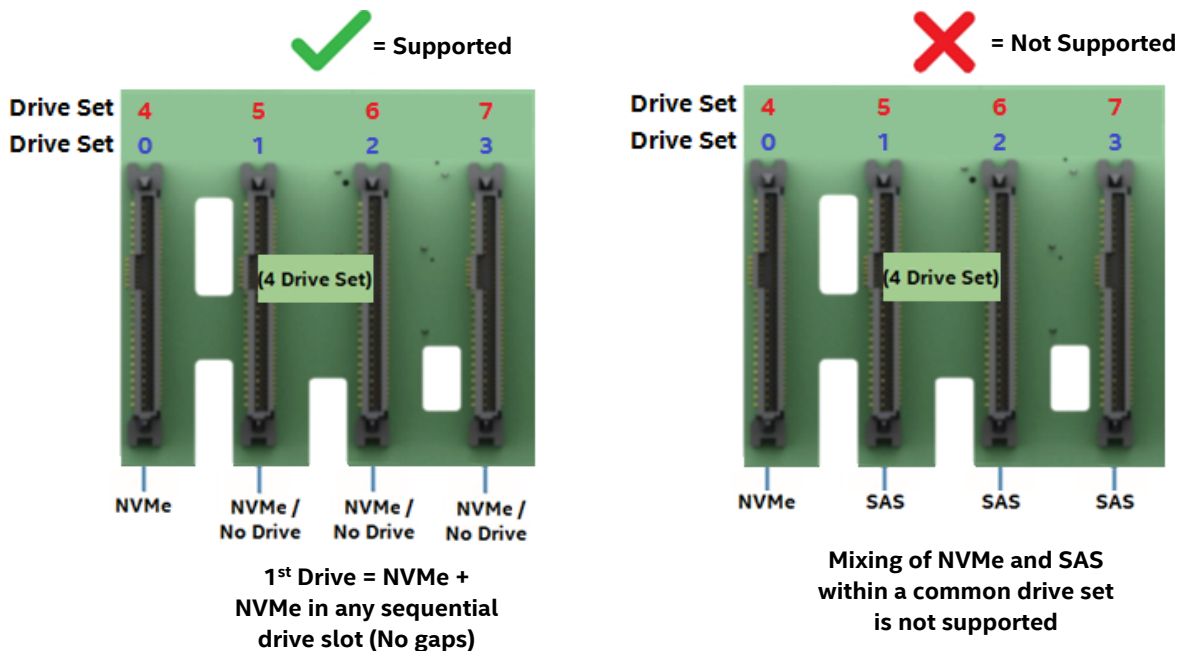
### 2.10.3.2 4 port / 8 port PCIe\* Switch to 8 x 2.5" Combo Backplane

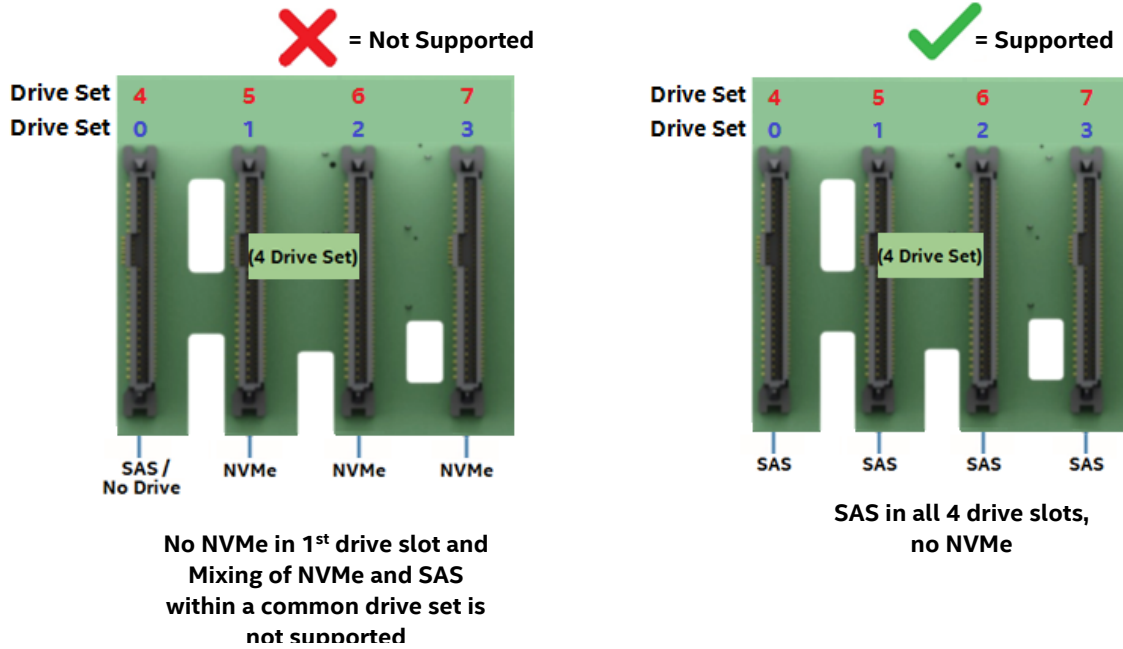
The following information is applicable when PCIe signals to the 8x2.5" combo backplane are cabled from 4 or 8 port PCIe Switch add-in cards.

- NVMe drive management sideband signals on the backplane are routed between drive connector sets: **(0,1,2,3)** and **(4,5,6,7)**
- In order to support NVMe drive management within a defined drive set, an NVMe drive **MUST** be populated in the first drive connector of the given set (drive connectors **0 or 4**). Additional NVMe drives within the drive set must be populated in sequential order with no gaps between drive connectors.
- Combining NVMe drives and SAS/SATA drives within a defined drive set is **NOT** supported.



The following illustrations identify supported and unsupported drive populations associated with any defined drive set of the 8x2.5" combo backplane when an Intel® VROC key is installed to the server board and the PCIe source to the backplane is from an add-in PCIe Switch card.





---

**Note:** The NVMe drive population rules defined above are only applicable when the Intel® VROC accessory option is installed and used to provide NVMe drive management.

---

## 3. Configuration Options and Accessory Kit Integration and Service

---

### Purpose

This chapter provides instructions for the integration of system components within a server system that has the server board and other system components pre-installed. It includes installation instructions for supported system options, and other available accessory option kits.

### Before You Begin

Before working with your server product, observe the safety and ESD precautions found in the Warnings section at the beginning of this manual.

### Tools and Supplies Needed

- Anti-static wrist strap and conductive foam pad (recommended).
- Phillips\* (cross head) screwdriver (#1 and #2 bits).

### System Reference

All references to left, right, front, top, and bottom assume the reader is facing the front of the chassis.

### Instruction Format

Each procedure described in this section will follow an illustration first format. This format will give the reader the option to follow a quicker path to system integration by first seeing an illustration of the intended procedure. If necessary, the reader can then follow the step-by-step instructions that will accompany each procedure.



## 3.1 Power Supply Module – Installation / Removal

### 3.1.1 2<sup>nd</sup> Power Supply Module Installation

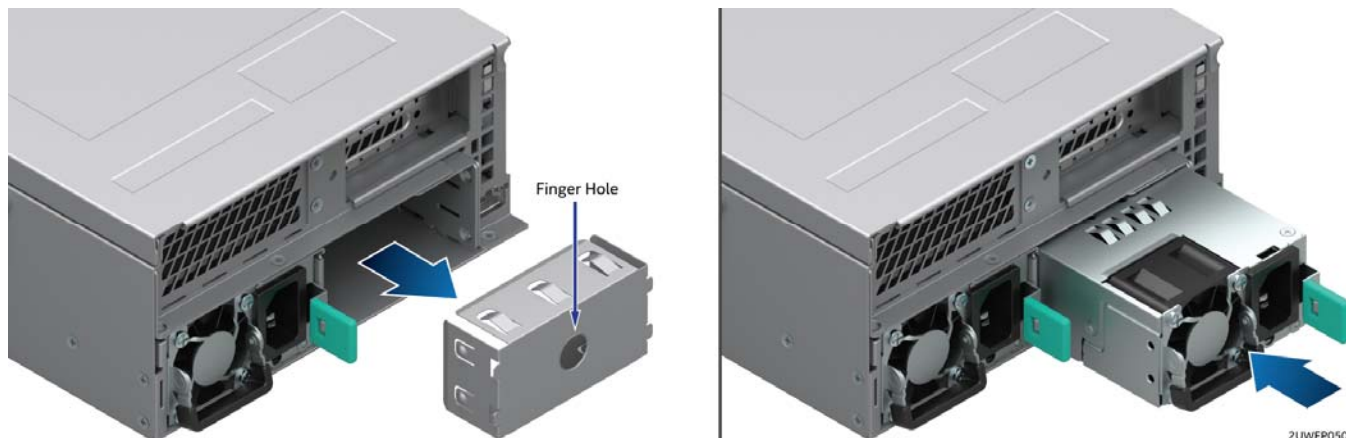


Figure 74. Power Supply Module Installation

1. If installed, remove the insert from the chassis power supply bay.
2. Install the power supply module into the power supply bay.
3. Push the power supply module into the bay until it locks into place.

### 3.1.2 Power Supply Module Removal

---

**Caution:** The power supply is only hot-swappable (system does not have to be powered down) if the system is configured with two power supply modules operating in a 1+1 redundant configuration only.

Systems with a single power supply installed or a system operating in a 2+0 non-redundant power mode, **MUST** be powered OFF before removing the power supply module from the system.

---

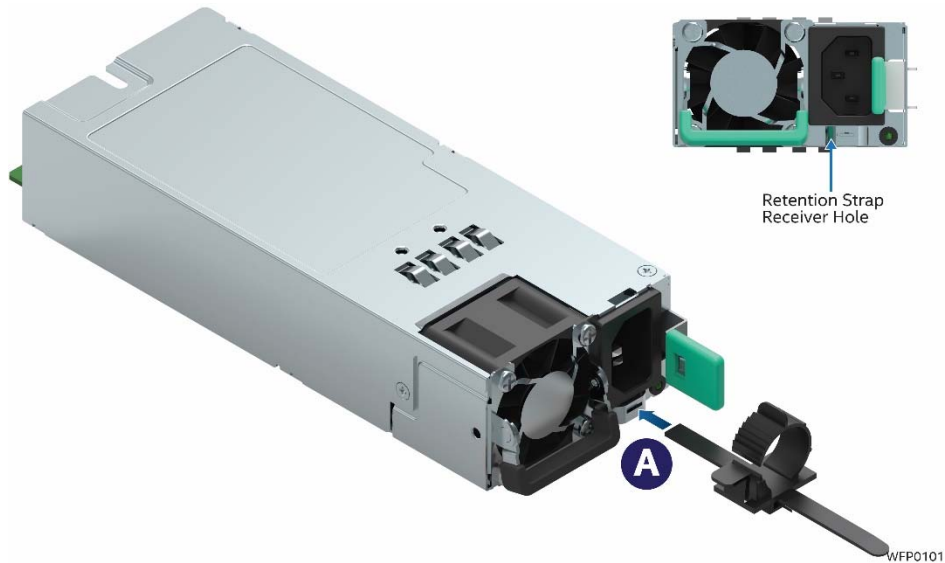
1. Detach the power cord from the power supply to be removed.
2. While pushing the green latch in the direction shown, use the handle to pull the power supply module from the system



Figure 75. Power Supply Module Removal

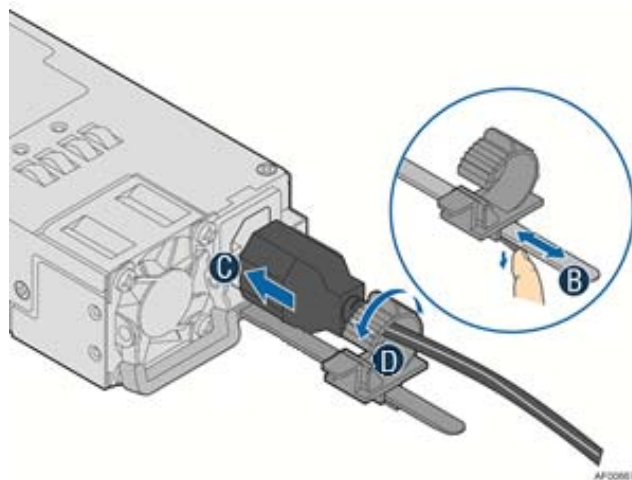
### 3.1.3 Power Cord Retention Strap Installation

To minimize the risk of someone accidentally pulling out a power cord from the power supply, it is highly recommended that the supplied power cord retention strap be installed.



**Figure 76. Power Cord Retention Strap Installation**

1. Locate the power cord retention strap from the system accessory kit.
2. Insert the locking tab end of the Retention Strap into the receiver hole located beneath the power supply socket on the back of the power supply module (see Letter 'A').



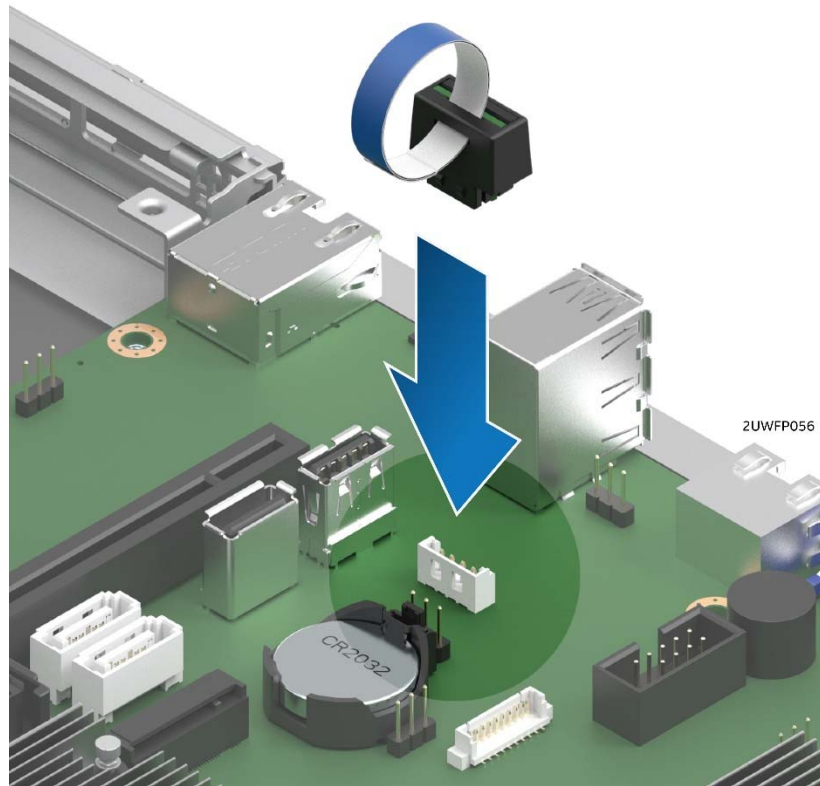
**Figure 77. Plugging the Power Cable**

3. While pushing up the locking tab on the bottom of the slider, adjust the slider to the desired position (see Letter 'B').
4. Install the power cord into the power supply socket on the back side of the power supply (see Letter 'C').
5. Pull the slider strap over the power cord and lock it securely into place (see Letter 'D').
6. To remove the power cord from the Retention Strap, push down on the slider tab to release the slider strap.
7. Pull the slider strap back over the power cord.
8. Remove power cord.



## 3.2 ESRT2 SATA RAID 5 Upgrade Key – Installation / Removal

### 3.2.1 ESRT2 SATA RAID 5 Upgrade Key Installation



**Figure 78. SATA RAID 5 Upgrade Key Installation**

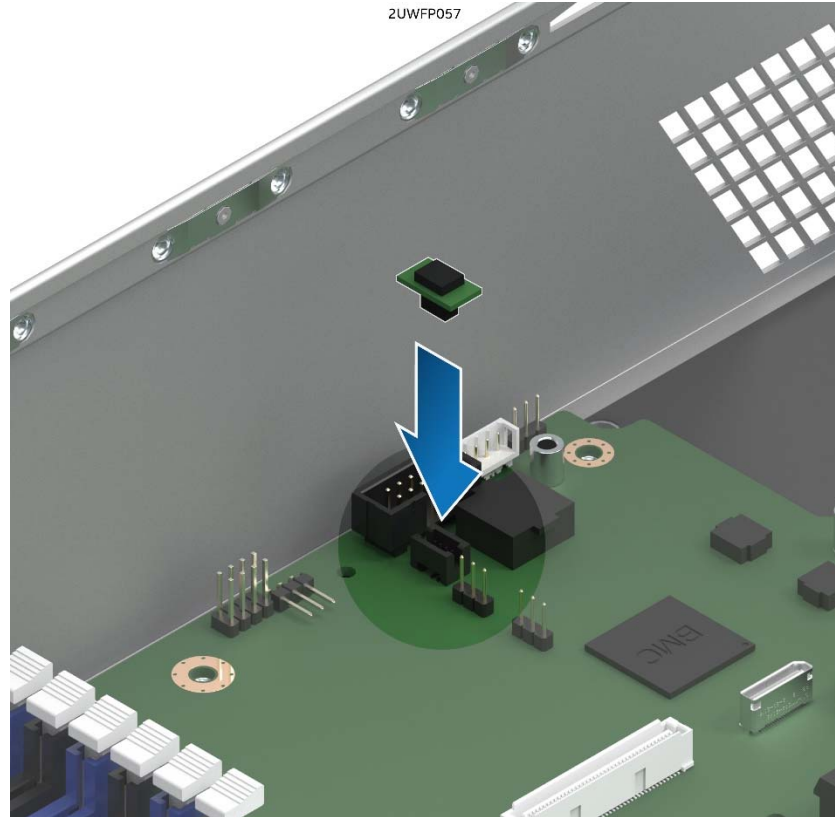
1. Remove the SATA 5 Upgrade Key from its packaging.
2. Locate the white 4-pin key connector above the CR2032 battery on the back edge of the server board.
3. To install the key, place it over the connector and confirm the orientation of the key matches that of the connector.
4. Press the key down onto the connector.

### 3.2.2 ESRT2 SATA RAID 5 Upgrade Key Removal

1. Power off the system and disconnect the power cable(s).
2. Remove the system cover (see Section 2.2.1).
3. Using the key pull tab, pull the key up until it disengages from the connector.

### 3.3 Intel® Remote Management Module 4 Lite Key – Installation / Removal

#### 3.3.1 Intel® RMM4 Lite Key Installation



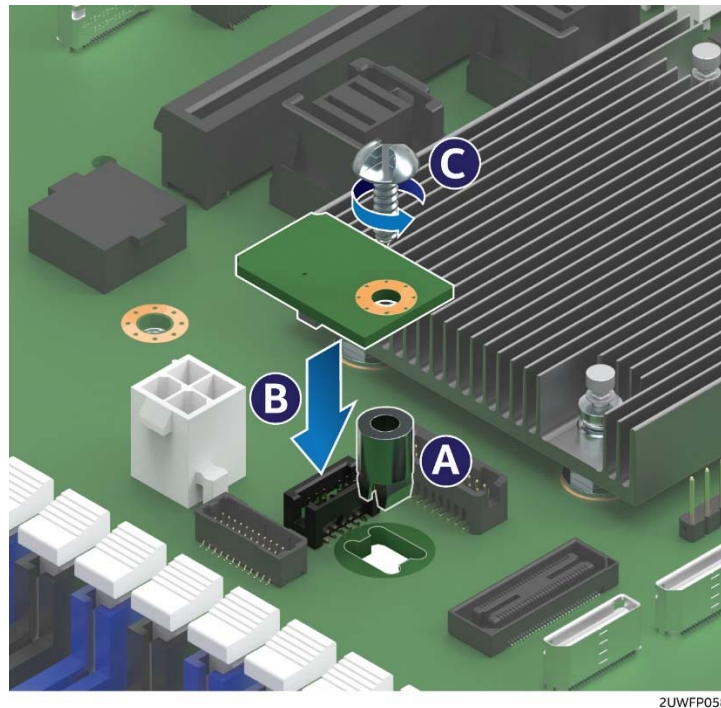
**Figure 79. Intel® RMM4 Lite Key Installation**

1. Remove the Intel® RMM4 Lite key from its packaging.
2. Locate the Intel® RMM4 Lite connector on the server board next to the front panel USB 2.0 connector.
3. Place the Intel® RMM4 Lite key over the connector and match the orientation of the key to that of the connector.
4. Press the key down onto the connector.

#### 3.3.2 Intel® RMM4 Lite Key Removal

1. Power off the system and disconnect the power cable(s).
2. Remove the system cover (see Section 2.2.1).
3. Carefully grasp the key by its edges and pull it up until it disengages from the connector.

### 3.4 Trusted Platform Module (TPM) Installation



**Figure 80. Trusted Platform Module (TPM) Installation**

1. Locate the TPM module connector on the server just below the PHM.
2. Insert the plastic stand-off into the server board mounting hole (see Letter “A”).
3. Place the TPM module over the connector, match the orientation and press the key down onto the connector (see Letter “B”).
4. Secure the TPM module to the stand-off with the fastener screw (see Letter “C”). Tightened to 8 in-lb

---

**Note:** TPM module comes with two screws in kit, one Philips head version and one tamper proof version.

---

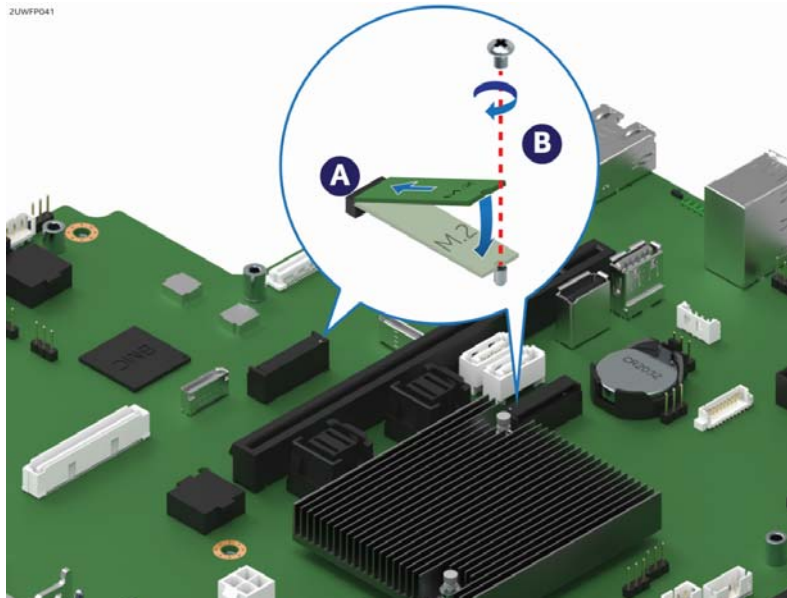
### 3.5 M.2 Memory Devices

#### 3.5.1 M.2 Installation

There are two onboard M.2 connectors, one located by Riser Slot 1 and the other is located by SATA 4 and 5 connectors.



**Figure 81. M.2 SSD Connector Locations**



**Figure 82. M.2 Device Installation**

Screws for M.2 drives are pre-installed on the server board mounting standoffs.

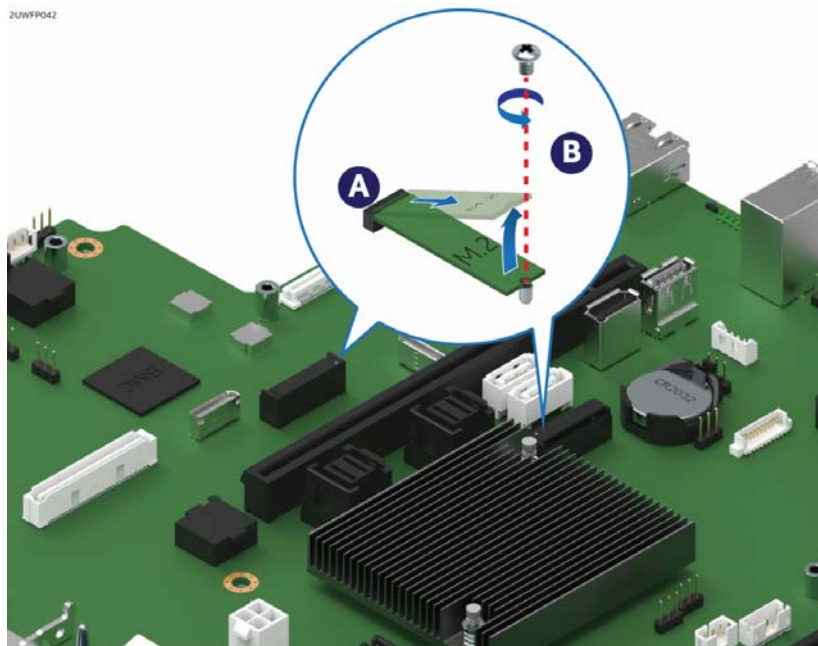
1. Remove the pre-installed screw from the server board mounting standoff.
2. Insert the M.2 SSD into the M.2 socket (see Letter 'A').
3. While holding down the M.2 drive, secure it with the previously removed screw (see Letter 'B').  
Tightened to 8 in-lb

---

**Note:** Not holding down the loose end of the M.2 drive while installing the screw will cause the board to spring up and make installing the screw difficult.

---

### 3.5.2 M.2 Removal



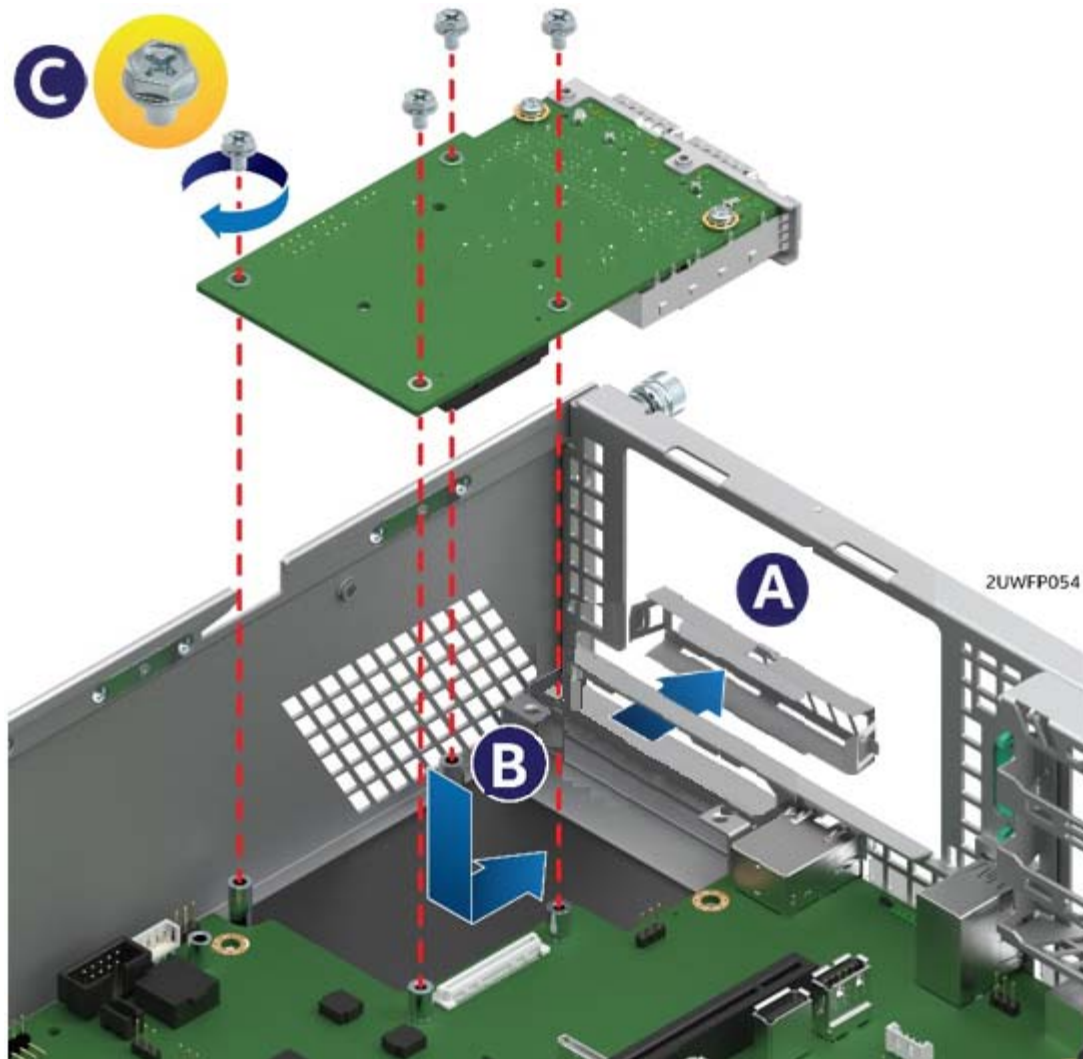
**Figure 83. M.2 Device Removal**

1. Remove the screw to release the M.2 drive (See Letter 'B').
2. Carefully remove the M.2 drive from the socket (see Letter 'A').
3. For future use, re-install the screw into M.2 standoff and Tightened to 8 in-lb



## 3.6 OCP Expansion Module – Installation / Removal

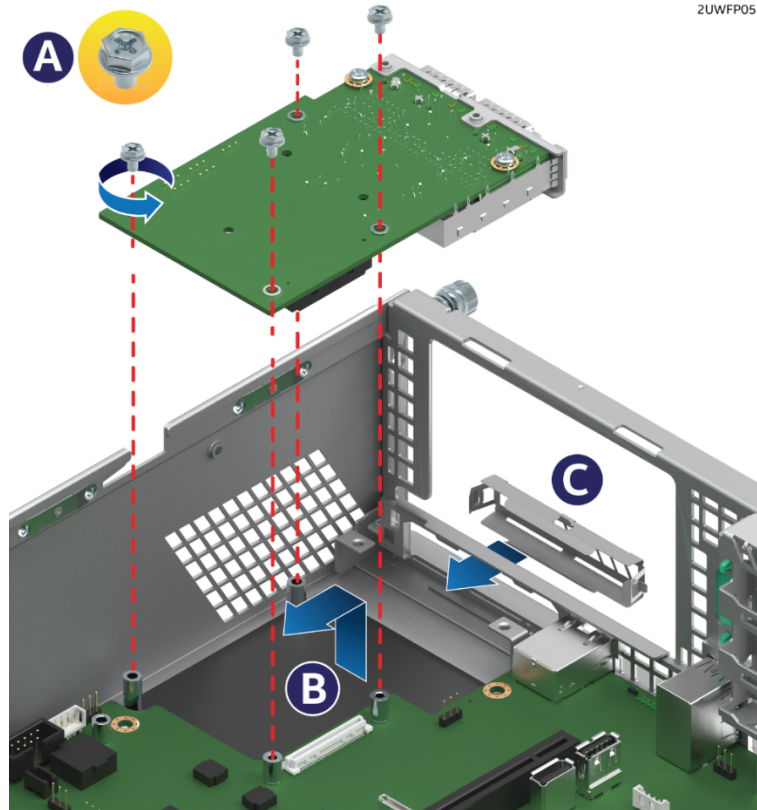
### 3.6.1 OCP Expansion Module Installation



**Figure 84. OCP Expansion Module Installation**

1. Remove the OCP bay filler insert from the chassis back panel. Squeeze the panels on each side of the filler and push it out from the chassis. (See letter 'A')
2. Remove the four (4) pre-installed screws from the OCP Module mounting stand-offs (2 on the server board + 2 on the chassis base)
3. Carefully angle and position the rear connectors of the OCP module into the cut-out on the chassis back panel and place the module over the server board connector. Care should be taken NOT to damage the I/O shield material when placing the OCP module into the back panel cut-out (see Letter 'B').
4. Carefully press down on the module to engage the connectors.
5. Secure the module with four screws as shown (see Letter 'C'). Tightened to 8 in-lb

### 3.6.2 OCP Expansion Module Removal



2UWFP055

**Figure 85. OCP Expansion Module Removal**

1. Power off the server and detach the power cable(s).
2. Detach all cables from the OCP Module.
3. Remove the system cover – (see Section 2.2.1).
4. Remove the four screws as shown (see Letter 'A').
5. Carefully pull up on the OCP Module until it disengages from the server board (see Letter 'B').
6. If no replacement module is to be installed, re-install the OCP bay filler panel (See letter 'C')

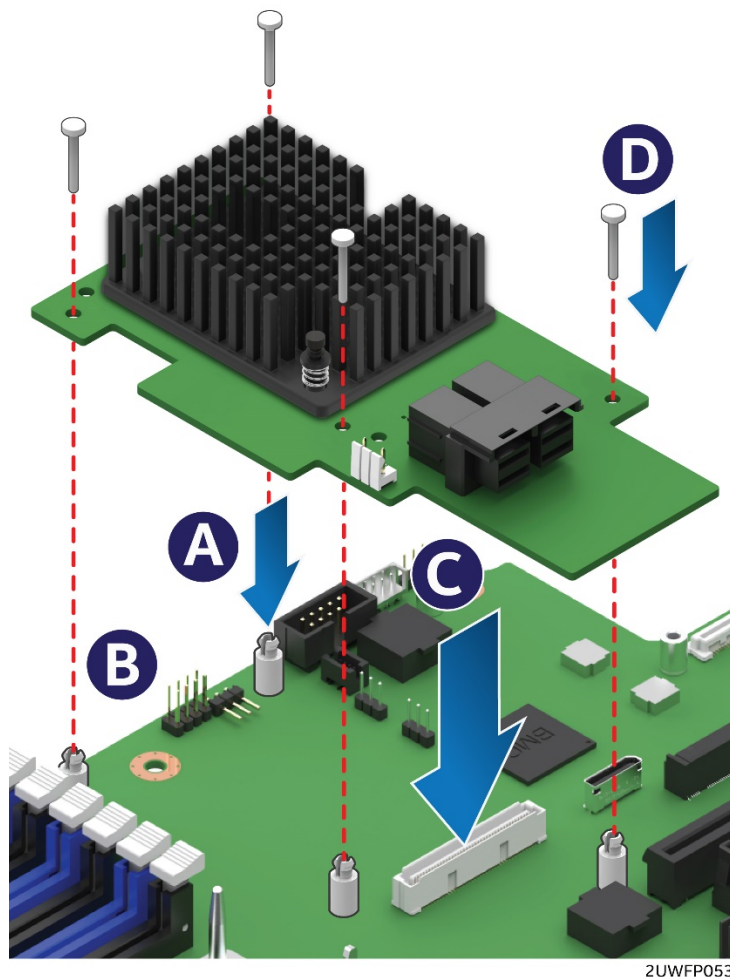
---

**Note:** The filler panel snaps into the back panel from the outside of the chassis.

---

## 3.7 Intel® SAS RAID Module Installation/Removal

### 3.7.1 Intel® SAS RAID Module Installation



2UWFP053

**Figure 86. Intel® SAS RAID Module Installation**

1. Insert the four barrel standoffs into the matching holes in the server board (see Letter 'A').
2. Align the module mounting holes over the four barrel standoffs (see Letter 'B').
3. Press down firmly until the module connector is fully engaged with the matching connector on the server board and the module is firmly seated over each barrel standoff (see Letter 'C').
4. Insert a locking pin into each barrel standoff and connect cables (see Letter 'D').

### 3.7.2 Intel® SAS RAID Module Removal

1. Disconnect cables and remove the four locking pins from each barrel standoff.
2. Grasp the module near the front two barrel standoffs and pull up firmly until the front side of the module is clear of the standoffs.
3. Repeat step 2 to release the other side of the module.

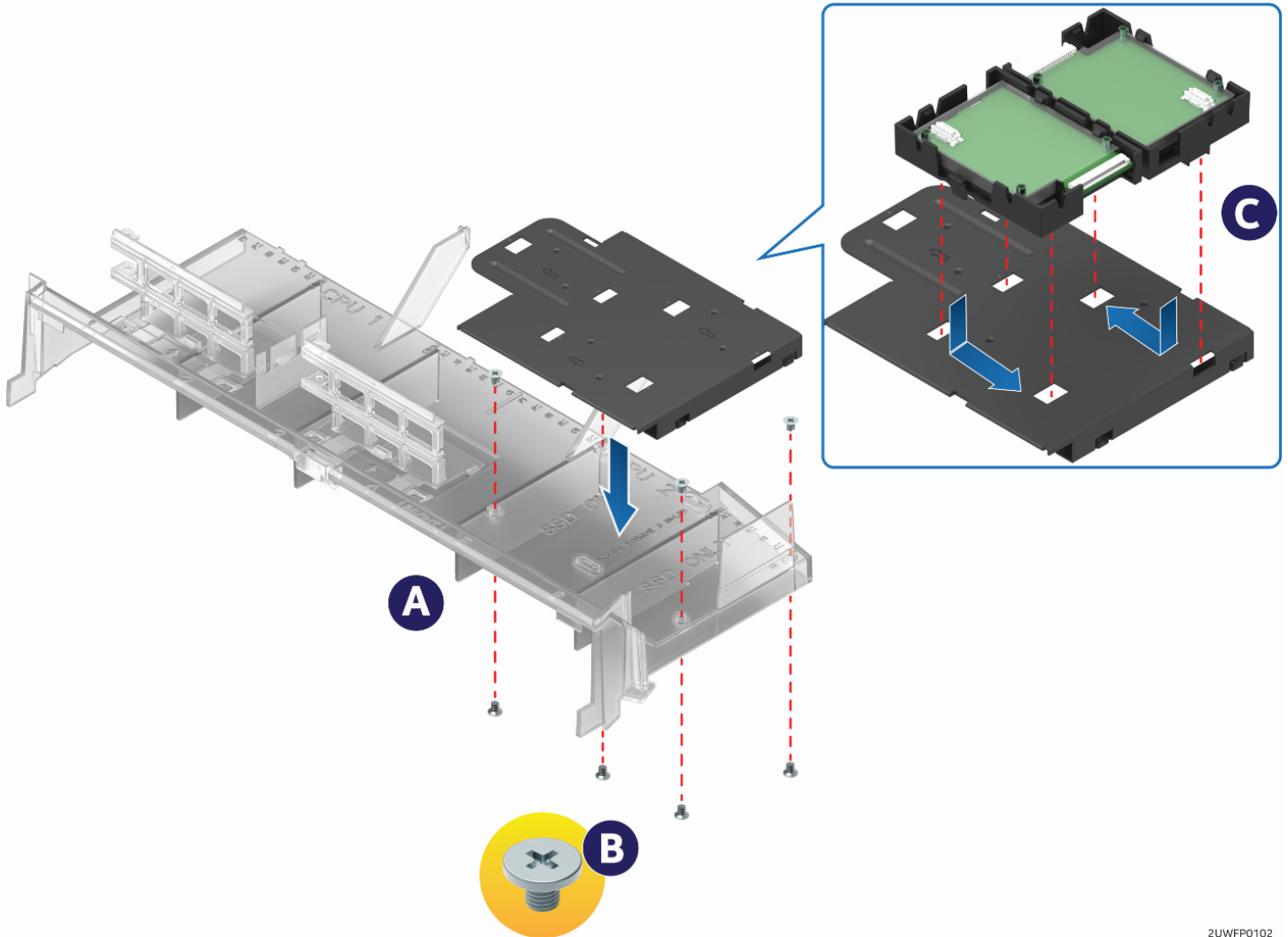
---

**Note:** Remember to remove the four plastic barrel standoffs when replacing the server board.

---



### 3.8 Intel® RAID Maintenance Free Backup Unit (RMFBU) – Mounting Bracket Installation



2UWFP0102

**Figure 87. Intel® RMFBU Installation**

1. Remove the RMFBU mounting bracket from the system accessory kit.
2. Place the RMFBU bracket onto the air duct (see Letter 'A').
3. Secure the RMFBU bracket to the air duct using the four screws (see Letter 'B').
4. Slide and lock the RMFBU onto the mounting bracket (see Letter 'C').

### 3.9 Intel® Omni-Path IFT Carrier Accessory Kit Installation

The Intel® Server System R2000WF product family has support for 1 or 2 Intel® Xeon® processor Scalable family SKUs that include an Intel Omni-path Host Fabric Interface (HFI) connector. In support of these processor SKUs, one of two available Intel accessory kits is necessary to enable support for the fabric interface.

- **AWF1PFABKITM** – Intel Omni-path IFT Carrier Kit – Mezzanine Card
- **AWF1PFABKITP** – Intel Omni-path IFT Carrier Kit – PCIe Add-in Card

The following sections describe the installation of components included with each kit.

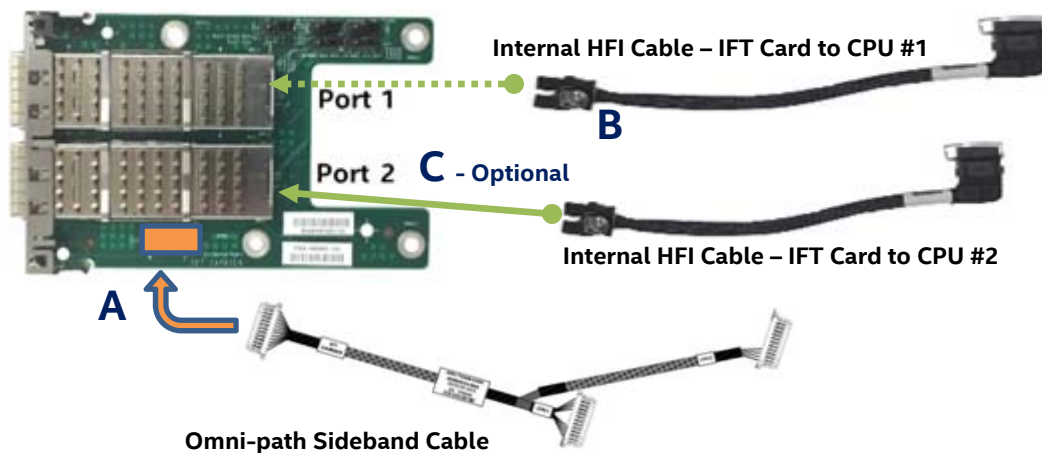
#### 3.9.1 Intel® Omni-path IFT Carrier Kit (iPC AWF1PFABKITM) – Installation

Kit Contents:

- 1 – Dual port IFT Carrier Mezzanine Card
- 1 – Internal Host Fabric Interface (HFI) Cable (CPU1)
- 1 – Internal Omni-Path Sideband Cable
- 2 – Fabric Processor Carrier Clips

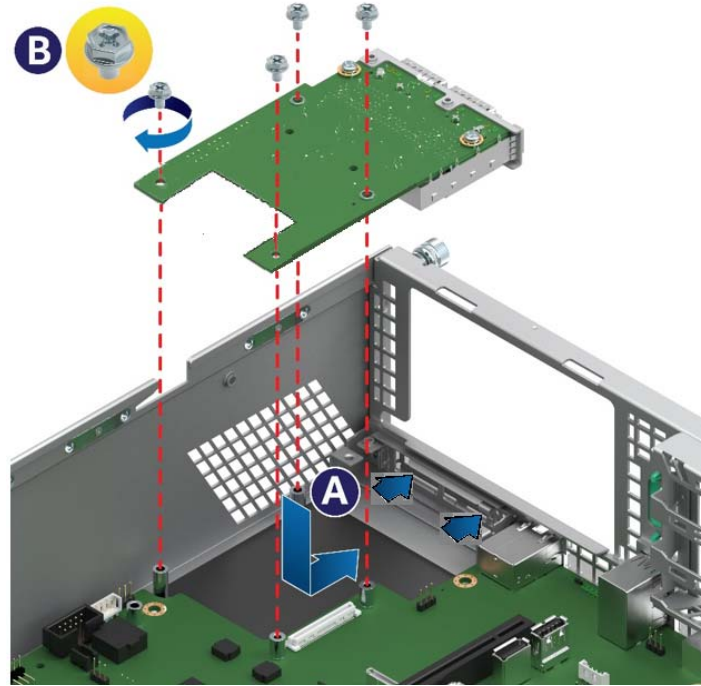
Intel Cable Kit **AXXCBL235IFPL1** required for dual fabric processor configurations.

1. Install Fabric processor(s) on to the server board. See Section 2.5 for processor assembly and installation instructions.



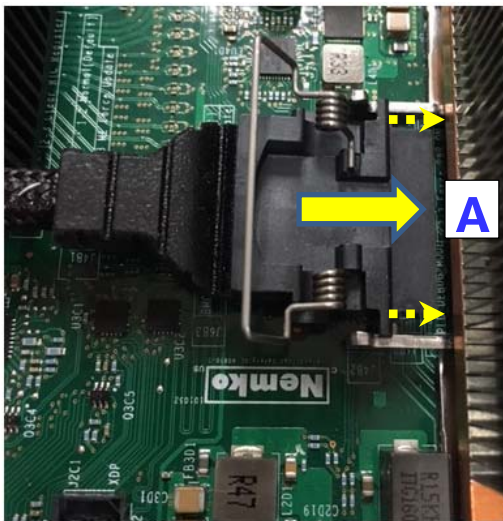
**Figure 88. IFT Carrier Mezzanine Card Assembly**

2. Connect the internal Omni-path sideband cable to the matching connector on the IFT Carrier mezzanine card (See letter "A")
3. Insert the internal HFI cable to Port 1 of the IFT Carrier mezzanine card until it locks into place (See letter "B")
4. (Optional – For dual Fabric processor configurations) Insert the second internal HFI cable to Port 2 of the IFT Carrier mezzanine card until it locks into place (See letter "C")

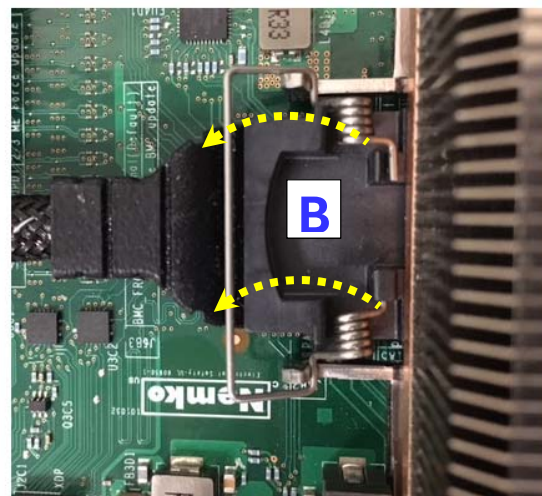


**Figure 89. IFT Mezzanine Card Installation**

5. Remove the OCP bay filler from the chassis back panel. Squeeze the panels on each side of the filler and push it out from the chassis.
6. Remove the four (4) pre-installed screws from the mounting stand-offs (2 on the server board + 2 on the chassis base)
7. Carefully angle and insert the rear connectors of the IFT Carrier card into the cut-out on the chassis back panel and position the card over the four stand-offs on the server board (see Letter 'A'). Care should be taken NOT to damage the I/O shield material when placing the card into the back panel cut-out
8. Secure the IFT Carrier card with four screws (see Letter 'B'). Tightened to 8 in-lb
9. Route the HFI cable attached to Port 1 of the IFT Carrier Card to CPU #1



**Place and Insert Cable**

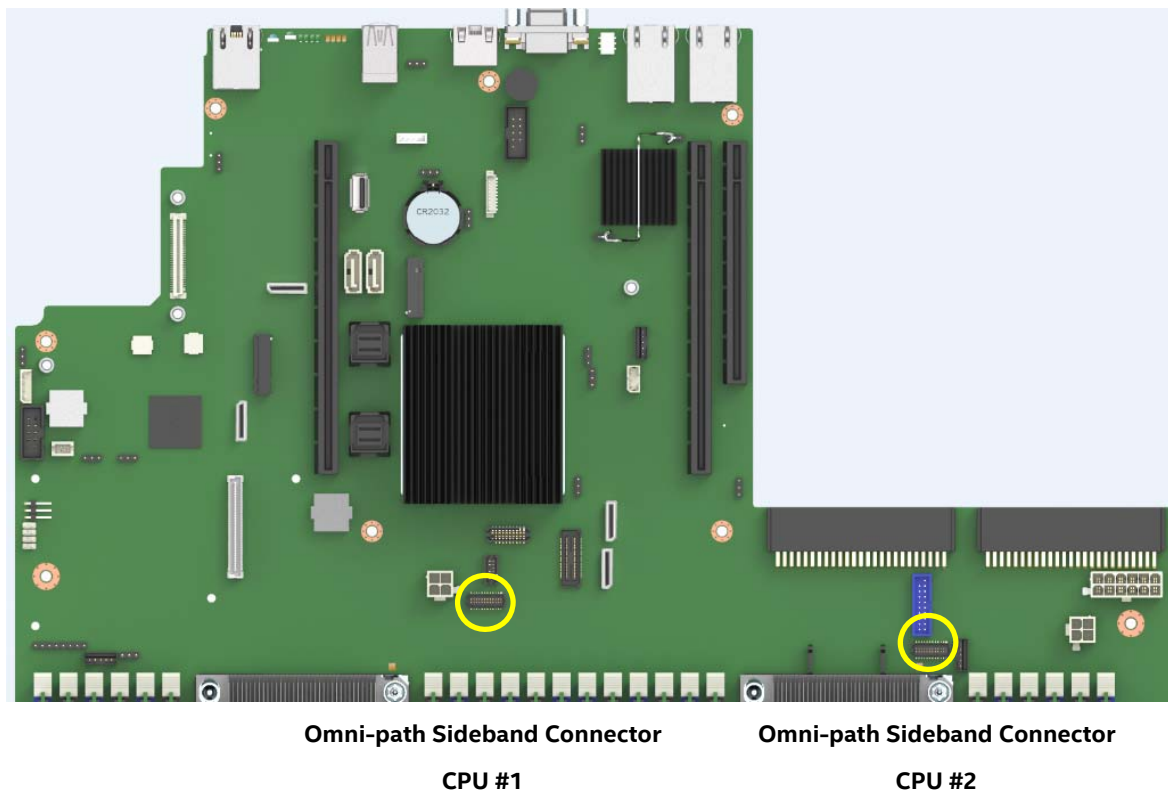


**Lock Cable**

**Figure 90. Fabric Processor Cable Installation**

10. Place the HFI cable processor connector within the connector rails on the processor socket and slide processor and cable connectors together (See Letter A)

11. Pull the bail wire back until the cable is securely locked in place (See Letter B)
12. Repeat Steps 8 thru 10 for the second internal HFI cable if present



**Figure 91. Onboard Omni-path Sideband Signal Connectors**

13. Connect the Omni-path sideband cable from the IFT Carrier card to the two sideband signal connectors on the server board at the locations shown above.

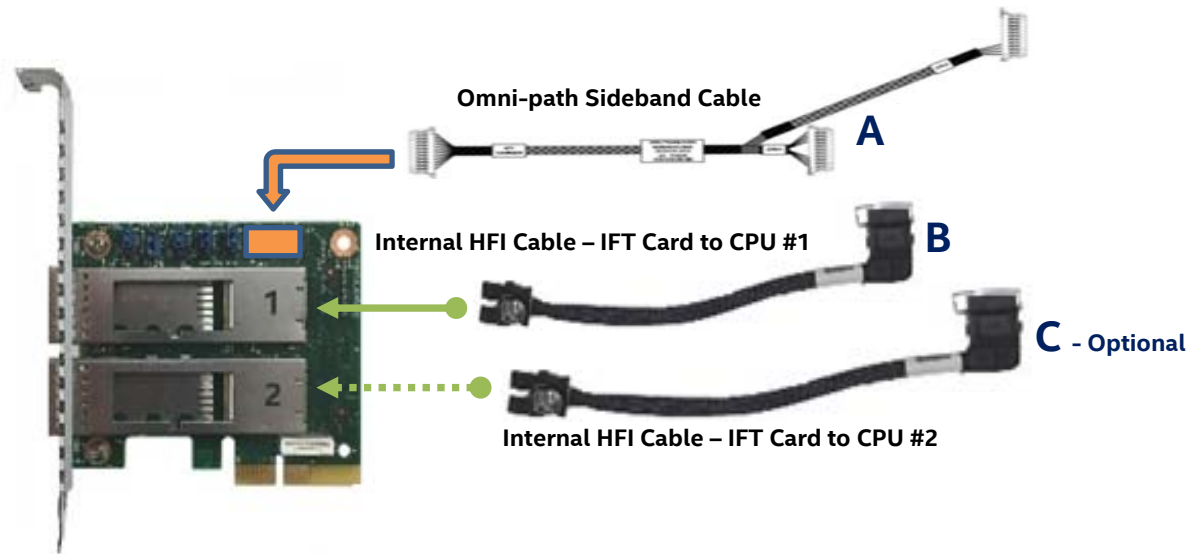
### **3.9.2 Intel® Omni-path IFT Carrier Kit (iPC AWF1PFABKITP) – Installation**

Kit Contents:

- 1 – Dual port IFT Carrier PCIe Add-in Card
- 1 – Internal Host Fabric Interface (HFI) Cable (CPU1)
- 1 – Internal Omni-Path Sideband Cable
- 2 – Fabric Processor Carrier Clips

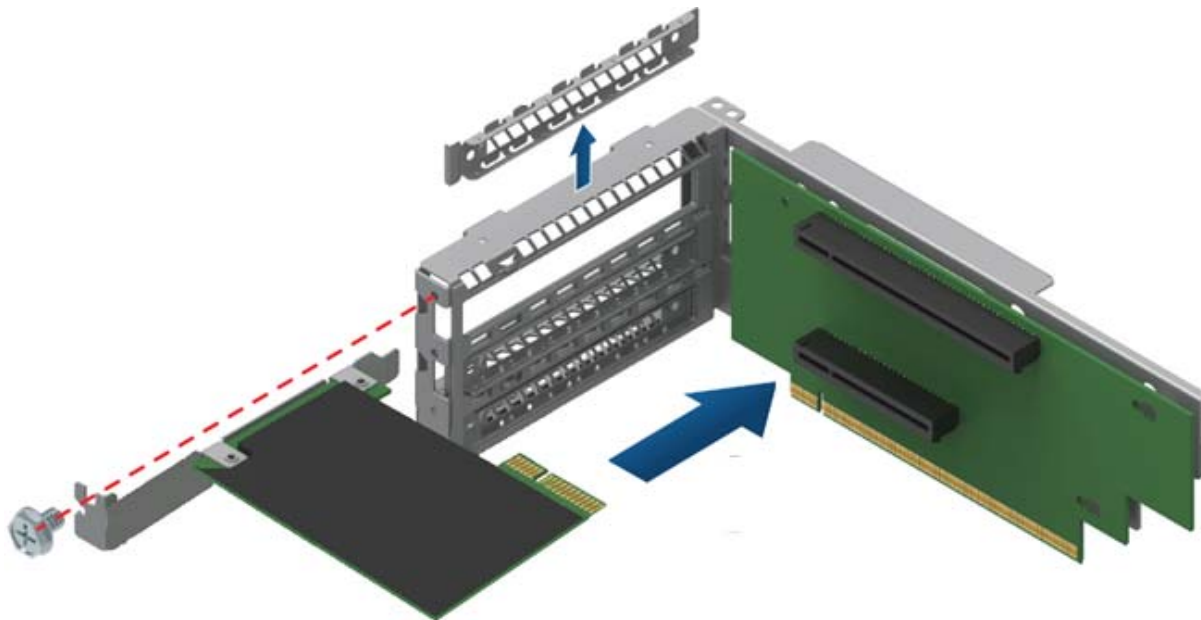
Intel Cable Kit **AXXCBL370IFPS1** required for dual fabric processor configurations.

1. Install Fabric processor(s) on to the server board. See Section 2.5 for fabric processor assembly and installation instructions.



**Figure 92. IFT Carrier Add-in Card Assembly**

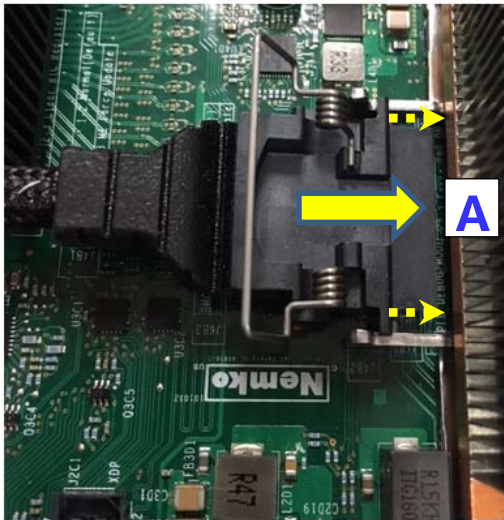
2. Connect the internal Omni-path sideband cable to the matching connector on the IFT Carrier card (See letter “A”)
3. Insert the internal HFI cable to Port 1 of the IFT Carrier mezzanine card until it locks into place (See letter “B”)
4. (Optional – For dual Fabric processor configurations) Insert the second internal HFI cable to Port 2 of the IFT Carrier card until it locks into place (See letter “C”)



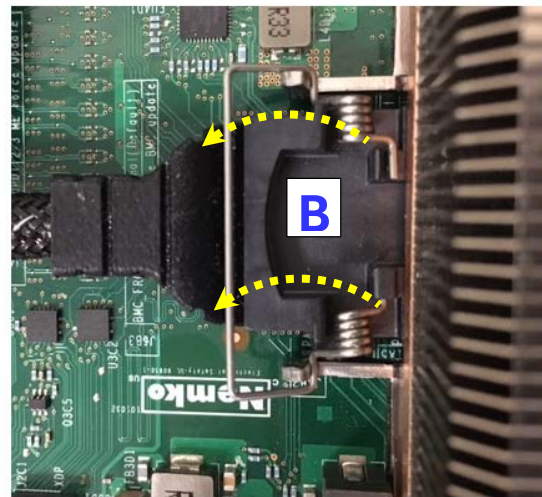
**Figure 93. IFT Carrier Add-in Card Installation**

5. Remove the desired riser bracket assembly from the system and install the IFT Carrier card to one of the add-in card slots on the riser card
6. Re-install the riser bracket in to the server – See section 2.9.3
7. Route the HFI cable attached to Port 1 of the IFT Carrier Card to CPU #1





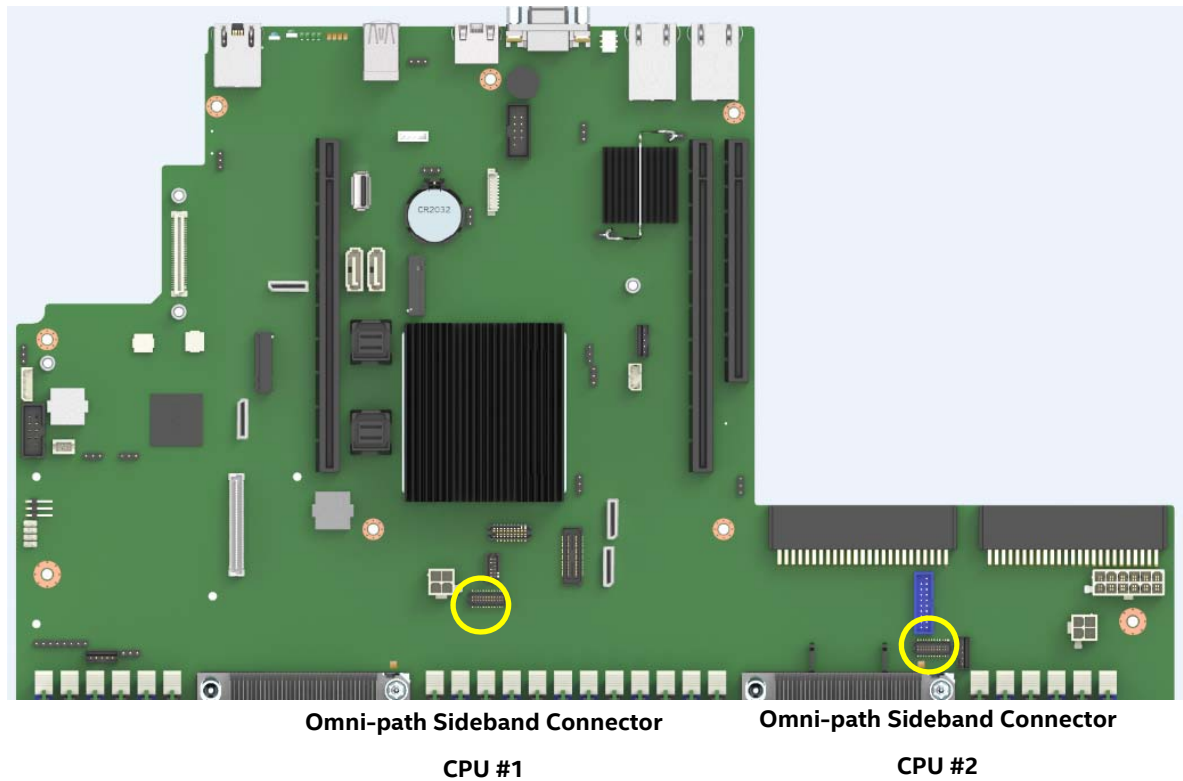
Place and Insert Cable



Lock Cable

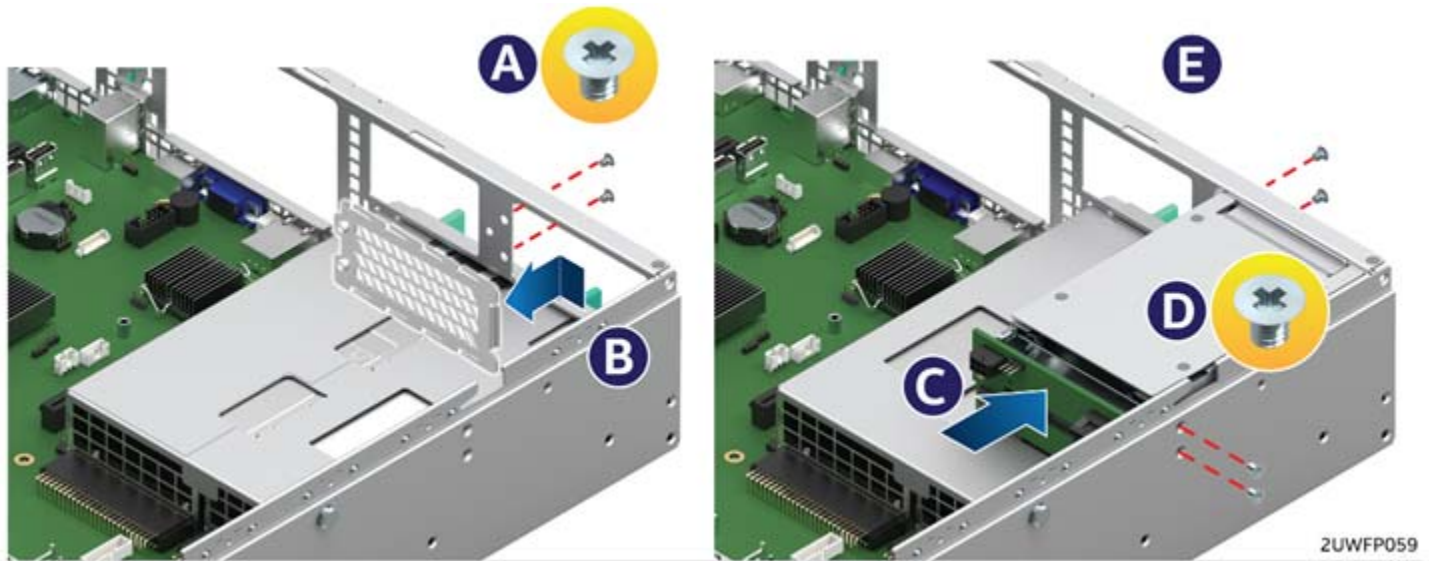
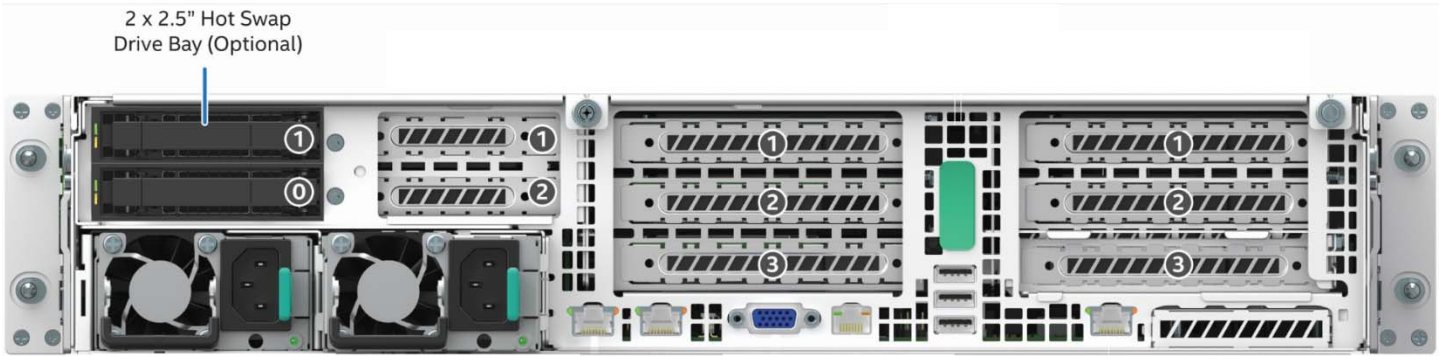
**Figure 94. Fabric Processor Cable Installation**

8. Place the HFI cable processor connector within the connector rails on the processor socket and slide processor and cable connectors together (See Letter A)
9. Pull the bail wire back until the cable is securely locked in place (See Letter B)
10. Repeat Steps 7 thru 9 for the second internal HFI cable if present



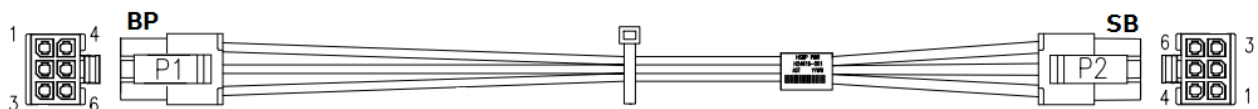
11. Connect the Omni-path sideband cable from the IFT Carrier card to the two sideband signal connectors on the server board at the locations shown above.

### 3.10 2 x 2.5" Rear Mount Backplane Module Accessory Kit (iPC- A2UREARHSDK1)



**Figure 95. 2 x 2.5" Rear Mount Backplane Module Installation**

1. Remove the two screws securing the bay cover plate to the chassis (see Letter 'A').
2. Unlatch and remove the bay cover plate from the chassis (see Letter 'B').
3. Carefully remove the backplane module from its packaging.
4. Position the drive bay module over the power supply bay and slide it back until it is flush with the back of the chassis back panel (see Letter 'C').
5. Secure the drive bay module to the chassis using four screws; two on the chassis sidewall, and two on the chassis back panel. (See Letter 'D').
6. From the backplane accessory kit, locate the following cables



**Figure 96. Rear HSBP Power Cable**



**Figure 97. Rear HSBP I2C Cable**





Figure 98. Rear HSBP SATA & SGPIO Cable Bundle

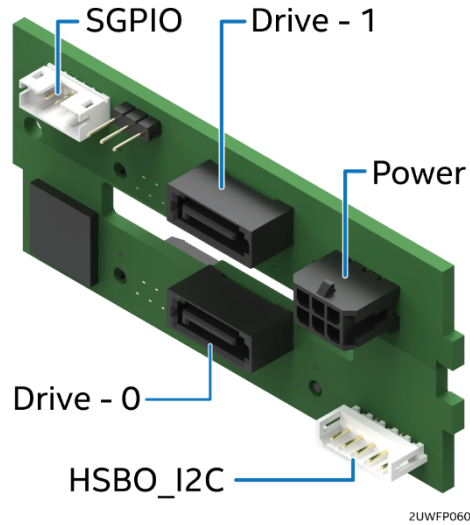
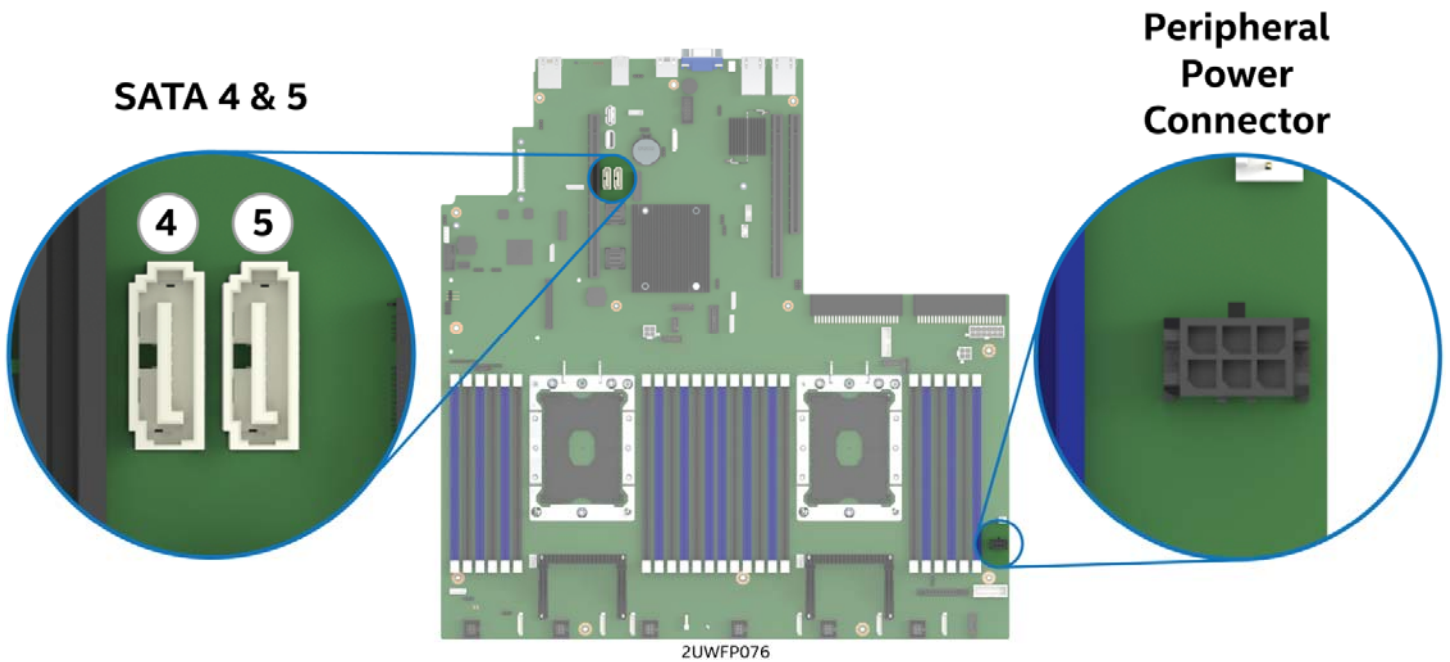
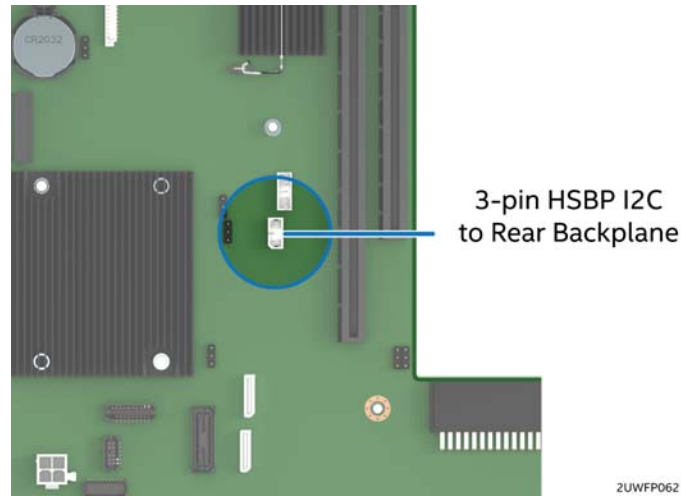


Figure 99. Rear Backplane Cable Connectors



7. Connect the 2x3 power cable connector (labeled “SB”) to the server board “Peripheral PWR” connector.
8. Connect the 2x3 power cable connector (labeled “BP”) to the backplane “PWR” connector.
9. Connect the 5-pin I<sup>2</sup>C cable connector to the matching “HSBP\_I2C” connector on the backplane.



10. Connect the 3-pin I<sup>2</sup>C cable connector to the matching “HSBP\_I2C” connector on the server board.



11. Match and connect the 7-pin SATA “Drive 0” and “Drive 1” cable connectors to the “Drive\_0” and “Drive\_1” connectors on the backplane.
12. Connect the 5-pin SATA SGPIO cable connector to the “SGPIO” connector on the backplane.
13. Match and connect the 7-pin “SATA 4” and “SATA 5” cable connectors to the “sSATA\_4” and “sSATA\_5” connectors on the server board.
14. Connect the 5-pin SATA SGPIO cable connector to the “SGPIO” connector on the server board.

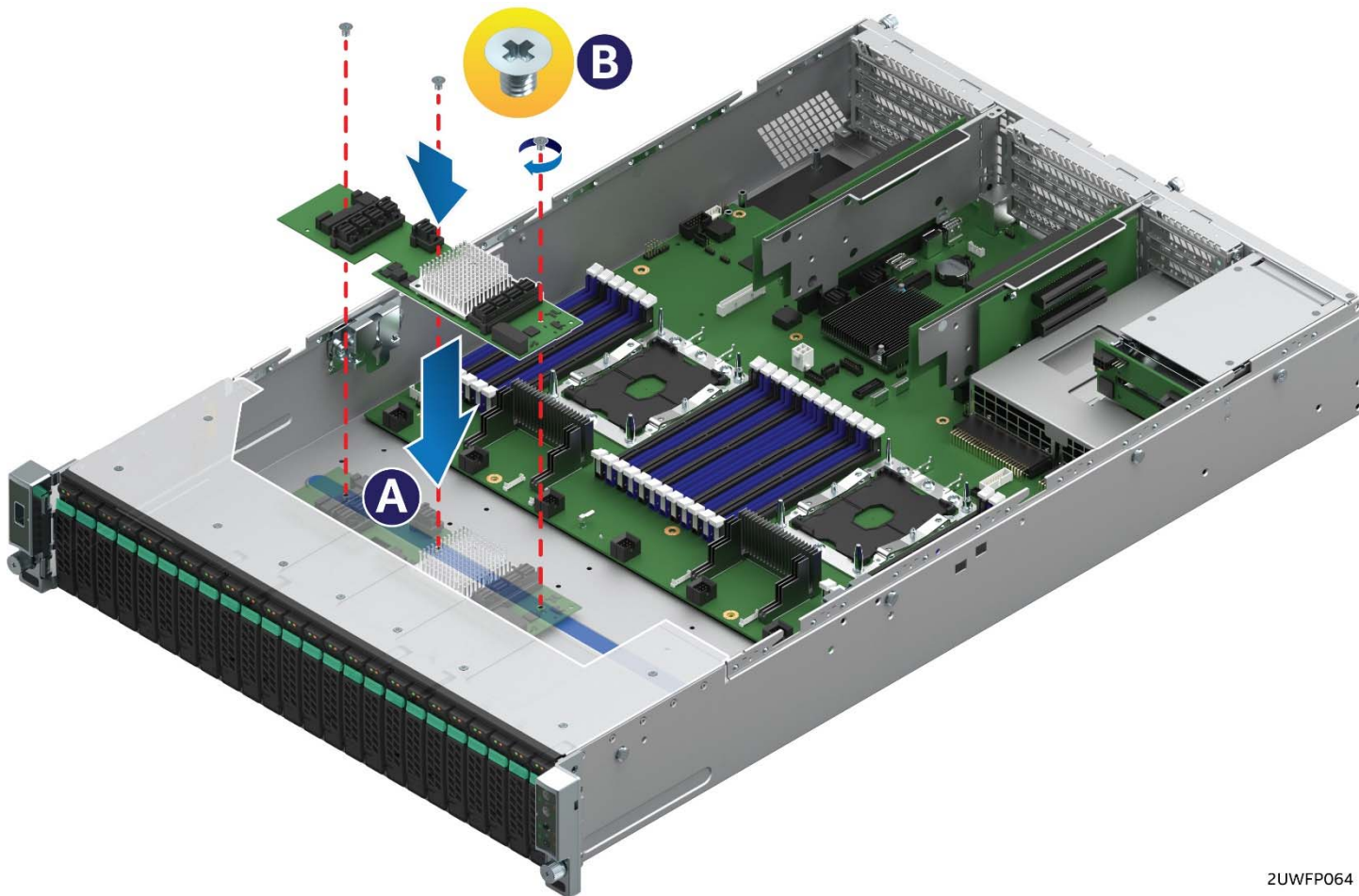
## 3.11 Intel® SAS Expander Card Installation

Depending on the front drive bay configuration, 2.5" or 3.5" drive support, and drive type (6Gb/s SAS/SATA or 12 Gb/s SAS), the 2U server system can support different Intel® SAS Expander card options.

### 3.11.1 2.5" Front Drive Bay Support

For Intel® Server Systems supporting 2.5" drive carriers, an Intel® SAS Expander Mezzanine Card option is mounted internally behind the front drive bays.

Intel product code: **RES3TV360** (12Gb)



ZUWFP064

**Figure 100. SAS Expander Mezzanine Card Installation**

1. Locate the Intel SAS RAID Expander Mezzanine Card.
2. Remove the system cover (see Section 2.2.1).
3. Remove the air duct (see Section 2.3.1).
4. Remove the system fan module (see Section 2.4.1).
5. Attach the rubber bumpers to the white circle targets on the bottom side of the RAID Expander card.
6. Align the three screw holes of the RAID Expander card with the matching threaded holes on the base of the chassis directly behind the front drive bays (see Letter 'A').
7. Secure the RAID Expander card to the chassis using three screws (8 in/lb torque for each screw)(see Letter 'B').
8. Locate and remove the power splitter cable from the RAID Expander kit.
9. Attach the power splitter cable to the power cable designated for use on the middle drive bay module.
10. Attach the 1x4-pin power connector from the splitter cable to the RAID Expander card.
11. Attach the 2x2-pin power connector from the splitter to the middle hot swap backplane.

### 3.11.2 3.5" Front Drive Bay Support

For the Intel® Server Systems supporting 3.5" drive carriers, an Intel® SAS Expander PCIe\* add-in card option installs into any available PCIe\* add-in card slot. See section 2.9

Intel product code - RES3FV288 (12Gb)

### 3.11.3 Intel® RAID Expander Card Cabling Overview

The following diagrams identify SAS Expander card connectors to be used when cabling the expander card to the system backplane(s) and to the add-in SAS RAID card. Care should be taken when connecting cables from the RAID expander card to the connectors on the backplane because each connector is pre-programmed at the factory to provide specific drive ID mapping. Improper connections may provide undesirable drive mappings.

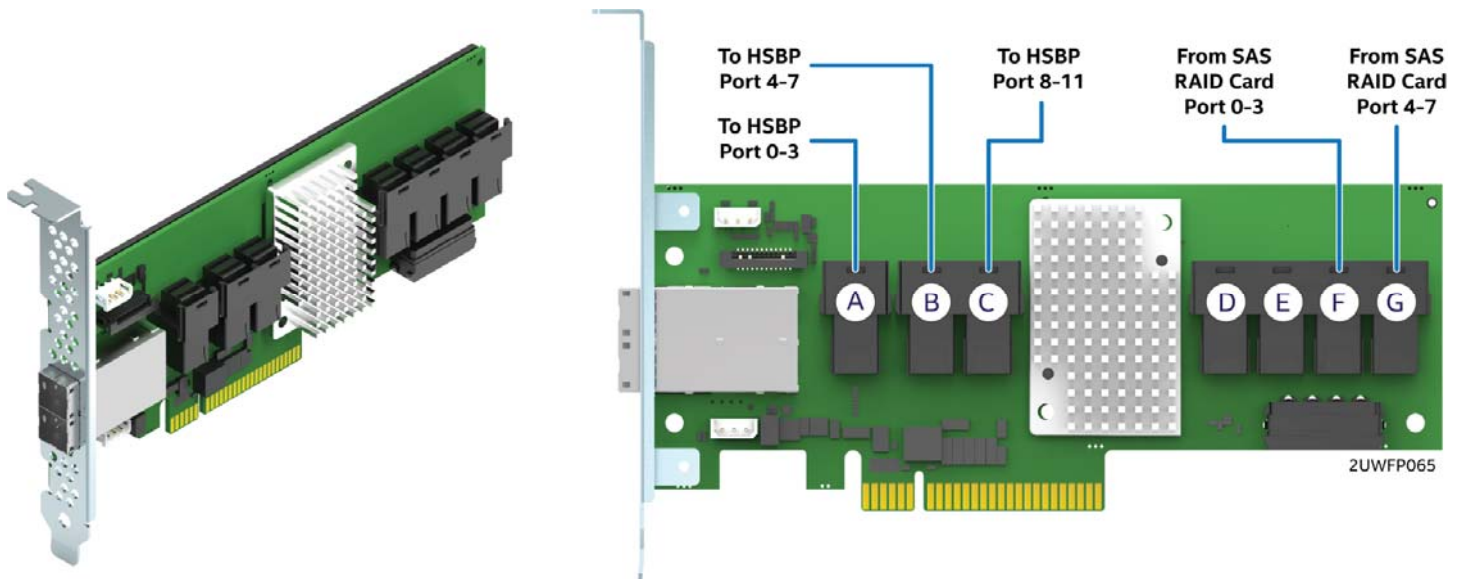


Figure 101. 12 Gb Intel® RAID Expander Card RES3FV288 Connector Identification

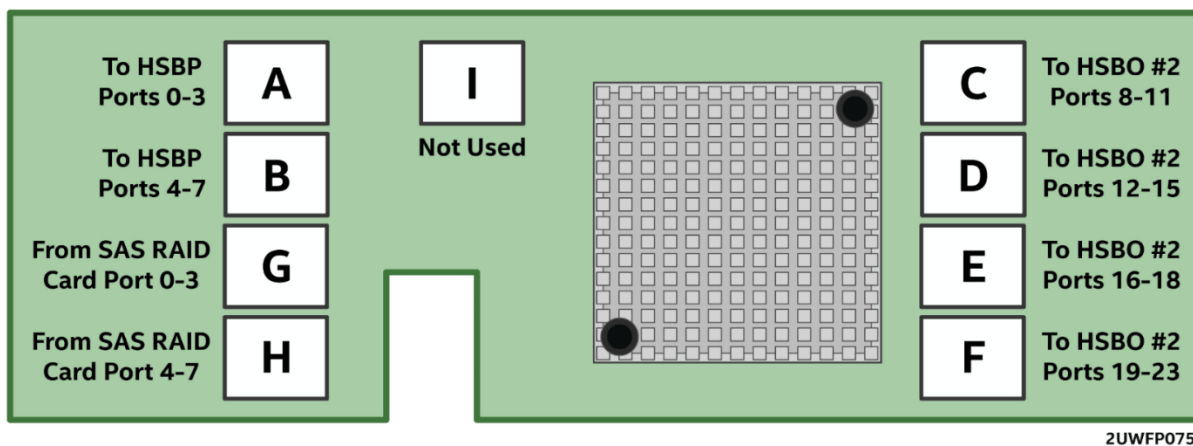
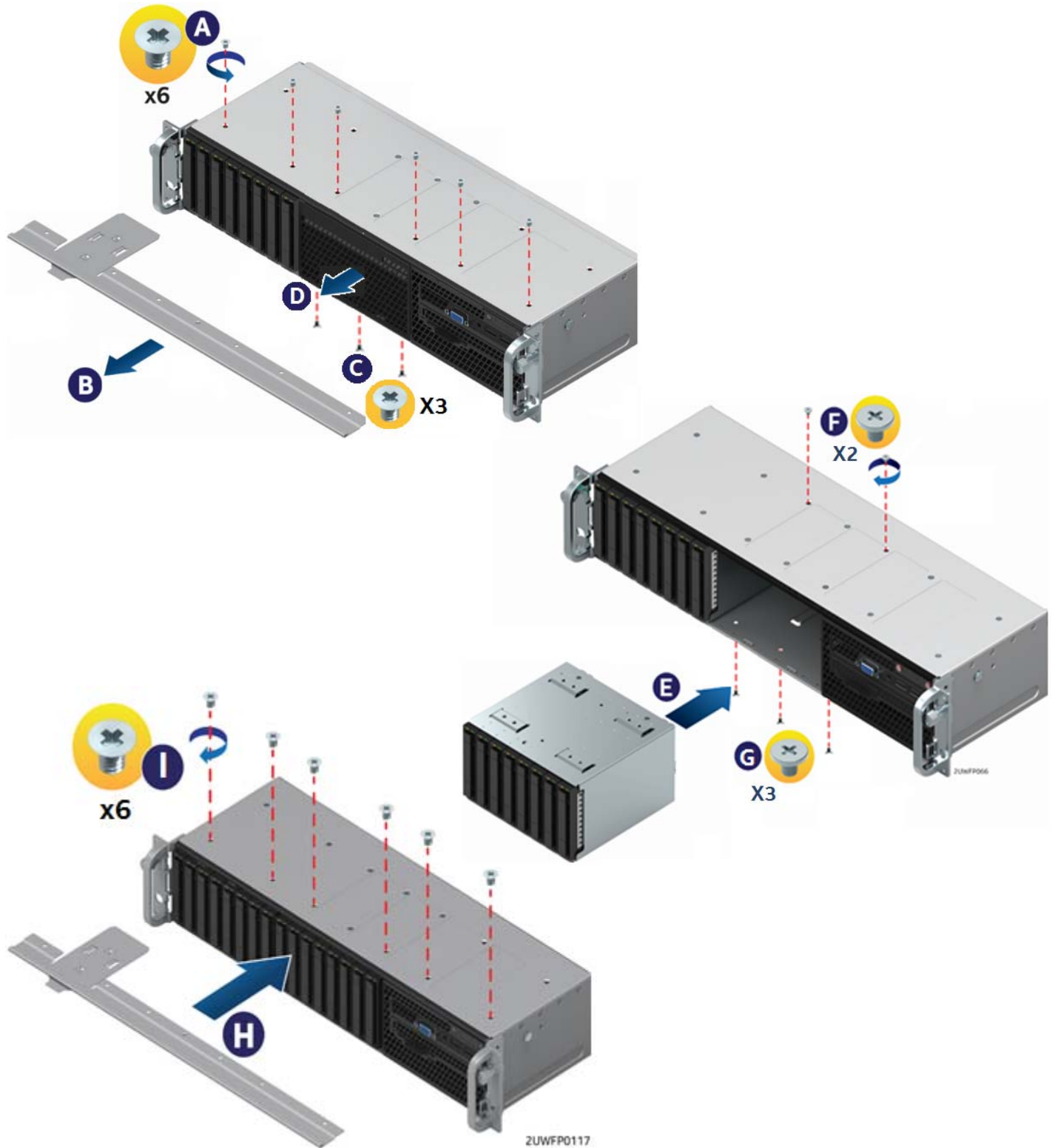


Figure 102. Internal 12 Gb Intel® RAID Expander Card RES3TV360 - Connector Identification Block Diagram



### 3.12 R2208WF Upgrade to 16 Drive Configuration

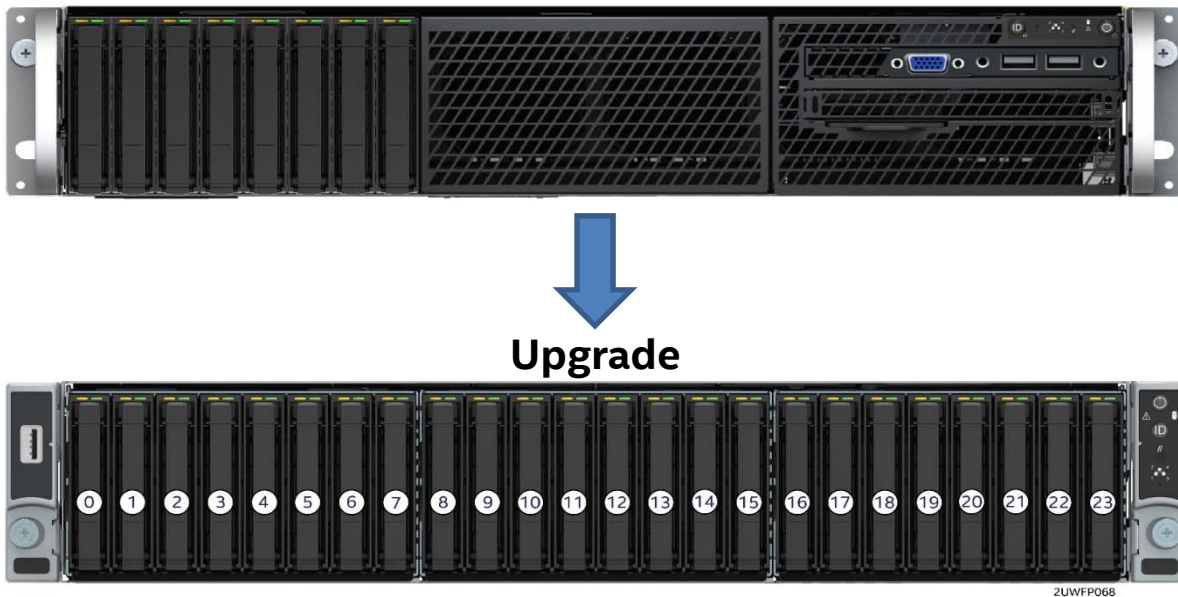
The 8 x 2.5" drive R2208WF server system can be upgraded to a 16 x 2.5" drive system with the addition of one 8 x 2.5" Front Drive Bay Module accessory kit option. Below is an installation overview. Refer to Section 1.3.1 for complete installation instructions.



Depending on the system configuration requirements, it may also be necessary to install an Intel® SAS expander card. See Section 3.11.1 for SAS Expander card installation instructions.

### 3.13 24 Drive Upgrade Option

The “no drive” server chassis building block SKU and any 2.5” drive server system can be configured to support 24 drives.



In order to support 24 2.5” drives, the system must have all the following Intel accessory kits installed:

- Three (3) 8 x 2.5” Front Drive Bay Module Accessory Kit options (several kits available)
- Storage Rack Handles from Rack Handle Spare / Accessory Kit (Intel product code **A2UHANDLKIT**)
- Appropriate SAS/SATA/NVMe Cables
- (Optional) Intel® SAS (12Gb) Expander Card (Intel product code **RES3TV360**)

---

Note: Reference the *Intel® Server S2600WF Product Family Configuration Guide* for a complete list of available accessory options

---

1. Remove the system cover (see Section 2.2.1).
2. Remove the air duct (see Section 2.3.1).
3. Remove the system fan module (see section 2.4.1).
4. Disconnect the front panel cables for the Front USB ports, Front Video port, and Front Control Panel from the server board (see Figure 12).
5. Disconnect all cables from the first (left most) drive bay module.
6. Remove the standard rack handles

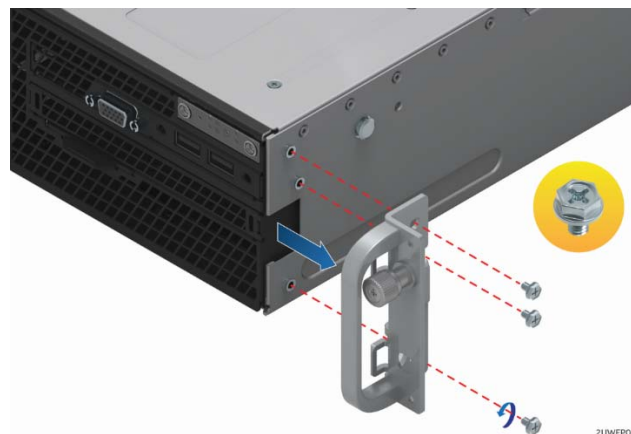


Figure 103. Standard Rack Handle Removal



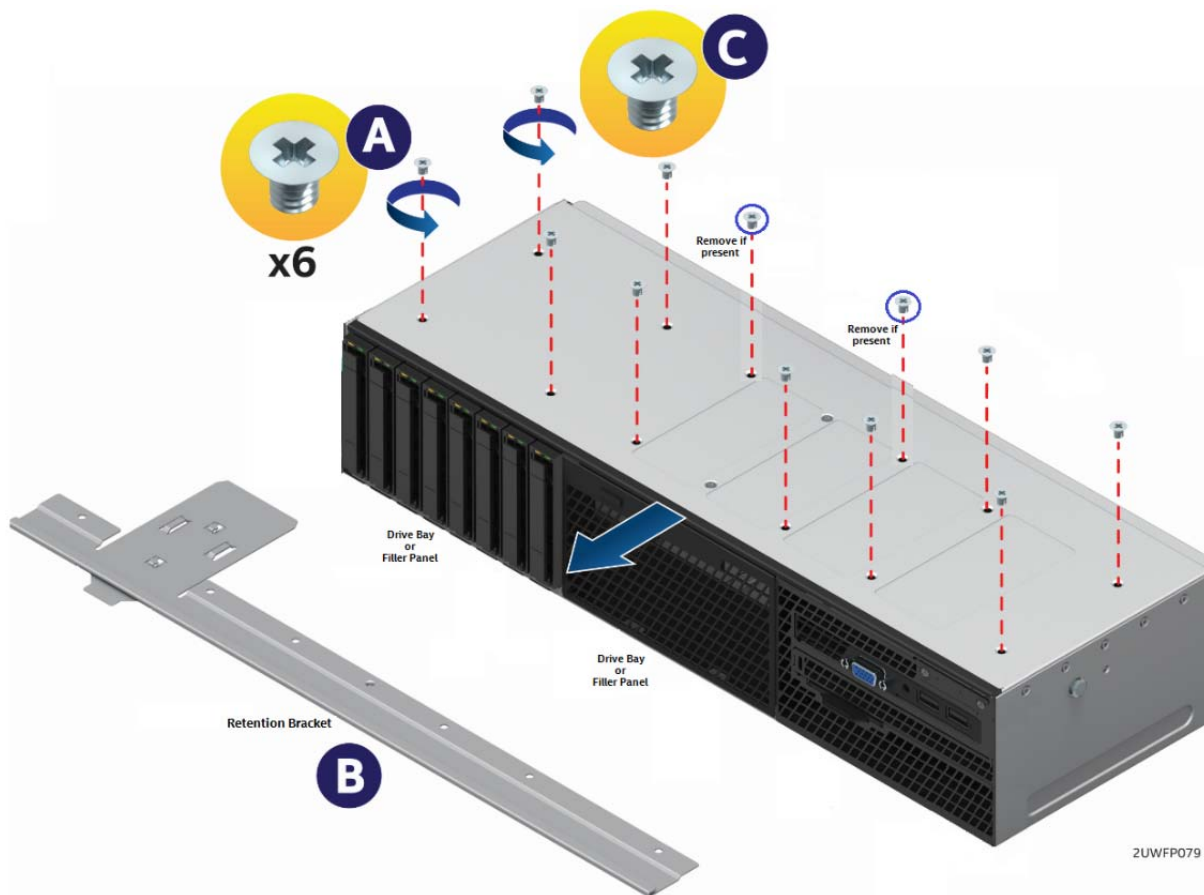
7. Remove the following from the chassis: drive bay retention bracket, drive bay modules (Storage and I/O) and/or drive bay inserts.



Drive Bay Storage Module

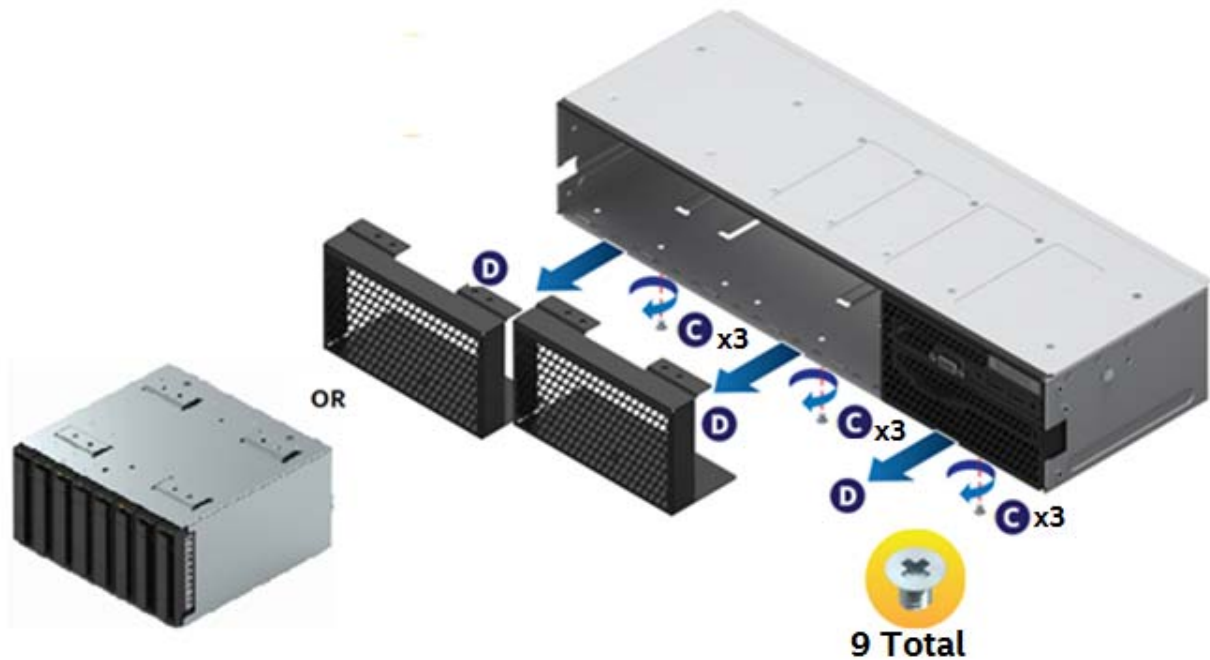
Drive Bay Insert

Drive Bay I/O Module



**Figure 104. Drive Bay Disassembly – Retention Bracket Removal**

- a) Remove the 6 screws from the top front edge of the drive bay (See Letter 'A') and pull out the metal retention bracket (see Letter 'B').
- b) Remove the top screws near the back edge of the drive bay from all installed drive bay modules (see Letter 'C').
- c) Carefully place the chassis on its side.

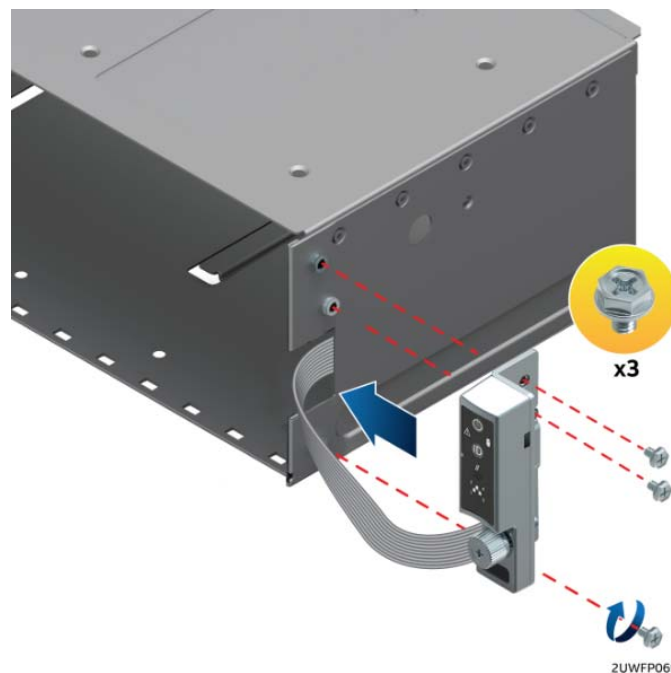


**Figure 105. Drive Bay Disassembly – Module Removal**

- d) From the bottom of the chassis, remove three (3) screws from each installed drive bay module or insert (see Letter 'C').
- e) Carefully return the chassis to its original position.
- f) Carefully slide out each drive bay module (Storage and I/O) and/or bay insert from the chassis (see Letter 'D')

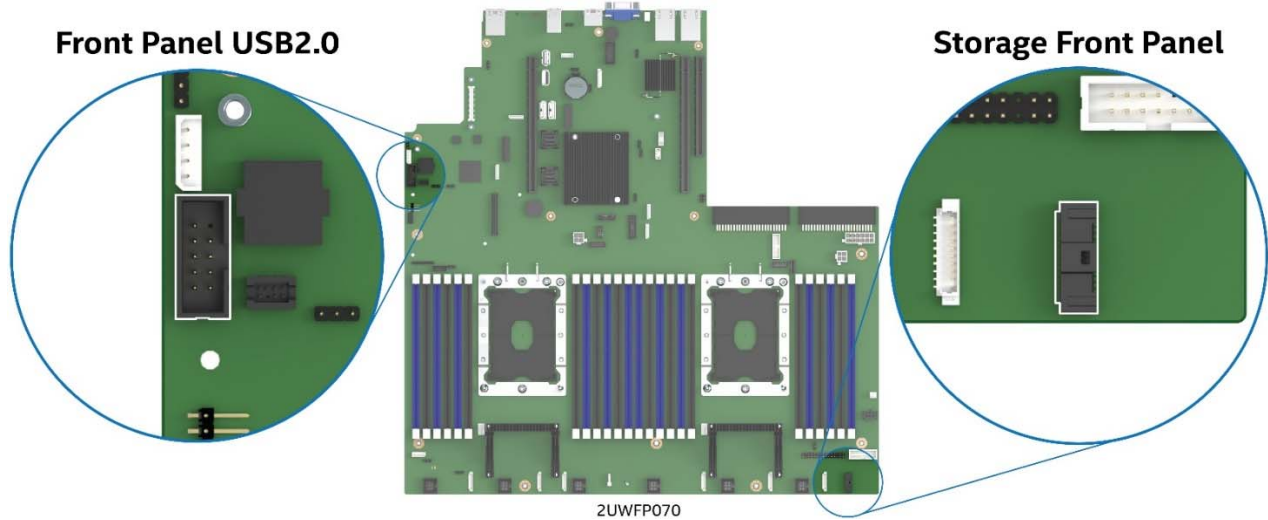
8. Install the Storage Rack Handles

**Note:** The Storage Rack Handles are ONLY intended to ease sliding of the system in and out of the rack when a rail kit is installed on the system. The rack handles are NOT designed to support the full weight of the system during installation/deinstallation or movement outside of the rack.



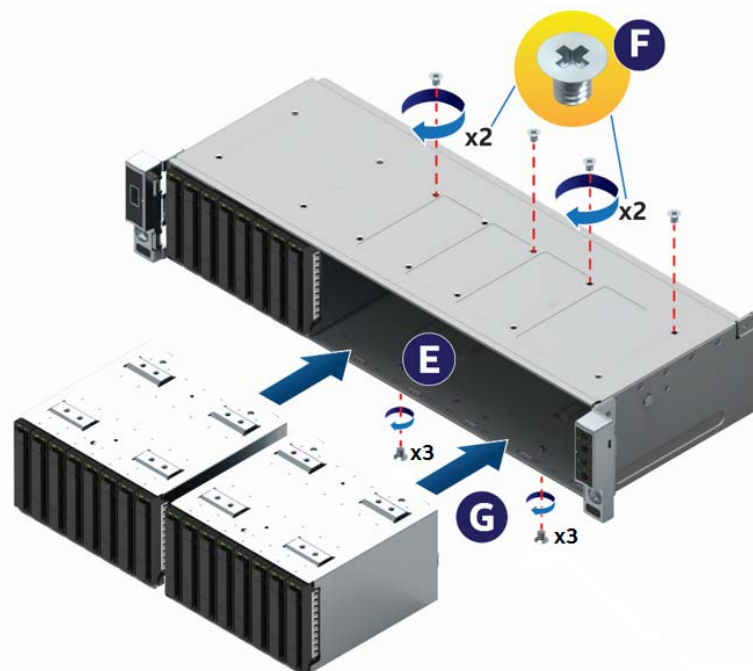
**Figure 106. Storage Rack Handle Installation**

- a) Locate and remove the Left (with USB port) and Right (with Control Panel) storage rack handle assemblies from Intel Accessory Kit **A2UHANDLKIT**.
- b) Lay each rack handle assembly near the left and right chassis corners, then route the ribbon cable from each along the inside of the chassis side wall towards the back of the drive bay.
- c) Attach the left and right rack handle assemblies to the chassis using three screws each (8 in/lb torque for each screw). Note that the ribbon cables should fit inside cutouts in the chassis sidewall.



**Figure 107. Server Board USB 2.0 Header**

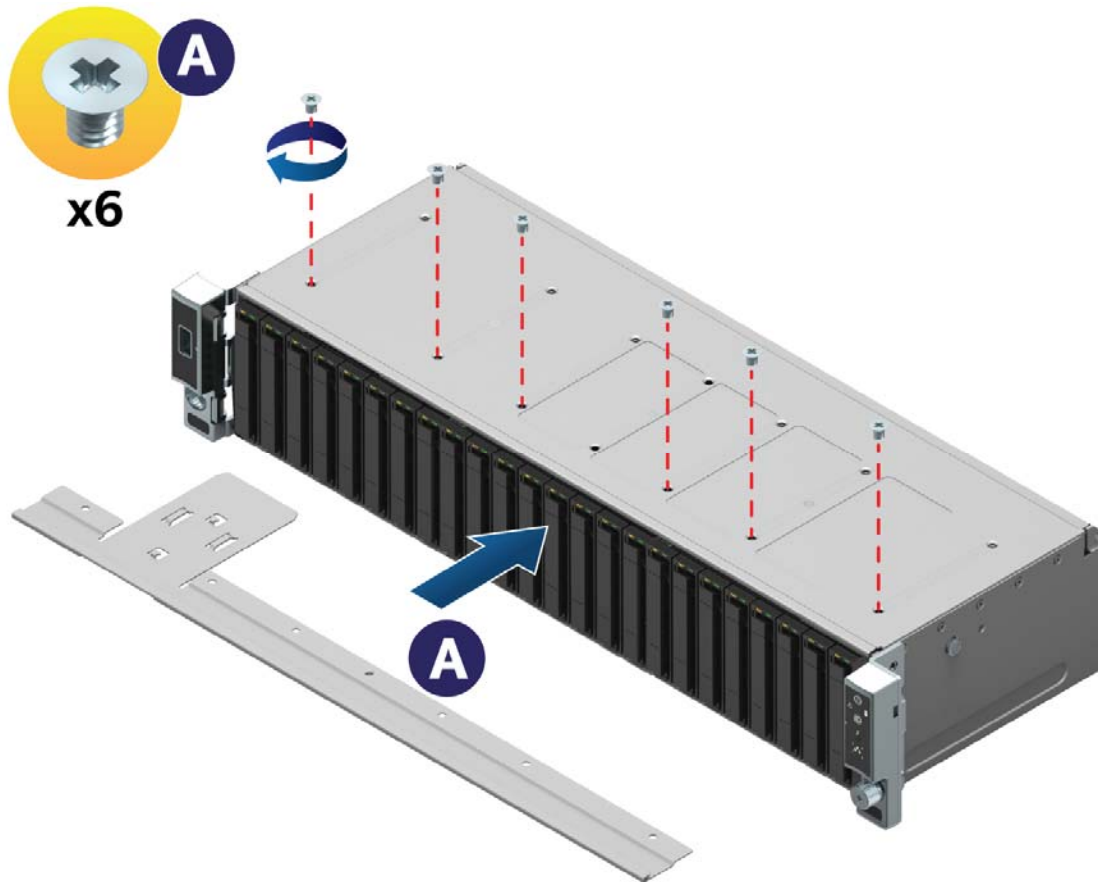
- d) Attach the Left USB flat cable to the black 10-pin server board connector labeled “FP\_USB”.
  - e) Attach the Right front panel ribbon cable to the high density 30-pin connector labeled “Storage\_FP” on the front right corner of the server board.
  - f) Ensure that the ribbon cables are routed within the cable channel inside each chassis sidewall, then secure them in place using the included adhesive tape strips.  
Note: Failing to secure each ribbon cable to the chassis sidewall may cause cable damage
9. Install the 8 x 2.5” Drive Bay Module(s)



**Figure 108. Installing the 8 x 2.5” Drive Bay Module(s)**

- a) Slide all 8x2.5" drive bay module(s) into the chassis (see Letter 'E').
- b) Secure the top side of each drive bay module with two fastener screws each (see letter 'F') (8 in/lb torque for each screw).
- c) Carefully place the chassis on its side and secure the bottom side of each drive bay module with three (3) screws each (see Letter 'G') (8 in/lb torque for each screw).
- d) Carefully return the chassis to its original position.

#### 10. Install Drive Bay Retention Bracket



2UWFP081

**Figure 109. Installing Drive Bay Retention Bracket**

- a) Locate the drive bay retention bracket and screws.
- b) Carefully slide the drive bay retention bracket into the gap between the top of the drive bay module(s) and the bottom of the drive bay sheet metal. (See Letter 'A').
- c) Secure the retention bracket with six fastener screws (see Letter 'B'). (8 in/lb torque for each screw).
- d) Connect a power cable to each of the hot swap backplanes.
- e) (Optional) Install add-in RAID Card option(s)
- f) (Optional) Install SAS Expander module option – See Section 3.11.1
- g) (Optional) Install SAS RAID RMFBU option(s)
- h) Route and attach appropriate SAS/SATA/NVMe data cables between data I/O sources (SAS RAID, Tri-Mode, onboard OCuLink, PCIe Switch) and backplanes

**Note:** If installing a RAID expander card, do NOT attach the power cable to the middle hot swap backplane. This will be attached at a later time.

## 4. System Software Updates and Configuration

---

### 4.1 Updating the System Software Stack

The system includes a software stack to operate including a BIOS, BMC firmware, ME firmware, and FRU & SDR data. A default software stack is loaded during the system manufacturing process. However, it may not be the latest available. For best operation and system reliability, it is highly recommended to update the system software stack to the latest available.

The latest system software stack can be downloaded from Intel at the following Intel web site:

<http://downloadcenter.intel.com>

At a minimum, after the initial configuration, the system's FRU and SDR data **MUST** be updated to ensure that the embedded platform management sub-system is configured properly. The system's FRU and SDR data is updated by running the FRUSDR utility. Properly loaded FRU and SDR data allows platform management to monitor the appropriate system sensors which are used to determine proper system cooling, best performance, and accurate error reporting. The FRUSDR utility is included in the platform's System Update Package (SUP) which can be downloaded from the Intel web site referenced above. The SUP will include full system update instructions.

### 4.2 Using the BIOS Setup Utility

This section describes how to access and navigate the embedded <F2> BIOS Setup utility. This utility can be used to view and configure system settings that determine how the server operates.

#### 4.2.1 Entering BIOS Setup

To enter the BIOS Setup using a keyboard (or emulated keyboard), press the <F2> function key during boot when the OEM or Intel Logo Screen or the POST Diagnostic Screen is displayed.

---

**Note:** At initial system power on, a USB Keyboard will not be functional until the USB Controller has been initialized during the power on self test (POST) process. When the USB controller is initialized, the system will beep once. Only after that time will the key strokes from a USB Keyboard be recognized allowing for access into the <F2> BIOS Setup utility.

---

The following message will be displayed on the Diagnostic Screen or under the Quiet Boot Logo Screen:

**Press <F2> to enter setup, <F6> Boot Menu, <F12> Network Boot**

After pressing the <F2> key, the system will eventually load the BIOS Setup Utility and display the BIOS Setup Main Menu screen.

---

**Note:** Should serious system errors occur during the POST process, the regular system boot will stop and the system will load the BIOS Setup Utility and display the Error Manager Screen. The Error Manager Screen will list and provide information about the specific boot errors detected

---

#### 4.2.2 No Access to the BIOS Setup Utility

If the BIOS Setup Utility is not accessible by hitting the <F2> key or other described access methods, it may be necessary to restore the BIOS default settings. For information relating to restoring BIOS defaults, see Section 6.2.1 BIOS Default Jumper Block.

### 4.2.3 Navigating the BIOS Setup Utility

The BIOS Setup Utility consists of several menu screens, each holding either informational fields and/or configurable system setup options.

The bottom right portion of each menu screen provides a list of commands that are used to navigate through the Setup utility. These commands are displayed at all times.

If no Administrator or User password is used, all available settings are configurable and can be set by anyone with access to BIOS Setup.

System settings that are not configurable, because of security settings or configuration limits, will be grayed out and are not accessible.

**Table 3. BIOS Setup: Keyboard Command Bar**

Key	Option	Description
<Enter>	<ul style="list-style-type: none"> <li>Execute Command</li> </ul>	<ul style="list-style-type: none"> <li>The &lt;Enter&gt; key is used to activate submenus when the selected feature is a submenu, or to display a pick list if a selected option has a value field, or to select a subfield for multi-valued features like time and date. If a pick list is displayed, the &lt;Enter&gt; key selects the currently highlighted item, undoes the pick list, and returns the focus to the parent menu.</li> </ul>
<Esc>	<ul style="list-style-type: none"> <li>Exit</li> </ul>	<ul style="list-style-type: none"> <li>The &lt;Esc&gt; key provides a mechanism for backing out of any field. When the &lt;Esc&gt; key is pressed while editing any field or selecting features of a menu, the parent menu is re-entered. When the &lt;Esc&gt; key is pressed in any submenu, the parent menu is re-entered. When the &lt;Esc&gt; key is pressed in any major menu, the exit confirmation window is displayed and the user is asked whether changes can be discarded. If "No" is selected and the &lt;Enter&gt; key is pressed, or if the &lt;Esc&gt; key is pressed, the user is returned to where they were before &lt;Esc&gt; was pressed, without affecting any existing settings. If "Yes" is selected and the &lt;Enter&gt; key is pressed, the setup is exited and the BIOS returns to the main System Options Menu screen.</li> </ul>
↑	<ul style="list-style-type: none"> <li>Select Item</li> </ul>	<ul style="list-style-type: none"> <li>The up arrow is used to select the previous value in a pick list, or the previous option in a menu item's option list. The selected item must then be activated by pressing the &lt;Enter&gt; key.</li> </ul>
↓	<ul style="list-style-type: none"> <li>Select Item</li> </ul>	<ul style="list-style-type: none"> <li>The down arrow is used to select the next value in a menu item's option list, or a value field's pick list. The selected item must then be activated by pressing the &lt;Enter&gt; key.</li> </ul>
← →	<ul style="list-style-type: none"> <li>Select Menu</li> </ul>	<ul style="list-style-type: none"> <li>The left and right arrow keys are used to move between the major menu pages. The keys have no effect if a sub-menu or pick list is displayed.</li> </ul>
<Tab>	<ul style="list-style-type: none"> <li>Select Field</li> </ul>	<ul style="list-style-type: none"> <li>The &lt;Tab&gt; key is used to move between fields. For example, &lt;Tab&gt; can be used to move from hours to minutes in the time item in the main menu.</li> </ul>
-	<ul style="list-style-type: none"> <li>Change Value</li> </ul>	<ul style="list-style-type: none"> <li>The minus key on the keypad is used to change the value of the current item to the previous value. This key scrolls through the values in the associated pick list without displaying the full list.</li> </ul>



Key	Option	Description
+	<ul style="list-style-type: none"> <li>▪ Change Value</li> </ul>	<ul style="list-style-type: none"> <li>▪ The plus key on the keypad is used to change the value of the current menu item to the next value. This key scrolls through the values in the associated pick list without displaying the full list. On 106-key Japanese keyboards, the plus key has a different scan code than the plus key on the other keyboards, but will have the same effect.</li> </ul>
<F9>	<ul style="list-style-type: none"> <li>▪ Setup Defaults</li> </ul>	<ul style="list-style-type: none"> <li>▪ Pressing the &lt;F9&gt; key causes the following to display:                             <div data-bbox="695 457 1422 556" style="border: 1px solid black; padding: 5px; margin: 10px 0;">                                 Load Optimized Defaults?                                  Yes No                             </div> <p>If "Yes" is highlighted and &lt;Enter&gt; is pressed, all Setup fields are set to their default values. If "No" is highlighted and &lt;Enter&gt; is pressed, or if the &lt;Esc&gt; key is pressed, the user is returned to where they were before &lt;F9&gt; was pressed without affecting any existing field values.</p> </li> </ul>
<F10>	<ul style="list-style-type: none"> <li>▪ Save and Exit</li> </ul>	<ul style="list-style-type: none"> <li>▪ Pressing the &lt;F10&gt; key causes the following message to display:                             <div data-bbox="695 905 1422 1003" style="border: 1px solid black; padding: 5px; margin: 10px 0;">                                 Save configuration and reset?                                  Yes No                             </div> <p>If "Yes" is highlighted and &lt;Enter&gt; is pressed, all changes are saved and the Setup is exited. If "No" is highlighted and &lt;Enter&gt; is pressed, or the &lt;Esc&gt; key is pressed, the user is returned to where they were before &lt;F10&gt; was pressed without affecting any existing values.</p> </li> </ul>

## 5. System Packaging Assembly Instructions

---

The original Intel packaging in which the server system was delivered, is designed to provide protection to a fully configured system and was tested to meet ISTA (International Safe Transit Association) Test Procedure 3A (2008). The packaging was also designed to be re-used for shipment after system integration has been completed.

The original packaging includes two layers of boxes – an inner box and the outer shipping box, and various protective inner packaging components. The boxes and packaging components are designed to function together as a protective packaging system. When reused, all of the original packaging material must be used, including both boxes and each inner packaging component. In addition, all inner packaging components **MUST** be reinstalled in the proper location to ensure adequate protection of the system for subsequent shipment.

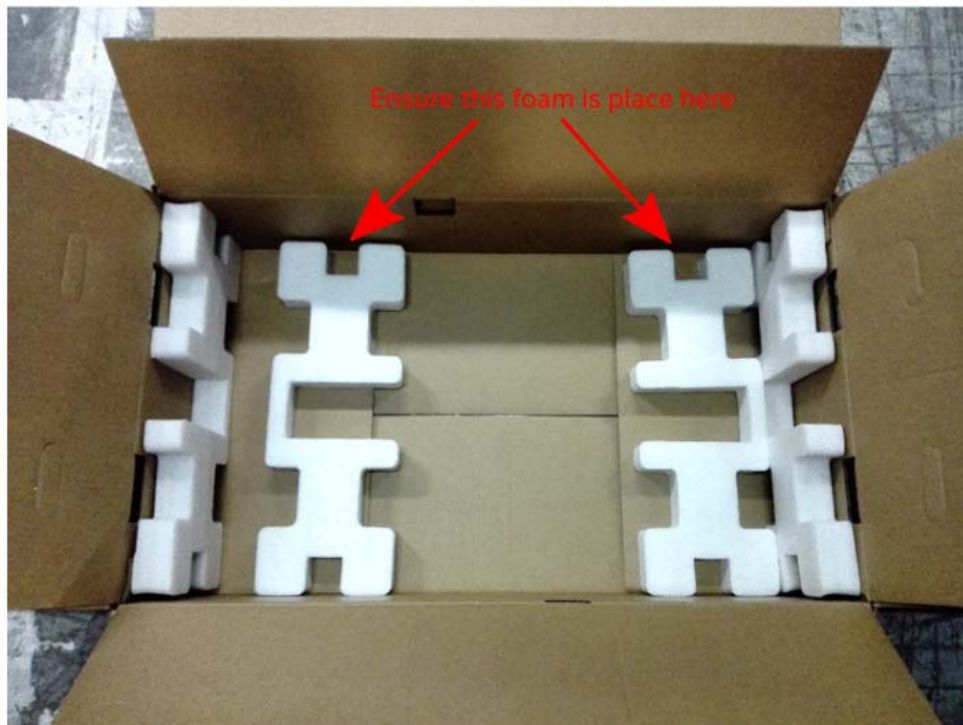
---

**Note:** The design of the inner packaging components does not prevent improper placement within the packaging assembly. There is only one correct packaging assembly that will allow the package to meet the ISTA (International Safe Transit Association) Test Procedure 3A (2008) limits.

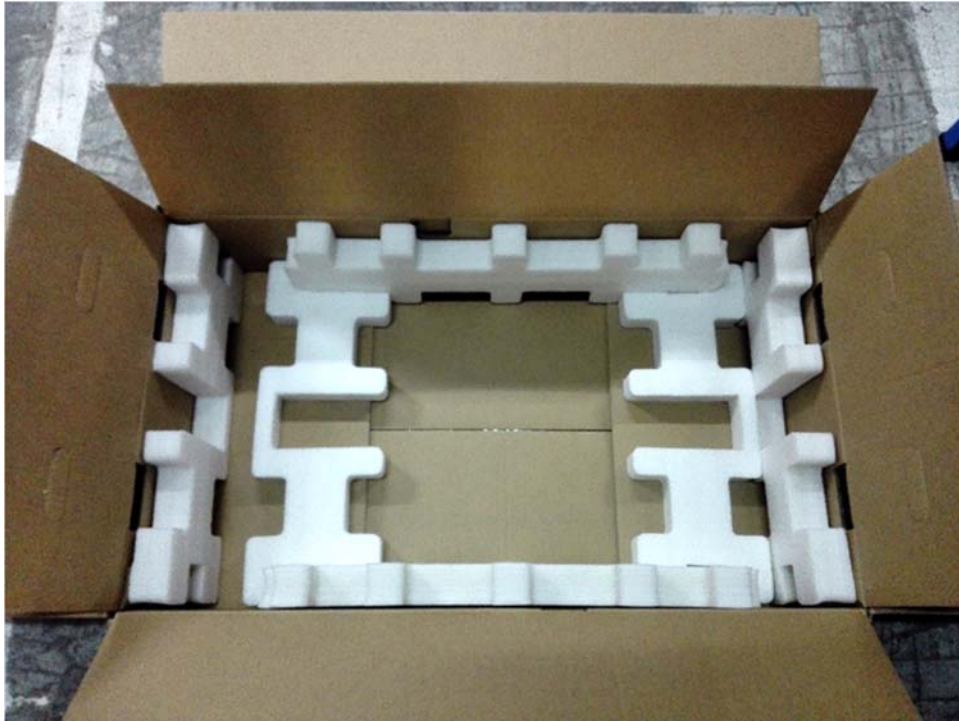
Failure to follow the specified packaging assembly instructions may result in damage to the system during shipment.

---

1. Place four foam inserts into the inner box as shown. Note foam insert orientation.
2. Place the Accessory Kit box between the end foam insert and the end wall of the inner box as shown.



3. Place the two pieces of side wall foam as shown.



4. Place three corrugated double wall cardboard pads onto the two bottom foam inserts as shown.



5. Carefully place the system into the shipping bag and tape the bag shut.
6. Carefully lower the system into the inner shipping box as shown.



7. Place the accessory box next to the foam located in the back of the box.
8. Place foam in front of the accessory box.





- At the front of the system, between the front foam insert and system front panel, place the foam marked J36266-001.



- Place two remaining foam inserts on top of the cardboard panels in the positions shown.



11. Fold the top flaps of the inner box closed, end flaps first, followed by side flaps.
  - a. By design, the two side flaps will not meet. Do not tape side flaps shut.



12. Fold the top flaps of the outer box closed, end flaps first, followed by the side flaps.
13. Tape the outer box using an H-pattern. Across the center first, followed by both ends.





## 6. System Service- System Features Overview

The intent of this chapter is to provide service personnel a reference to identify and locate the features associated with the Intel® Server System R2000WF product family.

Additional information for this product family can be obtained from the following Intel documents which can be downloaded from the following Intel web site:

<http://www.intel.com/support>

- Intel® Server System R2000WF Technical Product Specification
- Intel® Server Board S2600WF Technical Product Specification

### 6.1 System Feature Reference Diagrams

This section provides a high level overview of the Intel® Server System R2000WF product family. It provides illustrations and diagrams showing the location of important components, features, and connections found throughout the server system.

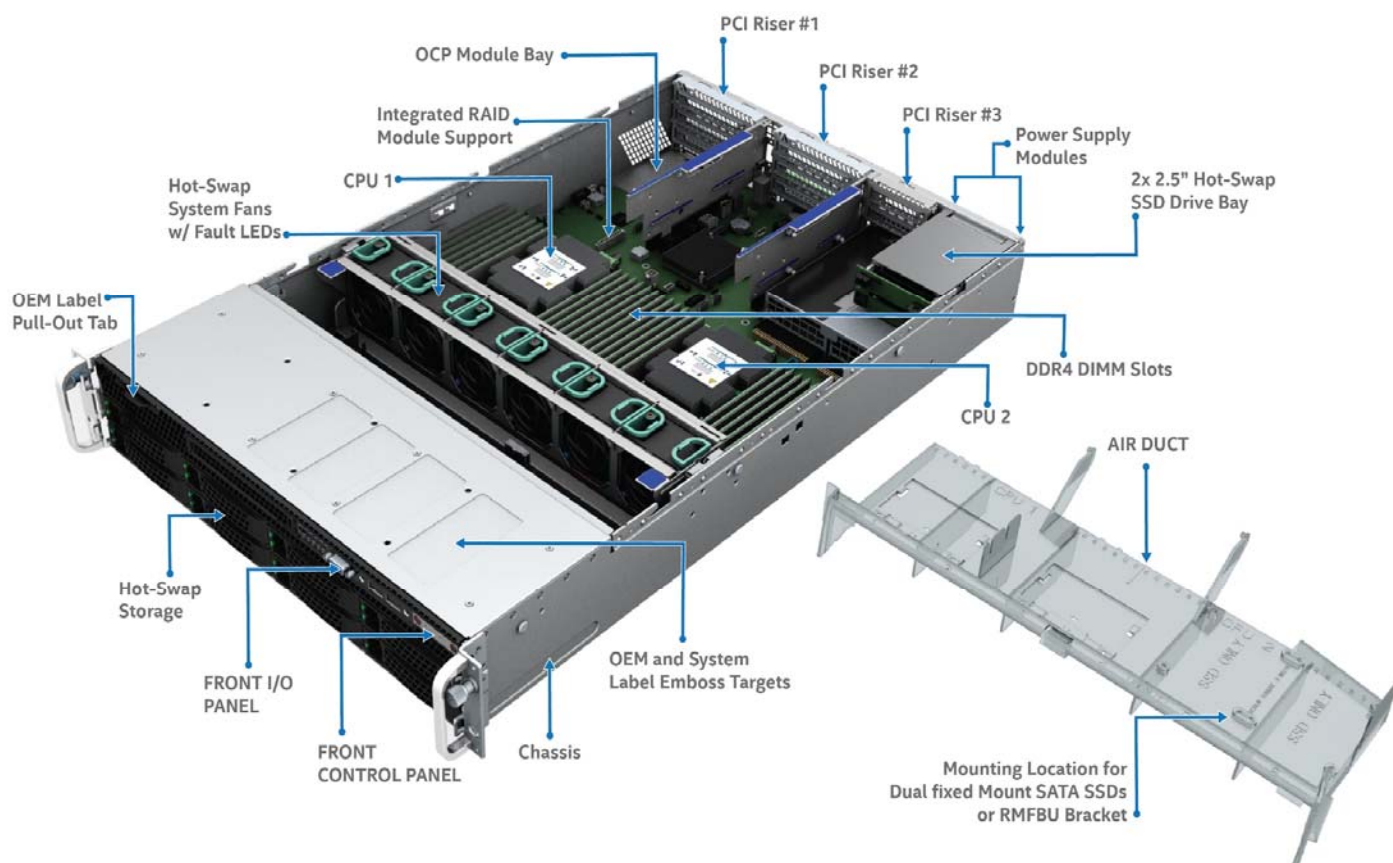


Figure 110. Intel® Server System R2000WF Features Overview

### 6.1.1 Front Drive Bay Options



Figure 111. No Drives – Chassis only building block (Intel® Server Chassis R2000WFXMLX)



WFP045

Figure 112. 8 x 3.5" Drive Bay Configuration (Intel® Server System R2308WF...)



WFP046

Figure 113. 12 x 3.5" Drive Bay Configuration (Intel® Server System R2312WF... – Storage System)

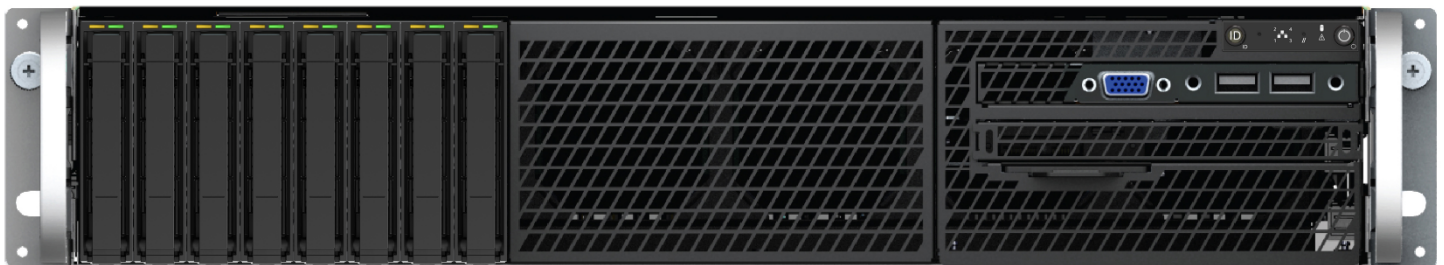


Figure 114. 8 x 2.5" Drive Bay Configuration (Intel® Server System R2208WF...)

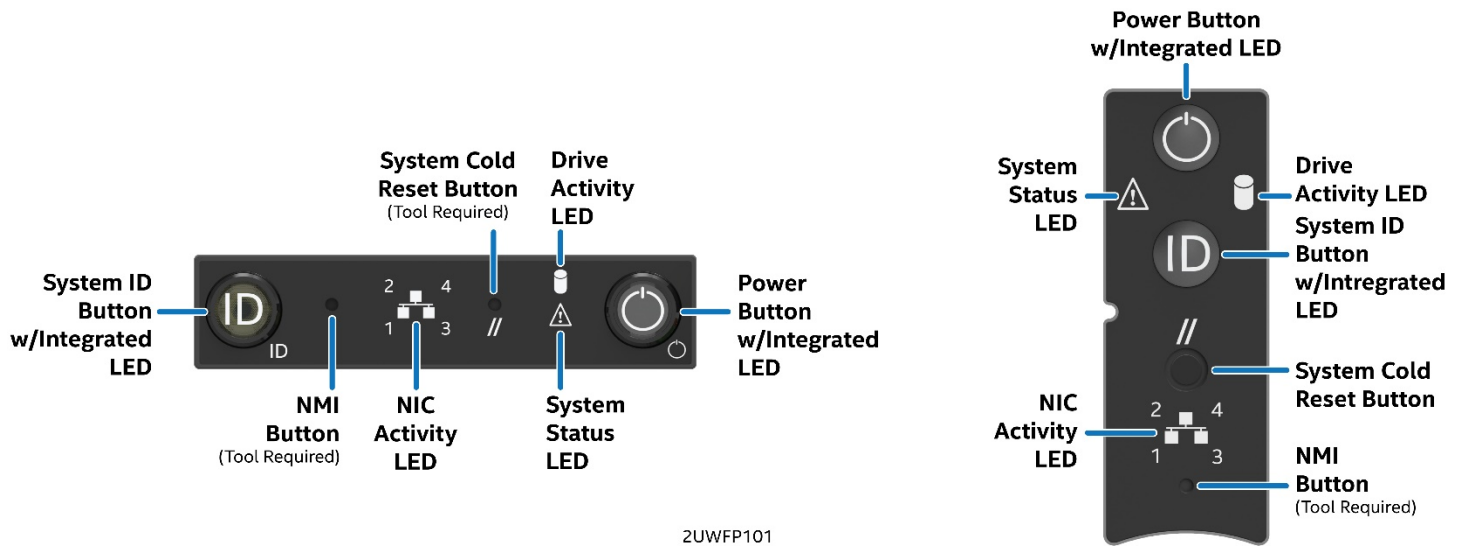


Figure 115. 16 x 2.5" Drive Bay Configuration (Intel® Server System R2208WF.... + 8x2.5" drive option)



Figure 116. 24 x 2.5" Drive Bay Configuration (Intel® Server System R2224WF.... – Storage System)

### 6.1.2 Control Panel Features



2UWFP101

Figure 117. Control Panel Features

### 6.1.3 Front I/O Features (Non-Storage Systems)

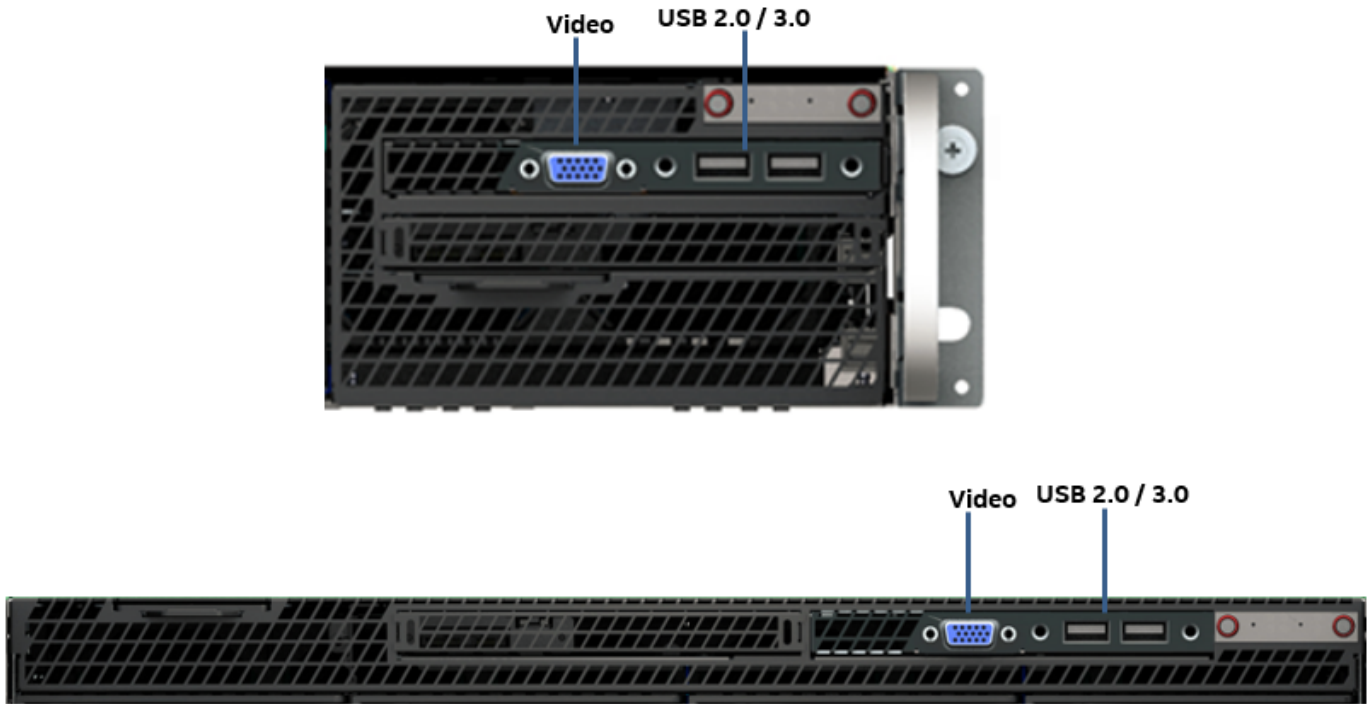


Figure 118. Front I/O Panel Features

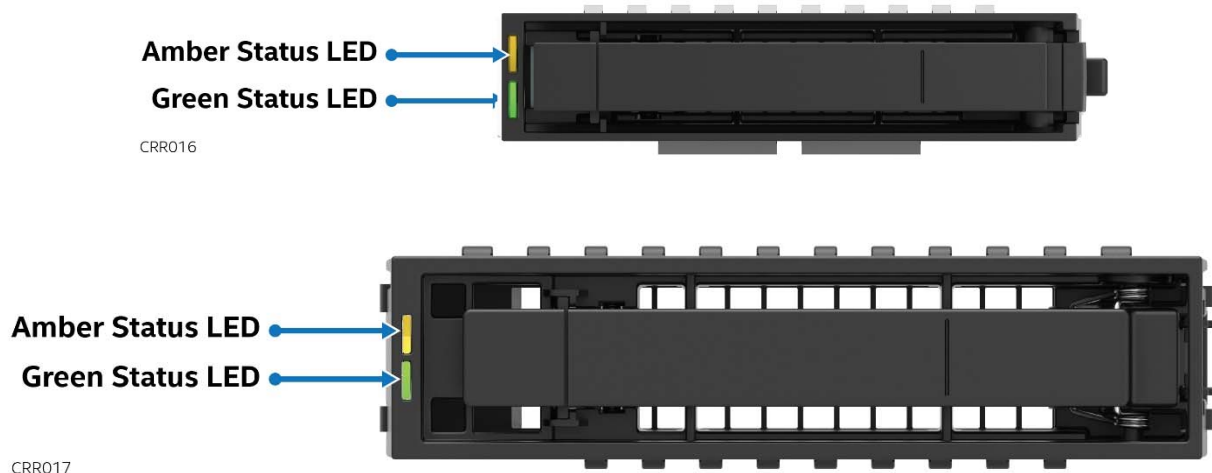


Figure 119. Hot Swap Drive Carrier LED Identification



### 6.1.4 Back Panel Features

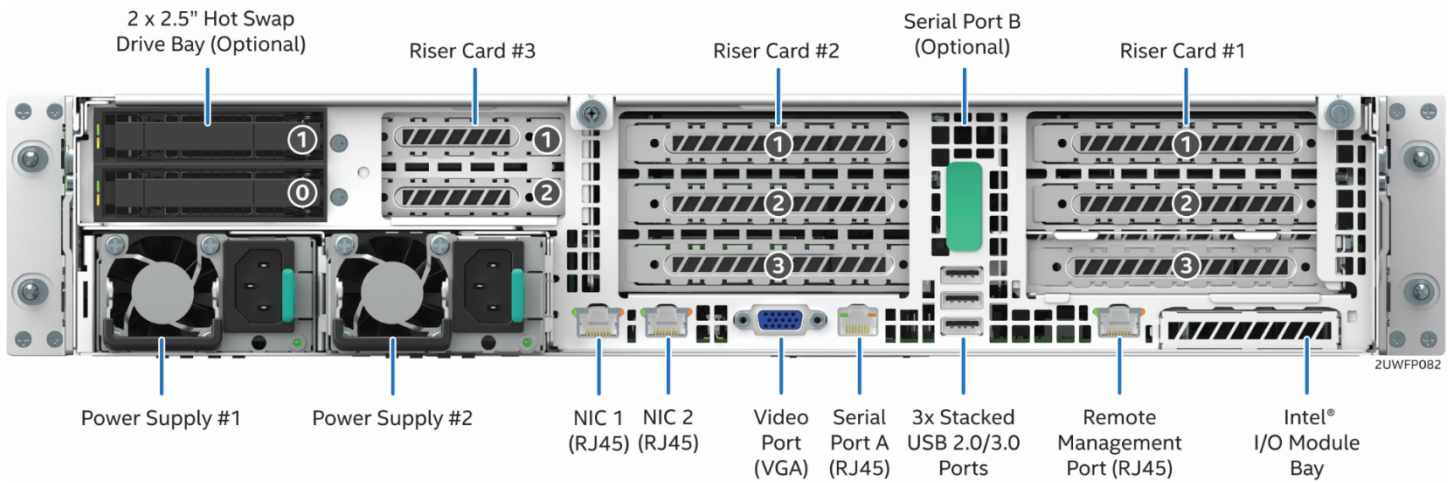


Figure 120. Back Panel Features

### 6.1.5 Server Board Features

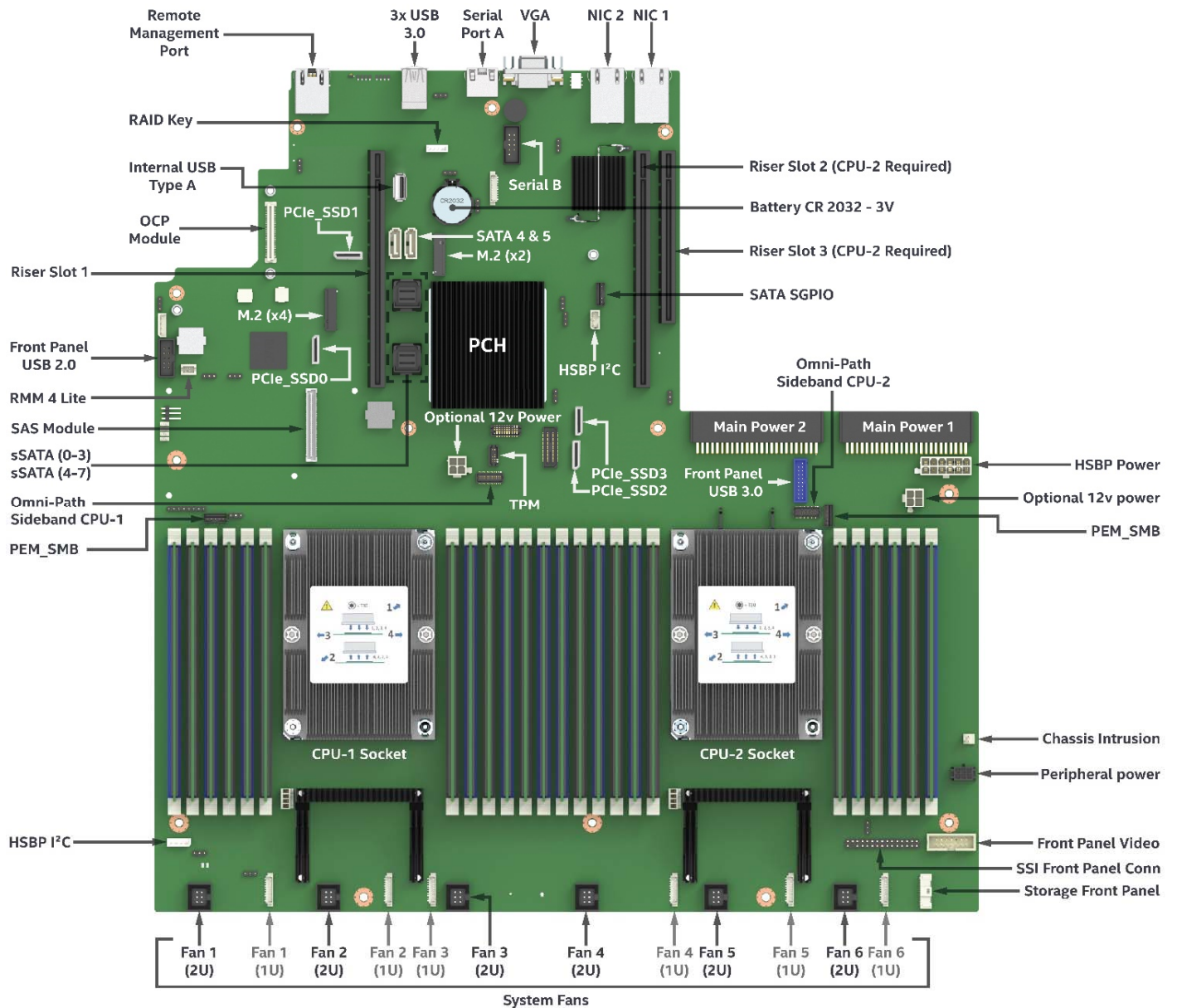


Figure 121. Server Board Feature Identification

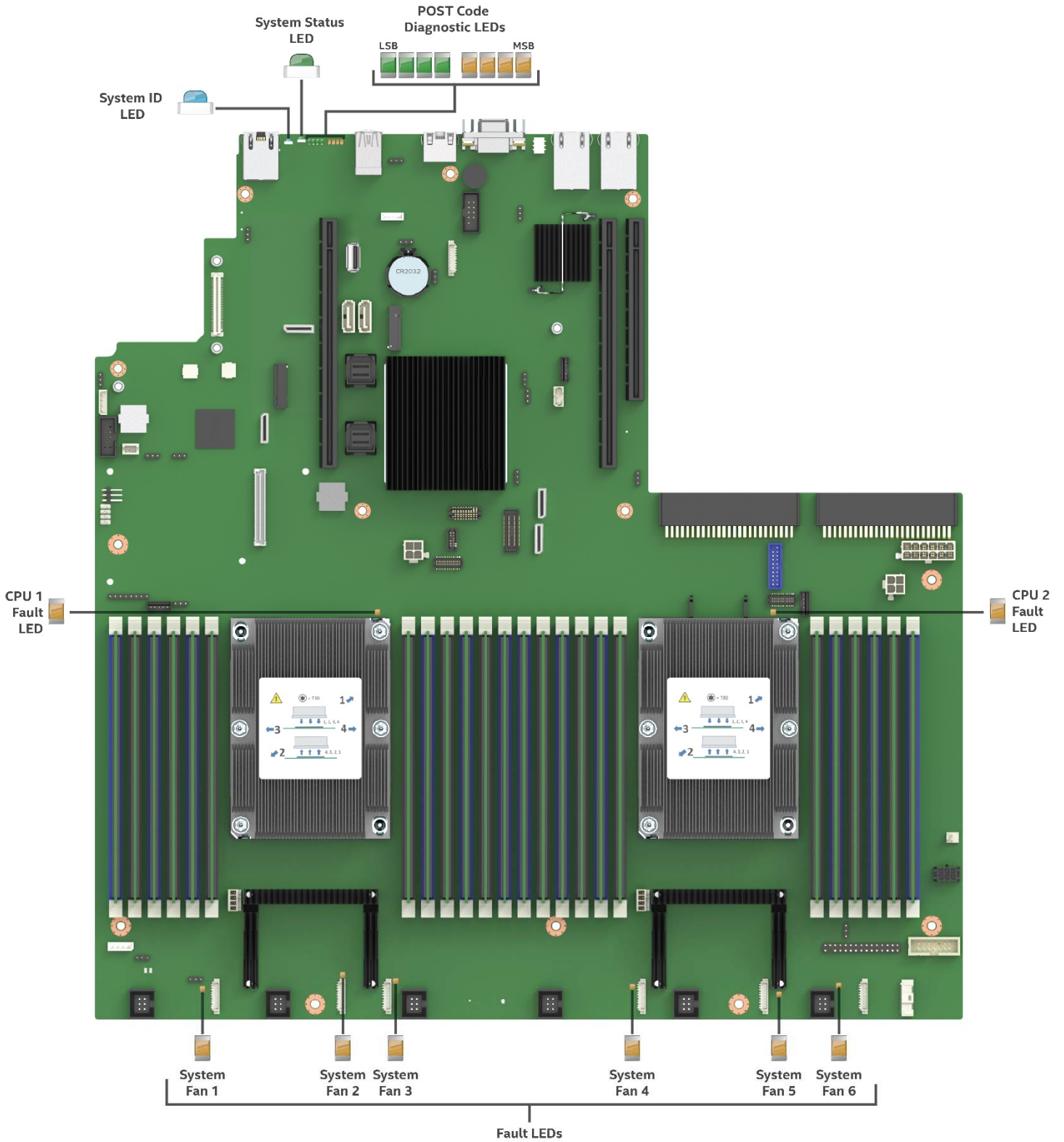


Figure 122. Intel® Light-Guided Diagnostic LEDs - Server Board



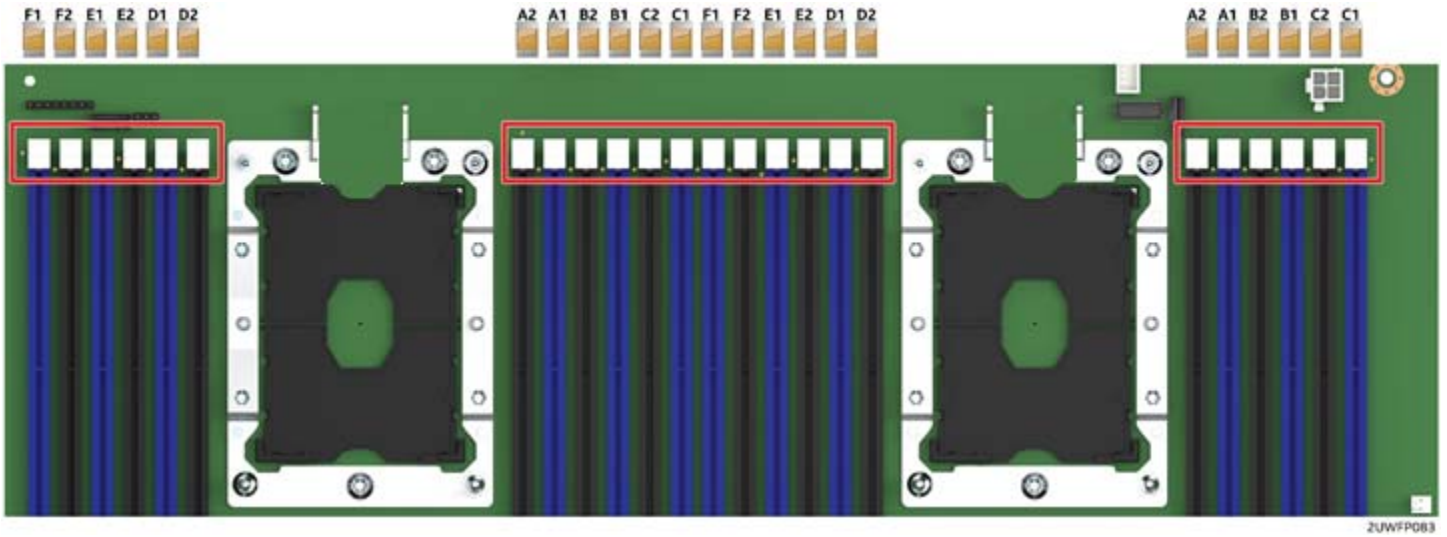


Figure 123. DIMM Fault LEDs

## 6.2 System Configuration and Recovery Jumpers

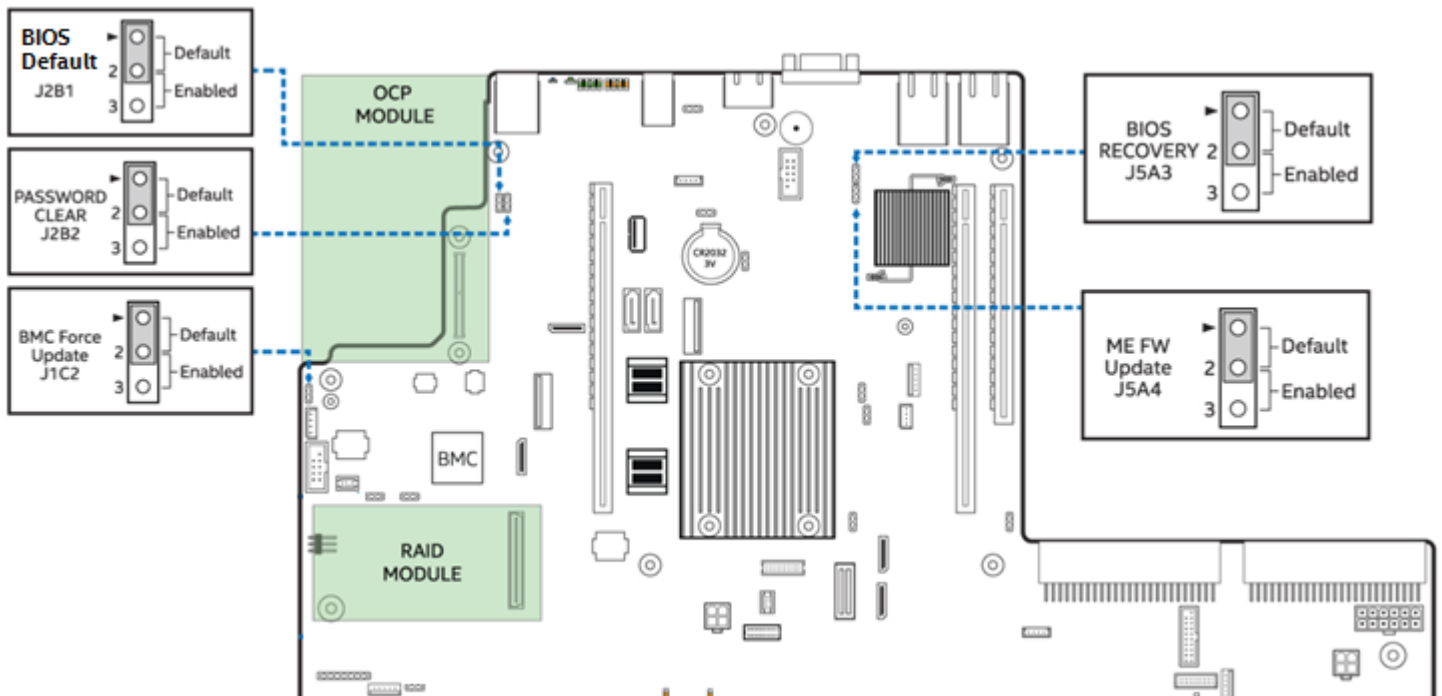


Figure 124. System Configuration and Recovery Jumpers

The following sections describe how each jumper block is used.

### 6.2.1 BIOS Default Jumper Block

This jumper resets BIOS options, configured using the <F2> BIOS Setup Utility, back to their original default factory settings.

---

**Note:** This jumper does not reset Administrator or User passwords. In order to reset passwords, the Password Clear jumper must be used

---

1. Power down the server and unplug the power cord(s)
2. Remove the system top cover and move the “BIOS DFLT” jumper from pins 1 - 2 (default) to pins 2 - 3 (Set BIOS Defaults)
3. Wait 5 seconds then move the jumper back to pins 1 - 2
4. Re-install the system top cover
5. Re-Install system power cords

---

**Note:** The system will automatically power on after AC is applied to the system.

---

6. During POST, access the <F2> BIOS Setup utility to configure and save desired BIOS options

---

**Note:** After resetting BIOS options using the BIOS Default jumper, the Error Manager Screen in the <F2> BIOS Setup Utility will display two errors:

0012 System RTC date/time not set  
5220 BIOS Settings reset to default settings

**Note:** also that the system time and date may need to be reset.

---

### 6.2.2 Password Clear Jumper Block

This jumper causes both the User password and the Administrator password to be cleared if they were set. The operator should be aware that this creates a security gap until passwords have been installed again through the <F2> BIOS Setup utility. This is the only method by which the Administrator and User passwords can be cleared unconditionally. Other than this jumper, passwords can only be set or cleared by changing them explicitly in BIOS Setup or by similar means. No method of resetting BIOS configuration settings to default values will affect either the Administrator or User passwords.

1. Power down the server. For safety, unplug the power cord(s)
2. Remove the system top cover
3. Move the “Password Clear” jumper from pins 1 - 2 (default) to pins 2 - 3 (password clear position)
4. Re-install the system top cover and re-attach the power cords
5. Power up the server and access the <F2> BIOS Setup utility
6. Verify the password clear operation was successful by viewing the Error Manager screen. Two errors should be logged:
  - 5221 Passwords cleared by jumper
  - 5224 Password clear jumper is set
7. Exit the BIOS Setup utility and power down the server. For safety, remove the AC power cords
8. Remove the system top cover and move the “Password Clear” jumper back to pins 1 - 2 (default)
9. Re-install the system top cover and reattach the AC power cords.
10. Power up the server
11. Strongly recommended: Boot into <F2> BIOS Setup immediately, go to the Security tab and set the Administrator and User passwords if you intend to use BIOS password protection

### 6.2.3 Management Engine (ME) Firmware Force Update Jumper Block

When the ME Firmware Force Update jumper is moved from its default position, the ME is forced to operate in a reduced minimal operating capacity. This jumper should only be used if the ME firmware has gotten corrupted and requires re-installation. The following procedure should be followed.

---

**Note:** System Update files are included in the System Update Packages (SUP) posted to Intel's Download center web site. <http://downloadcenter.intel.com>

---

1. Turn off the system.
2. Remove the AC power cords

---

**Note:** If the ME FRC UPD jumper is moved with AC power applied to the system, the ME will not operate properly.

---

3. Remove the system top cover
4. Move the "ME FRC UPD" Jumper from pins 1 - 2 (default) to pins 2 - 3 (Force Update position)
5. Re-install the system top cover and re-attach the AC power cords
6. Power on the system
7. Boot to the EFI shell
8. Change directories to the folder containing the update files
9. Update the ME firmware using the following command:  
    `iflash32 /u /ni <version#>_ME.cap`
10. When the update has successfully completed, power off the system
11. Remove the AC power cords
12. Remove the system top cover
13. Move the "ME FRC UPD" jumper back to pins 1-2 (default)
14. Re-attach the AC power cords
15. Power on system

### 6.2.4 BMC Force Update Jumper Block

The BMC Force Update jumper is used to put the BMC in Boot Recovery mode for a low-level update. It causes the BMC to abort its normal boot process and stay in the boot loader without executing any Linux code.

This jumper should only be used if the BMC firmware has gotten corrupted and requires re-installation. The following procedure should be followed:

---

**Note:** System Update files are included in the System Update Packages (SUP) posted to Intel's Download center web site. <http://downloadcenter.intel.com>

---

1. Turn off the system.
2. Remove the AC power cords

---

**Note:** If the BMC FRC UPD jumper is moved with AC power applied to the system, the BMC will not operate properly.

---

3. Remove the system top cover
4. Move the "BMC FRC UPD" Jumper from pins 1 - 2 (default) to pins 2 - 3 (Force Update position)
5. Re-install the system top cover and re-attach the AC power cords

6. Power on the system
7. Boot to the EFI shell
8. Change directories to the folder containing the update files
9. Update the BMC firmware using the following command:  
FWPIAUPD -u -bin -ni -b -o -pia -if=usb <file name.BIN>
10. When the update has successfully completed, power off the system
11. Remove the AC power cords
12. Remove the system top cover
13. Move the “BMC FRC UPD” jumper back to pins 1-2 (default)
14. Re-attach the AC power cords
15. Power on system
16. Boot to the EFI shell
17. Change directories to the folder containing the update files
18. Re-install the board/system SDR data by running the FRUSDR utility
19. After the SDRs have been loaded, reboot the server

### 6.2.5 BIOS Recovery Jumper

When the BIOS Recovery jumper block is moved from its default pin position (pins 1-2), the system will boot using a backup BIOS image to the uEFI shell, where a standard BIOS update can be performed. See the BIOS update instructions that are included with System Update Packages (SUP) downloaded from Intel's download center web site. This jumper is used when the system BIOS has become corrupted and is non-functional, requiring a new BIOS image to be loaded on to the server board.

---

**Note:** The BIOS Recovery jumper is ONLY used to re-install a BIOS image in the event the BIOS has become corrupted. This jumper is NOT used when the BIOS is operating normally and you need to update the BIOS from one version to another.

---

The following procedure should be followed.

---

**Note:** System Update Packages (SUP) can be downloaded from Intel's download center web site.  
<http://downloadcenter.intel.com>

---

1. Turn off the system
2. For safety, remove the AC power cords
3. Remove the system top cover
4. Move the “BIOS Recovery” jumper from pins 1 - 2 (default) to pins 2 - 3 (BIOS Recovery position)
5. Re-install the system top cover and re-attach the AC power cords
6. Power on the system
7. The system will automatically boot to the EFI shell. Update the BIOS using the standard BIOS update instructions provided with the system update package
8. After the BIOS update has successfully completed, power off the system. For safety, remove the AC power cords from the system
9. Remove the system top cover
10. Move the BIOS Recovery jumper back to pins 1-2 (default)
11. Re-install the system top cover and re-attach the AC power cords
12. Power on the system and access the <F2> BIOS Setup utility
13. Configure desired BIOS settings
14. Hit the <F10> key to save and exit the utility

### **6.2.6 Serial Port 'A' Configuration Jumper**

Pin 7 of the RJ45 Serial A connector is configurable to support either a DSR (Default) signal or a DCD signal. Pin 7 signals are changed by moving the jumper on the jumper block labeled "J4A2", located next to the connector, from pins 1-2 (default) to pins 2-3.



## 7. System Service - FRU Replacement

---

This chapter provides instruction for the removal and installation of system components considered as field replaceable. Components within the system can only be serviced after the system has been powered off and AC power cords have been disconnected from the server system.

Instruction for the removal and installation of add-in options is documented in Chapters 2 and 3.

These include:

- Processors
- Memory
- Riser Cards
- Add-in cards
- OCP Modules
- Storage Devices
- Power Supplies

### Before You Begin

Before working with your server product, observe the safety and ESD precautions found in the Warnings section at the beginning of this manual.

### Tools and Supplies Needed

Anti-static wrist strap and conductive foam pad (recommended)

Phillips\* (cross head) screwdriver (#2 bit)

Flat Head screwdriver

T30 Torx bit screwdriver

### System Reference

All references to left, right, front, and back, assume the reader is facing the front of the system or the side opposite that of the external I/O connectors of the server board.

## 7.1 System Fan Replacement

System fans used in the Intel Server System R2000WF product family are hot-swappable.

---

**CAUTION:** To minimize possible performance degradation and other thermal related issues, system fan replacement while the system is operational should be performed as quickly as possible.

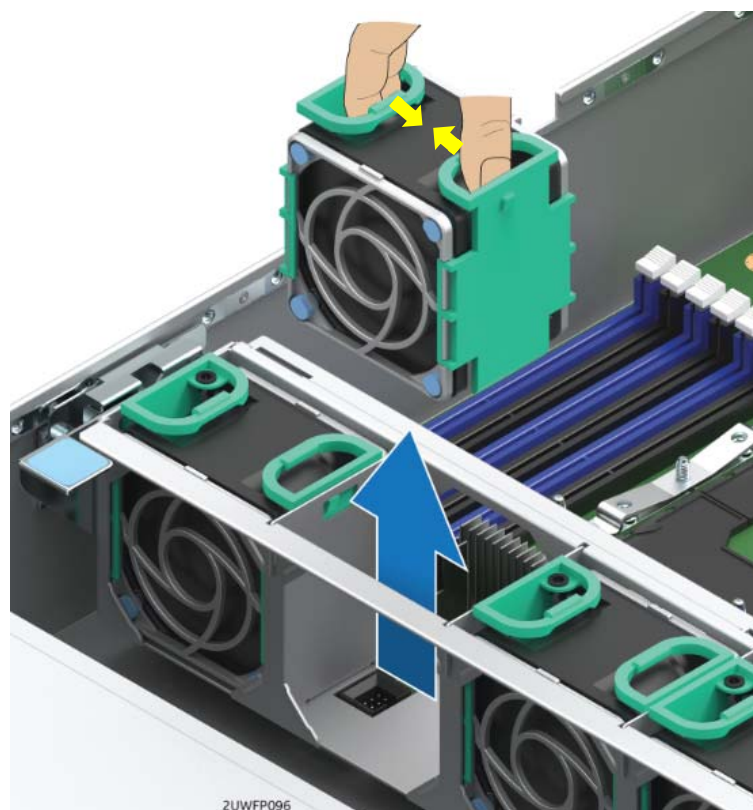
System fans operate at very high speeds. Keep all tools and fingers away from all operational system fans when swapping out a defective fan.

Components within an operational system can get very hot. Avoid touching any components within the system while swapping out a defective system fan.

---

### 7.1.1 To remove a failed system fan

1. Remove the system top cover (see Section 2.2.1)
2. Locate the faulty system fan – The LED on the faulty fan should be illuminated



**Figure 125. System Fan Removal**

3. Squeeze the two loop handles on the top side of the fan, and pull straight up until it clears the fan module bracket.

### 7.1.2 To install a new system fan

1. Locate the replacement fan (Intel product Code – **FR2UFAN60HSW**).
2. Orient the fan so the arrow located on the top side of the fan points to the back of the system.
3. Insert the fan into the fan module bracket.
4. Push down until it is firmly seated into the server board connector.
5. Re-install system top cover (see Section 2.2.2).

## 7.2 Replacing the System Battery

The battery on the server board powers the Real Time Clock for up to 10 years in the absence of power. When the battery starts to weaken, it loses voltage, and stored server settings and system clock and date settings may be lost.

Battery Specification:

- Lithium
- 3V
- Coin CR-2032

Contact your customer service representative or dealer for a list of approved devices.

**Warning:** *Danger of explosion if battery is incorrectly replaced. Replace only with the same or equivalent type recommended by the equipment manufacturer. Discard used batteries according to manufacturer's instructions.*

**Advarsel:** Lithiumbatteri - Eksplosionsfare ved fejlagtig håndtering. Udskiftning må kun ske med batteri af samme fabrikat og type. Levér det brugte batteri tilbage til leverandøren.

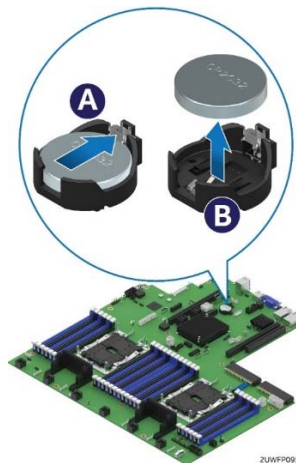
**Advarsel:** Lithiumbatteri - Eksplosjonsfare. Ved utskifting benyttes kun batteri som anbefalt av apparatfabrikanten. Brukt batteri returneres apparatleverandøren.

**Varning:** Explosionsfara vid felaktigt batteribyte. Använd samma batterityp eller en ekvivalent typ som rekommenderas av apparattillverkaren. Kassera använt batteri enligt fabrikantens instruktion.

**Varoitus:** Paristo voi räjähtää, jos se on virheellisesti asennettu. Vaihda paristo ainoastaan laitevalmistajan suosittelemaan tyyppiin. Hävitä käytetty paristo valmistajan ohjeiden mukaisesti.

**To replace the battery:**

1. Locate the battery on the server board.
2. Gently press the metal clip as shown to release the battery (see Letter "A").
3. Remove the battery from the plastic socket (see Letter "B").



**Figure 126. Replacing the Backup Battery**

4. Dispose of the battery according to local ordinance.
5. Remove the new lithium battery from its package, and, being careful to observe the correct polarity, insert it in to the battery socket.

---

**Note:** The <F2> BIOS Setup Utility must be accessed and setting must be set and saved to restore configuration settings

---

## 7.3 Standard Rack Handle – Installation / Removal

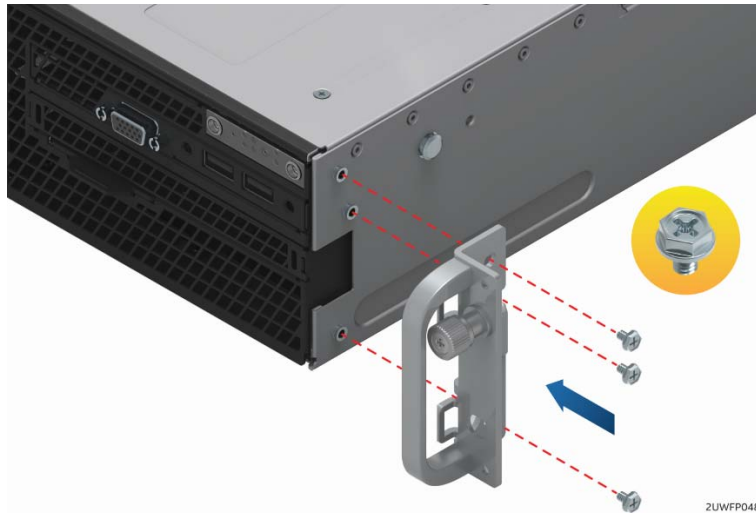
The system includes a set of rack handles designed to secure a system into a rack or cabinet and to aid with pulling systems from or pushing systems into a rack or cabinet.

---

**Note:** The system should never be carried by the rack handles. Intel recommends carrying the system using two people supporting the system from the sides or to use a cart when moving the system from one location to another.

---

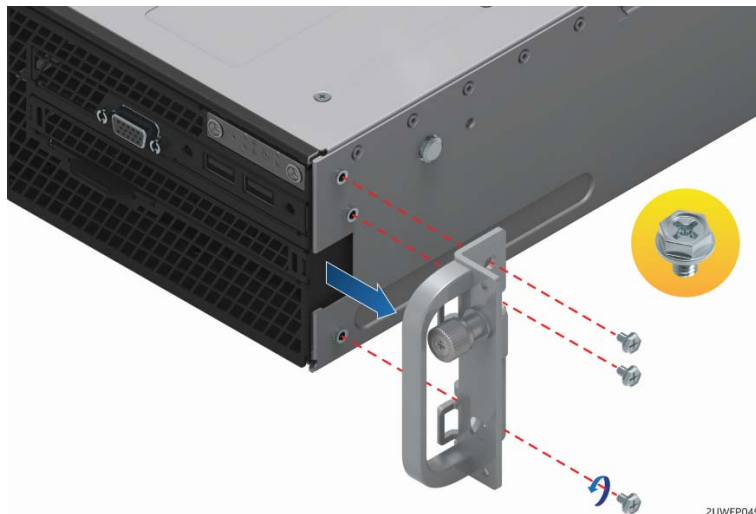
### 7.3.1 Standard Rack Handle Installation



**Figure 127. Standard Rack Handle Installation**

1. Locate the rack handles.
2. Align the rack handle with the three holes on the side of the server system.
3. Attach the rack handle to the server system with three screws using 8 in/lbf torque.

### 7.3.2 Standard Rack Handle Removal



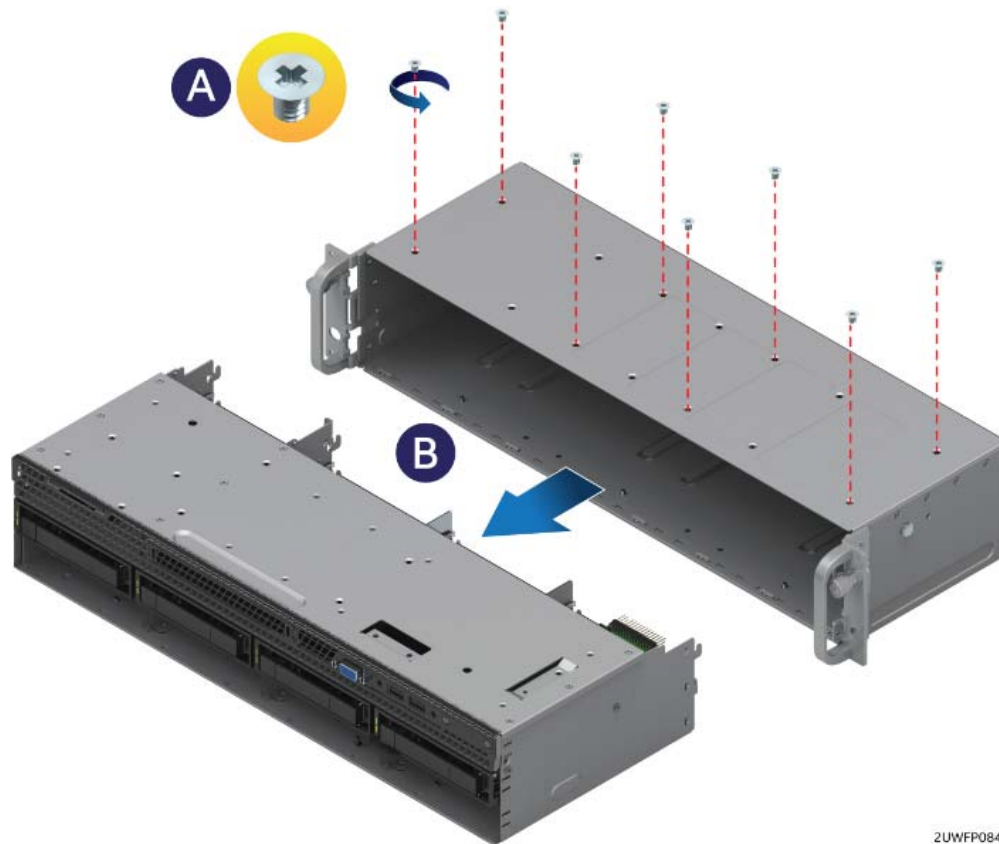
**Figure 128. Standard Rack Handle Removal**

Remove the three screws holding the rack handle to the chassis.

## 7.4 Standard Front Control Panel Replacement (R2308WFxxx)

### 7.4.1 Standard Front Control Panel Removal (R2308WFxxx)

1. Power off the system and remove all power cords.
2. Remove the system top cover (see Section 2.2.1).
3. Remove the air duct (see Section 2.3.1).
4. Remove the system fan assembly (see Section 2.4.1).
5. From the server board, disconnect the round black front panel USB cable, 14-pin gray front panel video ribbon cable, and the 30-pin gray front panel ribbon cable.
6. From the hotswap backplane, disconnect the 2x2-pin backplane power cable, all cables connected to the mini-SAS HD connectors, and the I2C cable.
7. Identify and remove the bottom four drive carriers from the drive bay.



**Figure 129. Removing the Drive Bay Module**

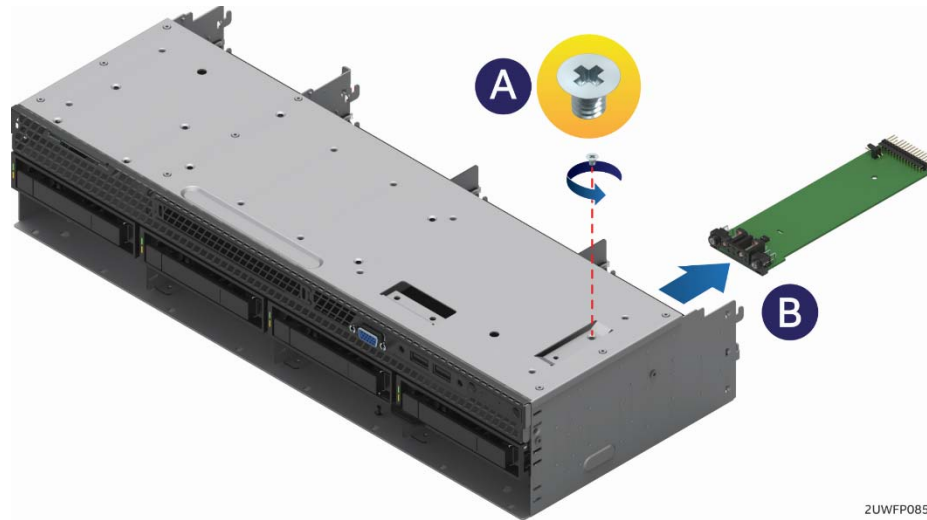
8. Remove the eight screws from the top of the drive bay (see Letter 'A').
9. From the back side of the drive bay module, carefully push it out towards the front of the chassis (see Letter 'B').

---

**Note:** As the module slides out from the chassis, the retention clip found on the front bottom edge of the drive bay module will disengage. When loose, remove and set it aside for re-installation.

---





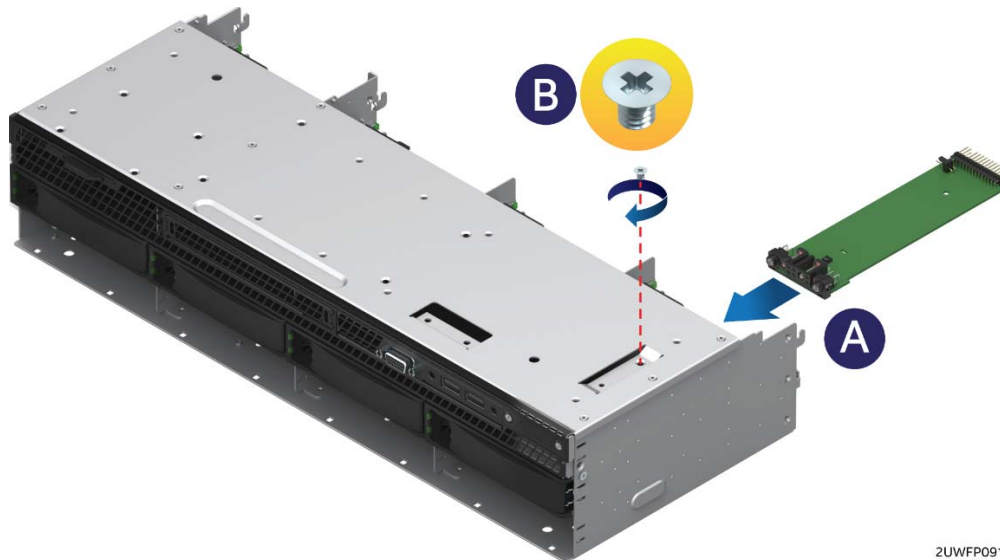
2UWFP085

**Figure 130. Control Panel Board Removal**

10. Remove the screw securing the control panel module to the drive bay module (see Letter 'A')
11. Remove the control panel board from the back of the drive bay module (see Letter 'B')

#### 7.4.2 Standard Front Control Panel Installation (R2308WFxxx)

1. Locate and remove the replacement control panel board from its packaging – (Intel Product Code – **FXXFPANEL2**).
2. Connect the 30-pin ribbon cable to the new control panel.



2UWFP091

**Figure 131. Control Panel Board Installation**

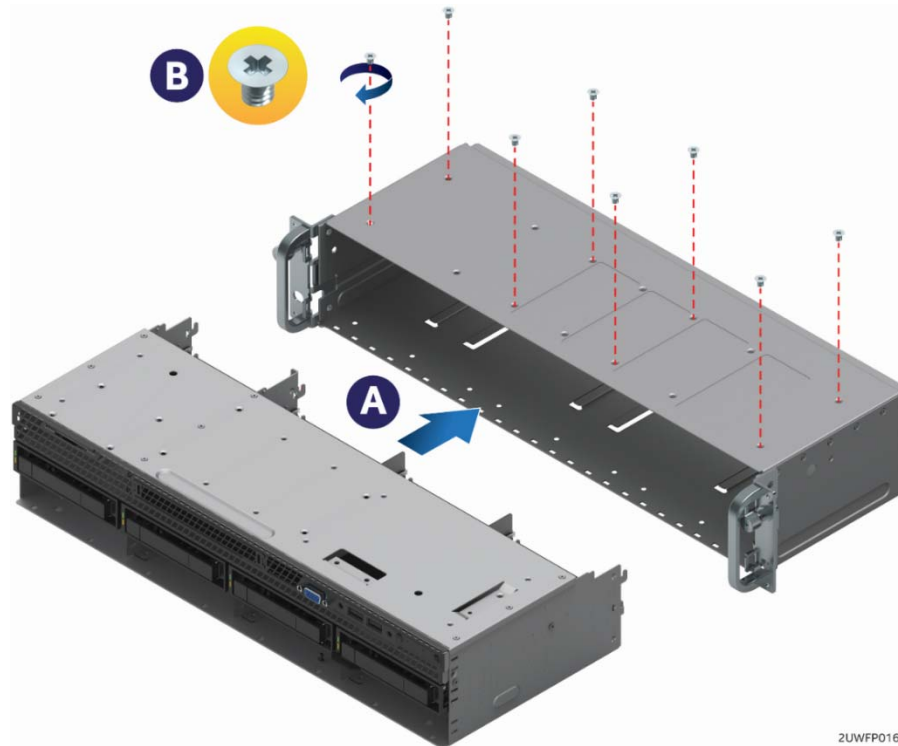
3. Install the control panel board into the back of the drive bay module (see Letter 'A').

---

**Note:** Ensure the plastic bracket over the control panel buttons is securely in place before installing the control panel board into the drive bay module.

---

4. The control panel is properly positioned when the buttons are protruding from the Control Panel face plate on the front of the drive bay module and the screw holes on the top of the module are aligned.
5. Using a single screw, secure the control panel module to the drive bay module (8 in/lbf torque) (see Letter 'B').
6. Ensure the control panel cable is securely attached to the control panel board.



**Figure 132. 3.5"x8 Drive Bay Module Installation**

7. Slide the 8 x 3.5" Front Drive Bay module into the front of the chassis (see Letter 'A').
8. Ensure the screw holes on the top of the drive bay are properly aligned.
9. Using eight fastener screws, secure the drive bay module to the chassis (8 in/lbf torque) (see Letter 'B').
10. Locate the drive bay retention clip.



**Figure 133. 3.5"x8 Drive Bay Module Retention Clip Installation**

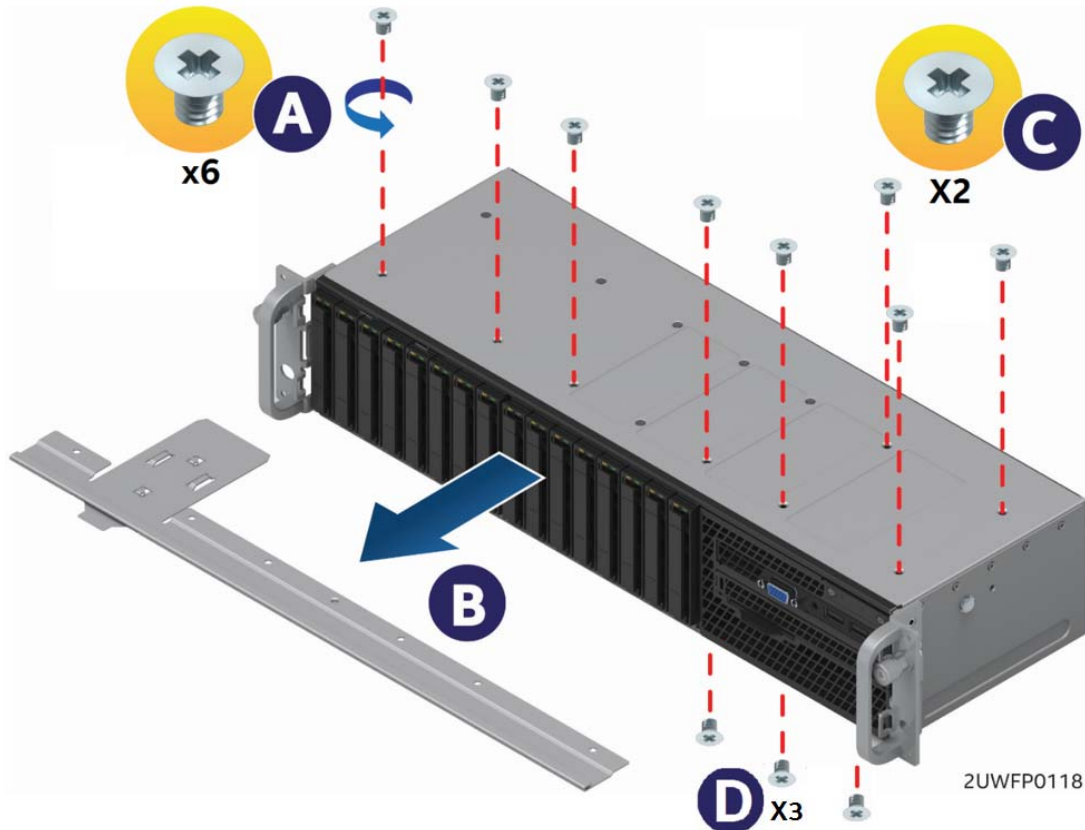
11. Slide the drive bay retention clip over the bottom edge of the drive bay module. The retention clip should clamp together the bottom of the drive bay module to the chassis base.
12. Re-attach all cables described in steps 5 & 6 of the removal process.
13. Re-Install drives into the same drive bays from where they were removed.
14. Install system fan module (see Section 2.4.2).
15. Install air duct (see Section 2.3.2).

## 7.5 Standard Front Control Panel Replacement (R2208WFxxx)

The following procedures apply to both 8 and 16 drive system configurations.

### 7.5.1 Standard Front Control Panel Removal (R2208WFxxx)

1. Power off the system and remove all power cords.
2. Remove the system top cover (see Section 2.2.1).
3. Remove the air duct (see Section 2.3.1).
4. Remove the system fan module (see Section 2.4.1).
5. From the server board, disconnect the black round front panel USB cable, 14-pin gray front panel video ribbon cable, and the 30-pin gray front panel ribbon cable.



6. Extract the drive bay retention bracket. To extract the drive bay retention bracket, remove the six (6) screws from the top front edge of the drive bay (see Letter 'A') and pull out the metal bracket (see Letter 'B').
7. Remove the two (2) screws from the back edge of the drive bay over the I/O Bay Module (see Letter 'C').
8. Carefully turn the system onto its side and remove the three (3) screws from the bottom of the I/O Bay module (see Letter 'D').
9. Carefully return the server to its original position.

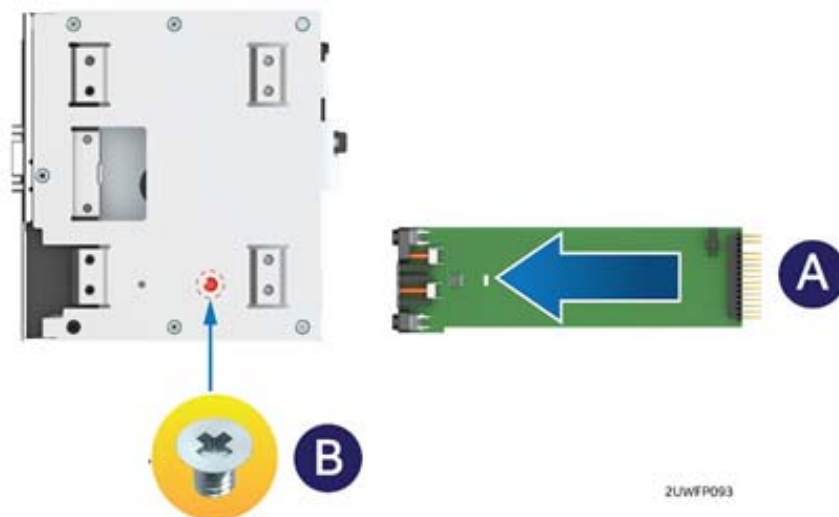


**Figure 134. I/O Bay Module Removal**

10. Carefully slide out the I/O Bay module from the chassis.
11. Remove the screw used to secure Front Panel board to the I/O Bay Module (see Letter 'A')
12. Remove Front Panel Board from the back of the I/O Bay Module.

### 7.5.2 Standard Front Control Panel Installation (R2208WFxxx)

1. Locate and remove the replacement control panel board from its packaging – (Intel Product Code – **FXXFPANEL2**).
2. Connect the 30-pin ribbon cable to the new control panel.



**Figure 135. Control Panel Board Installation**

3. Install the control panel board in to the back of the drive bay module (see Letter 'A').

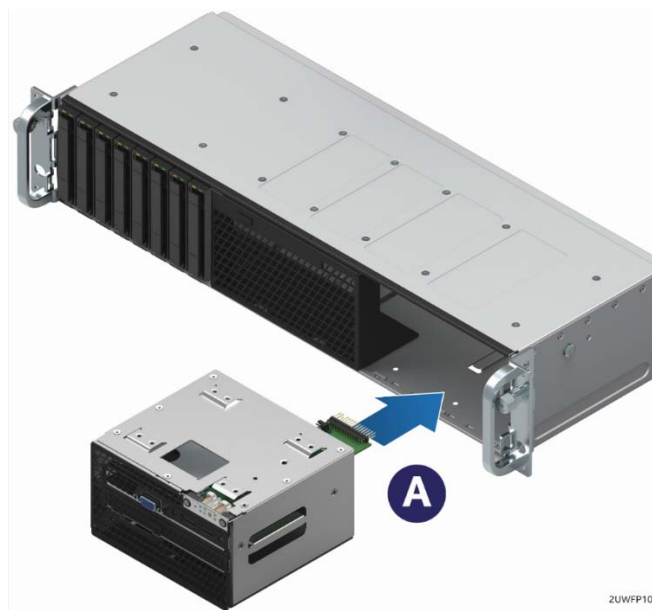
---

**Note:** Ensure the plastic gasket over the control panel buttons is securely in place before installing the control panel board into the drive bay module.

---

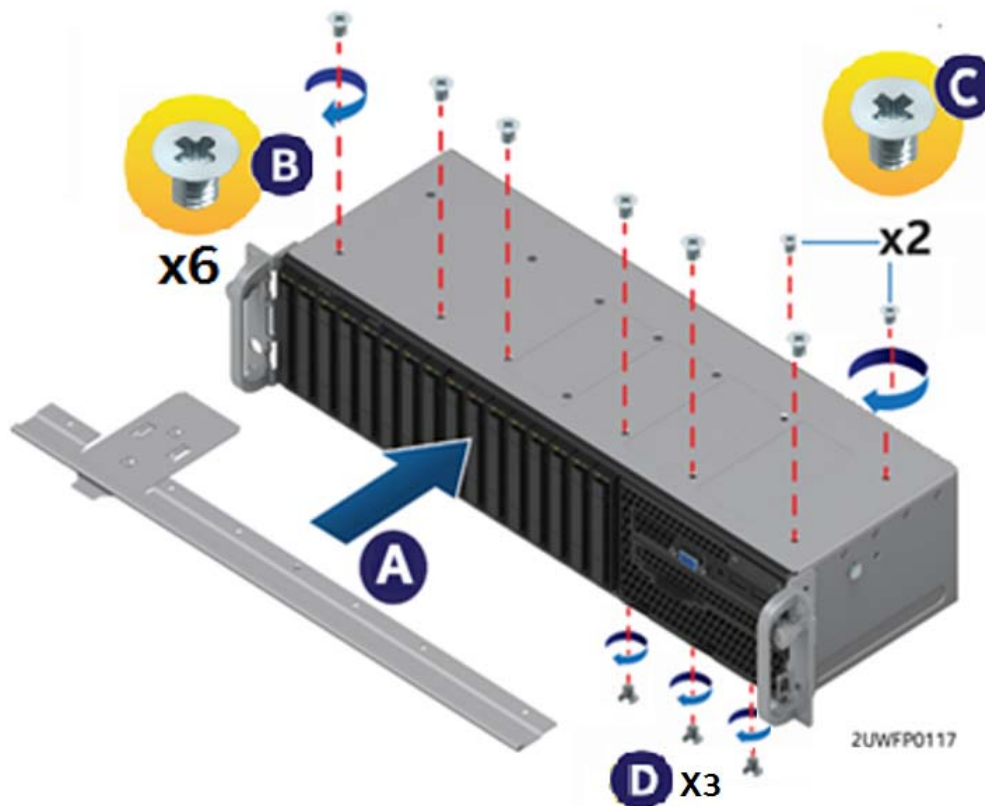
4. The control panel is properly positioned when the buttons are protruding from the Control Panel face plate on the front of the drive bay module and the screw holes on the top of the module are aligned.

- Using a single screw, secure the control panel module to the drive bay module (8 in/lbf torque) (see Letter 'B').
- Ensure the control panel cable is securely attached to the control panel board.



**Figure 136. I/O Bay Module Installation**

- Carefully slide the I/O Bay Module into the chassis (see Letter 'A').



**Figure 137. Retention Bracket Installation**

- Install the drive bay retention bracket into the gap between the top of the drive bay modules and the chassis (see Letter 'A').
- Secure the drive bay retention bracket to the chassis using six (6) screws (8 in/lbf torque) (see Letter 'B').
- Secure the I/O Module bay to the chassis using two (2) screws (8 in/lbf torque) (see Letter 'C').

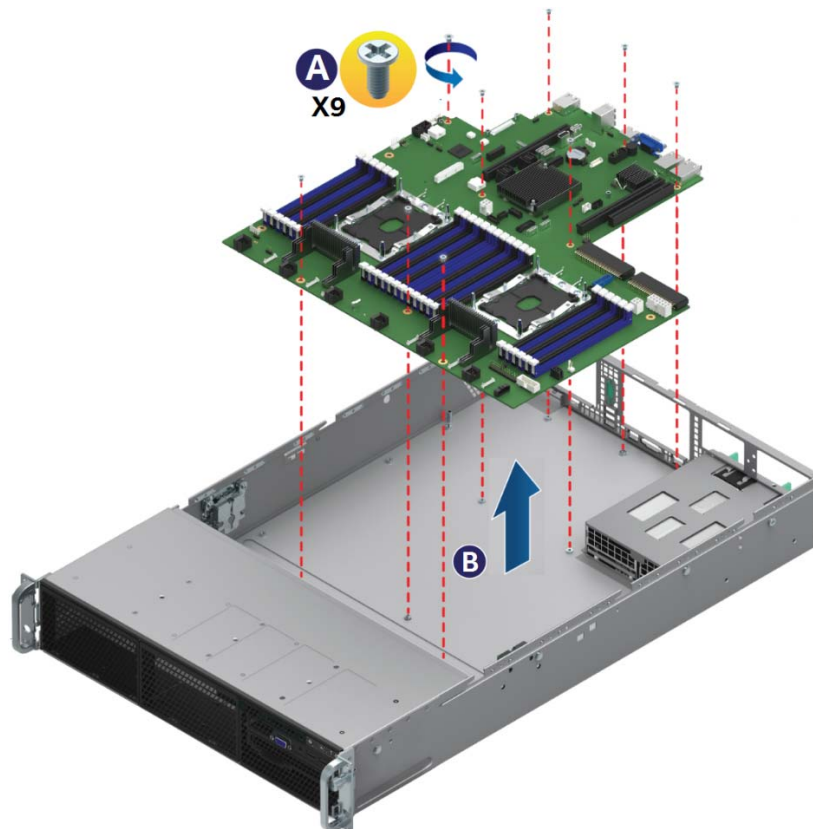


11. Carefully place the system on its side and secure the bottom of the I/O module bay to the chassis using three (3) screws (8 in/lbf torque) (see Letter 'D').
12. Re-attach all cables described in steps 5 & 6 of the removal process.
13. Install system fan module (see Section 2.4.2).
14. Install air duct (see Section 2.3.2).

## 7.6 Replacing the Server Board

### 7.6.1 Server Board Removal

1. Power off system and remove power cords from each power supply module installed.
2. Disconnect all externally attached cables.
3. Remove the system cover (see Section 2.2.1).
4. Remove power supply modules (see Section 3.1.2).
5. If installed, remove all cables from devices mounted to the air duct.
6. Remove air duct (see Section 2.3.1).
7. Remove System Fan Module (see Section 2.4.1).
8. Disconnect all cables attached to add-in PCIe add-cards and I/O modules.
9. Remove riser card assemblies (see Section 2.9.1).
10. Remove all options installed onto the server board including (if installed): OCP module, Intel® SAS RAID Module, Intel® RAID 5 option key, Intel® RMM 4 Lite key, TPM Module, eUSB SSD.
11. Remove processors (see Section 2.5.3).
12. Remove all DIMMs (see section 2.6.2).
13. Disconnect and clear from the server board area all cables attached to connectors on the server board
14. Remove the two air duct sidewalls located on each side of the server board.



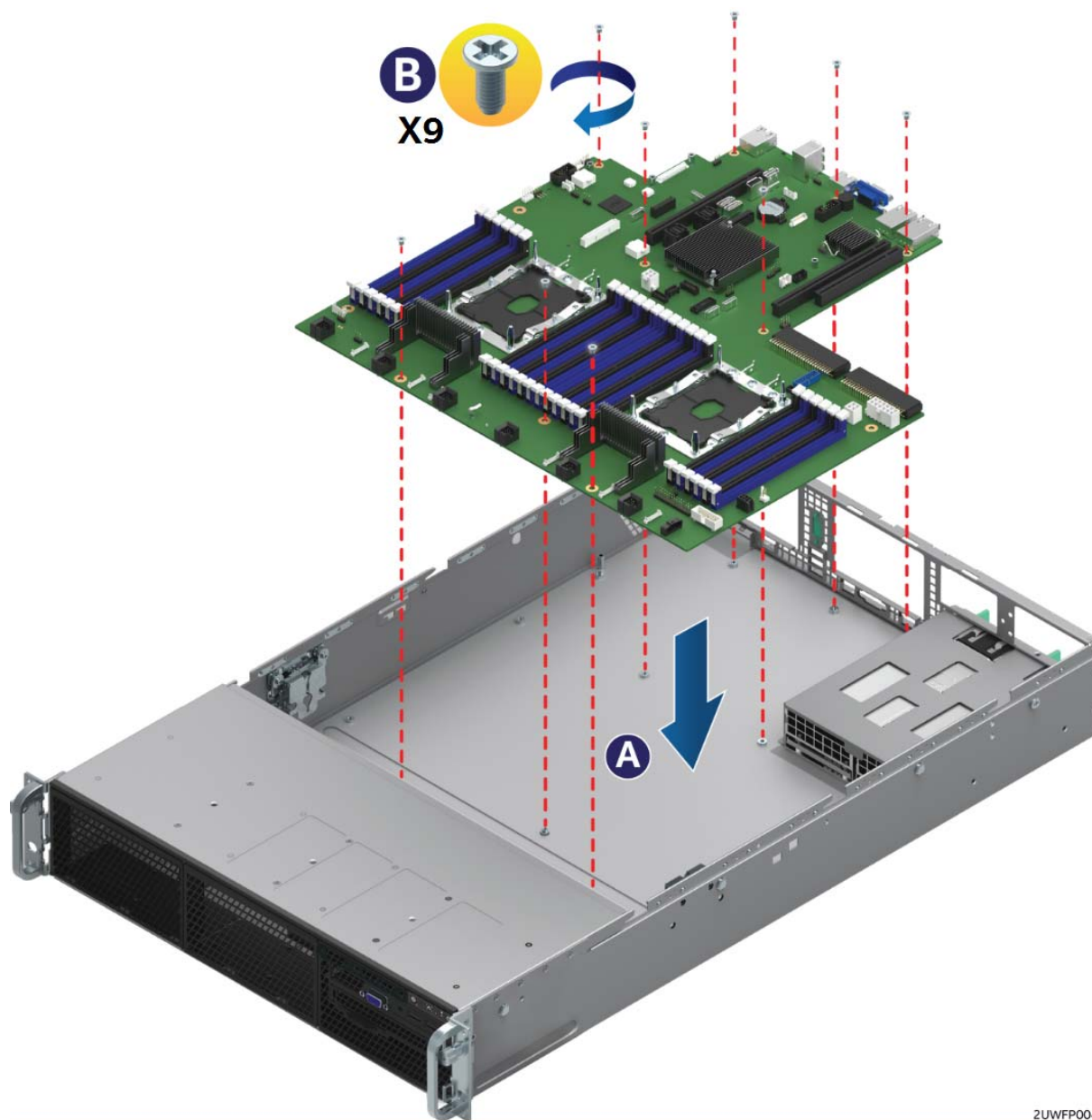
**Figure 138. Server Board Removal**

15. Remove nine screws used to secure the server board to the chassis (see Letter 'A').
16. Carefully lift the server board from the chassis and place it into an anti-static bag.

## 7.6.2 Server Board Installation

**Note:** Follow the ESD precautions outlined at the beginning of this manual

1. Verify that all cables are clear of the area in which the server board will be installed.
2. Remove the server board from its anti-static bag.

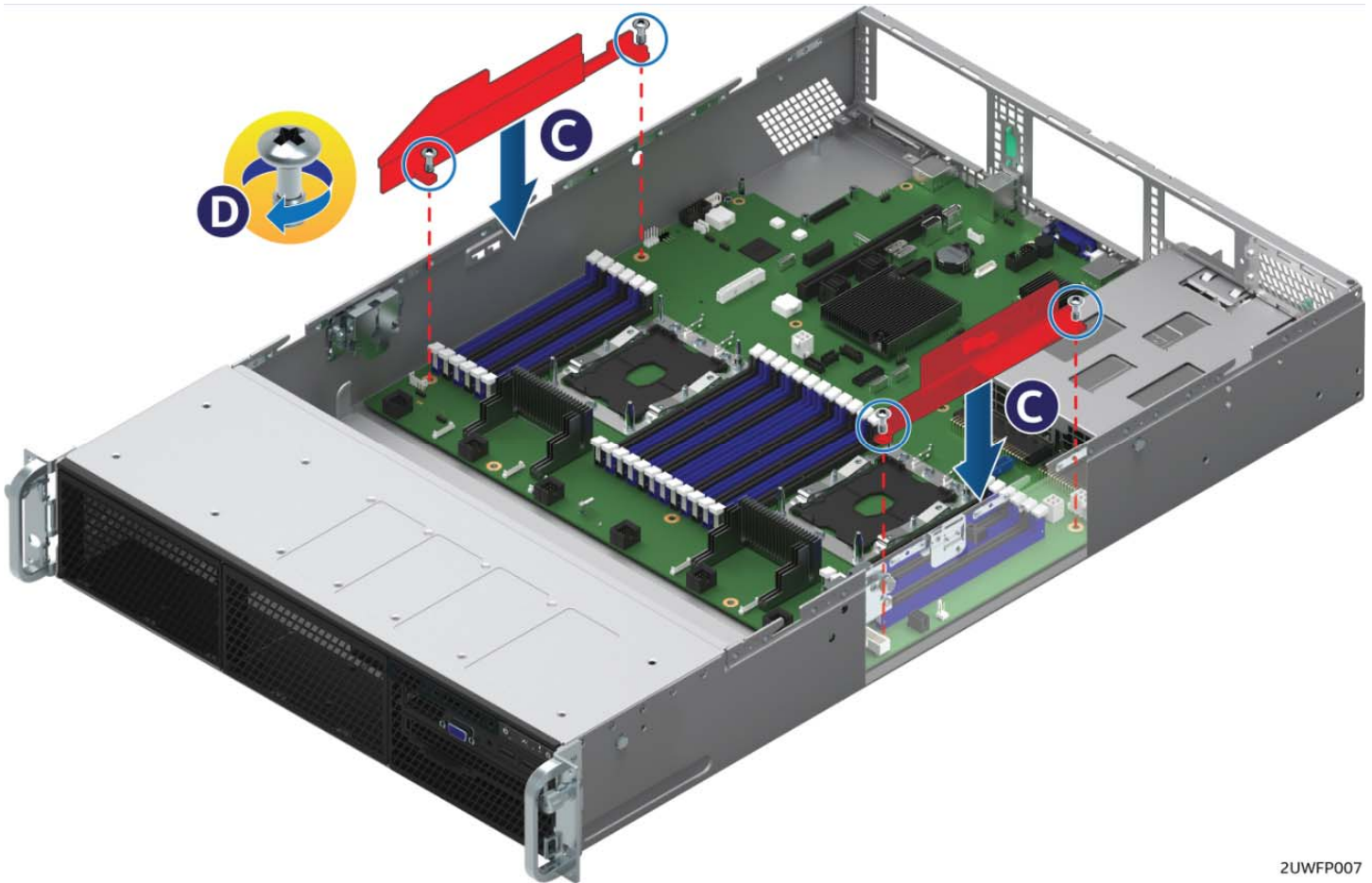


ZUWFP004

**Figure 139. Server Board Installation**

3. Carefully lower the server board into the chassis so that the rear I/O connectors of the server board align with and are fully seated into the matching holes on the chassis back panel.
4. The server board is accurately placed when the two end screw holes nearest the front edge of the server board sit securely onto the shouldered chassis standoffs.
5. Fasten down the server board with 9 screws using 8 in/lbf torque (See Letter “B”).

6. Locate the two black plastic air duct sidewalls.



2UWFP007

**Figure 140. Air Duct Sidewall Installation**

7. Fasten down the appropriate air duct side wall onto each side of the server board using 8 in/lbf torque for each screw (See Letter 'C').
8. Re-attach all cables previously removed from the server board.
9. Install processor(s) (see Section 2.5.2).
10. Install DIMMs (see Section 2.6.1).
11. Re-Install all options previously removed from the server board.
12. Re-Install riser card assemblies (see Section 2.9.3).
13. Re-attach all internal cables previously detached from add-in cards and modules.
14. Re-install system fan module (see Section 2.4.2).
15. Re-install air duct (see Section 2.3.2).
16. Re-attach cables to any device mounted to the air duct.
17. Install power supply module(s) (see Section 3.1.1).
18. Install system cover (see Section 2.2.2).

## Appendix A. Getting Help

If you encounter an issue with your server system, follow these steps to obtain support:

1. Visit the following Intel support web page: <http://www.intel.com/support/>

This web page provides 24x7 support when you need it to get the latest and most complete technical support information on all Intel Enterprise Server and Storage Platforms. Information available at the support site includes:

- Latest BIOS, firmware, drivers and utilities
- Product documentation, installation and quick start guides
- Full product specifications, technical advisories and errata
- Compatibility documentation for memory, hardware add-in cards, chassis support matrix and operating systems
- Server and chassis accessory parts list for ordering upgrades or spare parts
- A searchable knowledgebase to search for product information throughout the support site

2. If you are still unable to obtain a solution to your issue, send an email to Intel's technical support center using the online form available at:

[http://www.intel.com/p/en\\_US/support/contactsupport](http://www.intel.com/p/en_US/support/contactsupport)

3. Lastly, you can contact an Intel support representative using one of the support phone numbers available at: <http://www.intel.com/support/feedback.htm?group=server> (charges may apply).

Intel also offers Channel Program members around-the-clock 24x7 technical phone support on Intel® server boards, server chassis, server RAID controller cards, and Intel® Server Management at: <http://www.intel.com/reseller/>.

---

**Note:** You will need to log in to the Reseller site to obtain the 24x7 number.

---

### Warranty Information

To obtain warranty information, visit the following Intel web site:

[http://www.intel.com/p/en\\_US/support/warranty](http://www.intel.com/p/en_US/support/warranty)

## Appendix B. System Status LED Operating States and Definition

The server board includes a bi-color System Status LED. The System Status LED on the server board is tied directly to the System Status LED on the front panel. This LED indicates the current health of the server. Possible LED states include solid green, blinking green, blinking amber, and solid amber.

When the server is powered down (transitions to the DC-off state or S5), the BMC is still on standby power and retains the sensor and front panel status LED state established before the power-down event.

When AC power is first applied to the system, the status LED turns solid amber and then immediately changes to blinking green to indicate that the BMC is booting. If the BMC boot process completes with no errors, the status LED will change to solid green.

**Table 4. System Status LED State Definitions**

Color	State	Criticality	Description
Off	System is not operating	Not ready	<ul style="list-style-type: none"> <li>System is powered off (AC and/or DC).</li> <li>System is in EuP Lot6 Off Mode.</li> <li>System is in S5 Soft-Off State.</li> </ul>
Green	Solid on	Ok	<p>Indicates that the System is running (in S0 State) and its status is 'Healthy'. The system is not exhibiting any errors. AC power is present and BMC has booted and manageability functionality is up and running.</p> <p>After a BMC reset, and in conjunction with the Chassis ID solid ON, the BMC is booting Linux*. Control has been passed from BMC uBoot to BMC Linux* itself. It will be in this state for ~10~20 seconds</p>
Green	~1 Hz blink	Degraded - system is operating in a degraded state although still functional, or system is operating in a redundant state but with an impending failure warning	<p>System degraded:</p> <ul style="list-style-type: none"> <li>Redundancy loss such as power-supply or fan. Applies only if the associated platform sub-system has redundancy capabilities.</li> <li>Fan warning or failure when the number of fully operational fans is less than minimum number needed to cool the system.</li> <li>Non-critical threshold crossed – Temperature (including HSBP temp), voltage, input power to power supply, output current for main power rail from power supply and Processor Thermal Control (Therm Ctrl) sensors.</li> <li>Power supply predictive failure occurred while redundant power supply configuration was present.</li> <li>Unable to use all of the installed memory (more than 1 DIMM installed).</li> <li>Correctable Errors over a threshold and migrating to a spare DIMM (memory sparing). This indicates that the system no longer has spared DIMMs (a redundancy lost condition). Corresponding DIMM LED lit.</li> <li>In mirrored configuration, when memory mirroring takes place and system loses memory redundancy.</li> <li>Battery failure.</li> <li>BMC executing in uBoot. (Indicated by Chassis ID blinking at 3Hz). System in degraded state (no manageability). BMC uBoot is running but has not transferred control to BMC Linux*. Server will be in this state 6-8 seconds after BMC reset while it pulls the Linux* image into flash.</li> <li>BMC Watchdog has reset the BMC.</li> <li>Power Unit sensor offset for configuration error is asserted.</li> <li>HDD HSC is off-line or degraded.</li> </ul>
Amber	~1 Hz blink	Non-critical - System is operating in a degraded state with an impending failure warning, although still functioning	<p>Non-fatal alarm – system is likely to fail:</p> <ul style="list-style-type: none"> <li>Critical threshold crossed – Voltage, temperature (including HSBP temp), input power to power supply, output current for main power rail from power supply and PROCHOT (Therm Ctrl) sensors.</li> <li>VRD Hot asserted.</li> <li>Minimum number of fans to cool the system not present or failed</li> <li>Hard drive fault</li> <li>Power Unit Redundancy sensor – Insufficient resources offset (indicates not enough power supplies present)</li> </ul>



Color	State	Criticality	Description
			<ul style="list-style-type: none"> <li>• In non-sparing and non-mirroring mode if the threshold of correctable errors is crossed within the window</li> </ul>
Amber	Solid on	Critical, non-recoverable – System is halted	<p>Fatal alarm – system has failed or shutdown:</p> <ul style="list-style-type: none"> <li>• CPU CATERR signal asserted</li> <li>• MSID mismatch detected (CATERR also asserts for this case).</li> <li>• CPU 1 is missing</li> <li>• CPU Thermal Trip</li> <li>• No power good – power fault</li> <li>• DIMM failure when there is only 1 DIMM present and hence no good memory present.</li> <li>• Runtime memory uncorrectable error in non-redundant mode.</li> <li>• DIMM Thermal Trip or equivalent</li> <li>• SSB Thermal Trip or equivalent</li> <li>• CPU ERR2 signal asserted</li> <li>• BMC/Video memory test failed. (Chassis ID shows blue/solid-on for this condition)</li> <li>• Both uBoot BMC FW images are bad. (Chassis ID shows blue/solid-on for this condition)</li> <li>• 240VA fault</li> <li>• Fatal Error in processor initialization:                             <ul style="list-style-type: none"> <li>○ Processor family not identical</li> <li>○ Processor model not identical</li> <li>○ Processor core/thread counts not identical</li> <li>○ Processor cache size not identical</li> <li>○ Unable to synchronize processor frequency</li> <li>○ Unable to synchronize QPI link frequency</li> </ul> </li> <li>• Uncorrectable memory error in a non-redundant mode</li> </ul>

## Appendix C. POST Code Diagnostic LED Decoder Table

As an aid to assist in trouble shooting a system hang that occurs during a system's Power-On Self-Test (POST) process, the server board includes a bank of eight POST Code Diagnostic LEDs on the back edge of the server board as shown in the Figure below.

During the system boot process, Memory Reference Code (MRC) and System BIOS execute a number of memory initialization and platform configuration processes, each of which is assigned a specific hex POST code number.

As each routine is started, the given POST code number is displayed to the POST Code Diagnostic LEDs on the back edge of the server board.

During a POST system hang, the displayed post code can be used to identify the last POST routine that was run prior to the error occurring, helping to isolate the possible cause of the hang condition.

Each POST code is represented by eight LEDs; four green and four amber. The POST codes are divided into two nibbles, an upper nibble and a lower nibble. The upper nibble bits are represented by Amber Diagnostic LEDs and the lower nibble bits are represented by Green Diagnostics LEDs. If the bit is set in the upper and lower nibbles, the corresponding LED is lit. If the bit is clear, the corresponding LED is off.

**Note:** Diag LEDs are best read and decoded when viewing the LEDs from the back of the system.

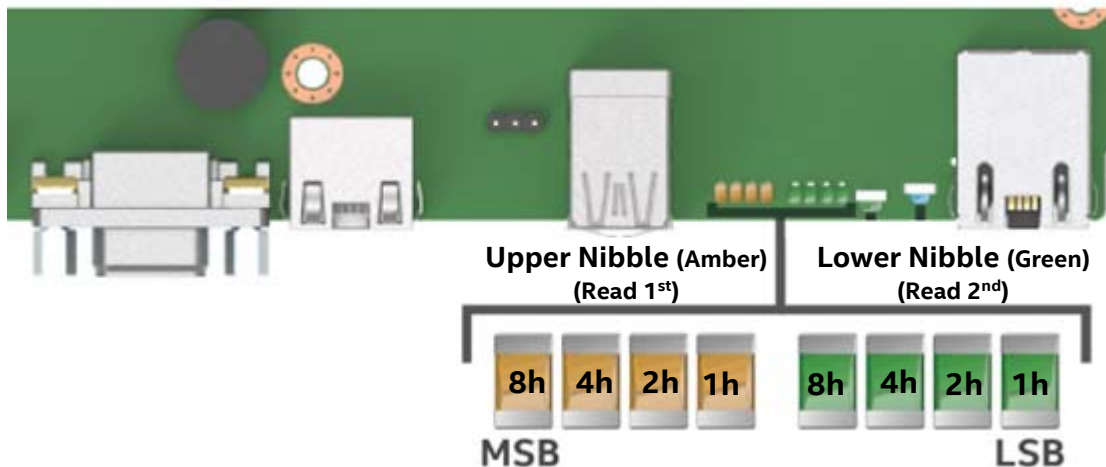


Figure 141. POST Diagnostic LED Location

In the following example, the BIOS sends a value of ACh to the diagnostic LED decoder. The LEDs are decoded as shown in Table 5.

Table 5. POST Progress Code LED Example

Binary Value	Upper Nibble AMBER LEDs				Lower Nibble GREEN LEDs			
	MSB							LSB
LED State	1	0	1	0	1	1	0	0
Hex Value	8h	4h	2h	1h	8h	4h	2h	1h
Hex Result	Ah				Ch			

Upper nibble bits = 1010b = Ah; Lower nibble bits = 1100b = Ch; the two are concatenated as ACh

## Early POST Memory Initialization MRC Diagnostic Codes

Memory Initialization at the beginning of POST includes multiple functions, including: discovery, channel training, validation that the DIMM population is acceptable and functional, initialization of the IMC and other hardware settings, and initialization of applicable RAS configurations.

The MRC Progress Codes are displayed to the Diagnostic LEDs that show the execution point in the MRC operational path at each step.

**Table 6. MRC Progress Codes**

Checkpoint	Diagnostic LED Decoder								Description
	1 = LED On, 0 = LED Off								
	Upper Nibble (Amber)				Lower Nibble (Green)				
	MSB							LSB	
	8h	4h	2h	1h	8h	4h	2h	1h	
MRC Progress Codes									
<b>B0h</b>	1	0	1	1	0	0	0	0	Detect DIMM population
<b>B1h</b>	1	0	1	1	0	0	0	1	Set DDR4 frequency
<b>B2h</b>	1	0	1	1	0	0	1	0	Gather remaining SPD data
<b>B3h</b>	1	0	1	1	0	0	1	1	Program registers on the memory controller level
<b>B4h</b>	1	0	1	1	0	1	0	0	Evaluate RAS modes and save rank information
<b>B5h</b>	1	0	1	1	0	1	0	1	Program registers on the channel level
<b>B6h</b>	1	0	1	1	0	1	1	0	Perform the JEDEC defined initialization sequence
<b>B7h</b>	1	0	1	1	0	1	1	1	Train DDR4 ranks
<b>B8h</b>	1	0	1	1	1	0	0	0	Initialize CLTT/OLTT
<b>B9h</b>	1	0	1	1	1	0	0	1	Hardware memory test and init
<b>BAh</b>	1	0	1	1	1	0	1	0	Execute software memory init
<b>BBh</b>	1	0	1	1	1	0	1	1	Program memory map and interleaving
<b>BCh</b>	1	0	1	1	1	1	0	0	Program RAS configuration
<b>BFh</b>	1	0	1	1	1	1	1	1	MRC is done

Should a major memory initialization error occur, preventing the system from booting with data integrity, a beep code is generated, the MRC will display a fatal error code on the diagnostic LEDs, and a system halt command is executed. Fatal MRC error halts do NOT change the state of the System Status LED, and they do NOT get logged as SEL events. The following table lists all MRC fatal errors that are displayed to the Diagnostic LEDs.

---

**Note:** Fatal MRC errors will display POST error codes that may be the same as BIOS POST progress codes displayed later in the POST process. The fatal MRC codes can be distinguished from the BIOS POST progress codes by the accompanying memory failure beep code of 3 long beeps as identified in Table 10.

---

Table 7. MRC Fatal Error Codes

Checkpoint	Diagnostic LED Decoder								Description
	1 = LED On, 0 = LED Off								
	Upper Nibble (Amber - Read 1st)				Lower Nibble (Green - Read 2nd)				
	MSB							LSB	
	8h	4h	2h	1h	8h	4h	2h	1h	
<b>MRC Fatal Error Codes</b>									
<b>E8h</b>	1	1	1	0	1	0	0	0	No usable memory error 01h = No memory was detected from SPD read, or invalid config that causes no operable memory. 02h = Memory DIMMs on all channels of all sockets are disabled due to hardware memtest error. 03h = No memory installed. All channels are disabled.
<b>E9h</b>	1	1	1	0	1	0	0	1	Memory is locked by Intel Trusted Execution Technology and is inaccessible
<b>EAh</b>	1	1	1	0	1	0	1	0	DDR4 channel training error 01h = Error on read DQ/DQS (Data/Data Strobe) init 02h = Error on Receive Enable 03h = Error on Write Leveling 04h = Error on write DQ/DQS (Data/Data Strobe)
<b>EBh</b>	1	1	1	0	1	0	1	1	Memory test failure 01h = Software memtest failure. 02h = Hardware memtest failed.
<b>EDh</b>	1	1	1	0	1	1	0	1	DIMM configuration population error 01h = Different DIMM types (RDIMM, LRDIMM) are detected installed in the system. 02h = Violation of DIMM population rules. 03h = The 3rd DIMM slot cannot be populated when QR DIMMs are installed. 04h = UDIMMs are not supported. 05h = Unsupported DIMM Voltage.
<b>EFh</b>	1	1	1	0	1	1	1	1	Indicates a CLTT table structure error

**BIOS POST Progress Codes**

The following table provides a list of all POST progress codes.

**Table 8. POST Progress Codes**

Checkpoint	Diagnostic LED Decoder								Description
	1 = LED On, 0 = LED Off								
	Upper Nibble (Amber - Read 1 <sup>st</sup> )				Lower Nibble (Green - Read 2 <sup>nd</sup> )				
	MSB							LSB	
8h	4h	2h	1h	8h	4h	2h	1h		
SEC Phase									
01h	0	0	0	0	0	0	0	1	First POST code after CPU reset
02h	0	0	0	0	0	0	1	0	Microcode load begin
03h	0	0	0	0	0	0	1	1	CRAM initialization begin
04h	0	0	0	0	0	1	0	0	EI Cache When Disabled
05h	0	0	0	0	0	1	0	1	SEC Core at Power on Begin
06h	0	0	0	0	0	1	1	0	Early CPU initialization during Sec Phase.
UPI RC (Fully leverage without platform change)									
A1h	1	0	1	0	0	0	0	1	Collect info such as SBSP, Boot Mode, Reset type etc
A3h	1	0	1	0	0	0	1	1	Setup minimum path between SBSP & other sockets
A7h	1	0	1	0	0	1	1	1	Topology discovery and route calculation
A8h	1	0	1	0	1	0	0	0	Program final route
A9h	1	0	1	0	1	0	0	1	Program final IO SAD setting
AAh	1	0	1	0	1	0	1	0	Protocol layer and other uncore settings
ABh	1	0	1	0	1	0	1	1	Transition links to full speed operation
ACH	1	0	1	0	1	1	0	0	Phy layer setting
ADh	1	0	1	0	1	1	0	1	Link layer settings
Aeh	1	0	1	0	1	1	1	0	Coherency settings
Afh	1	0	1	0	1	1	1	1	UPI initialization done
07h	0	0	0	0	0	1	1	1	Early SB initialization during Sec Phase.
08h	0	0	0	0	1	0	0	0	Early NB initialization during Sec Phase.
09h	0	0	0	0	1	0	0	1	End Of Sec Phase.
0Eh	0	0	0	0	1	1	1	0	Microcode Not Found.
0Fh	0	0	0	0	1	1	1	1	Microcode Not Loaded.
PEI Phase									
10h	0	0	0	1	0	0	0	0	PEI Core
11h	0	0	0	1	0	0	0	1	CPU PEIM
15h	0	0	0	1	0	1	0	1	NB PEIM
19h	0	0	0	1	1	0	0	1	SB PEIM
MRC Progress Codes									
31h	0	0	1	1	0	0	0	1	Memory Installed
32h	0	0	1	1	0	0	1	0	CPU PEIM (CPU Init)
33h	0	0	1	1	0	0	1	1	CPU PEIM (Cache Init)
4Fh	0	1	0	0	1	1	1	1	Dxe IPL started
DXE Phase									
60h	0	1	1	0	0	0	0	0	DXE Core started
61h	0	1	1	0	0	0	0	1	DXE NVRAM Init
62h	0	1	1	0	0	0	1	0	DXE Setup Init
63h	0	1	1	0	0	0	1	1	DXE CPU Init
65h	0	1	1	0	0	1	0	1	DXE CPU BSP Select
66h	0	1	1	0	0	1	1	0	DXE CPU AP Init
68h	0	1	1	0	1	0	0	0	DXE PCI Host Bridge Init
69h	0	1	1	0	1	0	0	1	DXE NB Init
6Ah	0	1	1	0	1	0	1	0	DXE NB SMM Init
70h	0	1	1	1	0	0	0	0	DXE SB Init
71h	0	1	1	1	0	0	0	1	DXE SB SMM Init
72h	0	1	1	1	0	0	1	0	DXE SB devices Init



Checkpoint	Diagnostic LED Decoder								Description
	1 = LED On, 0 = LED Off								
	Upper Nibble (Amber - Read 1 <sup>st</sup> )				Lower Nibble (Green - Read 2 <sup>nd</sup> )				
	MSB							LSB	
8h	4h	2h	1h	8h	4h	2h	1h		
78h	0	1	1	1	1	0	0	0	DXE ACPI Init
79h	0	1	1	1	1	0	0	1	DXE CSM Init
80h	1	0	0	0	0	0	0	0	DXE BDS Started
81h	1	0	0	0	0	0	0	1	DXE BDS connect drivers
82h	1	0	0	0	0	0	1	0	DXE PCI Bus begin
83h	1	0	0	0	0	0	1	1	DXE PCI Bus HPC Init
84h	1	0	0	0	0	1	0	0	DXE PCI Bus enumeration
85h	1	0	0	0	0	1	0	1	DXE PCI Bus resource requested
86h	1	0	0	0	0	1	1	0	DXE PCI Bus assign resource
87h	1	0	0	0	0	1	1	1	DXE CON_OUT connect
88h	1	0	0	0	1	0	0	0	DXE CON_IN connect
89h	1	0	0	0	1	0	0	1	DXE SIO Init
8Ah	1	0	0	0	1	0	1	0	DXE USB start
8Bh	1	0	0	0	1	0	1	1	DXE USB reset
8Ch	1	0	0	0	1	1	0	0	DXE USB detect
8Dh	1	0	0	0	1	1	0	1	DXE USB enable
91h	1	0	0	1	0	0	0	1	DXE IDE begin
92h	1	0	0	1	0	0	1	0	DXE IDE reset
93h	1	0	0	1	0	0	1	1	DXE IDE detect
94h	1	0	0	1	0	1	0	0	DXE IDE enable
95h	1	0	0	1	0	1	0	1	DXE SCSI begin
96h	1	0	0	1	0	1	1	0	DXE SCSI reset
97h	1	0	0	1	0	1	1	1	DXE SCSI detect
98h	1	0	0	1	1	0	0	0	DXE SCSI enable
99h	1	0	0	1	1	0	0	1	DXE verifying SETUP password
9Bh	1	0	0	1	1	0	1	1	DXE SETUP start
9Ch	1	0	0	1	1	1	0	0	DXE SETUP input wait
9Dh	1	0	0	1	1	1	0	1	DXE Ready to Boot
9Eh	1	0	0	1	1	1	1	0	DXE Legacy Boot
9Fh	1	0	0	1	1	1	1	1	DXE Exit Boot Services
C0h	1	1	0	0	0	0	0	0	RT Set Virtual Address Map Begin
C2h	1	1	0	0	0	0	1	0	DXE Legacy Option ROM init
C3h	1	1	0	0	0	0	1	1	DXE Reset system
C4h	1	1	0	0	0	1	0	0	DXE USB Hot plug
C5h	1	1	0	0	0	1	0	1	DXE PCI BUS Hot plug
C6h	1	1	0	0	0	1	1	0	DXE NVRAM cleanup
C7h	1	1	0	0	0	1	1	1	DXE ACPI Enable
0h	0	0	0	0	0	0	0	0	Clear POST Code
S3 Resume									
40h	0	1	0	0	0	0	0	0	S3 Resume PEIM (S3 started)
41h	0	1	0	0	0	0	0	1	S3 Resume PEIM (S3 boot script)
42h	0	1	0	0	0	0	1	0	S3 Resume PEIM (S3 Video Repost)
43h	0	1	0	0	0	0	1	1	S3 Resume PEIM (S3 OS wake)
BIOS Recovery									
46h	0	1	0	0	0	1	1	0	PEIM which detected forced Recovery condition
47h	0	1	0	0	0	1	1	1	PEIM which detected User Recovery condition
48h	0	1	0	0	1	0	0	0	Recovery PEIM (Recovery started)
49h	0	1	0	0	1	0	0	1	Recovery PEIM (Capsule found)
4Ah	0	1	0	0	1	0	1	0	Recovery PEIM (Capsule loaded)
E8h	1	1	1	0	1	0	0	0	No Usable Memory Error:
E9h	1	1	1	0	1	0	0	1	Memory is locked by Intel® Trusted Execution Technology and is inaccessible.

Checkpoint	Diagnostic LED Decoder								Description
	1 = LED On, 0 = LED Off								
	Upper Nibble (Amber - Read 1 <sup>st</sup> )				Lower Nibble (Green - Read 2 <sup>nd</sup> )				
	MSB						LSB		
8h	4h	2h	1h	8h	4h	2h	1h		
EAh	1	1	1	0	1	0	1	0	DDR4 Channel Training Error:
EBh	1	1	1	0	1	0	1	1	Memory Test Failure
EDh	1	1	1	0	1	1	0	1	DIMM Configuration/Population Error
EFh	1	1	1	0	1	1	1	1	Indicates a CLTT table structure error
B0h	1	0	1	1	0	0	0	0	Detect DIMM population
B1h	1	0	1	1	0	0	0	1	Set DDR4 frequency
B2h	1	0	1	1	0	0	1	0	Gather remaining SPD data
B3h	1	0	1	1	0	0	1	1	Program registers on the memory controller level
B4h	1	0	1	1	0	1	0	0	Evaluate RAS modes and save rank information
B5h	1	0	1	1	0	1	0	1	Program registers on the channel level
B6h	1	0	1	1	0	1	1	0	Perform the JEDEC defined initialization sequence
B7h	1	0	1	1	0	1	1	1	Train DDR4 ranks
B8h	1	0	1	1	1	0	0	0	Initialize CLTT/OLTT
B9h	1	0	1	1	1	0	0	1	Hardware memory test and init
BAh	1	0	1	1	1	0	1	0	Execute software memory init
BBh	1	0	1	1	1	0	1	1	Program memory map and interleaving
BCh	1	0	1	1	1	1	0	0	Program RAS configuration
BFh	1	0	1	1	1	1	1	1	MRC is done

## Appendix D. POST Code Errors

Most error conditions encountered during POST are reported using **POST Error Codes**. These codes represent specific failures, warnings, or are informational. POST Error Codes may be displayed in the Error Manager Display screen, and are always logged to the System Event Log (SEL). Logged events are available to System Management applications, including Remote and Out of Band (OOB) management.

There are exception cases in early initialization where system resources are not adequately initialized for handling POST Error Code reporting. These cases are primarily Fatal Error conditions resulting from initialization of processors and memory, and they are handled by a Diagnostic LED display with a system halt.

The following table lists the supported POST Error Codes. Each error code is assigned an error type which determines the action the BIOS will take when the error is encountered. Error types include Minor, Major, and Fatal. The BIOS action for each is defined as follows:

- **Minor:** The error message is displayed on the screen or on the Error Manager screen, and an error is logged to the SEL. The system continues booting in a degraded state. The user may want to replace the erroneous unit. The POST Error Pause option setting in the BIOS setup does not have any effect on this error.
- **Major:** The error message is displayed on the Error Manager screen, and an error is logged to the SEL. The POST Error Pause option setting in the BIOS setup determines whether the system pauses to the Error Manager for this type of error so the user can take immediate corrective action or the system continues booting.

Note that for 0048 "Password check failed", the system halts, and then after the next reset/reboot will display the error code on the Error Manager screen.

- **Fatal:** The system halts during post at a blank screen with the text "Unrecoverable fatal error found. System will not boot until the error is resolved" and "Press <F2> to enter setup" The POST Error Pause option setting in the BIOS setup does not have any effect with this class of error.

When the operator presses the **F2** key on the keyboard, the error message is displayed on the Error Manager screen, and an error is logged to the SEL with the error code. The system cannot boot unless the error is resolved. The user needs to replace the faulty part and restart the system.

---

**Note:** The POST error codes in the following table are common to all current generation Intel server platforms. Features present on a given server board/system will determine which of the listed error codes are supported

---

**Table 9. POST Error Messages and Handling**

<b>Error Code</b>	<b>Error Message</b>	<b>Action message</b>	<b>Response</b>
0012	System RTC date/time not set		Major
0048	Password check failed	Please put right password.	Major
0140	PCI component encountered a PERR error		Major
0141	PCI resource conflict		Major
0146	PCI out of resources error	Please enable Memory Mapped I/O above 4 GB item at SETUP to use 64bit MMIO.	Major
0191	Processor core/thread count mismatch detected	Please use identical CPU type.	Fatal
0192	Processor cache size mismatch detected	Please use identical CPU type.	Fatal
0194	Processor family mismatch detected	Please use identical CPU type.	Fatal
0195	Processor Intel(R) UPI link frequencies unable to synchronize		Fatal
0196	Processor model mismatch detected	Please use identical CPU type.	Fatal
0197	Processor frequencies unable to synchronize	Please use identical CPU type.	Fatal
5220	BIOS Settings reset to default settings		Major
5221	Passwords cleared by jumper		Major
5224	Password clear jumper is Set	Recommend to remind user to install BIOS password as BIOS admin password is the master keys for several BIOS security features.	Major
8130	Processor 01 disabled		Major
8131	Processor 02 disabled		Major
8160	Processor 01 unable to apply microcode update		Major
8161	Processor 02 unable to apply microcode update		Major
8170	Processor 01 failed Self Test (BIST)		Major
8171	Processor 02 failed Self Test (BIST)		Major
8180	Processor 01 microcode update not found		Minor
8181	Processor 02 microcode update not found		Minor
8190	Watchdog timer failed on last boot		Major
8198	OS boot watchdog timer failure		Major
8300	Baseboard management controller failed self test		Major
8305	Hot Swap Controller failure		Major
83A0	Management Engine (ME) failed self test		Major
83A1	Management Engine (ME) Failed to respond		Major
84F2	Baseboard management controller failed to respond		Major
84F3	Baseboard management controller in update mode		Major
84F4	Sensor data record empty	Please update right SDR.	Major

Error Code	Error Message	Action message	Response
84FF	System event log full	Please clear SEL through EWS or SELVIEW utility.	Minor
8500	Memory component could not be configured in the selected RAS mode		Major
8501	DIMM Population Error	Please plug DIMM at right population.	Major
8520	CPU1_DIMM_A1 failed test/initialization	Please remove the disabled DIMM.	Major
8521	CPU1_DIMM_A2 failed test/initialization	Please remove the disabled DIMM.	Major
8523	CPU1_DIMM_B1 failed test/initialization	Please remove the disabled DIMM.	Major
8524	CPU1_DIMM_B2 failed test/initialization	Please remove the disabled DIMM.	Major
8526	CPU1_DIMM_C1 failed test/initialization	Please remove the disabled DIMM.	Major
8527	CPU1_DIMM_C2 failed test/initialization	Please remove the disabled DIMM.	Major
8529	CPU1_DIMM_D1 failed test/initialization	Please remove the disabled DIMM.	Major
852A	CPU1_DIMM_D2 failed test/initialization	Please remove the disabled DIMM.	Major
852C	CPU1_DIMM_E1 failed test/initialization	Please remove the disabled DIMM.	Major
852D	CPU1_DIMM_E2 failed test/initialization	Please remove the disabled DIMM.	Major
852F	CPU1_DIMM_F1 failed test/initialization	Please remove the disabled DIMM.	Major
8530	CPU1_DIMM_F2 failed test/initialization	Please remove the disabled DIMM.	Major
8533	CPU1_DIMM_G2 failed test/initialization	Please remove the disabled DIMM.	Major
8538	CPU2_DIMM_A1 failed test/initialization	Please remove the disabled DIMM.	Major
8539	CPU2_DIMM_A2 failed test/initialization	Please remove the disabled DIMM.	Major
853B	CPU2_DIMM_B1 failed test/initialization	Please remove the disabled DIMM.	Major
853C	CPU2_DIMM_B2 failed test/initialization	Please remove the disabled DIMM.	Major
853E	CPU2_DIMM_C1 failed test/initialization	Please remove the disabled DIMM.	Major
853F (Go to 85C0)	CPU2_DIMM_C2 failed test/initialization	Please remove the disabled DIMM.	Major
8540	CPU1_DIMM_A1 disabled	Please remove the disabled DIMM.	Major
8541	CPU1_DIMM_A2 disabled	Please remove the disabled DIMM.	Major
8543	CPU1_DIMM_B1 disabled	Please remove the disabled DIMM.	Major
8544	CPU1_DIMM_B2 disabled	Please remove the disabled DIMM.	Major
8546	CPU1_DIMM_C1 disabled	Please remove the disabled DIMM.	Major
8547	CPU1_DIMM_C2 disabled	Please remove the disabled DIMM.	Major
8549	CPU1_DIMM_D1 disabled	Please remove the disabled DIMM.	Major
854A	CPU1_DIMM_D2 disabled	Please remove the disabled DIMM.	Major
854C	CPU1_DIMM_E1 disabled	Please remove the disabled DIMM.	Major
854D	CPU1_DIMM_E2 disabled	Please remove the disabled DIMM.	Major
854F	CPU1DIMM_F1 disabled	Please remove the disabled DIMM.	Major
8550	CPU1DIMM_F2 disabled	Please remove the disabled DIMM.	Major
8558	CPU2_DIMM_A1 disabled	Please remove the disabled DIMM.	Major
8559	CPU2_DIMM_A2 disabled	Please remove the disabled DIMM.	Major

<b>Error Code</b>	<b>Error Message</b>	<b>Action message</b>	<b>Response</b>
855B	CPU2_DIMM_B1 disabled	Please remove the disabled DIMM.	Major
855C	CPU2_DIMM_B2 disabled	Please remove the disabled DIMM.	Major
855E	CPU2_DIMM_C1 disabled	Please remove the disabled DIMM.	Major
855F (Go to 85D0)	CPU2_DIMM_C2 disabled	Please remove the disabled DIMM.	Major
8560	CPU1_DIMM_A1 encountered a Serial Presence Detection (SPD) failure		Major
8561	CPU1_DIMM_A2 encountered a Serial Presence Detection (SPD) failure		Major
8563	CPU1_DIMM_B1 encountered a Serial Presence Detection (SPD) failure		Major
8564	CPU1_DIMM_B2 encountered a Serial Presence Detection (SPD) failure		Major
8566	CPU1_DIMM_C1 encountered a Serial Presence Detection (SPD) failure		Major
8567	CPU1_DIMM_C2 encountered a Serial Presence Detection (SPD) failure		Major
8569	CPU1_DIMM_D1 encountered a Serial Presence Detection (SPD) failure		Major
856A	CPU1_DIMM_D2 encountered a Serial Presence Detection (SPD) failure		Major
856C	CPU1_DIMM_E1 encountered a Serial Presence Detection (SPD) failure		Major
856D	CPU1_DIMM_E2 encountered a Serial Presence Detection (SPD) failure		Major
856F	CPU1_DIMM_F1 encountered a Serial Presence Detection (SPD) failure		Major
8570	CPU1_DIMM_F2 encountered a Serial Presence Detection (SPD) failure		Major
8578	CPU2_DIMM_A1 encountered a Serial Presence Detection (SPD) failure		Major
8579	CPU2_DIMM_A2 encountered a Serial Presence Detection (SPD) failure		Major
857B	CPU2_DIMM_B1 encountered a Serial Presence Detection (SPD) failure		Major
857C	CPU2_DIMM_B2 encountered a Serial Presence Detection (SPD) failure		Major
857E	CPU2_DIMM_C1 encountered a Serial Presence Detection (SPD) failure		Major
857F (Go to 85E0)	CPU2_DIMM_C2 encountered a Serial Presence Detection (SPD) failure		Major
85C1	CPU2_DIMM_D1 failed test/initialization	Please remove the disabled DIMM.	Major
85C2	CPU2_DIMM_D2 failed test/initialization	Please remove the disabled DIMM.	Major
85C4	CPU2_DIMM_E1 failed test/initialization	Please remove the disabled DIMM.	Major
85C5	CPU2_DIMM_E2 failed test/initialization	Please remove the disabled DIMM.	Major



Error Code	Error Message	Action message	Response
85C7	CPU2_DIMM_F1 failed test/initialization	Please remove the disabled DIMM.	Major
85C8	CPU2_DIMM_F2 failed test/initialization	Please remove the disabled DIMM.	Major
85D1	CPU2_DIMM_D1 disabled	Please remove the disabled DIMM.	Major
85D2	CPU2_DIMM_D2 disabled	Please remove the disabled DIMM.	Major
85D4	CPU2_DIMM_E1 disabled	Please remove the disabled DIMM.	Major
85D5	CPU2_DIMM_E2 disabled	Please remove the disabled DIMM.	Major
85D7	CPU2_DIMM_F1 disabled	Please remove the disabled DIMM.	Major
85D8	CPU2_DIMM_F2 disabled	Please remove the disabled DIMM.	Major
85E0	CPU2_DIMM_C3 encountered a Serial Presence Detection (SPD) failure		Major
85E1	CPU2_DIMM_D1 encountered a Serial Presence Detection (SPD) failure		Major
85E2	CPU2_DIMM_D2 encountered a Serial Presence Detection (SPD) failure		Major
85E4	CPU2_DIMM_E1 encountered a Serial Presence Detection (SPD) failure		Major
85E5	CPU2_DIMM_E2 encountered a Serial Presence Detection (SPD) failure		Major
85E7	CPU2_DIMM_F1 encountered a Serial Presence Detection (SPD) failure		Major
85E8	CPU2_DIMM_F2 encountered a Serial Presence Detection (SPD) failure		Major
8604	POST Reclaim of non-critical NVRAM variables		Minor
8605	BIOS Settings are corrupted		Major
8606	NVRAM variable space was corrupted and has been reinitialized		Major
8607	Recovery boot has been initiated.	Note: The Primary BIOS image may be corrupted or the system may hang during POST. A BIOS update is required.	Fatal
92A3	Serial port component was not detected		Major
92A9	Serial port component encountered a resource conflict error		Major
A000	TPM device not detected		Minor
A001	TPM device missing or not responding		Minor
A002	TPM device failure		Minor
A003	TPM device failed self-test		Minor
A100	BIOS ACM Error		Major
A421	PCI component encountered a SERR error		Fatal
A5A0	PCI Express component encountered a PERR error		Minor
A5A1	PCI Express component encountered an SERR error		Fatal

Error Code	Error Message	Action message	Response
A6A0	DXE Boot Services driver: Not enough memory available to shadow a Legacy Option ROM	Please disable OpRom at SETUP to save runtime memory.	Minor

## POST Error Beep Codes

The following table lists the POST error beep codes. Prior to system video initialization, the BIOS uses these beep codes to inform users on error conditions. The beep code is followed by a user-visible code on the POST Progress LEDs.

**Table 10. POST Error Beep Codes**

Beeps	Error Message	POST Progress Code	Description
1	USB device action	N/A	Short beep sounded whenever USB device is discovered in POST, or inserted or removed during runtime.
1 long	Intel® TXT security violation	0xAE, 0xAF	System halted because Intel® Trusted Execution Technology detected a potential violation of system security.
3	Memory error	Multiple	System halted because a fatal error related to the memory was detected.
3 long and 1	CPU mismatch error	0xE5, 0xE6	System halted because a fatal error related to the CPU family/core/cache mismatch was detected.
The following Beep Codes are sounded during BIOS Recovery.			
2	Recovery started	N/A	Recovery boot has been initiated.
4	Recovery failed	N/A	Recovery has failed. This typically happens so quickly after recovery is initiated that it sounds like a 2-4 beep code.

The Integrated BMC may generate beep codes upon detection of failure conditions. Beep codes are sounded each time the problem is discovered, such as on each power-up attempt, but are not sounded continuously. Codes that are common across all Intel server boards and systems that use same generation chipset are listed in the following table. Each digit in the code is represented by a sequence of beeps whose count is equal to the digit.

**Table 11. Integrated BMC Beep Codes**

Code	Reason for Beep	Associated Sensors
1-5-1-2	VR Watchdog Timer sensor assertion	VR Watchdog Timer
1-5-1-4	The system does not power on or unexpectedly power off and a power supply unit (PSU) is present that is an incompatible model with one or more other PSUs in the system	PS Status
1-5-2-1	No CPUs installed or first CPU socket is empty	CPU Missing Sensor
1-5-2-2	CPU CAT Error (IERR) assertion	CPU ERR2 Timeout Sensor
1-5-2-3	CPU ERR2 timeout assertion	CPU ERR2 Timeout Sensor
1-5-2-4	CPU Icc max Mismatch	CPU Icc max Mismatch Sensor
1-5-2-5	CPU population error	CPU 0 Status Sensor
1-5-4-2	Power fault: DC power is unexpectedly lost (power good dropout).	Power unit – power unit failure offset
1-5-4-4	Power control fault (power good assertion timeout).	Power unit – soft power control failure offset

