

TS300-E10-PS4

Server User Guide



E14239
First Edition
July 2018

Copyright © 2018 ASUSTeK COMPUTER INC. All Rights Reserved.

No part of this manual, including the products and software described in it, may be reproduced, transmitted, transcribed, stored in a retrieval system, or translated into any language in any form or by any means, except documentation kept by the purchaser for backup purposes, without the express written permission of ASUSTeK COMPUTER INC. ("ASUS").

ASUS provides this manual "as is" without warranty of any kind, either express or implied, including but not limited to the implied warranties or conditions of merchantability or fitness for a particular purpose. In no event shall ASUS, its directors, officers, employees, or agents be liable for any indirect, special, incidental, or consequential damages (including damages for loss of profits, loss of business, loss of use or data, interruption of business and the like), even if ASUS has been advised of the possibility of such damages arising from any defect or error in this manual or product.

Specifications and information contained in this manual are furnished for informational use only, and are subject to change at any time without notice, and should not be construed as a commitment by ASUS. ASUS assumes no responsibility or liability for any errors or inaccuracies that may appear in this manual, including the products and software described in it.

Product warranty or service will not be extended if: (1) the product is repaired, modified or altered, unless such repair, modification or alteration is authorized in writing by ASUS; or (2) the serial number of the product is defaced or missing.

Products and corporate names appearing in this manual may or may not be registered trademarks or copyrights of their respective companies, and are used only for identification or explanation and to the owners' benefit, without intent to infringe.

Contents

Safety information.....	vii
About this guide.....	viii

Chapter 1: Product Introduction

1.1	System package contents.....	1-2
1.2	Serial number label.....	1-3
1.3	System specifications	1-4
1.4	Front panel features.....	1-6
1.5	Rear panel features.....	1-7
1.6	Internal features	1-8
1.7	LED information	1-9
1.7.1	Front panel LEDs.....	1-9
1.7.2	LAN (RJ-45) LEDs	1-10

Chapter 2: Hardware Information

2.1	Chassis cover.....	2-2
2.1.1	Removing the side cover.....	2-2
2.1.2	Reinstalling the side cover	2-3
2.2	Central Processing Unit (CPU)	2-4
2.2.1	Installing the CPU	2-4
2.2.2	Installing the CPU heatsink.....	2-7
2.2.3	Uninstalling the CPU heatsink and fan.....	2-8
2.3	System memory	2-9
2.3.1	Overview	2-9
2.3.2	Memory configurations.....	2-9
2.3.3	Installing a DIMM on a single clip DIMM socket.....	2-10
2.3.4	Removing a DIMM from a single clip DIMM socket	2-10
2.4	Front panel assembly	2-11
2.4.1	Removing the front panel assembly.....	2-11
2.4.2	Reinstalling the front panel assembly	2-11
2.5	SATA/SAS hard disk drives	2-12
2.5.1	Removing the HDD module cage.....	2-12
2.5.2	Installing the HDD module cage.....	2-13
2.5.3	Removing the backplane.....	2-14
2.5.4	Installing a hot-swap SATA/SAS hard disk drive	2-14
2.6	5.25-inch drives.....	2-17
2.6.1	Installing a 5.25-inch drive	2-17

Contents

- 2.7 Expansion slots.....2-18**
 - 2.7.1 Installing an expansion card.....2-18
 - 2.7.2 Installing an ASUS PIKE II card.....2-20
 - 2.7.3 Configuring an expansion card2-22
 - 2.7.4 Installing an M.2 expansion card.....2-24
- 2.8 Cable connections2-26**
 - 2.8.1 Motherboard connections.....2-26
 - 2.8.2 SATA/SAS backplane cabling.....2-27
- 2.9 Removable components.....2-29**
 - 2.9.1 System fans2-29
 - 2.9.2 Chassis footpads.....2-31

Chapter 3: Installation Options

- 3.1 Preparing the system for rack mounting.....3-2**
- 3.2 Attaching the inner rail to the server3-2**
- 3.3 Attaching the rails to the rack.....3-3**
- 3.4 Mounting the server to the rack.....3-4**

Chapter 4: Motherboard Information

- 4.1 Motherboard layout.....4-2**
- 4.2 Onboard LEDs.....4-5**
- 4.3 Jumpers4-8**
- 4.4 Internal connectors.....4-12**

Chapter 5: BIOS Setup

- 5.1 Managing and updating your BIOS.....5-2**
 - 5.1.1 ASUS CrashFree BIOS 3 utility.....5-2
 - 5.1.2 ASUS EZ Flash Utility5-3
 - 5.1.3 BUPDATER utility5-4
- 5.2 BIOS setup program5-6**
 - 5.2.1 BIOS menu screen.....5-7
 - 5.2.2 Menu bar5-7
 - 5.2.3 Menu items.....5-8
 - 5.2.4 Submenu items5-8
 - 5.2.5 Navigation keys.....5-8
 - 5.2.6 General help.....5-8
 - 5.2.7 Configuration fields5-8
 - 5.2.8 Pop-up window.....5-8
 - 5.2.9 Scroll bar.....5-8

Contents

5.3	Main menu	5-9
5.4	Advanced menu	5-10
5.4.1	Rework Configuration.....	5-11
5.4.2	CPU Configuration	5-11
5.4.3	Power & Performance.....	5-13
5.4.4	Server ME Configuration.....	5-15
5.4.5	Trusted Computing.....	5-15
5.4.6	APM Configuration	5-16
5.4.7	Runtime Error Logging Settings.....	5-16
5.4.8	Onboard LAN Configuration.....	5-17
5.4.9	Serial Port Console Redirection.....	5-18
5.4.10	Intel TXT Information.....	5-20
5.4.11	PCI Subsystem Settings	5-21
5.4.12	USB Configuration	5-22
5.4.13	Network Stack Configuration.....	5-23
5.4.14	CSM Configuration.....	5-24
5.4.15	NVMe Configuration.....	5-25
5.4.16	WHEA Configuration	5-25
5.4.17	Tls Auth Configuration.....	5-25
5.4.18	iSCSI Configuration	5-26
5.5	Chipset menu	5-27
5.5.1	System Agent (SA) Configuration	5-27
5.5.2	PCH-IO Configuration	5-29
5.6	Security menu	5-32
5.7	Boot menu	5-35
5.8	Monitor menu	5-37
5.9	Tool menu	5-38
5.10	Event Logs menu	5-38
5.10.1	Change Smbios Event Log Settings	5-38
5.10.2	View Smbios Event Log	5-39
5.11	Server Mgmt menu	5-40
5.11.1	System Event Log.....	5-41
5.11.2	Bmc self test log.....	5-42
5.11.3	BMC network configuration.....	5-43
5.11.4	View System Event Log.....	5-44
5.11.5	BMC User Settings.....	5-44
5.12	Save & Exit menu	5-45

Contents

Chapter 6: RAID Configuration

6.1	Setting up RAID	6-2
6.1.1	RAID definitions	6-2
6.1.2	Installing hard disk drives.....	6-3
6.1.3	Setting the RAID item in BIOS	6-3
6.2	Intel® Rapid Storage Technology enterprise SATA Option ROM Utility	6-4
6.2.1	Creating a RAID set.....	6-5
6.2.2	Deleting a RAID set.....	6-7
6.2.3	Resetting disks to Non-RAID	6-8
6.2.4	Exiting the Intel® Rapid Storage Technology enterprise SATA Option ROM utility.....	6-9
6.2.5	Rebuilding the RAID.....	6-9
6.2.6	Setting the Boot array in the BIOS Setup Utility.....	6-11
6.3	Intel® Rapid Storage Technology enterprise (Windows)	6-12
6.3.1	Creating a RAID set.....	6-13
6.3.2	Changing a Volume Type.....	6-15
6.3.3	Deleting a volume	6-16
6.3.4	Preferences.....	6-17

Chapter 7: Driver Installation

7.1	RAID driver installation	7-2
7.1.1	Creating a USB flash drive with RAID drive.....	7-2
7.1.2	Installing the RAID controller driver.....	7-2
7.2	Management applications and utilities installation	7-5
7.3	Running the Support DVD	7-5
7.4	Installing the system drivers	7-6

Appendix

P11C-E/4L block diagram	A-2
Q-Code table	A-3
Notices	A-6
REACH	A-7
Australia statement notice.....	A-7
ASUS contact information	A-8

Safety information

Electrical Safety

- Before installing or removing signal cables, ensure that the power cables for the system unit and all attached devices are unplugged.
- To prevent electrical shock hazard, disconnect the power cable from the electrical outlet before relocating the system.
- When adding or removing any additional devices to or from the system, ensure that the power cables for the devices are unplugged before the signal cables are connected. If possible, disconnect all power cables from the existing system before you add a device.
- If the power supply is broken, do not try to fix it by yourself. Contact a qualified service technician or your dealer.

Operation Safety

- Any mechanical operation on this server must be conducted by certified or experienced engineers.
- Before operating the server, carefully read all the manuals included with the server package.
- Before using the server, ensure all cables are correctly connected and the power cables are not damaged. If any damage is detected, contact your dealer as soon as possible.
- To avoid short circuits, keep paper clips, screws, and staples away from connectors, slots, sockets and circuitry.
- Avoid dust, humidity, and temperature extremes. Place the server on a stable surface.



This product is equipped with a three-wire power cable and plug for the user's safety. Use the power cable with a properly grounded electrical outlet to avoid electrical shock.

Lithium-Ion Battery Warning

CAUTION! Danger of explosion if battery is incorrectly replaced. Replace only with the same or equivalent type recommended by the manufacturer. Dispose of used batteries according to the manufacturer's instructions.

CLASS 1 LASER PRODUCT

Heavy System

CAUTION! This server system is heavy. Ask for assistance when moving or carrying the system.

About this guide

Audience

This user guide is intended for system integrators, and experienced users with at least basic knowledge of configuring a server.

Contents

This guide contains the following parts:

1. **Chapter 1: Product Introduction**

This chapter describes the general features of the server, including sections on front panel and rear panel specifications.

2. **Chapter 2: Hardware Information**

This chapter lists the hardware setup procedures that you have to perform when installing or removing system components.

3. **Chapter 3: Installation Options**

This chapter describes how to install optional components into the barebone server.

4. **Chapter 4: Motherboard Information**

This chapter gives information about the motherboard that comes with the server. This chapter includes the motherboard layout, jumper settings, and connector locations.

5. **Chapter 5: BIOS Setup**

This chapter tells how to change system settings through the BIOS Setup menus and describes the BIOS parameters.

6. **Chapter 6: RAID Configuration**

This chapter tells how to change system settings through the BIOS Setup menus. Detailed descriptions of the BIOS parameters are also provided.

7. **Chapter 7: Driver Installation**

This chapter provides instructions for installing the necessary drivers for different system components.

Conventions

To ensure that you perform certain tasks properly, take note of the following symbols used throughout this manual.



DANGER/WARNING: Information to prevent injury to yourself when trying to complete a task.



CAUTION: Information to prevent damage to the components when trying to complete a task.



IMPORTANT: Instructions that you **MUST** follow to complete a task.



NOTE: Tips and additional information to help you complete a task.

Typography

Bold text

Indicates a menu or an item to select.

Italics

Used to emphasize a word or a phrase.

<Key>

Keys enclosed in the less-than and greater-than sign means that you must press the enclosed key.

Example: <Enter> means that you must press the Enter or Return key.

<Key1>+<Key2>+<Key3>

If you must press two or more keys simultaneously, the key names are linked with a plus sign (+).

Example: <Ctrl>+<Alt>+

Command

Means that you must type the command exactly as shown, then supply the required item or value enclosed in brackets.

Example: At the DOS prompt, type the command line: **format A:/S**

References

Refer to the following sources for additional information, and for product and software updates.

1. **ASUS Control Center (ACC) user guide**

This manual tells how to set up and use the proprietary ASUS server management utility.

2. **ASUS websites**

The ASUS websites worldwide provide updated information for all ASUS hardware and software products. Refer to the ASUS contact information.

Product Introduction

1

This chapter describes the motherboard features and the new technologies it supports.

1.1 System package contents

Check your system package for the following items.

Model Name	TS300-E10-PS4
Chassis	ASUS T50D Pedestal / 5U Rackmount Chassis
Motherboard	ASUS P11C-E/4L Server Board
Component	1 x 500W Gold Single Power Supply
	4 x Hot-swap storage trays*
	1 x SAS/SATA Backplane (BP4LX12G-35-T50D) with 1 x MiniSAS HD Cable
	1 x Front I/O Board (FPB-TRS8A)
Accessories	2 x System Fan (Rear: 1 x 120mm x 38mm; Front: 1 x 80mm x 25mm)
	1 x Support DVD (including the User Guide)
	1 x ASUS Control Center (ACC) Enterprise DVD
	1 x Bag of Screws
	1 x AC Power Cable
Optional Items	1 x CPU Heatsink
	1 x ASMB9-iKVM Remote management card
	1 x DVD-ROM / DVD-RW
	1 x Ball Bearing Rail Kit
	1 x 4 bay HDD Module Cage (2nd set)
	1 x ASUS PIKE II RAID Card

* Four hot-swap 3.5-inch HDDs are supported by default. Upgrade the optional ASUS PIKE II card before using eight hot-swap 3.5-inch HDDs.



If any of the above items is damaged or missing, contact your retailer.

1.2 Serial number label

Before requesting support from the ASUS Technical Support team, you must take note of the product's serial number containing 12 characters such as xxS0xxxxxxx shown as the figure below. With the correct serial number of the product, ASUS Technical Support team members can then offer a quicker and satisfying solution to your problems.



1.3 System specifications

The ASUS TS300-E10-PS4 is a Pedestal / 5U Rackmount barebone server system featuring the ASUS P11C-E/4L Server Board. The server supports LGA1151 Intel® Xeon® Coffee Lake Processor plus other latest technologies through the chipsets onboard.

Model Name		TS300-E10-PS4
Processor Support / System Bus		1 x Socket LGA1151 Intel® Xeon® processor E-21xxx product family Intel® Core™ i3 processors Intel® Pentium™ processors Intel® Celeron™ processors
Core Logic		Intel® C246 Chipset
Memory	Total Slots	4 (2-Channel per CPU, 4 DIMM per CPU)
	Capacity	Maximum up to 64GB (UDIMM)
	Memory Type	DDR4-2666 ECC/non-ECC UDIMM Refer to www.asus.com for the latest memory AVL update.
	Memory Size	16GB, 8GB, 4GB (UDIMM) Refer to www.asus.com for the latest memory AVL update.
Expansion Slots (follow SSI Location #)	Total Slots	4+1
	Slot Type	1 x PCI-E x16 slot (Gen3 x16/x8 link) 1 x PCI-E x8 slot (Gen3 x8 link) 1 x PCI-E x8 slot (Gen3 x4 link) 1 x PCI slot 1 x MIO slot for Audio Card with PCI-E x1 slot (Gen3 x1 link)
Storage	SATA Controller	Intel® C246: 8 x SATA 6Gb/s ports Intel® RSTe (For Windows and Linux) (Support software RAID 0, 1, 10 & 5)
	SAS Controller	RAID card (optional): ASUS PIKE II 3008-8i 8-port SAS 12Gb/s RAID card ASUS PIKE II 3108-8i/16PD/1G 8-port SAS 12Gb/s RAID card ASUS PIKE II 3108-8i/16PD/2G 8-port SAS 12Gb/s RAID card
Storage Bays	I = internal A or S = hot-swappable	4 x Hot-swap 3.5" storage bays
Networking	LAN	4 x Intel® I210AT 1 x Mgmt LAN
Graphic	VGA	Aspeed AST2500 64MB

(continued on the next page)

Model Name		TS300-E10-PS4
Auxiliary Storage Device Bay (Floppy / Optical Drive) (optional)		4 x 5.25" media bay (Options: No ODD/DVD-RW) (DVD-RW default for North America)
Front I/O Ports		2 x USB 3.0 ports 2 x USB 2.0 ports
Rear I/O Ports		5 x RJ-45 ports (One for ASMB9-iKVM) 2 x USB 3.1 ports 2 x USB 3.0 ports 1 x internal Type A USB port 1 x VGA port 1 x COM port
Switch/LED		Front LED: 1 x Power LED 1 x Location LED 1 x HDD Access LED 1 x Message LED LAN 1-4 LED
OS Support		Windows® Server 2016 Windows® 10 64-bit RS3 RedHat® Enterprise Linux 7.4 Server Edition RedHat® Enterprise Linux 7.3 Server Edition RedHat® Enterprise Linux 6.9 Server Edition CentOS 7.4 (1708) / Scientific Linux 7.4 CentOS 7.3 (1611) / Scientific Linux 7.3 CentOS 6.9 / Scientific Linux 6.9 * Support versions are subject to change without notice. Refer to www.asus.com for updates.
Management Solution	Software	ACC
	Out of Band Remote Management	Optional ASMB9-iKVM for KVM-over-IP support
Regulatory Compliance		BSMI, CE, CCC
Dimensions (HH x WW x DD)		445mm x 217.5mm x 545mm (17.91" x 8.54" x 21.45")
Net Weight Kg (CPU, DRAM & HDD not included)		20 Kg
Power Supply and Rating		500W Single Gold Power Supply Rating: 100-240V, 7-3.5A, 50/60Hz, Class I
Environment		Operation temperature: 10° ~ 40° Non operation temperature: -40° ~ 70° Non operation humidity: 20% ~ 90% (Non condensing)

*Specifications are subject to change without notice.

1.4 Front panel features

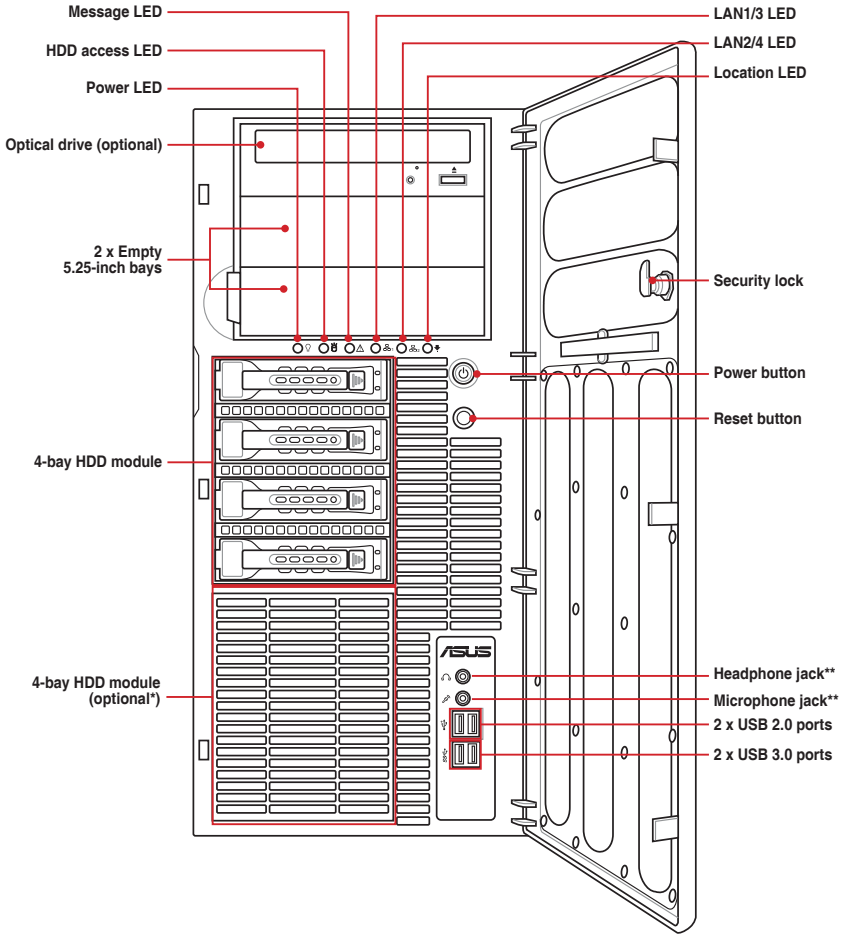

- Refer to the **1.7.1 Front panel LEDs** section for the LED descriptions.
- * Upgrade the optional ASUS PIKE II card before using eight hot-swap 3.5-inch HDDs.
- ** The function of front panel audio I/O ports is available only when the MIO card is installed.

1.5 Rear panel features

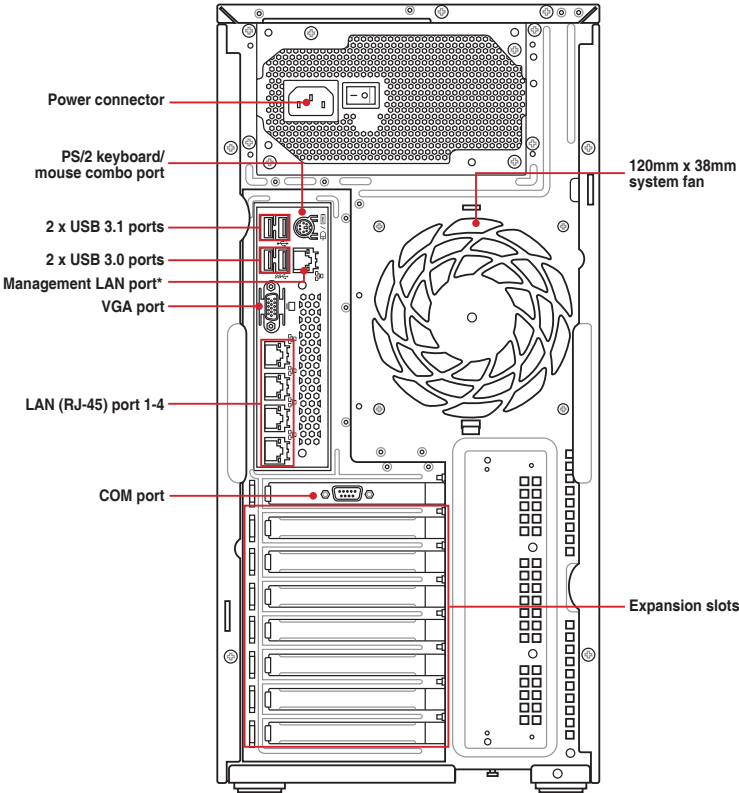

* This port is for ASUS ASMB9-iKVM controller and for technicians only.

1.6 Internal features

The barebone server includes the basic components as shown.

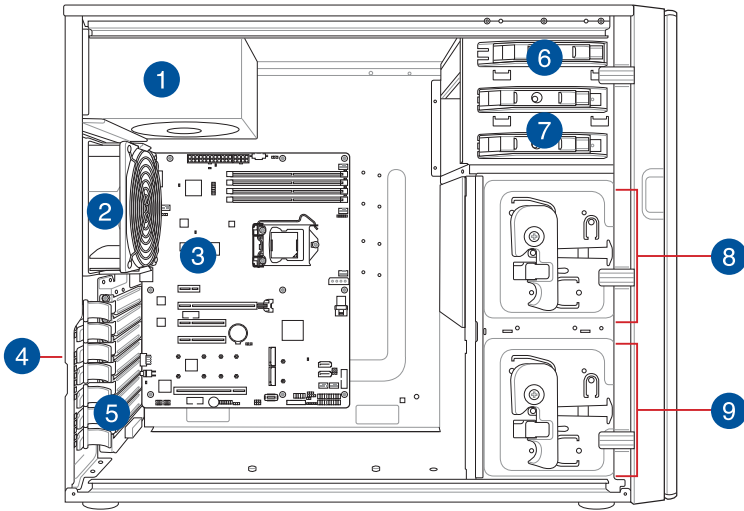

1. 500W Gold Single Power Supply
2. 120mm x 38mm system fan
3. ASUS P11C-E/4L Server Board
4. Chassis intrusion switch
5. Expansion card locks
6. Optical drive (optional)
7. 2 x 5.25-inch drive bays
8. 4-bay HDD module (First set with backplane)
9. 4-bay HDD module (Second set with backplane) (optional)



Turn off the system power and detach the power supply before removing or replacing any system component.









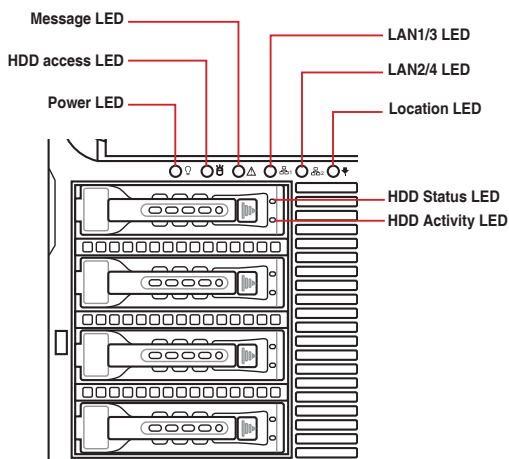

The barebone server does not include a floppy disk drive. Connect a USB floppy disk drive to any of the USB ports on the front or rear panel if you need to use a floppy disk.

WARNING
HAZARDOUS MOVING PARTS
KEEP FINGERS AND OTHER BODY PARTS AWAY

1.7 LED information

1.7.1 Front panel LEDs



LED	Icon	Display status	Description
Power LED		ON	System power ON
HDD Access LED		OFF	No activity
		Blinking	Read/write data into the HDD
Message LED		OFF	System is normal; no incoming event
		ON	A hardware temperature overheat is detected. Use ASUS Control Center (ACC) to check the abnormal status.
LAN LEDs	 	OFF	No LAN connection
		Blinking	LAN is transmitting or receiving data
HDD Status LED		ON	LAN connection is present
		OFF	Good condition
		Red	RAID failure
HDD Activity LED		Blinking	RAID rebuilding
		OFF	No HDD present
		Green	HDD present
		Blinking	Read / Write data into the HDD



The Power LED, HDD Status LED and Message LED are visible even if the system front bezel is closed.

1.7.2 LAN (RJ-45) LEDs

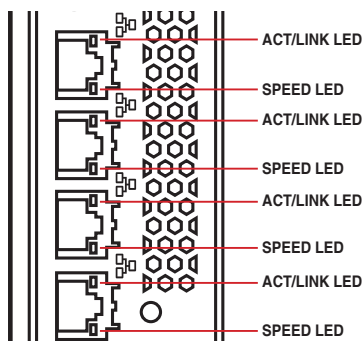

LAN1/LAN2 LEDs

ACT/LINK LED		SPEED LED	
Status	Description	Status	Description
OFF	No link	OFF	10 Mbps connection
GREEN	Linked	YELLOW	100 Mbps connection
BLINKING	Data activity	GREEN	1 Gbps connection

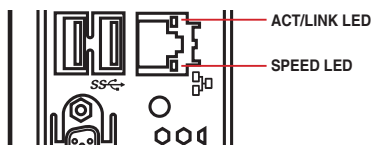

Dedicated Management LAN LEDs (for ASUS ASMB9-iKVM and DM_LAN1)

ACT/LINK LED		SPEED LED	
Status	Description	Status	Description
OFF	No link	OFF	10 Mbps connection
YELLOW	Linked	ORANGE	100 Mbps connection
BLINKING	Data activity	GREEN	1 Gbps connection

Hardware Information

2

This chapter lists the hardware setup procedures that you have to perform when installing or removing system components.

2.1 Chassis cover

2.1.1 Removing the side cover



-
- Ensure that you unplug the power cord before removing the side cover.
 - Take extra care when removing the side cover. Keep your fingers from components inside the chassis that can cause injury, such as the CPU fan, rear fan, and other sharp-edged parts.
-

To remove the side cover:

1. Remove the two screws that secure the side cover.
2. Slide the side cover for about half an inch toward the rear until it is disengaged from the chassis.
3. Carefully lift the side cover and set it aside.

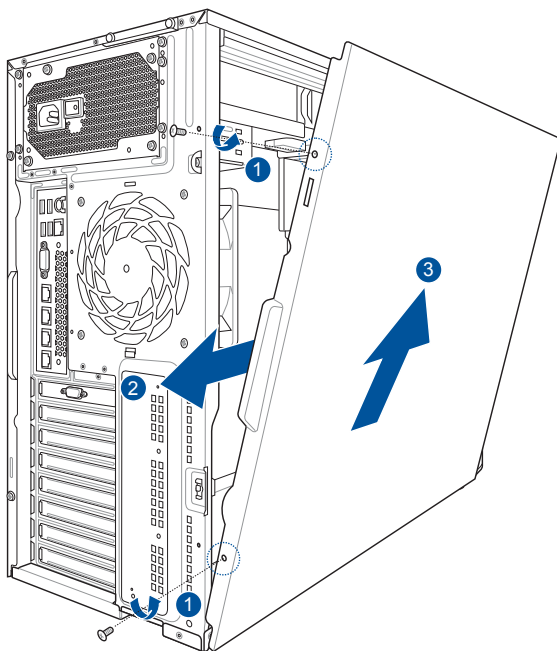

2.1.2 Reinstalling the side cover

To reinstall the side cover:

1. Match and insert the lower sliding edge of the side cover to the corresponding chassis edge.
2. Slide the side cover toward the front panel until it snaps in place.
3. Drive in the two screws you removed earlier to secure the side cover.

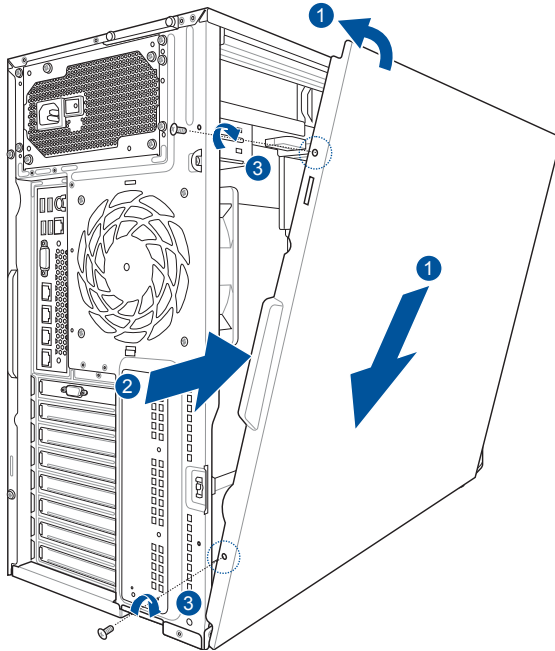

2.2 Central Processing Unit (CPU)

The motherboard comes with a surface mount LGA 1151 socket designed for the Intel® Xeon® E-2100; I3-8100; Pentium G5000; Celeron G4900 product family processor.



- Upon purchase of the server system, ensure that the PnP cap is on the socket and the socket contacts are not bent. Contact your retailer immediately if the PnP cap is missing, or if you see any damage to the PnP cap/socket contacts/motherboard components.
- The product warranty does not cover damage to the socket contacts resulting from incorrect CPU installation/removal, or misplacement/loss/incorrect removal of the PnP cap.

2.2.1 Installing the CPU

To install a CPU:

1. Locate the CPU socket on the motherboard.

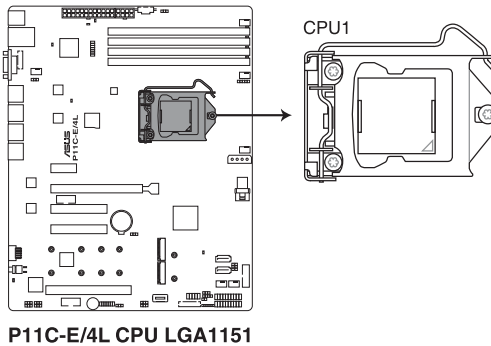

Before installing the CPU, ensure that the socket box is facing toward you and the triangle mark is on the top-right position.

2. Press the load lever with your thumb (A), then move it to the right (B) until it is released from the retention tab.



Do not remove the PnP cap yet from the CPU socket. Doing so may bend the pins of the socket.

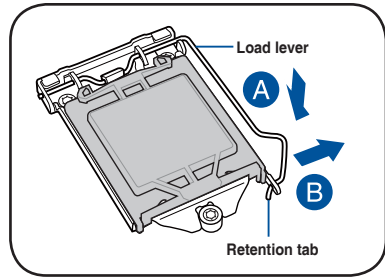

3. Lift the load lever until the load plate is completely lifted.

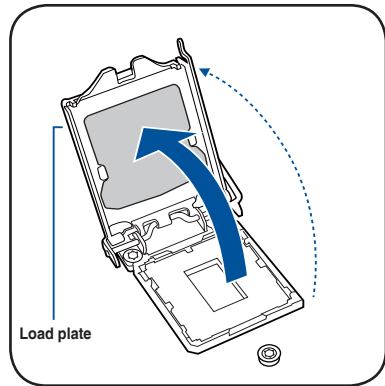

4. Position the CPU above the socket, ensuring that the gold triangle mark is on the bottom-left corner of the socket, then fit the CPU notches to the socket's alignment keys.



The CPU fits in only one orientation. DO NOT force the CPU into the socket to prevent bending the pins on the socket and damaging the CPU.

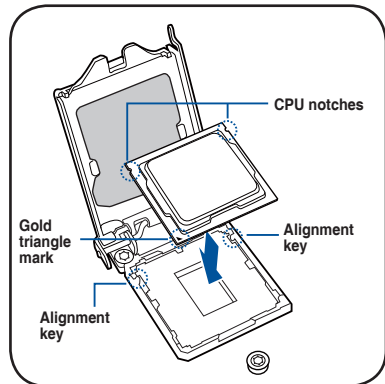

5. Close the load plate (A), ensuring that the front edge of the load plate slides under the retention lock (B) then push down the load lever (C).

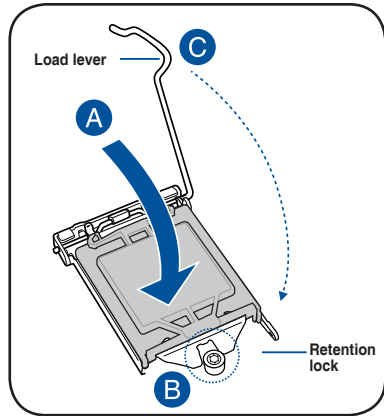

6. Insert the load lever under the retention tab to remove the PnP cap from the CPU socket.

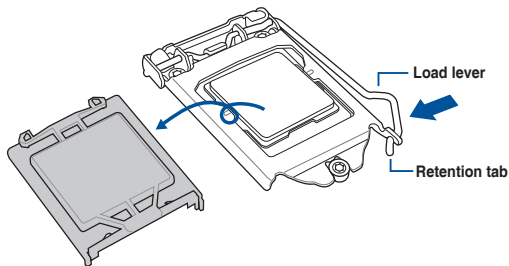

7. Apply some Thermal Interface Material to the exposed area of the CPU that the heatsink will be in contact with, ensuring that it is evenly spread in a thin layer.



Some heatsinks come with pre-applied Thermal Interface Material. If so, skip this step.



The Thermal Interface Material is toxic and inedible. DO NOT eat it. If it gets into your eyes or touches your skin, wash it off immediately and seek professional medical help.

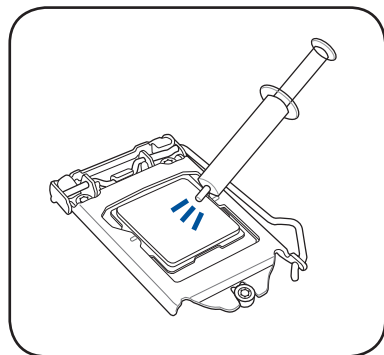

2.2.2 Installing the CPU heatsink

The Intel® LGA1151 processor requires a specially designed CPU heatsink to ensure optimum thermal condition and performance.



- When you buy a boxed Intel® processor, a specially designed CPU heatsink or a CPU heatsink with a CPU fan assembly is included depending on the package. If you buy a CPU separately, ensure that you use only Intel® certified multi-directional CPU heatsink with CPU fan.
- Use an LGA1151-compatible CPU heatsink and CPU fan assembly only. The LGA1151 socket is incompatible with the LGA775 and LGA1366 sockets in size and dimension.



If you purchased a separate CPU heatsink and fan assembly, ensure that the Thermal Interface Material is properly applied to the CPU heatsink or CPU before you install the heatsink and fan assembly.



Ensure that you have installed the motherboard to the chassis before you install the CPU fan and heatsink assembly.

To install the CPU heatsink and fan:

1. Place the heatsink on top of the installed CPU, making sure that the four fasteners match the holes on the motherboard.
2. Push down two fasteners at a time in a diagonal sequence to secure the heatsink and fan assembly in place.

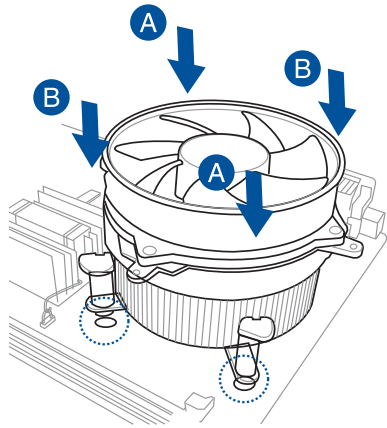
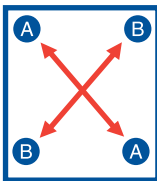

Orient the heatsink and fan assembly such that the CPU fan cable is closest to the CPU fan connector.

3. Connect the CPU fan cable to the connector on the motherboard labeled CPU_FAN1.

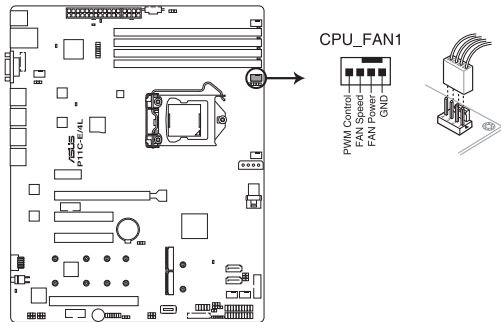

P11C-E/4L CPU fan connector



DO NOT forget to connect the CPU fan connector! Hardware monitoring errors can occur if you fail to plug this connector.

2.2.3 Uninstalling the CPU heatsink and fan

To uninstall the CPU fan and fan:

1. Disconnect the CPU fan cable from the connector on the motherboard.
2. Rotate each fastener counterclockwise.
3. Pull up two fasteners at a time in a diagonal sequence to disengage the heatsink and fan assembly from the motherboard.

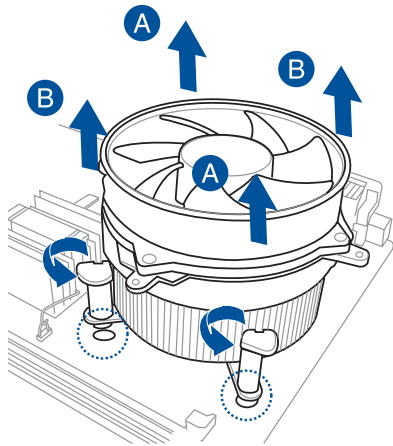
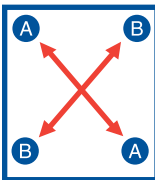

4. Carefully remove the heatsink and fan assembly from the motherboard.

2.3 System memory

2.3.1 Overview

The motherboard comes with four Double Data Rate 4 (DDR4) Dual Inline Memory Modules (DIMM) sockets.



A DDR4 module is notched differently from a DDR, DDR2, or DDR3 module. DO NOT install a DDR, DDR2, or DDR3 memory module to the DDR4 slot.

The figure illustrates the location of the DDR4 DIMM sockets:

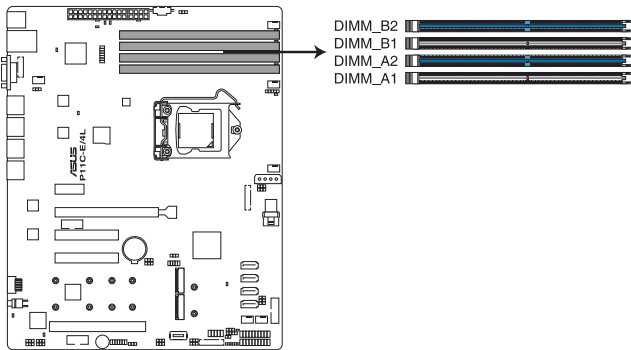

P11C-E/4L 288-pin DDR4 DIMM sockets

2.3.2 Memory configurations

You may install Unbuffered DDR4 DIMMs into the DIMM sockets using the memory configurations in this section.

UDIMM				
DIMM Slot Per Channel	DIMM Populated per Channel	DIMM Type	Speed	Rank per DIMM
2	1	Unbuffered DDR4	2666	Single Rank, Dual Rank
2	2	Unbuffered DDR4	2666	Single Rank, Dual Rank



- Always install DIMMs with the same CAS latency. For optimum compatibility, it is recommended that you obtain memory modules from the same vendor.
- Start installing the DIMMs in slots A2 and B2 (Blue).

2.3.3 Installing a DIMM on a single clip DIMM socket

1. Press the retaining clip outward to unlock the DIMM socket.
2. Align a DIMM on the socket such that the notch on the DIMM matches the DIMM slot key on the socket.

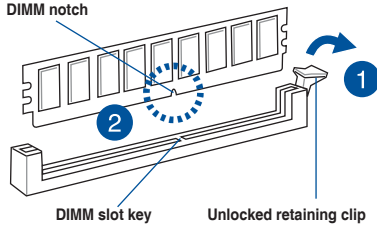

A DIMM is keyed with a notch so that it fits in only one direction. DO NOT force a DIMM into a socket in the wrong direction to avoid damaging the DIMM.

3. Hold the DIMM at both ends then insert the DIMM into the socket. Apply force to both ends of the DIMM simultaneously until the retaining clip clicks into place and the DIMM is seated securely in place.

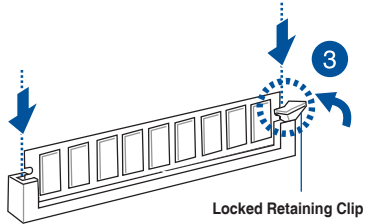

Always insert the DIMM into the socket VERTICALLY to prevent DIMM notch damage.



- To install two or more DIMMs, refer to the user guide bundled with the motherboard package.
- Refer to the user guide for qualified vendor lists of the memory modules.

2.3.4 Removing a DIMM from a single clip DIMM socket

1. Press the retaining clip outward to unlock the DIMM.
2. Remove the DIMM from the socket.

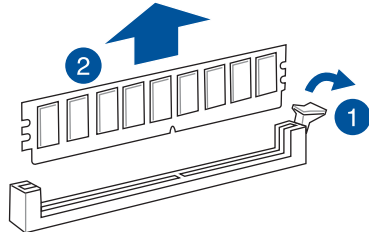

Support the DIMM lightly with your fingers when pressing the retaining clips. The DIMM might get damaged when it flips out with extra force.

2.4 Front panel assembly

Before you can install a 5.25-inch drive, you should first remove the front panel assembly (front bezel and front panel cover).

2.4.1 Removing the front panel assembly

To remove the front panel assembly:

1. Locate the three hooked tabs on the chassis side rail.
2. Shift the hooked tabs and take off the front bezel.

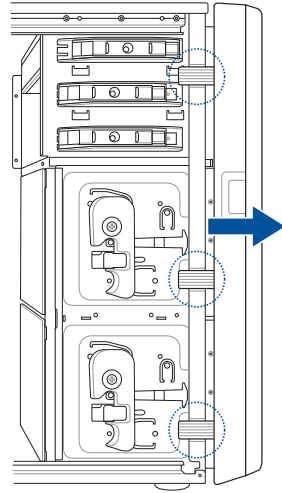

2.4.2 Reinstalling the front panel assembly

To reinstall the front panel assembly:

1. Hook the other side of the front panel assembly to the chassis.
2. Swing the front panel assembly and snap it back into place.

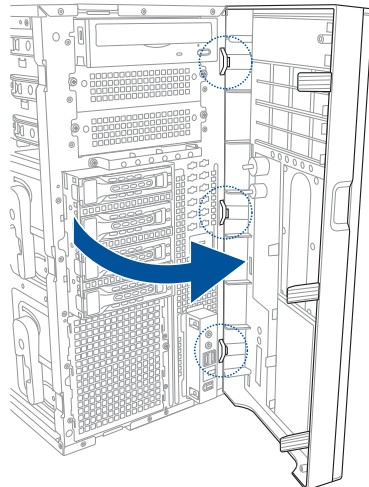

2.5 SATA/SAS hard disk drives

The system comes with two sets of hard disk drive modules. The first set is defaulted and the second set is optional. Each hard disk drive module, including externally removable trays for mounting four hot-swap SATA/SAS hard disk drives, allows you to access the drive trays by simply opening the front bezel.



An HDD module cage comes with a SATA or SAS backplane. Take note of the type of HDD module cage you purchase before buying hard disks.

2.5.1 Removing the HDD module cage

1. Disconnect all the cables from the SATA/SAS backplane on the HDD module cage.
2. Level the HDD module cage latch counterclockwise. The HDD module cage will be pushed out of the chassis.
3. Remove the HDD module cage.

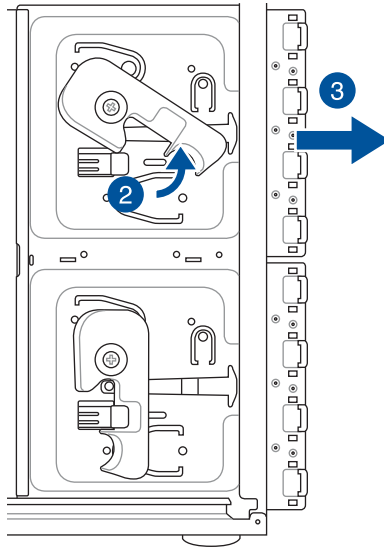

2.5.2 Installing the HDD module cage

1. Prepare the HDD tray then locate an empty bay and insert the HDD tray into the bay.
2. Level the HDD module cage latch counterclockwise.
3. Insert the HDD module cage into the bay.
4. When the HDD module cage is completely inserted, the cage latch will be pushed back clockwise.
5. Lock the cage latch properly.
6. Connect the appropriate cables to the SATA/SAS backplane on the HDD module cage.

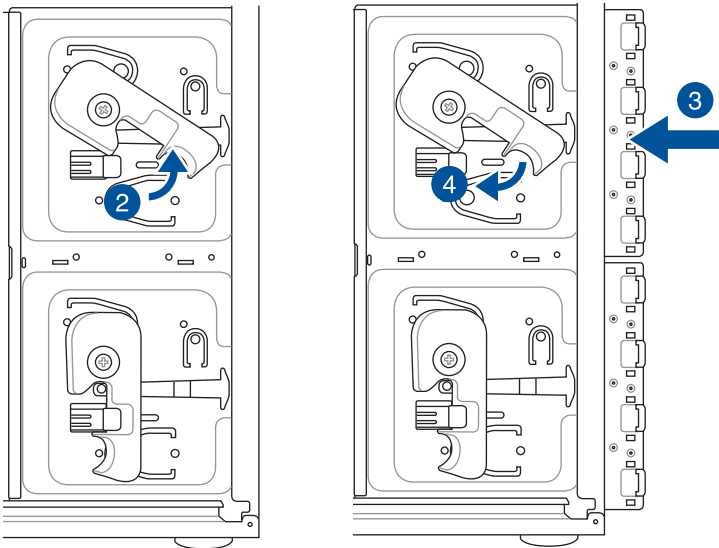

2.5.3 Removing the backplane



DO NOT remove the backplane unless necessary!

1. Remove all hot-swap HDD trays from the chassis.
2. Disconnect all cables from the SATA/SAS backplane.
3. Loosen the four screws on the backplane.

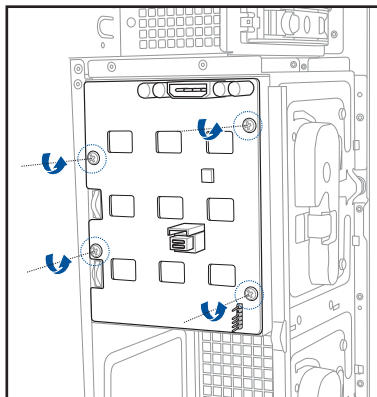

4. Firmly hold the backplane, and turn it in the direction of the arrow.
5. Remove the backplane from the module.

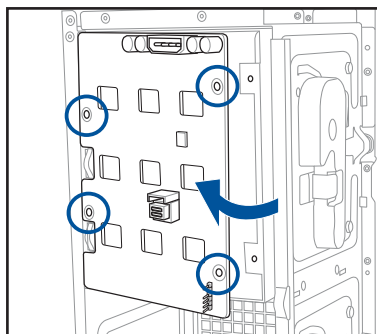

2.5.4 Installing a hot-swap SATA/SAS hard disk drive

1. Release a drive tray by pushing the spring lock to the right, and then pulling the tray lever outward. The drive tray ejects slightly after you pull out the lever.

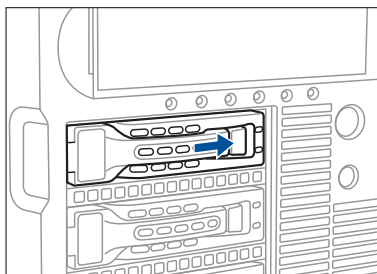

2. Firmly hold the tray lever and pull the drive tray out of the bay.

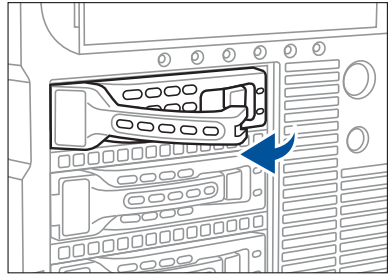

3. Take note of the drive tray holes. Each side has three holes to fit different types of hard disk drives. Use two screws on each side to secure the hard disk drive.

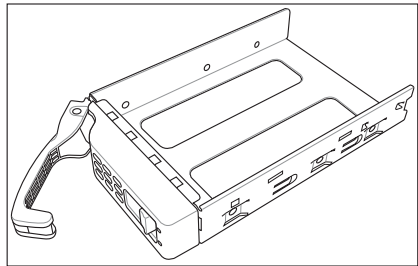

4. Place a SATA/SAS hard disk drive on the tray, and then secure it with four screws.

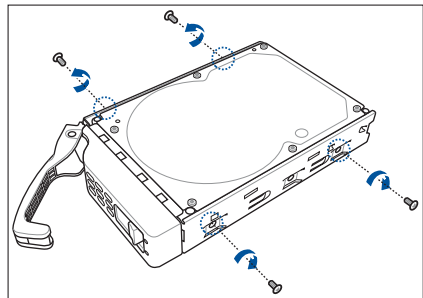

5. Carefully insert the drive tray and push it all the way to the depth of the bay until just a small fraction of the tray edge protrudes.

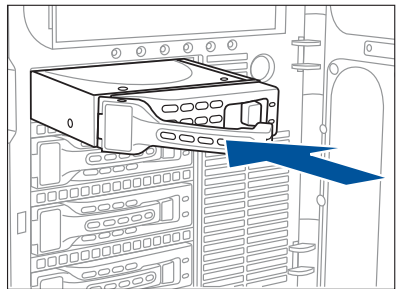

When installed, the SATA/SAS connector on the drive connects to the SATA/SAS interface on the backplane.

6. Push the tray lever until it clicks, and secures the drive tray in place. The drive tray is correctly placed when its front edge aligns with the bay edge.
7. Repeat steps 1 to 6 if you wish to install a second SATA/SAS drive.

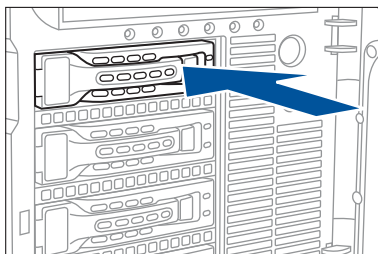

2.6 5.25-inch drives



Ensure to unplug the power cable before installing or removing any system components. Failure to do so may cause damage to the motherboard and other system components!

The system comes with three 5.25-inch drive bays located on the upper front part of the chassis. An optional optical drive occupies the uppermost bay (labeled 1). The lower bays (labeled 2 and 3) are available for additional 5.25-inch drives or 5.25-inch to 3.5-inch hard drive adapter for installing 3.5-inch zip or floppy disk drives.

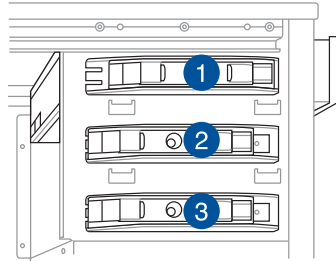

You must remove the front panel assembly before installing a 5.25-inch drive.

2.6.1 Installing a 5.25-inch drive

1. Unscrew and remove the metal cover of the bay where you want to install the 5.25-inch drive.
2. Insert the drive into the bay and slide the bay lock to the right until it clicks in place.
3. Connect the SATA cable to the SATA connector on the back of the drive.
4. Connect the 4-pin power connector from the power supply to the power connector on the back of the drive.

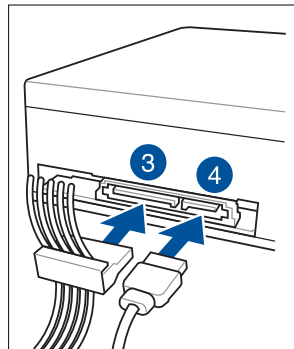
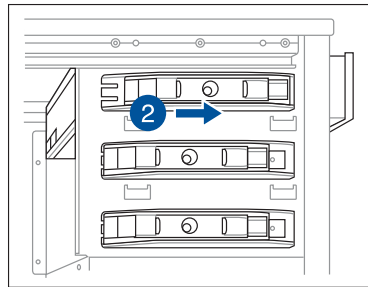

2.7 Expansion slots

Remove the metal slot cover before installing an expansion card.



Ensure to unplug the power cord before installing or removing expansion cards. Failure to do so may cause severe damage to the motherboard and other system components!

2.7.1 Installing an expansion card

1. Before installing the expansion card, read the documentation that came with it and make the necessary hardware settings for the card.
2. Remove the side chassis cover. Lay the system on its side on a flat, stable surface.

3. Push back the expansion card lock latch.

4. Pull the latch of the expansion card lock to release the metal slot cover.

5. Remove the metal slot cover opposite the slot where you wish to install an expansion card.

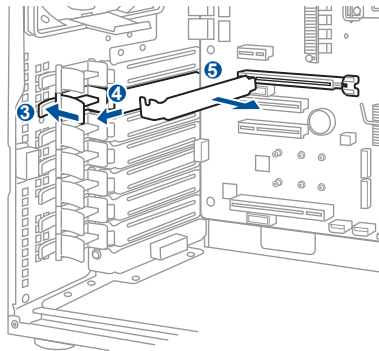

6. Align the PCI card's golden contact points with the slot, and then press firmly until the card is completely seated on the slot.

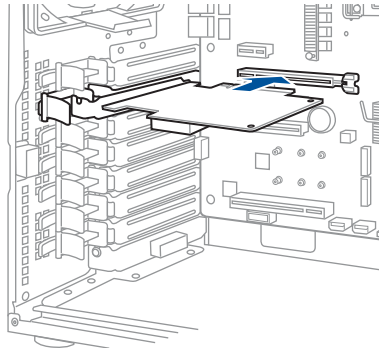

7. Restore the expansion card lock to its original position. A light click indicates the card is locked in place.

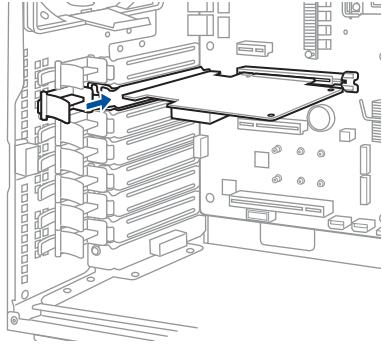

2.7.2 Installing an ASUS PIKE II card

You can install an ASUS PIKE II card on the provided PCI-E slot onboard.

To install an ASUS PIKE II card:

1. Remove the default cable from the motherboard.

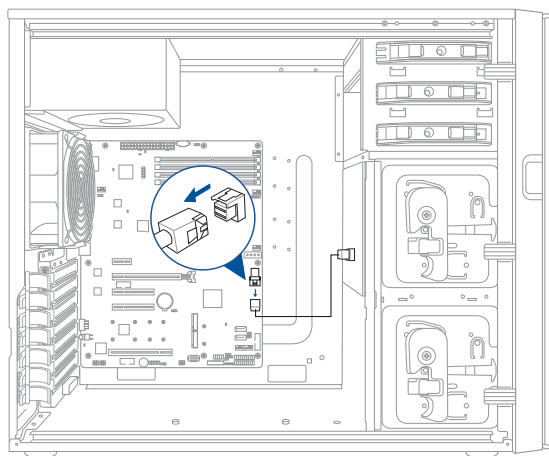

2. Follow steps 3 to 7 in section 2.7.1 **Installing an expansion card** to install your ASUS PIKE II card.
3. Connect the mini-SAS HD cable to the ASUS PIKE II card.

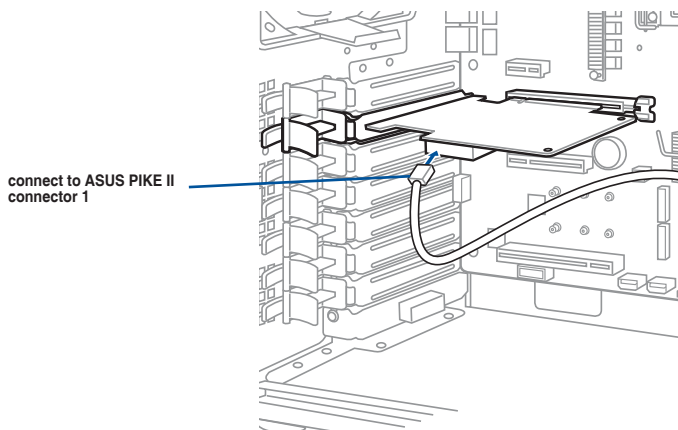

4. Connect connector 1 on the ASUS PIKE II card to the backplane using the mini-SAS HD cable.

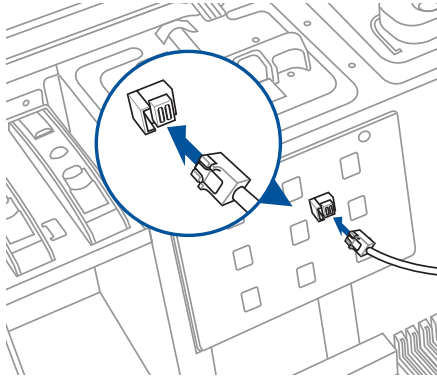

2.7.3 Configuring an expansion card

After installing the expansion card, configure it by adjusting the software settings.

1. Turn on the system and change the necessary BIOS settings, if any. See Chapter 5 for information on BIOS setup.
2. Assign an IRQ to the card. Refer to the following tables.
3. Install the software drivers for the expansion card.

Standard Interrupt assignments

IRQ	Priority	Standard function
0	1	System Timer
1	2	Keyboard Controller
2	-	Programmable Interrupt
3*	11	Communications Port (COM2)
4*	12	Communications Port (COM1)
5*	13	--
6	14	Floppy Disk Controller
7*	15	--
8	3	System CMOS/Real Time Clock
9*	4	ACPI Mode when used
10*	5	IRQ Holder for PCI Steering
11*	6	IRQ Holder for PCI Steering
12*	7	PS/2 Compatible Mouse Port
13	8	Numeric Data Processor
14*	9	Primary IDE Channel
15*	10	Secondary IDE Channel

* These IRQs are usually available for PCI devices.

Expansion slots

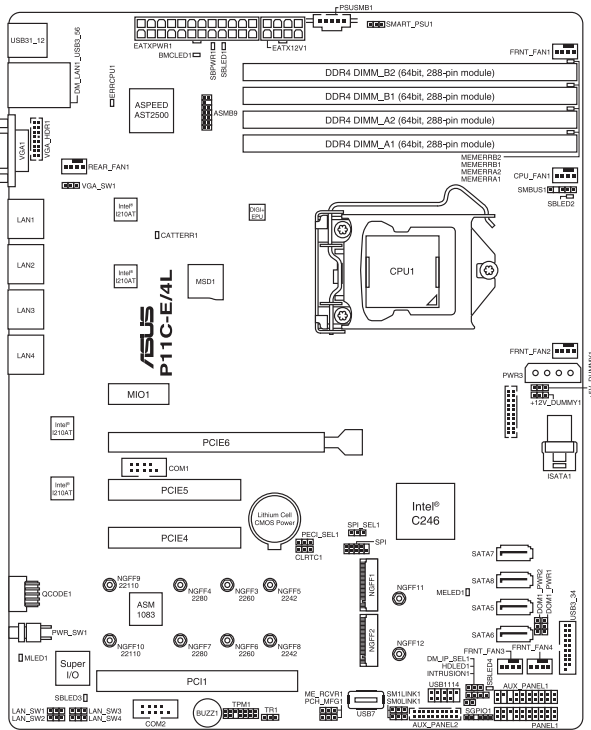

MIO1	1 x MIO slot with PCI-E x1 slot (Gen3 x1 link)
PCI-E6	1 x PCI-E x16 (x16 Gen3 link)
PCI-E5	1 x PCI-E x8 (x8 Gen3 link)
PCI-E4	1 x PCI-E x8 (x4 Gen3 link)
PCI1	1 x PCI 32 bit / 33 MHz

2.7.4 Installing an M.2 expansion card

You can install an M.2 expansion card on the provided M.2 socket (labeled M2) onboard.

To install an M.2 expansion card:

1. Locate the M.2 (NGFF) connectors on your motherboard.

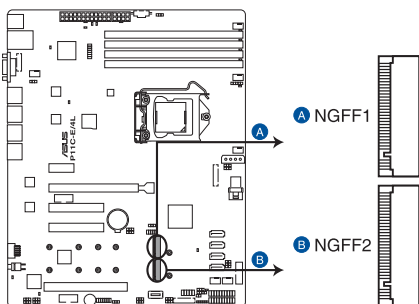

P11C-E/4L NGFF connectors



The illustrations below vary with models. The installation steps are the same.

2. Remove the top screw and the stand from the motherboard.

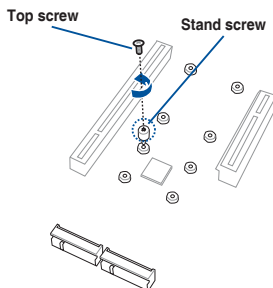

3. Select an appropriate screw hole on the motherboard for your M.2 card, then secure the stand to the motherboard.

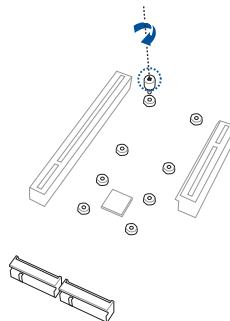

4. Prepare the M.2 card.
5. Align and insert the M.2 card into the M.2 connector on the motherboard.

Ensure that the golden connector of the M.2 card is inserted firmly in place and that the screw hole on the M.2 card matches the stand screw on the motherboard.

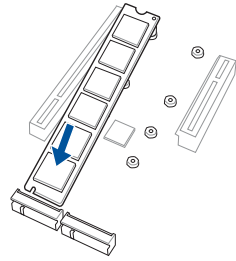

6. Secure the M.2 card with the top screw.



Ensure that the M.2 card is positioned between the top screw and the stand screw before securing it.

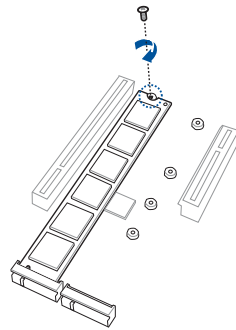

2.8 Cable connections



- The bundled system cables are pre-connected before shipment. You do not need to disconnect these cables unless you will remove pre-installed components to install additional devices.
- Refer to Chapter 4 for detailed information on the connectors.

2.8.1 Motherboard connections

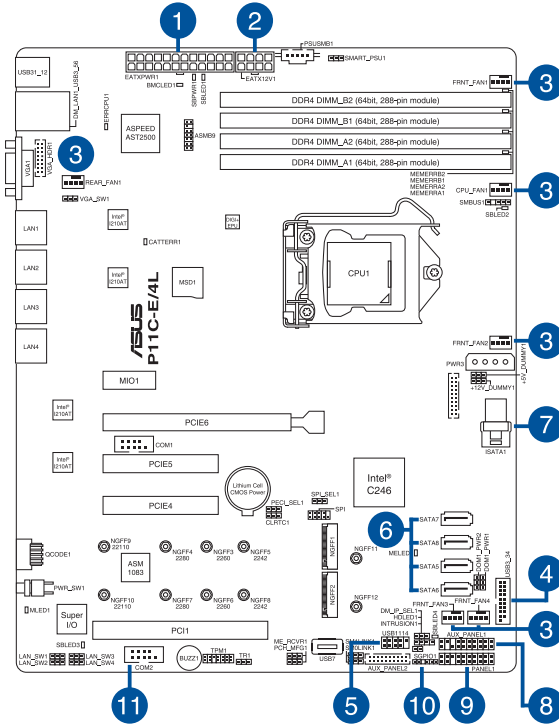

Standard cables connected to the motherboard

1. 24-pin ATX power connector (from power supply to motherboard)
2. 8-pin 12V power connector (from power supply to motherboard)
3. System fan connector (from motherboard to system fan)
4. USB 3.0 connector (from motherboard to front I/O board)
5. USB 2.0 connector (from motherboard to front I/O board)
6. SATA connector (from motherboard to front 3.5 / 5.25-inch SATA/SAS device)
7. Mini-SAS HD connector (from motherboard to SATA/SAS backplane)
8. System auxiliary panel connector (from motherboard to front I/O board)
9. System panel connector (from motherboard to front I/O board)
10. Serial General Purpose Input/Output connectors
11. COM port connector (from motherboard to rear I/O)

2.8.2 SATA/SAS backplane cabling

The system comes with a pre-installed SATA/SAS backplane. The SATA/SAS backplane has four 22-pin SATA/SAS connectors to support Serial ATA hard disk drives and SAS hard disk drives. The backplane design incorporates a hot-swap feature to allow easy connection or removal of SATA/SAS hard disks. The LEDs on the backplane connect to the front panel LEDs to indicate HDD status. See section 1.7 **LED information** for details.

Front side

The front side of the SATA/SAS backplane faces the front panel when installed. This side includes four SATA/SAS connectors for the hot-swap drive trays.

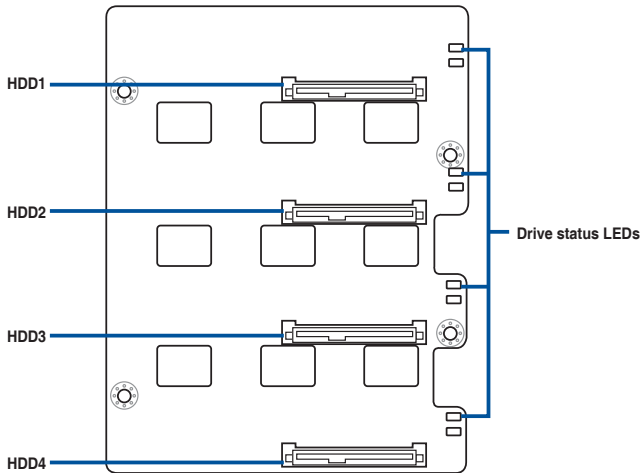

Each SATA/SAS connector is labeled (HDD1, HDD2, HDD3, HDD4) so you can easily determine their counterpart connectors at the back side of the backplane. Refer to the table for reference.

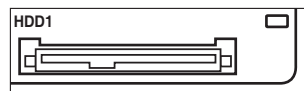

HDD Device	Front side connector	Back side connector
HDD 1	HDD1	CON1
HDD 2	HDD2	CON2
HDD 3	HDD3	CON3
HDD 4	HDD4	CON4

Back side

The back side of the SATA/SAS backplane faces the rear panel when installed. This side includes the power connectors and SATA/SAS interfaces for the motherboard Serial ATA connectors or the SAS card.

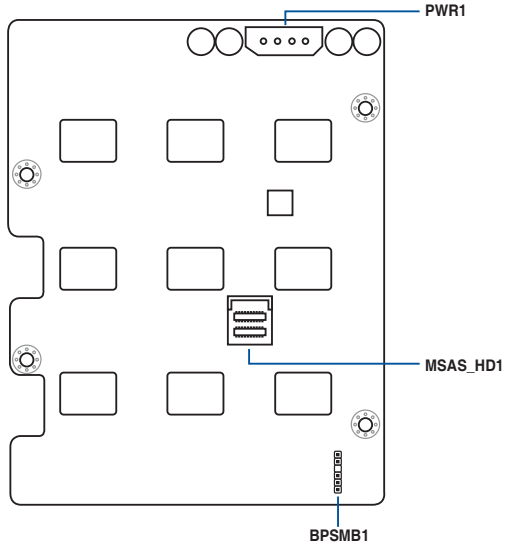

Connectors	Description
MSAS_HD1	Connects to SATA SGPIO1 connector on the motherboard or connects to SATA/SAS connectors on the ASUS PIKE II card.
BPSMB1	Connects to AUX_PANEL1 connector on the motherboard
PWR1	Connects to 4-pin plug of the power supply

2.9 Removable components

You may need to remove previously installed system components when installing or removing system devices, or when you need to replace defective components. This section tells how to remove the following components:

1. System fans (front and rear)
2. Chassis footpads

2.9.1 System fans

Removing the front system fan

To remove the front system fan:

1. Remove the two screws that secure the right side cover. Then remove the side cover.

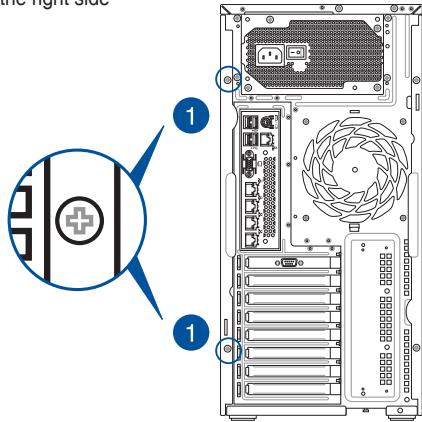

2. Locate the front system fan near the 5.25-inch drive bays.
3. Squeeze the front system fan latches (A) and pull out the front system fan (B), as shown in the right figure.
4. Follow the previous instructions in reverse to reinstall the front system fan.

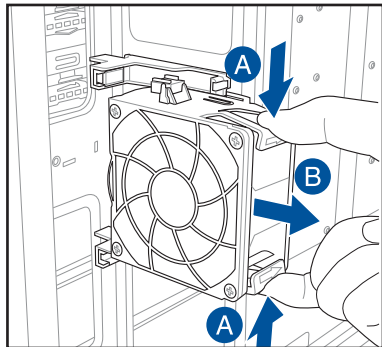

Removing the rear system fan

To remove the rear system fan:

1. Pull the rear system fan latches outwards (A) to release the rear system fan (B), as shown in the figure below.

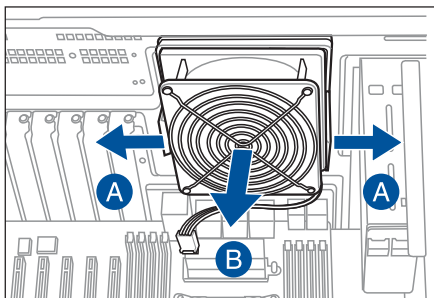

2. Unplug the system fan cable from the REAR_FAN1 connector on the motherboard, then remove the rear system fan from the server system.

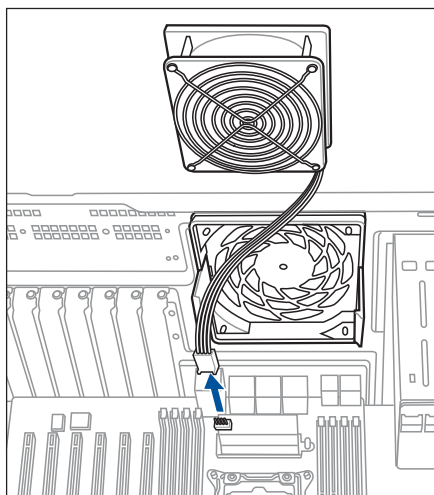

Follow the previous instructions in reverse to reinstall the rear system fan.

2.9.2 Chassis footpads

The barebone server system is shipped with four footpads attached to the bottom of the chassis for stability. You need to remove these footpads if you wish to install the system to a rack. Refer to Chapter 3: Installation Options of this user guide, and to the “Rackmount Kit” user guide for instructions.

To remove the footpads:

1. Lay the system chassis on its side.
2. Remove the footpad by rotating it counterclockwise with a Phillips (cross) screwdriver.
3. Repeat steps 1 and 2 to remove the other three footpads.

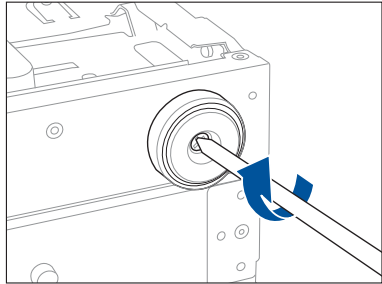

Installation Options

3

This chapter describes how to install the optional components and devices into the barebone server.

3.1 Preparing the system for rack mounting



- The items required for the optional configurations described in this chapter are not included in the standard barebone system package. These items are purchased separately.
- We recommend that you allot at least 1U space above the server system to ensure optimal thermal performance.

Removing the footpads



Refer to section 2.9.2 Chassis footpads for instructions on removing the footpads.

Removing the top cover

Unscrew and slide the top cover toward the rear panel, and then lift it up from the chassis.

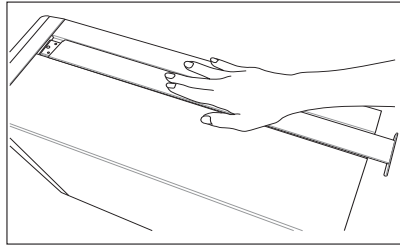

3.2 Attaching the inner rail to the server

1. Press the lock on side of the rail and slide the inner rail out from the rackmount rail kit.

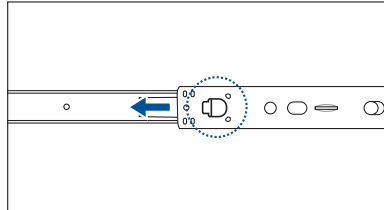

2. Slide the inner rail into the rail on top of the chassis.
3. Align the screw holes on the inner rail and the chassis top, and then secure the inner rail to the chassis top with screws.

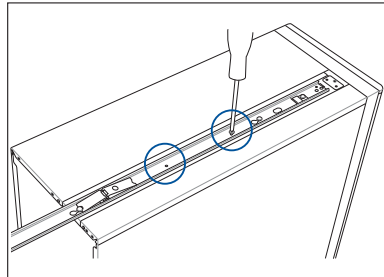

- Repeat the previous steps to secure the other inner rail to the bottom of the chassis with screws.

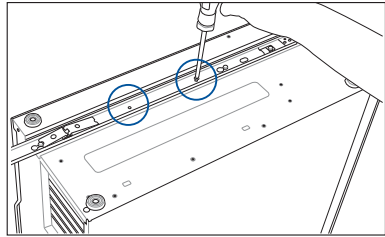

- Use three screws to secure the side hooks to both rails.

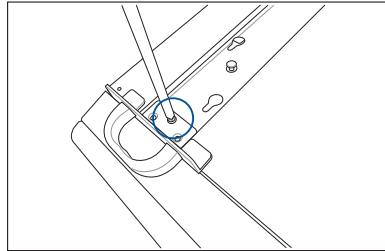

3.3 Attaching the rails to the rack

To attach the rails to the rack:

- Select one unit of space (1U) on the rack where you wish to install the server.

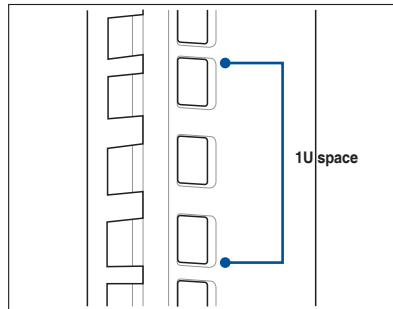

- Drive in two screws on the rack rails.

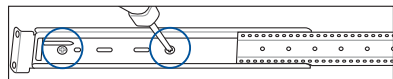

3. Align the front end holes of a rack rail pair to the 1U space.
4. Drive in two screws on the outer holes to secure the front end.

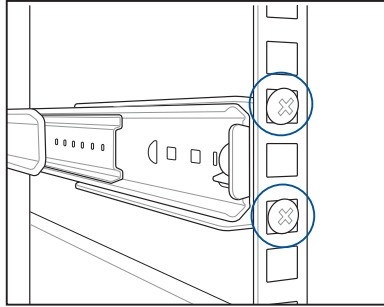

5. Find the rear 1U space that corresponds to the front 1U space where you attached the rail. Drive in two screws on the outer holes to secure the rear end.
6. From the rack front, find the corresponding 1U space for the second rail pair.
7. Repeat steps 3–6 to attach the second rail pair.

3.4 Mounting the server to the rack

To mount the server to the rack:

1. Align the server rails with the rack rails.
2. Press the lock on side of the rail and slide the server into the rack.

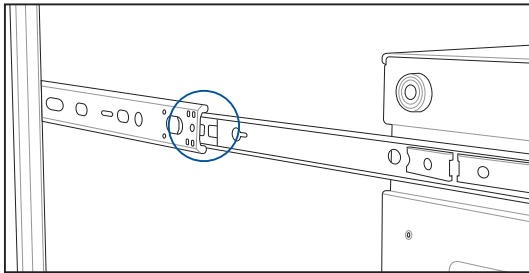

3. When the server is fully slide into the rack, secure both sides using screws.

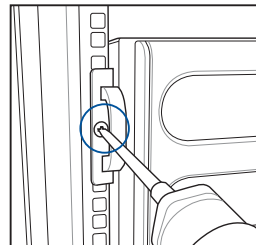
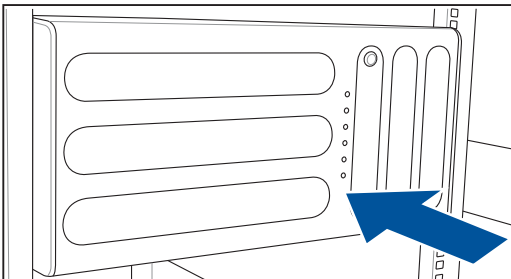

Motherboard Information

4

This chapter includes the motherboard layout and brief descriptions of the jumpers and internal connectors.

4.1 Motherboard layout

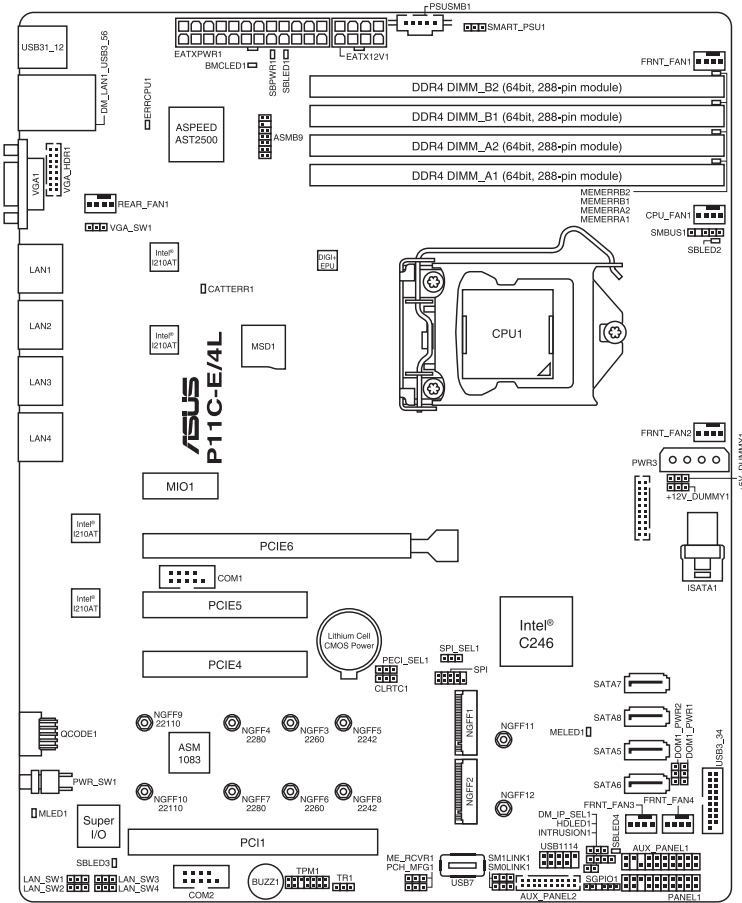

Layout contents

Onboard LEDs		Page
1.	Standby Power LED (SBPWR1)	4-5
2.	Baseboard Management Controller LED (BMCLED1)	4-5
3.	CPU Warning LED (ERRCPU1)	4-6
4.	Message LED (MLED1)	4-6
5.	CATT ERR LED (CATTERR1)	4-7

Jumpers		Page
1.	Clear RTC RAM (3-pin CLRTC1)	4-8
2.	VGA controller setting (3-pin VGA_SW1)	4-9
3.	LAN controller setting (3-pin LAN_SW1-4)	4-9
4.	ME firmware force recovery setting (3-pin ME_RCVR1)	4-10
5.	PCH_MFG1 setting (3-pin PCH_MFG1)	4-10
6.	SATA DOM power setting (3-pin DOM1_PWR1-2)	4-11
7.	Smart Ride Through setting (3-pin SMART_PSU1)	4-11

Internal connectors		Page
1.	Serial ATA 6 Gbps connectors (7-pin SATA 6 Gbps_5-6 connector [Gray], 7-8 connector [Light Blue])	4-12
2.	Hard disk activity LED connector (4-pin HDLED1)	4-12
3.	USB 2.0 connectors (10-1 pin USB1114, USB7)	4-13
4.	USB 3.0 connector (20-1 pin USB3_34)	4-13
5.	CPU, front and rear fan connectors (4-pin FRNT_FAN1-4, REAR_FAN1, CPU_FAN1)	4-14
6.	Serial General Purpose Input/Output connector (6-1 pin SGPIO1)	4-14
7.	Serial port connectors (10-1 pin COM1/COM2)	4-15
8.	Power Supply SMBus connector (5-pin PSUSMB1)	4-15
9.	Trusted Platform Module connector (14-1 pin TPM1)	4-16
10.	SATA DOM power connector (4-pin PWR3)	4-16
11.	VGA connector (16-1 pin VGA_HDR1)	4-17
12.	ATX power connectors (24-pin EATXPWR1, 8-pin EATX12V1)	4-17
13.	System panel connector (20-1 pin PANEL1)	4-18
14.	Auxiliary panel connectors (20-pin AUX_PANEL2, 20-2 pin AUX_PANEL1)	4-19
15.	M.2 (NGFF) card connectors (NGFF1-2)	4-20
16.	System Management Bus (SMBUS) connector (5-1 pin SMBUS1)	4-21
17.	Chassis intrusion connector (2-pin INTRUSION1)	4-21
18.	Mini-SAS HD connector (ISATA1)	4-22

4.2 Onboard LEDs

1. Standby Power LED (SBPWR1)

The motherboard comes with a standby power LED. The green LED lights up to indicate that the system is ON, in sleep mode, or in soft-off mode. This is a reminder that you should shut down the system and unplug the power cable before removing or plugging in any motherboard component. The illustration below shows the location of the onboard LED.

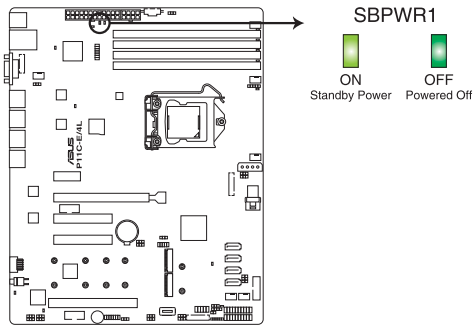

P11C-E/4L Standby Power LED

2. Baseboard Management Controller LED (BMCLED1)

The green heartbeat LED blinks per second to indicate that the ASMB9 is working normally. The BMC LED works with the ASUS ASMB9 management device and indicates its initiation status. When the PSU is plugged and the system is OFF, ASUS ASMB9 management device starts system initiation for about one (1) minute. The BMC LED blinks after system initiation finishes.

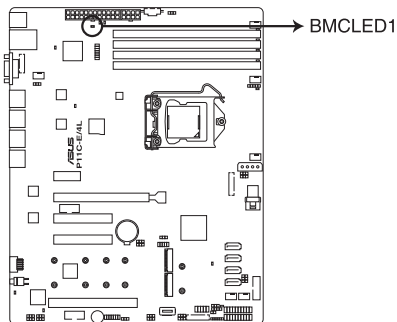

P11C-E/4L BMC LED



- The heartbeat LED functions only when you install the ASUS ASMB9 management card.
- Everytime after the AC power is replugged, you have to wait for about 60 seconds for the system to power up.

3. CPU Warning LED (ERRCPU1)

The CPU warning LED lights up to indicate that a CPU error or failure has occurred.

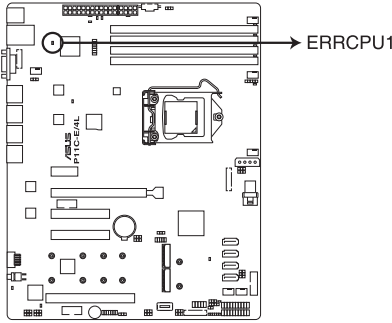

P11C-E/4L ERRCPU1 LED



The warning LED functions only when you install the ASUS ASMB9 management card.

4. Message LED (MLED1)

The Message LED is an onboard LED that lights up to indicate an abnormal event occurrence.

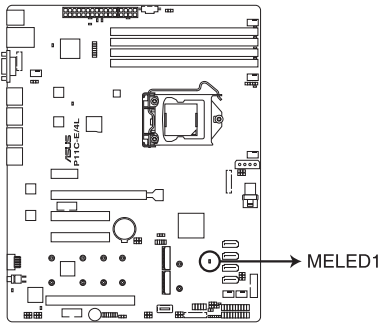

P11C-E/4L MELED1

5. CATTERR LED (CATTERR1)

The CATTERR LED indicates that the system has experienced a fatal or catastrophic error and cannot continue to operate.

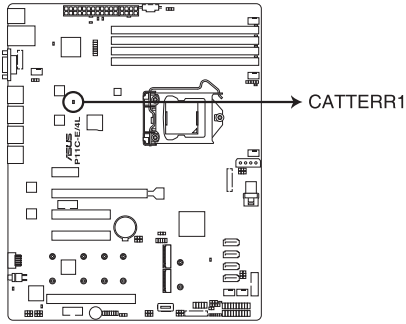

P11C-E/4L CATTERR1 LED

4.3 Jumpers

1. Clear RTC RAM (3-pin CLRTC1)

This jumper allows you to clear the Real Time Clock (RTC) RAM in CMOS. You can clear the CMOS memory of date, time, and system setup parameters by erasing the CMOS RTC RAM data. The onboard button cell battery powers the RAM data in CMOS, which include system setup information such as system passwords.

To erase the RTC RAM:

1. Turn OFF the computer and unplug the power cord.
2. Move the jumper cap from pins 1–2 (default) to pins 2–3. Keep the cap on pins 2–3 for about 5–10 seconds, then move the cap back to pins 1–2.
3. Plug the power cord and turn ON the computer.
4. Hold down the key during the boot process and enter BIOS setup to re-enter data.



Except when clearing the RTC RAM, never remove the cap on CLRTC jumper default position. Removing the cap will cause system boot failure!



If the steps above do not help, remove the onboard battery and move the jumper again to clear the CMOS RTC RAM data. After the CMOS clearance, reinstall the battery.

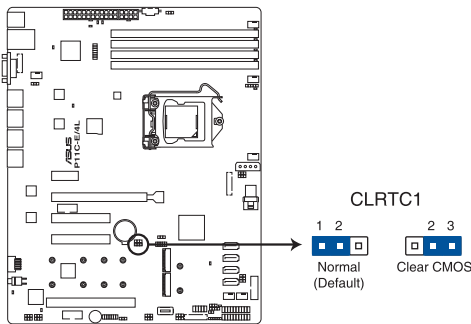

P11C-E/4L Clear RTC RAM

2. VGA controller setting (3-pin VGA_SW1)

This jumper allows you to enable or disable the onboard VGA controller. Set to pins 1-2 to activate the VGA feature.

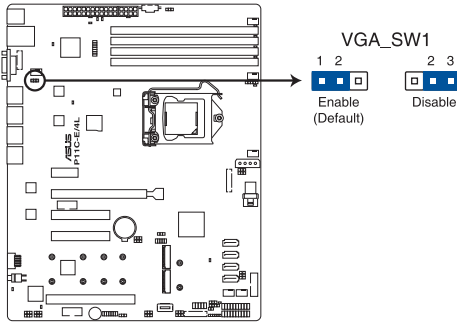

P11C-E/4L VGA setting

3. LAN controller setting (3-pin LAN_SW1-4)

These jumpers allow you to enable or disable the onboard Intel® I210 Gigabit LAN controllers. Set to pins 1-2 to activate the Gigabit LAN feature.

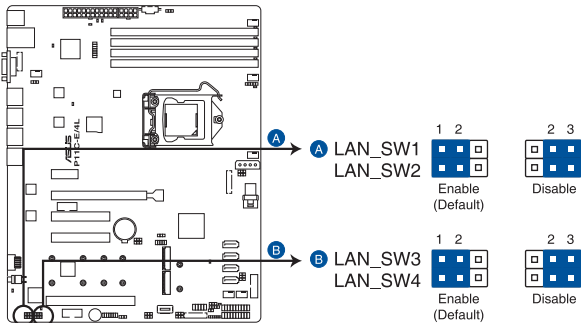

P11C-E/4L LAN setting

4. ME firmware force recovery setting (3-pin ME_RCVR1)

This jumper allows you to force Intel Management Engine (ME) boot from recovery mode when ME become corrupted.

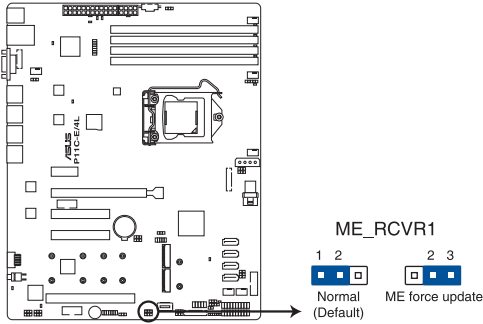

P11C-E/4L ME recovery setting

5. PCH_MFG1 setting (3-pin PCH_MFG1)

This jumper allows you to update the BIOS ME block select.

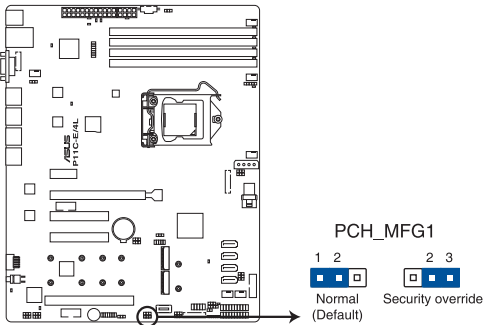

P11C-E/4L PCH_MFG1 setting

6. SATA DOM power setting (3-pin DOM1_PWR1, DOM1_PWR2)

This jumper allows you to configure the DOM power setting.

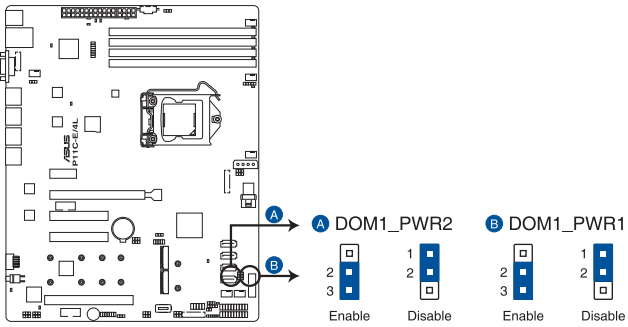

P11C-E/4L DOM PWR setting

7. Smart Ride Through (SmaRT) setting (3-pin SMART_PSU1)

This jumper allows you to enable or disable the Smart Ride Through (SmaRT) function. This feature is disabled by default. Set to pins 1-2 to enable it. When enabled, SmaRT allows uninterrupted operation of the system during an AC loss event.

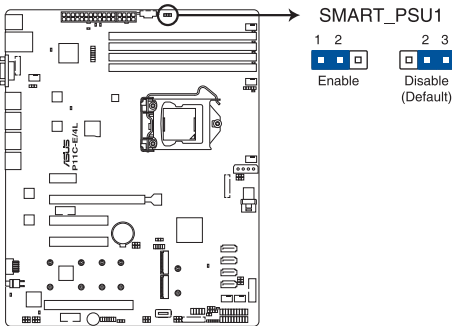

P11C-E/4L Smart Ride Through setting

4.4 Internal connectors

1. Serial ATA 6.0 Gbps connectors (7-pin SATA5-8)

Supported by the Intel® C236 chipset, these connectors are for the Serial ATA signal cables for Serial ATA hard disk drives that allows up to 6Gb/s of data transfer rate.

If you installed Serial ATA hard disk drives, you can create a RAID 0, RAID 1, RAID 10, or RAID 5 configuration.

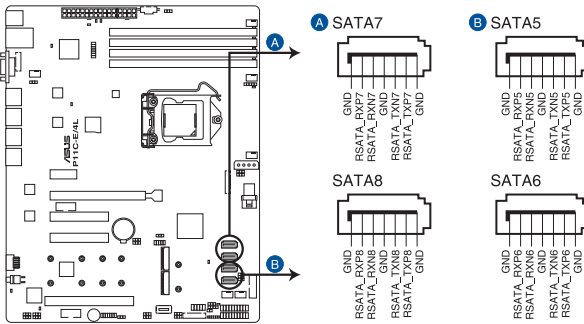

P11C-E/4L SATA connectors



- The actual data transfer rate depends on the speed of Serial ATA hard disks installed.
- When the M.2 (NGFF1) is operating in SATA mode, SATA5 will be disabled.
- When the M.2 (NGFF2) is operating in SATA mode, SATA6 will be disabled.

2. Hard disk activity LED connector (4-pin HDLED1)

This LED connector is for the storage add-on card cable connected to the SATA or SAS add-on card. The read or write activities of any device connected to the SATA or SAS add-on card causes the front panel LED to light up.

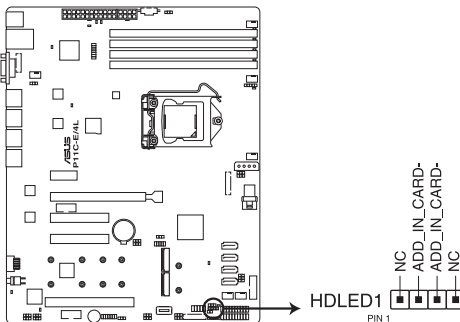

P11C-E/4L Storage device activity LED connector

3. USB 2.0 connectors (10-1 pin USB1114; USB7)

These connectors are for USB 2.0 ports. Connect the USB module cables to these connectors. These USB connectors comply with USB 2.0 specification that supports up to 480 Mbps connection speed.

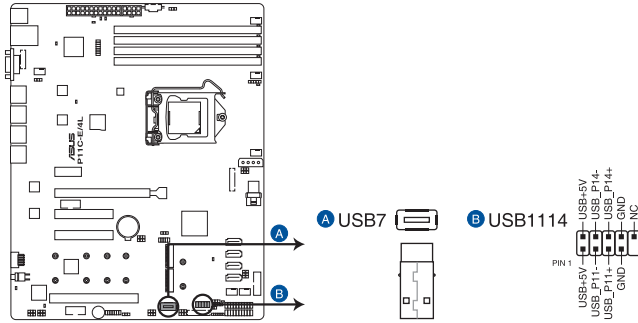

P11C-E/4L USB 2.0 connectors

4. USB 3.0 connector (20-1 pin USB3_34)

This connector allows you to connect a USB 3.0 module for additional USB 3.0 front or rear panel ports. With an installed USB 3.0 module, you can enjoy all the benefits of USB 3.0 including faster data transfer speeds of up to 5 Gbps, faster charging time for USB-chargable devices, optimized power efficiency, and backward compatibility with USB 2.0.

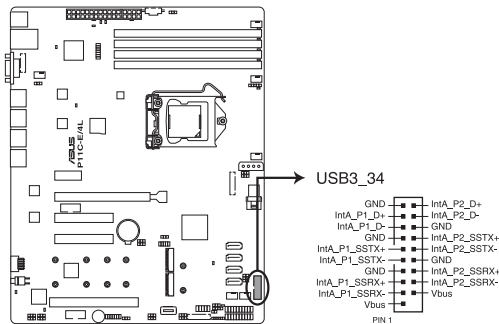

P11C-E/4L USB 3.0 connector

5. CPU, front, and rear fan connectors (4-pin FRNT_FAN1-4, REAR_FAN1, CPU_FAN1)

The fan connectors support cooling fans. Connect the fan cables to the fan connectors on the motherboard, ensuring that the black wire of each cable matches the ground pin of the connector.



- DO NOT forget to connect the fan cables to the fan connectors. Insufficient air flow inside the system may damage the motherboard components.
- These are not jumpers! DO NOT place jumper caps on the fan connectors!
- All fans feature the ASUS Smart Fan technology.

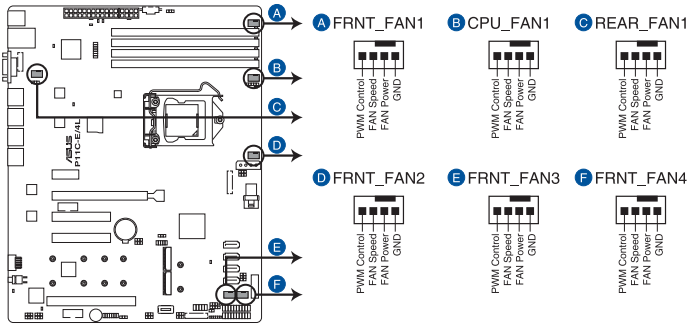

P11C-E/4L FAN connectors

6. Serial General Purpose Input/Output connector (6-1 pin SGPIO1)

The SGPIO 1 connector is used for the Intel Rapid Storage Technology Enterprise SGPIO interface that controls the LED pattern generation, device information, and general purpose data.

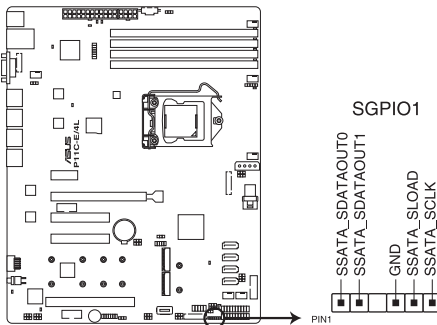

P11C-E/4L SGPIO1 connector

7. Serial port connectors (10-1 pin COM1/COM2)

These connectors are for the serial COM ports. Connect the serial port module cable to one of these connectors, then install the module to a slot opening at the back of the system chassis.

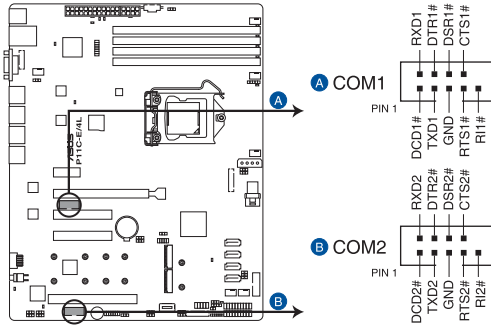

P11C-E/4L Serial port connectors

8. Power Supply SMBus connector (5-pin PSUSMB1)

This connector allows you to connect SMBus (System Management Bus) to the power supply unit to read PSU information. Devices communicate with an SMBus host and/or other SMBus devices using the SMBus interface.

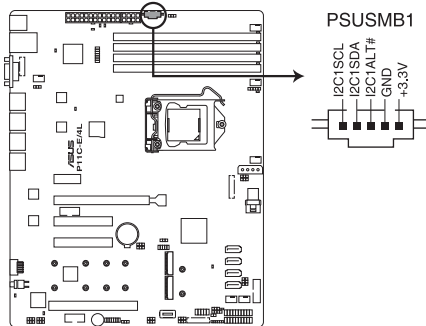

P11C-E/4L Power supply SMBus connector



This connector functions only when you install the ASUS ASMB9 management card.

9. Trusted Platform Module connector (14-pin TPM1)

This connector supports a TPM (Trusted Platform Module) system, which can securely store keys, digital certificates, passwords, and data. A TPM system also helps enhance network security, protects digital identities, and ensures platform integrity.

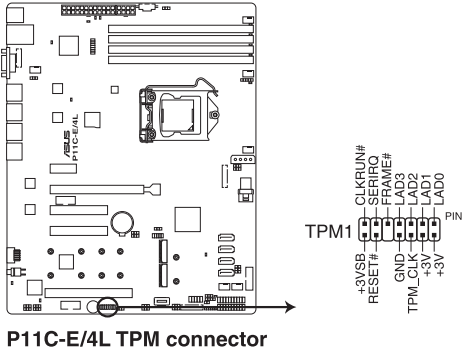

10. SATA DOM power connector (4-pin PWR3)

This 4-pin connector is for 5V power of a certain SATA DOM (Disk on Module) device when using an appropriate cable.

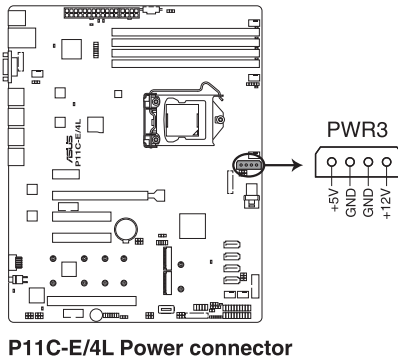

- The SATA DOM power connector is for output power only. It has a maximum output current of 1A.
- Ensure that the power of the SATA DOM device that you will use is less than 1A.

11. VGA connector (16-1 pin VGA_HDR1)

This connector supports the VGA High Dynamic-Range interface.

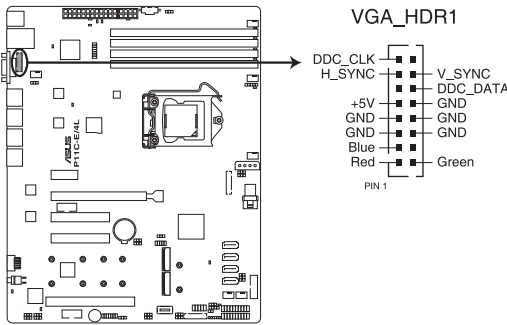

P11C-E/4L Internal VGA connector

12. ATX power connectors (24-pin EATXPWR1, 8-pin EATX12V1)

These connectors are for the ATX power supply plugs. The power supply plugs are designed to fit these connectors in only one orientation. Find the proper orientation and push down firmly until the connectors completely fit.



- DO NOT forget to connect the 24-pin and the 8-pin power plugs; otherwise, the system will not boot up.
- Use of a power supply unit (PSU) with a higher power output is recommended when configuring a system with more power-consuming devices. The system may become unstable or may not boot up if the power is inadequate.
- This motherboard supports ATX2.0 PSU or later version.
- Ensure that your PSU can provide at least the minimum power required by your system.

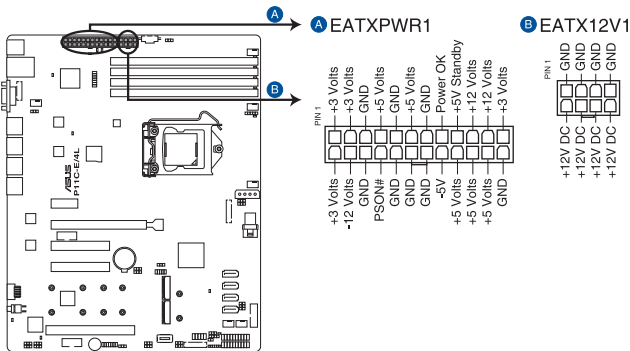

P11C-E/4L ATX power connectors

13. System panel connector (20-1 pin PANEL1)

This connector supports several chassis-mounted functions.

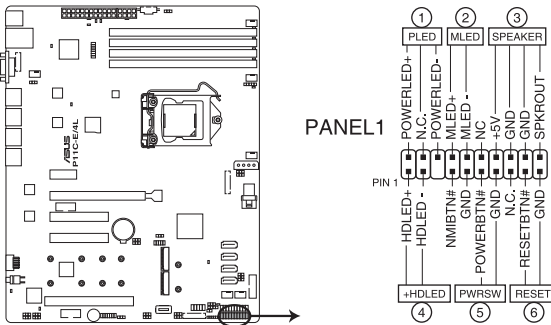

P11C-E/4L System panel connector

1. System power LED (3-pin PLED)

This 3-pin connector is for the system power LED. Connect the chassis power LED cable to this connector. The system power LED lights up when you turn on the system power, and blinks when the system is in sleep mode.

2. Message LED (2-pin MLED)

This 2-pin connector is for the message LED cable that connects to the front message LED. The message LED is controlled by Hardware monitor to indicate an abnormal event occurrence.

3. System warning speaker (4-pin SPEAKER)

This 4-pin connector is for the chassis-mounted system warning speaker. The speaker allows you to hear system beeps and warnings.

4. Hard disk drive activity LED (2-pin +HDLED)

This 2-pin connector is for the HDD Activity LED. Connect the HDD Activity LED cable to this connector. The IDE LED lights up or flashes when data is read from or written to the HDD.

5. Power button/soft-off button (2-pin PWRSW)

This connector is for the system power button. Pressing the power button turns the system on or puts the system in sleep or soft-off mode depending on the BIOS settings. Pressing the power switch for more than four seconds while the system is ON turns the system OFF.

6. Reset button (2-pin RESET)

This 2-pin connector is for the chassis-mounted reset button for system reboot without turning off the system power.

14. Auxiliary panel connectors (20-pin AUX_PANEL2; 20-2 pin AUX_PANEL1)

These connectors are for additional front panel features including front panel SMB, locator LED and switch, chassis intrusion, and LAN LEDs.

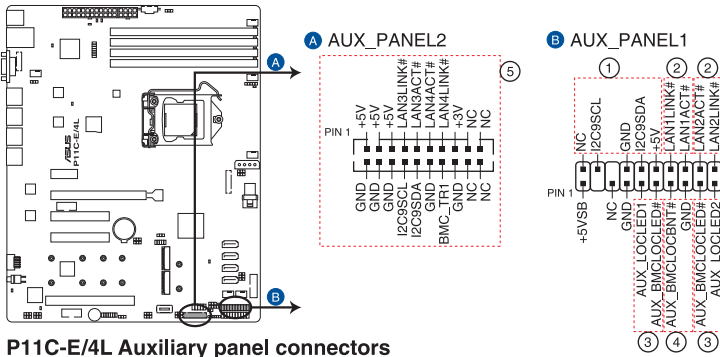

P11C-E/4L Auxiliary panel connectors

1. Front panel SMB (6-1 pin FPSMB)

These connectors connect the front panel SMBus cable.

2. LAN activity LED (2-pin LAN1LINK and 2-pin LAN2LINK)

These connectors are for Gigabit LAN activity LEDs on the front panel.

3. Locator LED (2-pin AUX_LOCLEDD1 and 2-pin AUX_LOCLEDD2)

These connectors are for the Locator LED1 and LED2 on the front panel. Connect the Locator LED cables to these 2-pin connector. The LEDs will light up when the Locator button is pressed.

4. Locator Button/Switch (2-pin AUX_BMCLOCBTN)

These connectors are for the locator button on the front panel. This button queries the state of the system locator.

5. LAN activity LED and USB port (USB power and OC pin)

These leads are for the USB ports on the front or rear panel.

15. M.2 (NGFF) card connectors (NGFF1-2)

These connectors allow you to install an M.2 device.

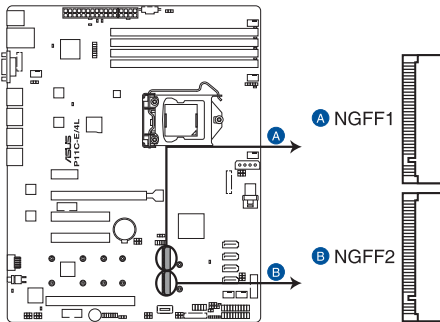

P11C-E/4L NGFF connectors



- NGFF1 supports PCIe 3.0 x2 and SATA mode M Key design and type 2242 / 2260 / 2280 / 22110 PCIe and SATA storage devices.
- NGFF2 supports SATA mode M Key design and type 2242 / 2260 / 2280 / 22110 SATA storage devices.
- When the M.2 (NGFF1) is operating in SATA mode, SATA5 will be disabled.
- When the M.2 (NGFF2) is operating in SATA mode, SATA6 will be disabled.



The M.2 (NGFF) device is purchased separately.

16. System Management Bus (SMBUS) connector (5-1 pin SMBUS1)

This connector controls the system and power management-related tasks. This connector processes the messages to and from devices rather than tripping the individual control lines.

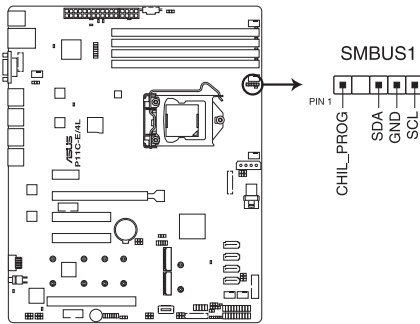

P11C-E/4L SMBUS connector

17. Chassis intrusion connector (2-pin INTRUSION1)

This connector is for a chassis-mounted intrusion detection sensor or switch. Connect one end of the chassis intrusion sensor or switch cable to this connector. The chassis intrusion sensor or switch sends a high-level signal to this connector when a chassis component is removed or replaced. The signal is then generated as a chassis intrusion event.

By default, the pin labeled “Chassis Signal” and “Ground” are shorted with a jumper cap. Remove the jumper caps only when you intend to use the chassis intrusion detection feature.

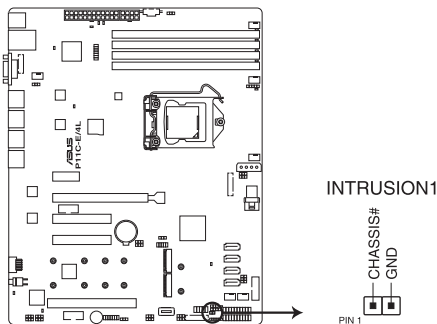

P11C-E/4L Chassis Intrusion connectors

18. Mini-SAS HD connector (ISATA1)

This motherboard comes with a mini Serial Attached SCSI (SAS) HD connector, the storage technology that supports Serial ATA. The connector supports up to four devices.

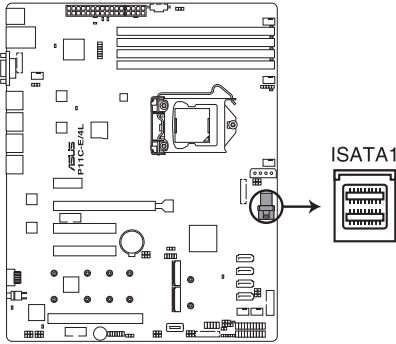

P11C-E/4L ISATA connector

BIOS Setup

5

This chapter tells how to change the system settings through the BIOS Setup menus. Detailed descriptions of the BIOS parameters are also provided.

5.1 Managing and updating your BIOS

The following utilities allow you to manage and update the motherboard Basic Input/Output System (BIOS) setup:

1. **ASUS CrashFree BIOS 3**

To recover the BIOS using a bootable USB flash disk drive when the BIOS file fails or gets corrupted.

2. **ASUS EzFlash**

Updates the BIOS using a USB flash disk.

3. **BUPDATER**

Updates the BIOS in DOS mode using a bootable USB flash disk drive.

Refer to the corresponding sections for details on these utilities.



Save a copy of the original motherboard BIOS file to a bootable USB flash disk drive in case you need to restore the BIOS in the future. Copy the original motherboard BIOS using the BUPDATER utility.

5.1.1 **ASUS CrashFree BIOS 3 utility**

The ASUS CrashFree BIOS 3 is an auto recovery tool that allows you to restore the BIOS file when it fails or gets corrupted during the updating process. You can update a corrupted BIOS file using a USB flash drive that contains the updated BIOS file.



Prepare a USB flash drive containing the updated motherboard BIOS before using this utility.



When downloading or updating the BIOS file, rename it as **P11CE4L.CAP** for this motherboard.

Recovering the BIOS from a USB flash drive

To recover the BIOS from a USB flash drive:

1. Insert the USB flash drive with the original or updated BIOS file to one USB port on the system.
2. The utility will automatically recover the BIOS. It resets the system when the BIOS recovery finished.



DO NOT shut down or reset the system while recovering the BIOS! Doing so would cause system boot failure!



The recovered BIOS may not be the latest BIOS version for this motherboard. Visit the ASUS website at www.asus.com to download the latest BIOS file.

5.1.2 ASUS EZ Flash Utility

The ASUS EZ Flash Utility feature allows you to update the BIOS using a USB flash disk without having to use a DOS-based utility.



Download the latest BIOS from the ASUS website at www.asus.com before using this utility.



The succeeding BIOS screens are for reference only. The actual BIOS screen displays may not be the same as shown.

To update the BIOS using EZ Flash Utility:

1. Insert the USB flash disk that contains the latest BIOS file to the USB port.
2. Enter the BIOS setup program. Go to the **Tool** menu then select **Start ASUS EzFlash** and press <Enter> to enable it.

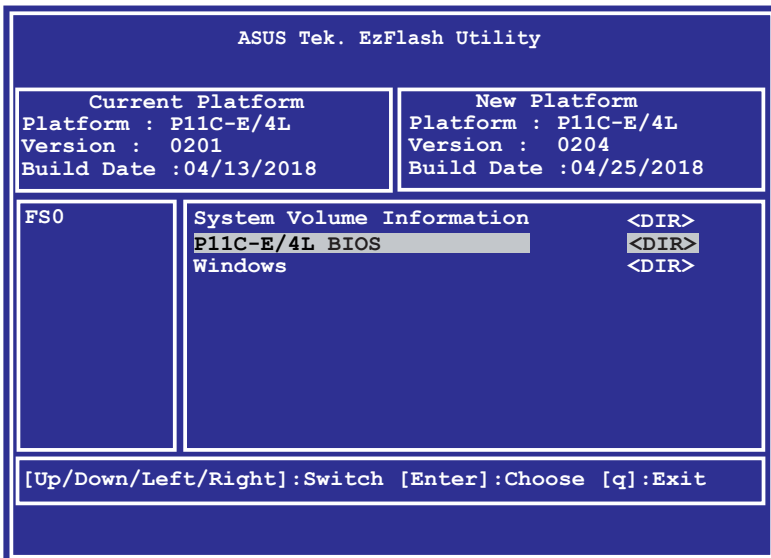

3. Press <Tab> to switch to the **Drive** field.
4. Press the Up/Down arrow keys to find the USB flash disk that contains the latest BIOS then press <Enter>.
5. Press <Tab> to switch to the **Folder Info** field.
6. Press the Up/Down arrow keys to find the BIOS file then press <Enter>.
7. Reboot the system when the update process is done.



-
- This function can support devices such as a USB flash disk with FAT 32/16 format and single partition only.
 - DO NOT shut down or reset the system while updating the BIOS to prevent system boot failure!
-



Ensure to load the BIOS default settings to ensure system compatibility and stability. Press <F5> and select **Yes** to load the BIOS default settings.

5.1.3 BUPDATER utility



The succeeding BIOS screens are for reference only. The actual BIOS screen displays may not be the same as shown.

The BUPDATER utility allows you to update the BIOS file in the DOS environment using a bootable USB flash disk drive with the updated BIOS file.

Updating the BIOS file

To update the BIOS file using the BUPDATER utility:

1. Visit the ASUS website at www.asus.com and download the latest BIOS file for the motherboard. Save the BIOS file to a bootable USB flash disk drive.
2. Copy the BUPDATER utility (BUPDATER.exe) from the ASUS support website at support.asus.com to the bootable USB flash disk drive you created earlier.
3. Boot the system in DOS mode, then at the prompt, type:

```
BUPDATER /i [filename] .CAP
```

where [filename] is the latest or the original BIOS file on the bootable USB flash disk drive, then press <Enter>.

```
A:\>BUPDATER /i[file name].CAP
```

4. The utility verifies the file, then starts updating the BIOS file.

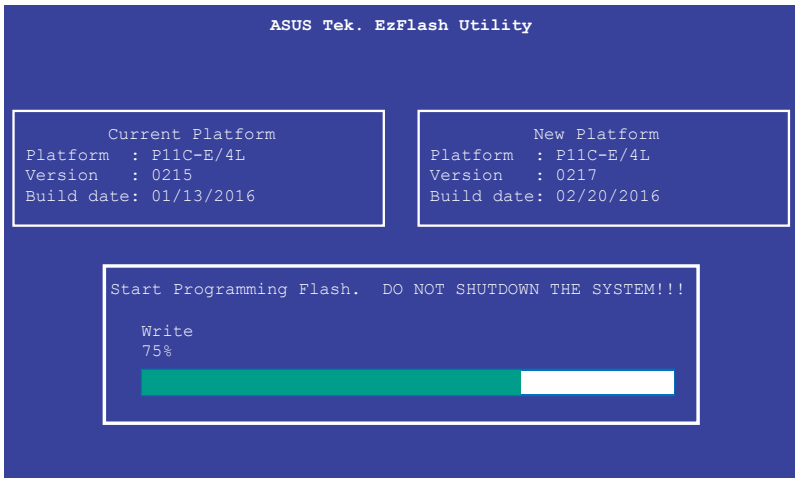

DO NOT shut down or reset the system while updating the BIOS to prevent system boot failure!

5. The utility returns to the DOS prompt after the BIOS update process is completed. Reboot the system from the hard disk drive.

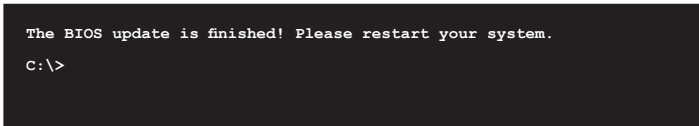

5.2 BIOS setup program

This motherboard supports a programmable firmware chip that you can update using the provided utility described in section **5.1 Managing and updating your BIOS**.

Use the BIOS Setup program when you are installing a motherboard, reconfiguring your system, or prompted to “Run Setup.” This section explains how to configure your system using this utility.

Even if you are not prompted to use the Setup program, you can change the configuration of your computer in the future. For example, you can enable the security password feature or change the power management settings. This requires you to reconfigure your system using the BIOS Setup program so that the computer can recognize these changes and record them in the CMOS RAM of the firmware chip.

The firmware chip on the motherboard stores the Setup utility. When you start up the computer, the system provides you with the opportunity to run this program. Press during the Power-On Self-Test (POST) to enter the Setup utility; otherwise, POST continues with its test routines.

If you wish to enter Setup after POST, restart the system by pressing <Ctrl>+<Alt>+, or by pressing the reset button on the system chassis. You can also restart by turning the system off and then back on. Do this last option only if the first two failed.

The Setup program is designed to make it as easy to use as possible. Being a menu-driven program, it lets you scroll through the various sub-menus and make your selections from the available options using the navigation keys.



-
- The default BIOS settings for this motherboard apply for most conditions to ensure optimum performance. If the system becomes unstable after changing any BIOS settings, load the default settings to ensure system compatibility and stability. Press <F5> and select **Yes** to load the BIOS default settings.
 - The BIOS setup screens shown in this section are for reference purposes only, and may not exactly match what you see on your screen.
 - Visit the ASUS website (www.asus.com) to download the latest BIOS file for this motherboard.
-

5.2.1 BIOS menu screen

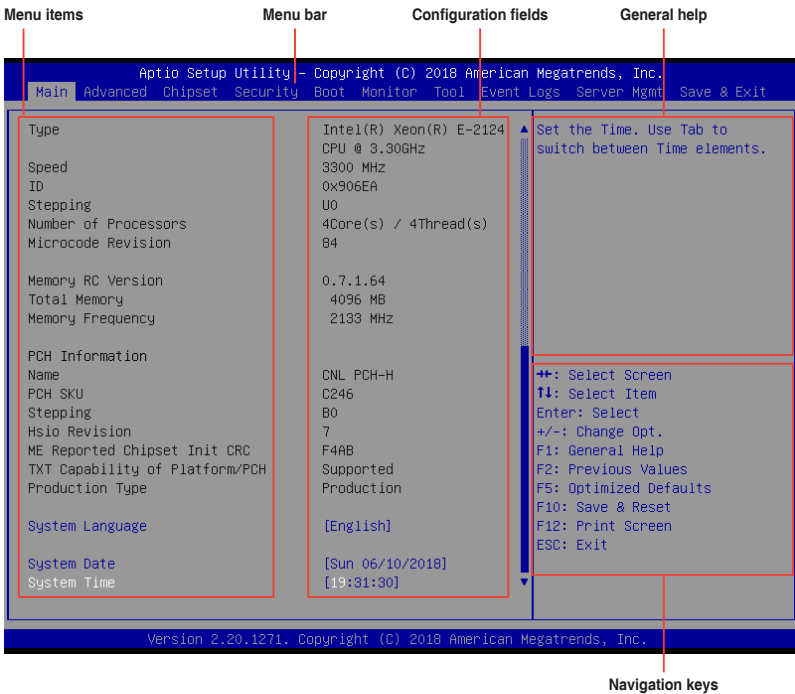

4.2.2 Menu bar

The menu bar on top of the screen has the following main items:

- Main** For changing the basic system configuration
- Advanced** For changing the advanced system settings
- Chipset** For changing the chipset settings
- Security** For changing the security settings
- Boot** For changing the system boot configuration
- Monitor** For displaying the system temperature, power status, and changing the fan settings
- Tool** For configuring options for special functions
- Event Logs** For changing the event log settings
- Server Mgmt** For changing the server mgmt settings
- Save & Exit** For selecting the save & exit options

To select an item on the menu bar, press the right or left arrow key on the keyboard until the desired item is highlighted.

5.2.3 Menu items

The highlighted item on the menu bar displays the specific items for that menu. For example, selecting **Main** shows the Main menu items. The other items (Advanced, Security, Boot, Monitor, Tool, Save & Exit, Server Mgmt, and Event Logs) on the menu bar have their respective menu items.

5.2.4 Submenu items

A solid triangle before each item on any menu screen means that the item has a submenu. To display the submenu, select the item and press <Enter>.

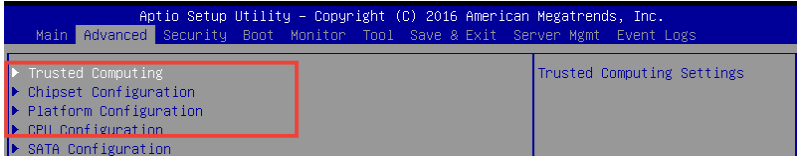

5.2.5 Navigation keys

At the bottom right corner of a menu screen are the navigation keys for the BIOS setup program. Use the navigation keys to select items in the menu and change the settings.

5.2.6 General help

At the top right corner of the menu screen is a brief description of the selected item.

5.2.7 Configuration fields

These fields show the values for the menu items. If an item is user-configurable, you can change the value of the field opposite the item. You cannot select an item that is not user-configurable.

A configurable field is enclosed in brackets, and is highlighted when selected. To change the value of a field, select it and press <Enter> to display a list of options.

5.2.8 Pop-up window

Select a menu item and press <Enter> to display a pop-up window with the configuration options for that item.

5.2.9 Scroll bar

A scroll bar appears on the right side of a menu screen when there are items that do not fit on the screen. Press the Up/Down arrow keys or <Page Up> / <Page Down> keys to display the other items on the screen.

5.3 Main menu

When you enter the BIOS Setup program, the Main menu screen appears. The Main menu provides you an overview of the basic system information, and allows you to set the system date, time, and language.

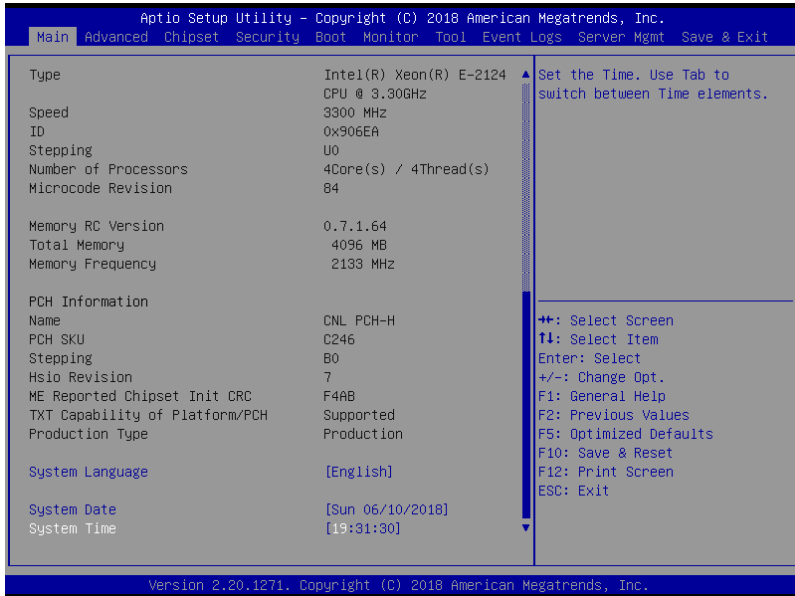

Navigate to the second page of the screen to see the rest of items in this menu by pressing the Up or Down arrow keys.



To quickly go to the last item of the second page, press the **Page Down** button. Press the **Page Up** button to go back to the first item in the first page.

System Date [Day MM/DD/YYYY]

Allows you to set the system date.

System Time [HH:MM:SS]

Allows you to set the system time.

5.4 Advanced menu

The Advanced menu items allow you to change the settings for the CPU and other system devices.



Take caution when changing the settings of the Advanced menu items. Incorrect field values can cause the system to malfunction.

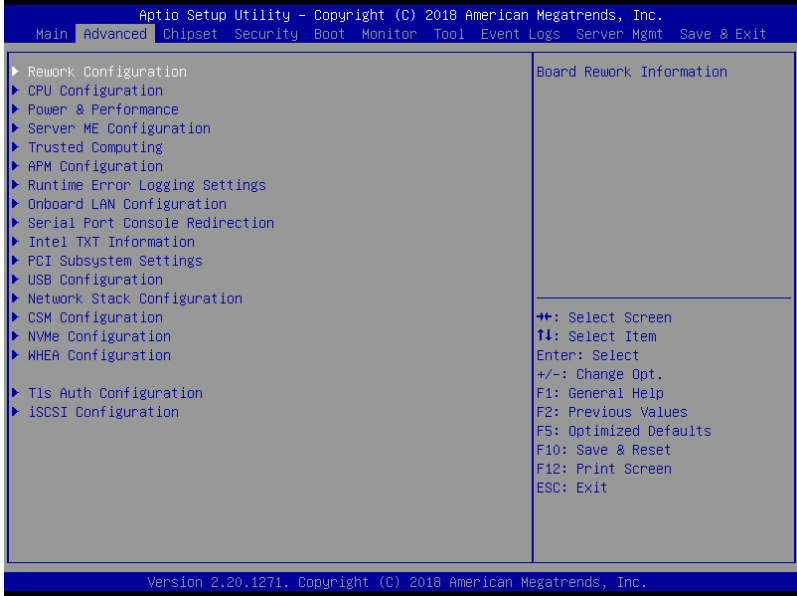

5.4.1 Rework Configuration

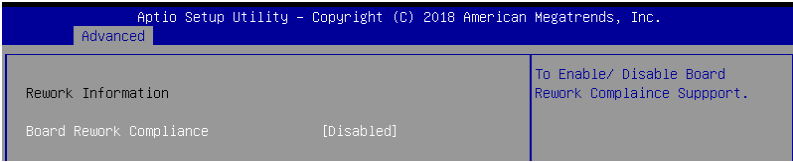

Board Rework Compliance [Disabled]

This option allows you to enable or disable Board Rework Compliance Support.

Configuration options: [Enabled] [Disabled]

5.4.2 CPU Configuration

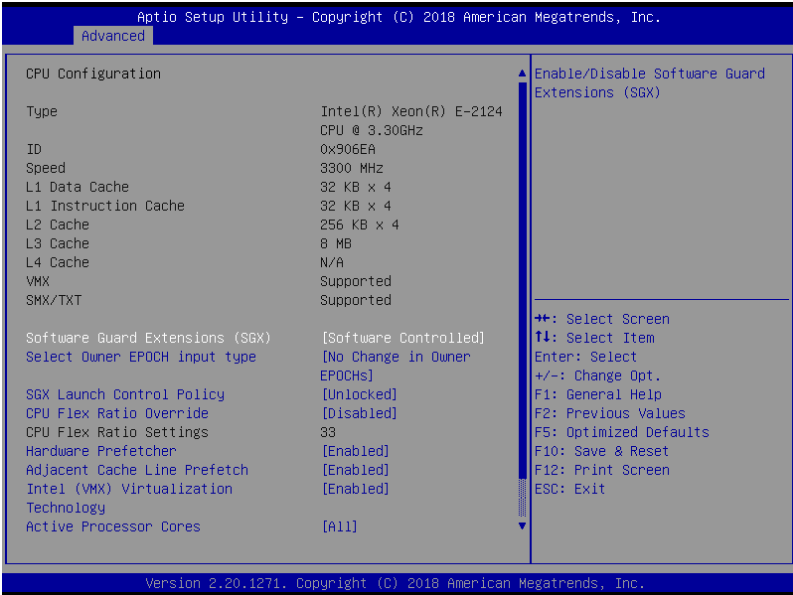

Software Guard Extensions (SGX) [Software Controlled]

Allows you to select the behavior of Software Guard Extensions (SGX).
Configuration options: [Software Controlled] [Disabled] [Enabled]



The following items appear only when you set **Software Guard Extensions (SGX)** to **[Enabled]** or **[Software Controlled]**.

Select Owner EPOCH input type [No change in Owner EPOCHs]

Allows you to select the behavior of EPOCH input type.
Configuration options: [No change in Owner EPOCHs] [Change to New Random EPOCHs] [Manual User Defined Owner EPOCHs]

SGX Launch Control Policy [Unlocked]

Allows you to select the behavior of SGX Launch Control Policy.
Configuration options: [Intel Locked] [Unlocked] [Locked]



The following items appear only when you set **SGX Launch Control Policy** to **[Locked]**.

SGX LE Public Key Hash 0-3 [0]

Allows you to set the Bytes of the Software Guard Extensions (SGX) Launch Enclave Public Key Hash.



The following item appears only when you set **Software Guard Extensions (SGX)** to **[Enabled]**.

PRMRR Size [128MB]

Allows you to set the PRMRR Size.
Configuration options: [32MB] [64MB] [128MB]

CPU Flex Ratio Override [Disabled]

Allows you to enable or disable CPU Flex Ratio Override.
Configuration options: [Disabled] [Enabled]



The following item appears only when you set **CPU Flex Ratio Override** to **[Enabled]**.

CPU Flex Ratio Settings [33]

Allows you to set the CPU Flex Ratio.
This value must be between the Max Efficiency Ratio (LFM) and the Maximum non-turbo ratio set by the Hardware (HFW).

Hardware Prefetcher [Enabled]

This Item allows you to turn on/off the MLC streamer prefetcher.
Configuration options: [Disabled] [Enabled]

Adjacent Cache Prefetch [Enabled]

This Item allows you to turn on/off prefetching of adjacent cache lines.
Configuration options: [Disabled] [Enabled]

Intel (VMX) Virtualization Technology [Enabled]

Enable this item to allow a VMM to utilize the additional hardware capabilities provided by Vanderpool Technology.

Configuration options: [Disabled] [Enabled]

Active Processor Cores [All]

This item allows you to set the number of cores to enable in each processor package.

Configuration options: [All] [1] [2] [3]

BIST [Disabled]

Allows you to enable or disable BIST (Built-In Self Test) on reset.

Configuration options: [Disabled] [Enabled]

AES [Enabled]

Allows you to enable or disable AES (Advanced Encryption Standard).

Configuration options: [Disabled] [Enabled]

Intel Trusted Execution Technology [Disabled]

Allows you to enable or disable utilization of additional hardware capabilities provided by Intel(R) Trusted Execution Technology. Changes require a full power cycle to take effect.

Configuration options: [Disabled] [Enabled]

5.4.3 Power & Performance

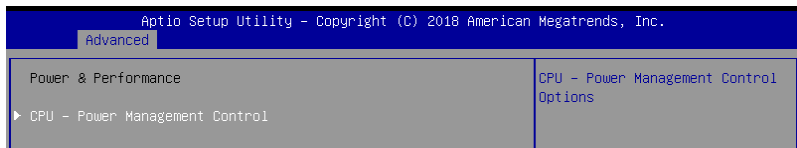

CPU - Power Management Control

Boot performance mode [Max Non-Turbo Performance]

This item allows you to select the performance state that the BIOS will set starting from reset vector.

Configuration options: [Max Battery] [Max Non-Turbo Performance] [Turbo Performance]

Intel(R) SpeedStep(tm) [Enabled]

Allows more than two frequency ranges to be supported.

Configuration options: [Disabled] [Enabled]

Race To Halt (RTH) [Enabled]

Allows you to enable or disable Race To Halt feature. RTH will dynamically increase CPU frequency in order to enter pkg C-State faster to reduce overall power. RTH is controlled through MSR 1FC bit 20.

Configuration options: [Disabled] [Enabled]

Intel(R) Speed Shift Technology [Disabled]

Allows you to enable or disable Intel(R) Speed Shift Technology support. Enabling will expose the CPPC v2 interface to allow for hardware controlled P-states.

Configuration options: [Disabled] [Enabled]

HDC Control [Enabled]

[Disabled] Disable HDC.

[Enabled] Can be enable by OS if OS native support available.

Turbo Mode [Enabled]

Allows you to enable or disable processor turbo mode if EMTTM is also enabled.

Configuration options: [Disabled] [Enabled]

C-States [Enabled]

Allows you to enable or disable CPU power management, this allows the CPU to enter C-state when it is not 100% utilized.

Configuration options: [Disabled] [Enabled]



The following items appears only when you set **C-States** to **[Enabled]**.

Enhanced C-States [Enabled]

Allows you to enable or disable C11E. Enable this item to allow the CPU to switch to minimum speed when all cores enter C-State.

Configuration options: [Disabled] [Enabled]

C-State Auto Demotion [C1 and C3]

This item allows you to configure the C-state auto demotion.

Configuration options: [Disabled] [C1] [C3] [C1 and C3]

C-State Un-demotion [C1 and C3]

This item allows you to configure the C-state Un-demotion.

Configuration options: [Disabled] [C1] [C3] [C1 and C3]

Package C-State Demotion [Disabled]

This item allows you to configure the Package C-State Demotion.

Configuration options: [Disabled] [Enabled]

Package C-State Un-demotion [Disabled]

This item allows you to configure the Package C-state Un-demotion.

Configuration options: [Disabled] [Enabled]

Package C-state Limit [Auto]

This item allows you to select the maximum package C-state limit setting.

Configuration options: [C0/C1] [C2] [C3] [C6] [C7] [C7S] [C8] [C9] [C10] [CPU Default] [Auto]

Thermal Monitor [Enabled]

Allows you to enable or disable Thermal Monitoring.
Configuration options: [Disabled] [Enabled]

5.4.4 Server ME Configuration

The screenshot shows the Aptio Setup Utility interface. At the top, it says "Aptio Setup Utility - Copyright (C) 2018 American Megatrends, Inc." Below that is a blue bar with the word "Advanced" in white. The main area is a table with two columns. The left column lists configuration items, and the right column provides a description. The items listed are: Server ME Configuration, Operational Firmware Version (00:12.0.2.1088), Backup Firmware Version (00:12.0.2.1088), Recovery Firmware Version (00:12.0.2.1088), ME Firmware Features (N/A), ME Firmware Status #1 (0x90000255), ME Firmware Status #2 (0x8610810E), Current State (Operational), Error Code (No Error), and TPM Device Selection ([PTT]). The right column text reads: "Selects TPM device: PTT or dTPM. PTT - Enables PTT in SkuMgr dTPM 1.2 - Disables PTT in SkuMgr Warning ! PTT/dTPM will be disabled and all data saved on it will be lost." Below the table is a legend for keyboard shortcuts: "+*": Select Screen, "11": Select Item, Enter: Select, +/-: Change Opt., F1: General Help, F2: Previous Values, F5: Optimized Defaults, F10: Save & Reset, F12: Print Screen, ESC: Exit.

Server ME Configuration		Selects TPM device: PTT or dTPM. PTT - Enables PTT in SkuMgr dTPM 1.2 - Disables PTT in SkuMgr Warning ! PTT/dTPM will be disabled and all data saved on it will be lost.
Operational Firmware Version	00:12.0.2.1088	
Backup Firmware Version	00:12.0.2.1088	
Recovery Firmware Version	00:12.0.2.1088	
ME Firmware Features	N/A	
ME Firmware Status #1	0x90000255	
ME Firmware Status #2	0x8610810E	
Current State	Operational	
Error Code	No Error	
TPM Device Selection	[PTT]	

+*: Select Screen
11: Select Item
Enter: Select
+/-: Change Opt.
F1: General Help
F2: Previous Values
F5: Optimized Defaults
F10: Save & Reset
F12: Print Screen
ESC: Exit

TPM Device Selection [PTT]

Allows you to select the TPM device.
Configuration options: [PTT] [dTPM]

5.4.5 Trusted Computing

The screenshot shows the Aptio Setup Utility interface. At the top, it says "Aptio Setup Utility - Copyright (C) 2018 American Megatrends, Inc." Below that is a blue bar with the word "Advanced" in white. The main area is a table with two columns. The left column lists configuration items, and the right column provides a description. The items listed are: TPM20 Device Found (Firmware Version: 402.2, Vendor: INTC), Security Device Support ([Enabled]), Active PCR banks (SHA-1, SHA256), and Available PCR banks (SHA-1, SHA256). The right column text reads: "Enables or Disables BIOS support for security device. O.S. will not show Security Device. TCG EFI protocol and INT1A interface will not be available." Below the table is a legend for keyboard shortcuts: "+*": Select Screen, "11": Select Item, Enter: Select, +/-: Change Opt., F1: General Help, F2: Previous Values, F5: Optimized Defaults, F10: Save & Reset, F12: Print Screen, ESC: Exit.

TPM20 Device Found		Enables or Disables BIOS support for security device. O.S. will not show Security Device. TCG EFI protocol and INT1A interface will not be available.
Firmware Version:	402.2	
Vendor:	INTC	
Security Device Support	[Enabled]	
Active PCR banks	SHA-1, SHA256	
Available PCR banks	SHA-1, SHA256	

+*: Select Screen
11: Select Item
Enter: Select
+/-: Change Opt.
F1: General Help
F2: Previous Values
F5: Optimized Defaults
F10: Save & Reset
F12: Print Screen
ESC: Exit

Security Device Support [Enabled]

This item allows you to enable or disable Security Device Support.
Configuration options: [Disabled] [Enabled]

5.4.6 APM Configuration

Aptio Setup Utility - Copyright (C) 2018 American Megatrends, Inc.		
Advanced		
ErP	[Enable(S5)]	ErP

ErP [Enabled (S5)]

This item allows you to switch off some power at S4+S5 or S5 to get the system ready for ErP requirement. When set to **[Enabled]**, all other PME options are switched off.
Configuration options: [Disabled] [Enabled (S4+S5)] [Enabled (S5)]

5.4.7 Runtime Error Logging Settings

Aptio Setup Utility - Copyright (C) 2018 American Megatrends, Inc.		
Advanced		
Runtime Error Logging Settings		Runtime Error Logging System Enable/Disable
Runtime Error Logging System Enabling	[Enabled]	

Runtime Error Logging System Enabling [Enabled]

This item allows you to enable or disable Runtime Error Logging System.
Configuration options: [Disabled] [Enabled]

5.4.8 Onboard LAN Configuration

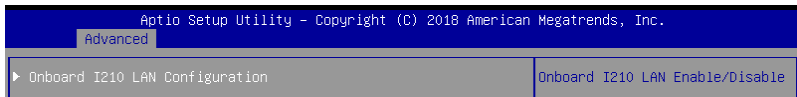

Onboard I210 LAN Configuration

Intel I210 LAN1

LAN Enable [Enabled]

Allows you to enable or disable the Intel LAN.

Configuration options: [Disabled] [Enabled]



The following item appears only when you set **LAN Enable** to [Enabled].

ROM Type [PXE]

Allows you to select the Intel LAN ROM type.

Configuration options: [Disabled] [PXE] [iSCSI]



Due to Intel® limitations, both Intel LAN ROM Type options should be the same when [PXE] or [iSCSI] is selected.

Intel I210 LAN2-4

LAN Enable [Enabled]

Allows you to enable or disable the Intel LAN.

Configuration options: [Disabled] [Enabled]



The following item appears only when you set Intel **LAN Enable** to [Enabled].

ROM Type [Disabled]

Allows you to select the Intel LAN ROM type.

Configuration options: [Disabled] [PXE] [iSCSI]



Due to Intel® limitations, both Intel LAN ROM Type options should be the same when [PXE] or [iSCSI] is selected.

5.4.9 Serial Port Console Redirection

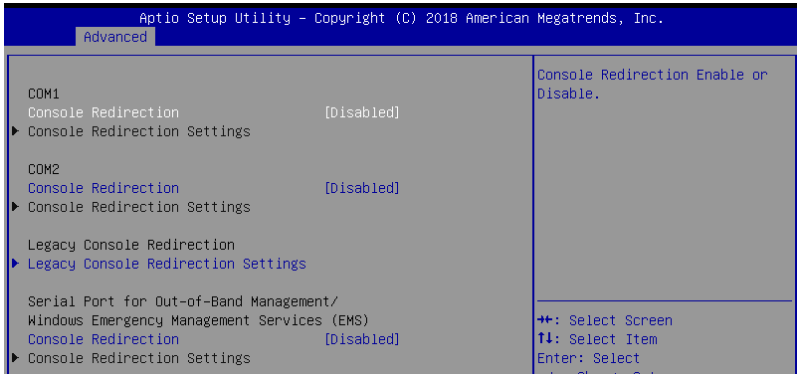

COM1/COM2

Console Redirection [Disabled]

Allows you to enable or disable the console redirection feature.

Configuration options: [Disabled] [Enabled]



The following item appears only when you set **Console Redirection** to **[Enabled]**.

Console Redirection Settings

These items become configurable only when you enable the **Console Redirection** item. The settings specify how the host computer and the remote computer (which the user is using) will exchange data. Both computers should have the same or compatible settings.

Terminal Type [VT-UTF8]

Allows you to set the terminal type.

[VT100] ASCII char set.

[VT100+] Extends VT100 to support color, function keys, etc.

[VT-UTF8] Uses UTF8 encoding to map Unicode chars onto 1 or more bytes.

[ANSI] Extended ASCII char set.

Bits per second [57600]

Selects serial port transmission speed. The speed must be matched on the other side. Long or noisy lines may require lower speeds.

Configuration options: [9600] [19200] [38400] [57600] [115200]

Data Bits [8]

Configuration options: [7] [8]

Parity [None]

A parity bit can be sent with the data bits to detect some transmission errors. [Mark] and [Space] parity do not allow for error detection.

[None]	None
[Even]	parity bit is 0 if the num of 1's in the data bits is even
[Odd]	parity bit is 0 if num of 1's in the data bits is odd
[Mark]	parity bit is always 1
[Space]	parity bit is always 0

Stop Bits [1]

Stop bits indicate the end of a serial data packet. (A start bit indicates the beginning.) The standard setting is 1 stop bit. Communication with slow devices may require more than 1 stop bit.

Configuration options: [1] [2]

Flow Control [Hardware RTS/CTS]

Flow control can prevent data loss from buffer overflow. When sending data, if the receiving buffers are full, a "stop" signal can be sent to stop the data flow. Once the buffers are empty, a "start" signal can be sent to re-start the flow. Hardware flow control uses two wires to send start/stop signals.

Configuration options: [None] [Hardware RTS/CTS]

VT -UTF8 Combo Key Support [Enabled]

This allows you to enable the VT -UTF8 Combination Key Support for ANSI/VT100 terminals.

Configuration options: [Disabled] [Enabled]

Recorder Mode [Disabled]

With this mode enabled only text will be sent. This is to capture Terminal data.

Configuration options: [Disabled] [Enabled]

Resolution 100x31 [Disabled]

This allows you to enable or disable extended terminal resolution.

Configuration options: [Disabled] [Enabled]

Putty Keypad [VT100]

This allows you to select the FunctionKey and Keypad on Putty.

Configuration options: [VT100] [LINUX] [XTERMR6] [SCO] [ESCN] [VT400]

Legacy Console Redirection Settings

Redirection COM Port [COM1]

Allows you to select a COM port to display redirection of Legacy OS and Legacy OPROM Messages.

Configuration options: [COM1] [COM2]

Resolution [80x24]

Allows you to select a the number of rows and columns in supported redirection.

Configuration options: [80x24] [80x25]

Redirect After POST [Always Enable]

Allows you to select the redirection after POST.

Configuration options: [Always Enable] [BootLoader]

Serial Port for Out-of-Band Management/Windows Emergency Management Services (EMS)

Console Redirection [Disabled]

Allows you to enable or disable the console redirection feature.
Configuration options: [Disabled] [Enabled]



The following item appears only when you set **Console Redirection** to **[Enabled]**.

Console Redirection Settings

Out-of-Band Mgmt Port [COM1]

Microsoft Windows Emergency Management Services (EMS) allow for remote management of a Windows Server OS through a serial port.
Configuration options: [COM1] [COM2]

Terminal Type [VT-UTF8]

Microsoft Windows Emergency Management Services (EMS) allow for remote management of a Windows Server OS through a serial port.
Configuration options: [VT100] [VT100+] [VT-UTF8] [ANSI]

Bits per second [115200]

Microsoft Windows Emergency Management Services (EMS) allow for remote management of a Windows Server OS through a serial port.
Configuration options: [9600] [19200] [57600] [115200]

Flow Control [None]

Microsoft Windows Emergency Management Services (EMS) allow for remote management of a Windows Server OS through a serial port.
Configuration options: [None] [Hardware RTS/CTS] [Software Xon/Xoff]

5.4.10 Intel TXT Information

You may view the Intel TXT information in this menu.

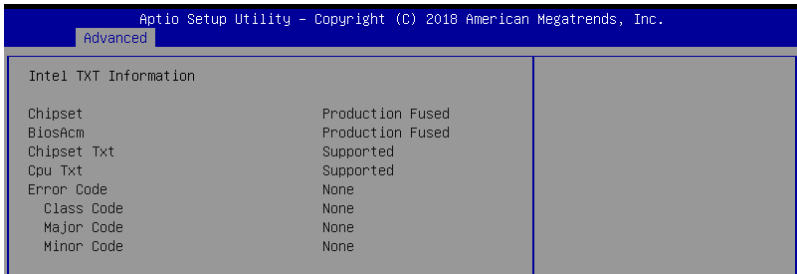

5.4.11 PCI Subsystem Settings

Allows you to configure PCI, PCI-X, and PCI Express Settings.

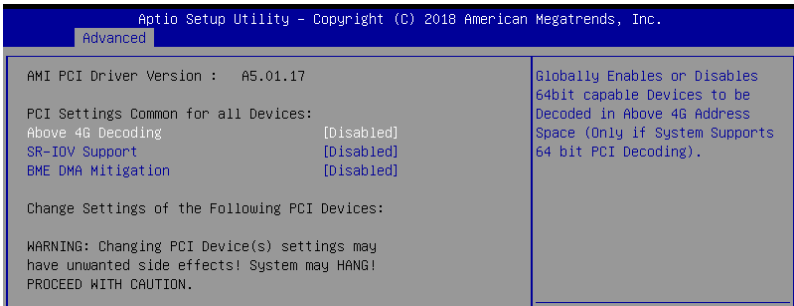

Above 4G Decoding [Disabled]

Allows you to enable or disable 64-bit capable devices to be decoded in above 4G address space. It only works if the system supports 64-bit PCI decoding.

Configuration options: [Disabled] [Enabled]

SR-IOV Support [Disabled]

This allows you to enable or disable Single Root IO Virtualization Support, if your system has SR-IOV capable PCIe Devices.

Configuration options: [Disabled] [Enabled]

BME DMA Mitigation [Disabled]

This allows you to enable or disable re-enabling Bus Master Attribute disabled during Pci enumeration for PCI Bridges after SMM locked.

Configuration options: [Disabled] [Enabled]

5.4.12 USB Configuration

Aptio Setup Utility - Copyright (C) 2018 American Megatrends, Inc.	
Advanced	
USB Configuration	Enables Legacy USB support. AUTO option disables legacy support if no USB devices are connected. DISABLE option will keep USB devices available only for EFI applications.
USB Module Version	20
USB Controllers:	
1 XHCI	
USB Devices:	
1 Drive, 1 Keyboard, 1 Mouse	
Legacy USB Support	[Enabled]
XHCI Hand-off	[Enabled]
USB Mass Storage Driver Support	[Enabled]
Port 60/64 Emulation	[Enabled]
USB hardware delays and time-outs:	
USB transfer time-out	[20 sec]
Device reset time-out	[20 sec]
Device power-up delay	[Auto]
Mass Storage Devices:	
JetFlashTranscend 4GB 8.07	[Auto]

Legacy USB Support [Enabled]

[Disabled] The USB devices can be used only for the BIOS setup program. It cannot be recognized in boot devices list.

[Enabled] Enables the support for USB devices on legacy operating systems (OS).

[Auto] Allows the system to detect the presence of USB devices at startup. If detected, the USB controller legacy mode is enabled. If no USB device is detected, the legacy USB support is disabled.

XHCI Hand-off [Enabled]

Allows you to enable or disable workaround for OS(s) without XHCI hand-off support.
Configuration options: [Disabled] [Enabled]

USB Mass Storage Driver Support [Enabled]

Allows you to enable or disable USB Mass Storage driver support.
Configuration options: [Disabled] [Enabled]

Port 60/64 Emulation [Enabled]

Allows you to enable or disable Port 60/64 Emulation.
Configuration options: [Disabled] [Enabled]

USB hardware delays and time-outs

USB transfer time-out [20 sec]

Allows you to set the USB transfer time-out value.
Configuration options: [1 sec] [5 sec] [10 sec] [20 sec]

Device reset time-out [20 sec]

Allows you to set the device reset time-out value.
Configuration options: [10 sec] [20 sec] [30 sec] [40 sec]

Device power-up delay [Auto]

Allows you to set the maximum time the device takes before the device reports itself to the host controller properly.

Configuration options: [Auto] [Manual]



The following item appears only when you set **Device power-up delay** to [Manual].

Device power-up delay in seconds [5]

Allows you to set the device power-up delay in seconds. Use the <+> or <-> to adjust the value. The values range from 1 to 40.

Mass Storage Devices

Allows you to select the mass storage device emulation type for devices connected.

Configuration options: [Auto] [Floppy] [Forced FDD] [Hard Disk] [CD-ROM]

5.4.13 Network Stack Configuration

Allows you to configure the network stack configuration.

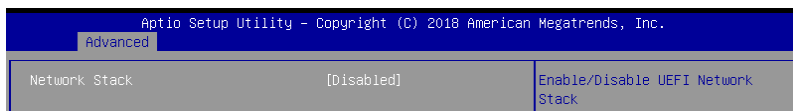

Network Stack [Disabled]

Allows you to enable or disable UEFI Network Stack.

Configuration options: [Disabled] [Enabled]



The following items appear only when you set **Network Stack** to [Enabled].

Ipv4 PXE Support [Disabled]

Enables or disables the Ipv4 PXE Boot Support. If disabled, Ipv4 PXE boot option will not be created.

Configuration options: [Disabled] [Enabled]

Ipv4 HTTP Support [Disabled]

Enables or disables the Ipv4 HTTP Boot Support. If disabled, Ipv4 PXE boot option will not be created.

Configuration options: [Disabled] [Enabled]

Ipv6 PXE Support [Disabled]

Enables or disables the Ipv6 PXE Boot Support. If disabled, Ipv6 PXE boot option will not be created.

Configuration options: [Disabled] [Enabled]

Ipv6 HTTP Support [Disabled]

Enables or disables the Ipv6 HTTP Boot Support. If disabled, Ipv6 PXE boot option will not be created.

Configuration options: [Disabled] [Enabled]

IPSEC Certificate [Enabled]

Enables or disables support for IPSEC Certificate.
Configuration options: [Disabled] [Enabled]

PXE boot wait time [0]

Set the wait time to press ESC key to abort the PXE boot. Use the <+> or <-> to adjust the value. The values range from 0 to 5.

Media detect count [1]

Set the number of times presence of media will be checked. Use the <+> or <-> to adjust the value. The values range from 1 to 50.

5.4.14 CSM Configuration

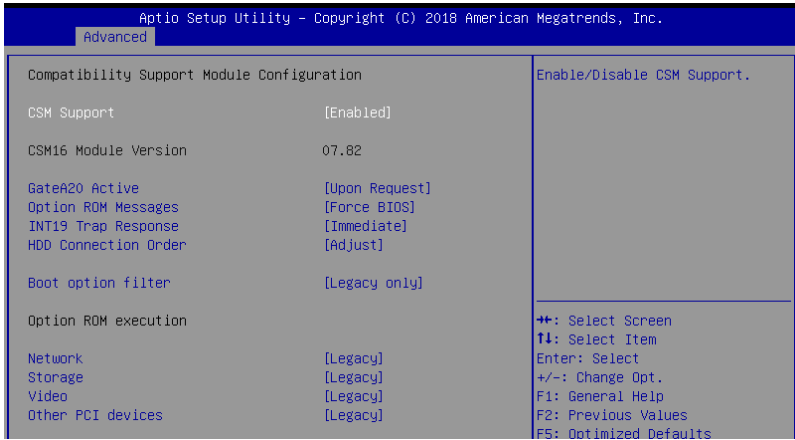

CSM Support [Enabled]

This option allows you to enable or disable CSM Support.
Configuration options: [Disabled] [Enabled]



The following items appear only when you set **CSM Support** to **[Enabled]**.

GateA20 Active [Upon Request]

This allows you to set the GA20 option.

[Upon Request]	GA20 can be disabled using BIOS services.
[Always]	Do not allow disabling GA20; this option is useful when any RT code is executed above 1MB.

Option ROM Messages [Force BIOS]

This allows you to set the display mode for option ROM.

Configuration options: [Force BIOS] [Keep Current]

INT19 Trap Response [Immediate]

This option allows you to control the BIOS reaction on INT19 trapping by Option ROM.

[Immediate]	Execute the trap right away.
[Postponed]	Execute the trap during legacy boot.

HDD Connection Order [Adjust]

This option allows you to select the HDD Connection Order. Some OS require HDD handles to be adjusted.

Configuration options: [Adjust] [Keep]

Boot Option filter [Legacy only]

This option allows you to control the Legacy/UEFI ROMs priority.

Configuration options: [UEFI and Legacy] [Legacy only] [UEFI only]

Network / Storage / Video [Legacy]

This option allows you to control the execution of UEFI and Legacy PXE/ Storage/ Video OpROM.

Configuration options: [UEFI] [Legacy]

Other PCI devices [Legacy]

This item determines the OpROM execution policy for devices other than Network, Storage, or Video.

Configuration options: [UEFI] [Legacy]

5.4.15 NVMe Configuration

You may view the NVMe controller and Drive information if an NVMe device is connected.

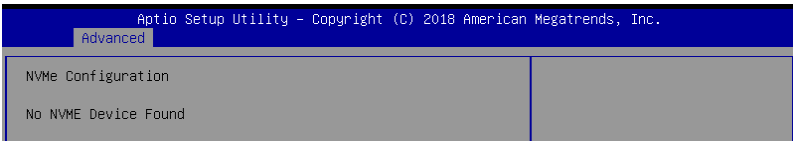

5.4.16 WHEA Configuration

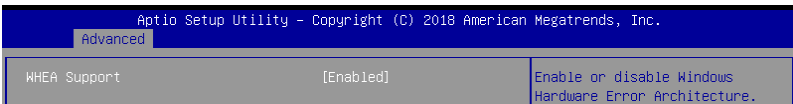

Whea Support [Enabled]

This item allows you to enable or disable the WHEA support.

Configuration options: [Disabled] [Enabled]

5.4.17 Tls Auth Configuration

Allows you to configure the Tls Auth.

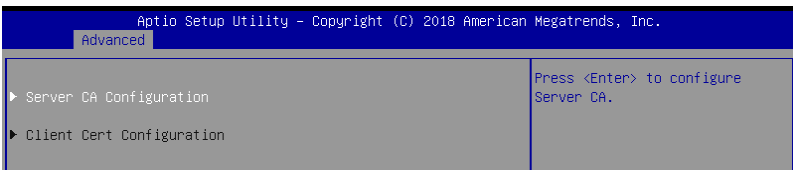

5.4.18 iSCSI Configuration

Allows you to configure the iSCSI parameters.

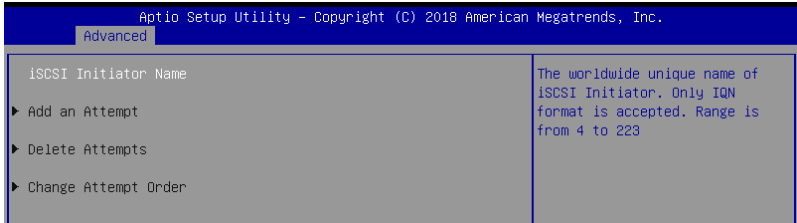

5.5 Chipset menu

The Chipset menu allows you to change the platform settings.

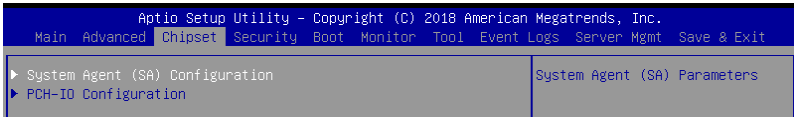

Take caution when changing the settings of the Chipset menu items. Incorrect field values can cause the system to malfunction.

5.5.1 System Agent (SA) Configuration

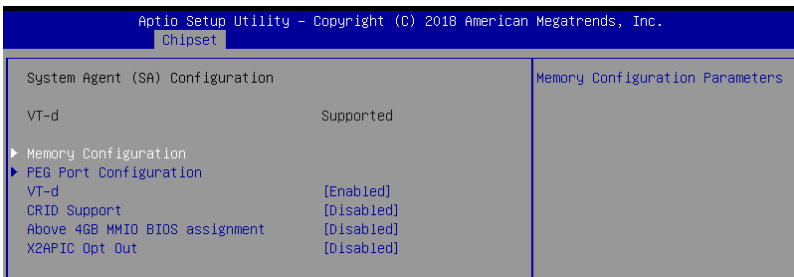

Memory Configuration

Memory Test on Warm Boot [Enabled]

Allows you to enable or disable the Base Memory Test Run on Warm Boot.
Configuration options: [Disabled] [Enabled]

Maximum Memory Frequency [Auto]

Allows you to select the maximum memory frequency setting.
Configuration options: [Auto] [2133] [2400] [2667]

ECC Support [Enabled]

Allows you to enable or disable the ECC support.
Configuration options: [Disabled] [Enabled]

Memory Scrambler [Enabled]

Allows you to enable or disable Memory Scrambler.
Configuration options: [Disabled] [Enabled]

Fast Boot [Disabled]

Allows you to enable or disable Fast Boot.
Configuration options: [Disabled] [Enabled]

PEG Port Configuration

PEG 0:1:0

Max Link Speed [Auto]

Allows you to set the Max Link Speed.

Configuration options: [Auto] [Gen1] [Gen2] [Gen3]

PEG0 Slot Power Limit Value [75]

Set the upper limit on power supplied by slot. Use the <+> or <-> to adjust the value. The values range from 0 to 255.

PEG0 Slot Power Limit Scale [1.0x]

Allows you to select the scale for the Slot Power Limit Value.

Configuration options: [1.0x] [0.1x] [0.01x] [0.001x]

PEG0 Physical Slot Number [1]

Allows you to set the physical slot number attached to this Port. The number has to be globally unique within the chassis. Use the <+> or <-> to adjust the value. The values range from 0 to 8191.

PEG 0:1:1

Max Link Speed [Auto]

Allows you to set the Max Link Speed.

Configuration options: [Auto] [Gen1] [Gen2] [Gen3]

PEG1 Slot Power Limit Value [75]

Set the upper limit on power supplied by slot. Use the <+> or <-> to adjust the value. The values range from 0 to 255.

PEG1 Slot Power Limit Scale [1.0x]

Allows you to select the scale for the Slot Power Limit Value.

Configuration options: [1.0x] [0.1x] [0.01x] [0.001x]

PEG1 Physical Slot Number [2]

Allows you to set the physical slot number attached to this Port. The number has to be globally unique within the chassis. Use the <+> or <-> to adjust the value. The values range from 0 to 8191.

PEG 0:1:2

Max Link Speed [Auto]

Allows you to set the Max Link Speed.

Configuration options: [Auto] [Gen1] [Gen2] [Gen3]

PEG2 Slot Power Limit Value [75]

Set the upper limit on power supplied by slot. Use the <+> or <-> to adjust the value. The values range from 0 to 255.

PEG2 Slot Power Limit Scale [1.0x]

Allows you to select the scale for the Slot Power Limit Value.

Configuration options: [1.0x] [0.1x] [0.01x] [0.001x]

PEG2 Physical Slot Number [3]

Allows you to set the physical slot number attached to this Port. The number has to be globally unique within the chassis. Use the <+> or <-> to adjust the value. The values range from 0 to 8191.

PEG3 Slot Power Limit Value [75]

Set the upper limit on power supplied by slot. Use the <+> or <-> to adjust the value. The values range from 0 to 255.

PEG3 Slot Power Limit Scale [1.0x]

Allows you to select the scale for the Slot Power Limit Value.

Configuration options: [1.0x] [0.1x] [0.01x] [0.001x]

PEG3 Physical Slot Number [3]

Allows you to set the physical slot number attached to this Port. The number has to be globally unique within the chassis. Use the <+> or <-> to adjust the value. The values range from 0 to 8191.

VT-d [Enabled]

Allows you to enable or disable VT-d capability.

Configuration options: [Disabled] [Enabled]

CRID Support [Disabled]

Allows you to enable or disable CRID control for Intel SIPP.

Configuration options: [Disabled] [Enabled]

Above 4GB MMIO BIOS Assignment [Disabled]

Allows you to enable or disable above 4 GB memory mapped IO BIOS assignment. This is enabled automatically if the aperture size is set to 2048MB.

Configuration options: [Disabled] [Enabled]



The following item is configurable only when you set **VT-d** to **[Enabled]**.

X2APIC Opt Out [Disabled]

Allows you to enable or disable X2APIC Opt Out.

Configuration options: [Disabled] [Enabled]

5.5.2 PCH-IO Configuration

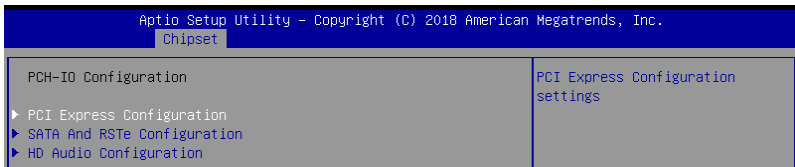

PCI Express Configuration

PCI Express Clock Gating [Enabled]

Allows you to enable or disable PCI Express clock gating for each root port.

Configuration options: [Disabled] [Enabled]

DMI Link ASPM Control [Auto]

Allows you to enable or disable control of active state power management of DMI link.
Configuration options: [Disabled] [L0s] [L1] [L0sL1] [Auto]

Port8xh Decode [Disabled]

Allows you to enable or PCI express port 8xh decode.
Configuration options: [Disabled] [Enabled]



The following item appears only when you set **Port8xh Decode** to **[Enabled]**.

Port8xh Decode Port# [0]

Select PCI Express Port8xh Decode Root Port. User to ensure port availability.
Configuration options: [0] - [23]

SATA And RSTe Configuration

SATA Controller(s) [Enabled]

Allows you to enable or disable the SATA Controller.
Configuration options: [Disabled] [Enabled]



The following items appear only when you set **SATA Controller(s)** to **[Enabled]**.

SATA Mode Selection [AHCI]

Allows you to select the SATA controllers operation.
Configuration options: [AHCI] [RAID]

Serial ATA Port 1-8

Port 1-8 [Enabled]

Allows you to enable or disable the SATA port.
Configuration options: [Disabled] [Enabled]

Hot Plug [Enabled]

Allows you to enable or disable this port as hot pluggable.
Configuration options: [Disabled] [Enabled]

Spin Up Device [Disabled]

Allows you to enable or disable Spin Up Device.
Configuration options: [Disabled] [Enabled]

SATA Device Type [Hard Disk Drive]

Allows you to identify the SATA port is connected to a solid state drive or a hard disk drive
Configuration options: [Hard Disk Drive] [Solid State Drive]

HD Audio Configuration

HD Audio [Enabled]

Allows you to enable or disable the HD Audio.

Configuration options: [Disabled] [Enabled]

Audio DSP [Disabled]

Allows you to enable or disable the Audio DSP.

Configuration options: [Disabled] [Enabled]

Audio Link Mode [HD Audio Link]

Allows you to select the audio link mode.

Configuration options: [HD Audio Link] [SSP (i2S)] [Soundwire] [Advanced Link Config]

HDA-Link Codec Select [Platform Onboard]

Allows you to select the HDA-Link Codec.

Configuration options: [Platform Onboard] [External Kit]

HD Audio Advanced Configuration

iDisplay Audio Disconnect [Disabled]

Allows you to enable or disable iDisplay Audio Disconnect.

Configuration options: [Disabled] [Enabled]

Codec Sx Wake Capability [Disabled]

Allows you to enable or disable Codec Sx Wake Capability.

Configuration options: [Disabled] [Enabled]

PME Enable [Disabled]

Allows you to enable or disable PME wake of HD Audio controller during POST.

Configuration options: [Disabled] [Enabled]



The following item appears only when you set the **Audio Link Mode** to [Soundwire].

Soundwire Buffer RCOMP Setting [Non-ACT Topology]

This item allows you to select the Soundwire Buffer RCOMP Setting.

Configuration options: [Non-ACT Topology] [ACT Topology]

HD Audio Link Frequency [24 MHz]

Allows you to select the HD Audio Link Frequency.

Configuration options: [6 MHz] [12 MHz] [24 MHz]

iDisplay Audio Link Frequency [96 MHz]

Allows you to select the iDisplay Audio Link Frequency.

Configuration options: [48 MHz] [96 MHz]

iDisplay Audio Link T-Mode [2T Mode]

Allows you to select the iDisplay Audio Link T-Mode.

Configuration options: [1T Mode][2T Mode]

5.6 Security menu

This menu allows a new password to be created or a current password to be changed. The menu also enables or disables the Secure Boot state and lets the user configure the System Mode state.

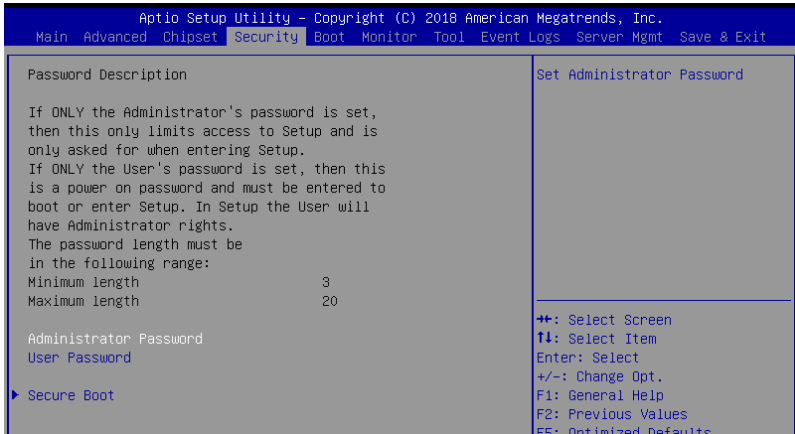

Administrator Password

To set an administrator password:

1. Select the Administrator Password item and press <Enter>.
2. From the Create New Administrator Password box, key in a password, then press <Enter>.
3. Confirm the password when prompted.

To change an administrator password:

1. Select the Administrator Password item and press <Enter>.
2. From the Enter Current Password box, key in the current password, then press <Enter>.
3. From the Create New Password box, key in a new password, then press <Enter>.
4. Confirm the password when prompted.



To clear the administrator password, follow the same steps as in changing an administrator password, but press <Enter> when prompted to create/confirm the password.

User Password

To set a user password:

1. Select the User Password item and press <Enter>.
2. From the Create New User Password box, key in a password, then press <Enter>.
3. Confirm the password when prompted.

To change a user password:

1. Select the User Password item and press <Enter>.
2. From the Enter Current Password box, key in the current password, then press <Enter>.
3. From the Create New Password box, key in a new password, then press <Enter>.
4. Confirm the password when prompted.

To clear a user password:

1. Select the Clear User Password item and press <Enter>.
2. Select Yes from the Warning message window then press <Enter>.

Secure Boot

This item allows you to customize the Secure Boot settings.

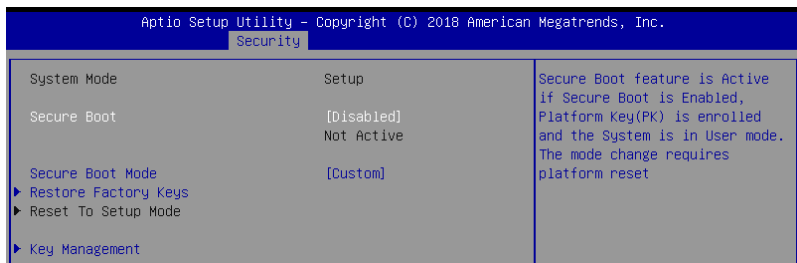

Secure Boot [Disabled]

Secure Boot can be enabled if the system is running in User mode with enrolled platform Key (EPK) or if the CSM function is disabled.

Configuration options: [Disabled] [Enabled]

Secure Boot Mode [Custom]

Allows you to set the Secure Boot selector.

Configuration options: [Custom] [Standard]

Restore Factory Keys

This option will force the system to User Mode, and install factory default Secure Boot key databases.

Key Management

This item only appears when the item **Secure Boot Mode** is set to **[Custom]**. The Key Management item allows you to modify Secure Boot variables and set Key Management page.

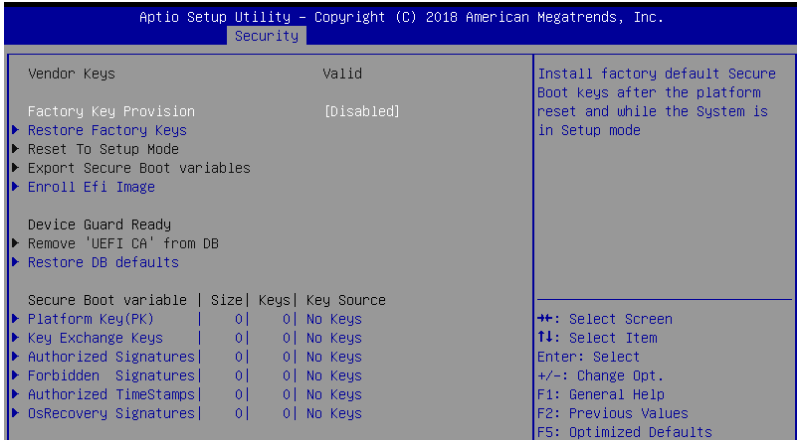

Factory Key Provision [Disabled]

Allows you to provision factory default Secure Boot keys when the system is in Setup Mode.

Configuration options: [Disabled] [Enabled]

Restore Factory keys

This item will install all Factory Default keys.

Reset to Setup Mode

This item appears only when you load the default Secure Boot keys. This item allows you to clear all default Secure Boot keys.

Export Secure Boot Variables

This item will ask you if you want to save all secure boot variables. Select Yes if you want to save all secure boot variables, otherwise select No.

Enroll Efi Image

This item will allow the image to run in Secure Boot mode.

Configuration options: [Set New] [Append]

Device Guard Ready

Remove 'UEFI CA' from DB

Remove Microsoft UEFI CA from Secure Boot DB.

Restore DB defaults

Restore DB variable to factory defaults.

Platform Key (PK)

Configuration options: [Details] [Export] [Update] [Delete]

Key Exchange Keys (KEK) / Authorized Signatures (DB) / Forbidden Signatures (DBX)

Configuration options: [Details] [Export] [Update] [Append] [Delete]

Authorized TimeStamps (DBT) / OsRecovery Signatures

Configuration options: [Update] [Append]

5.7 Boot menu

The Boot menu items allow you to change the system boot options.

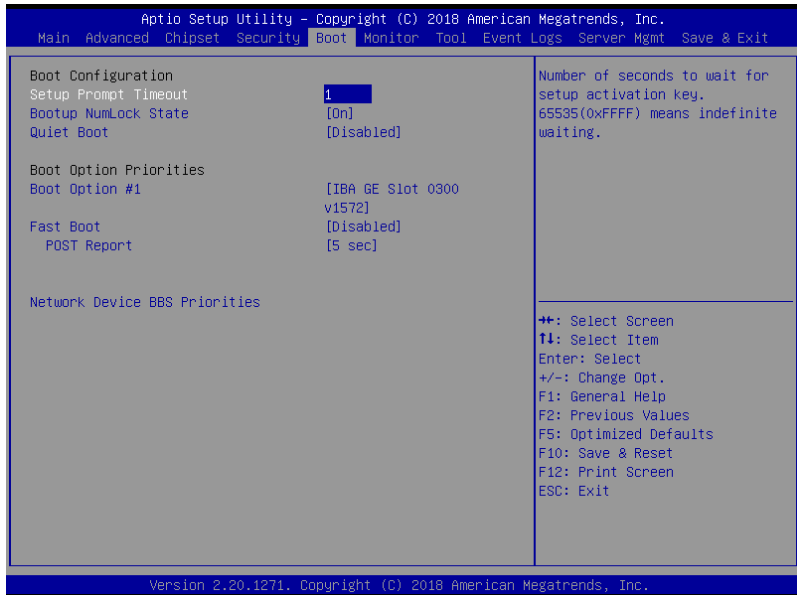

Setup Prompt Timeout [1]

Allows you to set the number of seconds that the firmware waits before initiating the original default boot selection. 65535(0xFFFF) means indefinite waiting. Use the <+> or <-> to adjust the value.

Bootup NumLock State [On]

Allows you to select the power-on state for the NumLock.
Configuration options: [Off] [On]

Quiet Boot [Disabled]

Allows you to enable or disable Quiet Boot option.
Configuration options: [Disabled] [Enabled]

Boot Option Priorities

These items specify the boot device priority sequence from the available devices. The number of device items that appears on the screen depends on the number of devices installed in the system.



- To select the boot device during system startup, press <F8> when ASUS Logo appears.
- To access Windows OS in Safe Mode, please press <F8> after POST.

Fast Boot [Disabled]

Allows you to enable or disable boot with initialization of a minimal set of devices required to launch active boot option. This has no effect for BBS boot options.
Configuration options: [Disabled] [Enabled]



The following item appears only when you set **Fast Boot** to **[Enabled]**.

Sata Support [All Sata Devices]

[Last Boot HDD Only] Only last booted HDD device will be available in POST.
[All Sata Devices] All SATA devices will be available in OS and POST.

VGA Support [EFI Driver]

[Auto] Only legacy OpRom with Legacy OS, and logo will NOT be shown during POST.
[EFI Driver] Efi driver will still be installed with EFI OS.

USB Support [Full Initial]

[Disabled] All USB devices will NOT be available until after OS boot.
[Partial Initial] USB Mass Storage and specific USB port/device will NOT be available before OS boot.
[Full Initial] All USB devices will be available in OS and POST.

PS2 Devices Support [Enabled]

If this option is disabled, PS2 devices will be skipped.
Configuration options: [Disabled] [Enabled]

Network Stack Driver Support [Disabled]

If this option is disabled, Network Stack Driver will be skipped.

Configuration options: [Disabled] [Enabled]

Redirection Support [Disabled]

If this option is disabled, Redirection function will be disabled.

Configuration options: [Disabled] [Enabled]



The following item appears only when you set **Quiet Boot** to **[Disabled]**.

POST Report [5 sec]

Allows you to set the desired POST Report waiting time from 1 to 10 seconds.

Configuration options: [1 sec] - [10 sec] [Until Press ESC]

Network Device BBS Priorities

This item allows you to set the booting order of the devices.

5.8 Monitor menu

This menu displays the system temperature, fan speed, and power status. You can also change the fan settings in this menu.

Aptio Setup Utility - Copyright (C) 2018 American Megatrends, Inc.

Main Advanced Chipset Security Boot Monitor Tool Event Logs Server Mgmt Save & Exit

CPU1 Temperature	: +38°C	Generic/High/Full/Manual Speed Mode
REAR_FAN1 Speed	: 1123 RPM	
CPU_FAN1 Speed	: 1505 RPM	
FRNT_FAN1 Speed	: N/A	
FRNT_FAN2 Speed	: 1198 RPM	
FRNT_FAN3 Speed	: N/A	
FRNT_FAN4 Speed	: N/A	
+VOCORE1	: +1.040 V	
+12V	: +12.288 V	
+5V	: +5.160 V	
+VDDQ_AB	: +1.216 V	
+VCCIO	: +0.960 V	
+VCCSA	: +1.056 V	
+5VSB	: +5.120 V	++: Select Screen
+VCCST	: +1.080 V	T4: Select Item
+3.3V	: +3.360 V	Enter: Select
+3.3VSB	: +3.360 V	+/-: Change Opt.
VBAT	: +3.168 V	F1: General Help
		F2: Previous Values
		F5: Optimized Defaults

FAN Speed Control [Generic Mode]

Fan Speed Control [Generic Mode]

Allows you to select the power-on state for the NumLock.

Configuration options: [Generic Mode] [High Speed Mode] [Full Speed Mode] [Manual Speed Mode]



The following items appear only when you set **Fan Speed Control** to **[Manual Speed Mode]**.

REAR_FAN1 / CPU_FAN1 / FRNT_FAN1-4 Duty% [50]

Allows you to set the desired POST Report waiting time from 1 to 10 seconds. Use the <+> or <-> to adjust the value. The values range from 10 to 100.

5.9 Tool menu

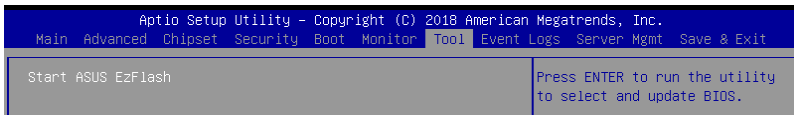

ASUS EZ Flash

Allows you to run ASUS EZ Flash BIOS ROM Utility when you press <Enter>. Refer to the ASUS EZ Flash Utility section for details.

5.10 Event Logs menu

The Event Logs menu items allow you to change the event log settings and view the system event logs.

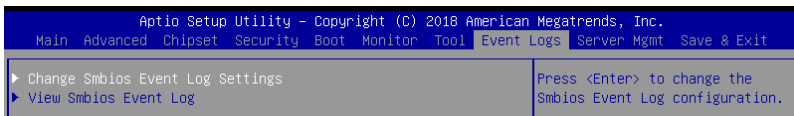

5.10.1 Change Smbios Event Log Settings

Press <Enter> to change the Smbios Event Log configuration.



All values changed here do not take effect until computer is restarted.

Enabling/Disabling Options

Smbios Event Log [Enabled]

Change this to enable or disable all features of Smbios Event Logging during boot. Configuration options: [Disabled] [Enabled]



The following items appear only when you set **Smbios Event Log** to **[Enabled]**.

Erasing Settings

Erase Event Log [No]

Choose options for erasing Smbios Event Log. Erasing is done prior to any logging activation during reset.

Configuration options: [No] [Yes, Next reset] [Yes, Every reset]

When Log is Full [Do Nothing]

Choose options for reacting to a full Smbios Event Log.
Configuration options: [Do Nothing] [Erase Immediately]

Smbios Event Log Standard Settings

Log System Boot Event [Enabled]

This option allows you to enable or disable logging System boot event.
Configuration options: [Disabled] [Enabled]

MECI [1]

This option allows you to set the number of occurrences of a duplicate event that must pass before the multiple-event counter of log entry is updated. Use the <+> or <-> to adjust the value. The values range from 1 to 255.

METW [60]

This option allows you to set the number of minutes which must pass between duplicate log entries which utilize a multiple-event counter. Use the <+> or <-> to adjust the value. The values range from 0 to 99.

Custom Options

Log EFI Status Code [Enabled]

This option allows you to enable or disable logging of the EFI Status Codes.
Configuration options: [Disabled] [Enabled]



The following item appears only when you set **Log EFI Status Code** to **[Enabled]**.

Convert EFI Status Codes to Standard Smbios Type [Disabled]

This option allows you to enable or disable converting of EFI Status Codes to Standard Smbios Type (Not all may be translated).
Configuration options: [Disabled] [Enabled]

5.10.2 View Smbios Event Log

Press <Enter> to view all smbios event logs.

5.11 Server Mgmt menu

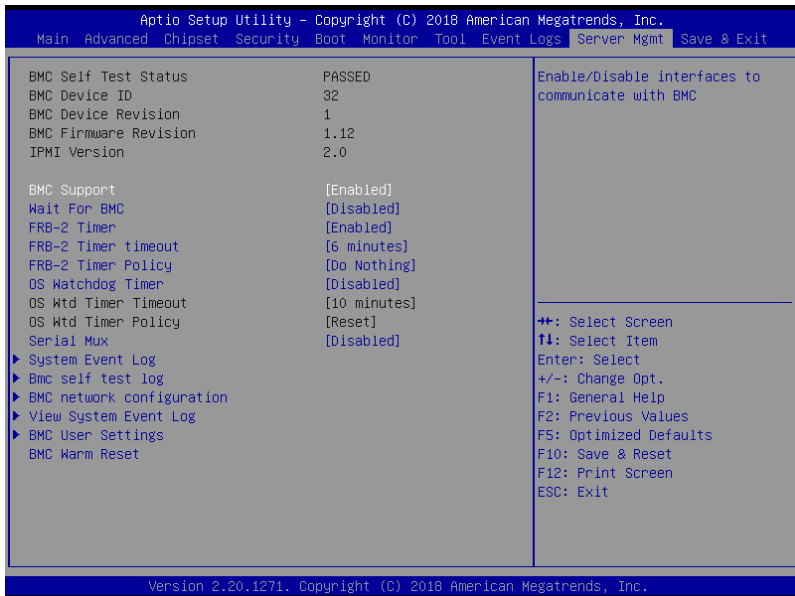

BMC Support [Enabled]

This item allows you to enable or disable interfaces to communicate with BMC.
Configuration options: [Disabled] [Enabled]



The following items appear only when **BMC Support** is set to **[Enabled]**.

Wait for BMC [Disabled]

Allows you to enable or disable wait for BMC response for specified time out.
Configuration options: [Disabled] [Enabled]

FRB-2 Timer [Enabled]

Allows you to enable or disable FRB-2 timer (POST timer).
Configuration options: [Disabled] [Enabled]

FRB-2 Timer timeout [6 minutes]

Allows you to select the FRB-2 Timer Expiration value.
Configuration options: [3 minutes] [4 minutes] [5 minutes] [6 minutes]

FRB-2 Timer Policy [Do Nothing]

Allows you to select the how the system should respond in FRB-2 Timer expires.
Configuration options: [Do Nothing] [Reset] [Power Down] [Power Cycle]

OS Watchdog Timer [Disabled]

This item allows you to start a BIOS timer which can only be shut off by Management Software after the OS loads.

Configuration options: [Disabled] [Enabled]



The following items are configurable only when **OS Watchdog Timer** is set to **[Enabled]**.

OS Wtd Timer Timeout [10 minutes]

Allows you to configure the length for the OS Boot Watchdog Timer.

Configuration options: [5 minutes] [10 minutes] [15 minutes] [20 minutes]

OS Wtd Timer Policy [Reset]

This item allows you to configure the how the system should respond if the OS Boot Watch Timer expires.

Configuration options: [Do Nothing] [Reset] [Power Down] [Power Cycle]

Serial Mux [Disabled]

Allows you to enable or disable Serial Mux configuration.

Configuration options: [Disabled] [Enabled]

BMC Warm Reset

This item allow you to perform a BMC warm reset.

5.11.1 System Event Log

Allows you to change the SEL event log configuration.

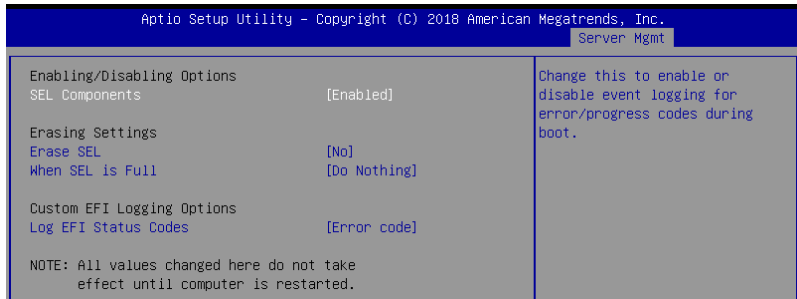

Enabling/Disabling Options

SEL Components [Enabled]

Allows you to enable or disable event logging for error/progress codes during boot.

Configuration options: [No] [Yes, On next reset] [Yes, On every reset]



- The following items are configurable only when **SEL Components** is set to **[Enabled]**.
- All values changed here do not take effect until computer is restarted.

Erasing Settings

Erase SEL [No]

Allows you to choose options for erasing SEL.

Configuration options: [No] [Yes, On next reset] [Yes, On every reset]

When SEL is Full [Do Nothing]

Allows you to choose options for reactions to a full SEL.

Configuration options: [Do Nothing] [Erase Immediately]

Custom EFI Logging Options

Log EFI Status Codes [Error code]

Allows you to select which codes to log.

Configuration options: [Disabled] [Both] [Error code] [Progress code]

5.11.2 Bmc self test log

Allows you to change the SEL event log configuration.

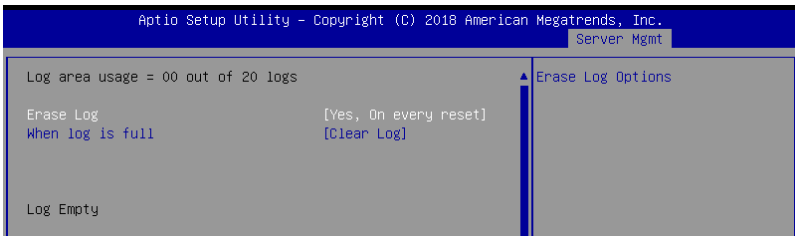

Erase Log [Yes, On every reset]

Choose options for erasing Smbios Event Log. Erasing is done prior to any logging activation during reset.

Configuration options: [No] [Yes, On every reset]

When Log is Full [Clear Log]

Allows you to choose options for reactions to a full Smbios Event Log.

Configuration options: [Clear Log] [Do not log any more]

5.11.3 BMC network configuration

The sub-items in this configuration allow you to configure the BMC network parameters.

```
Aptio Setup Utility - Copyright (C) 2018 American Megatrends, Inc.
Server Mgmt

--BMC network configuration--
*****
Configure IPV4 support
*****

DM_LAN1
Configuration Address source      [Unspecified]
Current Configuration Address     DynamicAddressBmcDhcp
source
Station IP address                0.0.0.0
Subnet mask                       0.0.0.0
Station MAC address              00-e0-18-05-02-c0
Router IP address                 0.0.0.0
Router MAC address               00-00-00-00-00-00

Shared LAN
Configuration Address source      [Unspecified]
Current Configuration Address     DynamicAddressBmcDhcp
source
Station IP address                0.0.0.0
Subnet mask                       0.0.0.0
Station MAC address              00-e0-18-05-02-c1
Router IP address                 0.0.0.0
Router MAC address               00-00-00-00-00-00

▲ Select to configure LAN
channel parameters statically
or dynamically(by BIOS or
BMC). Unspecified option will
not modify any BMC network
parameters during BIOS phase

+*: Select Screen
F1: Select Item
Enter: Select
+/-: Change Opt.
F1: General Help
F2: Previous Values
F5: Optimized Defaults
F10: Save & Reset
F12: Print Screen
ESC: Exit
```

Navigate to the second page of the screen to see the rest of items in this menu by pressing the Up or Down arrow keys.



To quickly go to the last item of the second page, press the **Page Down** button. Press the **Page Up** button to go back to the first item in the first page.

IPV4

DM_LAN1 / Shared LAN

Configuration Address source [Unspecified]

This item allows you to configure LAN channel parameters statically or dynamically (by BIOS or BMC). Unspecified option will not modify any BMC network parameters during BIOS phase.

Configuration options: [Unspecified] [Static] [DynamicBmcDhcp] [DynamicBmcNonDhcp]

IPV6

DM_LAN1

IPV6 Support [Enabled]

Allows you to enable or disable LAN1 IPV6 Support.

Configuration options: [Disabled] [Enabled]



The following items appear only when **IPV6 Support** is set to **[Enabled]**.

Configuration Address source [Unspecified]

This item allows you to configure LAN channel parameters statistically or dynamically (by BIOS or BMC). Unspecified option will not modify any BMC network parameters during BIOS phase.

Configuration options: [Unspecified] [Static] [DynamicBmcDhcp]

Shared LAN

IPV6 Support [Enabled]

Allows you to enable or disable LAN2 IPV6 Support.

Configuration options: [Disabled] [Enabled]



The following items appear only when **IPV6 Support** is set to **[Enabled]**.

Configuration Address source [Unspecified]

This item allows you to configure LAN channel parameters statistically or dynamically (by BIOS or BMC). Unspecified option will not modify any BMC network parameters during BIOS phase.

Configuration options: [Unspecified] [Static] [DynamicBmcDhcp]

5.11.4 View System Event Log

This item allows you to view the system event log records.

5.11.5 BMC User Settings

The sub-items in this configuration allow you to add, delete, or change BMC user settings.

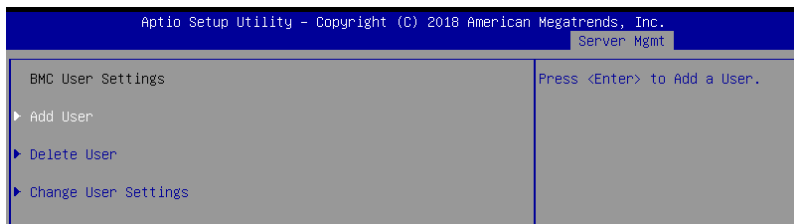

5.12 Save & Exit menu

The Exit menu items allow you to save or discard your changes to the BIOS items.

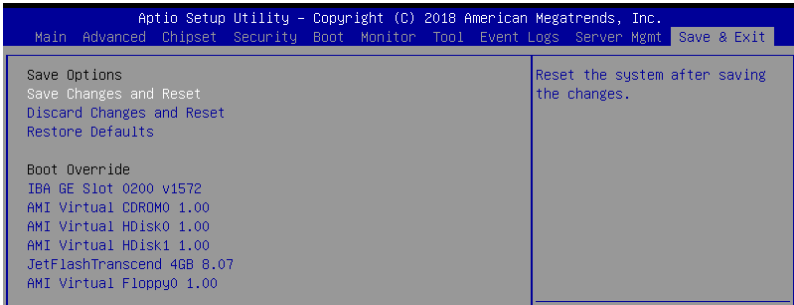

Pressing <Esc> does not immediately exit this menu. Select one of the options from this menu or <F10> from the legend bar to exit.

Save Changes and Reset

Exit System setup after saving the changes.

Discard Changes and Reset

Exit System setup without saving any changes.

Restore Defaults

Restore/load default values for all the setup options.

Boot Override

These items displays the available devices. The device items that appears on the screen depends on the number of devices installed in the system. Click an item to start booting from the selected device.

RAID Configuration

6

This chapter provides instructions for setting up, creating, and configuring RAID sets using the available utilities.

6.1 Setting up RAID

The motherboard supports the Intel® Rapid Storage Technology enterprise Option ROM Utility with RAID 0, RAID 1, RAID 10, and RAID 5 support.

6.1.1 RAID definitions

RAID 0 (Data striping) optimizes two identical hard disk drives to read and write data in parallel, interleaved stacks. Two hard disks perform the same work as a single drive but at a sustained data transfer rate, double that of a single disk alone, thus improving data access and storage. Use of two new identical hard disk drives is required for this setup.

RAID 1 (Data mirroring) copies and maintains an identical image of data from one drive to a second drive. If one drive fails, the disk array management software directs all applications to the surviving drive as it contains a complete copy of the data in the other drive. This RAID configuration provides data protection and increases fault tolerance to the entire system. Use two new drives or use an existing drive and a new drive for this setup. The new drive must be of the same size or larger than the existing drive.

RAID 10 is data striping and data mirroring combined without parity (redundancy data) having to be calculated and written. With the RAID 10 configuration you get all the benefits of both RAID 0 and RAID 1 configurations. Use four new hard disk drives or use an existing drive and three new drives for this setup.

RAID 5 stripes both data and parity information across three or more hard disk drives. Among the advantages of RAID 5 configuration include better HDD performance, fault tolerance, and higher storage capacity. The RAID 5 configuration is best suited for transaction processing, relational database applications, enterprise resource planning, and other business systems. Use a minimum of three identical hard disk drives for this setup.



If you want to boot the system from a hard disk drive included in a created RAID set, copy first the RAID driver from the support DVD to a floppy disk before you install an operating system to the selected hard disk drive.

6.1.2 Installing hard disk drives

The motherboard supports Serial ATA for RAID set configuration. For optimal performance, install identical drives of the same model and capacity when creating a disk array.

To install the SATA hard disks for RAID configuration:

1. Install the SATA hard disks into the drive bays following the instructions in the system user guide.
2. Connect a SATA signal cable to the signal connector at the back of each drive and to the SATA connector on the motherboard.
3. Connect a SATA power cable to the power connector on each drive.

6.1.3 Setting the RAID item in BIOS

You must set the RAID item in the BIOS Setup before you can create a RAID set from SATA hard disk drives attached to the SATA connectors supported by Intel® C246 chipset.

To do this:

1. Enter the BIOS Setup during POST.
2. Go to the **Chipset Menu > PCH-IO Configuration > SATA And RSTe Configuration**, then press <Enter>.
3. Set **SATA Mode Selection** to [RAID].
4. Press <F10> to save your changes and exit the BIOS Setup.



Refer to Chapter 5 for details on entering and navigating through the BIOS Setup.

6.2 Intel® Rapid Storage Technology enterprise SATA Option ROM Utility

The Intel® Rapid Storage Technology enterprise SATA Option ROM utility allows you to create RAID 0, RAID 1, RAID 10 (RAID 1+0), and RAID 5 set from Serial ATA hard disk drives that are connected to the Serial ATA connectors supported by the Southbridge.



Before you proceed, ensure that you have installed the Serial ATA hard disk drives, and have set the correct SATA mode in the BIOS setup. You can refer to the **Installing hard disk drives**, and **Setting the RAID item in BIOS** sections in this manual for more information.

To launch the Intel® Rapid Storage Technology enterprise SATA Option ROM utility:

1. Turn on the system.
2. During POST, press <Ctrl>+<I> to display the utility main menu.

```
Intel(R) Rapid Storage Technology enterprise - SATA Option ROM - 3.6.0.1023
Copyright(C) 2003-12 Intel Corporation. All Rights Reserved.

[ MAIN MENU ]
1. Create RAID Volume
2. Delete RAID Volume
3. Reset Disks to Non-RAID
4. Exit

[ DISK/VOLUME INFORMATION ]

RAID Volumes:
None defined.

Physical Disks:
ID Drive Model Serial # Size Type/Status (Vol ID)
0 ST3300656SS HWAS0000991753TR 279.3GB Non-RAID Disk
1 ST3300656SS 37VN00009846RAJ1 279.3GB Non-RAID Disk
2 ST3300656SS 397600009846UEDY 279.3GB Non-RAID Disk
3 ST3300656SS GWC50000991756G6 279.3GB Non-RAID Disk

[↑↓]-Select [ESC]-Exit [ENTER]-Select Menu
```

The navigation keys at the bottom of the screen allow you to move through the menus and select the menu options.



The RAID BIOS setup screens shown in this section are for reference only and may not exactly match the items on your screen.

6.2.1 Creating a RAID set

To create a RAID set:

1. From the utility main menu, select **1. Create RAID Volume** and press <Enter>.
2. Key in a name for the RAID set and press <Enter>.

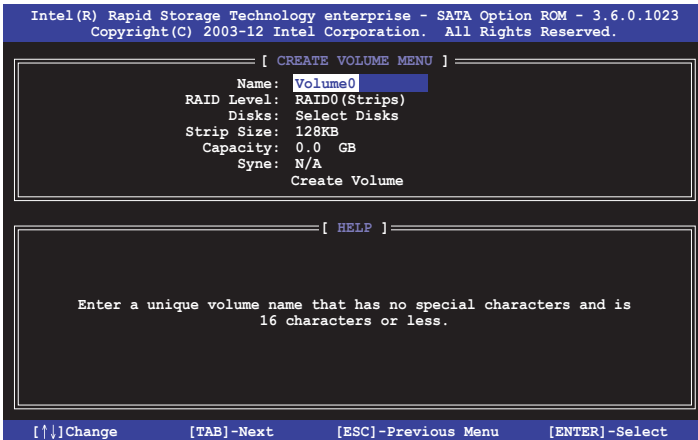

3. Press the up/down arrow keys to select a RAID Level that you wish to create then press <Enter>.
4. From the **Disks** item field, press <Enter> to select the hard disk drives that you want to include in the RAID set.

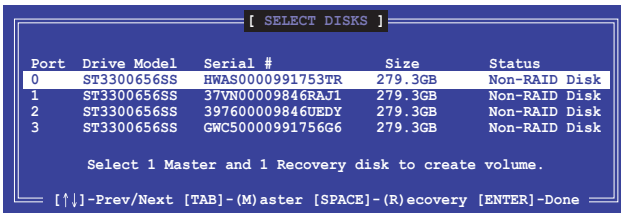

5. Use the up/down arrow keys to move the selection bar then press <Space> to select a disk. A small triangle before the Port number marks the selected drive. Press <Enter> when you are done.

- Use the up/down arrow keys to select the stripe size for the RAID array (for RAID 0, 10 and 5 only) then press <Enter>. The available stripe size values range from 4 KB to 128 KB. The following are typical values:
RAID 0: 128KB
RAID 10: 64KB
RAID 5: 64KB



We recommend a lower stripe size for server systems, and a higher stripe size for multimedia computer systems used mainly for audio and video editing.

- In the **Capacity** field item, key in the RAID volume capacity that you want to use and press <Enter>. The default value field indicates the maximum allowed capacity.
- Press <Enter> to start creating the RAID volume.
- From the following warning message, press <Y> to create the RAID volume and return to the main menu, or press <N> to go back to the **CREATE VOLUME** menu.

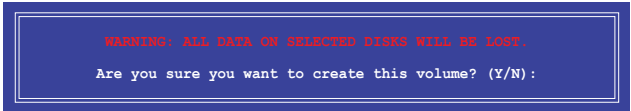

6.2.2 Deleting a RAID set



Take caution when deleting a RAID set. You will lose all data on the hard disk drives when you delete a RAID set.

To delete a RAID set:

1. From the utility main menu, select **2. Delete RAID Volume** and press <Enter>.
2. From the Delete Volume Menu, press the up/down arrow keys to select the RAID set you want to delete then press .

```
Intel(R) Rapid Storage Technology enterprise - SATA Option ROM - 3.6.0.1023
Copyright(C) 2003-12 Intel Corporation. All Rights Reserved.

[ DELETE VOLUME MENU ]

Name      Level      Drives    Capacity  Status    Bootable
Volume0   RAID0 (Stripe)  2         298.0GB   Normal    Yes

[ HELP ]

Deleting a volume will reset the disks to non-RAID

WARNING: ALL DISK DATA WILL BE DELETED.
(This does not apply to Recovery volumes)

[↑,↓]-Select      [ESC]-Previous Menu      [DEL]-Delete Volume
```

3. Press <Y> to confirm deletion of the selected RAID set and return to the utility main menu, or press <N> to return to the **DELETE VOLUME** menu.

```
[ DELETE VOLUME VERIFICATION ]

ALL DATA IN THE VOLUME WILL BE LOST!
(This does not apply to Recovery volumes)

Are you sure you want to delete volume "Volume0"? (Y/N):
```

6.2.3 Resetting disks to Non-RAID



Take caution before you reset a RAID volume hard disk drive to non-RAID. Resetting a RAID volume hard disk drive deletes all internal RAID structure on the drive.

To reset a RAID set:

1. From the utility main menu, select **3. Reset Disks to Non-RAID** and press <Enter>.
2. Press the up/down arrow keys to select the drive(s) or disks of the RAID set you want to reset, then press <Space>. A small triangle before the Port number marks the selected drive. Press <Enter> when you are done.

```
[ RESET RAID DATA ]
Resetting RAID disk will remove its RAID structures
and revert it to a non-RAID disk.
WARNING: Resetting a disk causes all data on the disk to be lost.
(This does not apply to Recovery volumes)
Port  Drive Model  Serial #      Size      Status
---  -
0     ST3300656SS   HWAS0000991753TR  279.3GB  Member Disk
1     ST3300656SS   37VN00009846RAJ1  279.3GB  Member Disk
Select the disks that should be reset.
[↑↓]-Previous/Next [SPACE]-Selects [ENTER]-Selection Complete
```

3. Press <Y> in the confirmation window to reset the drive(s) or press <N> to return to the utility main menu.

6.2.4 Exiting the Intel® Rapid Storage Technology enterprise SATA Option ROM utility

To exit the utility:

1. From the utility main menu, select **4. Exit** then press <Enter>.
2. Press <Y> to exit or press <N> to return to the utility main menu.

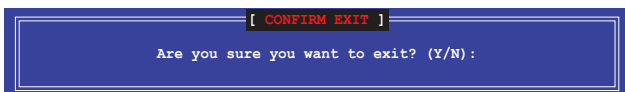

6.2.5 Rebuilding the RAID



This option is only for the RAID 1 set.

Rebuilding the RAID with other non-RAID disk

If any of the SATA hard disk drives included in the RAID 1 array failed, the system displays the status of the RAID volume as **“Degraded”** during POST. You can rebuild the RAID array with other installed non-RAID disks.

To rebuild the RAID with other non-RAID disk:

1. During POST, press <Ctrl>+<I> at the prompt to enter the Intel Rapid Storage Technology option ROM utility.
2. If there is a non-RAID SATA Hard Disk available, the utility will prompt you to rebuild the RAID. Press the up/down arrow keys to select the destination disk then Press <Enter> to start the rebuilding process, or press <ESC> to exit.

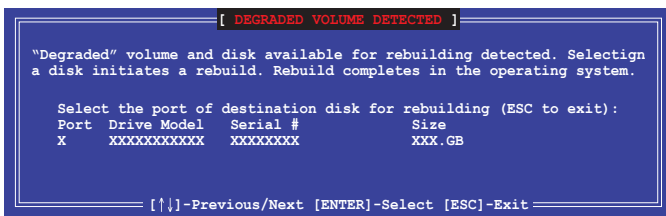

Select a destination disk with the same size as the original hard disk.

- The utility immediately starts rebuilding after the disk is selected. When done, the status of the degraded RAID volume is changed to **“Rebuild”**.

```

Intel(R) Rapid Storage Technology enterprise - SATA Option ROM - 3.6.0.1023
Copyright(C) 2003-12 Intel Corporation. All Rights Reserved.

----- [ MAIN MENU ] -----
  1. Create RAID Volume          3. Reset Disks to Non-RAID
  2. Delete RAID Volume         4. Exit

----- [ DISK/VOLUME INFORMATION ] -----

RAID Volumes:
ID  Name      Levell      Strip      Size      *Data is Encrypted
1   Volume0   RAID1(Mirror)  N/A       149.0GB   Rebuild    Yes

Physical Devices:
Port  Drive Model  Serial #      Size      Type/Status(Vol ID)
1     ST3160812AS  9LS0F4HL     149.0GB   Member Disk(0)
2     ST3160812AS  3LS0JYL8     149.0GB   Member Disk(0)

Volumes with "Rebuild" status will be rebuilt within the operating system.

[↑↓]-Select      [ESC]-Exit      [ENTER]-Select Menu

```

- Press <Esc> to exit Intel Rapid Storage Technology and reboot the system.
- Select **Start > Programs > Intel Rapid Storage > Intel Rapid Storage Console** or click the **Intel Rapid Storage Technology** tray icon to load the Intel Rapid Storage Manager utility.
- From the **View** menu, select **Advanced Mode** to display the details of the Intel Rapid Storage Console.
- From the **Volumes view** option, select **RAID volume** to view the rebuilding status. When finished, the status is changed to **“Normal”**.

Rebuilding the RAID with a new hard disk

If any of the SATA hard disk drives included in the RAID array failed, the system displays the status of the RAID volume as **“Degraded”** during POST. You may replace the disk drive and rebuild the RAID array.

To rebuild the RAID with a new hard disk:

- Remove the failed SATA hard disk and install a new SATA hard disk of the same specification into the same SATA Port.



Select a destination disk with the same size as the original hard disk.

- Reboot the system then follow the steps in section **Rebuilding the RAID with other non-RAID disk**.

6.2.6 Setting the Boot array in the BIOS Setup Utility

You can set the boot priority sequence in the BIOS for your RAID arrays when creating multi-RAID using the Intel® Rapid Storage Technology enterprise SATA Option ROM utility.

To set the boot array in the BIOS:



Set at least one of the arrays bootable to boot from the hard disk.

1. Reboot the system and press to enter the BIOS setup utility during POST.
2. Go to the **Boot** menu and select the boot option priority.
3. Use up/down arrow keys to select the boot priority and press <Enter>. See the **Boot menu** section of Chapter 4 for more details.
4. From the **Exit** menu, select **Save Changes & Exit**, then press <Enter>.
5. When the confirmation window appears, select **Yes**, then press <Enter>.

6.3 Intel® Rapid Storage Technology enterprise (Windows)

The Intel® Rapid Storage Technology enterprise allows you to create RAID 0, RAID 1, RAID 10 (RAID 1+0), and RAID 5 set(s) from Serial ATA hard disk drives that are connected to the Serial ATA connectors supported by the Southbridge.



You need to manually install the Intel® Rapid Storage Technology enterprise utility on a Windows® operating system. Please refer to the installation instructions in Chapter 7.

To enter the Intel® Rapid Storage Technology enterprise utility under Windows operating system:

1. Turn on the system and go to the windows desktop.
2. Click the **Intel® Rapid Storage Technology enterprise** icon to display the main menu.

Your storage system is configured for data protection, increased performance and optimal data storage capacity. You can create additional volumes to further optimize your storage system.

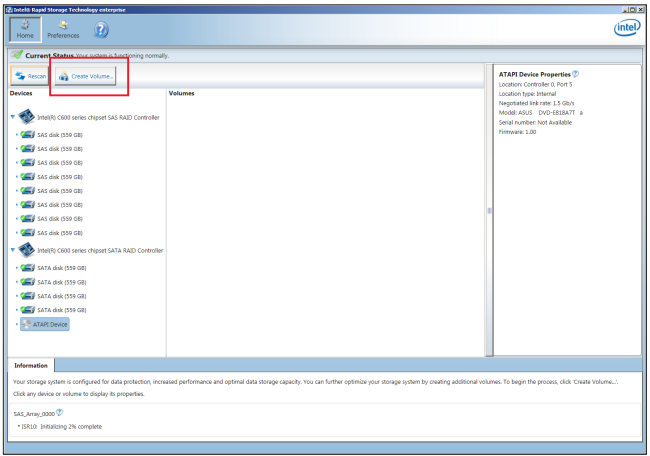

You can click **Rescan** to re-scan any attached hard disks.

6.3.1 Creating a RAID set

To create a RAID set:

1. From the utility main menu, select **Create Volume** and select volume type.
2. Click **Next**.

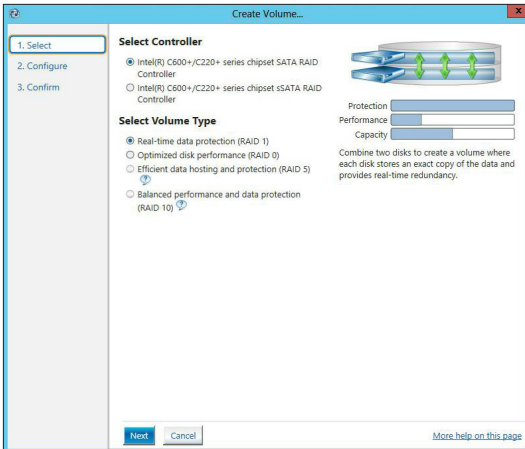

3. Enter a name for the RAID set, then select the array disks.
4. Select **Volume Size** tab, you can drag the bar to decide the volume size.
5. Click **Next**.

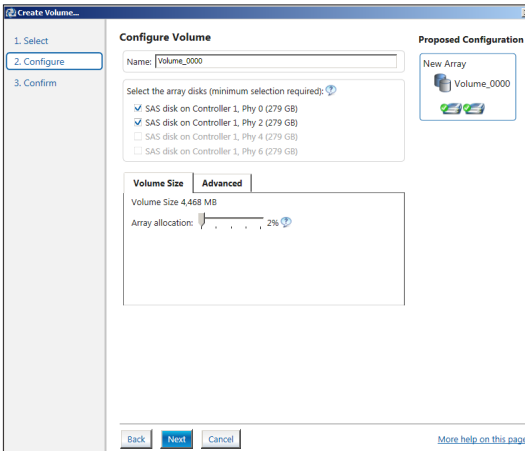

- If you do not want to keep the data on one of the selected disks, select **NO** when prompted.
- If you want to **Enable volume write-back cache** or **Initialize volume**, click **Advanced**.

6. Confirm the volume creation, then click **Create Volume** to continue.



This process could take a while depending on the number and size of the disks. You can continue using other applications during this time.

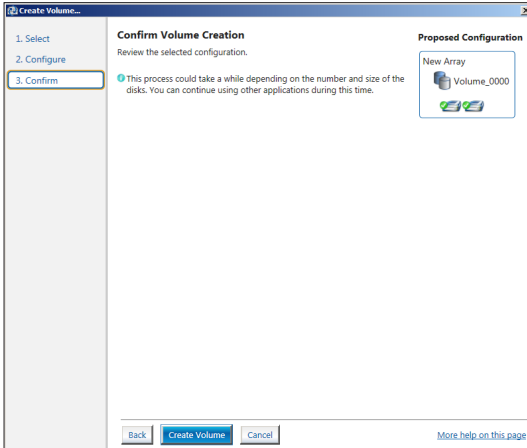

7. Wait until the process is completed, then click **OK** when prompted.

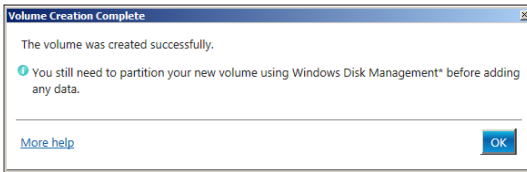

You still need to partition your new volume using Windows Disk Management before adding any data.

The RAID set is displayed in the **Volumes** list and you can change the settings in **Volume Properties**.

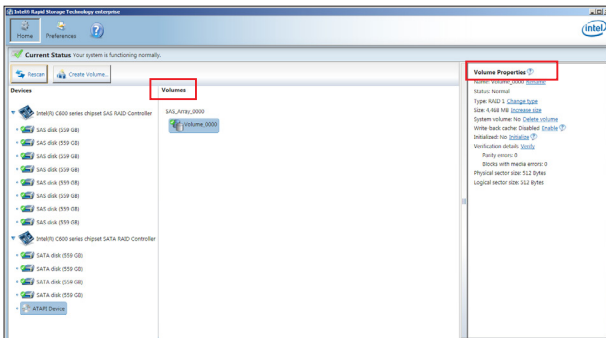

6.3.2 Changing a Volume Type

To change the volume type in **Volume Properties**:

1. Click the SATA array items you want to change in **Volumes** field.
2. From the **Volume Properties** field, select **Type:RAID 1 Change type**.

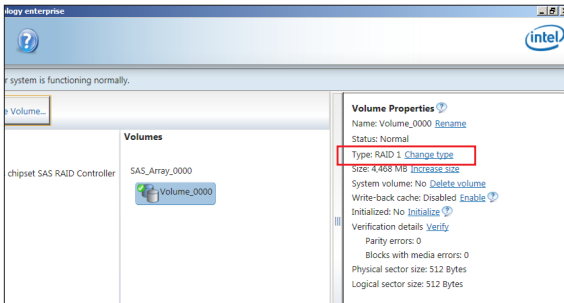

3. You can change the **Name**, **Select the new volume type**, and **Select additional disks to include in the new volume** if needed.
4. Select the **Data stripe size** for the RAID array (for RAID 0, 10 and 5 only), and click **OK**. The available stripe size values range from 4 KB to 128 KB. The following are typical values:
RAID 0: 128KB
RAID 10: 64KB
RAID 5: 64KB

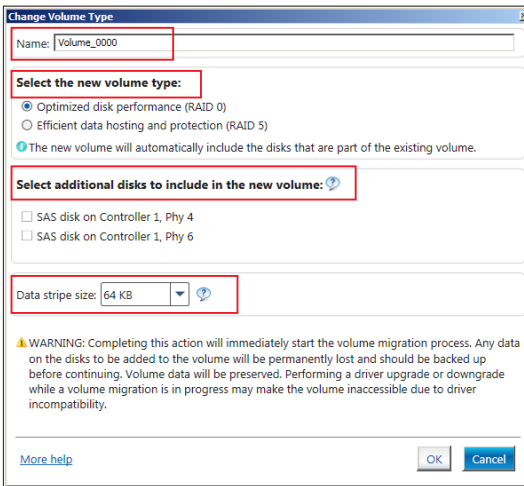

We recommend a lower stripe size for server systems, and a higher stripe size for multimedia computer systems used mainly for audio and video editing.

6.3.3 Deleting a volume



Be cautious when deleting a volume. You will lose all data on the hard disk drives. Before you proceed, ensure that you back up all your important data from your hard drives.

To delete a volume:

1. From the utility main menu, select the volume (exp. Volume_0000) in **Volumes** field you want to delete.

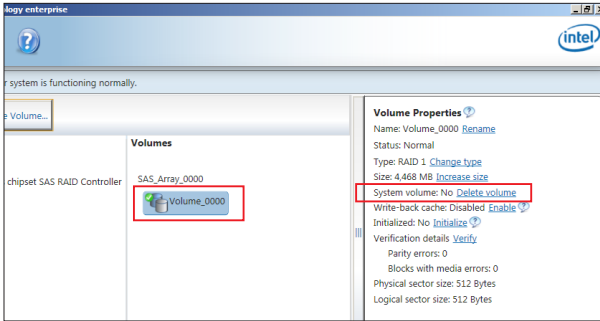

2. Select **Delete volume** in **Volume Properties** field. The following screen appears.

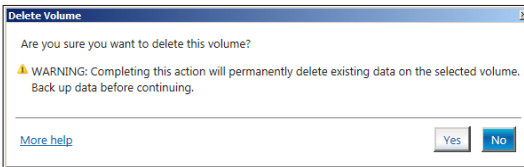

3. Click **Yes** to delete the volume and return to the utility main menu, or click **No** to return to the main menu.

6.3.4 Preferences

System Preferences

Allow you to set to show the notification area icon and show system information, warning, or errors here.

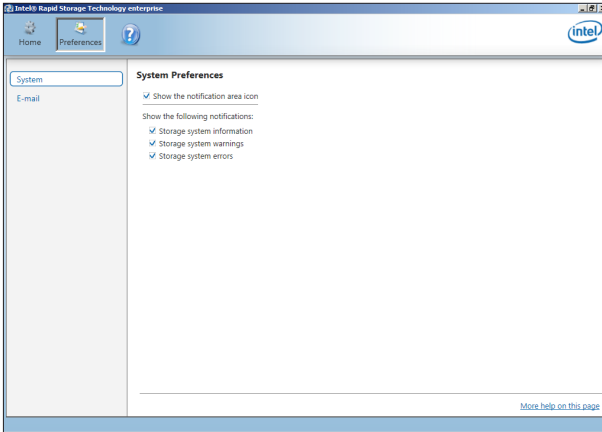

E-Mail Preferences

Allow you to set to sent e-mail of the following events:

- Storage system information
- Storage system warnings
- Storage system errors

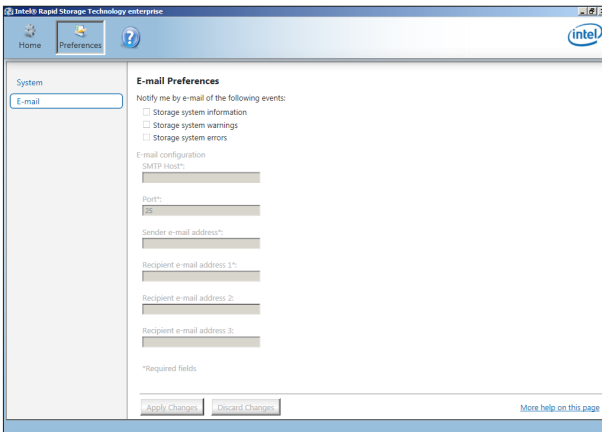

Driver Installation

7

This chapter provides the instructions for installing the necessary drivers for different system components in both Linux[®] and Windows[®] Operating Systems.

7.1 RAID driver installation

After creating the RAID sets for your server system, you are now ready to install an operating system to the independent hard disk drive or bootable array. This part provides the instructions on how to install the RAID controller drivers during OS installation.

7.1.1 Creating a USB flash drive with RAID drive

When installing Windows® Server OS, you can load the RAID driver from a USB flash drive. You can create a USB flash drive with RAID driver in Windows by copying the files from the support DVD to the USB flash drive.

To copy the RAID driver to a USB flash drive in Windows environment:

1. Place the motherboard support DVD in the optical drive.
2. Connect a USB flash drive to your system.
3. Click on the optical drive to browse the contents of the support DVD.
4. Click **Drivers > C24x INTEL RAID > Driver > Windows** and then copy the RAID driver folder to the USB flash drive.

7.1.2 Installing the RAID controller driver

During Windows® Server 2012 R2 or 2016 OS installation

To install the RAID controller driver when installing Windows® Server OS:

1. Boot the computer using the Windows® Server installation disc. Follow the onscreen instructions to start installing Windows® Server.
2. When prompted to choose a type of installation, click **Custom: Install Windows only (advanced)**.

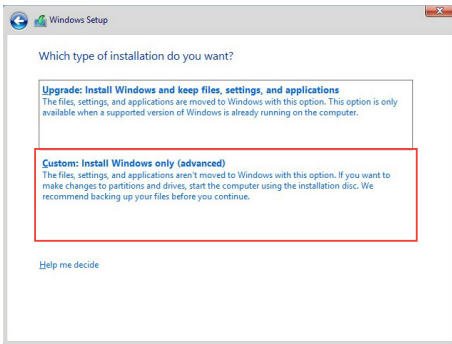

3. Click **Load Driver**.

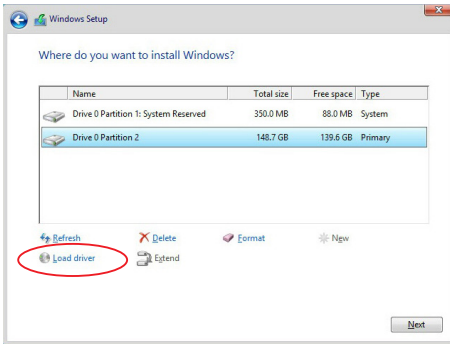

4. A message appears reminding you to insert the installation media containing the driver of the RAID controller driver (the installation media can be a CD, DVD, or USB flash drive).
- If you have only one optical drive installed in your system, eject the Windows OS installation disc and replace with the motherboard Support DVD into the optical drive.
 - Or you may connect a USB flash drive containing the RAID controller driver.

Click **Browse** to continue.

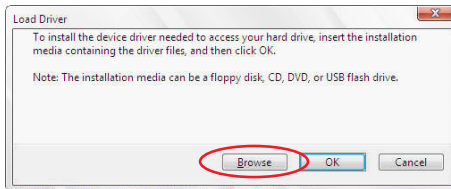

5. Locate the driver in the corresponding folder of the Support DVD or USB flash drive and then click **OK** to continue.
6. Select the RAID controller driver you need from the list and click **Next**.

7. When the system finishes loading the RAID driver,
 - Replace the motherboard Support DVD with the Windows Server installation disc.
 - Remove the USB flash drive.

Select the drive to install Windows and click **Next**.

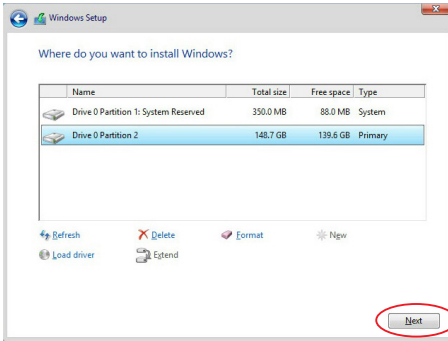

8. Setup then proceeds with the OS installation. Follow the onscreen instructions to continue.

7.2 Management applications and utilities installation

The support DVD that is bundled with your motherboard contains drivers, management applications, and utilities that you can install to maximize the features of your motherboard.



- The contents of the support DVD are subject to change at any time without notice. Visit the ASUS website (www.asus.com) for the latest updates on software and utilities.
- The support DVD is supported on Windows® Server 2012 R2 and Windows® Server 2016.

7.3 Running the Support DVD

When you place the support DVD into the optical drive, the DVD automatically displays the main screen if Autorun is enabled in your computer. By default, the Drivers tab is displayed.



If Autorun is NOT enabled in your computer, browse the contents of the support DVD to locate the file **Setup.exe**. Double-click the **Setup.exe** to run the support DVD.

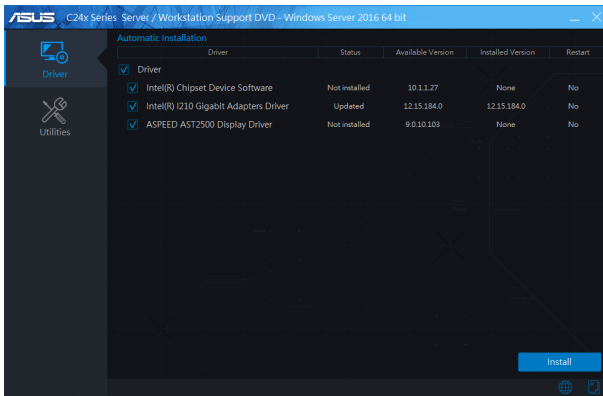

Onscreen display and content vary depending on the motherboard and chipset. The screenshots are provided for reference only.

7.4 Installing the system drivers

This section provides the instructions on how to install the system drivers. You will need to manually install the system drivers on a Windows® operating system.

To install the system drivers:

1. Restart the computer, and then log on with **Administrator** privileges.
2. Insert the support DVD into the optical drive. The support DVD automatically displays the **Driver** menu if Autorun is enabled in your computer.



If Autorun is NOT enabled in your computer, browse the contents of the support DVD to locate the file **Setup.exe**. Double-click the **Setup.exe** to run the support DVD.

3. Check the drivers that you would like to install, then select **Install**.

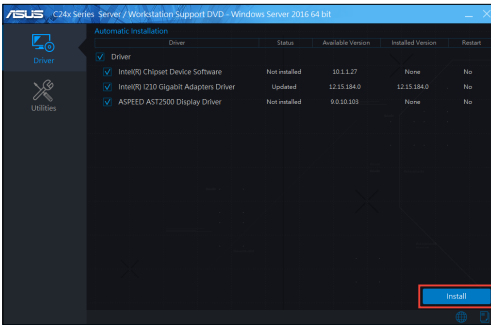

4. The installation window appears.

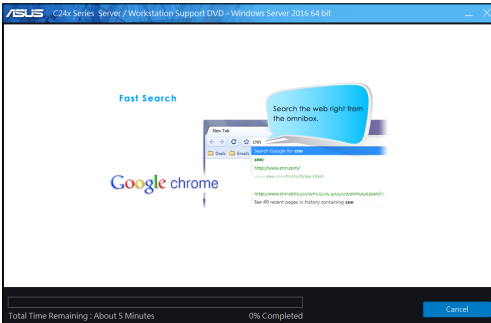

5. Follow the onscreen instructions to complete the installation.

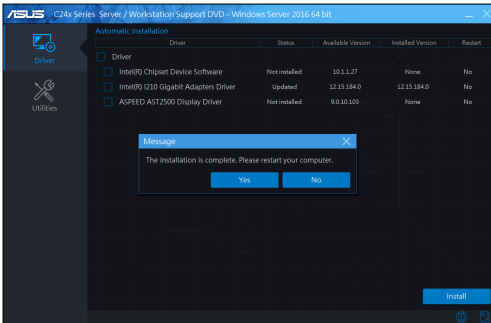

Appendix

This appendix includes additional information that you may refer to when configuring the motherboard.

P11C-E/4L block diagram

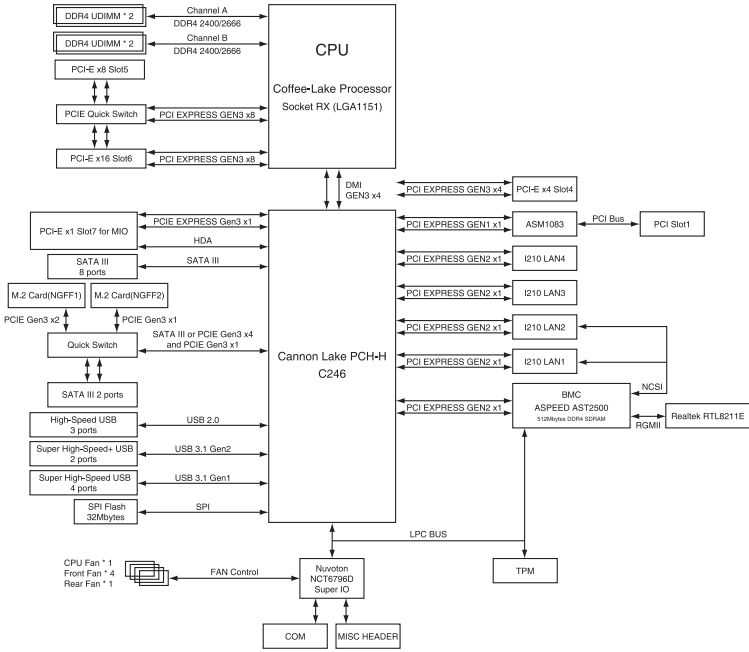

Q-Code table

Code	Description
00	Not used
02	microcode
03	CACHE_ENABLED
04	PCH initialization
06	CPU_EARLY_INIT
10	PEI Core is started
11 – 14	Pre-memory CPU initialization is started
15 – 18	Pre-memory System Agent initialization is started
19 – 1C	Pre-memory PCH initialization is started
2B – 2F	Memory initialization
30	Reserved for ASL (see ASL Status Codes section below)
31	Memory Installed
32 – 36	CPU post-memory initialization
37 – 3A	Post-Memory System Agent initialization is started
3B – 3E	Post-Memory PCH initialization is started
4F	DXE IPL is started
50 – 53	Memory initialization error. Invalid memory type or incompatible memory speed
4F	DXE IPL is started
54	Unspecified memory initialization error
55	Memory not installed
56	Invalid CPU type or Speed
57	CPU mismatch
58	CPU self test failed or possible CPU cache error
59	CPU micro-code is not found or micro-code update is failed
5A	Internal CPU error
5B	Reset PPI is not available
5C – 5F	Reserved for future AMI error codes
E0	S3 Resume is started (S3 Resume PPI is called by the DXE IPL)
E1	S3 Boot Script execution
E2	Video repost
E3	OS S3 wake vector call
E4 – E7	Reserved for future AMI progress codes
E8	S3 Resume Failed
E9	S3 Resume PPI not Found
EA	S3 Resume Boot Script Error
EB	S3 OS Wake Error
EC – EF	Reserved for future AMI error codes
F0	Recovery condition triggered by firmware (Auto recovery)
F1	Recovery condition triggered by user (Forced recovery)
F2	Recovery process started
F3	Recovery firmware image is found
F4	Recovery firmware image is loaded
F5 – F7	Reserved for future AMI progress codes
F8	Recovery PPI is not available
F9	Recovery capsule is not found

(continued on the next page)

Code	Description
FA	Invalid recovery capsule
FB – FF	Reserved for future AMI error codes
60	DXE Core is started
61	NVRAM initialization
62	Installation of the PCH Runtime Services
63 – 67	CPU DXE initialization is started
68	PCI host bridge initialization
69	System Agent DXE initialization is started
6A	System Agent DXE SMM initialization is started
6B – 6F	System Agent DXE initialization (System Agent module specific)
70	PCH DXE initialization is started
71	PCH DXE SMM initialization is started
72	PCH devices initialization
73 – 77	PCH DXE Initialization (PCH module specific)
78	ACPI module initialization
79	CSM initialization
7A – 7F	Reserved for future AMI DXE codes
90	Boot Device Selection (BDS) phase is started
91	Driver connecting is started
92	PCI Bus initialization is started
93	PCI Bus Hot Plug Controller Initialization
94	PCI Bus Enumeration
95	PCI Bus Request Resources
96	PCI Bus Assign Resources
97	Console Output devices connect
98	Console input devices connect
99	Super IO Initialization
9A	USB initialization is started
9B	USB Reset
9C	USB Detect
9D	USB Enable
9E – 9F	Reserved for future AMI codes
A0	IDE initialization is started
A1	IDE Reset
A2	IDE Detect
A3	IDE Enable
A4	SCSI initialization is started
A5	SCSI Reset
A6	SCSI Detect
A7	SCSI Enable
A8	Setup Verifying Password
A9	Start of Setup
AA	Reserved for ASL (see ASL Status Codes section below)
AB	Setup Input Wait

(continued on the next page)

Code	Description
AC	Reserved for ASL (see ASL Status Codes section below)
AD	Ready To Boot event
AE	Legacy Boot event
AF	Exit Boot Services event
B0	Runtime Set Virtual Address MAP Begin
B1	Runtime Set Virtual Address MAP End
B2	Legacy Option ROM Initialization
B3	System Reset
B4	USB hot plug
B5	PCI bus hot plug
B6	Clean-up of NVRAM
B7	Configuration Reset (reset of NVRAM settings)
B8– BF	Reserved for future AMI codes
D0	CPU initialization error
D1	System Agent initialization error
D2	PCH initialization error
D3	Some of the Architectural Protocols are not available
D4	PCI resource allocation error. Out of Resources
D5	No Space for Legacy Option ROM
D6	No Console Output Devices are found
D7	No Console Input Devices are found
D8	Invalid password
D9	Error loading Boot Option (LoadImage returned error)
DA	Boot Option is failed (StartImage returned error)
DB	Flash update is failed
DC	Reset protocol is not available

ACPI/ASL Checkpoints (under OS)

Code	Description
03	System is entering S3 sleep state
04	System is entering S4 sleep state
05	System is entering S5 sleep state
30	System is waking up from the S3 sleep state
40	System is waking up from the S4 sleep state
AC	System has transitioned into ACPI mode. Interrupt controller is in PIC mode.
AA	System has transitioned into ACPI mode. Interrupt controller is in APIC mode.

Notices

Federal Communications Commission Statement

This device complies with Part 15 of the FCC Rules. Operation is subject to the following two conditions:

- This device may not cause harmful interference, and
- This device must accept any interference received including interference that may cause undesired operation.

This equipment has been tested and found to comply with the limits for a Class A digital device, pursuant to part 15 of the FCC Rules. These limits are designed to provide reasonable protection against harmful interference when the equipment is operated in a commercial environment. This equipment generates, uses, and can radiate radio frequency energy and, if not installed and used in accordance with the instruction manual, may cause harmful interference to radio communications. Operation of this equipment in a residential area is likely to cause harmful interference in which case the user will be required to correct the interference at his own expense.



The use of shielded cables for connection of the monitor to the graphics card is required to assure compliance with FCC regulations. Changes or modifications to this unit not expressly approved by the party responsible for compliance could void the user's authority to operate this equipment.

Compliance Statement of Innovation, Science and Economic Development Canada (ISED)

This device complies with Innovation, Science and Economic Development Canada licence exempt RSS standard(s). Operation is subject to the following two conditions: (1) this device may not cause interference, and (2) this device must accept any interference, including interference that may cause undesired operation of the device.

CAN ICES-3(A)/NMB-3(A)

Déclaration de conformité de Innovation, Sciences et Développement économique Canada (ISED)

Le présent appareil est conforme aux CNR d'Innovation, Sciences et Développement économique Canada applicables aux appareils radio exempts de licence. L'exploitation est autorisée aux deux conditions suivantes : (1) l'appareil ne doit pas produire de brouillage, et (2) l'utilisateur de l'appareil doit accepter tout brouillage radioélectrique subi, même si le brouillage est susceptible d'en compromettre le fonctionnement.

CAN ICES-3(A)/NMB-3(A)

REACH

Complying with the REACH (Registration, Evaluation, Authorization, and Restriction of Chemicals) regulatory framework, we published the chemical substances in our products at ASUS website at <http://csr.asus.com/english/REACH.htm>.

ASUS Recycling/Takeback Services

ASUS recycling and takeback programs come from our commitment to the highest standards for protecting our environment. We believe in providing solutions for you to be able to responsibly recycle our products, batteries, other components as well as the packaging materials. Please go to <http://csr.asus.com/english/Takeback.htm> for detailed recycling information in different regions.



DO NOT throw the motherboard in municipal waste. This product has been designed to enable proper reuse of parts and recycling. This symbol of the crossed out wheeled bin indicates that the product (electrical and electronic equipment) should not be placed in municipal waste. Check local regulations for disposal of electronic products.



DO NOT throw the mercury-containing button cell battery in municipal waste. This symbol of the crossed out wheeled bin indicates that the battery should not be placed in municipal waste.

Australia statement notice

From 1 January 2012 updated warranties apply to all ASUS products, consistent with the Australian Consumer Law. For the latest product warranty details please visit <https://www.asus.com/support/>. Our goods come with guarantees that cannot be excluded under the Australian Consumer Law. You are entitled to a replacement or refund for a major failure and compensation for any other reasonably foreseeable loss or damage. You are also entitled to have the goods repaired or replaced if the goods fail to be of acceptable quality and the failure does not amount to a major failure.

If you require assistance please call ASUS Customer Service 1300 2787 88 or visit us at <https://www.asus.com/support/>.

ASUS contact information

ASUSTeK COMPUTER INC.

Address 4F, No. 150, Li-Te Rd., Peitou, Taipei 112, Taiwan
Telephone +886-2-2894-3447
Fax +886-2-2890-7798
Web site <https://www.asus.com>

Technical Support

Telephone +86-21-38429911
Fax +86-21-58668722 ext: 9101
Online Support <https://www.asus.com/support/Product/ContactUs/Services/questionform/?lang=en>

ASUSTeK COMPUTER INC. (Taiwan)

Address 4F, No. 150, Li-Te Rd., Peitou, Taipei 112, Taiwan
Telephone +886-2-2894-3447
Fax +886-2-2890-7798
Web site <https://www.asus.com/tw/>

Technical Support

Telephone +886-2-2894-3447 (0800-093-456)
Online Support <https://www.asus.com/support/Product/ContactUs/Services/questionform/?lang=zh-tw>

ASUSTeK COMPUTER INC. (China)

Address No. 5077, Jindu Road, Minhang District, Shanghai, China
Telephone +86-21-5442-1616
Fax +86-21-5442-0099
Web site <https://www.asus.com.cn>

Technical Support

Telephone +86-20-2804-7506 (400-620-6655)
Online Support <https://www.asus.com/support/Product/ContactUs/Services/questionform/?lang=zh-cn>

ASUS contact information

ASUS COMPUTER INTERNATIONAL (America)

Address 48720 Kato Rd., Fremont, CA 94538, USA
Fax +1-510-608-4555
Web site <https://www.asus.com/us/>

Technical Support

Support fax +1-812-284-0883
General support +1-812-282-2787
Online support <https://www.asus.com/support/Product/ContactUs/Services/questionform/?lang=en-us>

ASUS COMPUTER GmbH (Germany and Austria)

Address Harkort Str. 21-23, 40880 Ratingen, Germany
Fax +49-2102-959911
Web site <https://www.asus.com/de/>

Technical Support

Telephone +49-1805-010923
Support Fax +49-2102-959911
Online support <https://www.asus.com/support/Product/ContactUs/Services/questionform/?lang=de-de>

ASUS Czech Service s.r.o. (Europe)

Address Na Rovince 887, 720 00 Ostrava – Hrabová,
Czech Republic
Telephone +420-596766888
Web site <https://www.asus.com/cz/>

Technical Support

Telephone +420-596-766-891
Fax +420-596-766-329
E-mail advance.rma.eu@asus.com
Online Support <https://www.asus.com/support/Product/ContactUs/Services/questionform/?lang=cs-cz>

ASUS contact information

ASUS Holland BV (The Netherlands)

Address Marconistraat 2, 7825GD EMMEN, The Netherlands
Web site <https://www.asus.com/nl/>

Technical Support

Telephone +31-(0)591-5-70292
Fax +31-(0)591-666853
E-mail advance.rma.eu@asus.com
Online Support <https://www.asus.com/support/Product/ContactUs/Services/questionform/?lang=nl-nl>

ASUS Polska Sp. z o.o. (Poland)

Address Ul. Postępu 6, 02-676 Warszawa, Poland
Web site <https://www.asus.com/pl/>

Technical Support

Telephone +48-225718033
Online Support <https://www.asus.com/support/Product/ContactUs/Services/questionform/?lang=pl-pl>

ASK-Service (Russia and CIS)

Address г.Москва, ул. Орджоникидзе, д.10, Россия
Telephone (495) 640-32-75
Web site <https://www.asus.com/ru/>

Technical Support

Telephone 008-800-100-ASUS (008-800-100-2787)
Online Support <https://www.asus.com/support/Product/ContactUs/Services/questionform/?lang=ru-ru>