



Dell UltraSharp UP3218K User's Guide

Model: UP3218K
Regulatory model: UP3218Kt



-  **NOTE:** A NOTE indicates important information that helps you make better use of your computer.
-  **CAUTION:** A CAUTION indicates potential damage to hardware or loss of data if instructions are not followed.
-  **WARNING:** A WARNING indicates a potential for property damage, personal injury, or death.

Copyright © 2017 Dell Inc. All rights reserved. This product is protected by U.S. and international copyright and intellectual property laws.

Dell™ and the Dell logo are trademarks of Dell Inc. in the United States and/or other jurisdictions. All other marks and names mentioned herein may be trademarks of their respective companies.

Contents

About Your Monitor	5
Package Contents	5
Product Features	6
Identifying Parts and Controls	7
Monitor Specifications	10
Plug-and-Play	17
LCD Monitor Quality and Pixel Policy	17
Setting Up the Monitor	18
Attaching the Stand	18
Using the Tilt, Swivel, and Vertical Extension	19
Adjusting the Rotation Display Settings of Your System	20
Connecting Your Monitor	20
Organizing Your Cables	24
Removing the Monitor Stand	24
Wall Mounting (Optional)	25
Operating the Monitor	26
Turning on the Monitor	26
Using the Front Panel Controls	26
Using the On-Screen Display (OSD) Menu	29
Troubleshooting	42
Self-Test	42





Built-in Diagnostics	43
Common Problems.	44
Product Specific Problems	45
Appendix	47
Safety Instructions	47
FCC Notices (U.S. only) and Other Regulatory Information	47
Contacting Dell	47
Setting Up Your Monitor	48
Maintenance Guidelines.	50



About Your Monitor

Package Contents

Your monitor ships with the components shown below. Make sure that you have received all the components and [contact Dell](#) if something is missing.

 **NOTE:** Some items may be optional and may not ship with your monitor. Some features or media may not be available in certain countries.

	Monitor
	Stand
	Power cable (varies by country)
	DP cable (DP to DP) x 2 pcs

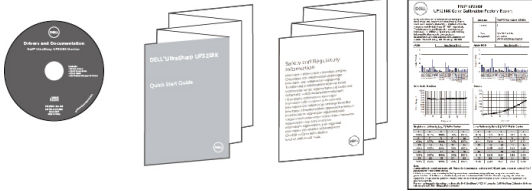
	<p>USB 3.0 upstream cable (enables the USB ports on the monitor)</p>
	<p>Cleaning cloth</p>
	<ul style="list-style-type: none"> • Drivers and documentation media • Quick Setup Guide • Safety and Regulatory Information • Factory Calibration Report

Product Features

The **Dell UltraSharp UP3218K** monitor has an active matrix, TFT-LCD (Color Active Matrix Liquid Crystal Display with a (WLED) The matrix employs Oxide Thin Film Transistor as the active element) and LED backlight. The monitor features include:

- 80.01 cm (31.5-inch) active area display (Measured diagonally) QUHD 7680 x 4320 resolution, plus full-screen support for lower resolutions.
- Wide viewing angles with Adobe RGB 100%, DCI 98% color.
- Tilt, swivel, pivot and vertical extension adjustment capabilities.
- Removable pedestal and Video Electronics Standards Association (VESA™) 100 mm mounting holes for flexible mounting solutions.
- Ultra-thin bezel minimizes the bezel gap in multi-monitor usage, enabling easier set up with an elegant viewing experience.
- Dual DP to support 7680 x 4320 @ 60Hz.
- Support for Displayport version DP1.4.
- Plug and play capability if supported by your system.
- On-Screen Display (OSD) adjustments for ease of set-up and screen optimization.
- Software and documentation media includes an information file (INF), Image color Matching File (ICM), Dell Display Manager software application and product documentation. Dell Display Manager included (comes in the CD attached with the monitor).
- Security lock slot.
- Asset Management Capability.
- Energy Star Compliant.
- EPEAT Gold Compliant.
- RoHS compliant.
- BFR/PVC Free monitor (excluding cables).
- Arsenic-Free glass and Mercury Free for Panel only.
- Energy Gauge shows the energy level being consumed by the monitor in real time.
- 0.5 W standby power when in the sleep mode.

Identifying Parts and Controls

Front view

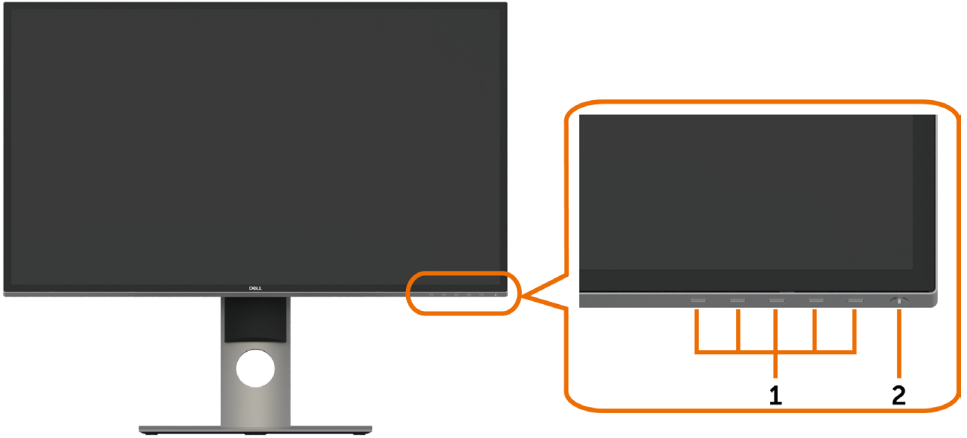

Label	Description
1	Function buttons (For more information, see Operating the Monitor)
2	Power on/off button (with LED indicator)

Back View



Label	Description	Use
1	VESA mounting holes (100 mm x 100 mm-behind attached VESA cover)	Wall mount monitor using VESA-compatible wall mount kit (100 mm x 100 mm).
2	Regulatory label	Lists the regulatory approvals.
3	Stand release button	Release stand from monitor.
4	Barcode, serial number, and Service Tag label	Refer to this label if you need to contact Dell for technical support.
5	LED touch PAD	Stand is fixed while DELL Logo light on.
6	Cable management hole	Use to organize cables by placing them through the hole.

Bottom View

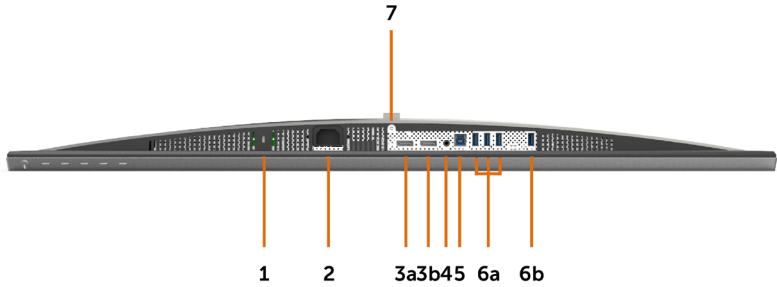

Label	Description	Use
1	Security lock slot	Secures monitor with security cable lock (sold separately).
2	AC power connector	To connect the monitor power cable.
3a	DisplayPort in connector 1	Connect both connectors to your computer with a pair of: <ul style="list-style-type: none"> DP to DP cables for 8K4K (max.) resolution.
3b	DisplayPort in connector 2	
4	Audio line-out port	Connect speakers to playback audio coming through DP audio channels. Only supports 2-channel audio. NOTE: The audio line-out port does not support headphones. ⚠ WARNING: Excessive sound pressure from earphones or headphones can cause hearing damage or loss.
5	USB upstream port	Connect the USB cable that comes with your monitor to the computer. Once this cable is connected, you can use the USB downstream connectors on the monitor.
6a,6b	USB downstream ports (4)	Connect your USB devices. * You can only use these connectors after you have connected the USB cable to the computer and USB upstream connector on the monitor. (Port with  battery icon is for BC 1.2).
7	Stand lock	Lock the stand to the monitor using a M3 x 6 mm screw (screw not included).

* It is recommended to use either the port (6b) for your wireless USB device whenever possible.

Monitor Specifications

Flat Panel Specifications

Screen type	Color Active Matrix Liquid Crystal Display with a (WLED) - TFT LCD
Panel type	In Plane Switching (IPS)
Viewable image	
Diagonal	80.01 cm (31.5 inches)
Active Area	
Horizontal	698.1 mm (27.48 inches)
Vertical	392.7 mm (15.46 inches)
Area	274143.9 mm ² (424.84 inches ²)
Pixel pitch	0.0303 mm x 0.0909 mm
Viewing angle	
Horizontal	178° (typical)
Vertical	178° (typical)
Luminance output	400 cd/m ² (Center 1 Point, typical)
Contrast ratio	1300 to 1 (typical)
Faceplate coating	Anti-Reflective treatment of the front polarizer (2H)
Backlight	LED
Response Time	8 ms (normal), 6 ms (fast)
Color depth	10-bit 1.07 Billion colors
Color gamut	Adobe RGB 100%, sRGB 100%, REC709 100%, DCI 98%

Resolution Specifications

Horizontal scan range	30 kHz to 90 kHz
Vertical scan range	59 Hz to 61 Hz
Maximum preset resolution	7680 x 4320 at 60 Hz
Video display capabilities (DP playback)	480i, 480p, 576i, 576p, 720p, 1080i, 1080p, 2160p, 4320p

Preset Display Modes

Display Mode	Horizontal Frequency (kHz)	Vertical Frequency (Hz)	Pixel Clock (MHz)	Sync Polarity (Horizontal/Vertical)
720 x 400	31.5	70.0	28.3	-/+
640 x 480	31.5	60.0	25.2	-/-
640 x 480	37.5	75.0	31.5	-/-
800 x 600	37.9	60.0	40.0	+/+
800 x 600	46.9	75.0	49.5	+/+
1024 x 768	48.4	60.0	65.0	-/-
1024 x 768	60.0	75.0	78.8	+/+
1152 x 864	67.5	75.0	108.0	+/+
1280 x 800	49.3	60.0	71.0	+/+
1280 x 1024	64.0	60.0	108.0	+/+
1280 x 1024	80.0	75.0	135.0	+/+
1600 x 1200	75.0	60.0	162.0	+/+
1920 x 1080	67.5	60.0	193.5	+/+
2048 x 1080	26.3	24.0	26.3	+/-
2048 x 1080	66.7	60.0	66.6	+/-
2560 x 1440	88.8	60.0	241.5	+/-
3840 x 2160	133.3	60.0	533.3	+/-
7680 x 4320	266.6	60.0	2089.8	+/-

* To display 7680 x 4320 at 60 Hz, both DP1 and DP2 must be connected to the same graphics card. DP source's graphics card must be DP1.4 certified and Tile display feature, capable of supporting resolution up to 7680 x 4320 at 60Hz and its driver supports DisplayID v1.3.

Electrical Specifications

Video input signals	<ul style="list-style-type: none"> • Digital video signal for each differential line Per differential line at 100 ohm impedance • DP signal input support
Input voltage/ frequency/current	100-240 VAC / 50 or 60 Hz \pm 3 Hz / 2.1 A (maximum)
Inrush current	120 V: 40 A (Max.) 240 V: 80 A (Max.)

Physical Characteristics

Connector type	<ul style="list-style-type: none"> • DP connector x 2 • Audio line-out • USB 3.0 upstream port connector • USB 3.0 downstream port connector x 4 (Port with  battery icon is for BC 1.2)
Signal cable type	DP to DP 1.8 M cable USB 3.0 1.8 M cable
Dimensions (with stand)	
Height (extended)	618.0 mm (24.33 inches)
Height (compressed)	498.4 mm (19.62 inches)
Width	720.5 mm (28.37 inches)
Depth	222.0 mm (8.74 inches)
Dimensions (without stand)	
Height	421.2 mm (16.58 inches)
Width	720.5 mm (28.37 inches)
Depth	53.2 mm (2.10 inches)
Stand dimensions	
Height (extended)	479.0 mm (18.85 inches)
Height (compressed)	441.4 mm (17.38 inches)
Width	333.4 mm (13.13 inches)
Depth	222.0 mm (8.74 inches)
Weight	
Weight with packaging	17.0 kg (37.48 lb)
Weight with stand assembly and cables	10.9 kg (24.03 lb)
Weight without stand assembly (For wall mount or VESA mount considerations - no cables)	6.9 kg (15.21 lb)

Weight of stand assembly	3.6 kg (7.94 lb)
--------------------------	------------------

Environmental Characteristics

Temperature	
Operating	0°C to 35°C (32°F to 95°F)
Non-operating	-20°C to 60°C (-4°F to 140°F)
Humidity	
Operating	10% to 80% (non-condensing)
Non-operating	5% to 90% (non-condensing)
Altitude	
Operating	5,000 m (16,404 ft) (maximum)
Non-operating	12,192 m (40,000 ft) (maximum)
Thermal dissipation	426.7 BTU/hour (maximum) 296.8 BTU/hour (typical)

Power Management Modes

If you have VESA's DPM-compliant video card or software installed in your PC, the monitor can automatically reduce its power consumption when not in use. This is referred to as power save mode*. If the computer detects input from the keyboard, mouse, or other input devices, the monitor automatically resumes functioning. The following table shows the power consumption and signaling of this automatic power saving feature.

VESA Modes	Horizontal Sync	Vertical Sync	Video	Power Indicator	Power Consumption
Normal operation	Active	Active	Active	White	125 W (maximum)** 87 W (typical)
Active-off mode	Inactive	Inactive	Off	White (blinking slowly)	Less than 0.5 W
Switch off	-	-	-	Off	Less than 0.3 W

Energy Star	Power Consumption
P _{ON}	105.2 W***
E _{TEC}	325.45 kWh****

The OSD operates only in the normal operation mode. If you press any button in the active-off mode, one of the following message is displayed:

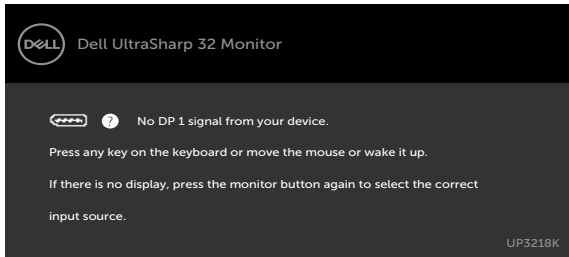

*Zero power consumption in OFF mode can only be achieved by disconnecting the AC mains cable from the monitor.

**Maximum power consumption with maximum luminance.

***Power consumption of on mode as defined in Energy Star 7.0 version.

****Total energy consumption in kWh as defined in Energy Star 7.0 version.

This document is informational only and reflects laboratory performance. Your product may perform differently, depending on the software, components and peripherals you ordered and shall have no obligation to update such information. Accordingly, the customer should not rely upon this information in making decisions about electrical tolerances or otherwise. No warranty as to accuracy or completeness is expressed or implied.

Activate the computer and the monitor to gain access to the OSD.



Pin Assignments

DP connector

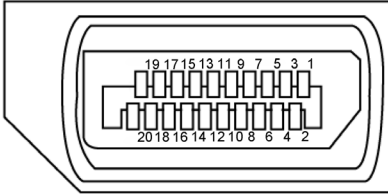

Pin number	20-pin side of the connected signal cable
1	ML3(n)
2	GND
3	ML3(p)
4	ML2(n)
5	GND
6	ML2(p)
7	ML1(n)
8	GND
9	ML1(p)
10	ML0(n)
11	GND
12	ML0(p)
13	GND
14	GND
15	AUX CH (p)
16	GND
17	AUX CH (n)
18	Hot Plug Detect
19	Return
20	DP_PWR

Universal Serial Bus (USB)

This section gives you information about the USB ports available on your monitor.

NOTE: Up to 2 A on USB downstream port (port  with battery icon) with BC 1.2 compliance devices; up to 0.9 A on the other 3 USB downstream ports.

Your computer has the following USB ports:

- 1 upstream - bottom
- 4 downstream - 4 at bottom

Power Charging Port - the one on the left side (Port with  battery icon); supports fast current charging capability if the device is BC 1.2 compatible.

 **NOTE:** The monitor's USB ports work only when the monitor is on or in the power save mode. If you turn off the monitor and then turn it on, the attached peripherals may take a few seconds to resume normal functionality.

Transfer speed	Data rate	Power consumption
SuperSpeed	5 Gbps	4.5 W (Max., each port)
Hi-Speed	480 Mbps	2.5 W (Max., each port)
Full speed	12 Mbps	2.5 W (Max., each port)

USB upstream port

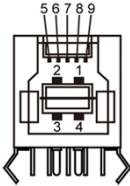

USB downstream port

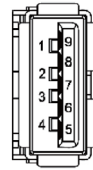

Pin number	Signal name
1	VBUS
2	D-
3	D+
4	GND
5	StdB_SSTX-
6	StdB_SSTX+
7	GND_DRAIN
8	StdB_SSRX-
9	StdB_SSRX+
Shell	Shield

Pin number	Signal name
1	VBUS
2	D-
3	D+
4	GND
5	StdA_SSRX-
6	StdA_SSRX+
7	GND_DRAIN
8	StdA_SSTX-
9	StdA_SSTX+
Shell	Shield

Plug-and-Play

You can install the monitor in any Plug-and-Play-compatible system. The monitor automatically provides the computer system with its extended display identification data (EDID) using display data channel (DDC) protocols so the computer can configure itself and optimize the monitor settings. Most monitor installations are automatic; you can select different settings if desired. For more information about changing the monitor settings, see [Operating the Monitor](#).

LCD Monitor Quality and Pixel Policy

During the LCD monitor manufacturing process, it is not uncommon for one or more pixels to become fixed in an unchanging state which are hard to see and do not affect the display quality or usability. For more information on LCD Monitor Pixel Policy, see Dell support site at: <http://www.dell.com/support/monitors>.

Setting Up the Monitor

Attaching the Stand

 **NOTE:** The stand riser and stand base are detached when the monitor is shipped from the factory.

 **NOTE:** The procedure below is applicable for the default stand. If you purchased any other stand, see the documentation shipped with the stand to set it up.

 **CAUTION:** Place monitor on a flat, clean, and soft surface to avoid scratching the display panel.

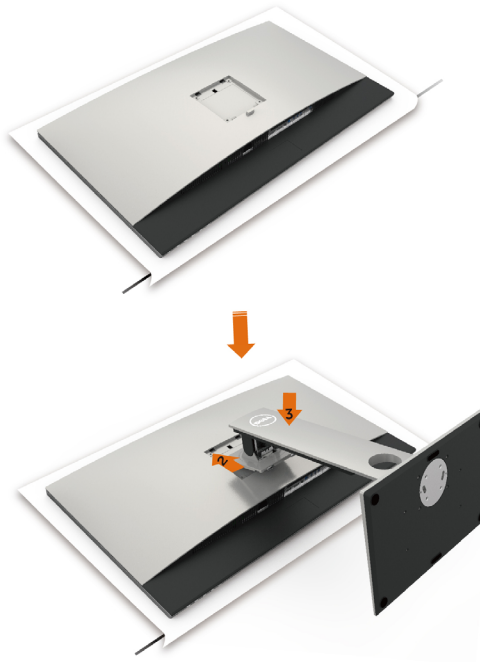

To attach the monitor stand:

- 1 Remove the monitor protective cover and place the monitor with its front facing downward on it.
- 2 Insert the stand to the groove on the back of the monitor.
- 3 Press the stand down till it snaps into its place.

Using the Tilt, Swivel, and Vertical Extension

NOTE: This is applicable for a monitor with a stand. If you purchased any other stand, refer to the respective stand setup guide for set up instructions.

Tilt, Swivel and Vertical Extension

With the stand attached to the monitor, you can tilt the monitor for the most comfortable viewing angle.

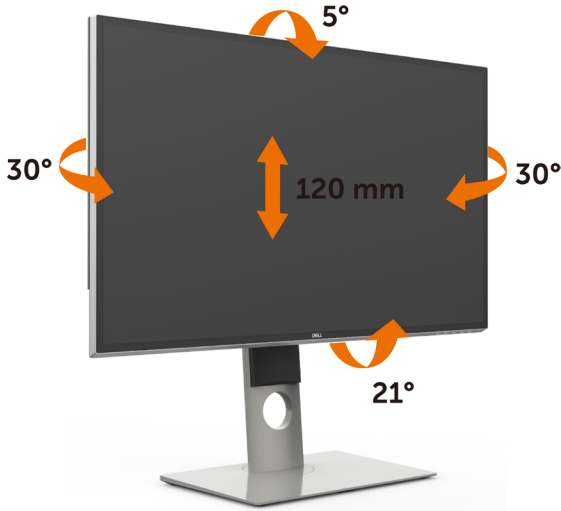



NOTE: The stand is detached when the monitor is shipped from the factory.

Rotating the Monitor

Before you rotate the monitor, your monitor should be fully vertically extended and fully tilted up to avoid hitting the bottom edge of the monitor.



 **NOTE:** To use the Display Rotation function (Landscape versus Portrait view) with your Dell computer, you require an updated graphics driver that is not included with this monitor. To download the graphics driver, go to www.dell.com/support and see the Download section for Video Drivers for latest driver updates.

 **NOTE:** When in the Portrait View Mode, you may experience performance degradation in graphic-intensive applications (3D Gaming and etc.).

Adjusting the Rotation Display Settings of Your System

After you have rotated your monitor, you need to complete the procedure below to adjust the Rotation Display Settings of your System.

 **NOTE:** If you are using the monitor with a non-Dell computer, you need to go the graphics driver website or your computer manufacturer website for information on rotating the 'contents' on your display.

To adjust the Rotation Display Settings:

- 1 Right-click on the desktop and click Properties.
- 2 Select the Settings tab and click Advanced.
- 3 If you have an AMD graphics card, select the Rotation tab and set the preferred rotation.
- 4 If you have an nVidia graphics card, click the nVidia tab, in the left-hand column select NVRotate, and then select the preferred rotation.
- 5 If you have an Intel® graphics card, select the Intel graphics tab, click Graphic Properties, select the Rotation tab, and then set the preferred rotation.

 **NOTE:** If you do not see the rotation option or it is not working correctly, go to www.dell.com/support and download the latest driver for your graphics card.

Connecting Your Monitor

 **WARNING:** Before you begin any of the procedures in this section, follow the [Safety Instructions](#).

To connect your monitor to the computer:

- 1 Turn off your computer.
- 2 Connect the DP-DP/USB cable from your monitor to the computer. (Vertically extend and tilt the monitor completely to rotate it for cable connection. See [Rotating the Monitor](#).)
- 3 Switch on your monitor.
- 4 Select the correct input source at Monitor OSD Menu and turn on your computer.

 **NOTE:** UP3218K default setting is DP 1.4. some older DP 1.2 Graphic card may not display normally. Please refer to "[product specific problems – No image when using DP connection to the PC](#)" to change default setting.

Connecting the DP cables

1. Connection Guide for 8K4K 60Hz (max.) Resolution with AMD or nVidia Graphics Cards (Two DP Cables)

1. Follow the connection guide below for DP cables connection.
2. Turn On the monitor by pressing the power on/off button.
3. Power up/ Boot up the computer system.
4. During BIOS/Post mode, you may observed a stretch screen content.
5. Change resolution if necessary up to 7680 x 4320 60Hz.



- **Recommended list of cards:**
nVidia GeForce series : GTX1070/1080,
Quadro series : P5000/6000.
AMD Radeon series : RX480.
Ensure the graphics card has 2 or more DP outputs.
- **Graphics card requirement:**
With two DP ports that are compliant to DP1.4 support HBR3, DisplayID 1.3 supporting Tile Display feature.
- **AMD driver version:**
revision later than 17.10 or later
<http://support.amd.com/en-us/download>
- **nVidia driver version:**
revision later than 381.xx or later
<http://www.nvidia.com/Download/index.aspx?lang=en-us>

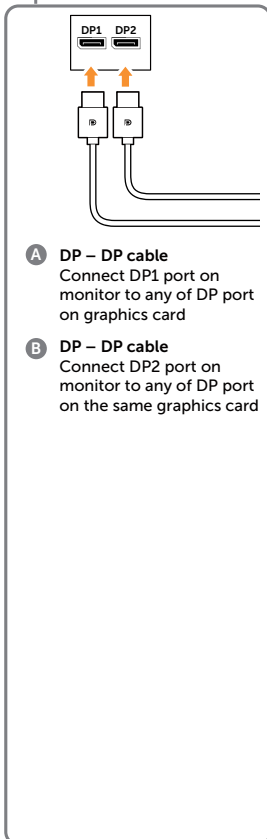

Troubleshooting

1. BIOS/Post screen is not observed, black screen during BIOS/Post, long period of black screen when monitor wake from sleep:

- To speed up monitor initialization, disable monitor Sleep by OSD (Menu>Energy Settings>Monitor Sleep> Disable).

2. 8K4K resolution changed after recovery from PC standby/ Hibernate/ Reboot :

- In certain cases, graphics card may not detect the monitor properly when the monitor goes to sleep.
- Disable monitor Sleep by OSD (Menu > Energy Settings > Monitor Sleep > Disable).
- Reboot PC.

3. Cannot achieve or image unstable at 8k4k resolution:

- Un-install the old graphics driver (Device Manager -> Display Adaptor -> uninstall) before installing the new driver.
- Ensure your graphics card is capable to support 8k4k.
- Use only the in-box DP cables for connection to your PC. Non-DP certified or low quality DP cable may degrade signal integrity/bandwidth, resulting in reduced performance.
- Connect only DP1 on the monitor to any DP port of the graphics card. Power up the monitor and PC system. After getting a stable image(eg 8k4k resolution), connect DP2 of monitor to another DP port of the same graphics card.

2. Connection Guide for 8K4K 30Hz (max.) Resolution (Single DP Cable)

1. Follow the connection guide below for DP cables connection.
2. Turn On the monitor by pressing the power on/off button.
3. Power up/ Boot up the computer or notebook.
4. Change resolution if necessary up to 7680 x 4320 30Hz.

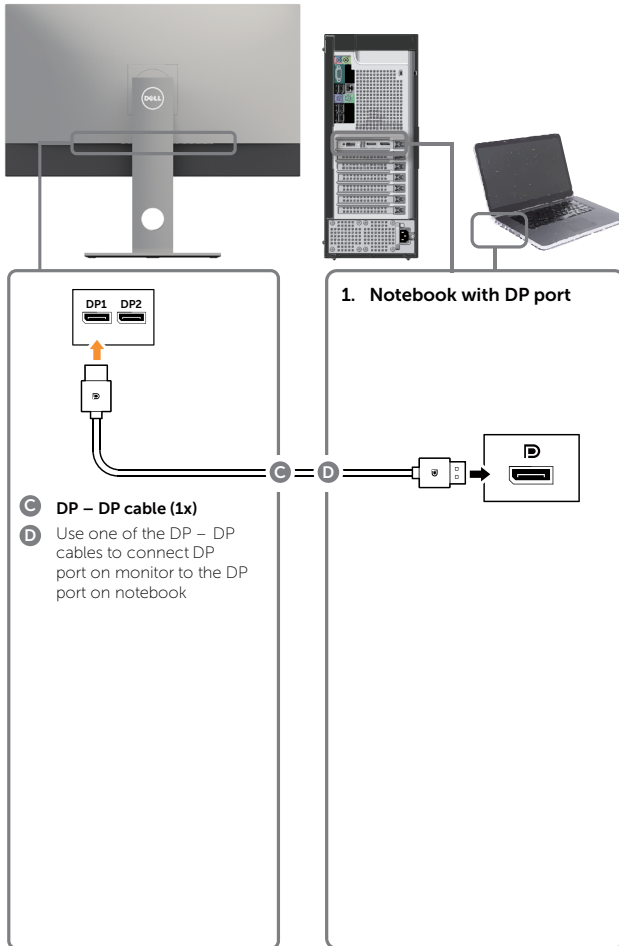

• Graphics card requirement:

Single DP port that is compliant to DP1.4 support HBR3.

• Recommended list of cards:

nVidia GeForce series : GTX1070/1080,
Quadro series : P5000/6000.
AMD Radeon series : RX480.
Ensure the graphics card has 2 or more DP outputs.

• Graphics card requirement:

With two DP ports that are compliant to DP1.4 support HBR3, DisplayID 1.3 supporting Tile Display feature.

• AMD driver version:

revision later than 17.10 or later
<http://support.amd.com/en-us/download>

• nVidia driver version:

revision later than 381.xx or later
<http://www.nvidia.com/Download/index.aspx?lang=en-us>

Troubleshooting

1. BIOS/Post screen is not observed, black screen during BIOS/Post, long period of black screen when monitor wake from sleep:

- To speed up monitor initialization, disable monitor Sleep by OSD (Menu>Energy Settings>Monitor Sleep> Disable).

2. Black screen :

- Ensure the graphics card support DP1.4 (older DP1.1 version is not supported by UP3218K).

3. Cannot achieve or image unstable at 8k4k resolution:

- Ensure your graphics card is capable to support 8k4k.
- Use only the in-box DP cables for connection to your PC. Non-DP certified or low quality DP cable may degrade signal integrity/bandwidth, resulting in reduced performance.

Connecting the USB 3.0 cable

After you have completed connecting the DP-DP cables, follow the procedure below to connect the USB 3.0 cable to the computer and complete your monitor setup:

1. Connect the upstream USB 3.0 port (cable supplied) to an appropriate USB 3.0 port on your computer.
2. Connect the USB 3.0 peripherals to the downstream USB 3.0 ports on the monitor.
3. Plug the power cables for your computer and monitor into nearby outlet.
4. Turn On the monitor and the computer.

If your monitor displays an image, installation is complete. If it does not display an image, see [Troubleshooting](#).

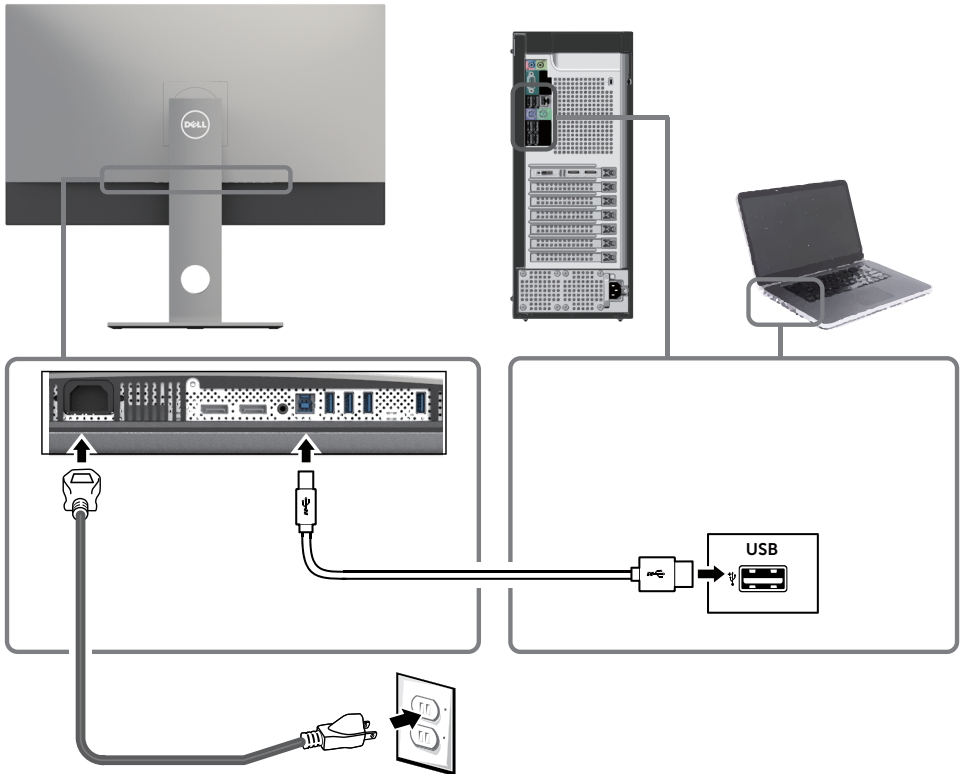

CAUTION: The graphics are used for the purpose of illustration only. Appearance of the computer may vary.

Organizing Your Cables



After attaching all necessary cables to your monitor and computer, (see [Connecting Your Monitor](#) for cable attachment) organize all cables as shown above.

Removing the Monitor Stand



CAUTION: To prevent scratches on the LCD screen while removing the stand, make sure that the monitor is placed on a soft, clean surface.



NOTE: The procedure below is applicable for the default stand. If you purchased any other stand, see the documentation shipped with the stand to set it up.

To remove the stand:

- 1 Place the monitor on a soft cloth or cushion.
- 2 Press and hold the stand-release button.
- 3 Lift the stand up and away from the monitor.

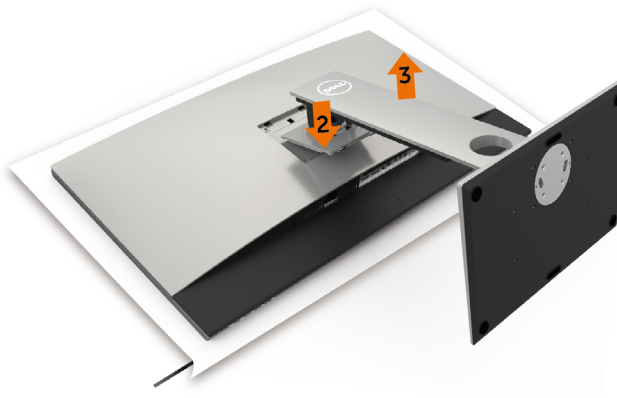

Wall Mounting (Optional)

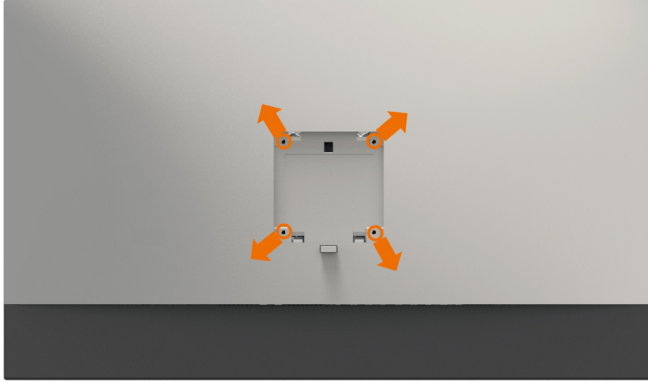

NOTE: Use M4 x 10 mm screws to connect the monitor to the wall-mounting kit.

Refer to the instructions that come with the VESA-compatible wall mounting kit.

- 1 Place the monitor on a soft cloth or cushion on a stable, flat table.
- 2 Remove the stand.
- 3 Use a Phillips crosshead screwdriver to remove the four screws securing the plastic cover.
- 4 Attach the mounting bracket from the wall mounting kit to the monitor.
- 5 Mount the monitor on the wall by following the instructions that comes with the wall mounting kit.

NOTE: For use only with UL or CSA or GS-listed wall mount bracket with minimum weight/load bearing capacity of 6.9 kg (15.21 lb).

Operating the Monitor

Turning on the Monitor

Press the  button to turn on the monitor.







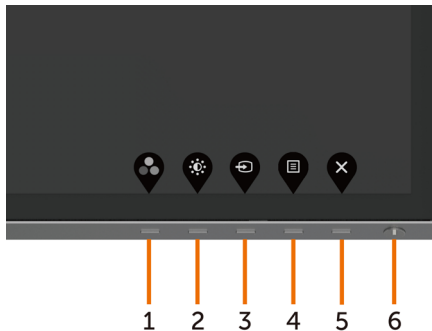

Using the Front Panel Controls

Use the control buttons on the front of the monitor to adjust the characteristics of the image being displayed. As you use these buttons to adjust the controls, an OSD shows the numeric values of the characteristics as they change.







The following table describes the front panel buttons:

Front-Panel Button	Description
1  Shortcut key: Preset Modes	Use this button to choose from a list of preset color modes.
2  Shortcut key: Brightness/Contrast	Use this button to directly access the "Brightness/Contrast" bar.
3  Shortcut key: Input Source	Use this button to choose from a list of Input Source.
4  Menu	Use this menu button to launch the on-screen display (OSD) and select the OSD menu. See Accessing the Menu System .
5  Exit	Use this button to go back to the main menu or exit the OSD main menu.
6  Power (with power light indicator)	Use the Power button to turn the monitor On and Off. The white LED indicates the monitor is On and fully functional. A glowing white LED indicates DPMS Power Save Mode.

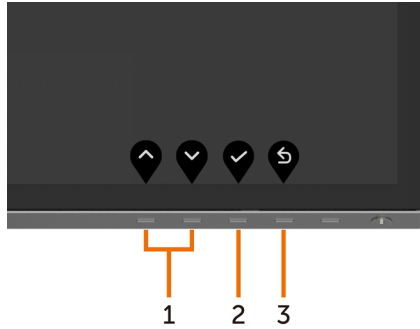
Front-Panel Button

Use the buttons on the front of the monitor to adjust the image settings.



Front Panel Button	Description
1  Up  Down	Use the Up (increase) and Down (decrease) keys to adjust items in the OSD menu.
2  OK	Use the OK button to confirm your selection.
3  Back	Use the Back button to go back to the previous menu.













Using the On-Screen Display (OSD) Menu

Accessing the Menu System

 **NOTE:** Any changes you make using the OSD menu are automatically saved if you move to another OSD menu, exit the OSD menu, or wait for the OSD menu to disappear.

- 1 Press the  button to launch the OSD menu and display the main menu.



- 2 Press the  and  buttons to move between options. As you move from one icon to another, the option name is highlighted.
- 3 Press the  or  or  button once to activate the highlighted option.
- 4 Press the  and  buttons to select the desired parameter.
- 5 Press  to enter the slide bar and then use the  or  button, according to the indicators on the menu, to make your changes.
- 6 Select the  to return to previous menu or  to accept and return to previous menu.

Icon	Menu and Submenus	Description
------	-------------------	-------------



Brightness/Contrast

Use this menu to activate **Brightness/Contrast** adjustment.

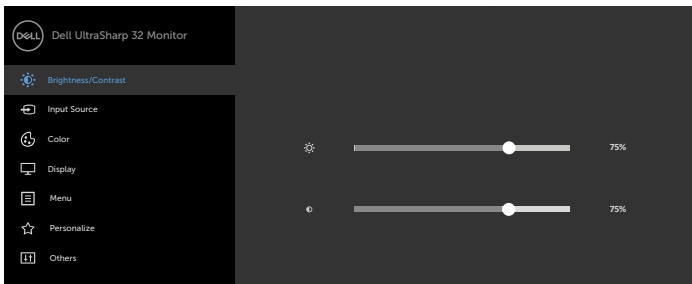

Brightness

Brightness adjusts the luminance of the backlight (minimum 0; maximum 100).



Press the  button to increase brightness.

Press the  button to decrease brightness.

NOTE: Manual adjustment of **Brightness** is disabled when **Dynamic Contrast** is switched on.

Contrast

Adjust the **Brightness** first, and then adjust **Contrast** only if further adjustment is necessary.

Press the  button to increase contrast and press the  button to decrease contrast (between 0 and 100).



Contrast adjusts the difference between darkness and lightness on the monitor.

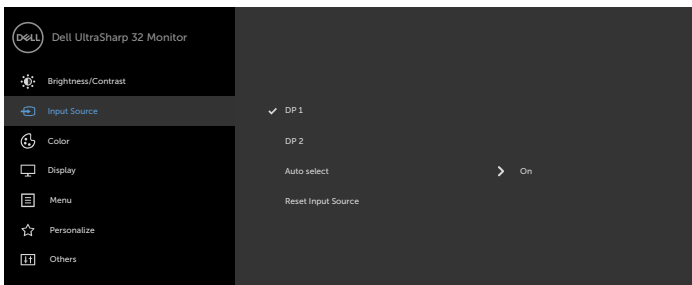

Input Source

Use the **Input Source** menu to select between different video inputs that are be connected to your monitor.



Icon	Menu and Submenus	Description
	DP 1	Select DP 1 input when you are using the DP (DisplayPort) connector. Use  to select the DP 1 input source.
	DP 2	Select DP 2 input when you are using the DP (DisplayPort) connector. Use  to select the DP 2 input source.
	Auto Select	Use  to select Auto Select , the monitor scans for available input sources.
	Reset Input Source	Resets your monitor's Input Source settings to the factory defaults.



Color

Use the **Color** menu to adjust the color setting mode.

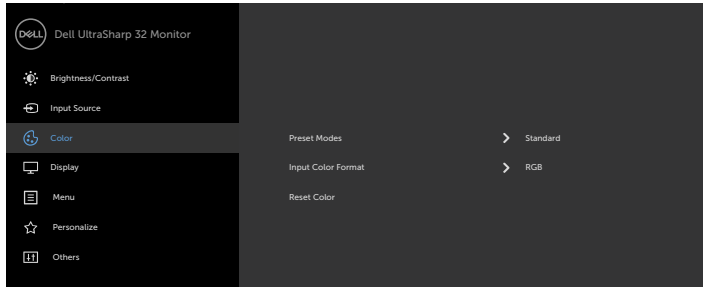





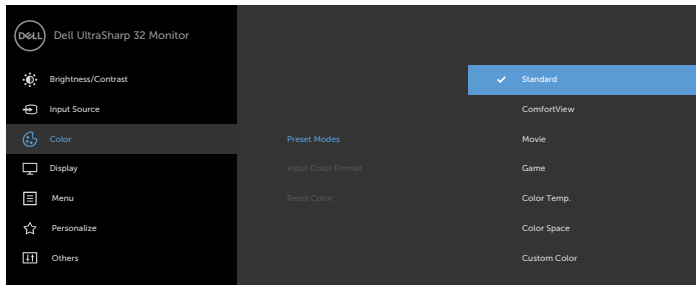

Icon	Menu and Submenus	Description
------	-------------------	-------------

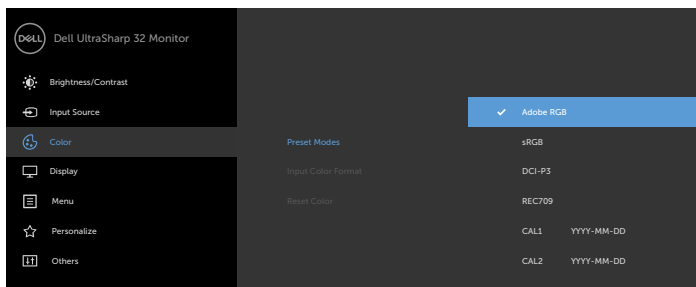

Preset Modes When you select **Preset Modes**, you can choose **Standard**, **ComfortView**, **Movie**, **Game**, **Color Temp.**, **Color Space**, or **Custom Color** from the list.



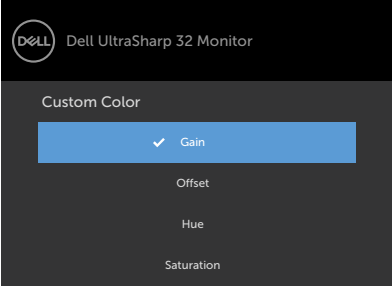



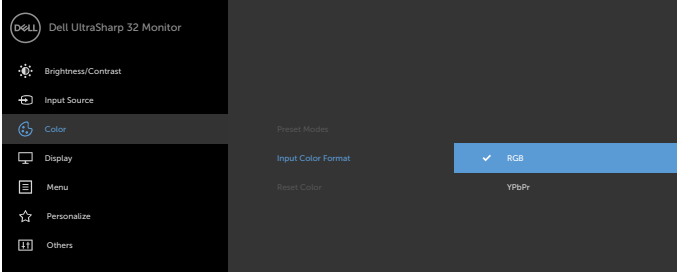



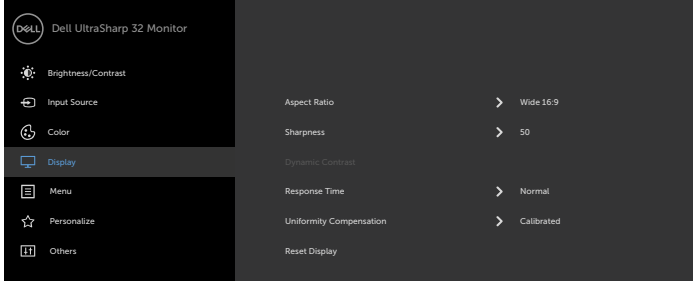

- **Standard:** Default color settings. This is the default preset mode.
- **ComfortView:** Decreases the level of blue light emitted from the screen to make viewing more comfortable for your eyes.
- **Movie:** Ideal for movies.
- **Game:** Ideal for most gaming applications.
- **Color Temp.:** The screen appears warmer with a red/yellow tint with slider set at 5,000K or cooler with blue tint with slider set at 10,000K.
- **Color Space:** Allows users to select the color space: **Adobe RGB**, **sRGB**, **DCI-P3**, **REC709**, **CAL1**, **CAL2**.



Icon	Menu and Submenus	Description
		<ul style="list-style-type: none"> - Adobe RGB: This mode matches 100% Adobe RGB standard. - sRGB: This mode matches 100% sRGB standard. - DCI-P3: This mode reproduces 98% of DCI-P3 digital cinema color standard. - REC709: This mode matches 100% REC709 standard. <p>NOTE: Accuracy of Adobe RGB, sRGB, DCI-P3, REC709, CAL1 and CAL2 are optimized for RGB input color format.</p> <p>• Custom Color: Allows you to manually adjust the color settings. Press the  and  buttons to adjust the Red, Green, and Blue values and create your own preset color mode.</p> <p>Use the  and  buttons to select the Gain, Offset, Hue, Saturation.</p>
		
		
		<ul style="list-style-type: none"> - Gain: Select it to adjust input RGB signal gain level (default value is 100). - Offset: Select it to adjust RGB black-level offset value (default value is 50) to control your monitor base color. - Hue: Select it to adjust RGBCMY hue value individually (default value is 50). - Saturation: Select it to adjust RGBCMY saturation value individually (default value is 50).

Icon	Menu and Submenus	Description
	Input Color Format	<p>Allows you to set the video input mode to:</p> <ul style="list-style-type: none"> • RGB: Select this option if your monitor is connected to a computer (or DVD player) using the DP to DP cable. • YPbPr: Select this option if your DVD player supports only YPbPr output.
		
		
Reset Color	Resets your monitor's color settings to the factory defaults.	

Icon	Menu and Submenus	Description
	Display	Use the Display menu to adjust image.
		
		
Aspect Ratio	Adjust the image ratio to Wide 16:9 , Auto Resize , 4:3 , or 1:1 .	
Sharpness	Makes the image look sharper or softer. Use  or  to adjust the sharpness from '0' to '100'.	
Dynamic Contrast	Allows you to increase the level of contrast to provide sharper and more detailed image quality. Push the  button to select the Dynamic Contrast "On" or "Off". NOTE: For Game and Movie preset mode only. NOTE: Dynamic Contrast provides higher contrast if you select Game or Movie preset mode.	
Response Time	Allows you to set the Response Time to Normal or Fast .	
Uniformity Compensation	Select screen brightness and color uniformity compensation settings. Calibrated is factory calibrated setting by default. Uniformity Compensation adjusts different areas of the screen with respect to the center to achieve uniform brightness and color over the entire screen.	
Reset Display	Restores the display settings to factory defaults.	

Icon	Menu and Submenus	Description
	Menu	Select this option to adjust the settings of the OSD, such as, the languages of the OSD, the amount of time the menu remains on screen, and so on.
		
Language	Set the OSD display to one of eight languages. (English, Spanish, French, German, Brazilian Portuguese, Russian, Simplified Chinese, or Japanese).	
Transparency	Select this option to change the menu transparency by using  and  (min. 0 / max. 100).	
Timer	<p>OSD Hold Time: Sets the length of time the OSD remains active after you press a button.</p> Use the  and  buttons to adjust the slider in 1-second increments, from 5 to 60 seconds.	
Reset Menu	Restore the menu settings to factory defaults.	

Icon	Menu and Submenus	Description
------	-------------------	-------------



Personalize

Select from **Preset Modes, Brightness/Contrast, Input Source** set as shortcut key.

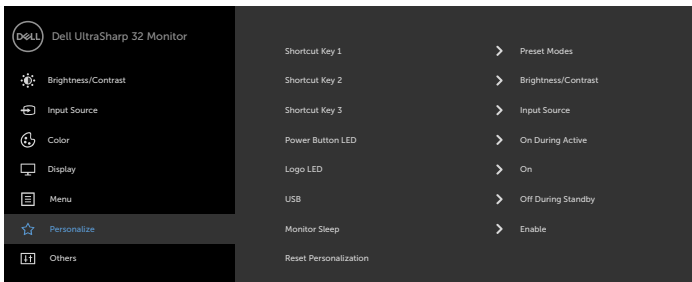

Power Button LED	Allows you to set the state of the power light to save energy.
Logo LED	On: To light up the Dell logo light on the stand. Off: To turn off the Dell logo light on the stand.
USB	Allows you to enable or disable USB function during monitor standby mode. NOTE: USB ON/OFF under standby mode is only available when the USB upstream cable is unplugged. This option will be greyed out when the USB upstream cable plugs in.
Monitor Sleep	Sleep After Timeout: Monitor goes into sleep after timeout. Never: Monitor never goes into sleep.
Reset Personalization	Restores shortcut keys to factory defaults.

Icon	Menu and Submenus	Description
------	-------------------	-------------



Other

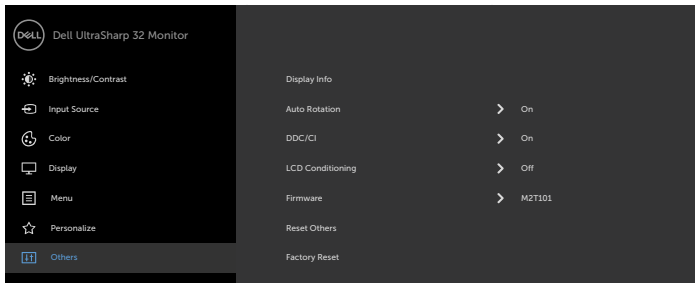

Select this option to adjust the OSD settings, such as the **DDC/CI**, **LCD conditioning**, and so on.

Display Info

Displays the monitor's current settings.

Auto Rotation

You can adjust the menu according to your display rotation.

DDC/CI

DDC/CI (Display Data Channel/Command Interface) allows you to adjust the monitor settings using software on your computer.

Select **Off** to turn off this feature.

On this feature for best user experience and optimum performance of your monitor.

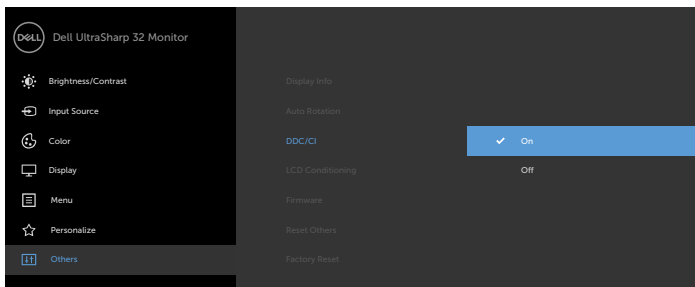

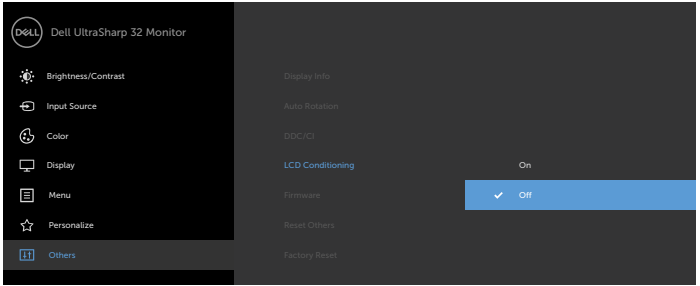
Icon	Menu and Submenus	Description
	LCD Conditioning	Helps reduce minor cases of image retention. Depending on the degree of image retention, the program may take some time to run. Select On to start the process.
		 <p>The screenshot shows the OSD menu for a Dell UltraSharp 32 Monitor. The left sidebar lists menu items: Brightness/Contrast, Input Source, Color, Display, Menu, Personalize, and Others. The main area shows 'LCD Conditioning' set to 'Off' with a blue bar and a checkmark. Other options like 'On', 'Firmware', 'Reset Others', and 'Factory Reset' are visible but dimmed.</p>
	Firmware	Firmware version.
	Reset Others	Restores other settings, such as DDC/CI , to factory defaults.
	Factory Reset	Restores all OSD settings to the factory defaults.



NOTE: This monitor has a built-in feature to automatically calibrate the brightness to compensate for LED aging.

OSD Warning Messages

When the **Dynamic Contrast** feature is enabled (in these preset modes: **Game** or **Movie**), manual brightness adjustment is disabled.

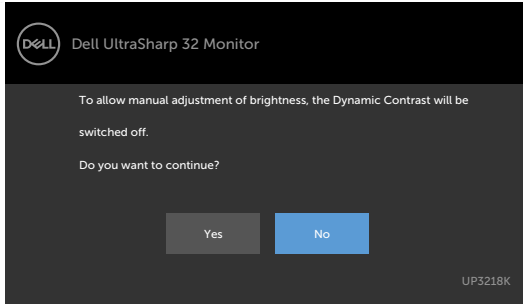

When the monitor does not support a particular resolution mode, you can see the following message:

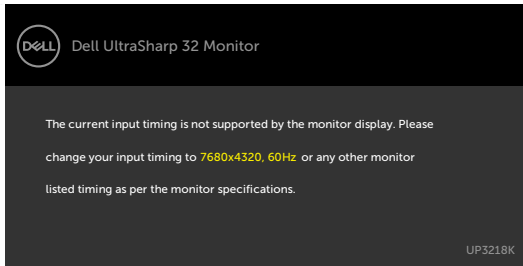

This means that the monitor cannot synchronize with the signal that it is receiving from the computer. See [Monitor Specifications](#) for the Horizontal and Vertical frequency ranges addressable by this monitor. Recommended mode is 7680 x 4320.

You can see the following message before the DDC/CI function is disabled:

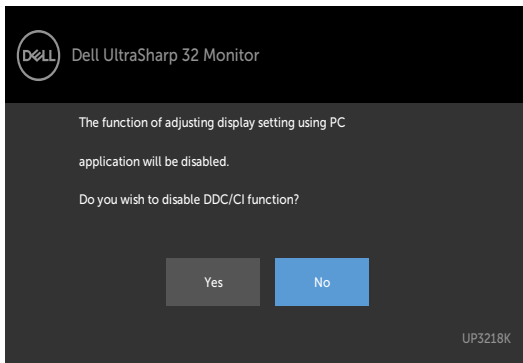

When the monitor enters the **Power Save** mode, the following message appears:

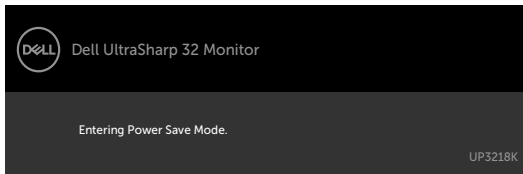

Activate the computer and wake up the monitor to gain access to the **OSD**. If you press any button other than the power button, the following messages will appear depending on the selected input:

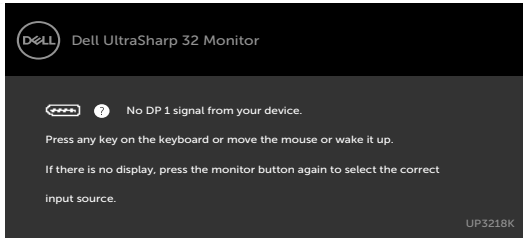

If either DP 1, DP 2 input is selected and the corresponding cable is not connected, a floating dialog box as shown below appears.

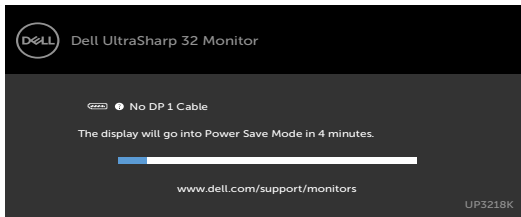

or

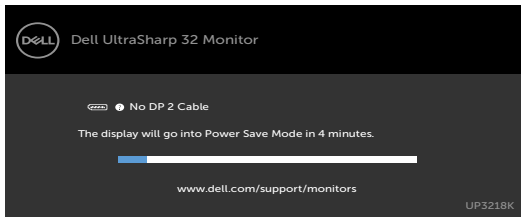

See [Troubleshooting](#) for more information.

Troubleshooting

⚠ WARNING: Before you begin any of the procedures in this section, follow the [Safety Instructions](#).

Self-Test

Your monitor provides a self-test feature that allows you to check whether your monitor is functioning properly. If your monitor and computer are properly connected but the monitor screen remains dark, run the monitor self-test by performing the following steps:

- 1 Turn off both your computer and the monitor.
- 2 Unplug the video cable from the back of the computer. To ensure proper Self-Test operation, remove all digital and the analog cables from the back of computer.
- 3 Turn on the monitor.

The floating dialog box should appear on-screen (against a black background), if the monitor cannot sense a video signal and is working correctly. While in self-test mode, the power LED remains white. Also, depending upon the selected input, one of the dialogs shown below will continuously scroll through the screen.

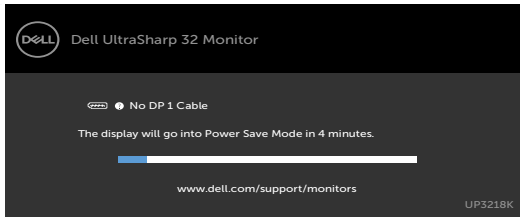

or

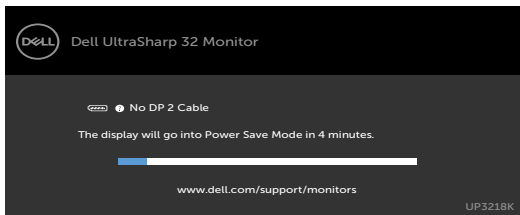

- 4 This box also appears during normal system operation, if the video cable becomes disconnected or damaged.
- 5 Turn off your monitor and reconnect the video cable; then turn on both your computer and the monitor.

If your monitor screen remains blank after you use the previous procedure, check your video controller and computer, because your monitor is functioning properly.

Built-in Diagnostics

Your monitor has a built-in diagnostic tool that helps you determine if the screen abnormality you are experiencing is an inherent problem with your monitor, or with your computer and video card.

 **NOTE:** You can run the built-in diagnostics only when the video cable is unplugged and the monitor is in self-test mode.

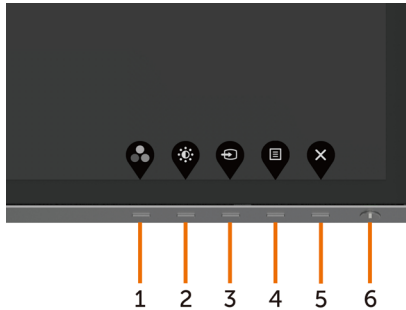

To run the built-in diagnostics:

- 1 Make sure that the screen is clean (no dust particles on the surface of the screen).
- 2 Unplug the video cable(s) from the back of the computer or monitor. The monitor then goes into the self-test mode.
- 3 Press and hold **Button 1** for 5 seconds. A gray screen appears.
- 4 Carefully inspect the screen for abnormalities.
- 5 Press **Button 1** on the front panel again. The color of the screen changes to red.
- 6 Inspect the display for any abnormalities.
- 7 Repeat steps 5 and 6 to inspect the display in green, blue, black, white, and text screens.

The test is complete when the text screen appears. To exit, press **Button 1** again. If you do not detect any screen abnormalities upon using the built-in diagnostic tool, the monitor is functioning properly. Check the video card and computer.

Common Problems

The following table contains general information about common monitor problems you might encounter and the possible solutions:

Common Symptoms	What You Experience	Possible Solutions
No Video/Power LED off	No picture	<ul style="list-style-type: none">• Ensure that the video cable connecting the monitor and the computer is properly connected and secure.• Verify that the power outlet is functioning properly using any other electrical equipment.• Ensure that the power button is depressed fully.• Ensure that the correct input source is selected in the Input Source menu.
No Video/Power LED on	No picture or no brightness	<ul style="list-style-type: none">• Increase brightness & contrast controls via OSD.• Perform monitor self-test feature check.• Check for bent or broken pins in the video cable connector.• Run the built-in diagnostics.• Ensure that the correct input source is selected in the Input Source menu.
Missing Pixels	LCD screen has spots	<ul style="list-style-type: none">• Cycle power on-off.• Pixel that is permanently off is a natural defect that can occur in LCD technology.• For more information on Dell Monitor Quality and Pixel Policy, see Dell Support site at: http://www.dell.com/support/monitors.
Stuck-on Pixels	LCD screen has bright spots	<ul style="list-style-type: none">• Cycle power On-Off.• Pixel that is permanently off is a natural defect that can occur in LCD technology.• For more information on Dell Monitor Quality and Pixel Policy, see Dell Support site at: http://www.dell.com/support/monitors.
Brightness Problems	Picture too dim or too bright	<ul style="list-style-type: none">• Reset the monitor to factory settings.• Adjust brightness & contrast controls via OSD.
Safety Related Issues	Visible signs of smoke or sparks	<ul style="list-style-type: none">• Do not perform any troubleshooting steps.• Contact Dell immediately.
Intermittent Problems	Monitor malfunctions on & off	<ul style="list-style-type: none">• Ensure that the video cable connecting the monitor to the computer is connected properly and is secure.• Reset the monitor to factory settings.• Perform monitor self-test feature check to determine if the intermittent problem occurs in self-test mode.

Common Symptoms	What You Experience	Possible Solutions
Missing Color	Picture missing color	<ul style="list-style-type: none"> • Perform monitor self-test. • Ensure that the video cable connecting the monitor to the computer is connected properly and is secure. • Check for bent or broken pins in the video cable connector.
Wrong Color	Picture color not good	<ul style="list-style-type: none"> • Change the settings of the Preset Modes in the Color menu OSD depending on the application. • Adjust R/G/B value under Custom. Color in Color menu OSD. • Change the Input Color Format to PC RGB or YPbPr in the Color menu OSD. • Run the built-in diagnostics.
Image retention from a static image left on the monitor for a long period of time	Faint shadow from the static image displayed appears on the screen	<ul style="list-style-type: none"> • Use the Power Management feature to turn off the monitor at all times when not in use (for more information, see Power Management Modes). • Alternatively, use a dynamically changing screensaver.

Product Specific Problems

Specific Symptoms	What You Experience	Possible Solutions
Screen image is too small	Image is centered on screen, but does not fill entire viewing area	<ul style="list-style-type: none"> • Check the Aspect Ratio setting in the Display menu OSD. • Reset the monitor to factory settings.
Cannot adjust the monitor with the buttons on the front panel	OSD does not appear on the screen	<ul style="list-style-type: none"> • Turn off the monitor, unplug the monitor power cable, plug it back, and then turn on the monitor.
No Input Signal when user controls are pressed	No picture, the LED light is white	<ul style="list-style-type: none"> • Check the signal source. Ensure the computer is not in the power saving mode by moving the mouse or pressing any key on the keyboard. • Check whether the signal cable is plugged in properly. Re-plug the signal cable if necessary. • Reset the computer or video player.
The picture does not fill the entire screen	The picture cannot fill the height or width of the screen	<ul style="list-style-type: none"> • Due to different video formats (aspect ratio) of DVDs, the monitor may display in full screen. • Run the built-in diagnostics.

Specific Symptoms	What You Experience	Possible Solutions
No image when using DP connection to the PC	Black screen	<ul style="list-style-type: none">• Verify which DP standard is your Graphics Card certified to. Download and install the latest graphics card driver.• Some DP 1.1 or DP 1.2 graphics card cannot support DP 1.4 monitors. Go to OSD menu, under Input Source selection, press and hold DP select  key for 8 sec to change the monitor setting from DP 1.4 to DP 1.2.

Appendix

Safety Instructions

For displays with glossy bezels the user should consider the placement of the display as the bezel may cause disturbing reflections from surrounding light and bright surfaces.

 **WARNING: Use of controls, adjustments, or procedures other than those specified in this documentation may result in exposure to shock, electrical hazards, and/or mechanical hazards.**

For information on safety instructions, see the Safety, Environmental, and Regulatory Information (SERI).

FCC Notices (U.S. only) and Other Regulatory Information

For FCC notices and other regulatory information, see the regulatory compliance website located at www.dell.com/regulatory_compliance.

Contacting Dell

 **NOTE:** If you do not have an active Internet connection, you can find contact information on your purchase invoice, packing slip, bill, or Dell product catalog.

Dell provides several online and telephone-based support and service options. Availability varies by country and product, and some services may not be available in your area.

To get online Monitor support content:

See www.dell.com/support/monitors.

To contact Dell for sales, technical support, or customer service issues:

- 1 Go to www.dell.com/support.
- 2 Verify your country or region in the Choose A Country/Region drop-down menu at the top-left corner of the page.
- 3 Click **Contact Us** next to the country dropdown.
- 4 Select the appropriate service or support link based on your need.
- 5 Choose the method of contacting Dell that is convenient for you.

Setting Up Your Monitor

Setting Display Resolution to 7680 x 4320 (maximum)

For best performance, set the display resolution to 7680 x 4320 pixels by performing the following steps:

In Windows Vista, Windows 7, Windows 8 or Windows 8.1:

- 1 For Windows 8 or Windows 8.1 only, select the Desktop tile to switch to classic desktop.
- 2 Right-click on the desktop and click **Screen Resolution**.
- 3 Click the Dropdown list of the Screen Resolution and select 7680 x 4320.
- 4 Click **OK**.

In Windows 10:

- 1 Right-click on the desktop and click **Display Settings**.
- 2 Click **Advanced display settings**.
- 3 Click the dropdown list of **Resolution** and select 7680 x 4320.
- 4 Click **Apply**.

If you do not see the recommended resolution as an option, you may need to update your graphics driver. Please choose the scenario below that best describes the computer system you are using, and follow the given steps.

Dell computer

- 1 Go to www.dell.com/support, enter your service tag, and download the latest driver for your graphics card.
- 2 After installing the drivers for your graphics adapter, attempt to set the resolution to 7680 x 4320 again.

 **NOTE:** If you are unable to set the resolution to 7680 x 4320, please contact Dell to inquire about a graphics adapter that supports these resolutions.

Non-Dell computer

In Windows Vista, Windows 7, Windows 8 or Windows 8.1:

- 1 For Windows 8 or Windows 8.1 only, select the Desktop tile to switch to classic desktop.
- 2 Right-click on the desktop and click **Personalization**.
- 3 Click **Change Display Settings**.
- 4 Click **Advanced Settings**.
- 5 Identify your graphics controller supplier from the description at the top of the window (e.g. NVIDIA, AMD, Intel etc.).
- 6 Refer to the graphic card provider website for updated driver (for example, <http://www.AMD.com> or <http://www.NVIDIA.com>).
- 7 After installing the drivers for your graphics adapter, attempt to set the resolution to **7680 x 4320** again.

In Windows 10:

- 1 Right-click on the desktop and click **Display Settings**.
- 2 Click **Advanced display settings**.
- 3 Click **Display adapter properties**.
- 4 Identify your graphics controller supplier from the description at the top of the window (e.g. NVIDIA, AMD, Intel etc.).
- 5 Refer to the graphic card provider website for updated driver (for example, <http://www.AMD.com> or <http://www.NVIDIA.com>).
- 6 After installing the drivers for your graphics adapter, attempt to set the resolution to 7680 x 4320 again.



NOTE: If you are unable to set the recommended resolution, please contact the manufacturer of your computer or consider purchasing a graphics adapter that supports the video resolution.

Maintenance Guidelines

Cleaning Your Monitor



WARNING: Before cleaning the monitor, unplug the monitor power cable from the electrical outlet.



CAUTION: Read and follow the [Safety Instructions](#) before cleaning the monitor.

For best practices, follow these instructions in the list below while unpacking, cleaning, or handling your monitor:

- To clean your anti-static screen, lightly dampen a soft, clean cloth with water. If possible, use a special screen-cleaning tissue or solution suitable for the anti-static coating. Do not use benzene, thinner, ammonia, abrasive cleaners, or compressed air.
- Use a lightly-dampened, soft cloth to clean the monitor. Avoid using detergent of any kind as some detergents leave a milky film on the monitor.
- If you notice white powder when you unpack your monitor, wipe it off with a cloth.
- Handle your monitor with care as a darker-colored monitor may get scratched and show white scuff marks more than a lighter-colored monitor.
- To help maintain the best image quality on your monitor, use a dynamically changing screen saver and turn off your monitor when not in use.