



Lenovo Preferred Pro USB Fingerprint Keyboard User Guide

 <http://www.lenovo.com/safety>

Note: Before installing the product, be sure to read the warranty information in Appendix B “Lenovo Limited Warranty” on page 17.

Sixth Edition (August 2016)

© Copyright Lenovo 2010, 2016.

LIMITED AND RESTRICTED RIGHTS NOTICE: If data or software is delivered pursuant to a General Services Administration “GSA” contract, use, reproduction, or disclosure is subject to restrictions set forth in Contract No. GS-35F-05925.

Contents

Chapter 1. About the Lenovo Preferred Pro USB Fingerprint Keyboard	1
Product description	1
Front view	1
Rear view	3
System requirements	4
Chapter 2. Installing the Lenovo Preferred Pro USB Fingerprint Keyboard	5
Installing the ThinkVantage Fingerprint Software	5
Installing the Lenovo Preferred Pro USB Fingerprint Keyboard	5
Chapter 3. Using the Lenovo Preferred Pro USB Fingerprint Keyboard	7
Creating a passport and enrolling fingerprints	7
Swiping your finger over the fingerprint reader	7
Chapter 4. Fingerprint reader settings in the BIOS	9
Setting up the fingerprint reader in the BIOS	9
Changing the BIOS settings for the fingerprint reader	9
Enrolling your fingerprints for BIOS passwords	10
Chapter 5. Caring for the fingerprint reader	11
Chapter 6. Troubleshooting	13
Appendix A. Service and Support	15

Online technical support	15
Telephone technical support	15
Accessibility information	15

Appendix B. Lenovo Limited Warranty	17
Part 1 - General Terms	17
Part 2 - Country-specific Terms	20
Part 3 - Warranty Service Information	22
Suplemento de Garantía para México	23

Appendix C. Compliance information	25
Electronic emission notices	25
Federal Communications Commission Declaration of Conformity	25

Appendix D. Notices	29
Recycling and environmental information	29
Recycling information for Brazil	29
Important WEEE information	30
Export Classification Notice	30
Trademarks	30

Appendix E. Restriction of Hazardous Substances (RoHS) Directive	33
European Union RoHS	33
China RoHS	33
Turkish RoHS	33
Ukraine RoHS	33
India RoHS	34

Chapter 1. About the Lenovo Preferred Pro USB Fingerprint Keyboard

This manual provides product description and instructions for installing and using the Lenovo® Preferred Pro USB Fingerprint Keyboard (hereafter called the keyboard).

Product description

This section provides a general description of the keyboard.

The keyboard is equipped with many functions that add convenience and security to your computer. Instead of using a password, the fingerprint reader on the keyboard enables you to swipe your fingerprint to access your computer resources. As multiple unique fingerprints are available at your fingertips and are stored securely on your computer, you can be assured that your personal information is protected.

Your option package includes the following:

- Lenovo Preferred Pro USB Fingerprint Keyboard
- Warranty poster
- *Software and User Guide Disc*

Front view

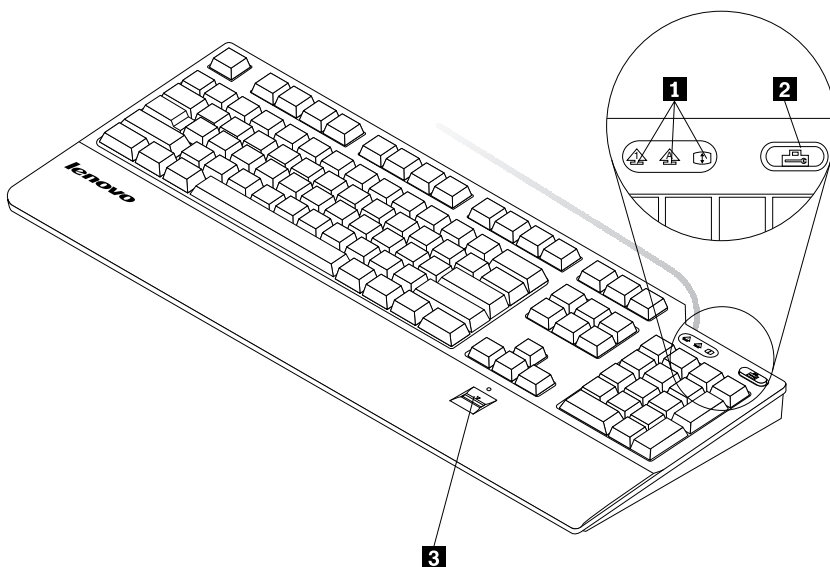

Figure 1. Front view of the keyboard

1 LED (light-emitting diode) indicators

The keyboard has the following three LED indicators:

- Numeric Lock LED:



When the Numeric Lock LED is illuminated, the numeric keypad on the keyboard is enabled. When the LED is not illuminated, the cursor control on the numeric keypad is enabled. Press the Numeric Lock (NumLk or NmLk) key to switch back and forth between these modes.

- Caps Lock LED:



When the Caps Lock LED is illuminated, the Caps Lock mode is enabled. In this mode, you can type all alphabetic characters (A-Z) in upper case without pressing the Shift key. When the LED is not illuminated, the Caps Lock mode is disabled. To enable or disable the Caps Lock mode, press the Caps Lock (Caps Lock or CapsLk) key.

- Scroll Lock LED:



When the Scroll Lock LED is illuminated, the Scroll Lock mode is enabled. The arrow keys can be used as screen-scroll function keys and the cursor cannot be moved with the arrow keys. Not all application programs support this function. When the Scroll Lock LED is not illuminated, the arrow keys can be used for cursor movement, not as screen-scroll function keys. Press the Scroll Lock (ScrLk) key to switch back and forth between these modes.

2 The ThinkVantage button

For the Microsoft® Windows® XP or Microsoft Windows Vista® operating system, whenever you have a question about your computer or want to view Lenovo Web sites, press the ThinkVantage® button to open the ThinkVantage Productivity Center or the Lenovo CareSM program for comprehensive help and information for your computer.

Note: The ThinkVantage Productivity Center or the Lenovo Care program comes with your computer. If you do not have either of them installed on your computer, pressing the ThinkVantage button will open the Windows System Information window.

For the Microsoft Windows 7 operating system, press the ThinkVantage button to open the Lenovo SimpleTap or Lenovo ThinkVantage Toolbox program.

The SimpleTap program provides a quick way to customize the basic settings and personalized features of the computer. The Lenovo ThinkVantage Toolbox program is a one-stop diagnostic solution. It can quickly identify and resolve system performance and security problems.

For the Microsoft Windows 8, press the ThinkVantage button to open the Lenovo Device Experience program.

3 Fingerprint reader

With the integrated fingerprint reader, you can enroll your fingerprints and associate them with a power-on password, a hard disk drive password, or both beforehand. Thus the fingerprint authentication can replace passwords and enable simple and secure user access.

Attention: Power-on and hard disk drive passwords support *requires* that fingerprint recognition be supported by your computer Basic Input Output System (BIOS). If your computer BIOS supports fingerprint

recognition, you can start the computer, log on to the system, and enter the BIOS Setup Utility by swiping your finger over the reader, without typing a password.

For more information about systems that support power-on passwords and hard disk drive passwords, see the following:

- Chapter 4 “Fingerprint reader settings in the BIOS” on page 9.
- “Changing the BIOS settings for the fingerprint reader” on page 9.

Rear view

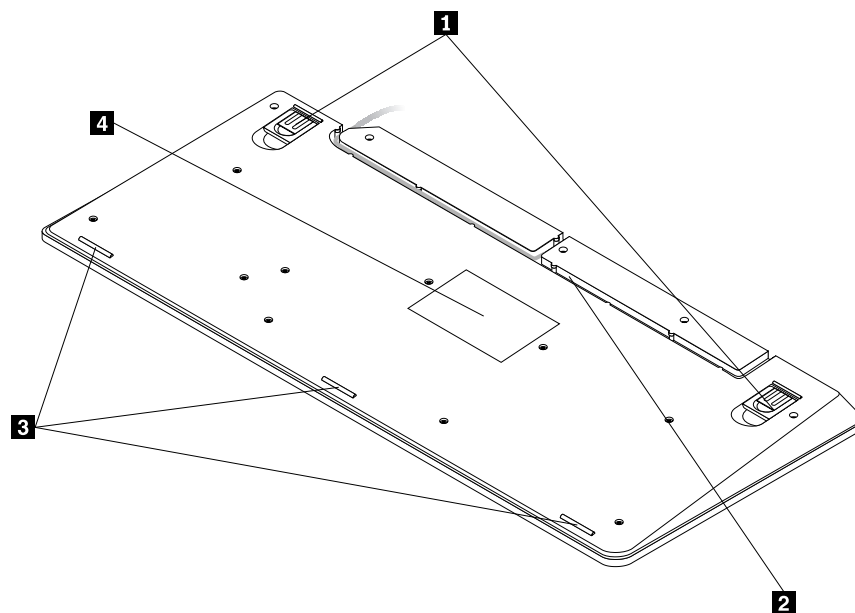

Figure 2. Rear view of the keyboard

- **1 Adjustable tilt feet**

The keyboard has three tilt feet positions with which you can adjust the angle of the keyboard to provide maximum comfort. The three keyboard angles are as follows:

- **3.5 degrees:** When none of the feet are raised, the keyboard is at a 3.5-degree angle.
- **6 degrees:** The small tilt feet raise the keyboard to a 6-degree angle.
- **9 degrees:** The large tilt feet raise the keyboard to a 9-degree angle.

- **2 Cable slot**

The cable slot provides a convenient way to change the location where the cable leaves the keyboard. You can press the keyboard cable into the left or right slot to reduce cable clutter and optimize desk space.

- **3 Non-skid feet**

The bottom of your keyboard has three non-skid feet to prevent the keyboard from moving when it is in use.

- **4 Label**

The label on the bottom of the keyboard includes country certifications and provides important information that might be necessary if you need to make a service call.

System requirements

Before using the keyboard, ensure that your computer meets the following system requirements:

- One of the following operating systems:
 - Microsoft Windows XP (32-bit)
 - Microsoft Windows Vista (32-bit or 64-bit)
 - Microsoft Windows 7 (32-bit or 64-bit)
 - Microsoft Windows 8 (32-bit or 64-bit)
- An available USB connector

Chapter 2. Installing the Lenovo Preferred Pro USB Fingerprint Keyboard

This section provides information about installing the ThinkVantage Fingerprint Software and the keyboard.

Installing the ThinkVantage Fingerprint Software

Note: If a keyboard driver is installed on the computer, uninstall the keyboard driver before installing the ThinkVantage Fingerprint Software.

To install the ThinkVantage Fingerprint Software on the Windows XP, Windows Vista, Windows 7, or Windows 8 operating system, do the following:

1. Save any open documents and exit all applications.
2. Insert the *Software and User Guide Disc* into the optical drive. The disc starts automatically. If the disc does not start automatically, do one of the following:
 - If the autoplay window opens, click **Run ViewHtml.exe**.
 - If the autoplay window does not open, do one of the following:
 - For the Windows XP, Windows Vista, or Windows 7 operating system, go into **My Computer** or **Computer**, then double-click the CD/DVD drive icon.
 - For the Windows 8, open File Explorer and click **Computer** or **This PC**, then double-click the CD/DVD drive icon.
3. Select your language.
4. Click **Software** in the left pane of the window.
5. Follow the instructions on the screen to install the device driver.

Note: After you have successfully installed the ThinkVantage Fingerprint Software, you must create a passport and enroll your fingerprints before the fingerprint reader is functional. See “Creating a passport and enrolling fingerprints” on page 7 for more information.

Installing the Lenovo Preferred Pro USB Fingerprint Keyboard

To install the keyboard, do the following:

1. Adjust the tilt feet to set the keyboard near your computer to your preference.
2. Connect the keyboard cable to an available USB connector on your computer, as shown:

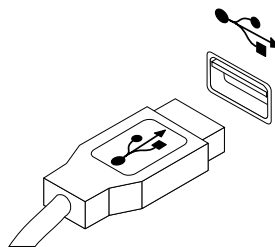

Figure 3. Connecting the keyboard cable

Note: Route the keyboard cable into the cable slot if necessary.

After the operating system identifies the keyboard, the keyboard will be ready for use.

Chapter 3. Using the Lenovo Preferred Pro USB Fingerprint Keyboard

This section provides information about using the fingerprint reader on the keyboard.

Creating a passport and enrolling fingerprints

To create a passport and enroll your first fingerprint, do the following:

1. Open the ThinkVantage Fingerprint Software window by doing one of the following:
 - Click **Start** → **All Programs** → **ThinkVantage** → **ThinkVantage Fingerprint Software**. The ThinkVantage Fingerprint Software window opens.
 - Click **Start** → **All Programs** → **Lenovo ThinkVantage Tools**. Then, double-click **Fingerprint Reader**. The ThinkVantage Fingerprint Software window opens.
2. Enter your Windows password and click **Submit**. The End User Agreement window is displayed.
3. Carefully read the End User Agreement and click **Accept**.

Note: You must agree to the End User Agreement to install the product.

4. When a dialog with two hands is displayed, select a finger to enroll by clicking the button above the finger.
5. Swipe the selected finger over the fingerprint sensor. Good quality matching fingerprints are required. It is strongly recommended that you enroll more than one finger in the event of injury.
6. (Optional - only if supported by your computer) A Power-on button is displayed above each finger. Click the Power-on button above the selected finger. The selected finger will be used instead of your power-on and/or hard disk passwords (BIOS passwords) at the system startup.

Notes:

- If you do not use a Windows password, you will be prompted to define one. This is optional, but a password improves the security of your software.
- For more information about enrolling your fingerprint for power-on and hard disk drive passwords (BIOS passwords), see “Enrolling your fingerprints for BIOS passwords” on page 10.

Swiping your finger over the fingerprint reader

To swipe your finger over the fingerprint reader, do the following:

1. Place your fingertip on the small circular indentation above the reader, as shown below. Ensure that the rest of your finger is flat on the reader.

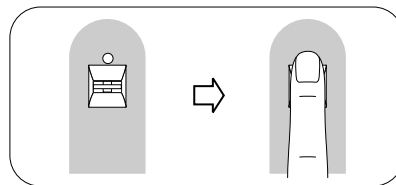

Figure 4. Placing your fingertip above the reader

2. Apply light pressure, and swipe your finger across the reader in one smooth motion, as shown below.

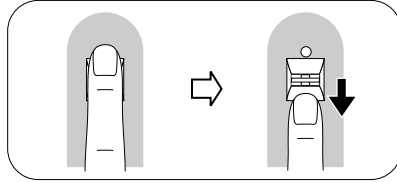

Figure 5. *Swiping your finger across the reader*

Chapter 4. Fingerprint reader settings in the BIOS

This section provides information about the fingerprint reader settings in the BIOS.

Setting up the fingerprint reader in the BIOS

To set up the fingerprint reader in your computer BIOS, do the following:

1. Set a power-on password or a hard disk drive password, or both.
2. Turn off the computer and then turn it on.
3. When prompted, swipe your finger over the fingerprint reader.
4. Type your power-on password, your hard disk drive password, or both as requested. The enrolled fingerprint is now associated with your power-on password, your hard disk drive password, or both.

The first time you start the computer, you will need to log on to the system by swiping your finger over the reader once and entering your password to associate the two. The next time you start the computer, you can log on to the system by swiping your finger over the reader once.

Attention: If you always use your fingerprint to log on to the system, you may forget your BIOS password. Write down your password and keep it in a safe place. If you forget your password and cannot swipe your finger, you cannot start the computer or change the password. For optimal performance, enroll more than one fingerprint.

If you forget your power-on password, you must take your computer to a Lenovo service representative to have the password erased.

If you forget your hard disk drive password, Lenovo will not reset your password or recover data from the hard disk drive. You must take your computer to a Lenovo service representative to have the hard disk drive replaced. Proof of purchase is required, and a fee will be charged for parts and service.

Changing the BIOS settings for the fingerprint reader

Note: The information in this topic applies to certain ThinkPad® computer models only.

The **Fingerprint** submenu under the **Security** menu of the BIOS Setup Utility program offers the following choices:

- **Predesktop authentication:** Enables or disables the fingerprint authentication before the operating system is loaded.
- **Security Mode:** Specifies the settings of the security mode.

To change the settings of the fingerprint reader, do the following:

1. Print these instructions.
2. Save all open files and exit all applications.
3. Turn off the computer and then turn it on.
4. When the “To interrupt normal startup...” message is displayed on the lower left side of the window, press F1. The BIOS Setup Utility window opens.
5. Using the cursor keys, move to **Security** and press Enter. The **Security** menu opens.
6. Using the cursor keys, move to **Fingerprint** and press Enter. The **Fingerprint** menu opens.

7. Using the cursor keys, move to an item you want to set. When that item is highlighted, press Enter.
8. Using the cursor keys, select the setting you want to use and press Enter. A Notice window is displayed, saying Changes have been saved and presenting you with a choice **Continue**.
9. Press Enter to continue.
10. Using the cursor keys, make other fingerprint settings depending on your needs.
11. Press F10 to exit.
12. In the Setup Confirmation window, select **Yes** to save configuration changes and exit.

Enrolling your fingerprints for BIOS passwords

To enroll your fingerprints for BIOS passwords (power-on and hard disk drive passwords), do the following:

1. Depending on your operating system, do one of the following:
 - Click **Start → All Programs → ThinkVantage → ThinkVantage Fingerprint Software**. The ThinkVantage Fingerprint Software window opens.
 - Click **Start → All Programs → Lenovo ThinkVantage Tools**. Then, double-click **Fingerprint Reader**. The ThinkVantage Fingerprint Software window opens.
2. Enter your Windows password and click **Submit**.
3. When a dialog with two hands appears, select a finger to enroll by clicking the corresponding **Windows** button above the finger. The Enrollment window opens.
4. Swipe the selected finger over the fingerprint reader on your computer. Keep scanning until the progress bar reaches 100%. Then, you will return to the dialog with two hands and there will be a green circle around the image of the finger you just enrolled and the **Windows** button above the finger is highlighted.
5. Do one of the following depending on your operating system:
 - (Only if supported by your computer) A **Power-on** button is displayed above each finger. Click the **Power-on** button above the selected finger. The selected finger will be used instead of your power-on and/or hard disk drive passwords at system startup.
 - Click **Settings**. The Settings window opens. Do the following:
 - a. In the **Power-on Security** area, select **Use fingerprint scan instead of power-on and hard drive passwords**.
 - b. Click **OK**. There will be a highlighted **Power-on** button above the image of the finger you just enrolled, indicating that you have successfully enrolled your fingerprints for BIOS passwords.

Chapter 5. Caring for the fingerprint reader

The following actions could damage the fingerprint reader or cause it not to work properly:

- Scratching the surface of the reader with a hard, pointed object.
- Scraping the surface of the reader with your nail or anything hard.
- Using or touching the reader with a dirty finger.

Gently clean the surface of the reader with a dry, soft, lint-free cloth if you notice any of the following conditions:

- The surface of the reader is dirty or stained.
- The surface of the reader is wet.
- The reader often fails to enroll or authenticate your fingerprint.

You might not be able to register or authenticate it if your finger has any of the following conditions:

- Your finger is wrinkled.
- Your finger is rough, dry, or injured.
- Your finger is stained with dirt, mud, or oil.
- The surface of your finger is very different from what it was when you enrolled your fingerprint.
- Your finger is wet.
- A finger that has not been enrolled is used.

Try using the following methods if you have problems registering or authenticating a fingerprint:

- Clean or wipe your hands to remove any excess dirt or moisture from the fingers.
- Enroll and use a different finger for authentication.
- If your hands are too dry, apply lotion to them.

Chapter 6. Troubleshooting

The following are the most common keyboard problems. If you encounter any of the following problems with the keyboard, refer to the corresponding solution.

Problem: The fingerprint reader is not working correctly.

Solution: Refer to Chapter 5 “Caring for the fingerprint reader” on page 11.

Problem: The ThinkVantage button does not work correctly.

Solution: Ensure that one of the following programs is installed on your computer, or the Windows system information window will be displayed when you press the ThinkVantage button:

- ThinkVantage Productivity Center
- Lenovo Care
- Lenovo ThinkVantage Toolbox
- Lenovo Simpletap
- Lenovo Solution Center
- Lenovo Device Experience

Problem: I press a button once, but the computer responds as if I pressed it twice.

Solution: Depending on your operating system, adjust the keyboard repeat delay or repeat rate settings by doing one of the following:

- For the Windows XP or Windows Vista operating system:
 1. Depending on your **Start** menu mode, click **Start → Control Panel** or **Start → Settings → Control Panel**.
 2. Depending on your Control Panel mode, click or double-click **Keyboard**.
 3. Click the **Speed** tab.
 4. Move the Repeat delay slider to **Long** or the Repeat rate slider to **Slow**.
 5. Click **OK**.
- For the Windows 7 operating system:
 1. Depending on your **Start** menu mode, click **Start → Control Panel** or **Start → Settings → Control Panel**.
 2. Click the **View by** menu and select **Small icons** or **Large icons**. The **All Control Panel Items** category is expanded.
 3. Click **Keyboard**.
 4. Click the **Speed** tab.
 5. Move the Repeat delay slider to **Long** or the Repeat rate slider to **Slow**.
 6. Click **OK**.

- For Windows 8 operating system:
 1. To go to Control Panel, move the pointer to the top-right or bottom-right corner of the screen to display the charms. Click **Search** and then search for Control Panel.
 2. Click the **View by** menu and select the **Small icons** or **Large icons** view. The **All Control Panel Items** category is expanded.
 3. Click **Keyboard**.
 4. Click the **Speed** tab.
 5. Move the Repeat delay slider to **Long** or the Repeat rate slider to **Slow**.
 6. Click **OK**.

Problem: The keyboard and the fingerprint reader are not functioning correctly.

Solution: You might need to connect the keyboard to another available USB connector on your computer and try again.

To change the USB connector, do the following:

1. Unplug the keyboard connector from the USB connector.
2. Insert the keyboard connector into a different USB connector on the computer.
3. The operating system will identify the keyboard and the fingerprint reader with its plug-and-play feature.

Note: Contact your Lenovo service representative if the situation continues.

Problem: The ThinkPad built-in fingerprint reader does not work when a USB Fingerprint Reader is installed.

Solution: The fingerprint reader software only operates with one reader. When a USB Fingerprint Reader is installed, the software recognizes only the USB Fingerprint Reader and will not work with the internal one.

Appendix A. Service and Support

The following information describes the technical support that is available for your product, during the warranty period or throughout the life of your product. Refer to the Lenovo Limited Warranty for a full explanation of Lenovo warranty terms.

Online technical support

Online technical support is available during the lifetime of a product at:
<http://www.lenovo.com/support>

Product replacement assistance or exchange of defective components also is available during the warranty period. In addition, if your option is installed in a Lenovo computer, you might be entitled to service at your location. A Lenovo technical support representative can help you determine the best alternative.

Telephone technical support

Installation and configuration support through the Customer Support Center will be available until 90 days after the option has been withdrawn from marketing. After that time, the support is canceled, or made available for a fee, at Lenovo's discretion. Additional support is also available for a nominal fee.

Before contacting a Lenovo technical support representative, please have the following information available: option name and number, proof of purchase, computer manufacturer, model, serial number and manual, the exact wording of any error message, description of the problem, and the hardware and software configuration information for your system.

Your technical support representative might want to walk you through the problem while you are at your computer during the call.

Telephone numbers are subject to change without notice. The most up-to-date telephone list for Lenovo Support is always available at <http://www.lenovo.com/support/phone>. If the telephone number for your country or region is not listed, contact your Lenovo reseller or Lenovo marketing representative.

Accessibility information

Documentation in accessible formats

Lenovo provides electronic documentation in accessible formats, such as properly tagged PDF files or HyperText Markup Language (HTML) files. Lenovo electronic documentation is developed to ensure that visually impaired users can read the documentation through a screen reader. Each image in the documentation also includes adequate alternative text to explain the image so that visually impaired users can understand the image when they use a screen reader.

To open and view PDF files, your computer must have the Adobe Reader program installed. The Adobe Reader program also is available for download at:
<http://www.adobe.com>

Appendix B. Lenovo Limited Warranty

L505-0010-02 08/2011

This Lenovo Limited Warranty consists of the following parts:

Part 1 - General Terms

Part 2 - Country-specific Terms

Part 3 - Warranty Service Information

The terms of **Part 2** replace or modify terms of **Part 1** as specified for a particular country.

Part 1 - General Terms

This Lenovo Limited Warranty applies only to Lenovo hardware products you purchased for your own use and not for resale. This Lenovo Limited Warranty is available in other languages at www.lenovo.com/warranty.

What this Warranty Covers

Lenovo warrants that each Lenovo hardware product that you purchase is free from defects in materials and workmanship under normal use during the warranty period. The warranty period for the product starts on the original date of purchase as shown on your sales receipt or invoice or as may be otherwise specified by Lenovo. The warranty period and type of warranty service that apply to your product are as specified in “**Part 3 - Warranty Service Information**” below. This warranty only applies to products in the country or region of purchase.

THIS WARRANTY IS YOUR EXCLUSIVE WARRANTY AND REPLACES ALL OTHER WARRANTIES OR CONDITIONS, EXPRESS OR IMPLIED, INCLUDING, BUT NOT LIMITED TO, ANY IMPLIED WARRANTIES OR CONDITIONS OF MERCHANTABILITY OR FITNESS FOR A PARTICULAR PURPOSE. AS SOME STATES OR JURISDICTIONS DO NOT ALLOW THE EXCLUSION OF EXPRESS OR IMPLIED WARRANTIES, THE ABOVE EXCLUSION MAY NOT APPLY TO YOU. IN THAT EVENT, SUCH WARRANTIES APPLY ONLY TO THE EXTENT AND FOR SUCH DURATION AS REQUIRED BY LAW AND ARE LIMITED IN DURATION TO THE WARRANTY PERIOD. AS SOME STATES OR JURISDICTIONS DO NOT ALLOW LIMITATIONS ON THE DURATION OF AN IMPLIED WARRANTY, THE ABOVE LIMITATION ON DURATION MAY NOT APPLY TO YOU.

How to Obtain Warranty Service

If the product does not function as warranted during the warranty period, you may obtain warranty service by contacting Lenovo or a Lenovo approved Service Provider. A list of approved Service Providers and their telephone numbers is available at: www.lenovo.com/support/phone.

Warranty service may not be available in all locations and may differ from location to location. Charges may apply outside a Service Provider’s normal service area. Contact a local Service Provider for information specific to your location.

Customer Responsibilities for Warranty Service

Before warranty service is provided, you must take the following steps:

- follow the service request procedures specified by the Service Provider;

- backup or secure all programs and data contained in the product;
- provide the Service Provider with all system keys or passwords;
- provide the Service Provider with sufficient, free, and safe access to your facilities to perform service;
- remove all data, including confidential information, proprietary information and personal information, from the product or, if you are unable to remove any such information, modify the information to prevent its access by another party or so that it is not personal data under applicable law. The Service Provider shall not be responsible for the loss or disclosure of any data, including confidential information, proprietary information, or personal information, on a product returned or accessed for warranty service;
- remove all features, parts, options, alterations, and attachments not covered by the warranty;
- ensure that the product or part is free of any legal restrictions that prevent its replacement;
- if you are not the owner of a product or part, obtain authorization from the owner for the Service Provider to provide warranty service.

What Your Service Provider Will Do to Correct Problems

When you contact a Service Provider, you must follow the specified problem determination and resolution procedures.

The Service Provider will attempt to diagnose and resolve your problem by telephone, e-mail or remote assistance. The Service Provider may direct you to download and install designated software updates.

Some problems may be resolved with a replacement part that you install yourself called a “Customer Replaceable Unit” or “CRU.” If so, the Service Provider will ship the CRU to you for you to install.

If your problem cannot be resolved over the telephone; through the application of software updates or the installation of a CRU, the Service Provider will arrange for service under the type of warranty service designated for the product under “**Part 3 - Warranty Service Information**” below.

If the Service Provider determines that it is unable to repair your product, the Service Provider will replace it with one that is at least functionally equivalent.

If the Service Provider determines that it is unable to either repair or replace your product, your sole remedy under this Limited Warranty is to return the product to your place of purchase or to Lenovo for a refund of your purchase price.

Replacement Products and Parts

When warranty service involves the replacement of a product or part, the replaced product or part becomes Lenovo’s property and the replacement product or part becomes your property. Only unaltered Lenovo products and parts are eligible for replacement. The replacement product or part provided by Lenovo may not be new, but it will be in good working order and at least functionally equivalent to the original product or part. The replacement product or part shall be warranted for the balance of the period remaining on the original product.

Use of Personal Contact Information

If you obtain service under this warranty, you authorize Lenovo to store, use and process information about your warranty service and your contact information, including name, phone numbers, address, and e-mail address. Lenovo may use this information to perform service under this warranty. We may contact you to inquire about your satisfaction with our warranty service or to notify you about any product recalls or safety issues. In accomplishing these purposes, you authorize Lenovo to transfer your information to any country where we do business and to provide it to entities acting on our behalf. We may also disclose it where required by law. Lenovo’s privacy policy is available at www.lenovo.com/.

What this Warranty Does not Cover

This warranty does not cover the following:

- uninterrupted or error-free operation of a product;
- loss of, or damage to, your data by a product;
- any software programs, whether provided with the product or installed subsequently;
- failure or damage resulting from misuse, abuse, accident, modification, unsuitable physical or operating environment, natural disasters, power surges, improper maintenance, or use not in accordance with product information materials;
- damage caused by a non-authorized service provider;
- failure of, or damage caused by, any third party products, including those that Lenovo may provide or integrate into the Lenovo product at your request;
- any technical or other support, such as assistance with “how-to” questions and those regarding product set-up and installation;
- products or parts with an altered identification label or from which the identification label has been removed.

Limitation of Liability

Lenovo is responsible for loss or damage to your product only while it is in the Service Provider’s possession or in transit, if the Service Provider is responsible for the transportation.

Neither Lenovo nor the Service Provider is responsible for loss or disclosure of any data, including confidential information, proprietary information, or personal information, contained in a product.

UNDER NO CIRCUMSTANCES, AND NOTWITHSTANDING THE FAILURE OF ESSENTIAL PURPOSE OF ANY REMEDY SET FORTH HEREIN, SHALL LENOVO, ITS AFFILIATES, SUPPLIERS, RESELLERS, OR SERVICE PROVIDERS BE LIABLE FOR ANY OF THE FOLLOWING EVEN IF INFORMED OF THEIR POSSIBILITY AND REGARDLESS OF WHETHER THE CLAIM IS BASED IN CONTRACT, WARRANTY, NEGLIGENCE, STRICT LIABILITY OR OTHER THEORY OF LIABILITY: 1) THIRD PARTY CLAIMS AGAINST YOU FOR DAMAGES; 2) LOSS, DAMAGE OR DISCLOSURE OF YOUR DATA; 3) SPECIAL, INCIDENTAL, PUNITIVE, INDIRECT OR CONSEQUENTIAL DAMAGES, INCLUDING BUT NOT LIMITED TO LOST PROFITS, BUSINESS REVENUE, GOODWILL OR ANTICIPATED SAVINGS. IN NO CASE SHALL THE TOTAL LIABILITY OF LENOVO, ITS AFFILIATES, SUPPLIERS, RESELLERS OR SERVICE PROVIDERS FOR DAMAGES FROM ANY CAUSE EXCEED THE AMOUNT OF ACTUAL DIRECT DAMAGES, NOT TO EXCEED THE AMOUNT PAID FOR THE PRODUCT.

THE FOREGOING LIMITATIONS DO NOT APPLY TO DAMAGES FOR BODILY INJURY (INCLUDING DEATH), DAMAGE TO REAL PROPERTY OR DAMAGE TO TANGIBLE PERSONAL PROPERTY FOR WHICH LENOVO IS LIABLE UNDER LAW. AS SOME STATES OR JURISDICTIONS DO NOT ALLOW THE EXCLUSION OR LIMITATION OF INCIDENTAL OR CONSEQUENTIAL DAMAGES, THE ABOVE LIMITATION OR EXCLUSION MAY NOT APPLY TO YOU.

Your Other Rights

THIS WARRANTY GIVES YOU SPECIFIC LEGAL RIGHTS. YOU MAY HAVE OTHER RIGHTS ACCORDING TO THE APPLICABLE LAWS OF YOUR STATE OR JURISDICTION. YOU MAY ALSO HAVE OTHER RIGHTS UNDER A WRITTEN AGREEMENT WITH LENOVO. NOTHING IN THIS WARRANTY AFFECTS STATUTORY RIGHTS, INCLUDING RIGHTS OF CONSUMERS UNDER LAWS OR REGULATIONS GOVERNING THE SALE OF CONSUMER GOODS THAT CANNOT BE WAIVED OR LIMITED BY CONTRACT.

Part 2 - Country-specific Terms

Australia

“Lenovo” means Lenovo (Australia & New Zealand) Pty Limited ABN 70 112 394 411. Address: Level 10, North Tower, 1-5 Railway Street, Chatswood, NSW, 2067. Telephone: +61 2 8003 8200. Email: lensyd_au@lenovo.com

The following replaces the same section in Part 1:

What this Warranty Covers:

Lenovo warrants that each hardware product that you purchase is free from defects in materials and workmanship under normal use and conditions during the warranty period. If the product fails due to a covered defect during the warranty period, Lenovo will provide you a remedy under this Limited Warranty. The warranty period for the product starts on the original date of purchase specified on your sales receipt or invoice unless Lenovo informs you otherwise in writing. The warranty period and type of warranty service that apply to your product are set forth below in **Part 3 - Warranty Service Information**.

THE BENEFITS GIVEN BY THIS WARRANTY ARE IN ADDITION TO YOUR RIGHTS AND REMEDIES AT LAW, INCLUDING THOSE UNDER THE AUSTRALIAN CONSUMER LAW.

The following replaces the same section in Part 1:

Replacement Products and Parts:

When warranty service involves the replacement of a product or part, the replaced product or part becomes Lenovo’s property and the replacement product or part becomes your property. Only unaltered Lenovo products and parts are eligible for replacement. The replacement product or part provided by Lenovo may not be new, but it will be in good working order and at least functionally equivalent to the original product or part. The replacement product or part shall be warranted for the balance of the period remaining on the original product. Products and parts presented for repair may be replaced by refurbished products or parts of the same type rather than being repaired. Refurbished parts may be used to repair the product; and repair of the product may result in loss of data, if the product is capable of retaining user-generated data.

The following is added to the same section in Part 1:

Use of Personal Contact Information:

Lenovo will not be able to perform our service under this warranty if you refuse to provide your information or do not wish us to transfer your information to our agent or contractor. You have the right to access your personal contact information and request correction of any errors in it pursuant to the Privacy Act 1988 by contacting Lenovo.

The following replaces the same section in Part 1:

Limitation of Liability:

Lenovo is responsible for loss or damage to your product only while it is in the Service Provider’s possession or in transit, if the Service Provider is responsible for the transportation.

Neither Lenovo nor the Service Provider is responsible for loss or disclosure of any data, including confidential information, proprietary information, or personal information, contained in a product.

TO THE EXTENT PERMITTED BY LAW, UNDER NO CIRCUMSTANCES AND NOTWITHSTANDING THE FAILURE OF ESSENTIAL PURPOSE OF ANY REMEDY SET FORTH HEREIN, SHALL LENOVO, ITS AFFILIATES, SUPPLIERS, RESELLERS, OR SERVICE PROVIDERS BE LIABLE FOR ANY OF THE FOLLOWING EVEN IF INFORMED OF THEIR POSSIBILITY AND REGARDLESS OF WHETHER THE CLAIM IS BASED IN CONTRACT, WARRANTY, NEGLIGENCE, STRICT LIABILITY OR OTHER THEORY OF LIABILITY: 1) THIRD PARTY CLAIMS AGAINST YOU FOR DAMAGES; 2) LOSS, DAMAGE OR DISCLOSURE OF YOUR DATA; 3) SPECIAL, INCIDENTAL, PUNITIVE, INDIRECT OR CONSEQUENTIAL DAMAGES, INCLUDING BUT NOT LIMITED TO LOST PROFITS, BUSINESS REVENUE, GOODWILL OR ANTICIPATED SAVINGS. IN NO CASE SHALL THE TOTAL LIABILITY OF LENOVO, ITS AFFILIATES, SUPPLIERS, RESELLERS OR SERVICE PROVIDERS FOR DAMAGES FROM ANY CAUSE EXCEED THE AMOUNT OF ACTUAL DIRECT DAMAGES, NOT TO EXCEED THE AMOUNT PAID FOR THE PRODUCT.

THE FOREGOING LIMITATIONS DO NOT APPLY TO DAMAGES FOR BODILY INJURY (INCLUDING DEATH), DAMAGE TO REAL PROPERTY OR DAMAGE TO TANGIBLE PERSONAL PROPERTY FOR WHICH LENOVO IS LIABLE UNDER LAW.

The following replaces the same section in Part 1:

Your Other Rights:

THIS WARRANTY GIVES YOU SPECIFIC LEGAL RIGHTS. YOU ALSO HAVE OTHER RIGHTS AT LAW, INCLUDING UNDER THE AUSTRALIAN CONSUMER LAW. NOTHING IN THIS WARRANTY AFFECTS STATUTORY RIGHTS OR RIGHTS AT LAW, INCLUDING RIGHTS THAT CANNOT BE WAIVED OR LIMITED BY CONTRACT.

For example, our products come with guarantees that cannot be excluded under the Australian Consumer Law. You are entitled to a replacement or refund for a major failure and compensation for any other reasonably foreseeable loss or damage. You are also entitled to have the products repaired or replaced if the products fail to be of acceptable quality and the failure does not amount to a major failure.

New Zealand

The following is added to the same section in Part 1:

Use of Personal Information:

Lenovo will not be able to perform our service under this warranty if you refuse to provide your information or do not wish us to transfer your information to our agent or contractor. You have the right to access your personal information and request correction of any errors in it pursuant to the Privacy Act 1993 by contacting Lenovo (Australia & New Zealand) Pty Limited ABN 70 112 394 411. Address: Level 10, North Tower, 1-5 Railway Street, Chatswood, NSW, 2067. Telephone: 61 2 8003 8200. Email: lensyd_au@lenovo.com

Bangladesh, Cambodia, India, Indonesia, Nepal, Philippines, Vietnam and Sri Lanka

The following is added to Part 1:

Dispute Resolution

Disputes arising out of or in connection with this warranty shall be finally settled by arbitration held in Singapore. This warranty shall be governed, construed and enforced in accordance with the laws of Singapore, without regard to conflict of laws. If you acquired the product in **India**, disputes arising out of or in connection with this warranty shall be finally settled by arbitration held in Bangalore, India. Arbitration in Singapore shall be held in accordance with the Arbitration Rules of Singapore International Arbitration Center ("SIAC Rules") then in effect. Arbitration in India shall be held in accordance with the laws of India then in effect. The arbitration award shall be final and binding on the parties without appeal. Any award

shall be in writing and set forth the findings of fact and the conclusions of law. All arbitration proceedings, including all documents presented in such proceedings shall be conducted in the English language. The English language version of this warranty prevails over any other language version in such proceedings.

European Economic Area (EEA)

The following is added to Part 1:

Customers in the EEA may contact Lenovo at the following address: EMEA Service Organisation, Lenovo (International) B.V., Floor 2, Einsteinova 21, 851 01, Bratislava, Slovakia. Service under this warranty for Lenovo hardware products purchased in EEA countries may be obtained in any EEA country in which the product has been announced and made available by Lenovo.

Russia

The following is added to Part 1:

Product Service Life

The product service life is four (4) years from the original date of purchase.

Part 3 - Warranty Service Information

Product Type	Country or Region of Purchase	Warranty Period	Type of Warranty Service
Lenovo Preferred Pro USB Fingerprint Keyboard	Worldwide	1 year	1, 4

If required, your Service Provider will provide repair or exchange service depending on the type of warranty service specified for your product and the available service. Scheduling of service will depend upon the time of your call, parts availability, and other factors.

Types of Warranty Service

1. Customer Replaceable Unit (“CRU”) Service

Under CRU Service, the Service Provider will ship CRUs to you at its cost for installation by you. CRU information and replacement instructions are shipped with your product and are available from Lenovo at any time upon request. CRUs that are easily installed by you are called “Self-service CRUs”. “Optional-service CRUs” are CRUs that may require some technical skill and tools. Installation of Self-service CRUs is your responsibility. You may request that a Service Provider install Optional-service CRUs under one of the other types of warranty service designated for your product. An optional service offering may be available for purchase from a Service Provider or Lenovo under which Self-service CRUs would be installed for you. You may find a list of CRUs and their designation in the publication that was shipped with your product or at www.lenovo.com/CRUs. The requirement to return a defective CRU, if any, will be specified in the instructions shipped with a replacement CRU. When return is required: 1) return instructions, a prepaid return shipping label, and a container will be included with the replacement CRU; and 2) you may be charged for the replacement CRU if the Service Provider does not receive the defective CRU from you within thirty (30) days of your receipt of the replacement CRU.

2. On-site Service

Under On-Site Service, a Service Provider will either repair or exchange the product at your location. You must provide a suitable working area to allow disassembly and reassembly of the product. Some repairs

may need to be completed at a service center. If so, the Service Provider will send the product to the service center at its expense.

3. Courier or Depot Service

Under Courier or Depot Service, your product will be repaired or exchanged at a designated service center, with shipping at the expense of the Service Provider. You are responsible for disconnecting the product and packing it in a shipping container provided to you to return your product to a designated service center. A courier will pick up your product and deliver it to the designated service center. The service center will return the product to you at its expense.

4. Customer Carry-In Service

Under Customer Carry-In Service, your product will be repaired or exchanged after you deliver it to a designated service center at your risk and expense. After the product has been repaired or exchanged, it will be made available to you for collection. If you fail to collect the product, the Service Provider may dispose of the product as it sees fit, with no liability to you.

5. Mail-In Service

Under Mail-In Service, your product will be repaired or exchanged at a designated service center after you deliver it at your risk and expense. After the product has been repaired or exchanged, it will be returned to you at Lenovo's risk and expense, unless the Service Provider specifies otherwise.

6. Customer Two-Way Mail-In Service

Under Customer Two-Way Mail-In Service, your product will be repaired or exchanged after you deliver it to a designated service center at your risk and expense. After the product has been repaired or exchanged, it will be made available to you for return shipping at your risk and expense. If you fail to arrange return shipment, the Service Provider may dispose of the product as it sees fit, with no liability to you.

7. Product Exchange Service

Under Product Exchange Service, Lenovo will ship a replacement product to your location. You are responsible for its installation and verification of its operation. The replacement product becomes your property in exchange for the failed product, which becomes the property of Lenovo. You must pack the failed product in the shipping carton in which you received the replacement product and return it to Lenovo. Transportation charges, both ways, shall be at Lenovo's expense. If you fail to use the carton in which the replacement product was received, you may be responsible for any damage to the failed product occurring during shipment. You may be charged for the replacement product if Lenovo does not receive the failed product within thirty (30) days of your receipt of the replacement product.

Suplemento de Garantía para México

Este Suplemento de Garantía se considera parte integrante de la Garantía Limitada de Lenovo y será efectivo única y exclusivamente para los productos distribuidos y comercializados dentro del Territorio de los Estados Unidos Mexicanos. En caso de conflicto, se aplicarán los términos de este Suplemento.

El comercializador responsable del producto es Lenovo México S de R L de CV y para efectos de esta garantía en la República Mexicana su domicilio es Paseo de Tamarindos No.400-A Piso 27 Arcos Torre Poniente, Bosques de Las Lomas, Delegación Miguel Hidalgo, C.P. 05120 México, D.F. En el caso de que se precise una reparación cubierta por la garantía o precise de partes, componentes, consumibles o accesorios diríjase a este domicilio.

Si no existiese ningún Centro de servicio autorizado en su ciudad, población o en un radio de 70 kilómetros de su ciudad o población, la garantía incluirá cualquier gasto de entrega razonable relacionado con el transporte del producto a su Centro de servicio autorizado más cercano. Por favor, llame al Centro de servicio autorizado más cercano para obtener las aprobaciones necesarias o la información relacionada con el envío del producto y la dirección de envío.

Esta garantía ampara todas las piezas de hardware del producto e incluye mano de obra.

El procedimiento para hacer efectiva la garantía consiste en la presentación del producto, acompañado de la póliza correspondiente, debidamente sellada por el establecimiento que lo vendió, o la factura, o recibo o comprobante, en el que consten los datos específicos del producto objeto de la compraventa.

Lenovo sólo pueden eximirse de hacer efectiva la garantía en los siguientes casos: a) Cuando el producto se hubiese utilizado en condiciones distintas a las normales. b) Cuando el producto no hubiese sido operado de acuerdo con el instructivo de uso que se le acompaña. c) Cuando el producto hubiese sido alterado o reparado por personas no autorizadas por el fabricante nacional, importador o comercializador responsable respectivo.

Todos los programas de software precargados en el equipo sólo tendrán una garantía de noventa (90) días por defectos de instalación desde la fecha de compra. Lenovo no es responsable de la información incluida en dichos programas de software y /o cualquier programa de software adicional instalado por Usted o instalado después de la compra del producto.

La garantía cubre la atención, revisión y corrección de errores, defectos o inconsistencias que impidan el desempeño normal de un equipo de cómputo en cuanto a su hardware y software. Los servicios no cubiertos por la garantía se cargarán al usuario final, previa obtención de una autorización.

Esta garantía tiene una duración de un año a partir del momento de la compra e incluye la mano de obra, por lo que en caso de aplicarse la garantía, esta no causara ningún gasto o costo para el cliente.

Centros de Servicios autorizados para hacer efectiva la garantía:

- Lenovo México con domicilio en Paseo de Tamarindos No.400-A Piso 27 Arcos, Torre Poniente, Bosques de Las Lomas, Delegación Miguel Hidalgo, C.P. 05120 México, D.F. Teléfono 01800- 083-4916, http://support.lenovo.com/es_MX/product-service/service-provider/default.page
- Lenovo Monterrey con domicilio en Boulevard Escobedo No.316, Apodaca Technology Park, Apodaca, C.P. 66601, Nuevo León, México. Teléfono 01800- 083-4916, http://support.lenovo.com/es_MX/product-service/service-provider/default.page

Importado por:

Lenovo México S. de R.L. de C.V.

Av. Santa Fe 505, Piso 15

Col. Cruz Manca

Cuajimalpa, D.F., México

C.P. 05349

Tel. (55) 5000 8500

Appendix C. Compliance information

The latest compliance information is available at:
<http://www.lenovo.com/compliance>

Electronic emission notices

The following information refers to the Lenovo Preferred Pro USB Fingerprint Keyboard.

Federal Communications Commission Declaration of Conformity

Lenovo Preferred Pro USB Fingerprint Keyboard - 73P4730

This equipment has been tested and found to comply with the limits for a Class B digital device, pursuant to Part 15 of the FCC Rules. These limits are designed to provide reasonable protection against harmful interference in a residential installation. This equipment generates, uses, and can radiate radio frequency energy and, if not installed and used in accordance with the instructions, may cause harmful interference to radio communications. However, there is no guarantee that interference will not occur in a particular installation. If this equipment does cause harmful interference to radio or television reception, which can be determined by turning the equipment off and on, the user is encouraged to try to correct the interference by one or more of the following measures:

- Reorient or relocate the receiving antenna.
- Increase the separation between the equipment and receiver.
- Connect the equipment into an outlet on a circuit different from that to which the receiver is connected.
- Consult an authorized dealer or service representative for help.

Lenovo is not responsible for any radio or television interference caused by using other than specified or recommended cables and connectors or by unauthorized changes or modifications to this equipment. Unauthorized changes or modifications could void the user's authority to operate the equipment.

This device complies with Part 15 of the FCC Rules. Operation is subject to the following two conditions: (1) this device may not cause harmful interference, and (2) this device must accept any interference received, including interference that may cause undesired operation.

Responsible Party:
Lenovo (United States) Incorporated
1009 Think Place - Building One
Morrisville, NC 27560
Phone Number: 919-294-5900



European Union - Compliance to the Electromagnetic Compatibility Directive

This product is in conformity with the protection requirements of EU Council Directive 2004/108/EC (until 19 April, 2016) and Council Directive 2014/30/EU (from 20 April, 2016) on the approximation of the laws of the Member States relating to electromagnetic compatibility.

Lenovo cannot accept responsibility for any failure to satisfy the protection requirements resulting from a non-recommended modification of the product, including the installation of option cards from other manufacturers. This product has been tested and found to comply with the limits for Class B equipment

according to European Standards harmonized in the Directives in compliance. The limits for Class B equipment were derived for typical residential environments to provide reasonable protection against interference with licensed communication devices.

Lenovo, Einsteinova 21, 851 01 Bratislava, Slovakia



German Class B compliance statement

Deutschsprachiger EU Hinweis:

Hinweis für Geräte der Klasse B EU Richtlinie zur Elektromagnetischen Verträglichkeit

Dieses Produkt entspricht den Schutzanforderungen der EU Richtlinie 2014/30/EU (früher 2004/108/EC) zur Angleichung der Rechtsvorschriften über die elektromagnetische Verträglichkeit in den EU-Mitgliedsstaaten und hält die Grenzwerte der Klasse B der Norm gemäß Richtlinie.

Um dieses sicherzustellen, sind die Geräte wie in den Handbüchern beschrieben zu installieren und zu betreiben. Des Weiteren dürfen auch nur von der Lenovo empfohlene Kabel angeschlossen werden. Lenovo übernimmt keine Verantwortung für die Einhaltung der Schutzanforderungen, wenn das Produkt ohne Zustimmung der Lenovo verändert bzw. wenn Erweiterungskomponenten von Fremdherstellern ohne Empfehlung der Lenovo gesteckt/eingebaut werden.

Deutschland:

Einhaltung des Gesetzes über die elektromagnetische Verträglichkeit von Betriebsmitteln

Dieses Produkt entspricht dem „Gesetz über die elektromagnetische Verträglichkeit von Betriebsmitteln“ EMVG (früher „Gesetz über die elektromagnetische Verträglichkeit von Geräten“). Dies ist die Umsetzung der EMV EU Richtlinie 2014/30/EU (früher 2004/108/EC) in der Bundesrepublik Deutschland.

Zulassungsbescheinigung laut dem Deutschen Gesetz über die elektromagnetische Verträglichkeit von Betriebsmitteln, EMVG vom 20. Juli 2007 (früher Gesetz über die elektromagnetische Verträglichkeit von Geräten), bzw. der EMV EU Richtlinie 2014/30/EU (früher 2004/108/EC), für Geräte der Klasse B.

Dieses Gerät ist berechtigt, in Übereinstimmung mit dem Deutschen EMVG das EG-Konformitätszeichen - CE - zu führen. Verantwortlich für die Konformitätserklärung nach Paragraf 5 des EMVG ist die Lenovo (Deutschland) GmbH, Meitnerstr. 9, D-70563 Stuttgart.

Informationen in Hinsicht EMVG Paragraf 4 Abs. (1) 4:

Das Gerät erfüllt die Schutzanforderungen nach EN 55024 und EN 55022 Klasse B.

Korea Class B compliance statement

B급 기기 (가정용 방송통신기자재)
이 기기는 가정용(B급) 전자파적합기기로서 주로 가정에서 사용하는 것을 목적으로 하며, 모든 지역에서 사용할 수 있습니다.

Japan VCCI Class B compliance statement

この装置は、クラスB情報技術装置です。この装置は、家庭環境で使用することを目的としていますが、この装置がラジオやテレビジョン受信機に近接して使用されると、受信障害を引き起こすことがあります。

取扱説明書に従って正しい取り扱いをして下さい。

VCCI-B

Lenovo product service information for Taiwan

委製商/進口商名稱: 荷蘭商聯想股份有限公司台灣分公司
進口商地址: 台北市內湖區堤頂大道2段89號5樓
進口商電話: 0800-000-702 (代表號)

Appendix D. Notices

Lenovo may not offer the products, services, or features discussed in this document in all countries. Consult your local Lenovo representative for information on the products and services currently available in your area. Any reference to a Lenovo product, program, or service is not intended to state or imply that only that Lenovo product, program, or service may be used. Any functionally equivalent product, program, or service that does not infringe any Lenovo intellectual property right may be used instead. However, it is the user's responsibility to evaluate and verify the operation of any other product, program, or service.

Lenovo may have patents or pending patent applications covering subject matter described in this document. The furnishing of this document does not give you any license to these patents. You can send license inquiries, in writing, to:

*Lenovo (United States), Inc.
1009 Think Place - Building One
Morrisville, NC 27560
U.S.A.
Attention: Lenovo Director of Licensing*

LENOVO PROVIDES THIS PUBLICATION "AS IS" WITHOUT WARRANTY OF ANY KIND, EITHER EXPRESS OR IMPLIED, INCLUDING, BUT NOT LIMITED TO, THE IMPLIED WARRANTIES OF NON-INFRINGEMENT, MERCHANTABILITY OR FITNESS FOR A PARTICULAR PURPOSE. Some jurisdictions do not allow disclaimer of express or implied warranties in certain transactions, therefore, this statement may not apply to you.

This information could include technical inaccuracies or typographical errors. Changes are periodically made to the information herein; these changes will be incorporated in new editions of the publication. Lenovo may make improvements and/or changes in the product(s) and/or the program(s) described in this publication at any time without notice.

Recycling and environmental information

Lenovo encourages owners of information technology (IT) equipment to responsibly recycle their equipment when it is no longer needed. Lenovo offers a variety of programs and services to assist equipment owners in recycling their IT products. For information on recycling Lenovo products, go to:
<http://www.lenovo.com/recycling>

Recycling and disposal information for Japan is available at:
<http://www.lenovo.com/recycling/japan>

The latest environmental information about our products is available at:
<http://www.lenovo.com/ecodeclaration>

Recycling information for Brazil

Declarações de Reciclagem no Brasil

Descarte de um Produto Lenovo Fora de Uso

Equipamentos elétricos e eletrônicos não devem ser descartados em lixo comum, mas enviados à pontos de coleta, autorizados pelo fabricante do produto para que sejam encaminhados e processados por empresas

especializadas no manuseio de resíduos industriais, devidamente certificadas pelos órgãos ambientais, de acordo com a legislação local.

A Lenovo possui um canal específico para auxiliá-lo no descarte desses produtos. Caso você possua um produto Lenovo em situação de descarte, ligue para o nosso SAC ou encaminhe um e-mail para: reciclar@lenovo.com, informando o modelo, número de série e cidade, a fim de enviarmos as instruções para o correto descarte do seu produto Lenovo.

Important WEEE information

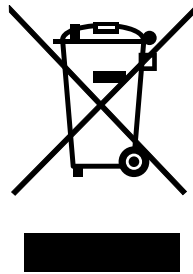

The WEEE marking on Lenovo products applies to countries with WEEE and e-waste regulations (for example, the European WEEE Directive, India E-Waste Management & Handling Rules). Appliances are labeled in accordance with local regulations concerning waste electrical and electronic equipment (WEEE). These regulations determine the framework for the return and recycling of used appliances as applicable within each geography. This label is applied to various products to indicate that the product is not to be thrown away, but rather put in the established collection systems for reclaiming these end of life products.

Users of electrical and electronic equipment (EEE) with the WEEE marking must not dispose of end of life EEE as unsorted municipal waste, but use the collection framework available to them for the return, recycle, and recovery of WEEE and to minimize any potential effects of EEE on the environment and human health due to the presence of hazardous substances. Lenovo electrical and electronic equipment (EEE) may contain parts and components, which at end-of-life might qualify as hazardous waste.

EEE and waste electrical and electronic equipment (WEEE) can be delivered free of charge to the place of sale or any distributor that sells electrical and electronic equipment of the same nature and function as the used EEE or WEEE.

For additional WEEE information go to: <http://www.lenovo.com/recycling>

WEEE information for Hungary

Lenovo, as a producer, bears the cost incurred in connection with the fulfillment of Lenovo's obligations under Hungary Law No. 197/2014 (VIII.1.) subsections (1)-(5) of section 12.

Export Classification Notice

This product is subject to the United States Export Administration regulations (EAR) and has an Export Classification Control Number (ECCN) of 5A992.c. It can be re-exported except to any of the embargoed countries in the EAR E1 country list.

Trademarks

The following terms are trademarks of Lenovo in the United States, other countries, or both:

Lenovo

The Lenovo logo
Lenovo Care
ThinkPad
ThinkVantage

Microsoft, Windows, and Windows Vista are trademarks of the Microsoft group of companies.

Other company, product, or service names may be trademarks or service marks of others.

Appendix E. Restriction of Hazardous Substances (RoHS) Directive

European Union RoHS

This Lenovo product, with included parts (cables, cords, and so on) meets the requirements of Directive 2011/65/EU on the restriction of the use of certain hazardous substances in electrical and electronic equipment (“RoHS recast” or “RoHS 2”).

For more information about Lenovo worldwide compliance on RoHS, go to:
http://www.lenovo.com/social_responsibility/us/en/RoHS_Communication.pdf

China RoHS

为满足中国电子电气产品有害物质限制相关的法律法规和其他要求，联想公司对本产品中有害物质，按部件分类，声明如下。

部件名称	有害物质					
	铅 (Pb)	汞 (Hg)	镉 (Cd)	六价铬 (Cr (VI))	多溴联苯 (PBB)	多溴二苯醚 (PBDE)
印刷电路板组件*	X	O	O	O	O	O
外壳及附件	X	O	O	O	O	O

本表格依据SJ/T 11364的规定编制。
O：表示该有害物质在该部件所有均质材料中的含量均在GB/T 26572规定的限量要求以下。
X：表示该有害物质至少在该部件的某一均质材料中的含量超出GB/T 26572规定的限量要求。
表中标记“X”的部件，皆因全球技术发展水平限制而无法实现有害物质的替代。

印刷电路板组件*：包括印刷电路板及其零部件，电子元器件等
根据产品型号不同，您所购买的产品可能不会含有以上所有部件

 在中华人民共和国境内销售的电子电气产品上将印有“环保使用期”(EPuP)符号。
圆圈中的数字代表产品的正常环保使用年限。

Turkish RoHS

The Lenovo product meets the requirements of the Republic of Turkey Directive on the Restriction of the Use of Certain Hazardous Substances in Electrical and Electronic Equipment (EEE).

Türkiye AEEE Yönetmeliğine Uygunluk Beyanı

Bu Lenovo ürünü, T.C. Çevre ve Orman Bakanlığı'nın “Atık Elektrik ve Elektronik Eşyalarda Bazı Zararlı Maddelerin Kullanımının Sınırlandırılmasına Dair Yönetmelik (AEEE)” direktiflerine uygundur.

AEEE Yönetmeliğine Uygundur.

Ukraine RoHS

Цим підтверджуємо, що продукція Леново відповідає вимогам нормативних актів України, які обмежують вміст небезпечних речовин

India RoHS

RoHS compliant as per E-Waste (Management & Handling) Rules.



Part Number: 57Y3998

Printed in China

(1P) P/N: 57Y3998

