



## *airFiber*<sup>®</sup> X Antenna

5 GHz, Slant 45 Antenna for airFiber<sup>®</sup>

Model: AF-5G23-S45, AF-5G30-S45, AF-5G34-S45

Powerful Performance for Long-Range Links

---

Robust Design and Construction for Outdoor Use

---

Seamless Integration with airFiber Radio

# Overview

Pair an airFiber® X antenna with an airFiber X radio to create the endpoint of a high-performance, Point-to-Point (PtP) bridge or network backhaul (airFiber X radio sold separately).

The airFiber X antenna uses the 5 GHz frequency band and is available as the following models:

- AF-5G23-S45 (gain: 23 dBi)
- AF-5G30-S45 (gain: 30 dBi)
- AF-5G34-S45 (gain: 34 dBi)

Each model is compatible with the airFiber AF-5X, a 5 GHz Carrier Backhaul Radio.

## Powerful Performance

The airFiber X antenna delivers 2x2, dual-polarity performance. On the right is one example of how the airFiber X antenna with an airFiber X radio can be deployed in a backhaul link to deliver bandwidth from an ISP network out to a neighborhood tower. From there, an airMAX® Sector antenna with a Rocket™ radio delivers bandwidth to the ISP's customers.

## Carrier-Class Construction

Incorporating a dish reflector design for excellent beam directivity, the airFiber X antennas feature robust mechanical design using industrial-strength hardware for outdoor application use.

## Plug and Play Integration

airFiber X antennas and airFiber X radios have been designed to seamlessly work together. Every airFiber X antenna has a built-in airFiber X radio mount, so installation requires no special tools.

Snap the airFiber X radio securely into place and mount the antenna; you then have the optimal combination of airFiber X antenna and airFiber X radio for your PtP application.

## Application Example

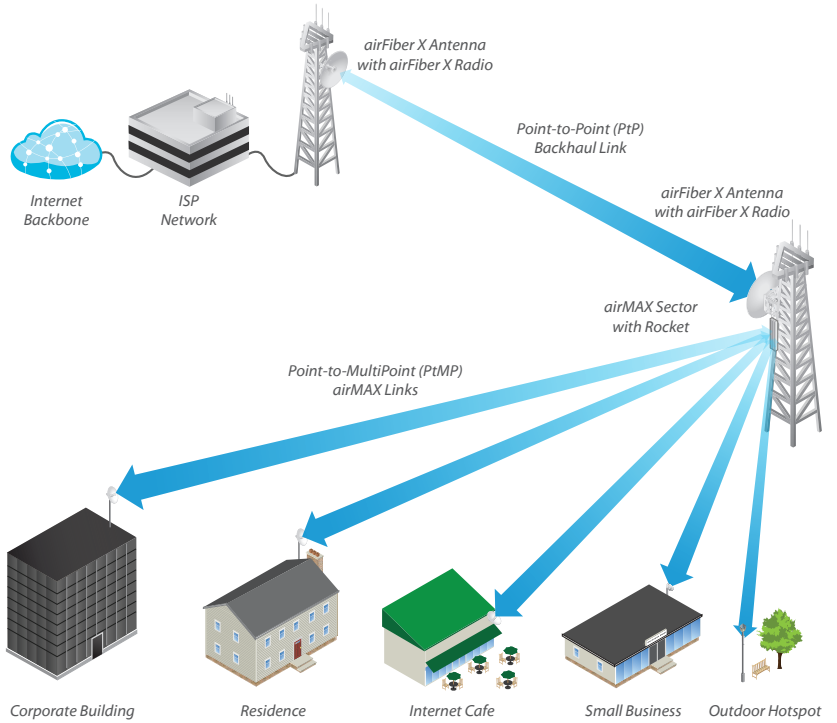

Mounting an airFiber X radio on the AF-5G30-S45

# Hardware Overview

## Innovative Mechanical Design

- **Secure Pole-Mounting** The hardware is designed to securely mount and maintain the position of the dish during harsh outdoor conditions.
- **Convenient Installation** The bubble level allows for easy alignment.
- **Precision Elevation Adjustment of the AF-5G30-S45** Use this new feature to quickly fine-tune and adjust the elevation.

## Weatherproof Design

- **Protective Shroud** The shroud protects the cables and connectors from nature's elements.
- **Mounting Hardware of the AF-5G30-S45** Made of galvanized steel that is powder-coated for superior corrosion resistance.
- **Fasteners of the AF-5G30-S45** GEOMET-coated for improved corrosion resistance when compared with zinc-plated fasteners.

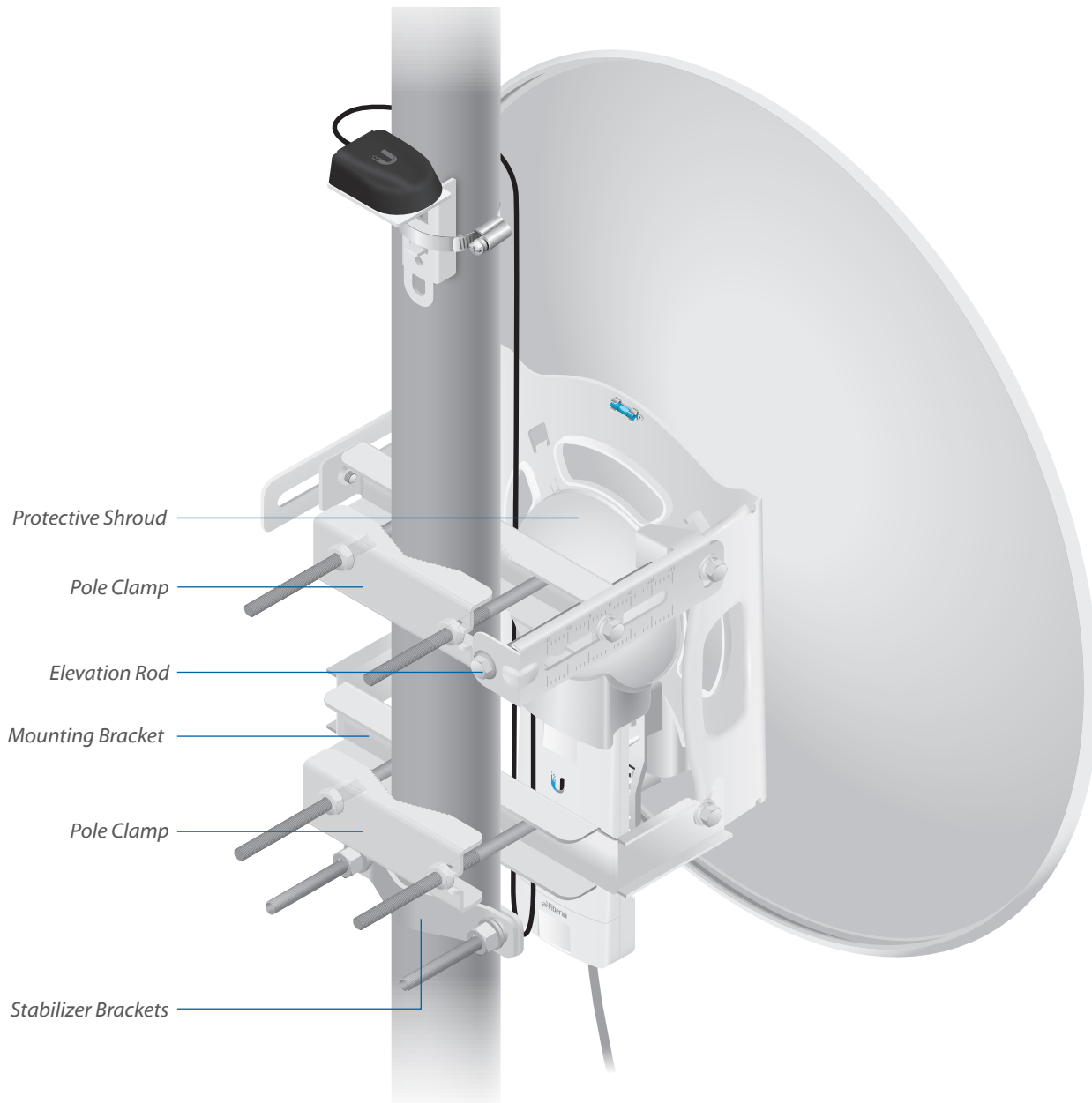

Back View of the Fully Assembled AF-5G30-S45

# Models

The 5 GHz frequency band is free to use, worldwide, offers plentiful spectrum, and works well for long-distance links. However, 5 GHz signals have more difficulty passing through obstacles than lower-frequency signals.



Model	Frequency	Gain
AF-5G23-S45	5 GHz	23 dBi

Housed in a compact form factor, the AF-5G23-S45 offers 23 dBi of gain and features the following advantages:

- Low sidelobes reduce interference from other transmitters in the area.
- High isolation enhances performance for co-location in tower-mounted installations.
- The low-profile design with integrated radome reduces wind-loading.



Model	Frequency	Gain
AF-5G30-S45	5 GHz	30 dBi

The AF-5G30-S45 offers 30 dBi of gain and features the following advantages:

- Lightweight yet robust components lessen the load.
- The extended depth of the dish reflector rejects noise interference in co-location deployments.
- The design of the mounting bracket allows for ease of installation on a pole or tower.



Model	Frequency	Gain
AF-5G34-S45	5 GHz	34 dBi

The AF-5G34-S45 offers 34 dBi of gain in a 1050-mm diameter size.

# AF-5G30-S45 Accessories

## IsoBeam™

Model: ISO-BEAM-620



The IsoBeam™ is an isolator radome that is available as an optional accessory for the AF-5G30-S45 and other dish antenna models:

- RocketDish® RD-5G30-LW
- PowerBeam™ PBE-5AC-620
- PowerBeam PBE-M5-620

The innovative RF-choke perimeter of the IsoBeam delivers superior noise immunity in co-location deployments; its perimeter corrugation provides enhanced RF shielding. Compare the two near-field plots below, and note the breakthrough isolation performance of the IsoBeam.

Both near-field plots are displayed in watts and use a linear scale. The strength of the electromagnetic field is color-coded:

- Red: Highest strength
- Green: Medium strength
- Indigo: Lowest strength

Without IsoBeam

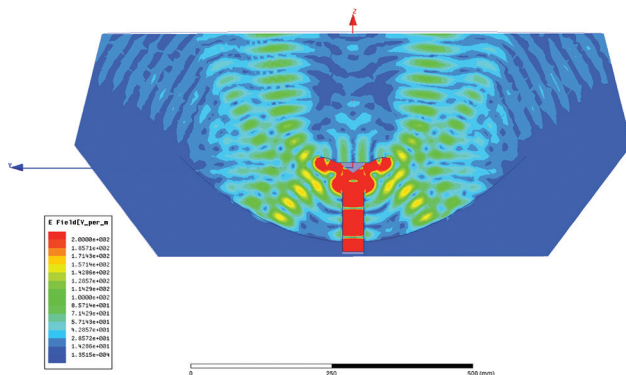

With IsoBeam

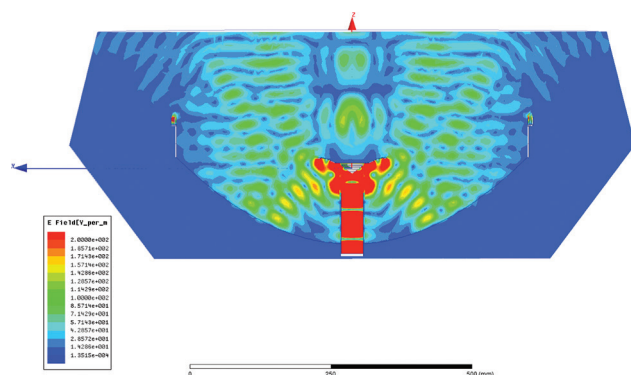

## Precision Alignment Kit

Model: PAK-620

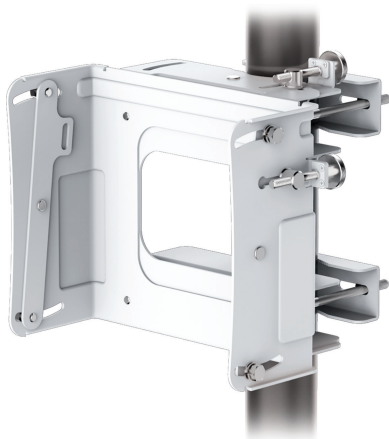

The Precision Alignment Kit is available as an optional accessory for the AF-5G30-S45. It features 15° of azimuth adjustment and 15° of elevation adjustment to enable extremely accurate aiming for optimal PtP link performance.

The Precision Alignment Kit is also compatible with other dish antenna models:

- RocketDish RD-5G30-LW
- PowerBeam PBE-5AC-620
- PowerBeam PBE-M5-620

# Specifications

Antenna Characteristics			
Model	AF-5G23-S45	AF-5G30-S45	AF-5G34-S45
Dimensions*	378 x 378 x 290 mm (14.88 x 14.88 x 11.42")	650 x 650 x 386 mm (25.6 x 25.6 x 15.2")	1050 x 1050 x 421 mm (41.34 x 41.34 x 16.57")
Weight**	3.4 kg (7.5 lb)	7.4 kg (16.31 lb)	13.5 kg (29.76 lb)
Frequency Range	5.1 - 5.9 GHz	5.1 - 5.9 GHz	5.1 - 5.8 GHz
Gain	23 dBi	30 dBi	34 dBi
+ 45° Beamwidth	10° (3 dB)	5.8° (3 dB)	3° (3 dB)
- 45° Beamwidth	10° (3 dB)	5.8° (3 dB)	3° (6 dB)
F/B Ratio	30 dB	30 dB	42 dB
Max. VSWR	1.5:1	1.6:1	1.4:1
Wind Loading	190 N @ 200 km/h (43 lbf @ 125 mph)	790 N @ 200 km/h (178 lbf @ 125 mph)	1,779 N @ 200 km/h (400 lbf @ 125 mph)
Wind Survivability	200 km/h (125 mph)		
Polarization	Dual-Linear		
Cross-pol Isolation	35 dB Min.		
ETSI Specification	EN 302 326 DN2		
Mounting	Universal Pole Mount, airFiber X Radio Bracket, and Weatherproof RF Connectors Included		

\* Dimensions exclude pole mount and airFiber X radio (airFiber X radio sold separately)

\*\* Weight includes pole mount and excludes airFiber X radio (airFiber X radio sold separately)

## AF-5G23-S45 Antenna Information

Return Loss

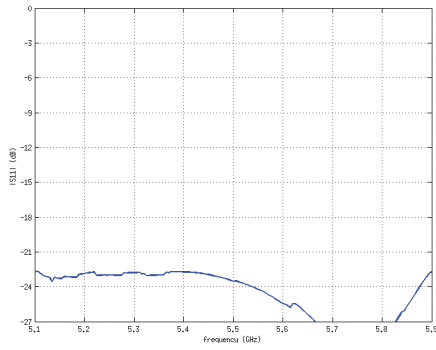

E-Plane, 5500 MHz

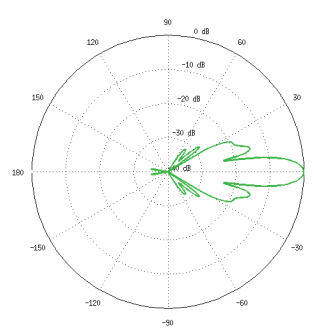

E-Plane Specs

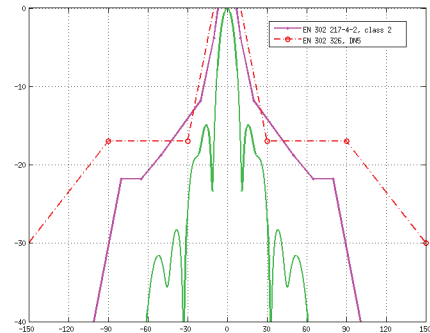

H-Plane, 5500 MHz

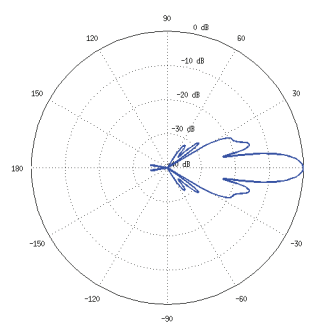

H-Plane Specs

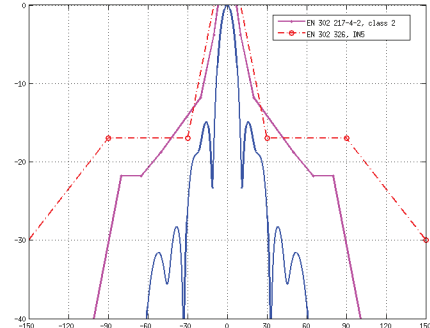

## AF-5G30-S45 Antenna Information

Return Loss

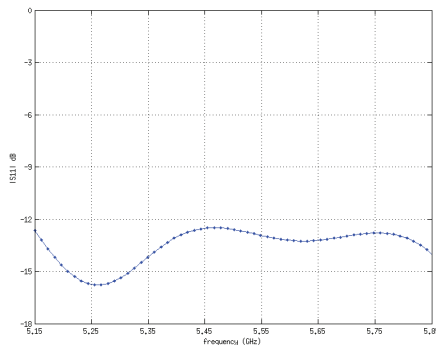

E-Plane, 5500 MHz

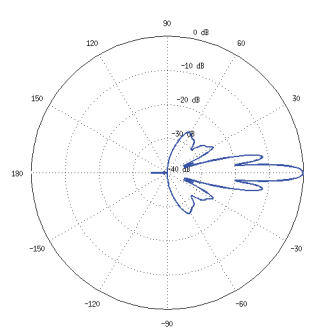

E-Plane Specs

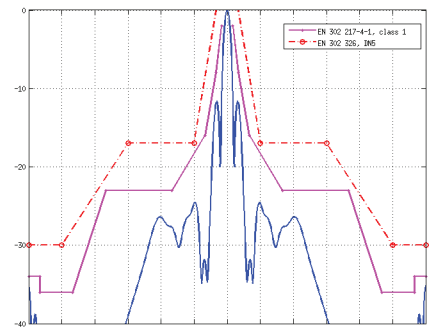

H-Plane, 5500 MHz

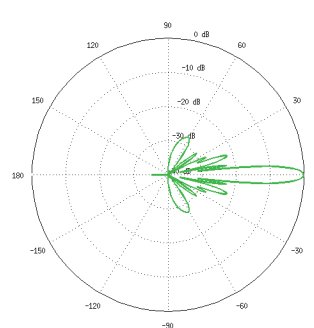

H-Plane Specs

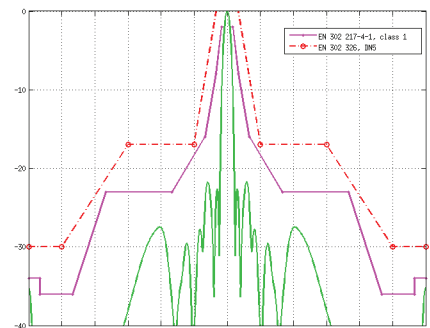

# AF-5G34-S45 Antenna Information

E-Plane, 5500 MHz

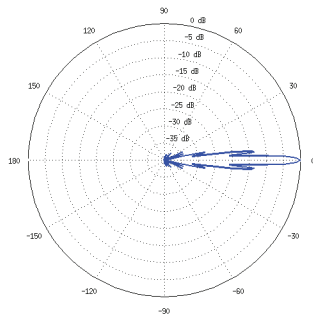

E-Plane Specs

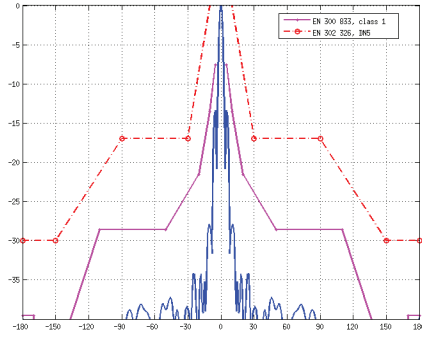

H-Plane, 5500 MHz

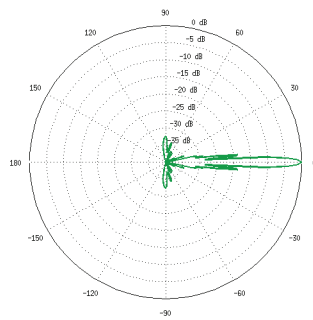

H-Plane Specs

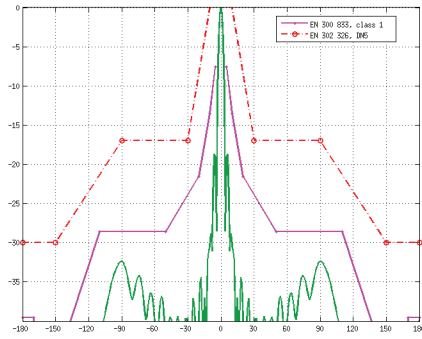

Specifications are subject to change. Ubiquiti products are sold with a limited warranty described at: [www.ubnt.com/support/warranty](http://www.ubnt.com/support/warranty)  
 ©2015 Ubiquiti Networks, Inc. All rights reserved. Ubiquiti, Ubiquiti Networks, the Ubiquiti U logo, the Ubiquiti beam logo, airFiber, airMAX, airOS, PowerBeam, Rocket, and RocketDish are trademarks or registered trademarks of Ubiquiti Networks, Inc. in the United States and in other countries. All other trademarks are the property of their respective owners.

[www.ubnt.com](http://www.ubnt.com)

JL060415