

HP 10bII+ Financial Calculator

User's Guide



HP Part Number: NW239-90001
Edition 1, May 2010

Legal Notice

This manual and any examples contained herein are provided “as is” and are subject to change without notice. Hewlett-Packard Company makes no warranty of any kind with regard to this manual, including, but not limited to, the implied warranties of merchantability, non-infringement and fitness for a particular purpose. In this regard, HP shall not be liable for technical or editorial errors or omissions contained in the manual.

Hewlett-Packard Company shall not be liable for any errors or for incidental or consequential damages in connection with the furnishing, performance, or use of this manual or the examples contained herein.

Copyright © 2010 Hewlett-Packard Development Company, L.P.

Reproduction, adaptation, or translation of this manual is prohibited without prior written permission of Hewlett-Packard Company, except as allowed under the copyright laws.

Hewlett-Packard Company
Palo Alto, CA
94304
USA

HP 10bII+ Financial Calculator

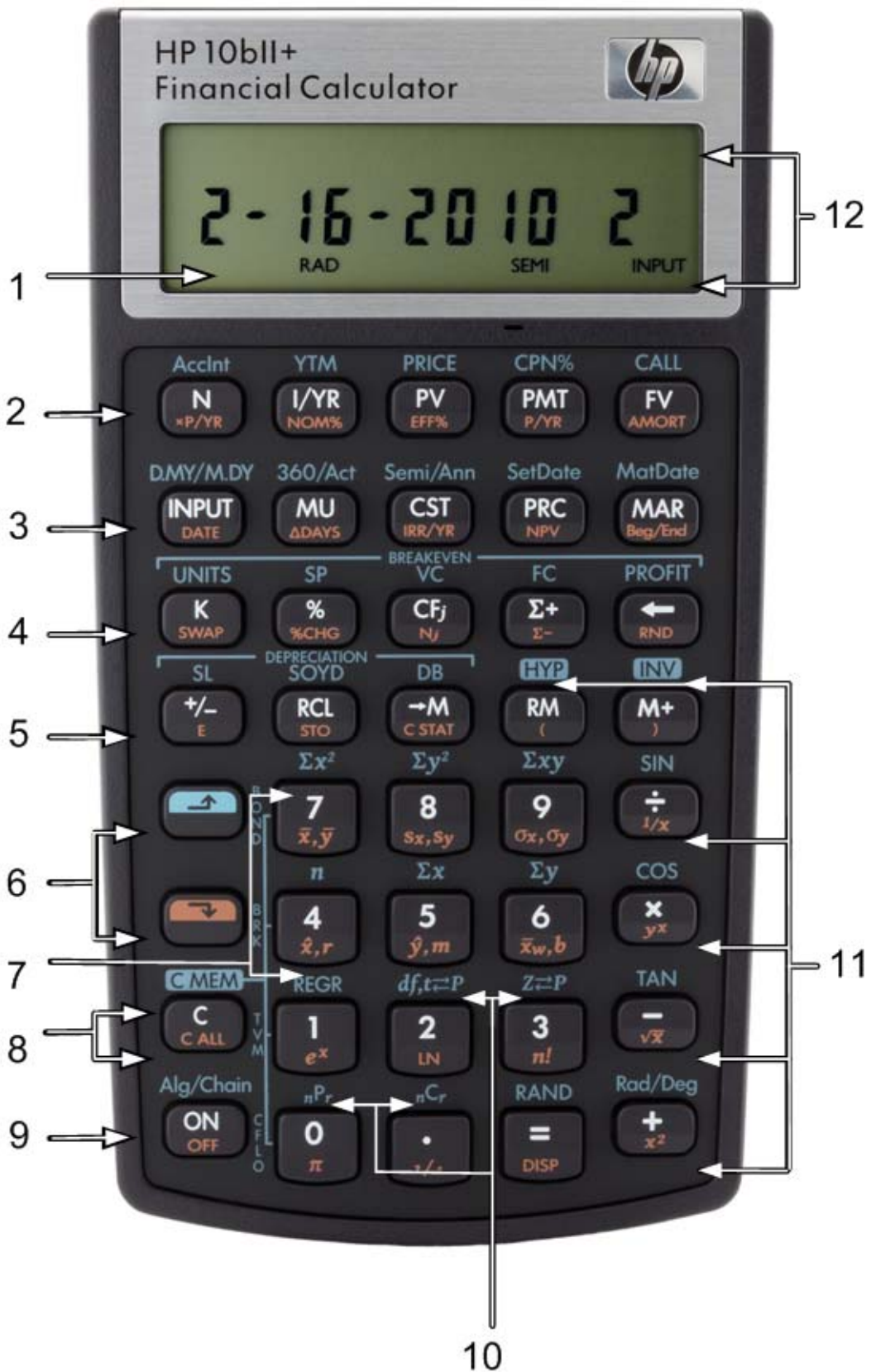

Keyboard Map Legend



Number (row of keys)	Primary Functions (white)	SHIFT Down  (orange functions on key bevel)	SHIFT Up  (blue functions above keys)
1	12 character, seven-segment screen display		
2	Time Value of Money (TVM)	Payments per year, interest conversion, amortization,	Bond calculations
3	Input key, markup, cost, price and margin	Date and change of days, IRR per year, NPV, beginning/end of payment period	Calendar and coupon payment schedules, settlement and maturity dates (bonds)
4	K memory register, percent, cash flow amount, statistics entry, backspace	Swap, percent change, cash flow count, delete statistics, round	Break-even calculation
5	Change sign, recall and memory	Scientific notation, store, clear statistics, parentheses	Depreciation, hyperbolic and trigonometric functions
6	Shift (blue, up) Shift (orange, down)		
7	Numbered keys: 1, and 4-9	Statistics, weighted mean and estimation	Statistical functions and regression modes
8	Clearing functions	Clearing functions	Clearing functions
9	On	Off	Operating modes
10	Numbered keys: 0 and 2-3, decimal	Common mathematical functions	Probability functions
11	Mathematical functions	Common mathematical functions, parentheses	Trigonometric functions
12	Annunciators		

Table of Contents

Legal Notice.....	ii
HP 10bII+ Financial Calculator.....	iii
Keyboard Map Legend.....	iv
1 At a Glance.....	1
Basics of Key Functions.....	1
Shift Keys.....	2
Boxed Key Functions.....	2
Percentages.....	3
Memory Keys.....	4
Time Value of Money (TVM).....	6
TVM What if.....	7
Amortization.....	8
Depreciation.....	9
Interest Rate Conversion.....	10
Cash Flows, IRR/YR, NPV, and NFV.....	11
Date and Calendar.....	13
Bonds.....	14
Break-even.....	16
Statistical Calculations.....	17
Probability.....	19
Trigonometric Functions.....	20
2 Getting Started.....	23
Power On and Off.....	23
Manual Conventions and Examples.....	23
Basics of Key Functions.....	24
Shift Keys.....	25
Boxed Key Functions.....	25
Simple Arithmetic Calculations.....	26
Understanding the Display and Keyboard.....	29
Cursor.....	29
Clearing the Calculator.....	29
Annunciators.....	30
Input Key.....	32
Swap Key.....	32
Statistics Keys.....	32
Time Value of Money (TVM), Cash Flows, Bond, and Break-even Keys.....	33
Math Functions.....	33
Trigonometric and Hyperbolic Functions and Modes.....	35
Pi.....	36
Hyperbolic Functions.....	36
Two-Number Functions.....	37
In-line Functions.....	37

Arithmetic with One-and Two-number Functions	39
Last Answer	41
Display Format of Numbers	41
Scientific Notation	43
Interchanging the Period and Comma	43
Rounding Numbers	43
Messages	44
3 Business Percentages	45
The Business Percentage Keys	45
Percent key	45
Margin and Markup Calculations	47
4 Number Storage and Storage Register Arithmetic	49
Using Stored Numbers in Calculations	49
5 Picturing Financial Problems	55
How to approach a Financial Problem	55
Signs of Cash Flows	56
Periods and Cash Flows	56
Simple and Compound Interest	56
Interest Rates	57
Two Types of Financial Problems	58
Recognizing a Cash Flow Problem	59
6 Time Value of Money Calculations	61
Using the TVM Application	61
The TVM Keys	61
Begin and End Modes	62
Loan Calculations	62
Savings Calculations	67
Lease Calculations	71
Amortization	74
Interest Rate Conversions	79
Resetting the TVM Keys	82
7 Depreciation	83
The Depreciation Keys	83
Resetting the TVM Keys	86

8 Cash Flow Calculations	87
How to Use the Cash Flow Application	87
Clearing the Cash Flow Memory.....	88
Calculating Internal Rate of Return.....	90
NPV and IRR/YR: Discounting Cash Flows	91
Organizing Cash Flows	91
Viewing and Editing Cash Flows.....	93
Calculating Net Present Value and Net Future Value	95
Automatic Storage of IRR/YR and NPV	98
9 Calendar Formats and Date Calculations	99
Calendar Format.....	99
Date Format	99
Date Calculations and Number of Days	101
Number of Days	102
10 Bonds	105
The Bond Keys.....	105
Resetting the bond keys	108
11 Break-even	109
The Break-even Keys.....	109
Resetting the Break-even keys	112
12 Statistical Calculations	113
Clearing Statistical Data	114
Entering Statistical Data	114
Viewing and Editing Statistical Data	116
Summary of Statistical Calculations	119
Mean, Standard Deviations, and Summation Statistics.....	120
Linear Regression, Estimation, and Regression Modes.....	121
Weighted Mean	124
Regression Models and Variables	125
Probability Calculations	126
Factorial	126
Permutations.....	126
Combinations	127
Random Number and Seed.....	127
Advanced Probability Distributions	128
Normal Lower Tail Probability	129
Inverse of Normal Lower Tail Probability	130
Student's T Probability Lower Tail	131































Inverse of Student's t Probability Lower Tail.....	132
Conversions from Lower Tail	133
13 Additional Examples	137
Business Applications.....	137
Loans and Mortgages	139
Savings	148
Cash Flow Examples.....	152
14 Appendix A: Batteries and Answers to Common Questions	I
Power and Batteries	I
Low Power Annunciator.....	I
Installing Batteries.....	I
Determining if the Calculator Requires Service	II
Answers to Common Questions	III
Environmental Limits.....	IV
15 Appendix B: More About Calculations	I
IRR/YR Calculations	I
Equations	I
16 Appendix C: Messages	I
17 Warranty, Regulatory, and Contact Information	1
Replacing the Batteries.....	1
HP Limited Hardware Warranty and Customer Care.....	1
Limited Hardware Warranty Period	1
General Terms	2
Exclusions.....	2
Regulatory Information	3
Federal Communications Commission Notice.....	3
Modifications.....	3
Declaration of Conformity for Products Marked with FCC Logo, United States Only	4
Canadian Notice	4
Avis Canadien	4
European Union Regulatory Notice	4
Japanese Notice	5
Disposal of Waste Equipment by Users in Private Household in the European Union	5
Perchlorate Material - special handling may apply.....	6
Customer Care.....	6
Contact Information	6

1 At a Glance...

This section is designed for you if you're already familiar with calculator operation or financial concepts. You can use it for quick reference. The rest of the manual is filled with explanations and examples of the concepts presented in this section.

Basics of Key Functions

Table 1-1 Basics of key functions

Keys	Display	Description
	0.00	Turns calculator on.
	0.00	Displays shift annunciator  .
 [blue]	0.00	Displays shift annunciator  .
 [orange]	0.00	Displays shift annunciator  .
   	12_	Erases last character.
	0.00	Clears display.
 	0.00	Clears statistics memory.
 	12 P_Yr (message flashes, then disappears)	Clears all memory.
  	BOND CLR (message flashes, then disappears)	Clears bond memory.
  	BR EV CLR (message flashes, then disappears)	Clears break-even memory.
  	TVM CLR (message flashes, then disappears)	Clears tvm registers.
  	CFLO CLR (message flashes, then disappears)	Clears cash flow memory.
 		Turns calculator off.

Shift Keys

Most keys on the HP 10bII+ have three functions:

- a primary function printed in white on the key.
- a secondary function printed in orange on the bevel of the key.
- a tertiary function printed in blue above the key on the keyboard (see Figure 1).

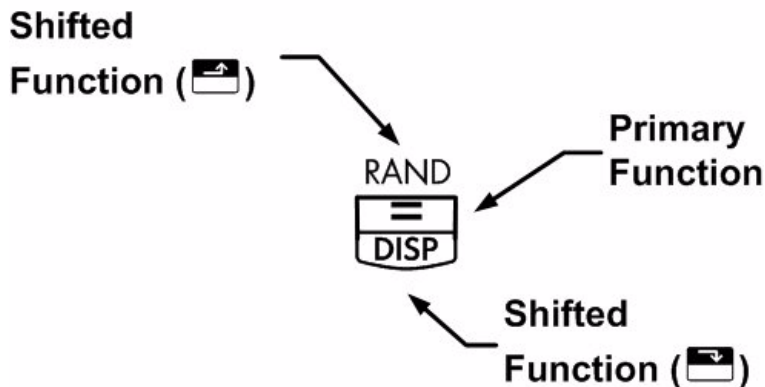







Figure 1

As an example, the functions associated with the equals key, , are illustrated in the text as follows:

- primary function (equals): 
- secondary function (display):  
- tertiary function (random):  

Boxed Key Functions

These special functions require subsequent key presses to operate. For example, the functions associated with the clear key, , include:

Table 1-2 Clearing functions

















Keys	Associated Function
	Clear display.
 	Clear all memory.
  	Clears bond memory.







Table 1-2 Clearing functions

Keys	Associated Function
  	Clears break-even memory.
  	Clears TVM memory.
  	Clears cash flow memory.
 	Clears statistics memory.

For more information on the calculator's keys and basic functions, refer to chapter 2, *Getting Started*.











Percentages

Table 1-3 Keys for percentage calculations

Keys	Description
	Percent
 	Percent change
	Cost
	Price
	Margin
	Markup







Add 15% to 17.50.

Table 1-4 Calculating the price

Keys	Display	Description
     	17.50	Enters number.
   	20.13	Adds 15%.







Find the margin if the cost is 15.00 and selling price is 22.00.

Table 1-5 Finding the margin

Keys	Display	Description
  	15.00	Enters cost.
  	22.00	Enters price.
	31.82	Calculates margin.

If the cost is 20.00 and the markup is 33%, what is the selling price?



























Table 1-6 Calculating the price

Keys	Display	Description
  	20.00	Enters cost.
  	33.00	Enters markup.
	26.60	Calculates price.

For more information on percentages, refer to chapter 3, *Business Percentages*.













Memory Keys

Table 1-7 Memory keys

Keys	Description
	Stores a constant operation.
	Stores a value in the M register (memory location).
	Recalls a value from the M register.
	Adds a value to the number stored in the M register.
 	When followed by a number key,  to  , or  and  to  , stores a number in the display into a numbered data storage register. There are 20 storage registers, designated 0-19. Press    followed by  through  to access registers 10-19.
	When followed by a number key,  to  , or  and  to  , recalls a number from a storage register. Press   followed by  through  to access registers 10-19.









Multiply 17, 22, and 25 by 7, storing 'x 7' as a constant operation.

Table 1-8 Storing 'x 7' as a constant

Keys	Display	Description
    	7.00	Stores 'x 7' as a constant operation.
	119.00	Multiplies 17 x 7.
  	154.00	Multiplies 22 x 7.
  	175.00	Multiplies 25 x 7.



















Store 519 in register 2, then recall it.

Table 1-9 Storing and recalling

Keys	Display	Description
     	519.00	Stores 519 in register 2.
	0.00	Clears display.
 	519.00	Recalls register 2.

Store 1.25 into register 15, then add 3, and store the result in register 15.

Table 1-10 Storage register arithmetic

Keys	Display	Description
   	1.25	Inputs 1.25 into the display.
   		Stores 1.25 in register 15.
     	3.00	Adds 3 to 1.25 in register 15 stores the result in register 15.
	0.00	Clears the display.
  	4.25	Recalls register 15.















For more information on number storage and storage register arithmetic, refer to chapter 4, *Number Storage and Storage Register Arithmetic*.

Time Value of Money (TVM)

Enter any four of the five values and solve for the fifth.

A negative sign in the display represents money paid out, and money received is positive.

Table 1-11 Keys for TVM calculations

Keys	Description
  	Clears TVM memory and the current P_YR is displayed.
	Number of payments.
 	Multiplies a value by the number of payments per year and stores as N.
	Interest per year.
	Present value.
	Payment.
	Future value.
 	Begin or End mode.
 	Number of payments per year mode.

If you borrow 14,000 (PV) for 360 months (N) at 10% interest (I/YR), what is the monthly repayment?

Set to End mode. Press  if **BEGIN** annunciator is displayed.

Table 1-12 Calculating the monthly payment





















Keys	Display	Description
  	TVM CLR (message flashes, then disappears)	Clears TVM memory and displays the current P_YR.
   	12.00	Sets payments per year.
   	360.00	Enters number of payments.
  	10.00	Enters interest per year.
     	14,000.00	Enters present value.

Table 1-12 Calculating the monthly payment

Keys	Display	Description
0 FV	0.00	Enters future value.
PMT	-122.86	Calculates payment if paid at end of period.

TVM What if...

It is not necessary to reenter TVM values for each example. Using the values you just entered, how much can you borrow if you want a payment of 100.00?

Table 1-13 Calculating a new payment

Keys	Display	Description
1 0 0 +/- PMT	-100.00	Enters new payment amount. (Money paid out is negative).
PV	11,395.08	Calculates amount you can borrow.





...how much can you borrow at a 9.5% interest rate?

Table 1-14 Calculating a new interest rate

Keys	Display	Description
9 . 5 I/YR	9.50	Enters new interest rate.
PV	11,892.67	Calculates new present value for 100.00 payment and 9.5% interest.
1 0 I/YR	10.00	Reenters original interest rate.
1 4 0 0 0 PV	14,000.00	Reenters original present value.
PMT	-122.86	Calculates original payment.









For more information on TVM concepts and problems, refer to chapter 5, *Picturing Financial Problems*, and chapter 6, *Time Value of Money Calculations*.

Amortization

After calculating a payment using Time Value of Money (TVM), input the periods to amortize and press  . Press   once for periods 1-12, and once again for payments 13-24. Press  to continually cycle through the principal, interest, and balance values (indicated by the **PRIN**, **INT**, and **BAL** annunciators respectively). Using the previous TVM example, amortize a single payment and then a range of payments.

Amortize the 20th payment of the loan.

Table 1-15 Amortizing the 20th payment of the loan

Keys	Display	Description
  	20.00	Enters period to amortize.
 	20 – 20	Displays period to amortize.
	-7.25	Displays principal.
	-115.61	Displays interest. (Money paid out is negative).
	13,865.83	Displays the balance amount.

Amortize the 1st through 24th loan payments.

Table 1-16 Amortization example













Keys	Display	Description
   	12_	Enters range of periods to amortize.
 	1 – 12	Displays range of periods (payments).
	-77.82	Displays principal.
	-1,396.50	Displays interest. (Money paid out is negative).
	13,922.18	Displays the balance amount.
 	13 – 24	Displays range of periods.
	-85.96	Displays principal.

Table 1-16 Amortization example

Keys	Display	Description
	-1,388.36	Displays interest.
	13,836.22	Displays the balance amount.

For more information on amortization, refer to the section titled, *Amortization* in chapter 6, *Time Value of Money Calculations*.

Depreciation

Table 1-17 Depreciation keys







Keys	Description
	Expected useful life of the asset.
	Declining balance factor entered as a percentage.
	Depreciable cost of the asset at acquisition.
	Salvage value of the asset.
	Straight-line depreciation.
	Sum-of-the-years'-digits depreciation.
	Declining Balance depreciation.

A metalworking machine, purchased for 10,000.00, is to be depreciated over five years. Its salvage value is estimated at 500.00. Using the straight-line method, find the depreciation and remaining depreciable value for each of the first two years of the machine's life.

Table 1-18 Calculating the depreciation

Keys	Display	Description
	10,000.00	Inputs cost of the item.
	500.00	Inputs the salvage value of the item.
	5.00	Inputs the useful life of the asset.
	1,900.00	Depreciation of the asset in year one.

Table 1-18 Calculating the depreciation







Keys	Display	Description
  SWAP	7,600.00	Remaining depreciable value after year one.
  	1,900.00	Depreciation of the asset in year two.
  SWAP	5,700.00	Remaining depreciable value after year two.

For more information on depreciation, refer to chapter 7, *Depreciation*.

Interest Rate Conversion











To convert between nominal and effective interest rates, enter the known rate and the number of periods per year, then solve for the unknown rate.

Table 1-19 Keys for interest rate conversion

Keys	Description
  NOM%	Nominal interest percent.
  EFF%	Effective interest percent.
  P/YR	Periods per year.

Find the annual effective interest rate of 10% nominal interest compounded monthly.

























Table 1-20 Calculating the interest rate

Keys	Display	Description
    NOM%	10.00	Enters nominal rate.
    P/YR	12.00	Enters payments per year.
  EFF%	10.47	Calculates annual effective interest.

For more information on interest rate conversions, refer to the section titled, *Interest Rate Conversions* in chapter 6, *Time Value of Money Calculations*.

Cash Flows, IRR/YR, NPV, and NFV

Table 1-21 Cash flows, IRR, NPV, and NFV keys

Keys	Description
  	Clears cash flow memory.
 	Number of periods per year (default is 12). For annual cash flows, P/YR should be set to 1 ; for monthly cash flows, use the default setting, 12 .
	Cash flows, up to 45. “ J ” identifies the cash flow <i>number</i> . When preceded by a number, pressing  enters a cash flow amount.
<i>number 1</i>  <i>number 2</i> 	Enter a cash flow amount, followed by  . Enter a number for the cash flow count followed by  to enter cash flow amount and count simultaneously.
 	Opens editor for reviewing/editing entered cash flows. Press  or  to scroll through the cash flows.
 	Number of consecutive times cash flow “ J ” occurs.
 	Internal rate of return per year.
 	Net present value.
   	Net future value.

If you have an initial cash outflow of 40,000, followed by monthly cash inflows of 4,700, 7,000, 7,000, and 23,000, what is the IRR/YR? What is the IRR per month?

Table 1-22 Calculating the IRR/YR and IRR per month

Keys	Display	Description
	CFLO CLR (message flashes, then disappears)	Clears cash flow memory.
	12.00	Sets payments per year.
	-40,000.00 (CF 0 flashes, then disappears)	Enters initial outflow.
	4,700.00 (CF 1 flashes, then disappears)	Enters first cash flow.
	2.00 (CFn 2 flashes, then disappears)	Enters both the cash flow amount (7000.00) and count (2.00) simultaneously for second cash flow.
	23,000.00 (CF 3 flashes, then disappears)	Enters third cash flow.
	0 -40,000.00	Reviews entered cash flows starting with the initial cash flow. Press to scroll through the cash flow list to verify the cash flow number, the amounts, and count for each entry. Press to exit.
	15.96	Calculates <i>IRR/YR</i> .
	1.33	Calculates <i>IRR</i> per month.

What is the NPV and NFV if the discount rate is 10%?

Table 1-23 Calculating NPV and NFV

Keys	Display	Description
	10.00	Enters <i>I/YR</i> .
	622.85	Calculates <i>NPV</i> .

Table 1-23 Calculating NPV and NFV

Keys	Display	Description
	643.88	Calculates NFV.

For more information on cash flows, refer to chapter 8, *Cash Flow Calculations* in the *HP 10bII+ Financial Calculator User's Guide*.

Date and Calendar

Table 1-24 Keys used for dates and calendar functions

Keys	Description
	Enters dates in DD.MMYYYY or MM.DDYYYY formats. D.MY is the default. Numbers at the far right of a calculated date indicate days of the week. 1 is for Monday; 7 is for Sunday.
	Toggles between 360-and 365-day (Actual) calendars.
	Calculates the date and day, past or future, that is a given number of days from a given date. Based on your current setting, returned result is calculated using either 360-day or 365-day (Actual).
	Calculates the number of days between two dates. Returned result is always calculated based on the 365-day calendar (Actual).

If the current date is February 28 2010, what is the date 52 days from now? Calculate the date using the 365-day calendar (actual) and the M.DY settings.

If **360** is displayed, press . If **D.MY** is displayed, press .

Table 1-25 Calculating the date

Keys	Display	Description
	2.28	Inputs the date in the selected format.
	4-21-2010 3	Inputs the number of days and calculates the date along with the day of the week.

For more information on date and calendar functions, refer to chapter 9, *Calendar Formats and Date Calculations*.

Bonds





























Bond calculations, primarily calculating bond price and yield, are performed by two keys,  and . These keys permit you to input data or return results. Pressing  only calculates a result. The other keys used in bond calculations only permit you to input the data required for the calculations.

Table 1-26 Bond calculation keys





















































Keys	Description
  	Clears bond memory.
 	Calculates accrued interest only.
 	Yield% to maturity or yield% to call date for given price.
 	Price per 100.00 face value for a given yield.
 	Coupon rate stored as an annual %.
 	Call value. Default is set for a call price per 100.00 face value. A bond at maturity has a call value of 100% of its face value.
 	Date format. Toggle between day-month-year (dd.mmyyyy) or month-day-year (mm.ddyyyy).
 	Day count calendar. Toggle between Actual (365-day calendar) or 360 (30-day month/360-day year calendar).
 	Bond coupon (payment). Toggle between semiannual and annual payment schedules.
 	Settlement date. Displays the current settlement date.
 	Maturity date or call date. The call date must coincide with a coupon date. Displays the current maturity.

What price should you pay on April 28, 2010 for a 6.75% U.S. Treasury bond maturing on June 4, 2020, if you want a yield of 4.75%? Assume the bond is calculated on a semiannual coupon payment on an actual/actual basis.

If **SEMI** is not displayed, press   to select the semiannual coupon payment.

If **D.MY** is displayed, press   to select M.DY format.













Table 1-27 Bond calculation

Keys	Display	Description
  	BOND CLR (message flashes, then disappears)	Clears bond memory.
       	4-28-2010 3	Inputs the settlement date (mm.ddyyyy format).
  		
       	6-4-2020 4	Inputs the maturity date.
  		
      	6.75	Inputs CPN% .
     	100.00	Inputs call value. Optional, as default is 100 .
      	4.75	Inputs Yield% .
  	115.89	Calculates the price.
   	2.69	Displays the current value for accrued interest.
	118.59	Returns the result for total price (value of price + value of accrued interest). The net price you should pay for the bond is 118.59 .

For more information on bond calculations, refer to chapter 10, *Bonds*.































Break-even

Table 1-28 Break-even keys

Keys	Description
  	Clears break-even memory.
 	Stores the quantity of units required for a given profit or calculates it.
 	Stores the sales price per unit or calculates it.
 	Stores variable cost per unit for manufacturing or calculates it.
 	Stores the fixed cost to develop and market or calculates it.
 	Stores the expected profit or calculates it.

The sale price of an item is 300.00, the cost 250.00, and fixed cost 150,000.00. For a profit of 10,000.00, how many units would have to be sold?





































Table 1-29 Calculating break-even

Keys	Display	Description
  	BR EV CLR (message flashes, then disappears)	Clears break-even memory.
      	150,000.00	Inputs fixed cost.
		
    	250.00	Inputs variable cost per unit.
    	300.00	Inputs price.
      	10,000.00	Inputs profit.
 	3,200.00	Calculates the current value for the unknown item, UNITS .

For more information on break-even calculations, refer to chapter 11, *Break-even*.

Statistical Calculations

















































Table 1-30 Statistics keys

Keys	Description
	Clear statistical registers.
x-data 	Enter one-variable statistical data.
x-data  	Delete one-variable statistical data.
x-data  y-data 	Enter two-variable statistical data.
x-data  y-data  	Delete two-variable statistical data.
 	Opens editor for reviewing/editing entered statistical data.
   	Means of x and y .
   	Mean of x weighted by y . Also calculates b , intercept.
   	Sample standard deviations of x and y .
   	Population standard deviations of x and y .
y-data    	Estimate of x and correlation coefficient.
x-data    	Estimate of y and slope.
 	Permits selection of six regression models; linear is default.

Using the following data, find the means of x and y , the sample standard deviations of x and y , and the y -intercept and the slope of the linear regression forecast line. Then, use summation statistics to find Σxy .

x -data	2	4	6
y -data	50	90	160















Table 1-31 Statistics example

Keys	Display	Description
 	0.00	Clears statistics registers.
    	1.00	Enters first x,y pair.
    	2.00	Enters second x,y pair.
     	3.00	Enters third x,y pair.
 	1 2.00	Reviews entered statistical data, starting with the initial x -value. Press  to scroll through and verify the entered statistical data. Press  to exit.
 	4.00	Displays mean of x .
  	100.00	Displays mean of y .
  	2.00	Displays sample standard deviation of x .
  	55.68	Displays sample standard deviation of y .
     	-10.00	Displays y -intercept of regression line.
     	27.50	Displays slope of regression line.
  	1,420.00	Displays Σxy , sum of the products of x - and y -values.

For more information on statistical calculations, refer to chapter 12, *Statistical Calculations*.















Probability

Table 1-32 Probability keys

Keys	Description
 $Z \leftrightarrow P$ 	Calculates a cumulative normal probability given a Z-value.
 INV  $Z \leftrightarrow P$ 	Calculates a Z-value given a cumulative normal probability.
 $df \leftrightarrow P$ 	Calculates the cumulative Student's T probability given degrees of freedom and a T-value.
 INV  $df \leftrightarrow P$ 	Calculates a T-value given degrees of freedom and the cumulative Student's T probability.
 nPr 	Calculates number of permutations of n items taken r at a time.
 nCr 	Calculates number of combinations of n taken r at a time.
 $\frac{3}{n!}$	Calculates factorial of n (where $-253 < n < 253$).

Enter .5 as a Z-value and calculate the cumulative probability of the Z-value and the Z-value from a given cumulative probability.























Table 1-33 Calculating the probability

Keys	Display	Description
 $\frac{=}{DISP}$ 	0.00000	Sets number display to five digits to the right of the decimal.
   $Z \leftrightarrow P$ 	.69146	Calculates the cumulative probability of the Z-value.
    	.94146	Adds .25.
 INV  $Z \leftrightarrow P$ 	1.56717	Calculates the Z-value from the cumulative probability.

For more information on probability, refer to the section titled, *Probability* in chapter 12, *Statistical Calculations*.







Trigonometric Functions

Table 1-34 Trigonometry keys

Keys	Description
   , or 	Calculates sine, cosine, and tangent.
 	Calculates inverse sine, inverse cosine, and inverse tangent.
 ,  , or 	
 	Calculates hyperbolic sine, cosine and tangent.
 ,  , or 	
  	Calculates inverse hyperbolic sine, cosine, and tangent.
 ,  , or 	
 	Toggles between radians and degrees modes. Degrees is the default setting.

Find $\sin \theta = .62$ in degrees. If **RAD** is displayed, press  .

Table 1-35 Trigonometry example

Keys	Display	Description
  	.62	Enters value of sine for θ .
  	38.32	Calculates θ .

Convert the results to radians using Pi.



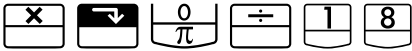
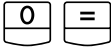



Table 1-36 Converting to radians

Keys	Display	Description
	.67	Converts degrees to radians.
		

For more information on trigonometric functions, refer to chapter 2, *Getting Started*.

2 Getting Started





Power On and Off

To turn on your HP 10bll+, press . To turn the calculator off, press the orange shift key, , then . To change the brightness of the display, hold down  and then simultaneously press  or .

Since the calculator has continuous memory, turning it off does not affect the information you have stored. To conserve energy, the calculator turns itself off after five minutes of inactivity. The calculator uses two CR2032 coin batteries. If you see the low-battery symbol () in the display, replace the batteries. For more information, refer to the section titled, *Installing Batteries* in Appendix A.

Manual Conventions and Examples

In this manual, key symbols are used to indicate the key presses used in the example problems. These symbols vary in appearance according to whether they indicate the primary, secondary, or tertiary functions required for the problem. For example, the functions associated with the equals key, , are illustrated in the text as follows:





- primary function (equals): 
- secondary function (display):  
- tertiary function (random):  

Note the symbol for the primary function of the key, in this case, =, appears on each of the key symbols depicted above. This repetition is intended to serve as a visual aid. By looking for the symbol of the primary function on the key, you can quickly locate the keys used for the secondary and tertiary functions on the calculator.

Displayed text































Text that appears in the display screen of the calculator is presented in **BOLD CAPITAL** letters throughout the manual.

Examples

Example problems appear throughout the manual to help illustrate concepts and demonstrate how applications work. Unless otherwise noted, these examples are calculated with **CHAIN** set as the active operating mode. To view the current mode, press   . The current mode, **CHAIN** or **ALGEBRAIC**, will flash, then disappear. To change the mode, press  followed by .

Basics of Key Functions

Table 2-1 Basics of key functions

Keys	Display	Description
	0.00	Turns calculator on.
 [blue]	0.00	Displays shift annunciator  .
 [orange]	0.00	Displays shift annunciator  .
   	12_	Erases last character.
 	RAD (at the bottom of the display)	Toggles between radians and degrees. The item before the / is the alternate; the item after the / is the default setting. Except for the operating mode, annunciators in the display indicate alternate settings are active.
	0.00	Clears display.
 	0.00	Clears statistics memory.
  	12 P_Yr (message flashes, then disappears)	Clears all memory.
  	BOND CLR (message flashes, then disappears)	Clears bond memory.
  	BR EV CLR (message flashes, then disappears)	Clears break-even memory.
  	TVM CLR (message flashes, then disappears)	Clears tvm memory.
  	CFLO CLR (message flashes, then disappears)	Clears cash flow memory.
 		Turns calculator off.

Shift Keys

Most keys on the HP 10bII+ have three functions:

- a primary function printed in white on the key.
- a secondary function printed in orange on the level of the key.
- a tertiary function printed in blue above the key on the keyboard (see Figure 1).

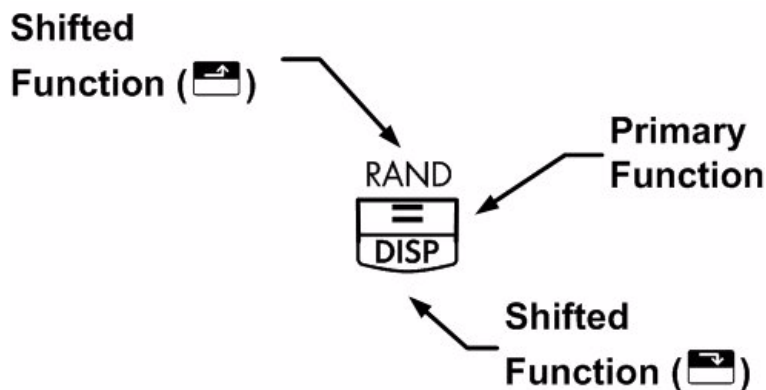

Figure 1

When you press or , a shift annunciator or is displayed to indicate that the shifted functions are active. For example, press followed by to multiply a number in the display by itself. To turn the shift annunciators off, press or again.









Boxed Key Functions

There are three shifted key functions on the calculator that are used to change the operation of another key's function. These three tertiary functions, , and , are bound by blue boxes to show that they operate differently. These special functions require subsequent key presses to operate. For example, the functions associated with the clear key, , include:

Table 2-2 Clearing functions



Keys	Associated Function
	Clear display.
	Clear all memory.
	Clear statistics memory.
	Clears bond memory.



Table 2-2 Clearing functions

Keys	Associated Function
  	Clears break-even memory.
  	Clears TVM memory.
  	Clears cash flow memory.





Simple Arithmetic Calculations





Operating Modes

To change the operating mode, press the blue shift key,  followed by  to toggle between Algebraic and Chain modes. A brief message is displayed indicating the selected operating mode.

To view the current mode, press   . The current mode will flash, then disappear.

Arithmetic Operators

The following examples demonstrate using the arithmetic operators , , , and .

If you press more than one operator consecutively, for example , , , , , all are ignored except the last one.













If you make a typing mistake while entering a number, press  to erase the incorrect digits.

Table 2-3 Example displaying calculations using arithmetic operators

Keys	Display	Description
           	87.18	Adds 24.71 and 62.47.











When a calculation has been completed (by pressing ), pressing a number key starts a new calculation.

Table 2-4 Completing a calculation

Keys	Display	Description
        	240.92	Calculates 19×12.68 .

If you press an operator key after completing a calculation, the calculation is continued.

Table 2-5 Continuing a calculation

Keys	Display	Description
$\boxed{+}$ $\boxed{1}$ $\boxed{1}$ $\boxed{5}$ $\boxed{\cdot}$ $\boxed{5}$ $\boxed{=}$	356.42	Completes calculation of 240.92 + 115.5.

Calculations in Chain Mode

Calculations in Chain mode are interpreted in the order in which they are entered. For example, entering the following numbers and operations as written from left to right,

$\boxed{1}$ $\boxed{+}$ $\boxed{2}$ $\boxed{\times}$ $\boxed{3}$ $\boxed{=}$, returns 9. If you press an operator key, $\boxed{+}$, $\boxed{-}$, $\boxed{\times}$, or $\boxed{\div}$, after $\boxed{=}$, the calculation is continued using the currently displayed value.

You can do chain calculations without using $\boxed{=}$ after each step.

Table 2-6 Chain calculations

Keys	Display	Description
$\boxed{6}$ $\boxed{\cdot}$ $\boxed{9}$ $\boxed{\times}$ $\boxed{5}$ $\boxed{\cdot}$ $\boxed{3}$ $\boxed{5}$ $\boxed{\div}$	36.92	Pressing $\boxed{\div}$ displays intermediate result (6.9 × 5.35).
$\boxed{\cdot}$ $\boxed{9}$ $\boxed{1}$ $\boxed{=}$	40.57	Completes calculation.

Without clearing, now calculate 4 + 9 × 3.

Table 2-7 Chain calculations

Keys	Display	Description
$\boxed{4}$ $\boxed{+}$ $\boxed{9}$ $\boxed{\times}$	13.00	Adds 4 and 9.
$\boxed{3}$ $\boxed{=}$	39.00	Completes calculation.

In Chain mode, if you wish to override the left to right order of entry, use parentheses

$\boxed{\leftarrow}$ \boxed{RM} $\boxed{(}$ and $\boxed{\rightarrow}$ $\boxed{M+}$ $\boxed{)}$ to prioritize operations.

For example, to calculate $1 + (2 \times 3)$, you may enter the problem as written from left to right, with parentheses to prioritize the multiplication operation. When entered with parentheses, this expression returns a result of **7**.

Calculations in Algebraic Mode

In Algebraic mode, multiplication and division have a higher priority than addition and subtraction. For example, in Algebraic mode, pressing $\boxed{1} \boxed{+} \boxed{2} \boxed{\times} \boxed{3} \boxed{=}$ returns a result of **7.00**. In Chain mode, the same key presses return a result of **9.00**.

In Algebraic mode, operations between two numbers have the following priority:

- Highest priority: combinations and permutations, T probability calculations, % change, and date calculations
- Second priority: the power function (y^x)
- Third priority: multiplication and division
- Forth priority: addition and subtraction.

The calculator is limited to 12 pending operations. An operation is pending when it is waiting for the input of a number or the result of an operation of higher priority.

Using Parentheses in Calculations

Use parentheses to postpone calculating an intermediate result until you've entered more numbers. You can enter up to four open parentheses in each calculation. For example, suppose you want to calculate:

$$\frac{30}{(85 - 12)} \times 9$$

If you enter $\boxed{3} \boxed{0} \boxed{\div} \boxed{8} \boxed{5} \boxed{-}$, the calculator displays the intermediate result, 0.35. This is because calculations without parentheses are performed from left to right as you enter them.

To delay the division until you've subtracted 12 from 85, use parentheses. Closing parentheses at the end of the expression can be omitted. For example, entering $25 \div (3 \times (9 + 12 =$ is equivalent to $25 \div (3 \times (9 + 12)) =$.

If you type in a number, for example, 53, followed by the parenthesis symbol, the calculator considers this implicit multiplication.

Example

Table 2-8 Using parentheses in calculations

Keys	Display	Description
$\boxed{3} \boxed{0} \boxed{\div} \boxed{\rightarrow} \boxed{RM} \boxed{8} \boxed{5} \boxed{-}$	85.00	No calculation yet.
$\boxed{1} \boxed{2} \boxed{\rightarrow} \boxed{M+}$	73.00	Calculates 85 - 12.

Table 2-8 Using parentheses in calculations

Keys	Display	Description
	0.41	Calculates $30 \div 73$.
	3.70	Multiplies the result by 9.

Negative Numbers

Enter the number and press to change the sign.

Calculate $-75 \div 3$.

Table 2-9 Changing the sign of numbers

Keys	Display	Description
	-75_	Changes the sign of 75.
	-25.00	Calculates result.

Understanding the Display and Keyboard

Cursor

The blinking cursor (_) is visible when you are entering a number.

Clearing the Calculator

Backspace

When the cursor is on, erases the last digit you entered. Otherwise, clears the display and cancels the calculation.















Clear

clears the current item on the display and replaces it with **0**. If entry is in progress, pressing clears the current entry and replaces it with **0**, but the current calculation continues. Otherwise, clears the display of its current contents and cancels the current calculation.





Clear Memory

followed by , , , clears a selected memory type (register). Other memory is left intact.



Table 2-10 Clear memory keys

Keys	Description
  	Clears bond memory.
  	Clears break-even memory.
  	Clears TVM memory.
  	Clears cash flow memory.
 	Clears statistics memory.

Clear All

  all clears all memory in the calculator, with the exception of the payments per year (P/Yr) setting. To clear all memory and reset calculator modes, press and hold down , then press and hold down both  and . When you release all three, all memory is cleared. The **All Clear** message is displayed.

Clearing Messages

When the HP 10bII+ is displaying an error message,  or  clears the message and restores the original contents of the display.

Annunciators

Annunciators are symbols in the display that indicate the status of the calculator. For functions that toggle between settings, annunciators indicate alternate settings are active. For the defaults, no annunciators appear in the display. For example, when selecting a date format, the default setting is month-day-year (M.DY). When day-month-year (D.MY) is active, the **D.MY** in the display indicates it is the active setting. Table 2-11 lists all the annunciators that appear in the display screen.

Table 2-11 Annunciators and status







Annunciator	Status
	A shift key has been pressed. When another key is pressed, the functions labeled in orange or blue are executed.
INV	Inverse mode is active for trigonometric or probability functions.
RAD	Radians mode is active.
BEG	Begin mode is active; payments are at the beginning of a period.
D.MY	Day-month-year date format (DD.MMYYYY) is active.
360	360-day calendar is active.
SEMI	Semi-annual coupon payment schedule (bonds) is active.
PEND	An operation is waiting for another operand.
INPUT	The  key has been pressed and a number stored.
	Battery power is low.
AMORT	The amortization annunciator is lit, together with one of the following four annunciators:
PER	The range of periods for an amortization is displayed.
PRIN	The principal of an amortization is displayed.
INT	The interest of an amortization is displayed.
BAL	The balance of an amortization is displayed.
CFLO	The cash flow annunciator is lit, together with one of the following two annunciators:
CF	The cash flow number appears briefly, then the cash flow is shown.
N	The cash flow number appears briefly, then the number of times the cash flow is repeated is shown.
STAT	The statistics annunciator is lit, together with one of the following two annunciators:
X	The number of the data point, n , followed by an x -value is shown, or, if STAT is not lit, indicates that the first of two results is displayed.
Y	The number of the data point, n , followed by a y -value is shown, or, if STAT is not lit, indicates that the second of two results is displayed.
ERROR	The error annunciator is lit, together with one of the following four annunciators:
TVM	There is a TVM error (such as an invalid P/Yr), or, when ERROR is not lit, a TVM calculation returned a second result.
FULL	Available memory for cash flows or statistics is full, or the pending operator memory is full.
STAT	Incorrect data used in a statistics calculation or, when ERROR is not lit, a statistical calculation has been performed.

Table 2-11 Annunciators and status

Annunciator	Status
FUNC	A math error has occurred (for example, division by zero).



Input Key

The  key is used to separate two numbers when using two-number functions or two-variable statistics. The  key can also be used to enter cash flows and cash flow counts, ordered pairs, and evaluate any pending arithmetic operations, in which case the result is the same as pressing .

Swap Key

Pressing   exchanges the following:

- The last two numbers that you entered; for instance, to change the order of division or subtraction.
- The results of functions that return two values.

The  key toggles the item in the  register, or swaps the top two items in the mathematical stack. This function is used to retrieve a secondary value returned during a calculation, as well as to swap two items during a calculation.

Statistics Keys

The statistics keys are used to access summary statistics from the statistics memory registers.

When you press  followed by a statistics key, you can recall one of six summary statistics with the next keystroke.



For example, press  followed by the  key to recall the sum of the x -values entered.

Table 2-12 Statistics keys













Keys	Description
 	Sum of the squares of the x -values.
 	Sum of the squares of the y -values.
 	Sum of the products of the x - and y -values.
 	Number of data points entered.

Table 2-12 Statistics keys

Keys	Description
 Σ_y 	Sum of the y-values.
 Σ_x 	Sum of the x-values.

Time Value of Money (TVM), Cash Flows, Bond, and Break-even Keys

When entering data for TVM, cash flows, bond, depreciation and break-even calculations, results are calculated based on data entered into specific memory registers. When pressed, the keys used for these operations:

- store data.
- enter data for a variable that is used during calculations (input only).
- calculate unknown variables based on stored data.

For more information on how these keys function, refer to the specific chapters which cover TVM problems, cash flows, and bond and break-even calculations.

Math Functions

One-Number Functions

Math functions involving one number use the number in the display. To execute one-number functions, with a number displayed, press the key or key combination corresponding to the operation you wish to execute. The result is displayed. See Table 2-14 for a list of one-number functions.



Before doing any trigonometric calculations, check whether the angle mode is set for degrees or radians (Rad). Degrees is the default setting. The **RAD** annunciator in the display indicates radians is active. Press   to toggle between the settings. You will need to change the setting if the active mode is not what your problem requires.

Table 2-13 Example displaying one number functions



















Keys	Display	Description
      	9.45	Calculates square root.
          	0.42	1/2.36 is calculated first.
	3.99	Adds 3.57 and 1/2.36.

Table 2-14 lists the one-number functions of the calculator.



Table 2-14 One-number functions

Keys	Description
	Divide a number by 100.
	Rounds x to the number specified by the display format.
	Calculates $1/x$.
	Calculates the square root of x .
	Calculates the square of x .
	Calculates natural exponent to the power of x .
	Calculates natural log.
	Calculates factorial of n (where $-253 < n < 253$). The Gamma function is used to calculate $n!$ for non-integers or negative numbers.
	Calculates sine, cosine, or tangent.
	Calculates inverse sine, cosine, or tangent.
	Calculates hyperbolic sine, cosine, or tangent.
	Calculates inverse hyperbolic sine, cosine, or tangent.
	Calculates a cumulative normal probability given a Z-value.
	Calculates a Z-value given a cumulative normal probability.

The random function , and Pi are special operators. They insert values for Pi, or a random number in the range $0 < x < 1$, into calculations.















Trigonometric and Hyperbolic Functions and Modes

Selecting Angle Format

The trigonometric angle format determines how numbers are interpreted when using trigonometry functions. The default format for angles on the 10bII+ is *degrees*. To change to radians mode, press  . When radians mode is active, the **RAD** annunciator is displayed.

Trigonometric Functions

Table 2-15 Trigonometric functions

Keys	Description
 	Calculates sine, written as <i>sin</i> .
 	Calculates cosine, written as <i>cos</i> .
 	Calculates tangent, written as <i>tan</i> .
  	Calculates inverse sine, also written, <i>arcsin</i> , <i>asin</i> , or \sin^{-1} .
  	Calculates inverse cosine, also written, <i>arccos</i> , <i>acos</i> , or \cos^{-1} .
  	Calculates inverse tangent, also written, <i>arctan</i> , <i>atan</i> , or \tan^{-1} .

Example



Perform the following trigonometric calculations. If **RAD** is lit in the display, press  .

Table 2-16 Example using various trigonometric calculations





















Keys	Display	Description
   	0.0000	Set display to four decimal places.
   	0.2588	Displays sine of 15°.
     	1.7321	Displays tangent of 60°.
	2.7321	Calculates 1 + tangent of 60°.
     	69.5127	Displays inverse cosine of 0.35.

Table 2-16 Example using various trigonometric calculations

Keys	Display	Description
	51.6839	Displays inverse cosine of 0.62.
	17.8288	Calculates arccos 0.35 - arccos 0.62.
	17.83	Return display to default format.

Pi

Pressing displays the value of π . Although the displayed value appears in the current display format, the 12 digit value is actually used for calculations. π is often used during calculations in radians mode, as there are 2π radians in a circle.

Example

Find the surface area of a sphere with a radius of 4.5 centimeters. Use the formula:

$$A = 4\pi r^2$$

Table 2-17 Example using Pi

Keys	Display	Description
	3.14	Displays π .
	20.25	Displays 4.5^2 .
	254.47	Calculates sphere surface area in square centimeters.

Hyperbolic Functions

Table 2-18 Hyperbolic and inverse hyperbolic functions

Keys	Description
	Calculates hyperbolic sine, written as, <i>sinh</i> .
	Calculates hyperbolic cosine, written as, <i>cosh</i> .
	Calculates hyperbolic tangent, written as, <i>tanh</i> .
	Calculates inverse hyperbolic sine, written as, <i>arcsinh</i> , <i>asinh</i> , or, \sinh^{-1} .
	Calculates inverse hyperbolic sine, also written, <i>arccosh</i> , <i>acosh</i> , or \cosh^{-1} .
	Calculates inverse hyperbolic tangent, also written, <i>arctanh</i> , <i>atanh</i> , or \tanh^{-1} .

Example

Perform the following hyperbolic calculations.

Table 2-19 Example performing various hyperbolic calculations

Keys	Display	Description
	0.0000	Sets display to four decimal places.
	1.6019	Display sinh 1.25.
	0.5299	Displays tanh 0.59.
	2.1318	Calculates sinh 1.25 + tanh 0.59.
	1.3899	Calculates acosh 2.1318.
	1.39	Returns display to default format.







Two-Number Functions

When a function requires two numbers, other than for addition, subtraction, multiplication, division, and the power function, (y^x), you may key in the numbers as follows: *number 1* *number 2* followed by the operation. Pressing evaluates the current expression and displays the **INPUT** annunciator.

In-line Functions

For calculations involving , , , and , which require two numbers, you may also key in the first number followed by the function keys, and then key in the second number followed by to return results. Throughout the manual, when examples are entered in this manner without using , they are referred to as *in-line* functions. For example, the following keystrokes calculate the percent change between 17 and 29 using the keys as an in-line function:

Table 2-20 Example calculating percent change as an in-line function

Keys	Display	Description
   	17.00	Enters <i>number 1</i> , displays the PEND annunciator indicating the calculator is awaiting instructions.
 	29_	Enters <i>number 2</i> .
	70.59	Calculates the percent change.









Press , and now calculate the same example using the  key to store the first number, then key in the second number and perform the operation.

Table 2-21 Example calculating percent change using 'INPUT'

Keys	Display	Description
  	17.00	Enters <i>number 1</i> , and displays the INPUT annunciator indicating the number has been stored.
   	70.59	Enters <i>number 2</i> and calculates the percent change.



















Although the in-line function has fewer key strokes, performing this example using the  key permits you to store a value and then perform other calculations following  without using parentheses.

Table 2-22 Example displaying two-number functions with chain calculation

Keys	Display	Description
  	17.00	Enters <i>number 1</i> , and displays the INPUT annunciator.
    	87_	Enters and performs the chain calculation. Results are stored and used in the next operation. The PEND annunciator and the blinking cursor indicate an operation is pending as the calculator awaits instructions.
     		
 	70.59	Calculates the percent change between 17 and the result of the chain operation (29).

The Table 2-23 below lists the two-number functions of the calculator.

Table 2-23 Two-number functions

Keys	Description
	Addition, subtraction, multiplication, division.
	The power function.
	% Change.
	Combinations.
	Permutations.
	The date and day, past or future, that is a given number of days from a given date.
	The number of days between two dates.
	Calculates the cumulative Student's t probability given degrees of freedom and a t-value.
	Calculates a t-value given degrees of freedom and the cumulative Student's t probability.

Two-number functions may be performed in either **CHAIN** or **ALGEBRAIC** mode.

Arithmetic with One-and Two-number Functions

Math functions operate on the number in the display.

Example 1

Calculate $1/4$, then calculate $\sqrt{20} + 47.2 + 1.1^2$.

Table 2-24 Calculating the expression

Keys	Display	Description
	0.25	Calculates the reciprocal of 4.
	4.47	Calculates $\sqrt{20}$.

Table 2-24 Calculating the expression

Keys	Display	Description
	51.67	Calculates $\sqrt{20} + 47.20$.
	1.21	Calculates 1.1^2 .
	52.88	Completes the calculation.

Example 2

Calculate natural logarithm ($e^{2.5}$). Then calculate $790 + 4!$

Table 2-25 Calculating the logarithm value

Keys	Display	Description
	12.18	Calculates $e^{2.5}$.
	2.50	Calculates natural logarithm of the result.
	24.00	Calculates 4 factorial.
	814.00	Completes calculation.

Example 3

The power operator, y^x , raises the preceding number (y -value) to the power of the following number (x -value).



Calculate 125^3 , then find the cube root of 125.

Table 2-26 Calculating the cube root

Keys	Display	Description
	1,953,125.00	Calculates 125^3 .
	5.00	Calculates the cube root of 125, or $125^{1/3}$.













Last Answer

When a calculation is completed by pressing , or a calculation is completed during another operation, the result is stored in a memory location that contains the last calculated result. This enables the last result of a calculation to be used during the next calculation.

To access the last calculated answer, press  . Unlike the other stored memory registers however, this register is automatically updated when you complete a calculation.

















Example 1

Table 2-27 Using last answer

Keys	Display	Description
      	3.75	Calculate 5-1.25
    	3.75	Recall last answer.
	61.55	Calculate $3^{3.75}$.

Example 2

Table 2-28 Using last answer with 'INPUT'

Keys	Display	Description
  	50.00	Store 50 in the INPUT register.
      	-28.00	Calculate percent change.
  	60.00	Store 60 in the INPUT register.
 	36.00	Recalls last calculation, 22+14.
 	-40.00	Calculate percent change.

Display Format of Numbers

When you turn on the HP 10bII+ for the first time, numbers are displayed with two decimal places and a period as the decimal point. The display format controls how many digits appear in the display.

If the result of a calculation is a number containing more significant digits than can be displayed in the current display format, the number is rounded to fit the current display setting.

Regardless of the current display format, each number is stored internally as a signed, 12-digit number with a signed, three-digit exponent.

Specifying Displayed Decimal Places

To specify the number of displayed decimal places:

1. Press followed by – for the desired decimal setting.
2. followed by , , or changes the display mode. Pressing provides the best estimate and displays as many digits as required. is the value for 10, and for 11.

Table 2-29 Example displaying the number of decimal places

Keys	Display	Description
	0.00	Clears display.
	0.000	Displays three decimal places.
	5.727	
	5.727360000	Displays nine decimal places.
	5.73	Restores two decimal places.







When a number is too large or too small to be displayed in **DISP** format, it automatically displays in scientific notation.

Displaying the Full Precision of Numbers



To set your calculator to display numbers as precisely as possible, press (trailing zeros are not displayed.) To temporarily view all 12 digits of the number in the display (regardless of the current display format setting), press and hold . The number is displayed as long as you continue holding . The decimal point is not shown.

Start with two decimal places .

Table 2-30 Example displaying all digits

Keys	Display	Description
   	1.43	Divides.
  	142857142857	Displays all 12 digits.

Scientific Notation



Scientific notation is used to represent numbers that are too large or too small to fit in the display. For example, if you enter the number $10,000,000 \times 10,000,000 =$, the result is **1.00E14**, which means one times ten to the fourteenth power, or 1.00 with the decimal point moved fourteen places to the right. You can enter this number by pressing  

  . The *E* stands for exponent of ten.

Exponents can also be negative for very small numbers. The number 0.000000000004 is displayed as **4.00E−12**, which means four times ten to the *negative* twelfth power, or 4.0 with the decimal point moved 12 places to the left. You can enter this number by pressing

     .

Interchanging the Period and Comma

To switch between the period and comma (United States and International display) used as the decimal point and digit separator, press  .

For example, one million can be displayed as 1,000,000.00 or 1.000.000,00.

Pressing  , toggles between these options.

Rounding Numbers



The calculator stores and calculates using 12-digit numbers. When 12 digit accuracy is not desirable, use   to round the number to the displayed format before using it in a calculation. Rounding numbers is useful when you want the actual (dollars and cents) monthly payment.

Table 2-31 Example displaying rounding off numbers

Keys	Display	Description
	9.87654321_	Enters a number with more than two nonzero decimal places.
	9.88	Displays two decimal places.
 (while you press).	987654321000	Displays all digits without the decimal.
	9.88	Rounds to two decimal places (specified by pressing).
	988000000000	Shows rounded, stored number.

Messages

The HP 10bll+ displays messages about the status of the calculator or informs you that you have attempted an incorrect operation. To clear a message from the display, press or . For a complete list of error messages, refer to *Appendix C*.

3 Business Percentages

The Business Percentage Keys

When entering data for business percentage calculations, results are calculated based on data entered into specific memory registers. When pressed, the keys used for these operations:

- store data.
- enter known data for variables used during calculations.
- calculate unknown variables based on stored data.

You can use the 10bII+ to calculate simple percent, percent change, cost, price, margin, and markup.

Percent key

The  key has two functions:

- Finding a percent
- Adding or subtracting a percent









Finding a Percent

The  key divides a number by 100 unless it is preceded by an addition or subtraction sign.

Example

Find 25% of 200.

Table 3-1 Finding a percent

Keys	Display	Description
   	200.00	Enters 200.
  	0.25	Converts 25% to a decimal.
	50.00	Multiplies 200 by 25%.

Adding or Subtracting a Percent

You can add or subtract a percent in one calculation.

Example 1

Decrease 200 by 25%.

Table 3-2 Subtracting a percent in a calculation

Keys	Display	Description
	200.00	Enters 200.
	50.00	Multiplies 200 by 0.25 and subtracts 50 from 200.
	150.00	Completes the calculation.

Example 2

You borrow 1,250 from a relative, and you agree to repay the loan in a year with 7% simple interest. How much money will you owe?

Table 3-3 Adding a percent in a calculation

Keys	Display	Description
	1,337.50	Calculates loan interest, 87.50 and adds 87.50 and 1250.00 to show the repayment amount.

Percent Change

Calculate the percent change between two numbers.

Example 1

Calculate the percent change between 291.7 and 316.8 using the in-line feature.

Table 3-4 Calculating the percent change

Keys	Display	Description
	291.70	Enters <i>number 1</i> .
	8.60	Calculates percent change.

Example 2

Calculate the percent change between (12×5) and $(65 + 18)$ using .

Table 3-5 Calculating the percent change between two numbers

Keys	Display	Description
	60.00	Calculates and enters <i>number 1</i> . Note the INPUT annunciator.
	38.33	Calculates percent change.

For more information on in-line features, refer to chapter 2, *Getting Started*.

Margin and Markup Calculations

The 10bII+ can calculate cost, selling price, margin, or markup.

Table 3-6 Keys for margin and markup

Application	Keys	Description
Margin	<input type="text" value="CST"/> , <input type="text" value="PRC"/> , <input type="text" value="MAR"/>	Margin is markup expressed as a percent of price.
Markup	<input type="text" value="CST"/> , <input type="text" value="PRC"/> , <input type="text" value="MU"/>	Markup calculations are expressed as a percent of cost.

To see any value used by the margin and markup application, press and then the key you wish to see. For example, to see the value stored as , press .

Margin Calculations

Example

Kilowatt Electronics purchases televisions for 255. The televisions are sold for 300. What is the *margin*?

Table 3-7 Calculating the margin

Keys	Display	Description
<input type="text" value="2"/> <input type="text" value="5"/> <input type="text" value="5"/> <input type="text" value="CST"/>	255.00	Stores cost in CST.
<input type="text" value="3"/> <input type="text" value="0"/> <input type="text" value="0"/> <input type="text" value="PRC"/>	300.00	Stores selling price in PRC.
<input type="text" value="MAR"/>	15.00	Calculates margin.

Markup on Cost Calculations

Example

The standard *markup* on costume jewelry at Kleiner's Kosmetique is 60%. They just received a shipment of chokers costing 19.00 each. What is the retail price per choker?

Table 3-8 Calculating the retail price

Keys	Display	Description
<input type="text" value="1"/> <input type="text" value="9"/> <input type="text" value="CST"/>	19.00	Stores cost.
<input type="text" value="6"/> <input type="text" value="0"/> <input type="text" value="MU"/>	60.00	Stores markup.

Table 3-8 Calculating the retail price

Keys	Display	Description
PRC	30.40	Calculates retail price.

Using Margin and Markup Together

Example

A food cooperative buys cases of canned soup with an invoice cost of 9.60 per case. If the co-op routinely uses a 15% *markup*, for what price should it sell a case of soup? What is the margin?







Table 3-9 Calculating the margin

Keys	Display	Description
9 . 6 CST	9.60	Stores invoice cost.
1 5 MU	15.00	Stores markup.
PRC	11.04	Calculates the price on a case of soup.
MAR	13.04	Calculates <i>margin</i> .



4 Number Storage and Storage Register Arithmetic

Using Stored Numbers in Calculations

You can store numbers for reuse in several different ways:

- Use  (Constant) to store a number and its operator for repetitive operations.
- Use 3 Key Memory (, , and ) to store, recall, and sum numbers with a single keystroke.
- Use   and  to store to, and recall from, the 20 numbered registers.









Using Constants

Use  to store a number and arithmetic operator for repetitive calculations. Once the constant operation is stored, enter a number and press . The stored operation is performed on the number in the display.

Example 1

Calculate $5 + 2$, $6 + 2$, and $7 + 2$.













Table 4-1 Storing '+2' as constant

Keys	Display	Description
   	2.00	Stores + 2 as constant.
	7.00	Adds 5 + 2.
 	8.00	Adds 6 + 2.
 	9.00	Adds 7 + 2.

Example 2

Calculate $10 + 10\%$, $11 + 10\%$, and $25 + 10\%$.







Table 4-2 Storing '+ 10%' as a constant

Keys	Display	Description
      	1.00	Stores + 10% as a constant.
	11.00	Adds 10% to 10.
	12.10	Adds 10% to 11.
  	27.50	Adds 10% to 25.

Example 3

Calculate 2^3 and 4^3 .

Table 4-3 Storing 'y³' as a constant

Keys	Display	Description
   	3.00	Stores y^3 as constant.
	8.00	Calculates 2^3 .
 	64.00	Calculates 4^3 .

Example 4

Calculate the percent change between 55 and 32 and store it as a constant. Then calculate the percent change between 50 and 32, and 45 and 32.

Table 4-4 Calculating percent change

Keys	Display	Description
$\boxed{5}$ $\boxed{5}$ $\boxed{\rightarrow}$ $\boxed{\%CHG}$ $\boxed{3}$ $\boxed{2}$ \boxed{K}	32.00	Stores % change 32 as constant.
$\boxed{=}$	-41.82	Calculates the % change between 55 and 32.
$\boxed{5}$ $\boxed{0}$ $\boxed{=}$	-36.00	Calculates the % change between 50 and 32.
$\boxed{4}$ $\boxed{5}$ $\boxed{=}$	-28.89	Calculates the % change between 45 and 32.

All of the other two-number functions on the calculator may be used with \boxed{K} in the same manner as shown in example 4. For a complete list of two-number functions, refer to the section titled, *Two-Number Functions* in chapter 2.

Using the M Register

The $\boxed{-M}$, \boxed{RM} , and $\boxed{M+}$ keys perform memory operations on a single storage register, called the M register. In most cases, it is unnecessary to clear the M register, since $\boxed{-M}$ replaces the previous contents. However, you can clear the M register by pressing $\boxed{0}$ $\boxed{-M}$. To add a series of numbers to the M register, use $\boxed{-M}$ to store the first number and $\boxed{M+}$ to add subsequent numbers. To subtract the displayed number from the number in the M register, press $\boxed{+/-}$ followed by $\boxed{M+}$.























Table 4-5 Keys for performing memory operations

Keys	Description
$\boxed{-M}$	Stores displayed number in the M register.
\boxed{RM}	Recalls number from the M register.
$\boxed{M+}$	Adds displayed number to the M register.



Example



Use the M register to add 17, 14.25, and 16.95. Then subtract 4.65 and recall the result.

Table 4-6 Calculating basic arithmetic operations using M register

























Keys	Display	Description
  	17.00	Stores 17 in M register.
     	14.25	Adds 14.25 to M register.
     	16.95	Adds 16.95 to M register.
     	-4.65	Adds -4.65 to M register.
	43.55	Recalls contents of the M register.

Using Numbered Registers

The  and  keys access the 20 user registers, designated 0-19. The

 key is used to copy the displayed number to a designated register. The  key is used to copy a number from a register to the display.

To store or recall a number in two steps:

- Press  or . To cancel this step, press  or .
- Press  followed by a number key,  to , or  and  to , to store a number in the display into a numbered data storage register. Press   followed by  through  to access registers 10-19.
- Press  followed by a number key,  to , or  and  to , to recall a number from a storage register. Press   followed by  through  to access registers 10-19.

Example

In the following example, two storage registers are used. Set the calculator for **CHAIN** mode

() and calculate the following:

$$\frac{475.6}{39.15} \text{ and } \frac{560.1 + 475.6}{39.15}$$

Table 4-7 Calculating the expression using two storage registers

Keys	Display	Description
 	475.60	Stores 475.60 (displayed number) in R ₁₄ .
 	39.15	Stores 39.15 in R ₂ .
	12.15	Completes first calculation.
 	1,035.70	Recalls R ₁₄ . NOTE: If the calculator is set for Algebraic mode, press at the end of this step.
	39.15	Recalls R ₂ .
	26.45	Completes second calculation.

With the exception of the statistics registers, you can also use and for application registers. For example, stores the number from the display in the register. copies the contents from to the display.

In most cases, it is unnecessary to clear a storage register since storing a number replaces the previous contents. However, you can clear a single register by storing **0** in it. To clear all the registers at once, press .



Doing Arithmetic Inside Registers

You can do arithmetic inside storage registers R₀ through R₁₉. The result is stored in the register.

Table 4-8 Keys for performing arithmetic inside registers

Keys	New Number in Register
<i>register number</i>	Old contents + displayed number.
<i>register number</i>	Old contents - displayed number.
<i>register number</i>	Old contents × displayed number.

















Table 4-8 Keys for performing arithmetic inside registers

Keys	New Number in Register
   <i>register number</i>	Old contents ÷ displayed number.

Example 1

Store 45.7 in R₃, multiply by 2.5, and store the result in R₃.



















Table 4-9 Calculating and storing the result in the storage register

Keys	Display	Description
   	45.70	Stores 45.7 in R ₃ .
  		
  	2.50	Multiplies 45.7 in R ₃ by 2.5 and stores result (114.25) in R ₃ .
   		
 	114.25	Displays R ₃ .

Example 2

Store 1.25 into register 15, then add 3, and store the result in register 15.

Table 4-10 Storage register arithmetic

Keys	Display	Description
   	1.25	Inputs 1.25 into the display.
   	1.25	Stores 1.25 in R ₁₅ .
     	3.00	Adds 3 to 1.25 in R ₁₅ and stores the result R ₁₅ .
	0.00	Clears the display.
  	4.25	Recalls R ₁₅ .

5 Picturing Financial Problems

How to approach a Financial Problem

The financial vocabulary of the HP 10bII+ is simplified to apply to all financial fields. For example, your profession may use the term *balance*, *balloon payment*, *residual*, *maturity value*, or *remaining amount* to designate a value that the HP 10bII+ knows as FV (future value).

The simplified terminology of the HP 10bII+ is based on cash flow diagrams. Cash flow diagrams are pictures of financial problems that show cash flows over time. Drawing a cash flow diagram is the first step to solving a financial problem.

The following cash flow diagram represents investments in a mutual fund. The original investment was 7,000.00, followed by investments of 5,000.00 and 6,000.00 at the end of the third and sixth months. At the end of the 11th month, 5,000.00 was withdrawn. At the end of the 16th month, 16,567.20 was withdrawn.

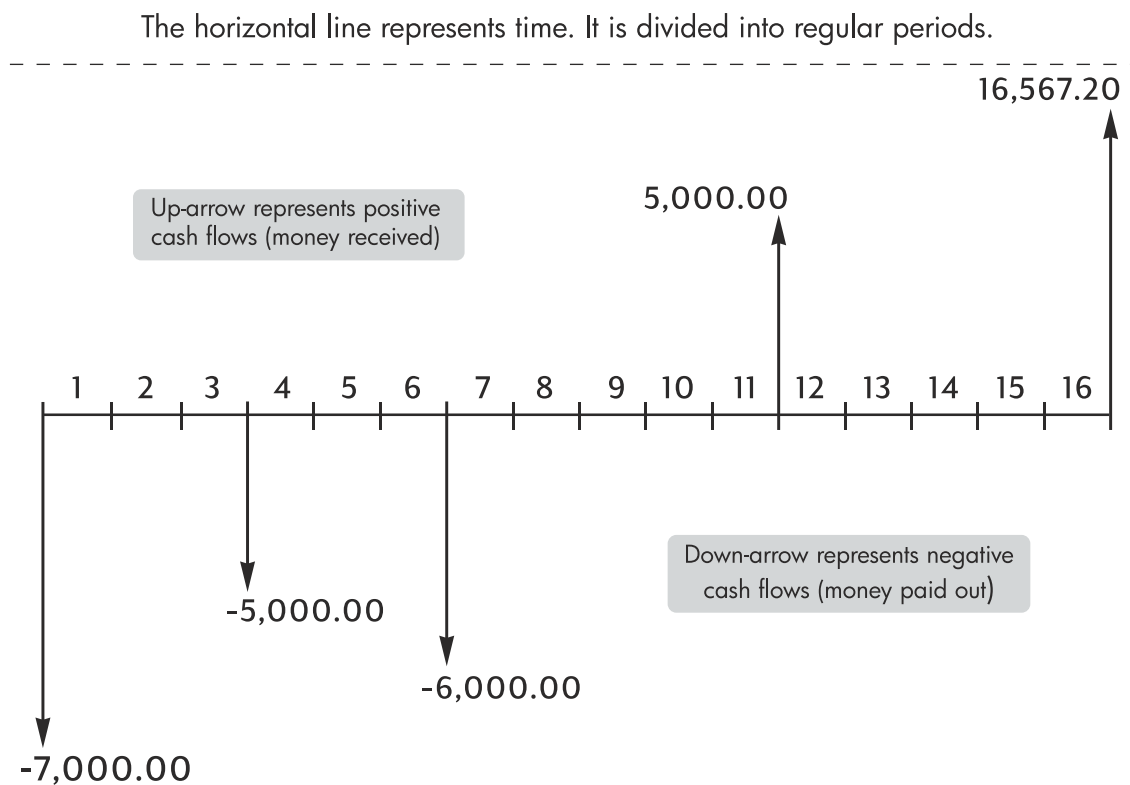

Figure 2 Cash flow diagram

Any cash flow example can be represented by a cash flow diagram. As you draw a cash flow diagram, identify what is known and unknown about the transaction.

Time is represented by a horizontal line divided into regular time periods. Cash flows are placed on the horizontal line when they occur. Where no arrows are drawn, no cash flows occur.

Signs of Cash Flows

In cash flow diagrams, money invested is shown as negative and money withdrawn is shown as positive. Cash flowing *out* is *negative*, cash flowing *in* is *positive*.

For example, from the lender's perspective, cash flows to customers for loans are represented as negative. Likewise, when a lender receives money from customers, cash flows are represented as positive. In contrast, from the borrower's perspective, cash borrowed is positive while cash paid back is negative.

Periods and Cash Flows

In addition to the sign convention (cash flowing out is negative, cash flowing in is positive) on cash flow diagrams, there are several more considerations:

- The time line is divided into equal time intervals. The most common period is a month, but days, quarters, and annual periods are also common. The period is normally defined in a contract and must be known before you can begin calculating.
- To solve a financial problem with the HP 10bII+, all cash flows must occur at either the beginning or end of a period.
- If more than one cash flow occurs at the same place on the cash flow diagram, they are added together or netted. For example, a negative cash flow of -250.00 and a positive cash flow of 750.00 occurring at the same time on the cash flow diagram are entered as a 500.00 cash flow ($750 - 250 = 500$).
- A valid financial transaction must have at least one positive and one negative cash flow.

Simple and Compound Interest

Financial calculations are based on the fact that money earns interest over time. There are two types of interest:

- Simple interest
- Compound interest

The basis for Time Value of Money and cash flow calculations is compound interest.

Simple Interest

In simple-interest contracts, interest is a percent of the original principal. The interest and principal are due at the end of the contract. For example, say you loan 500 to a friend for a year, and you want to be repaid with 10% simple interest. At the end of the year, your friend owes you 550.00 (50 is 10% of 500). Simple interest calculations are done using the  key on your HP 10bII+. An example of a simple interest calculation can be found in chapter 6 under the section titled, *Interest Rate Conversions*.

Compound Interest

A compound-interest contract is like a series of simple-interest contracts that are connected. The length of each simple-interest contract is equal to one compounding period. At the end of each period the interest earned on each simple-interest contract is added to the principal. For example, if you deposit 1,000.00 in a savings account that pays 6% annual interest, compounded monthly, your earnings for the first month look like a simple-interest contract written for 1 month at $\frac{1}{2}\%$ ($6\% \div 12$). At the end of the first month the balance of the account is 1,005.00 (5 is $\frac{1}{2}\%$ of 1,000).

The second month, the same process takes place on the new balance of 1,005.00. The amount of interest paid at the end of the second month is $\frac{1}{2}\%$ of 1,005.00, or 5.03. The compounding process continues for the third, fourth, and fifth months. The intermediate results in this illustration are rounded to dollars and cents.

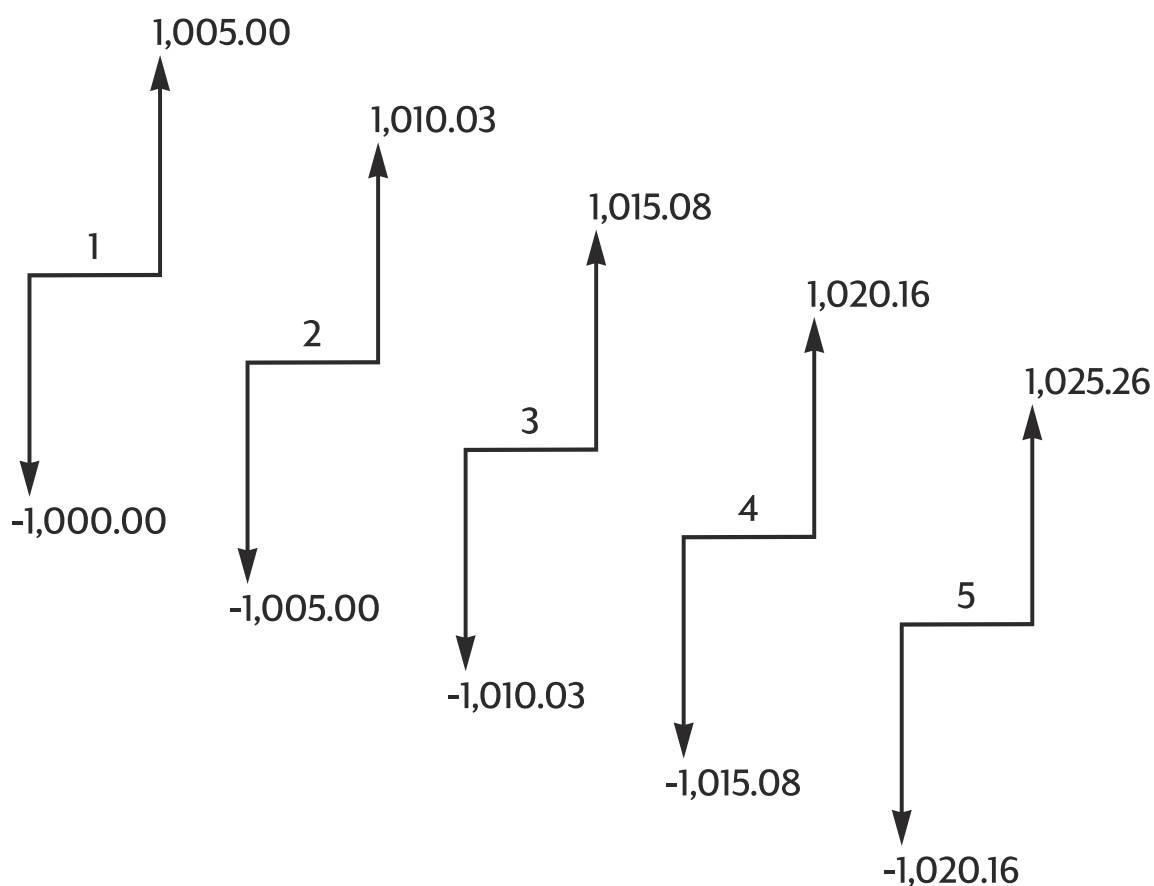

Figure 3 Annual interest compounded monthly

The word *compound* in compound interest comes from the idea that interest previously earned or owed is added to the principal. Thus, it can earn more interest. The financial calculation capabilities of the HP 10bII+ are based on compound interest.

Interest Rates

When you approach a financial problem, it is important to recognize that the interest rate or rate of return can be described in at least three different ways:

- As a periodic rate. This is the rate that is applied to your money from period to period.
- As an annual nominal rate. This is the periodic rate multiplied by the number of periods in a year.
- As an annual effective rate. This is an annual rate that considers compounding.

In the previous example of a 1,000.00 savings account, the periodic rate is $\frac{1}{2}\%$ (per month), quoted as an annual nominal rate of 6% ($\frac{1}{2} \times 12$). This same periodic rate could be quoted as an annual effective rate, which considers compounding. The balance after 12 months of compounding is 1,061.68, which means the annual effective interest rate is 6.168%.

Examples of converting between nominal and annual effective rates can be found in the section titled, Interest Rate Conversions in the next chapter.

Two Types of Financial Problems

The financial problems in this manual use compound interest unless specifically stated as simple interest calculations. Financial problems are divided into two groups:

- TVM problems
- Cash flow problems

Recognizing a TVM Problem

If uniform cash flows occur between the first and last periods on the cash flow diagram, the financial problem is a TVM (time value of money) problem. There are five main keys used to solve a TVM problem.

Table 5-1 Keys for solving a TVM problem

Keys	Description
<input type="text" value="N"/>	Number of periods or payments
<input type="text" value="I/YR"/>	Annual percentage interest rate (usually the annual nominal rate)
<input type="text" value="PV"/>	Present value (the cash flow at the beginning of the time line)
<input type="text" value="PMT"/>	Periodic payment
<input type="text" value="FV"/>	Future value (the cash flow at the end of the cash flow diagram, in addition to any regular periodic payment).

You can calculate any value after entering the other four values. Cash flow diagrams for loans, mortgages, leases, savings accounts, or any contract with regular cash flows of the same amount are normally treated as TVM problems.

For example, following is a cash flow diagram, from the borrower's perspective, for a 30-year, 150,000.00 mortgage, with a payment of 1,041.40, at 7.5% annual interest, with a 10,000 balloon payment.

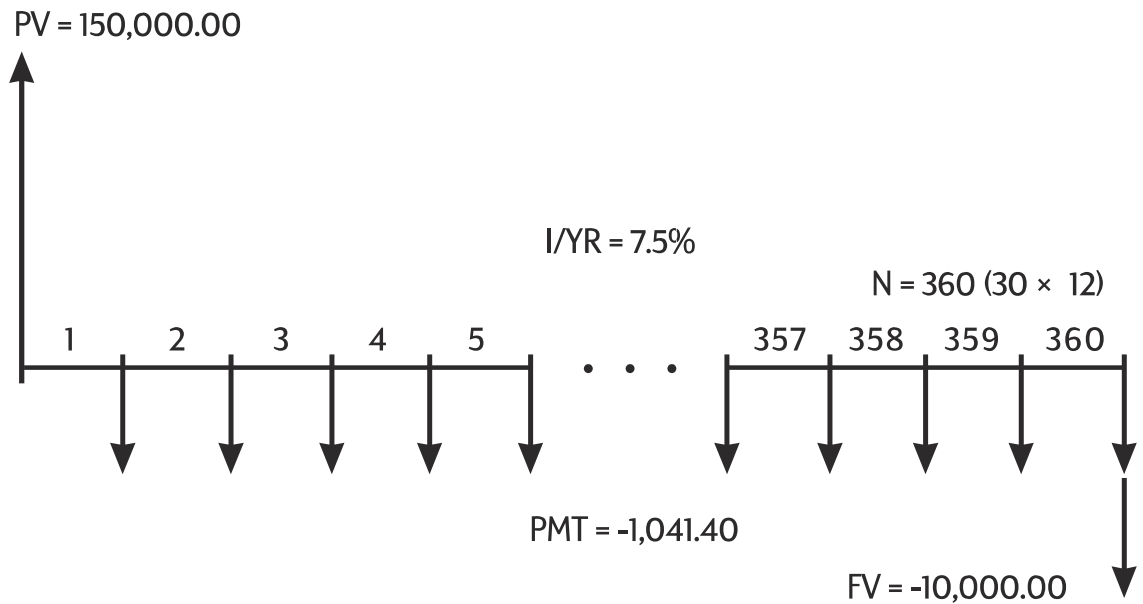

Figure 4 Cash flow diagram (Borrower's perspective)

One of the values for PV , PMT , FV can be zero. For example, following is a cash flow diagram (from the saver's perspective) for a savings account with a single deposit and a single withdrawal five years later. Interest compounds monthly. In this example, PMT is zero.

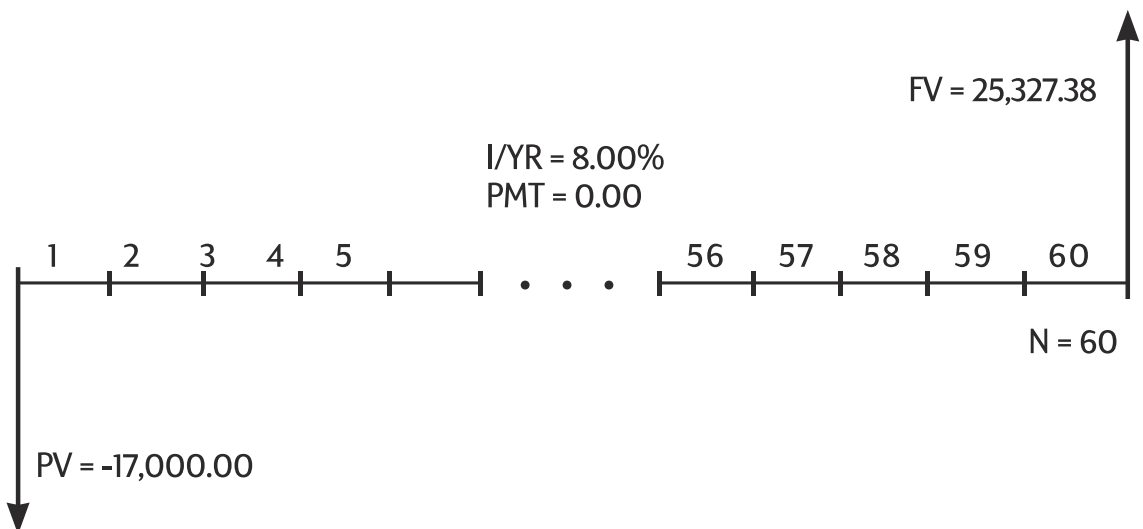

Figure 5 Cash flow diagram (Saving perspective)

Time value of money calculations are described in the next chapter titled, Time Value of Money Calculations.

Recognizing a Cash Flow Problem

A financial problem that does not have regular, uniform payments (sometimes called *uneven* cash flows) is a cash flow problem rather than a TVM problem.

The following is a cash flow diagram for an investment in a mutual fund. This is an example of a problem that is solved using either ^{PRC} ^{CST} (Net Present Value) or ^{IRR/YR} (Internal Rate of Return per Year).

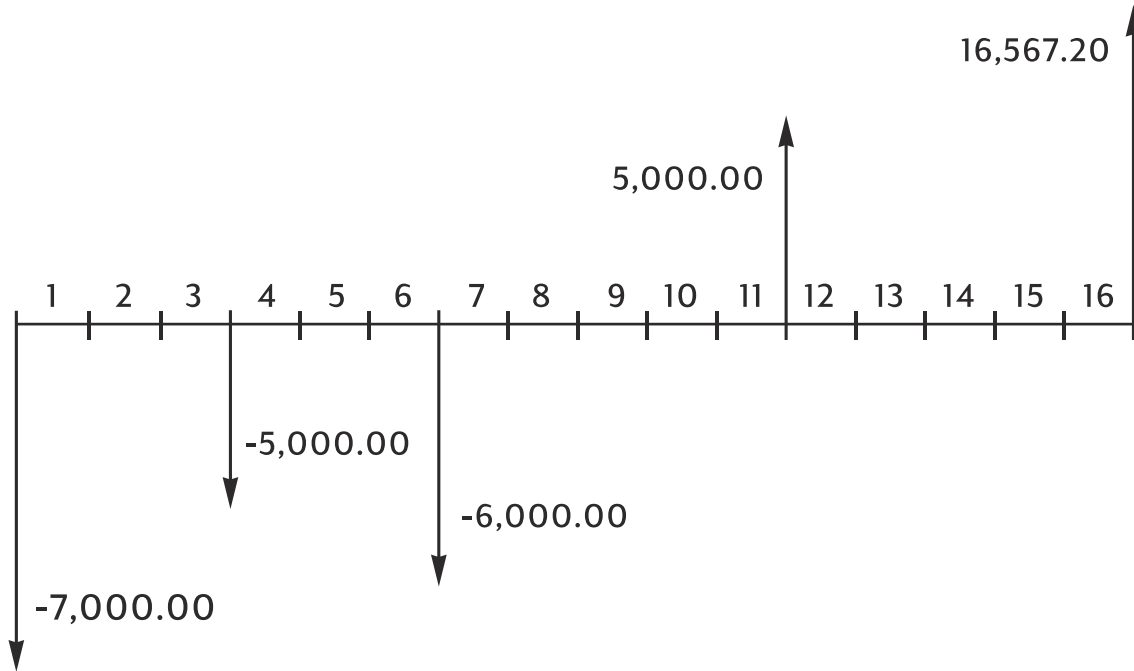

Figure 6 Cash flow diagram (Investment in a mutual fund)







Cash flow problems are described in chapter 8 titled, *Cash Flow Calculations*.

6 Time Value of Money Calculations

Using the TVM Application

The time value of money (TVM) application is used for compound interest calculations that involve regular, uniform cash flows – called *payments*. Once the values are entered you can vary one value at a time, without entering all the values again.

To use TVM, several prerequisites must be met:

- The amount of each payment must be the same. If the payment amounts vary, use the procedures described in chapter 8 titled, *Cash Flow Calculations*.
- Payments must occur at regular intervals.
- The payment period must coincide with the interest compounding period. If it does not, convert the interest rate using the  ,  , and   keys described below in the section titled, *Interest Rate Conversions*.
- There must be at least one positive and one negative cash flow.

The TVM Keys

When entering data for TVM calculations, results are calculated based on data entered into specific memory registers. When pressed, the keys used for these operations:

- store data.
- enter known data for variables used during calculations.
- calculate unknown variables based on stored data.

Table 6-1 Keys for performing TVM calculations





























Keys	Stores or Calculates
	Number of payments or compounding periods.
	Annual nominal interest rate.
	Present value of future cash flows. <i>PV</i> is usually an initial investment or loan amount and always occurs at the beginning of the first period.
	Amount of periodic payments. All payments are equal, and none are skipped; payments can occur at the beginning or end of each period.
	Future value. <i>FV</i> is either a final cash flow or compounded value of a series of previous cash flows. <i>FV</i> occurs at the end of the last period.
 	Stores the number of periods per year. The default is 12. Reset only when you wish to change it.
 	Optional shortcut for storing <i>N</i> : number in display is multiplied by the value in <i>P/YR</i> and the result is stored in <i>N</i> .

Table 6-1 Keys for performing TVM calculations



Keys	Stores or Calculates
 	Switches between Begin and End mode. In Begin mode, the BEGIN annunciator is displayed.
 	Calculates an amortization table.

To verify values, press  ,  ,  ,  , and  .

Pressing    recalls the total number of payments in years and    shows you the number of payments per year. Recalling these numbers does not change the content of the registers.

Begin and End Modes

Before you start a TVM calculation, identify whether the first periodic payment occurs at the beginning or end of the first period. If the first payment occurs at the end of the first period, set your HP 10bII+ to End mode; if it occurs at the beginning of the first period, set your calculator to Begin mode.

To switch between modes, press  . The **BEGIN** annunciator is displayed when your calculator is in *Begin* mode. No annunciator is displayed when you are in End mode.

Mortgages and loans typically use End mode. Leases and savings plans typically use Begin mode.

Loan Calculations

Example: A Car Loan

You are financing a new car with a three year loan at 10.5% annual nominal interest, compounded monthly. The price of the car is 14,500. Your down payment is 1,500.

Part 1

What are your monthly payments at 10.5% interest? (Assume your payments start one month after the purchase or at the end of the first period.)

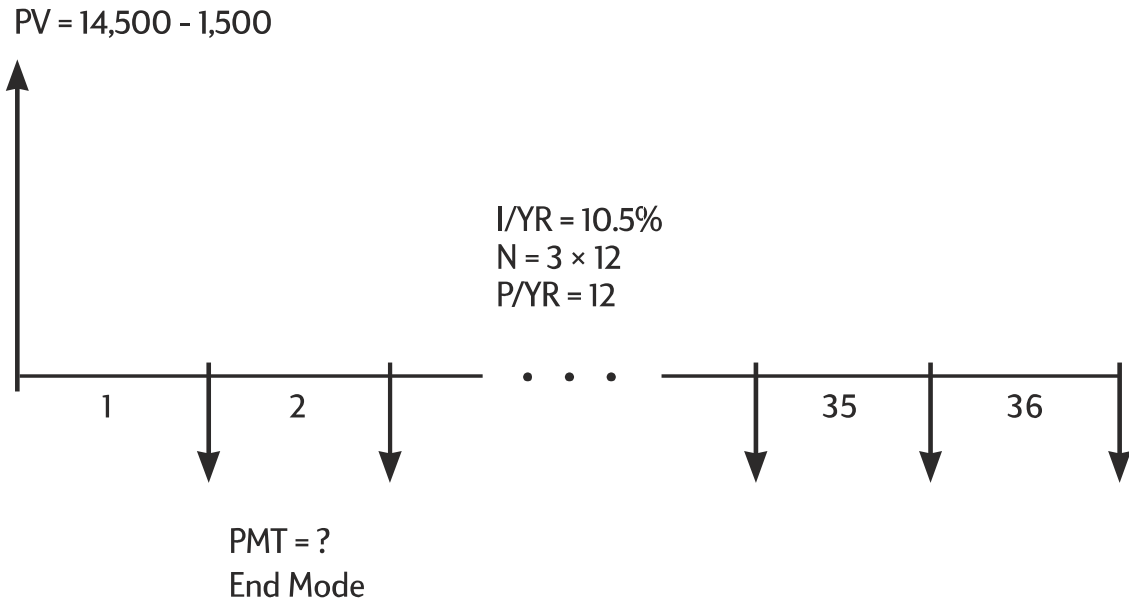

Figure 7 Cash flow diagram (Calculate PMT)

Set to End mode. Press if **BEGIN** annunciator is displayed.

Table 6-2 Calculating the monthly payment

Keys	Display	Description
	12.00	Sets periods per year (optional, as 12 is the default).
	36.00	Stores number of periods in loan.
	10.50	Stores annual nominal interest rate.
	13,000.00	Stores amount borrowed.
	0.00	Stores the amount left to pay after 3 years.
	-422.53	Calculates the monthly payment. The negative sign indicates money paid out.

Part 2

At a price of 14,500, what interest rate is necessary to lower your payment by 50.00, to 372.53?

Table 6-3 Calculating the interest rate

Keys	Display	Description
$\boxed{+}$ $\boxed{5}$ $\boxed{0}$ $\boxed{\text{PMT}}$	-372.53	Decreases payment from 422.53.
$\boxed{\text{I/YR}}$	2.03	Calculates annual interest rate for the reduced payment.

Part 3

If interest is 10.5%, what is the maximum you can spend on the car to lower your car payment to 375.00?

Table 6-4 Calculating the amount

Keys	Display	Description
$\boxed{1}$ $\boxed{0}$ $\boxed{\cdot}$ $\boxed{5}$ $\boxed{\text{I/YR}}$	10.50	Stores original interest rate.
$\boxed{3}$ $\boxed{7}$ $\boxed{5}$ $\boxed{+/-}$ $\boxed{\text{PMT}}$	-375.00	Stores desired payment.
$\boxed{\text{PV}}$	11,537.59	Calculates amount of money to finance.
$\boxed{+}$ $\boxed{1}$ $\boxed{5}$ $\boxed{0}$ $\boxed{0}$ $\boxed{=}$	13,037.59	Adds the down payment to the amount financed for total price of the car.

Example: A Home Mortgage

You decide that the maximum monthly mortgage payment you can afford is 930.00. You can make a 12,000 down payment, and annual interest rates are currently 7.5%. If you obtain a 30 year mortgage, what is the maximum purchase price you can afford?

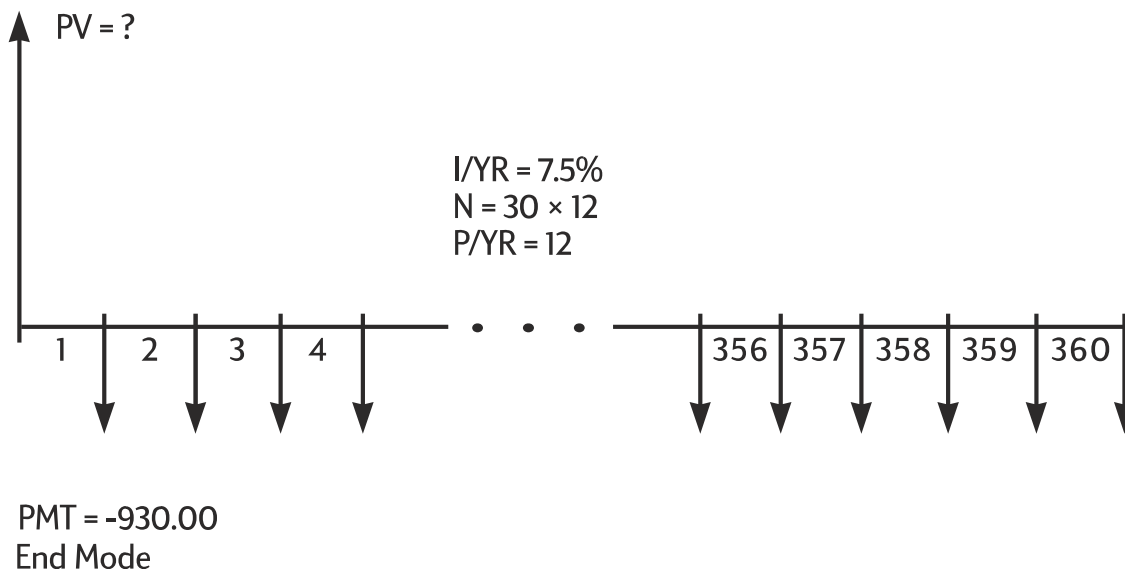

Figure 8 Cash flow diagram (Calculate PV)





























Set to End mode. Press   if **BEGIN** annunciator is displayed.

Table 6-5 Calculating the maximum purchase price

Keys	Display	Description
   	12.00	Sets periods per year.
   	360.00	Stores the length of the mortgage (30 × 12).
 	0.00	Pays mortgage off in 30 years.
   	7.50	Stores interest rate.
    	-930.00	Stores desired payment (money paid out is negative).
	133,006.39	Calculates the loan you can afford with a 930 payment.
      	145,006.39	Adds 12,000 down payment for the total purchase price.

Example: A Mortgage With a Balloon Payment

You've obtained a 25 year, 172,500 mortgage at 8.8% annual interest. You anticipate that you will own the house for four years and then sell it, repaying the loan with a balloon payment. What will your balloon payment be?

Solve this problem using two steps:

1. Calculate the loan payment using a 25 year term.
2. Calculate the remaining balance after 4 years.

Step 1

First calculate the loan payment using a 25 year term.

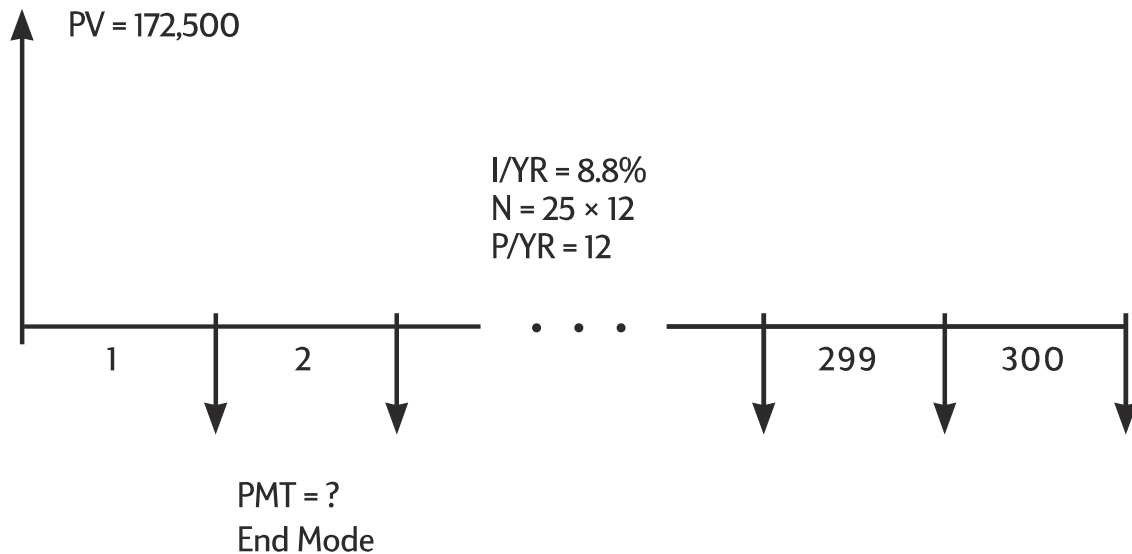

























Figure 9 Cash flow diagram (Calculate PMT)

Set to End mode. Press   if **BEGIN** annunciator is displayed.

Table 6-6 Calculating the monthly payment

Keys	Display	Description
    	12.00	Sets periods per year.
    	300.00	Stores length of mortgage ($25 \times 12 = 300$ months).
 	0.00	Stores loan balance after 25 years.
      	172,500.00	Stores original loan balance.
   	8.80	Stores annual interest rate.
	-1,424.06	Calculates the monthly payment.

Step 2

Since the payment is at the end of the month, the past payment and the balloon payment occur at the same time. The final payment is the sum of PMT and FV .

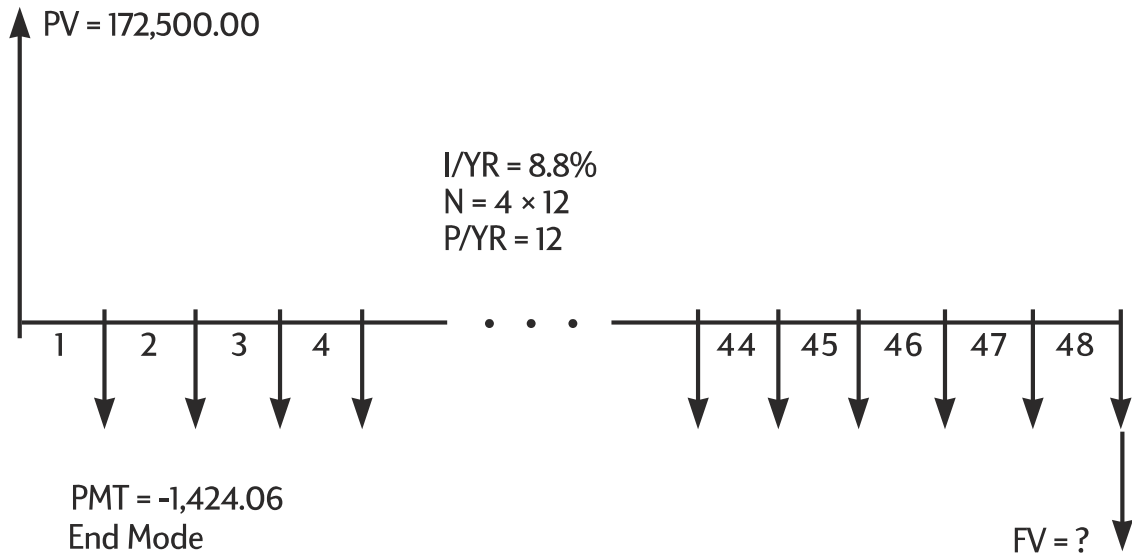

Figure 10 Cash flow diagram (Calculate FV)

The value in *PMT* should always be rounded to two decimal places when calculating *FV* or *PV* to avoid small, accumulative discrepancies between non-rounded numbers and actual (dollars and cents) payments. If the display is not set to two decimal places, press



Table 6-7 Calculating the final amount

Keys	Display	Description
	-1,424.06	Rounds payment to two decimal places, then stores.
	48.00	Stores four year term (12 × 4) that you expect to own house.
	-163,388.39	Calculates loan balance after four years.
	-164,812.45	Calculates the total 48 th payment (<i>PMT</i> and <i>FV</i>) to pay off the loan (money paid out is negative).

Savings Calculations

Example: A Savings Account

If you deposit 2,000 in a savings account that pays 7.2% annual interest compounded annually, and make no other deposits to the account, how long will it take for the account to grow to 3,000?

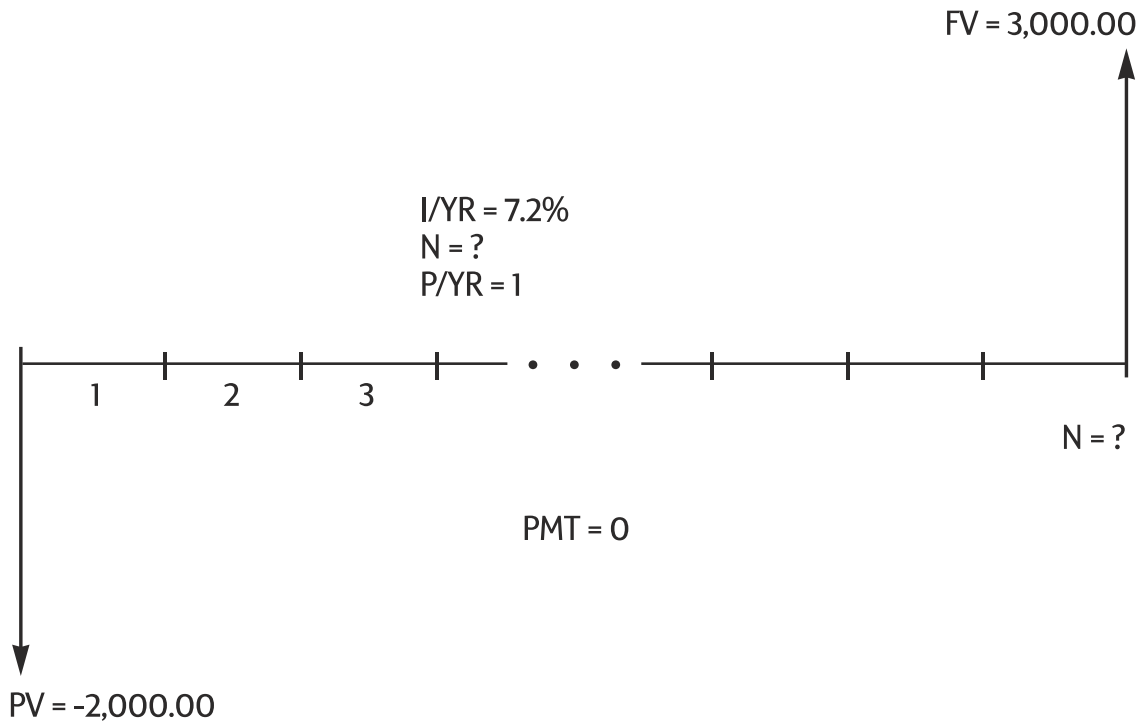























Figure 11 Cash flow diagram (Calculate the number of years)

Since this account has no regular payments ($PMT = 0$), the payment mode (End or Begin) is irrelevant.

Table 6-8 Calculating the number of years

Keys	Display	Description
  	0.00	Clears TVM memory.
  	1.00	Sets P/YR to 1 since interest is compounded annually.
     	-2,000.00	Stores amount paid out for the first deposit.
    	3,000.00	Stores the amount you wish to accumulate.
   	7.20	Stores annual interest rate.
	5.83	Calculates the number of years it takes to reach 3,000.

Since the calculated value of N is between 5 and 6, it will take six years of annual compounding to achieve a balance of at *least* 3,000. Calculate the actual balance at the end of six years.

Table 6-9 Calculating the balance after six years

Keys	Display	Description
$\boxed{6}$ \boxed{N}	6.00	Sets n to 6 years.
\boxed{FV}	3,035.28	Calculates the amount you can withdraw after six years.

Example: An Individual Retirement Account

You opened an individual retirement account on April 14, 1995, with a deposit of 2,000. 80.00 is deducted from your paycheck and you are paid twice a month. The account pays 6.3% annual interest compounded semimonthly. How much will be in the account on April 14, 2010?

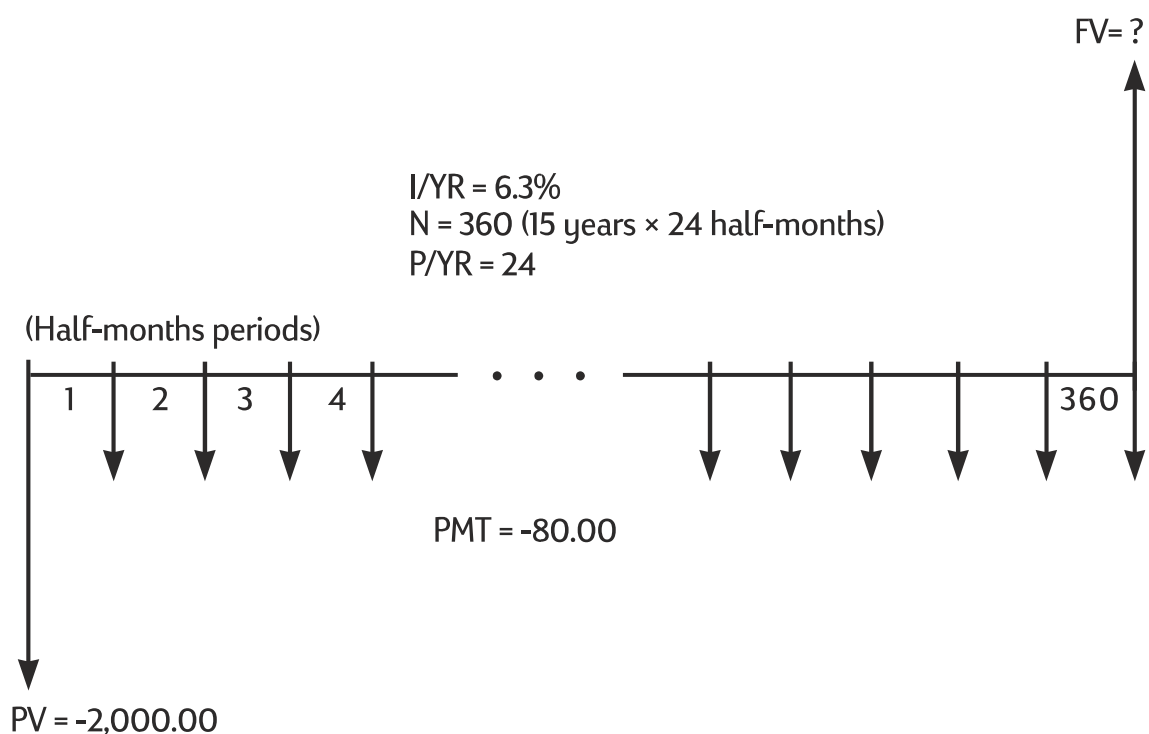

Figure 12 Cash flow diagram (Calculate FV)

Set to End mode. Press $\boxed{\downarrow}$ $\boxed{\text{MAR}}$ $\boxed{\text{Beg/End}}$ if **BEGIN** annunciator is displayed.

Table 6-10 Calculating the balance amount

Keys	Display	Description
$\boxed{2}$ $\boxed{4}$ $\boxed{\downarrow}$ $\boxed{\text{PMT}}$ $\boxed{\text{P/YR}}$	24.00	Sets number of periods per year.
$\boxed{2}$ $\boxed{0}$ $\boxed{0}$ $\boxed{0}$ $\boxed{+/-}$ $\boxed{\text{PV}}$	-2,000.00	Stores initial deposit.
$\boxed{8}$ $\boxed{0}$ $\boxed{+/-}$ $\boxed{\text{PMT}}$	-80.00	Stores regular semimonthly deposits.

Table 6-10 Calculating the balance amount

Keys	Display	Description
6 . 3 I/YR	6.30	Stores interest rate.
1 5 [↓] N xP/YR	360.00	Stores the number of deposits.
FV	52,975.60	Calculates the balance amount.

Example: An Annuity Account

You opt for an early retirement after a successful business career. You have accumulated a savings of 400,000 that earns an average of 7% annual interest, compounded monthly. What annuity (repetitive, uniform, withdrawal of funds) will you receive at the beginning of each month if you wish that savings account to support you for the next 50 years?

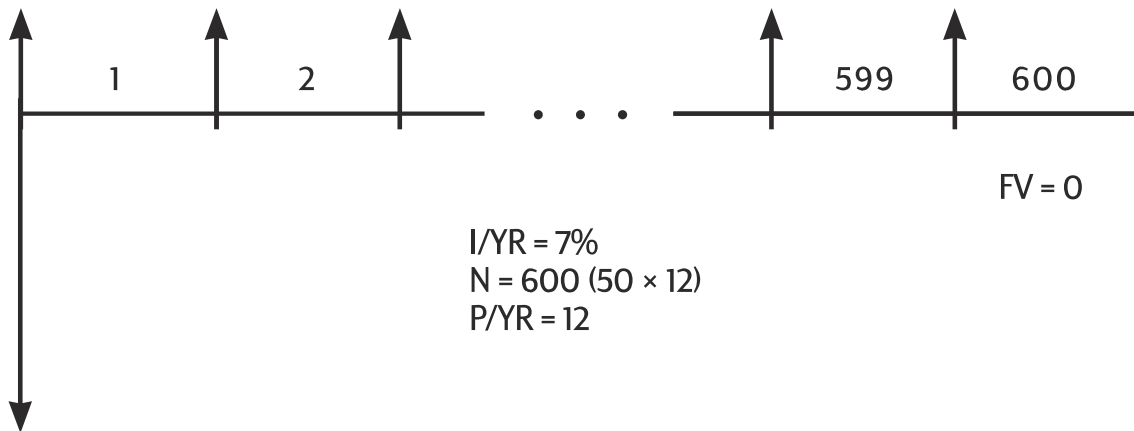

Figure 13 Cash flow diagram (Calculate the amount)

Set to Begin mode. Press [↓] [MAR] [Beg/End] if **BEGIN** annunciator is **not** displayed.

Table 6-11 Calculating the amount at the beginning of each month

Keys	Display	Description
1 2 [↓] PMT P/YR	12.00	Sets payments per year.
4 0 0 0 0 0 +/- PV	-400,000.00	Stores your nest egg as an outgoing deposit.
7 I/YR	7.00	Stores annual interest rate you expect to earn.
5 0 [↓] N xP/YR	600.00	Stores number of withdrawals.
0 FV	0.00	Stores balance of account after 50 years.
PMT	2,392.80	Calculates the amount that you can withdraw at the beginning of each month.

Lease Calculations

A lease is a loan of valuable property (like real estate, automobiles, or equipment) for a specific amount of time, in exchange for regular payments. Some leases are written as purchase agreements, with an option to buy at the end of the lease (sometimes for as little as 1.00). The defined future value (FV) of the property at the end of a lease is sometimes called the *residual value* or *buy out value*.

All five TVM application keys can be used in lease calculations. There are two common lease calculations.

- Finding the lease payment necessary to achieve a specified yield.
- Finding the present value (capitalized value) of a lease.

The first payment on a lease usually occurs at the beginning of the first period. Thus, most lease calculations use Begin mode.

Example: Calculating a Lease Payment

A customer wishes to lease a 13,500 car for three years. The lease includes an option to buy the car for 7,500 at the end of the lease. The first monthly payment is due the day the customer drives the car off the lot. If you want to yield 10% annually, compounded monthly, what will the payments be? Calculate the payments from your (the dealer's) point of view.

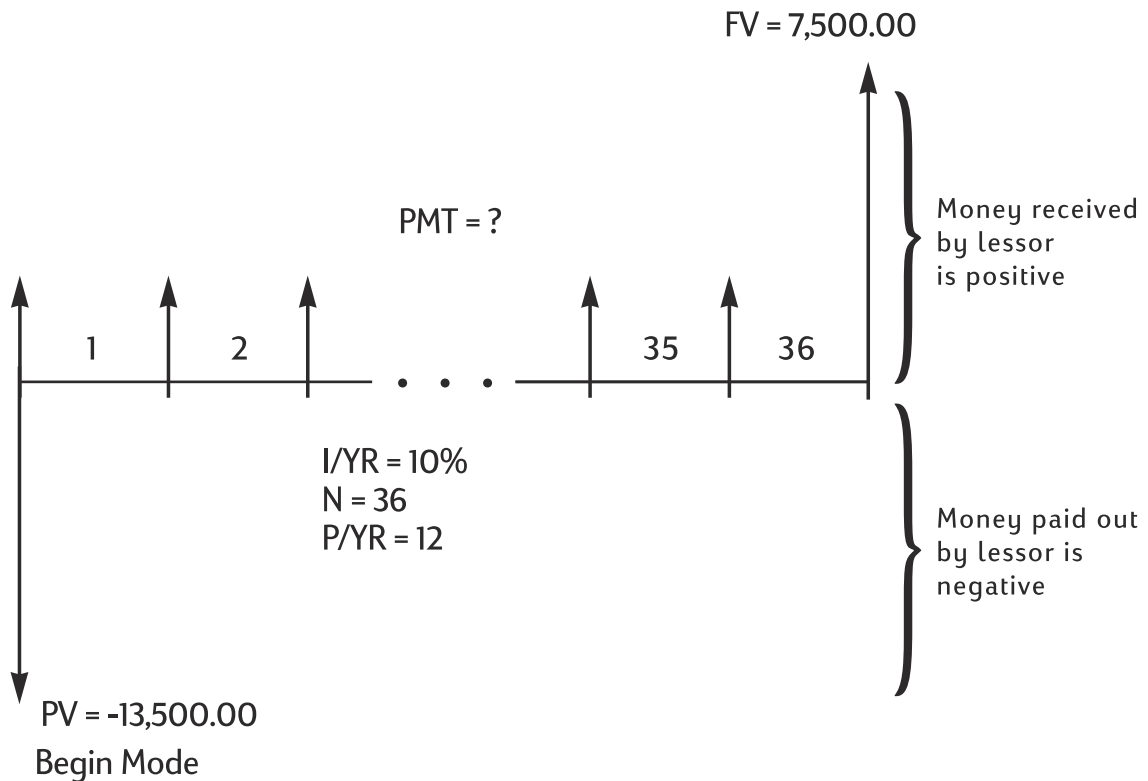

Figure 14 Cash flow diagram (Calculate the monthly lease payment)



Set to Begin mode. Press   if **BEGIN** annunciator is **not** displayed.

Table 6-12 Calculating the monthly lease payment

Keys	Display	Description
1 2 PMT P/YR	12.00	Sets payments per year.
1 0 I/YR	10.00	Stores desired annual yield.
1 3 5 0 0 +/- PV	-13,500.00	Stores lease price.
7 5 0 0 FV	7,500.00	Stores residual (buy out value).
3 6 N	36.00	Stores length of lease, in months.
PMT	253.99	Calculates the monthly lease payment.

Notice that even if the customer chooses not to buy the car, the lessor still includes a cash flow coming in at the end of the lease equal to the residual value of the car. Whether the customer buys the car or it is sold on the open market, the lessor expects to recover 7,500.

Example: Lease With Advance Payments

Your company, Quick-Kit Pole Barns, plans to lease a forklift for the warehouse. The lease is written for a term of four years with monthly payments of 2,400. Payments are due at the beginning of the month with the first and last payments due at the onset of the lease. You have an option to buy the forklift for 15,000 at the end of the leasing period.

If the annual interest rate is 9%, what is the capitalized value of the lease?

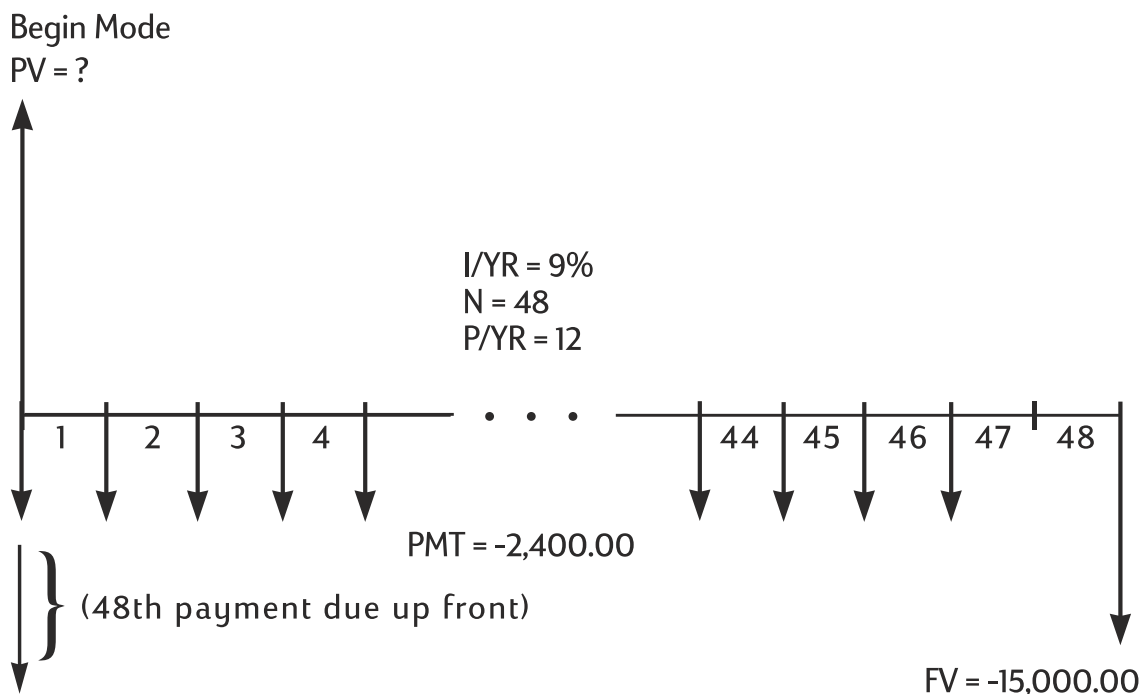

Figure 15 Cash flow diagram (Calculate PV of the lease)

This solution requires four steps:

1. Calculate the present value of the 47 monthly payments: $(4 \times 12) - 1 = 47$.
2. Add the value of the additional advance payment.
3. Find the present value of the buy option.
4. Sum the values calculated in steps 2 and 3.

Step 1

Find the present value of the monthly payments.





















Set to Begin mode. Press   if **BEGIN** annunciator is **not** displayed.







Table 6-13 Calculating the present value

Keys	Display	Description
   	12.00	Sets payments per year.
  	47.00	Stores number of payments.
     	-2,400.00	Stores monthly payment.
 	0.00	Stores <i>FV</i> for Step 1.
 	9.00	Stores interest rate.
	95,477.55	Calculates the present value of 47 monthly payments.

Step 2

Add the additional advance payment to *PV*. Store the answer.

Table 6-14 Adding the advance payment

Keys	Display	Description
    	97,877.55	Adds additional advance payment
	97,877.55	Stores result in <i>M</i> register.

Step 3

Find the present value of the buy option.

Table 6-15 Calculating the present value of the last cash flow



Keys	Display	Description
  	48.00	Stores month when buy option occurs.

Table 6-15 Calculating the present value of the last cash flow

Keys	Display	Description
<input type="text" value="0"/> <input type="text" value="PMT"/>	0.00	Stores zero payment for this step of solution.
<input type="text" value="1"/> <input type="text" value="5"/> <input type="text" value="0"/> <input type="text" value="0"/> <input type="text" value="0"/> <input type="text" value="+/-"/> <input type="text" value="FV"/>	-15,000.00	Stores value to discount.
<input type="text" value="PV"/>	10,479.21	Calculates the present value of last cash flow.

Step 4

Add the results of 'Step 2' and 'Step 3'.

Table 6-16 Calculating the present value of lease

Keys	Display	Description
<input type="text" value="+"/> <input type="text" value="RM"/> <input type="text" value="="/>	108,356.77	Calculates the present (capitalized) value of lease. (Rounding discrepancies are explained on page 67.)

Amortization

Amortization is the process of dividing a payment into the amount that applies to interest and the amount that applies to principal. Payments near the beginning of a loan contribute more interest, and less principal, than payments near the end of a loan.

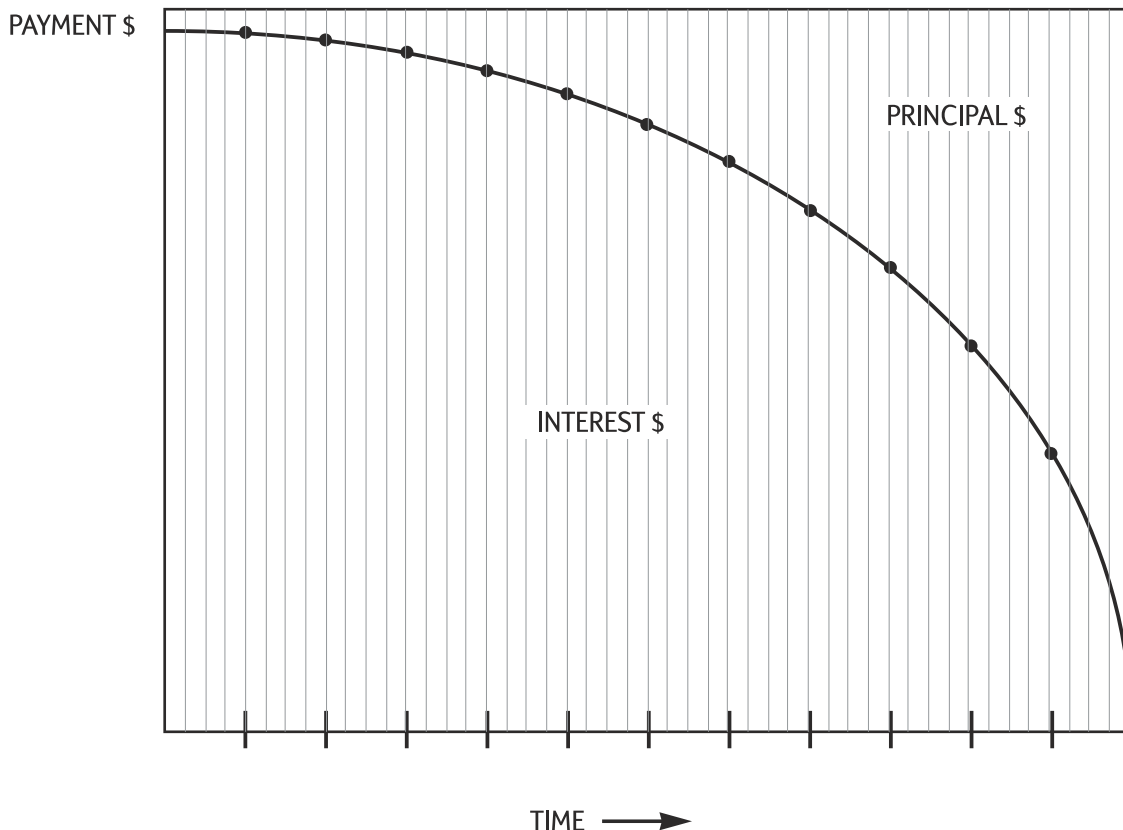

Figure 16 Graph

The AMORT key on the HP 10bII+ allows you to calculate.

- The amount applied to *interest* in a range of payments.
- The amount applied to *principal* in a range of payments.
- The *loan balance* after a specified number of payments are made.











The   function assumes you have just calculated a payment or you have stored the appropriate amortization values in *I/YR*, *PV*, *FV*, *PMT*, and *P/YR*.



Table 6-17 Keys for storing the amortization values





Keys	Description
	Annual nominal interest rate.
	Starting balance.
	Ending balance.
	Payment amount (rounded to the display format).
 	Number of payments per year.



The numbers displayed for interest, principal, and balance are rounded to the current display setting.





To Amortize

To amortize a single payment, enter the period number and press  . The HP 10bII+ displays the annunciator **PER** followed by the starting and ending payments that will be amortized.

Press  to see interest (**INT**). Press  again to see the principal (**PRIN**) and again to see the balance (**BAL**). Continue pressing  to cycle through the same values again.

To amortize a range of payments, enter *starting period number*  *ending period number*, then press  . The HP 10bII+ displays the annunciator **PER** followed by the starting and ending payments that will be amortized. Then press  repeatedly to cycle through interest, principal, and balance.

Press   again to move to the next set of periods. This auto-increment feature saves you the keystrokes of entering the new starting and ending periods.

If you store, recall, or perform any other calculations during amortization, pressing  will no longer cycle through interest, principal, and balance. To resume amortization with the same set of periods, press   .

Example: Amortizing a Range of Payments

Calculate the first two years of the annual amortization schedule for a 30 year, 180,000 mortgage, at 7.75% annual interest with monthly payments.



































Set to End mode. Press   if **BEGIN** annunciator is displayed.

Table 6-18 Calculating the monthly payment

Keys	Display	Description
   	12.00	Sets payments per year.
   	360.00	Stores total number of payments.
    	7.75	Stores interest per year.
      	180,000.00	Stores present value.
 	0.00	Stores future value.
	-1,289.54	Calculates the monthly payment.

If you already know the mortgage payment, you can enter and store it just like you store the other four values. Next, amortize the first year.











Table 6-19 Calculating the loan balance after a year

Keys	Display	Description
   	12_	Enters starting and ending periods.
 	1- 12	Displays the PER and AMORT annunciators and range.
	-1,579.84	Displays the PRIN annunciator and the principal paid in the first year.
	-13,894.67	Displays the INT annunciator and the interest paid in the first year.
	178,420.16	Displays the BAL annunciator and the loan balance after one year.

The amount paid toward interest and principal ($13,894.67 + 1,579.84 = 15,474.51$) equals the total of 12 monthly payments ($12 \times 1,289.54 = 15,474.51$). The remaining balance equals the initial mortgage, less the amount applied toward principal ($180,000 - 1,579.84 = 178,420.16$).

Amortize the second year:

Table 6-20 Calculating the remaining balance

Keys	Display	Description
    	13 – 24	Displays PER and the next range of periods.
  		
	-1,706.69	Displays PRIN and the principal paid in the second year.
	-13,767.79	Displays INT and the interest paid in the second year.
	176,713.49	Displays BAL and the loan balance after 24 payments.

The amount paid toward interest and principal ($13,767.79 + 1,706.69 = 15,474.51$) equals the total of 12 monthly payments ($12 \times 1,289.54 = 15,474.51$). The remaining balance equals the initial mortgage less the amount applied toward principal ($180,000 - 1,579.84 - 1,706.69 = 176,713.49$). More money is applied to principal during the second year rather than the first year. The succeeding years continue in the same fashion.

Example: Amortizing a Single Payment

Amortize the 1st, 25th, and 54th payments of a five year car lease. The lease amount is 14,250 and the interest rate is 11.5%. Payments are monthly and begin immediately.



Set to Begin mode. Press   if **BEGIN** annunciator is **not** displayed.

Table 6-21 Calculating the monthly payment























Keys	Display	Description
    	12.00	Sets payments per year.
   	60.00	Stores number of payments.
    	11.50	Stores interest per year.
     	14,250.00	Stores present value.
 	0.00	Stores future value.

Table 6-21 Calculating the monthly payment







Keys	Display	Description
	-310.42	Calculates the monthly payment.

Amortize the 1st, 25th, and 54th payments







Table 6-22 Calculating the amount

Keys	Display	Description
	1.00	Enters first payment.
	1 – 1	Displays PER and the amortized payment period.
	-310.42	Displays PRIN and the first principal payment.
	0.00	Displays INT and the interest.
	13,939.58	Displays BAL and the loan balance after one payment.
	25.00	Enters payment to amortize.
	25 – 25	Displays PER and the amortized payment period.
	-220.21	Displays PRIN and the principal paid on the 25 th payment.
	-90.21	Displays INT and the interest paid on the 25 th payment.
	9,193.28	Displays BAL and the balance after the 25 th payment.
	54.00	Enters payment to amortize.
	54 – 54	Displays PER and the amortized payment period.
	-290.37	Displays PRIN and the principal paid on the 54 th payment.
	-20.05	Displays INT and the interest paid on the 54 th payment.
	1,801.57	Displays BAL and the balance after the 54 th payment.







Interest Rate Conversions



The Interest Conversion application uses three keys:  ,  , and  . They convert between nominal and annual effective interest rates.

If you know an annual nominal interest rate and you wish to solve for the corresponding annual effective rate:

1. Enter the nominal rate and press  .
2. Enter the number of compounding periods and press  .
3. Calculate the effective rate by pressing  .

To calculate a nominal rate from a known effective rate:

1. Enter the effective rate and press  .
2. Enter the number of compounding periods and press  .
3. Calculate the nominal rate by pressing  .

In the TVM application,   and  share the same memory.

Interest conversions are used primarily for two types of problems:

- Comparing investments with different compounding periods.
- Solving TVM problems where the payment period and the interest period differ.

Investments With Different Compounding Periods

Example: Comparing Investments

You are considering opening a savings account in one of three banks. Which bank has the most favorable interest rate?

First Bank	6.70% annual interest, compounded quarterly
Second Bank	6.65% annual interest, compounded monthly
Third Bank	6.63% annual interest, compounded 360 times per year

First Bank

Table 6-23 Calculating the interest rate (First bank)









Keys	Display	Description
    	6.70	Stores nominal rate.
  	4.00	Stores quarterly compounding periods.

Table 6-23 Calculating the interest rate (First bank)

Keys	Display	Description
	6.87	Calculates the annual effective rate.

Second Bank

Table 6-24 Calculating the interest rate (Second bank)

Keys	Display	Description
	6.65	Stores nominal rate.
	12.00	Stores monthly compounding periods.
	6.86	Calculates the annual effective rate.

Third Bank

Table 6-25 Calculating the interest rate (Third bank)

Keys	Display	Description
	6.63	Stores nominal rate.
	360.00	Stores compounding periods.
	6.85	Calculates the annual effective rate.

First Bank offers a slightly better deal since 6.87 is greater than 6.86 and 6.85.

Compounding and Payment Periods Differ

The TVM application assumes that the compounding periods and the payment periods are the same. Some loan installments or savings deposits and withdrawals do not coincide with the bank's compounding periods. If the payment period differs from the compounding period, adjust the interest rate to match the payment period before solving the problem.

To adjust an interest rate when the compounding period differs from the payment period complete the following steps:

1. Enter the nominal rate and press . Enter the number of *compounding* periods in a year and press . Solve for the effective rate by pressing .
2. Enter the number of *payment* periods in a year and press . Solve for the adjusted nominal rate by pressing .

Example: Monthly Payments, Daily Compounding

Starting today, you make monthly deposits of 25 to an account paying 5% interest, compounded daily (using a 365 day year). What will the balance be in seven years?

Step 1

Calculate the equivalent rate with monthly compounding.

Table 6-26 Calculating the equivalent nominal percentage rate

Keys	Display	Description
	5.00	Stores nominal percentage rate.
	365.00	Stores bank's compounding periods per year.
	5.13	Calculates annual effective rate.
	12.00	Stores monthly periods.
	5.01	Calculates the equivalent nominal percentage rate for monthly compounding.

Since *NOM%* and *I/YR* share the same memory, this value is ready for use in the rest of the problem.

Step 2



Calculate the future value.

Set to Begin mode. Press if **BEGIN** annunciator is **not** displayed.

Table 6-27 Calculating the future value

Keys	Display	Description
	0.00	Stores present value
	-25.00	Stores payment
	84.00	Stores total number of payments
	2,519.61	Calculates the balance after 7 years.

Resetting the TVM Keys

Press    to clear the TVM registers. This sets N , I/YR , PV , PMT , and FV to zero and briefly displays **TVM CLR**, followed by the current value in **P/Yr**.

7 Depreciation





















On the 10bII+, depreciation calculations are performed using the functions printed in blue on the keyboard located under the blue bracket titled, **DEPRECIATION**. Depreciation calculations are based on data entered into the Time Value of Money (TVM) keys: , , , and .

Table 7-1 Depreciation keys





TVM Key	Description
  	Clear TVM memory. Since the TVM and depreciation applications share the same memory, clearing TVM resets depreciation also.
	The expected useful life of the asset in years.
	The depreciable cost of the asset at acquisition.
	The salvage value of the asset at the end of its useful life.
 	Straight line is a method of calculating depreciation presuming an asset loses a certain percentage of its value annually at an amount evenly distributed throughout its useful life.
 	Sum-of-the-years' digits is an accelerated depreciation method. In SOYD , the depreciation in year y is $(\text{Life}-y + 1)/\text{SOY}$ of the asset, where SOY is the sum-of-the-years for the asset, or, for an asset with a 5-year life, $5+4+3+2+1=15$.
 	Declining balance is an accelerated depreciation method that presumes an asset will lose the majority of its value during the first few years of its useful life.
	The declining balance factor as a percentage. This is used for declining balance method.
 	With the calculated depreciation displayed, press   to display the remaining depreciable value at the end of the given year.







The Depreciation Keys











When entering data for depreciation calculations, results are calculated based on data entered into specific memory registers. When pressed, the keys used for these operations:

- store data.
- enter known data for variables used during calculations.
- calculate unknown variables based on stored data.

To perform a depreciation calculation:

1. Enter the original cost of the asset, using .
2. Enter the salvage value of the asset, using FV. If the salvage value is zero, press  .
3. Enter the expected useful life of the asset (in years), followed by .
4. If the declining-balance method is being used, enter the declining-balance factor (as a percentage), followed by . For example, 1-1/4 times the straight-line rate — 125 percent declining-balance — would be entered as 125.
5. Key in the number of the year for which depreciation is to be calculated followed by the desired depreciation method:

-   for depreciation using the straight-line method.
-   for depreciation using the sum-of-the-years digits method.
-   for depreciation using the declining-balance method.

 ,  , and   each place the amount of depreciation in the display, and the **TVM** and **X** annunciators are displayed. Press   to display the remaining depreciable value (the book value less the salvage value). After pressing   to display the remaining depreciable value, note the **X** annunciator changes to **Y**.

Example 1

A metalworking machine, purchased for 10,000.00, is to be depreciated over five years. Its salvage value is estimated at 500.00. Using the straight-line method, find the depreciation and remaining depreciable value for each of the first two years of the machine's life. See Table 7-2.

Table 7-2 Depreciation example using SL

























Keys	Display	Description
  	TVM CLR (message flashes then disappears)	Clears TVM registers.
     	10,000.00	Enters 10,000.00 for the depreciable cost of the item in the selected format.
   	500.00	Enters 500.00 for the salvage value of the item in the selected format.























Table 7-2 Depreciation example using SL

Keys	Display	Description
 	5.00	Inputs 5 for the expected useful life of the asset in the selected format.
  	1,900.00	Enters the year for which depreciation is to be calculated and calculates the depreciation of the asset in year one. TVM and X are displayed.
 	7,600.00	Displays remaining depreciable value after year one. X changes to Y in the display.
  	1,900.00	Enters the year for which depreciation is to be calculated and calculates the depreciation of the asset in year two.
 	5,700.00	Displays remaining depreciable value after year two.

Example 2

A machine was purchased for 4,000 and is to be depreciated over four years with a 1,000 salvage value. Using the sum-of-the-year's digit method, what is the depreciation during the machine's first year and third years? What is the remaining depreciable value?



























Table 7-3 Depreciation example using SOYD

Keys	Display	Description
  	TVM CLR (message flashes then disappears)	Clears TVM registers.
    	4,000.00	Enters the depreciable cost of the asset at acquisition.
 	4.00	Enters the expected useful life of the asset.
    	1,000.00	Enters the salvage value.
  	1,200.00	Calculates the depreciation for the first year.
  	600.00	Calculates the depreciation for the third year.
 	300.00	Displays the remaining depreciable value.



Example 3

A machine was purchased for 5,000 and is to be depreciated over seven years with no salvage value. Using the double declining balance method, what is the depreciation for the first three years of the machine's life? What is the remaining depreciable value?

Table 7-4 Depreciation example using Declining Balance

Keys	Display	Description
  	TVM CLR (message flashes then disappears)	Clears TVM registers.
    	5,000.00	Enters the depreciable cost of the asset at acquisition.
 	7.00	Enters the expected useful life of the asset.
   	200.00	Enters the double declining balance factor as a percentage.
 	0.00	Enters the salvage value.
  	1,428.57	Calculates the depreciation for the first year.
  	1,020.41	Calculates the depreciation for the second year.
  	728.86	Calculates the depreciation for the third year.
 	1,822.16	Displays the remaining depreciable value.

Resetting the TVM Keys



To clear the TVM registers and reset the TVM and depreciation functions to their default values, press  , followed by . The messages, **TVM CLR** and **12 P_yr** appear briefly to indicate the TVM registers have been reset.

8 Cash Flow Calculations

How to Use the Cash Flow Application

The cash flow application is used to solve problems where cash flows occur over regular intervals. Problems with regular, equal, periodic cash flows are handled more easily using the TVM keys. To operate the cash flow system, cash flow amounts and repeat values are keyed in either individually or together. In the following chapter, the term *repeat value* is used to describe the number of times a cash flow occurs. Terms such as *cash flow count*, *number of occurrences*, or *cash flow group* are also used to describe the *repeat value*.

If a new cash flow is entered, the calculator auto-increments the current cash flow count by 1. A value of 1 is automatically entered for a repeat value. To enter a repeat value for the current

cash flow entry, enter a value using  . To enter the cash flow and a repeat value

together, enter the cash flow value followed by , then enter the repeat value followed by

.

In general, use the following steps for cash flow calculations on the HP 10bII+:















































1. Organize your cash flows on paper. A cash flow diagram is useful.
2. Clear the cash flow memory.
3. Enter the number of periods per year.
4. Enter the amount of the initial investment (CF_0) using  to enter the cash flow value. The CF_0 value may have a repeated value. To enter the cash flow amount and repeat value simultaneously, enter a cash flow amount, followed by , then enter a number for the repeat value followed by .
5. Unless the cash flow and repeat value have already been entered as described in step 4 using  and , as an alternative, enter the repeat value using  .
6. Repeat steps 4 and 5 for each cash flow and repeat value.
7. To calculate net present value and net future value, you must first enter a value for the annual interest rate and press ; then press  . With NPV calculated, press   to display Net Future Value.
8. To calculate IRR, press  .

Table 8-1 Cash Flow Keys

Key	Description
  	Clears cash flow memory.
 	Number of periods per year (default is 12). For annual cash flows, P/YR should be set to 1 ; for monthly cash flows, use the default setting, 12 .
<i>number 1</i> 	Cash flows, up to 45. <i>J</i> identifies the cash flow number. When preceded by a number, pressing  enters a cash flow amount.
<i>number 1</i>  <i>number 2</i> 	Enter a cash flow amount, followed by  . Enter a number for the repeat value followed by  . This enters cash flow amount and repeat value simultaneously.
<i>number 2</i>  	An alternative for entering repeat value for cash flow <i>J</i> .
 	Opens editor for reviewing or editing entered cash flows. Press  or  to scroll through the cash flow data.
 	Internal rate of return per year.
 	Net present value.
    	Net future value.
 	With cash flow editor open, displays total of cash flows.
 	With cash flow editor open, displays total number of cash flows.

Clearing the Cash Flow Memory

It is always a good idea to clear the cash flow memory before beginning. To clear cash flows, use   . A brief message appears, **CFLO CLR**, to indicate the cash flow memory has been reset.

On the 10bII+, there is always space reserved for up to 15 cash flows. In addition, up to 30 additional cash flows may be stored in memory shared with the statistics memory, as shown in Figure 1 below.

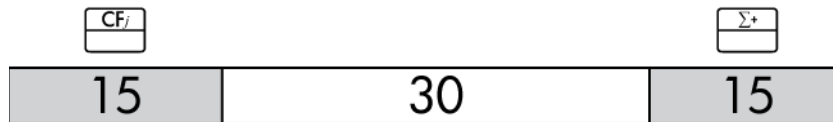

Figure 1

As illustrated in Figure 1, if no more than 15 data points are stored in the statistics memory, you may store up to 45 cash flows with the shared memory space.

If more than 15 data points are stored in the statistics memory, the total memory available for storing cash flows is reduced. For example, in Figure 2, there are 25 data points stored, and the amount of available shared memory has therefore decreased by 10 slots.

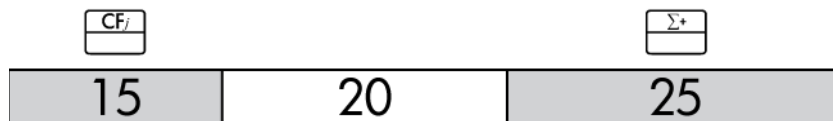

Figure 2

If data storage in the calculator memory resembles Figure 2, and you have a cash flow calculation requiring more than 35 data points, clearing unneeded statistical information will free up more space for information. When available memory is reached (see Figure 3), the **FULL** annunciator indicates there is not enough space to continue saving data. If you attempt to enter another cash flow at this point, the **ERROR** annunciator is displayed. In this case, no additional cash flow data can be entered until some data in the statistics memory is removed and the shared memory is once again available.



Figure 3

Example 1: A Short Term Investment

The following cash flow diagram represents an investment in stock over three months. Purchases were made at the beginning of each month, and the stock was sold at the end of the third month. Calculate the annual internal rate of return and the monthly rate of return.

Calculating Internal Rate of Return

1. Press , and store the desired number of periods per year in *P/YR*.
2. Enter the cash flows using and .
3. Press .

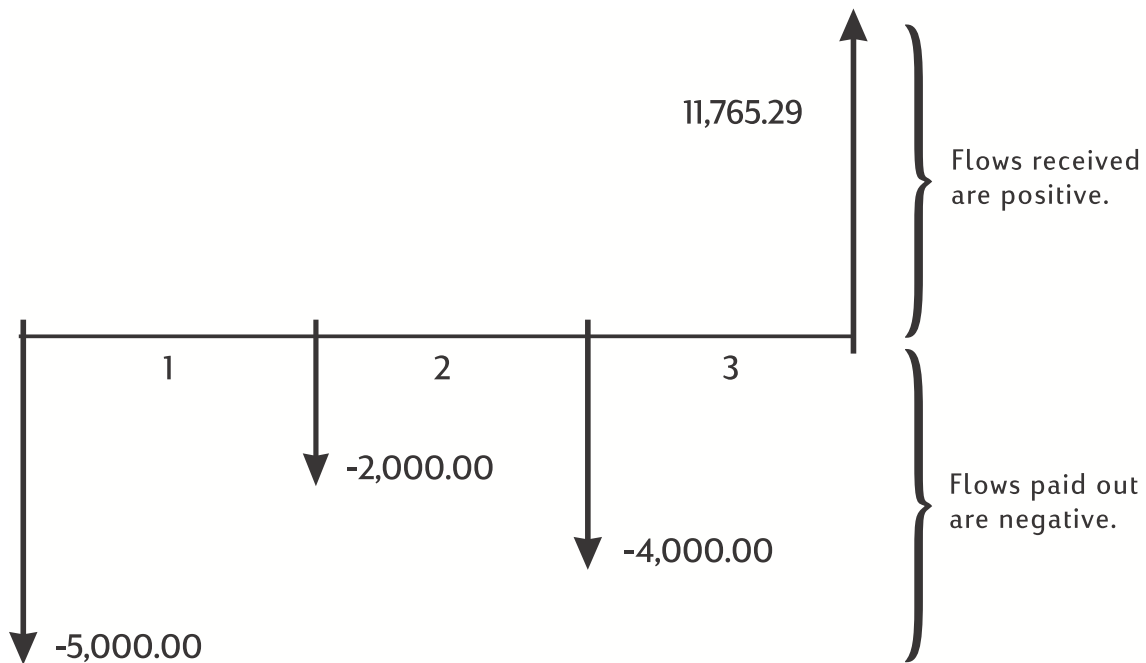

Figure 4 Cash flow diagram (Investments in stock)

Table 8-2 Example 1: a short term investment

Keys	Display	Description
	CFLO CLR (message flashes, then disappears)	Clears cash flow memory.
	12.00	Set payments per year.
	-5,000.00 (CF 0 flashes, then disappears)	Enters initial cash flow. Note the CFLO and CF annunciators.
	-2,000.00 (CF 1 flashes, then disappears)	Enters first cash flow. Note the CFLO and CF annunciators.

Table 8-2 Example 1: a short term investment

Keys	Display	Description
	-4,000.00 (CF 2 flashes, then disappears)	Enters second cash flow. Note the CFLO and CF annunciators.
	11,765.29 (CF 3 flashes, then disappears)	Enters third cash flow. Note the CFLO and CF annunciators.
	38.98	Calculates annual nominal yield.
	3.25	Monthly yield.

NPV and IRR/YR: Discounting Cash Flows

Chapter 5 titled, *Picturing Financial Problems* demonstrates the use of cash flow diagrams to clarify financial problems. This section describes discounted cash flows. The *NPV*, *NFV* and *IRR/YR* functions are frequently referred to as *discounted cash flow functions*.

When a cash flow is discounted, you calculate its present value. When multiple cash flows are discounted, you calculate the present values and add them together.

The net present value (*NPV*) function finds the present value of a series of cash flows. The annual nominal interest rate must be known to calculate *NPV*.

The net future value (*NFV*) function finds the value of the cash flows at the time of the last cash flow, discounting the earlier cash flows by the value set for the annual nominal interest rate.

The internal rate of return (*IRR/YR*) function calculates the annual nominal interest rate that is required to give a net present value of zero.

The utility of these two financial tools becomes clear after working a few examples. The next two sections describe organizing and entering your cash flows. Examples of *NPV*, *NFV*, and *IRR/YR* calculations follow.

Organizing Cash Flows

The cash flow series is organized into an *initial cash flow* (CF_0) and succeeding *cash flow groups* (up to 44 cash flows). CF_0 occurs at the beginning of the first period. A cash flow group consists of a cash flow amount and the number of times it repeats.

For example, in the following cash flow diagram, the initial cash flow is -11,000. The next group of cash flows consists of six flows of zero each, followed by a group of three 1,000 cash flows. The final group consists of one 10,000 cash flow.

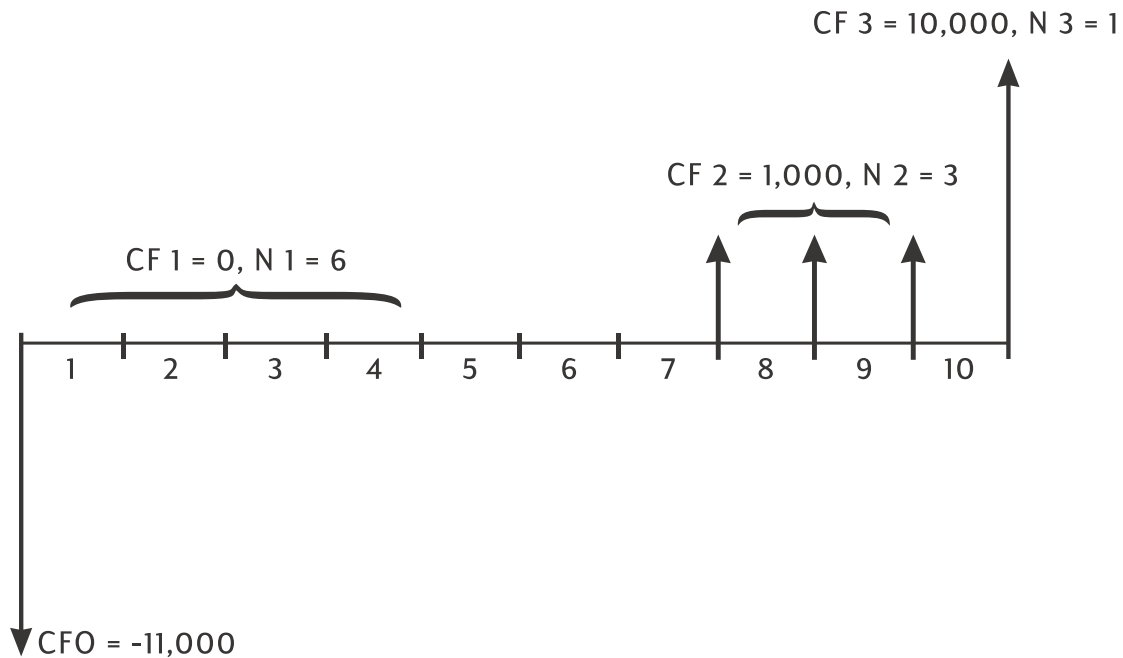

Figure 5 Initial cash flow and cash flow groups

Whenever you enter a series of cash flows, it is important to account for every period on the cash flow diagram, even periods with cash flows of zero.



















Example

Enter the cash flows from the preceding diagram and calculate the *IRR/YR*. Assume there are 12 periods per year.

Table 8-3 Example calculating IRR and effective interest rate









Keys	Display	Description
	CFLO CLR (message flashes, then disappears)	Clears cash flow memory.
	12.00	Set payments per year.
	-11,000.00 (CF 0 flashes, then disappears)	Enters initial cash flow. Displays cash flow group number and amount. Note the CFLO and CF annunciators.
	0.00 (CF 1 flashes, then disappears)	Enters first cash flow group amount. Note the CF annunciator.
	6.00 (CFn 1 flashes, then disappears)	Enters number of repetitions. Note the CFLO and N annunciators.

Table 8-3 Example calculating IRR and effective interest rate

Keys	Display	Description
    	1,000.00 (CF 2 flashes, then disappears)	Enters second cash flow group amount. Note the CFLO and CF annunciators.
   	3.00 (CFn 2 flashes, then disappears)	Enters number of repetitions. Note the CFLO and N annunciators.
     	10,000.00 (CF 3 flashes, then disappears)	Enters third cash flow. Note the CFLO and CF annunciators.
  	21.22	Calculates the annual nominal yield.

Viewing and Editing Cash Flows

The cash flow editor application allows you to review entered data quickly to ensure accuracy. In addition, you may edit, add, or delete cash flow data as needed.

1. Press   to open the editor. The current repeat value and the current cash flow value are displayed. The **CFLO** annunciator appears, and either **CF** or **N** identifies which value is being displayed.
2. Press  to move up through the current cash flow information. When you pass the maximum of the data, an empty cash flow pair is displayed before wrapping around to CF_0 , provided there is enough memory for another cash flow pair to be entered.
3. Press  to move down through the current cash flow information. At CF_0 the display wraps around to the maximum cash flow pair count.
4. At any time with the editor open, press  to return to CF_0 . To jump to a specific cash flow, type the desired whole number of the desired cash flow item, J , and press . The editor jumps to that position. If the number is higher than your maximum current cash flow item count, it will place you at the highest cash flow value. If an invalid entry is typed, such as a negative number or a non-whole number, the editor remains in its current location.
5. To delete the current cash flow pair, press . To add a new cash flow with a value of 0 and a repeat value of 1 before the currently displayed item, press .

6. To replace the currently displayed value, simply type a new number and press . Only valid entries are accepted. If you type an invalid entry, such as a value of 0 for the count, the **ERROR** annunciator appears and the value is rejected.
7. To clear the current cash flow or repeat value without removing the entire pair, press . If the cash flow amount is displayed, it will be set to a value of 0. If the cash flow repeat value is displayed, it will be set to a value of 1.
8. To view the current cash flow total, press . To view the current total number of cash flows, press .
9. Press to exit.

After completing the last example, open the cash flow list and modify the following cash flows with the data in the table below. Calculate the new *IRR/YR*.

























Table 8-4 Enter the new data

Cash Flow Group	New Cash Flow Amount	New Cash Flow Count
CF 0	-11,000.00	1
CF 1	0	3
CF 2	1,000.00	2
CF 3	7,500.00	2
CF 4	-1,200.00	2

Table 8-5 Editing cash flows

Keys	Display	Description
<input type="button" value="RCL"/> <input type="button" value="CF<sub>j</sub>"/>	0 -11,000.00	Open the cash flow list, starting with the initial cash flow CF ₀ .
<input type="button" value="1"/> <input type="button" value="CF<sub>j</sub>"/> <input type="button" value="+"/>	1 6.00	Jumps to the group, CF ₁ , and the repeat value, 6.00.
<input type="button" value="3"/> <input type="button" value="INPUT"/>	1 3.00	Inputs new repeat value, 3.00, for CF ₁ .
<input type="button" value="+"/> <input type="button" value="+"/> <input type="button" value="2"/> <input type="button" value="INPUT"/>	2 2.00	Displays cash flow repeat value and inputs new repeat value for CF ₂ .
<input type="button" value="3"/> <input type="button" value="CF<sub>j</sub>"/>	3 10,000.00	Displays the group, CF ₃ , and the cash flow amount, 10,000.00.









Table 8-5 Editing cash flows

Keys	Display	Description
       	3 2.00	Inputs new cash flow amount and repeat value. Displays the new repeat value, 2.00, for CF ₃ .
         	4 is displayed first, with no value followed by 4 -1,200 , then 4 2.00	Inputs new cash flow, CF ₄ , and repeat value.
  	3,600.00	Displays total of the cash flows.
	0.00	Exit the editor.
  	58.97	Calculate the new annual yield.

Calculating Net Present Value and Net Future Value

The net present value (*NPV*) function is used to discount all cash flows to the front of the time line using an annual nominal interest rate that you supply.

To calculate *NPV* or *NFV*:

1. Press    and store the desired number of periods per year in *P/YR*.
2. Enter the cash flow data.
3. Store the annual nominal interest rate in *I/YR* and press   .
4. If you have just calculated *NPV*, press    to calculate *NFV*.

Example: A Discounted Contract, Uneven Cash flows

You have an opportunity to purchase a contract with the following cash flows:

Table 8-6 Example of a contract with uneven cash flows

End of Month	Amount
4	5,000.00
9	5,000.00
10	5,000.00
15	7,500.00
25	10,000.00

How much should you pay for the contract if you wish to yield a yearly rate of 15% on your investment?

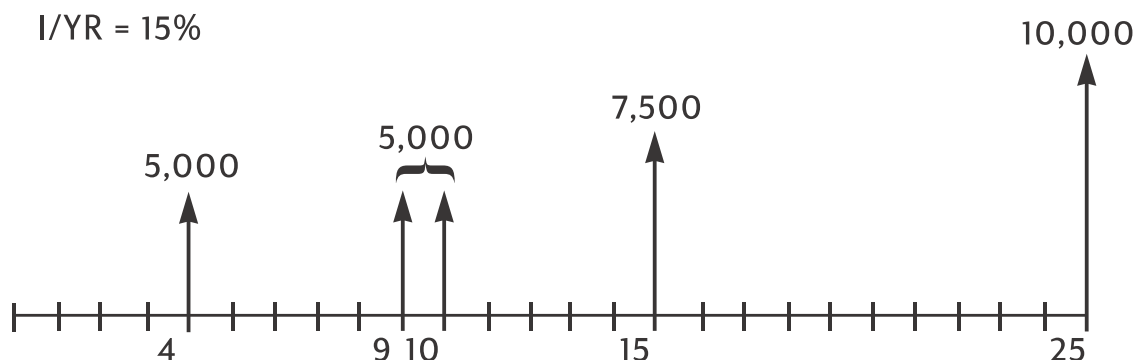

Figure 6 Cash flow diagram (Calculate the amount)

The following example uses the **INPUT** and **CFj** keys to enter the cash flow amount and repeat value simultaneously. When the cash flow count is 1 for a given cash flow amount, the cash flow amount may be entered simply by pressing the amount followed by **CFj**, as the default for the count is 1. However, when using the **INPUT** key to enter the cash flow amount, you must then follow **INPUT** with the repeat value followed by **CFj**, even if the repeat value is 1. This process is shown here to demonstrate this application and for consistency with entering the data for the example.

Table 8-7 Entering uneven cash flows

Keys	Display	Description
↑ C/MEM 0 c	CFLO CLR (message flashes, then disappears)	Clear cash flow memory.
1 2 ↓ PMT P/YR	12.00	Set payments per year.
0 INPUT 4 CFj	4.00 (CFn 0 flashes, then disappears)	Input initial cash flow of zero and the repeat value.
5 0 0 0 INPUT 1 CFj	1.00 (CFn 1 flashes, then disappears)	Input second cash flow amount and repeat value. Note the N annunciator.
0 INPUT 4 CFj	4.00 (CFn 2 flashes, then disappears)	Input third cash flow amount and repeat value.
5 0 0 0 INPUT 2 CFj	2.00 (CFn 3 flashes, then disappears)	Input fourth cash flow amount and repeat value.

Keys	Display	Description
	4.00 (Cf _n 4 flashes, then disappears)	Input fifth cash flow amount and repeat value.
	1.00 (Cf _n 5 flashes, then disappears)	Input sixth cash flow amount and repeat value.
	9.00 (Cf _n 6 flashes, then disappears)	Input seventh cash flow amount and repeat value.
	1.00 (Cf _n 7 flashes, then disappears)	Input eighth cash flow amount and repeat value.

The cash flows that describe your prospective investment are now in the calculator. Press . Press or to scroll through the list and verify the cash flows and the repeat value is entered correctly. Press to exit.

Now that you have entered the cash flows, store the interest rate and calculate the net present value and net future value.

Table 8-8 Calculating NPV and NFV

Keys	Display	Description
	15.00	Store annual interest rate
	27,199.92	Calculate net present value of stored cash flows.
	37,105.94	Calculate NFV of stored cash flows.

This result shows that if you want a yield of 15% per year, you should pay 27,199.92 for the contract. Notice that this amount is positive. The net present value is simply the summed (or netted) value of a series of cash flows when they are discounted to the front of the time line.

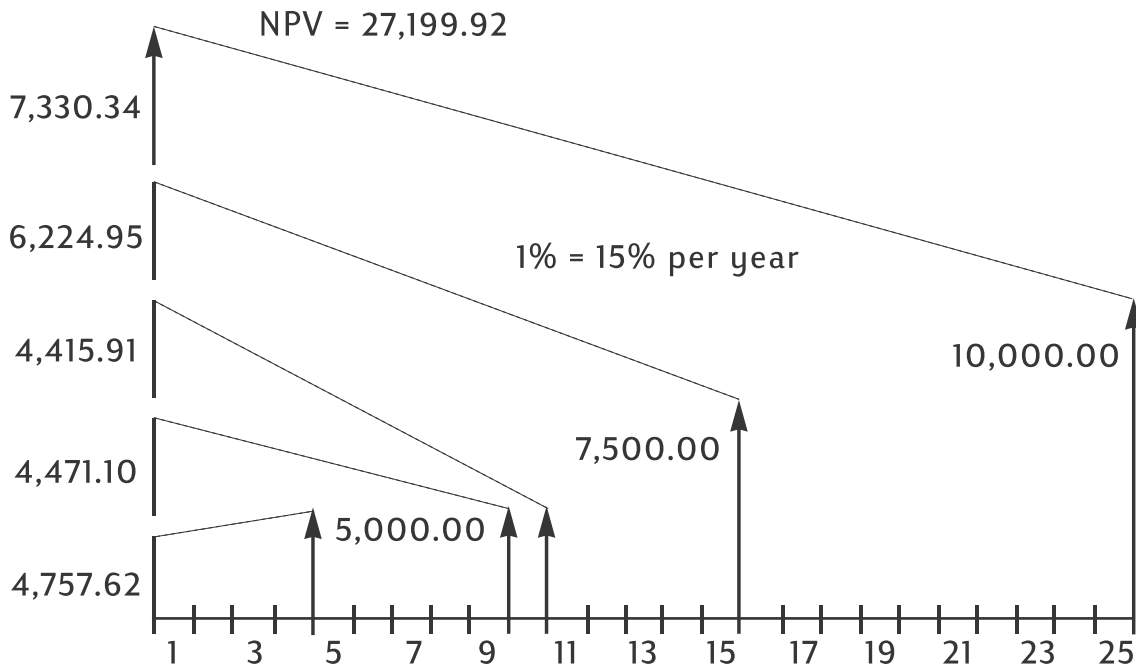

Figure 7 Cash flow diagram (Calculates NPV)

Automatic Storage of IRR/YR and NPV

When you calculate *NPV*, the result is stored in *PV* for your convenience. To recall that result, press . If you haven't changed the TVM values from the last example using *NPV*, when you press the result is 27,199.92. When you calculate *IRR/YR*, the result is stored in *I/YR*. Press to display the annualized yield. More examples of *NPV*, *NFV* and *IRR/YR* calculations can be found in the chapter 13 titled, *Additional Examples*.

9 Calendar Formats and Date Calculations

Calendar Format







The calendar options for bonds and date calculations are Actual (**ACT**) and 360. Press  to toggle between these options. The default setting, *Actual*, is based on a 365-day calendar. The alternate setting, **360**, is based on a 360-day calendar. It is important to note date and bond calculations return different values for each of these settings, so verify the calendar mode is appropriate for your problem before you begin.

Table 9-1 Date and Calendar Keys

Keys	Description
	Enters dates in DD.MMYYYY or MM.DDYyyy formats. D.MY is the default. Numbers at the far right of a calculated date indicate days of the week. 1 is for Monday; 7 is for Sunday.
	Toggles between 360-and 365-day (Actual) calendars.
	Calculates the date and day, past or future, that is a given number of days from a given date. Note the returned result is <i>always</i> calculated on the 365-day calendar (Actual), regardless of the calendar setting.
	Calculates the number of days between two dates. Based on your current setting, returned result is calculated on either the 365-day (Actual) or the 360-day calendar.

Date Format

The valid range of dates for the calendar functions of the HP 10bII+ is October 15, 1582 through December 31, 9999. For the date, the number of days between two dates, and bond calculations, dates may be entered and displayed either in month-day-year (M.DY) or day-month-year (D.MY) formats. In addition to a different display mode for the date and date calculations, these functions also return different values based on the 365-day (ACT) and 360-day (360) calendars.

Press  to toggle between the formats. The default setting is day-month-year (dd.mmyyyy).

Press  to toggle between the 360-and 365-day (actual) calendars.

To specify the number of displayed decimal places:

1. Press .

- Enter the number of digits through that you wish to appear after the decimal point. To view the entire date, press . For more information on changing the number display, refer to the section titled, *Specifying Displayed Decimal Places* in chapter 2.

To key in a date in M.DY format:

- Key in one or two digits for the month.
- Press .
- Key in two digits for the day.
- Key in four digits for the year.
- Press either or to display the date in the selected number display format.

To key in a date in D.MY, press until the **D.MY** annunciator appears.

- Key in one or two digits for the day.
- Press .
- Key in two digits for the month.
- Key in four digits for the year.
- Press either or to display the date in the selected number display format.

Using the INPUT key

You can also enter dates for date calculations and the number of days using .





To enter a date in M.DY format using .

- Key in one or two digits for the month.
- Press .
- Key in two digits for the day.
- Key in four digits for the year.
- Press .





For more information about using the data and number of days functions as in-line functions, or with the key, see the examples below and refer to the section titled, *In-Line Functions* in chapter 2.



Date Calculations and Number of Days

To calculate the date and day, past or future, that is a given number of days from a given date as an in-line function:

1. Key in the given date and press  .
2. Key in the number of days.
3. If the other date is in the past, press .
4. Press  to display the date in the selected number display format.

To calculate the date and day, past or future, that is a given number of days from a given date using :

1. Key in the given date and press .
2. Key in the number of days.
3. If the other date is in the past, press .
4. Press   to display the date in the selected number display format.

Regardless of the setting for displayed places after the decimal point, or whether you use  or the in-line feature, the answer calculated by the   function is displayed in a special format. The numbers of the month, day, and year (or day, month, and year) are separated by digit separators. The digit at the right of the displayed answer indicates the day of the week: **1** is for Monday; **7** is for Sunday.

Date Calculation

Example 1



































What is the date 100 days after December 18, 2011? Press   if the **D.MY** annunciator is displayed. Calculate this example using the date feature as an in-line function and with the  key.

Table 9-2 Date calculation example as an in-line function



Keys	Display	Description
        	12.182011_	Keys in the date in MM.DDYYYY format.
     	3-27-2012 2	Calculates the date.





To enter the data for this example using the  key:

Table 9-3 Date calculation example using the 'INPUT' key

Keys	Display	Description
        	12.182011_	Keys in the date in MM.DDYYYY format.
     	3-27-2012 2	Returns the same results using the  key.

Number of Days

Use the   function to calculate the number of days between two dates.

1. Key in the earlier date and press  .
2. Key in the later date and press   to calculate the number of days between the two dates in actual days.

Example 1

How many days remain in the 2010 fiscal year if today's date is June 4, 2010? Assume the fiscal year ends on October 31st, and you wish to calculate the actual number of days (**Actual**)



using the D.MY format. Press   if the **360** annunciator is displayed. Calculate the example as an in-line function.

Table 9-4 Calculating the actual number of days as an in-line function

Keys	Display	Description
D.MY/M.DY 	0.00	Sets the desired date format. Note the D.MY annunciator.
360/Act 	0.00	Sets the desired calendar format, in this case, actual days (optional if the 360 annunciator is not displayed, as Actual is the default).
	0.000000	Sets the number of displayed decimal places so the entire date is displayed (optional).
	4.062010	Inputs the starting date in the selected format.
	149.000000	Inputs the ending date in the selected format and calculates the number of actual days between the starting and ending dates.
	149.00	Returns the number of displayed decimal places to the default (optional).

Example 2

How many days are there between October 17, 2012 and June 4, 2015? Use the M.DY setting and compute the number of days in Actual (**Act**) mode. Press if the **360** annunciator is displayed; press if the **D.MY** annunciator is displayed. Calculate this example using the number of days feature as an in-line function and also with the key.

Table 9-5 Calculating the actual number of days as an in-line function

Keys	Display	Description
	10.172012_	Keys in the date in MM.DDYYYY format.
	960.00	Calculates the days between based on the 360-day calendar.

























Using the  key:

Table 9-6 Calculating the actual number of days using the 'INPUT' key

Keys	Display	Description
	0.00	Clear display.
         	10.17	Keys in the date in MM.DDYYYY format and displays digits in the selected display format (2).
           	960.00	Returns the same results.

10 Bonds

The Bond Keys













On the 10bII+, bond calculations are based on data or settings stored in the ten keys which make up the top two rows of the keyboard. The functions used in bond calculations are printed in blue above the keys on the keyboard. To access the bond functions, press  followed by the desired function. See the table below for a description of the bond keys.

Table 10-1 Bond keys



Keys	Description
 C MEM C 	Clears bond memory.
 AccInt N	Calculates accrued interest only.
 YTM I/YR	Yield% to maturity or yield% to call date for given price.
 PRICE PV	Price per 100.00 face value for a given yield.
 CPN% PMT	Coupon rate stored as an annual %.
 CALL FV	Call value. Default is set for a call price per 100.00 face value. A bond at maturity has a call value of 100% of its face value.
 D.MY/M.DY INPUT	Date format. Toggle between day-month-year (dd.mmyyyy) or month-day-year (mm.ddyyyy).
 360/Act MU	Day count calendar. Toggle between Actual (365-day calendar) or 360 (30-day month/360-day year calendar).
 Semi/Ann CST	Bond coupon (payment). Toggle between semiannual and annual payment schedules.
 SetDate PRC	Settlement date. Displays the current settlement date.
 MatDate MAR	Maturity date or call date. The call date must coincide with a coupon date. Displays the current maturity.

Bond calculations, primarily calculating bond price and yield, are performed by two keys,

 **PRICE**
PV and  **YTM**
I/YR.

When entering data for bond calculations, results are calculated based on data entered into specific memory registers. When pressed, the keys used for these operations:

- store data.
- enter data for variables used during calculations (input only).
- calculate unknown variables based on stored data.

Most of the other keys used in bond calculations allow you to enter data for a variable, but you cannot solve for that variable. The exception is the   key. This key permits you to return results for accumulated interest, but you cannot enter data into this key.

Before you perform a bond calculation, be sure to verify the date format is set appropriately for your problem. The default setting is mm.ddyyyy, but it can be set for dd.mmyyyy. For more information about entering dates and date formats, see chapter 9, *Calendar Formats and Date Calculations*. The range of acceptable dates is October 15, 1582 to December 31, 9999. Verify that bond day counts (360/365) and annual or semiannual coupon payment schedules are appropriate for your problem prior to inputting your data.

Example 1



What price should you pay on April 28, 2010 for a 6.75% U.S. Treasury bond maturing on June 4, 2020, if you want a yield of 4.75%? Assume the bond is calculated on a semiannual coupon payment on an actual/actual basis. If D.MY is displayed, press   before beginning. See Table .

Table 10-2 Bond calculation example















Keys	Display	Description
  	BOND CLR (message flashes, then disappears)	Clears bond memory.
 	0.00	Selects semiannual coupon payment, as required by the example. Note the annunciator in the display.
         	4-28-2010 3	Inputs April 28, 2010 for the settlement date (mm.ddyyyy format). Note: the 3 in the far right of the display indicates the day of the week. This number indicates the day of the week corresponding to that date. Monday is 1, and Sunday is 7. April 4, 2010 is a Wednesday.

Table 10-2 Bond calculation example

Keys	Display	Description
 	6-4-2020 4	Inputs June 4, 2020 for the maturity date.
	6.75	Inputs 6.75% for the value for CPN% .
	100.00	Inputs call value. Optional, as default is 100 . Note: if Call requires another value, key in the number followed by .
	4.75	Inputs 4.75% for Yield%.
	115.89	Calculates the price.
	2.69	Displays the current value for accrued interest.
	118.58	Returns the result for total price (value of price + value of accrued interest). The net price you should pay for the bond is 118.58 .























Example 2

A bond has a call provision at 104 and a coupon rate of 5.5%. If the bond matures on October 15, 2020 and is presently selling at 101, what is the yield-to-call on April 15, 2012? Assume the bond is calculated on a semiannual coupon payment on an actual/actual basis.

Table 10-3







Keys	Display	Description
	BOND CLR (message flashes, then disappears)	Clears bond memory.
	5.50	Inputs coupon rate as an annual%.
	104.00	Inputs call value.
	101.00	Inputs price.

Table 10-3





Keys	Display	Description
          	10-15-2020-4	Inputs October 15, 2020 for the maturity date.
         	4-15-2012-7	Inputs April 15, 2012 for the settlement date.
 	5.72	Calculates yield as a %.

Continuing with the same bond problem, assume the bond will not be called. What is the expected yield to maturity?

Table 10-4

Keys	Display	Description
    	100.00	Inputs new call value. Since the bond will not be called, the bond at maturity has a call value of 100% of its face value.
 	5.35	Calculates new yield%.













Resetting the bond keys

To reset the Bond keys to their default values, press   . The message, **BOND CLR** flashes briefly on the screen to indicate the bond registers have been reset. To return to the default calculator screen, press .

11 Break-even

The break-even function allows you to study problems involving a profit, when a quantity of items, with a cost to manufacture and a fixed price to develop and market, is sold at a given price. On the 10bII+, break-even calculations are performed using the functions printed in blue on the keyboard located under the blue bracket titled, **BREAKEVEN**. Break-even calculations are based on data entered into these keys, which are listed in the table below:

Table 11-1 Break-even keys

Key	Description
  	Clears break-even memory.
 	Stores the quantity of units required for a given profit or calculates it.
 	Stores the sales price per unit or calculates it.
 	Stores variable cost per unit for manufacturing or calculates it.
 	Stores the fixed cost to develop and market or calculates it.
 	Stores the expected profit or calculates it.

The Break-even Keys































When entering data for break-even calculations, results are calculated based on data entered into specific memory registers. When pressed, the keys used for these operations:

- store data.
- enter known data for variables used during calculations.
- calculate unknown variables based on stored data.

Example 1

The sale price of an item is 300.00, the cost is 250.00, and the fixed cost is 150,000.00. How many units would have to be sold to make a profit of 10,000.00?























Table 11-2 Break-even example

Keys	Display	Description
  	BK EV CLR (message flashes, then disappears)	Clears break-even memory.
       	150,000.00	Inputs fixed cost.
    	250.00	Inputs variable cost per unit.
    	300.00	Inputs price.
      	10,000.00	Inputs profit.
 	3,200.00	Calculates the current value for the unknown item, UNITS .





Example 2

What is the estimated maximum fixed cost you can afford to manufacture 10,000 water filters, if your desired selling price is 45.00? Assume the cost per unit is 23.00. Since you want to calculate the maximum fixed cost, your profit for the purpose of the example will be 0.00.

Table 11-3 Calculating the projected maximum fixed cost

Keys	Display	Description
  	BK EV CLR (message flashes, then disappears)	Clears break-even memory.
      	10,000.00	Inputs the projected number of units.
   	45.00	Inputs the projected selling price.
   	23.00	Inputs the variable cost per unit.
  	0.00	Inputs the profit, in this case, 0.
 	220,000.00	Calculates the maximum projected fixed cost to develop and market the water filter.

Resetting the Break-even keys

To reset the break-even keys to their default values, press   . A brief message flashes on the screen to indicate the break-even registers have been reset. To return to the default calculator screen, press .

12 Statistical Calculations



The 10bII+ allows you to enter data for one- and two-variable statistics easily. Once data is entered, you can use the statistical functions to calculate the following:

- Mean and standard deviation
- Regression statistics or a best fit
- Estimation and forecasting
- Weighted mean
- Summation statistics: n , Σx , Σx^2 , Σy , Σy^2 , and Σxy .

Table 12-1 Statistics keys

Keys	Description
	Clear statistics memory.
x-value	Enter one-variable statistical data.
x-value	Delete one-variable statistical data.
x-value y-value	Enter two-variable statistical data.
x-value y-value	Delete two-variable statistical data.
	Opens editor for reviewing or editing statistical data.
	Means of x and y .
	Mean of x weighted by y . Also calculates b coefficient.
	Sample standard deviations of x and y .
	Population standard deviations of x and y .
	Estimation of x . Also calculates r correlation coefficient.
	Estimation of y . Also calculates slope and m coefficient.
	Permits selection of six regression models or a best fit. Default is linear.

Clearing Statistical Data

Clear the statistical data before entering new data. If you don't clear the statistical data, new information stored will be added to the current calculations. To clear all statistical data, press  . The message **STAT CLR** flashes briefly and the display is cleared. The regression model is also reset to its default setting, **LINEAR**.

Entering Statistical Data

The 10bII+ uses a combination of list-based and register-based statistics when storing statistical data. List-based statistics store every value and permit you to review and edit entered data. Register-based statistics accumulate information, but you cannot easily edit or review this information.

On the 10bII+, there is always space reserved for up to 15 data points. In addition, up to 30 additional data points may be stored in memory shared with the cash flow memory. See Figure 1.

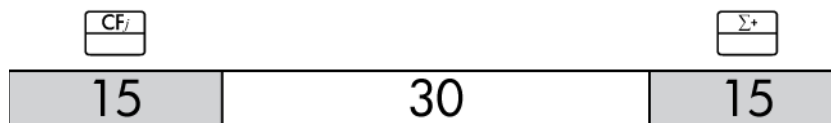

Figure 1

As illustrated in Figure 1, if no more than 15 cash flows are stored in the cash flow memory, you may store up to 45 data points for statistical usage.

If more than 15 cash flows are stored in the cash flow memory, the total memory available for storing statistical data is reduced. For example, in Figure 2, there are 25 cash flows stored, and the amount of available shared memory has therefore decreased by 10 slots.

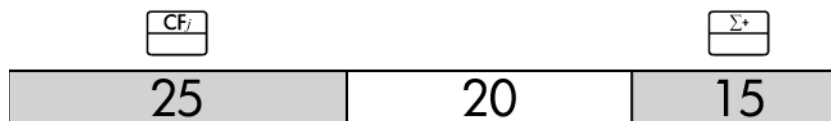

Figure 2

If data storage in the calculator memory resembles Figure 2, and you have a statistical calculation requiring more than 35 data points, clearing unneeded cash flow information will free up more space for information. If there are more data points than available memory, the 10bII+ automatically switches to register-based statistics to allow continued work. When available memory is reached, the **FULL** annunciator indicates there is not enough space to continue saving data. See Figure 3.



Figure 3

When the calculator switches to register-based mode, some key points to consider:

- You may enter an unlimited number of data points.
- The statistics editor, accessed with $\boxed{\text{RCL}}$ $\boxed{\Sigma^+}$, is not available.
- While use of $\boxed{\blacktriangledown}$ $\boxed{\frac{\Sigma^+}{\Sigma^-}}$ is allowed, viewing previously entered data is not possible.
- The only regression mode available is a linear regression.

One-Variable Statistics

To enter x -data for one-variable statistics complete the following steps:

1. Clear the statistical registers by pressing $\boxed{\blacktriangledown}$ $\boxed{\frac{-M}{\text{CSTAT}}}$.
2. Enter the first value and press $\boxed{\Sigma^+}$. The HP 10bII+ displays n , the number of items accumulated.
3. Continue accumulating values by entering the numbers and pressing $\boxed{\Sigma^+}$. The n -value is increased with each entry.

Two-Variable Statistics and Weighted Mean

To enter x,y pairs of statistical data complete these steps:

1. Clear the statistical registers by pressing $\boxed{\blacktriangledown}$ $\boxed{\frac{-M}{\text{CSTAT}}}$.
2. Enter the first x -value and press $\boxed{\text{INPUT}}$. The HP 10bII+ displays the x -value.
3. Enter the corresponding y -value and press $\boxed{\Sigma^+}$. The HP 10bII+ displays n , the number of pairs of items accumulated.
4. Continue entering x,y pairs. The n -value is increased with each entry.

To enter data for calculating the weighted mean, enter each data value as x , and its

corresponding weight as y in the statistics memory. Press $\boxed{\blacktriangledown}$ $\boxed{\frac{6}{\bar{x}_{w,b}}}$ to calculate the weighted mean.

Viewing and Editing Statistical Data

1. Press $\boxed{\text{RCL}}$ $\boxed{\Sigma^+}$ to open the editor. The number of items accumulated, n , is displayed, along with the current x -or y -value. The **STAT** annunciator appears, and the **X** or **Y** identifies the displayed value.
2. Press $\boxed{+}$ to move up through the current statistical data. When you pass the maximum of the data, an empty statistical pair displays before wrapping back to x_1 , provided there is enough memory for more data.
3. Press $\boxed{-}$ to move down through the current statistical data. At x_0 , the display wraps back to the maximum y -value.
4. At any time with the editor open, press $\boxed{\Sigma^+}$ to return to x_1 . To jump to a specific data pair, type the whole number which represents the pair's n -value and press $\boxed{\Sigma^+}$. The editor will jump to that data pair, unless your entered number is higher than your maximum data pair, in which case it will jump to the highest x -value. If you type in an invalid number, such as a negative number, or a non-whole number, the editor remains in its current position.
5. To delete the currently displayed statistical data pair, press $\boxed{\div}$. To add a new pair with the x - and y -values equal to zero, press $\boxed{\times}$.
6. To replace the currently displayed value, simply type in the new number and press $\boxed{\text{INPUT}}$.
7. To clear the currently displayed x -or y -value without removing the entire pair, press $\boxed{\leftarrow}$ to set the value to 0.
8. Press $\boxed{\text{C}}$ to exit the editor.

Example 1





























































A tropical beach resort has been having some very hot weather lately. A manager at the beach resort has noticed an increase in the number of cold drinks sold during hot days and wants to be able to predict how many employees are needed to sell drinks tomorrow. Each employee can sell 200 drinks a day at most.

Table 12-2 Data

Past 3 Days Temperature (Celsius)	Cold Drinks Sold
32	415
35	515
38	725

At what temperature would the manager predict to sell 800 drinks? How many employees will be needed for tomorrow's predicted temperature of 43°C?

Table 12-3 Example entering statistical data, opening the editor, and predicting

Keys	Display	Description
 	STAT CLR (message flashes briefly, then disappears)	Clears the statistics memory.
      	1.00	Enters first ordered pair.
      	2.00	Enters the second ordered pair.
      	3.00	Enters the third ordered pair.
 	1 32.00	Open the editor. Displays X annunciator.
    	3 725.00	Scroll and verify the data points, starting with the <i>x</i> -value of the first pair. The <i>y</i> -value of the third pair is displayed.
		Exit the editor.
   	0.00	Set the regression model to power. 4-POWER flashes briefly after  is pressed, then disappears.
     	39.49	Predict the temperature.
     	.988080878	Display the correlation coefficient.
       	1,053.49	Predict the number of drinks sold tomorrow.
    	5.27	Manager should have at least 6 employees at work tomorrow to cover the expected load.

Continuing with this example, modify this data by adding more points: two additional days of sales and their corresponding temperatures. The first day's temperature of 43°C resulted in the sale of 1,023 cold drinks. The next day's temperature at 37°C resulted in the sale of 685 drinks.

Table 12-4 Adding more data

Keys	Display	Description
4 3 INPUT 1 0 2 3 Σ^+	4.00	Enters fourth ordered pair.
3 7 INPUT 6 8 5 Σ^+	5.00	Enters fifth ordered pair.

After modifying the data, predict the next day's activity at a record 45°C.

Table 12-5 A new prediction

Keys	Display	Description
4 5 \downarrow 5 \hat{y}_m	1,204.67	Predicts the drinks sold at 45°C. But is this the best fit?
\uparrow REGR 1 0	0.00	Sets regression mode to 0-BEST FIT .
4 5 \downarrow 5 \hat{y}_m	1,128.12	All regressions are calculated and LINEAR is selected as being a better fit than POWER . The result, 1128, is well within the limit of six employees.

Summary of Statistical Calculations

















The **STAT** annunciator indicates that a statistical calculation was performed. Some functions return two values. In this instance, the **X** annunciator is displayed along with **STAT**. Press   to see the second value. In this case, the **X** annunciator changes to a **Y**, indicating the second value is being displayed.

Table 12-6 Statistical calculations that return two values

Keys	Description	  Displays:
 	Arithmetic mean (average) of the x -values.	Mean (average) of the y -values if you entered y -data.
 	Sample standard deviation of the x -values. NOTE: The sample standard deviation assumes that the data is a sampling of a larger, complete set of data. The population standard deviation assumes that the data constitutes the entire population.	Sample standard deviation of the y -values if you entered y -data. NOTE: The sample standard deviation assumes that the data is a sampling of a larger, complete set of data. The population standard deviation assumes that the data constitutes the entire population.
 	Population standard deviation of the x -values. NOTE: The sample standard deviation assumes that the data is a sampling of a larger, complete set of data. The population standard deviation assumes that the data constitutes the entire population.	Population standard deviation of the y -values if you entered y -data. NOTE: The sample standard deviation assumes that the data is a sampling of a larger, complete set of data. The population standard deviation assumes that the data constitutes the entire population.
y -value  	Estimate of x for a given value of y .	Correlation coefficient. NOTE: The correlation coefficient is a number in the range -1 through +1 that measures how closely the data fits the calculated line. A value of +1 indicates a perfect positive correlation, and -1 indicates a perfect negative correlation. A value close to zero indicates the line is a poor fit.
x -value  	Estimate of y for a given value of x .	Coefficient m of the current regression.
 	Mean of the x -values weighted by the y -values.	Coefficient b of the current regression.

Mean, Standard Deviations, and Summation Statistics





































You can calculate the mean (\bar{x}), sample standard deviation (S_x), and population standard deviation (σ_x), and summation statistics, n , Σx , and Σx^2 of x -data. For x, y data, you can also calculate the mean, sample standard deviation, and population standard deviation of the y -data and the summation statistics Σy , Σy^2 , and Σxy .

Example 2

A yacht captain wants to determine how long it takes to change a sail. She randomly chooses six members of her crew, observes them as they carry out the sail change, and records the numbers of minutes required: 4.5, 4, 2, 3.25, 3.5, 3.75. Calculate the mean and sample standard deviation of the times. Also, calculate the root mean square, using the formula,

$$\sqrt{\Sigma x^2 / n}.$$

Table 12-7 Example calculating mean, standard deviation, and summation statistics

Keys	Display	Description
 	STAT CLR (message flashes briefly, then disappears)	Clears statistics memory.
   	1.00	Enters first time.
 	2.00	Enters second time.
 	3.00	Enters third time.
    	4.00	Enters fourth time.
   	5.00	Enters fifth time.
    	6.00	Enters sixth time
 	3.50	Calculates the mean.
 	0.85	Calculates the sample standard deviation.
 	77.13	Displays Σx^2 .
  	6.00	Displays n .
  	3.59	Calculates the root mean square.

The standard deviations calculated by $\left[\text{2nd} \right] \left[\frac{8}{Sx.Sy} \right]$ and $\left[\text{2nd} \right] \left[\frac{8}{Sx.Sy} \right] \left[\text{2nd} \right] \left[\frac{K}{\text{SWAP}} \right]$ are the sample standard deviations. They assume that the data is a sampling of a larger, complete set of data. If the data constitutes the entire population, the true population standard deviations can be calculated by pressing $\left[\text{2nd} \right] \left[\frac{9}{\sigma x.\sigma y} \right]$ and $\left[\text{2nd} \right] \left[\frac{9}{\sigma x.\sigma y} \right] \left[\text{2nd} \right] \left[\frac{K}{\text{SWAP}} \right]$.

Example 3

The coach has four new players on the team with heights of 193, 182, 177, and 185 centimeters and weights of 90, 81, 83, and 77 kilograms. Find the mean and population standard deviation of both their heights and weights, then sum the y -data.

















Table 12-8 Example 3

Keys	Display	Description
$\left[\text{2nd} \right] \left[\frac{-M}{\text{CSTAT}} \right]$	STAT CLR (message flashes briefly, then disappears)	Clears statistics memory.
$\left[\text{1} \right] \left[\text{9} \right] \left[\text{3} \right] \left[\text{INPUT} \right] \left[\text{9} \right] \left[\text{0} \right] \left[\Sigma^+ \right]$	1.00	Enters height and weight of player 1.
$\left[\text{1} \right] \left[\text{8} \right] \left[\text{2} \right] \left[\text{INPUT} \right] \left[\text{8} \right] \left[\text{1} \right] \left[\Sigma^+ \right]$	2.00	Enters height and weight of player 2.
$\left[\text{1} \right] \left[\text{7} \right] \left[\text{7} \right] \left[\text{INPUT} \right] \left[\text{8} \right] \left[\text{3} \right] \left[\Sigma^+ \right]$	3.00	Enters height and weight of player 3.
$\left[\text{1} \right] \left[\text{8} \right] \left[\text{5} \right] \left[\text{INPUT} \right] \left[\text{7} \right] \left[\text{7} \right] \left[\Sigma^+ \right]$	4.00	Enters height and weight of player 4.
$\left[\text{2nd} \right] \left[\frac{7}{\bar{x}.\bar{y}} \right]$	184.25	Calculates mean of heights (\bar{x}).
$\left[\text{2nd} \right] \left[\frac{K}{\text{SWAP}} \right]$	82.75	Displays mean of weights (\bar{y}).
$\left[\text{2nd} \right] \left[\frac{9}{\sigma x.\sigma y} \right]$	5.80	Calculates population standard deviation for heights (σ_x).
$\left[\text{2nd} \right] \left[\frac{K}{\text{SWAP}} \right]$	4.71	Displays population standard deviation for weights (σ_y).
$\left[\text{2nd} \right] \left[\frac{\Sigma y}{6} \right]$	331.00	Displays the total of the y -values.





Linear Regression, Estimation, and Regression Modes

Linear regression is a statistical method for estimation and forecasting. It is used to find a straight line that best fits a set of x,y data. There must be at least two different x,y pairs. The straight line provides a relationship between the x - and y -variables: $y = mx + b$, where m is the slope and b is the y -intercept.

Linear Regression. Calculate r (the correlation coefficient), m , b , and as follows:

1. Clear the statistical registers by pressing  .
2. Enter the first x -value and press . The x -value is displayed.
3. Enter the corresponding y -value and press . The HP 10bII+ displays n , the number of pairs of items accumulated.
4. Continue entering x,y pairs. The n -value is increased with each entry.
5. To display r , the correlation coefficient, press    .
6. To display m , the slope, press    .
7. To display b (the y -intercept), press    .

Linear Estimation. The straight line calculated by linear regression can be used to estimate a y -value for a given x -value, or vice versa:

1. Enter the x,y data.
2. Enter the known x -value or y -value.
 - To estimate x for the given y , enter the y -value, then press  .
 - To estimate y for the given x , enter the x -value, then press  .

Example: 4

Ali's Azaleas advertises on a local radio station. For the past six weeks, the manager has kept records of the number of minutes of advertising that were purchased, and the sales for that week.

Table 12-9 Recording the number of minutes of the advertisements and sales

Week	Minutes of Advertising (x -values)	Sales (y -values)
1	2	1,400
2	1	920
3	3	1,100
4	5	2,265
5	5	2,890
6	4	2,200

What is the y -intercept, the slope, and the correlation coefficient?

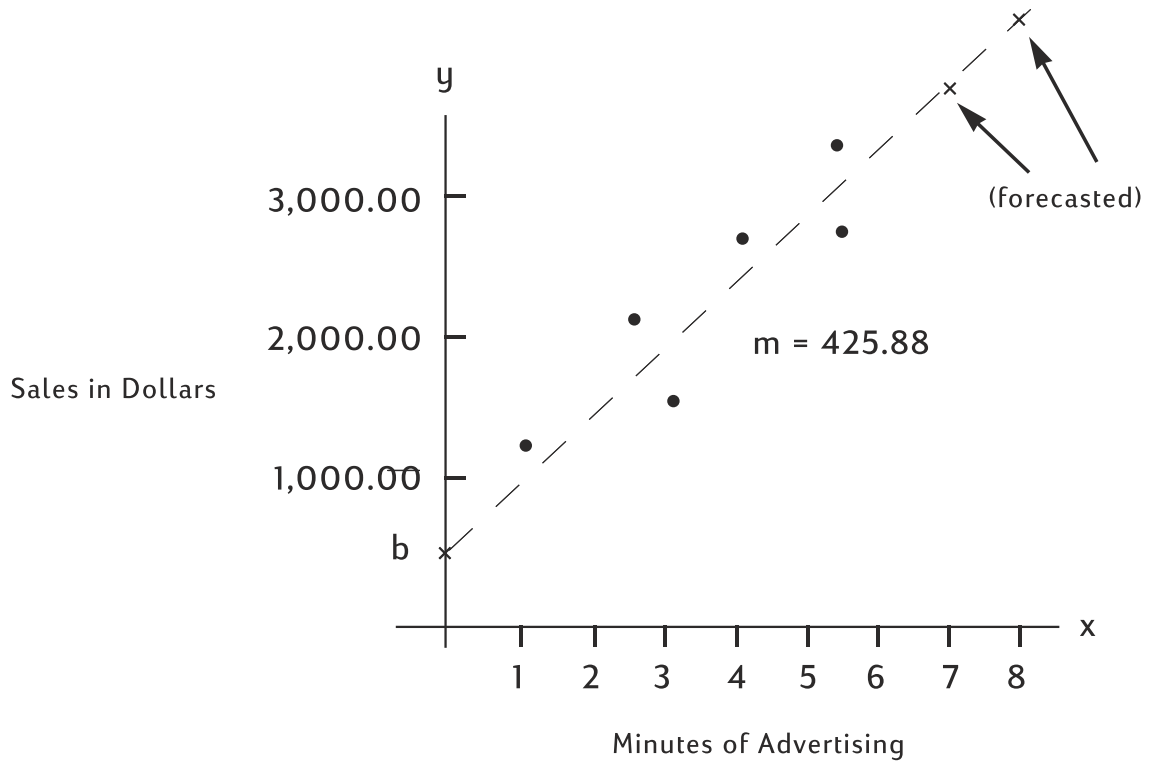

Figure 4 Diagram on forecasting sales and minutes for advertising

Table 12-10 Example for forecasting























































Keys	Display	Description
 	STAT CLR (message flashes briefly, then disappears)	Clears statistics memory.
      	1.00	Enters minutes and sales for consecutive weeks.
     	2.00	
      	3.00	
      	4.00	
      	5.00	
      	6.00	
     	376.25	Calculates y -intercept.
     	425.88	Displays slope.

Table 12-10 Example for forecasting

Keys	Display	Description
	0.90	Calculates correlation coefficient.

Estimate what the level of sales would be if the business purchased 7 or 8 minutes of advertising.

Table 12-11 Estimating the level of sales

Keys	Display	Description
	3,357.38	Estimates sales if 7 minutes of advertising were purchased.
	3,783.25	Estimates sales if 8 minutes were purchased.

How many minutes of advertising should Ali's buy to attain sales of 3,000?

Table 12-12 Estimating the minutes of advertising for 3,000 sales

Keys	Display	Description
	6.16	Estimates minutes of advertising required for 3,000 in sales.

Weighted Mean







The following procedure calculates the weighted mean of data points x_1, x_2, \dots, x_n occurring with weights y_1, y_2, \dots, y_n .

1. Use and to enter x,y pairs. The y -values are the weights of the x -values.
2. Press .

Example 5

A survey of 266 one-bedroom rental apartments reveals that 54 of them rent for 500 per month, 32 for 505, 88 for 510, and 92 for 516. What is the average monthly rent?

Table 12-13 Calculating the average monthly rent









Keys	Display	Description
	STAT CLR (message flashes briefly, then disappears)	Clears statistics memory.
	1.00	Enters first rent and its weight.
	2.00	Enters second rent and its weight.
	3.00	Enters third rent and its weight.
	4.00	Enters fourth rent and its weight.
	509.44	Calculates the weighted mean.

Regression Models and Variables

The 10bl+ has six built-in regression models, as well as the ability to calculate which model best fits the current data. These six regression modes are listed in the table below.

Table 12-14 Regression models

Number and Mode	Description
0-Best Fit	Automatically selects fit
1-Linear	$m \cdot x + b$
2-Logarithm	$m \cdot \ln(x) + b$
3-Exponential	$b \cdot e^{(m \cdot x)}$
4-Power	$b \cdot x^m$
5-Exponent	$b \cdot m^x$
6-Inverse	$m/x + b$

Press   to open the regression selection application. The initially displayed option is the current setting. Press  or  to scroll through the available regressions. With the desired model displayed, press  to select it. To exit without changing the current model, press . As an alternative to scrolling, and if you know the number of the desired model, press   followed by the desired number of the fit option.

If **BEST FIT** is selected, the 10bII+ calculates the best fit when $\boxed{\downarrow} \boxed{\frac{4}{\hat{x},r}}$, $\boxed{\downarrow} \boxed{\frac{5}{\hat{y},m}}$, or $\boxed{\downarrow} \boxed{\frac{6}{\hat{x}_{w,b}}}$ is pressed. When selected, **BEST FIT** flashes briefly, followed by the chosen fit. The selected regression will remain set until a new one is selected, or the statistics memory is cleared.

When the statistics memory is cleared using $\boxed{\downarrow} \boxed{\frac{-M}{CSTAT}}$, the current regression model is set back to **LINEAR**.

Probability Calculations

In many probability calculations, specific methods of counting possible outcomes are required as part of a process to determine the likelihood of certain results. The three main operations that allow this are:

- $!$ factorial
- ${}_n P_r$ permutations
- ${}_n C_r$ combinations

Factorial

Factorial ($!$) is a mathematical operator that instructs you to multiply the current number by all previous whole numbers. Writing out so many numbers can be cumbersome, so mathematicians use $!$ to signify this process. For example:

$$5! \text{ is equivalent to } 5 \times 4 \times 3 \times 2 \times 1 = 120.$$

On the 10bII+, the input value n must be within $-253 < n < 253$. The gamma function is used to calculate $n!$ for non-integer or negative values.

Permutations











The ${}_n P_r$ function calculates the number of different arrangements, or permutations, of n items taken r at a time. No item can occur more than once in a set of r items, and different orders of the same r items are counted separately. This is calculated using the formula:

$$PERMUTATIONS = \frac{n!}{(n-r)!}$$

Example

Using five books labeled A, B, C, D, and E, how many different ways can three books be placed on a shelf?

Table 12-15 Example calculating permutations

Keys	Display	Description
    	60.00	Calculates permutations of n items taken r at a time.
or, using  :		
    	60.00	

Combinations











The nCr function calculates the number of different sets, or combinations, of n items taken r at a time. No item can occur more than once in the set of r items, and different orders of the same r items are not counted separately. This is calculated using the formula:

$$COMBINATIONS = \frac{n!}{(n-r)!r!}$$

Example





Using five colored balls, how many different color combinations of three colors can be chosen?

Table 12-16 Example calculating combinations

Keys	Display	Description
    	10.00	Calculates combinations of n items taken r at a time.
or, using  :		
    	10.00	

Random Number and Seed













The 10bII+ includes a random number generator function that generates a pseudo-random number in the range $0 < x < 1$. To store a seed value, type a positive number and press

   . Storing a value of 0 will select a random number and store it as the seed value.

Example

Store a seed value of 42; set the number display to 9. Then generate three random numbers.













Table 12-17 Example storing a seed value and generating random numbers

Keys	Display	Description
    	42.00	Stores 42 as the random number generator seed.
 	42.000000000	Set display precision.
	.199873749	Generate first random number.
	.863046890	Generate second random number.
	.504024868	Generate third random number.
 	.50	Reset display to default setting.

Advanced Probability Distributions

The 10bII+ allows easy calculation of the Z and Student's T probability distribution values. In addition, it allows inverse calculations of both functions. The values are calculated using the lower tail probability. This lower tail probability corresponds to the area under the curve to the left of the input. If you need a value other than a lower tail, such as a two-sided value, please see the conversion instructions at the end of this chapter.

Table 12-18 Advanced probability keys

Keys	Description
 	Calculates a cumulative normal probability given a Z-value.
   	Calculates a Z-value given a cumulative normal probability.
 	Calculates the cumulative Student's T probability given degrees of freedom and a T-value.
   	Calculates a T-value given degrees of freedom and the cumulative Student's T probability.

These distribution functions replace the statistical tables found in the back of textbooks. Unlike the textbook, the calculator can calculate any value, not just a limited selection found in the table.

Normal Lower Tail Probability

To calculate the area under the curve to the left of z (the lower tail probability), enter the z -value and press $\boxed{\rightarrow}$ $\boxed{\frac{Z \Rightarrow P}{3}}$. This function calculates the probability that a standard normal random variable, Z , is less than z .

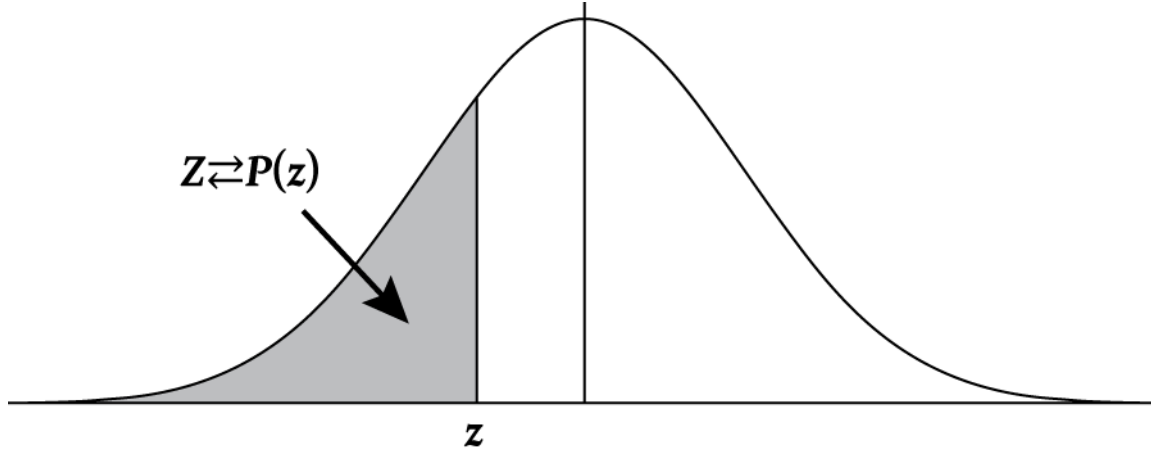

Figure 5

Example

The variable Z is a standard normal random variable. What is the probability that Z is less than -1.7 ?

Table 12-19 Probability example

Keys	Display	Description
$\boxed{\rightarrow}$ $\boxed{=}$ $\boxed{6}$ \boxed{DISP}	.000000	Set display precision.
$\boxed{1}$ $\boxed{.}$ $\boxed{7}$ $\boxed{+/-}$ $\boxed{\rightarrow}$ $\boxed{\frac{Z \Rightarrow P}{3}}$.044565	Calculate the probability.

z	.00	.01
-1.90	.0287	.0281
-1.80	.0359	.0351
-1.70	.0446	.0436
-1.60	.0548	.0537

Figure 6

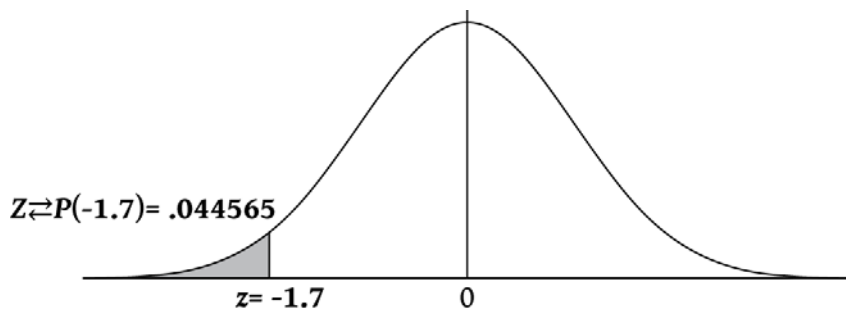

Figure 7

Inverse of Normal Lower Tail Probability

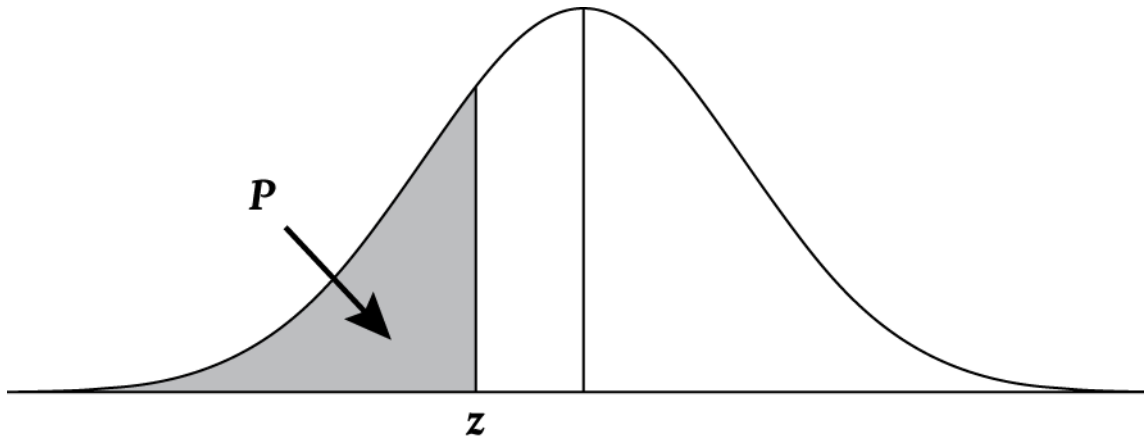

Figure 8

What is the z-value corresponding to a lower tail cumulative probability of .025?

Table 12-20 Example calculating z-value (lower tail)

Keys	Display	Description
	-1.959964	Calculate the corresponding z-value.

z	.05	.06
-2.00	.0202	.0197
-1.90	.0256	.0250
-1.80	.0322	.0314
-1.70	.0401	.0392

Figure 9

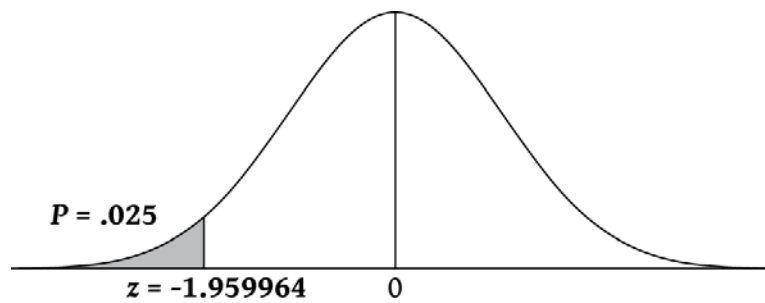

Figure 10

Student's T Probability Lower Tail

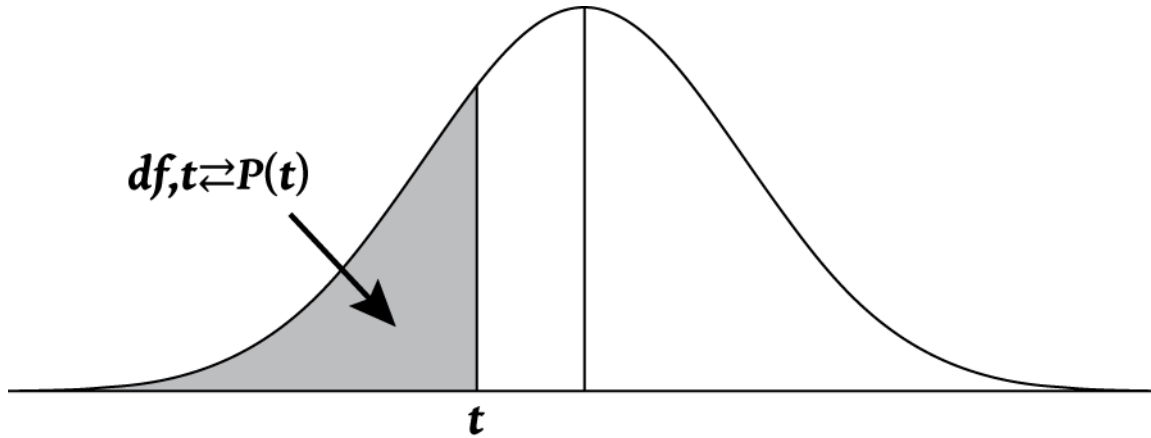

Figure 11

To calculate the area under the Student's T Distribution curve, first enter the degrees of freedom, followed by the t -value. It is a two-number function, so it may be entered as either an in-line function, or by using .

Example:

What is the lower tail probability associated with a Student's T distribution with 8 degrees of freedom (df_1) with a t -value of -1.86?

Table 12-21 Example of Student's t (lower tail)

Keys	Display	Description
$\boxed{8}$ $\boxed{\uparrow}$ $\boxed{2}$ $\boxed{1}$ $\boxed{\cdot}$ $\boxed{8}$ $\boxed{6}$ $\boxed{+/-}$ $\boxed{=}$.0499653	Calculates the lower tail probability.
or, using <input type="text" value="INPUT"/> :		
$\boxed{8}$ <input type="text" value="INPUT"/> $\boxed{1}$ $\boxed{\cdot}$ $\boxed{8}$ $\boxed{6}$ $\boxed{+/-}$ $\boxed{\uparrow}$ $\boxed{2}$		Returns the same results.

df	.05	.01
6	-1.943	-3.143
7	-1.895	-2.998
8	-1.860	-2.896
9	-1.833	-2.861

$$df, t \Leftrightarrow P(-1.86) = .0499653$$

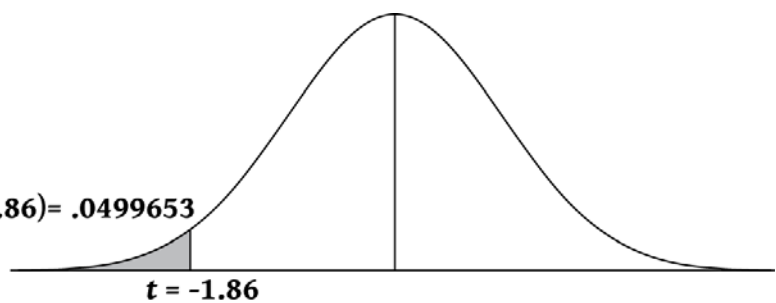

Figure 12

Figure 13

Inverse of Student's t Probability Lower Tail

If you know the lower tail probability, P , and you want to calculate t , enter the degrees of freedom (df_1), followed by , then P . Press to calculate t .

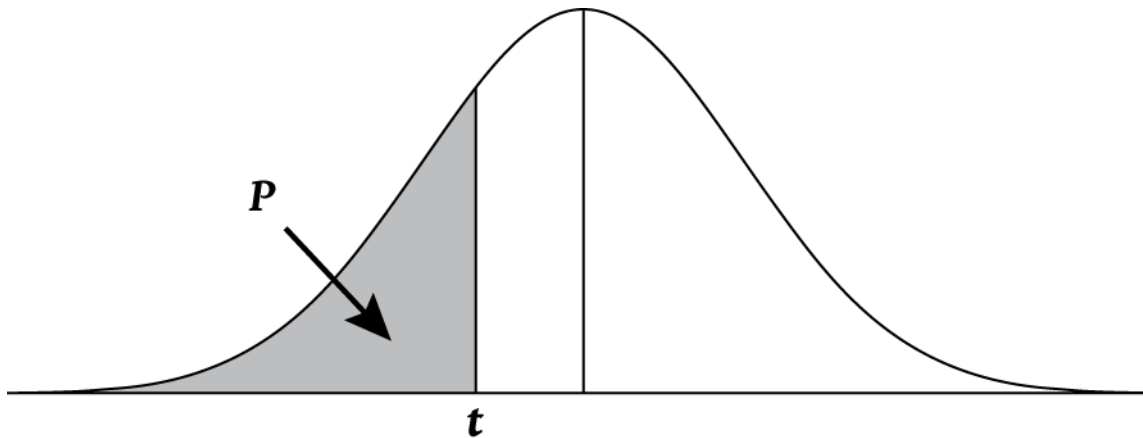

Figure 14

Example

A hypothesis test requires a critical t -value from the Student's T distribution with 26 degrees of freedom. Find the t -value for a lower tail probability of .05.

Table 12-22 Example calculating the t -value (lower tail)

Keys	Display	Description
<input type="text" value="2"/> <input type="text" value="6"/> <input type="text" value="↑"/> <input type="text" value="INV"/> <input type="text" value="df,t↔P"/> <input type="text" value="M+"/> <input type="text" value="2"/> <input type="text" value="."/> <input type="text" value="0"/> <input type="text" value="5"/> <input type="text" value="="/>	-1.705618	Enter degrees of freedom and the probability, and calculates the lower tail t -value.
or, using <input type="text" value="INPUT"/> :		
<input type="text" value="2"/> <input type="text" value="6"/> <input type="text" value="INPUT"/> <input type="text" value="."/> <input type="text" value="0"/> <input type="text" value="5"/> <input type="text" value="↑"/> <input type="text" value="INV"/> <input type="text" value="df,t↔P"/> <input type="text" value="M+"/> <input type="text" value="2"/>		Returns the same results.

df	.05	.01
24	-1.711	-2.492
25	-1.708	-2.485
26	-1.706	-2.479
27	-1.703	-2.473

Figure 15

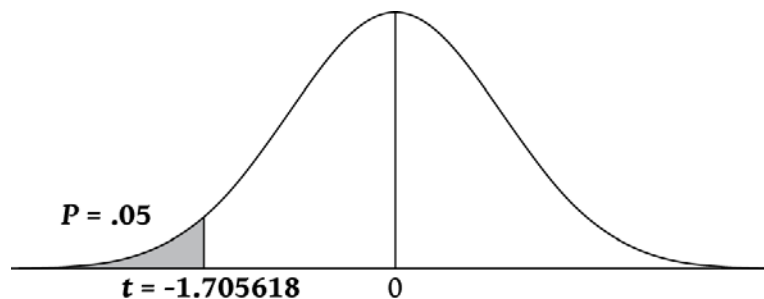

Figure 16

Conversions from Lower Tail

The distribution functions on the 10bll+ return values for the lower tail cumulative probability. The lower tail probability corresponds to the area under the curve to the left of the given value. Sometimes you will want to work with areas other than the lower tail. It is easy to convert from lower tail to another area as long as you keep in mind that the total area under the curve is equal to 1, and the Normal and the Student's T distributions are symmetrical. In other words, the portion of the curve to the left of zero is a mirror image of the portion of the curve to the right of zero.

Example 1

The random variable Z is a standard normal random variable. What is the probability that z is greater than -1.7 ?

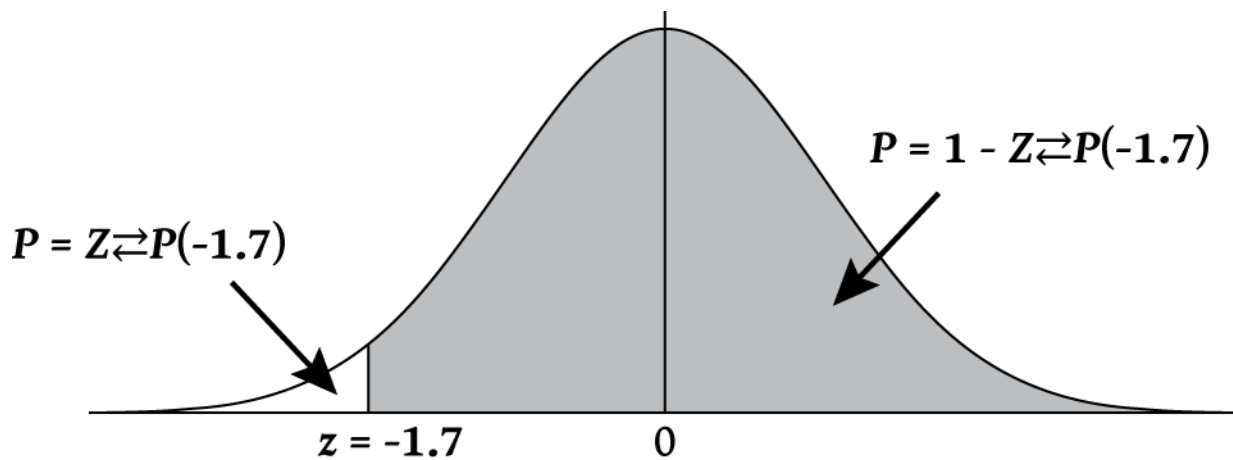

Figure 17

The probability that z is greater than -1.7 is the area of the curve to the right of -1.7 . You can calculate the area to the left of -1.7 and subtract it from 1 (total area of the curve).

Table 12-23 Example converting from lower tail

Keys	Display	Description
$\boxed{1}$ $\boxed{\cdot}$ $\boxed{7}$ $\boxed{+/-}$ $\boxed{\rightarrow}$ $\boxed{Z \Leftarrow P}$ $\boxed{3}$.044565	Calculate the lower tail area. Since the area is -1.7 , change the sign.
$\boxed{+/-}$ $\boxed{+}$ $\boxed{1}$ $\boxed{=}$.955435	Subtracts the lower tail from 1.

Example 2

The variable Z is a standard normal random variable. What is the probability that z is greater than 1.2 or less than -1.2?

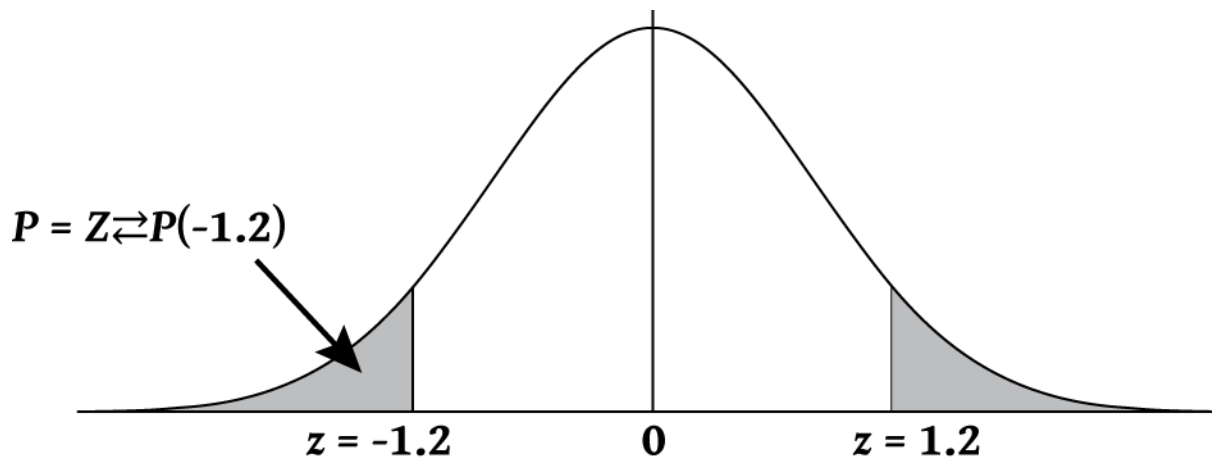

Figure 18

The desired area is to the right of 1.2 and to the left of -1.2. Since normal distributions are symmetrical, and the areas are the same, you can calculate the lower tail area and simply multiply by 2.

Table 12-24 Example converting from lower tail

Keys	Display	Description
1 . 2 +/- \uparrow $Z⇐P$ 3	.115070	Calculate the lower tail area and store the value.
x 2 =	.230139	Calculates the result.

Example 3

The variable Z is a standard normal random variable. Find z so that the probability that Z is less than z and greater than $-z$ is equal to 0.95.

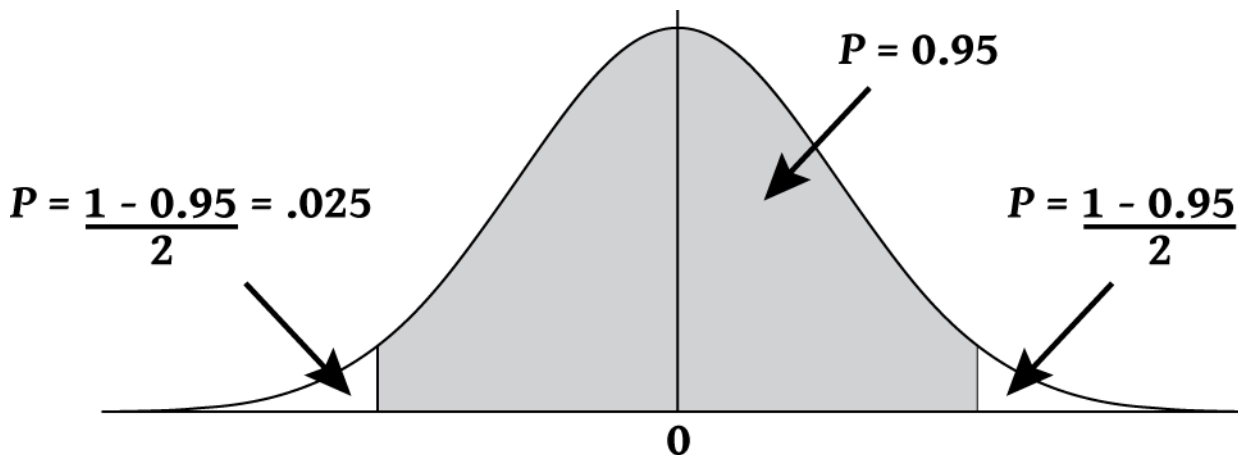

Figure 19

The given area is 0.95. The area not included is $1 - 0.95 / 2 = 0.025$. Since the normal distribution is symmetrical, half of the desired area is in the lower tail, $.05 / 2 = .025$. The desired area corresponds to a lower tail probability of .025.

Table 12-25 Example converting from lower tail (the inner area)

Keys	Display	Description
\cdot 0 2 5 \uparrow INV $Z \leftrightarrow P$ M+ 3	-1.959964	Returns desired value of z .

13 Additional Examples

Business Applications

Setting a Sales Price

One method for setting the per unit sales price is to determine the cost of production per unit, and then multiply by the desired rate of return. For this method to be accurate, you must identify all costs associated with the product.

The following equation calculates unit price based on total cost and rate of return:

$$\text{PRICE} = \text{TOTAL COST} \div \text{NUMBER OF UNITS} \times (1 + (\%RTN \div 100))$$

Example

To produce 2,000 units, your cost is 40,000. You want a 20% rate of return. What price should you charge per unit?

Table 13-1 Calculating the price charged per unit

Keys	Display	Description
	40,000.00	Enters cost.
	20.00	Calculates unit cost.
	24.00	Calculates the unit sales price.

Forecasting Based on History

One method of forecasting sales, manufacturing rates, or expenses is reviewing historical trends. Once you have historical data, the data are fit to a curve that has time on the x-axis and quantity on the y-axis.

Example

Given the following sales data, what are the sales estimates for years six and seven?

Table 13-2 Sales data

Year	Sales
1	10,000
2	11,210
3	13,060
4	16,075
5	20,590

Table 13-3 Calculating the sales estimates for years six and seven

Keys	Display	Description
	0.00	Clears statistics registers.
	1.00	Enters first year and sales for that year.
	2.00	Enters second year's data.
	3.00	Continues data entry.
	4.00	
	5.00	
	22,000.50	Estimates sales for year six.
	24,605.00	Estimates sales for year seven.

Cost of Not Taking a Cash Discount

A cash discount gives a buyer a reduction in price if the payment is made within a specified time period. For example, "2/10, NET/30" means that the buyer can deduct 2 percent if payment is made within 10 days. If payment is not made within 10 days, the full amount must be paid by the 30th day.

You can use the equation shown below to calculate the cost of failing to take the cash discount. The cost is calculated as an annual interest rate charged for delaying payment.

$$COST\% = \frac{DISC\% \times 360 \times 100}{((100 - DISC\%) \times (TOTAL\ DAYS - DISC\ DAYS))}$$

DISC% is the discount percent if the payment is made early. *TOTAL DAYS* is the total number of days until the bill must be paid. *DISC DAYS* is the number of days for which the discount is available.

Example

You receive a bill with the credit terms 2/10, NET/30. What is the cost of not taking the cash discount?

Table 13-4 Calculating the cost without the cash discount

Keys	Display	Description
	72,000.00	Calculates numerator in equation.
	98.00	Parentheses force order of calculation.
	36.73	Calculates, as an annual percentage rate, cost of not taking discount.

Loans and Mortgages

Simple Annual Interest

Example

Your good friend needs a loan to start his latest enterprise and has asked you to lend him 450 for 60 days. You lend him the money at 10% simple annual interest, to be calculated on a 365-day basis. How much interest will he owe you in 60 days, and what is the total amount owed?

This equation is used for calculating simple annual interest using a 365 day year:

$$INTEREST = \frac{LOAN\ AMOUNT \times INTEREST\% \times TERM\ OF\ LOAN\ (IN\ DAYS)}{365}$$

Table 13-5 Calculating the total amount owed

Keys	Display	Description
	0.10	Stores interest.
	7.40	Calculates interest owed.
	457.40	Calculates the total amount owed.

Continuous Compounding

The equation for calculating an effective rate for continuous compounding is:

$$EFF\% = (e^{(NOM\% \div 100)} - 1) \times 100$$

























To solve a continuous compounding problem complete these steps:

1. Compute the annual effective rate using the above equation.
2. Either use this effective rate in your calculations with an annual period ($P/YR = 1$) or convert this rate so that it applies to your payment period. In the following example, $P/YR = 12$ so you have to calculate a new $NOM\%$ using the interest rate conversion application with P/YR equal to 12.

Example

You currently have 4,572.80 in an account at Dream World Investments that earns 18% annual interest compounded continuously. At the end of each month, you deposit 250.00 in the account. What will the balance be after 15 years?

Table 13-6 Calculating the annual nominal rate

Keys	Display	Description
  	0.18	Divides nominal rate by 100.
  	1.20	Raises e to 0.18 power.
      	19.72	Calculates annual effective rate.
  	19.72	Stores effective rate.
    	12.00	Sets payments per year.
  	18.14	Calculates the annual nominal rate for a monthly payment period.























Set to End Mode. Press    if **BEGIN** annunciator is displayed.

Table 13-7 Calculating the balance amount after 15 years

Keys	Display	Description
    	180.00	Stores number of months.
    	-250.00	Stores regular payment.
       	-4,572.80	Stores current balance as a negative value (like an initial investment).
	297,640.27	Calculates the account balance after 15 years of payments with 18% interest compounded continuously.

Yield of a Discounted (or Premium) Mortgage

The annual yield of a mortgage bought at a discount or premium can be calculated given the original mortgage amount (PV), interest rate (I/YR), periodic payment (PMT), balloon payment amount (FV), and the price paid for the mortgage (new PV).

Remember the cash flow sign convention: money paid out is negative; money received is positive.

Example

An investor wishes to purchase a 100,000 mortgage taken out at 9% for 20 years. Since the mortgage was issued, 42 monthly payments have been made. The loan is to be paid in full (a balloon payment) at the end of its fifth year. What is the yield to the purchaser if the price of the mortgage is 79,000?

Step 1

Calculate PMT . Make sure $FV = 0$.

























Set to End Mode. Press   if **BEGIN** annunciator is displayed.

Table 13-8 Calculating the monthly payment

Keys	Display	Description
   	12.00	Sets payments per year.
 	9.00	Stores interest rate.
   	240.00	Stores number of months.
        	-100,000.00	Stores original amount of mortgage.
 	0.00	Enters amount left to pay after 20 years.
	899.73	Calculates the regular payment.

Step 2

Enter the new value for N indicating when the balloon occurs, then find FV , the amount of the balloon.

É

Table 13-9 Calculating the balloon payment



Keys	Display	Description
  	899.73	Rounds payment to two decimal places for accuracy.

Table 13-9 Calculating the balloon payment

Keys	Display	Description
	60.00	Stores number of payments until balloon.
	88,706.74	Calculates the balloon payment (add to final payment).

Step 3

Enter actual, current values for *N* and *PV*; then find the new *I/YR* for the discounted mortgage with balloon.

Table 13-10

Keys	Display	Description
	18.00	Stores remaining number of payments.
	-79,000.00	Stores price of mortgage.
	20.72	Calculates the return on this discounted mortgage.

Annual Percentage Rate for a Loan With Fees

The Annual Percentage Rate, *APR*, incorporates fees usually charged when a mortgage is issued, which effectively raises the interest rate. The actual amount received by the borrower (the *PV*) is reduced, while the periodic payments remain the same. The *APR* can be calculated given the term of the mortgage (*N* periods), the annual interest rate (*I/PR*), the mortgage amount (new *PV*), and the amount of the fee.

Remember the cash flow sign convention: money paid out is negative; money received is positive.

Example: APR for a Loan With Fees

A borrower is charged two points for the issuance of a mortgage. (One point is equal to 1% of the mortgage amount.) If the mortgage amount is 160,000 for 30 years and the annual interest rate is 8.5% with monthly payments, what APR is the borrower paying?

Set to End Mode. Press if **BEGIN** annunciator is displayed.

Table 13-11 Calculating the annual percentage rate considering fees

Keys	Display	Description
	12.00	Sets payments per year.
	8.50	Stores interest rate.

Table 13-11 Calculating the annual percentage rate considering fees

Keys	Display	Description
	360.00	Stores length of mortgage.
	160,000.00	Stores original amount of mortgage.
	0.00	The loan will be completely paid off in 30 years.
	-1,230.26	Calculates payment.
	160,000.00	Recalls loan amount.
	156,800	Subtracts points.
	8.72	Calculates APR, considering fees.

Example: Interest-Only Loan With Fee

A 1,000,000, 10-year, 12% (annual interest) *interest-only* loan has an origination fee of three points. What is the yield to the lender? Assume that monthly payments of interest are made.

Set to End mode. Press if **BEGIN** annunciator is displayed.

Table 13-12 Calculating the annual percentage rate

Keys	Display	Description
	12.00	Sets payments per year.
	12.00	Stores interest rate.
	120.00	Stores length of mortgage.
	1,000,000.00	Stores original amount of mortgage.
	-1,000,000.00	Enters amount due at end of term. Payments are interest only so entire loan amount is due.
	-10,000.00	Calculates interest-only payments.
	1,000,000.00	Recalls loan amount.
	970,000.00	Subtracts points.

Table 13-12 Calculating the annual percentage rate

Keys	Display	Description
	12.53	Calculates APR.

Loan With a Partial (Odd) First Period

TVM calculations apply to financial transactions where each payment period is the same length. However, situations exist where the first payment period is not the same length as the remaining periods. This first period is sometimes called an *odd* or *partial first period*.

If interest is applied to an odd first period, it is usually calculated as simple interest. So using the HP 10bII+ to do a payment calculation with an odd first period is a two step process:

1. Calculate the amount of simple interest that accrues during the fractional first period and add it to the loan amount. This is the new *PV*. You must be able to calculate the length of the odd first period as a fraction of the whole period. (For example, a 15-day odd first period would be 0.5 periods assuming a whole period to be a 30-day month.)
2. Calculate the payment using the new *PV*, with *N* equal to the number of full periods. Use Begin mode if the number of days until the first payment is less than 30; otherwise use End mode.

Example

A 36-month loan for 4,500 has an annual rate of 15%. If the first monthly payment is made in 46 days, what is the monthly payment amount assuming 30-day months?

The odd first period in this example is 16 days.

Set to End mode. Press if **BEGIN** annunciator is displayed.

Table 13-13 Calculating the monthly payment amount

Keys	Display	Description
	12.00	Sets payments per year.
	15.00	Stores interest rate.
	1.25	Calculates periodic interest rate.
	0.67	Multiplies by fraction of a period.
	30.00	Calculates amount of simple interest owed for odd period.
	4,530.00	Adds this simple interest to present value.
	36.00	Stores term of loan.

Table 13-13 Calculating the monthly payment amount

Keys	Display	Description
	0.00	Enters amount left to pay after 36 payments.
	-157.03	Calculates the payment amount.

Automobile Loan

Example

You are buying a new 14,000.00 sedan. Your down payment is 1,500 and you are going to finance the remaining 12,500. The car dealer is offering two choices for financing:

- A 3-year loan with an annual interest rate of 3.5%.
- A 3-year loan with an annual interest rate of 9.5% and a 1,000.00 rebate.

With which choice do you pay less for the car?

Set to End mode. Press if **BEGIN** annunciator is displayed.

Calculate the first option:

Table 13-14 Calculating the annual interest rate of 3.5%









Keys	Display	Description
	12.00	Sets payments per year.
	36.00	Stores known values.
	12,500.00	Stores loan amount.
	0.00	
	3.50	Stores first interest rate.
	-366.28	Calculates payment.
	-13,185.94	Calculates total interest and principal.

Calculate the second option:

Table 13-15 Calculating the annual interest rate of 9.5%

Keys	Display	Description
	11,500.00	Stores loan amount with rebate.

Table 13-15 Calculating the annual interest rate of 9.5%

Keys	Display	Description
   	9.50	Stores second interest rate.
	-368.38	Calculates payment.
   	-13,261.64	Calculates total interest and principal.

The first option costs slightly less.

Canadian Mortgages





























In Canadian mortgages, the compounding and payment periods are not the same. Interest is compounded semi-annually while payments are made monthly. To use the TVM application in the HP 10bII+, you need to calculate a *Canadian mortgage factor* (which is an adjusted interest rate) to store in *I/YR*.

For additional information on interest rate conversions, see *Interest Rate Conversions* in Ch. 6.

Example

What is the monthly payment required to fully amortize a 30-year, 130,000 Canadian mortgage if the annual interest rate is 12%?

Table 13-16 Calculating the monthly payment for Canadian mortgage

Keys	Display	Description
   	12.00	Stores known nominal percentage and number of compounding periods.
  	2.00	
 	12.36	Calculates annual effective rate.
   	12.00	Sets payments per year.
 	11.71	Calculates <i>Canadian mortgage factor</i> (adjusted interest rate).
      	130,000	Stores other known values for mortgage.
     	360.00	
	-1,308.30	Calculates monthly payment for Canadian mortgage.

What if ... TVM Calculations

One of the most valuable aspects of the HP 10bII+'s TVM application is the ease with which it handles the question "what if ..." in financial calculations. For example, one of the most popular "what if ..." questions is, "What if the interest rate changes to ...? How will that affect my payment?" To answer this question, once you have calculated a payment based on one interest rate, all you need to do is enter the new interest rate and recalculate *PMT*.

Some of the examples earlier in this manual have included some brief encounters with "what if ..." questions, but a more complete example follows.

Example

You are about to sign on the dotted line for a 30-year, 735,000 mortgage, on a vacation home. The annual interest rate is 11.2%.

Part 1

What will your payments be at the end of the month?

























Set to End mode. Press   if **BEGIN** annunciator is displayed.

Table 13-17 Calculating the monthly payment

Keys	Display	Description
   	12.00	Sets payments per year.
      	735,000.00	Stores known values.
    	11.20	
   	360.00	
 	0.00	
	-7,110.88	Calculates payment.

Part 2

Your company's regular payroll is generated every other Friday. The bank agrees to automatically draw payments of 3,555.00 out of each paycheck (approximately half of what a monthly payment would be) and adjust the payment period accordingly (26 compounding periods per year). What would be the new term of the loan?

Table 13-18 Calculating the number of years required to pay off the loan







Keys	Display	Description
     	-3,555.00	Enters new payment.

Table 13-18 Calculating the number of years required to pay off the loan

Keys	Display	Description
	26.00	Sets payments per year for every two weeks.
	514.82	Calculates number of biweekly payments.
	19.80	Displays years required to pay off the loan.

Part 3

What if you had monthly payments as in part 1, but chose a 15-year term? What would your new payment be? What would be the total interest paid on the contract?

Table 13-19 Calculating the total interest paid on the contract

Keys	Display	Description
	12.00	Sets payments per year.
	180.00	Stores new term.
	-8,446.53	Calculates payment for shorter term.
	-1,520,374.70	Calculates total paid.
	-785,374.70	Displays the total interest paid on the contract.

Savings

Saving for College Costs

Suppose you start saving now to accommodate a future series of cash outflows. An example of this is saving money for college. To determine how much you need to save each period, you must know when you'll need the money, how much you'll need, and at what interest rate you can invest your deposits.

Example

Your oldest daughter will attend college in 12 years and you are starting a fund for her education. She will need 15,000 at the beginning of each year for four years. The fund earns 9% annual interest, compounded monthly, and you plan to make monthly deposits, starting at the end of the current month. The deposits cease when she begins college. How much do you need to deposit each month?

This problem is solved in two steps. First calculate the amount you'll need when she starts college. Start with an interest rate conversion because of the monthly compounding.

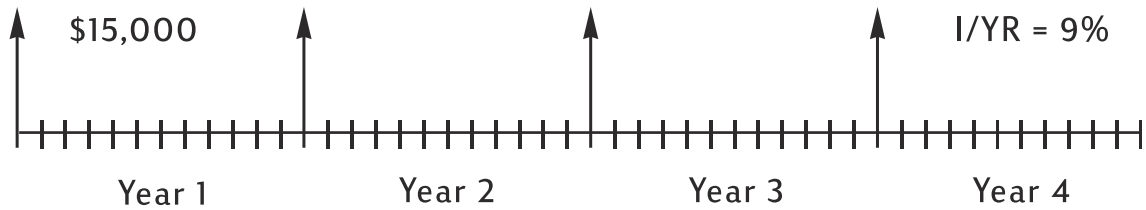











Figure 20 Cash flow diagram

Set to Begin mode. Press   if **BEGIN** annunciator is not displayed.

Table 13-20 Calculating the annual effective rate















Keys	Display	Description
  	9.00	Stores annual nominal rate.
   	12.00	Stores number of compounding periods used with this nominal rate.
 	9.38	Calculates annual effective rate.

When compounding occurs only once per year, the effective rate and the nominal rate are the same.

 9.38 Stores effective rate as annual rate.

Set to Begin mode. Press   if **BEGIN** annunciator is not displayed.

Table 13-21 Calculating the amount required at the start

Keys	Display	Description
  	1.00	Sets 1 payment per year.
    	15,000.00	Stores annual withdrawal.
		
 	4.00	Stores number of withdrawals.
 	0.00	Stores balance at the end of four years.
	-52,713.28	Calculates the amount required when your daughter starts college.

Then use that *PV* as the *FV* on the following cash flow diagram, and calculate the *PMT*.

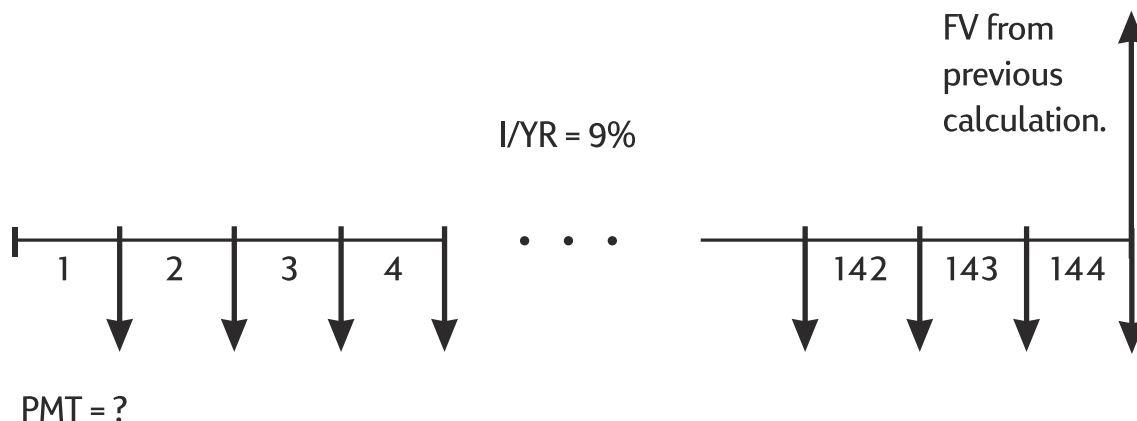

Figure 21 Cash flow diagram (Calculate PMT)

Set to End mode. Press if **BEGIN** annunciator is displayed.

Table 13-22 Calculating the monthly deposit required

Keys	Display	Description
	52,713.28	Stores amount you need.
	0.00	Stores amount you are starting with.
	12.00	Sets payments per year.
	144.00	Stores number of deposits.
	9.00	Stores interest rate.
	-204.54	Calculates monthly deposit required.

Gains That Go Untaxed Until Withdrawal

You can use the TVM application to calculate the future value of a tax-free or tax-deferred account. (Current tax laws and your income determine whether both interest and principal are tax-free. You can solve for either case.)

The purchasing power of that future value depends upon the inflation rate and the duration of the account.















































Example

You are considering opening a tax-deferred account with a dividend rate of 8.175%. If you invest 2,000 at the beginning of each year for 35 years, how much will be in the account at retirement? How much will you have paid into the account? How much interest will you have earned? If your post-retirement tax rate is 15%, what will the after tax future value of the

account be? Assume that only the interest is taxed (assume the principal was taxed before deposit). What is the purchasing power of that amount, in today's dollars, assuming a 4% inflation rate?

Set to Begin mode. Press   if **BEGIN** annunciator is not displayed.

Table 13-23 Calculating the purchasing power of the amount

Keys	Display	Description
  	1.00	Sets 1 payment per year.
  	35.00	Stores number of periods and interest rate.
     	8.18	
 	0.00	Stores amount you start with.
     	-2,000.00	Stores amount of annual payment.
	387,640.45	Calculates amount in account at retirement.
     	-70,000.00	Calculates amount you have paid into account by retirement.
   	317,640.45	Calculates interest account has earned by retirement.
    	47,646.07	Calculates taxes at 15% of interest.
    	339,994.39	Calculates after-tax <i>FV</i> .
	339,994.39	Stores after-tax future value in <i>FV</i> .
    	-86,159.84	Calculates the present value purchasing power of after-tax <i>FV</i> , assuming a 4% inflation rate.

Value of a Taxable Retirement Account

This problem uses the TVM application to calculate the future value of a taxable retirement account that receives regular, annual payments beginning today (Begin mode). The annual tax on the interest is paid out of the account. (Assume the deposits have been taxed already.)

Example

If you invest 3,000 each year for 35 years, with dividends taxed as ordinary income, how much will you have in the account at retirement? Assume an annual dividend rate of 8.175%, a tax rate of 28%, and that payments begin today. What is the purchasing power of that amount in today's dollars, assuming 4% inflation?

































Set to Begin mode. Press   if **BEGIN** annunciator is not displayed.

Table 13-24 Calculating the purchasing power, assuming 4% inflation rate

Keys	Display	Description
  	1.00	Sets 1 payment per year.
  	35.00	Stores number of payment periods until retirement.
         	5.89	Calculates interest rate diminished by tax rate.
	5.89	Stores adjusted interest rate.
 	0.00	Stores amount you are starting with.
     	-3,000.00	Stores amount of annual payment.
	345,505.61	Calculates amount in account at retirement.
    	-87,556.47	Calculates present value purchasing power of FV, assuming a 4% inflation rate.

Cash Flow Examples

Wrap-Around Mortgages

A wrap-around mortgage is a combination of refinancing a mortgage and borrowing against real estate equity. Usually the two unknown quantities in the wrapped mortgage are the new payment and the rate of return to the lender. To arrive at a solution, you need to use both the TVM and the cash flow applications.

Example

You have 82 monthly payments of 754 left on your 8% mortgage, leaving a remaining balance of 47,510.22. You would like to wrap that mortgage and borrow an additional 35,000 for another investment. You find a lender who is willing to "wrap" an 82,510.22 mortgage at 9.5% for 15 years. What are your new payments and what return is the lender getting on this wrap-around mortgage?

The payment calculation is a straightforward TVM payment calculation using the new amount as the *PV*.





























Set to End mode. Press   if **BEGIN** annunciator is displayed.

Table 13-25 Calculating the payment

Keys	Display	Description
  	0.00	Clears TVM registers.
   	12.00	Sets payments per year.
        	82,510.22	Stores loan amount on which your new payment is calculated.
   	9.50	Stores interest rate.
 	0.00	Stores final balance.
   	180.00	Stores number of monthly payments you will make.
	-861.59	Calculates your new payment.

Then, to calculate the lender's return, enter cash flows that represent the *complete* picture of the wrap-around mortgage from the lender's point of view:

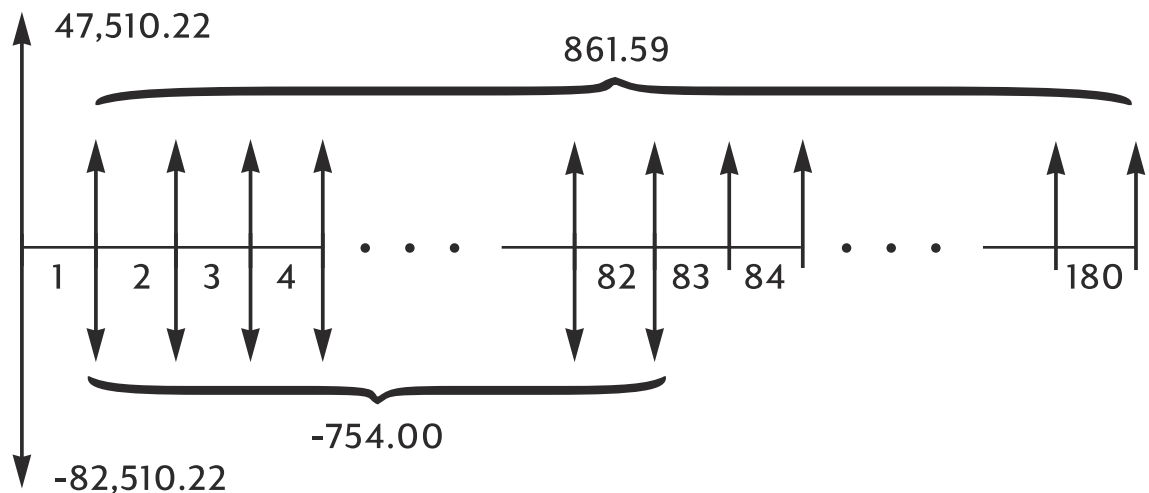

Figure 22 Cash flow diagram (Wrap-around mortgage)

When you group the above cash flows, you'll find that:

$$CF_0 = 47,510.22 - 82,510.22 = -35,000$$

$$CF_1 = 861.59 - 754.00 = 107.59$$

$$N_1 = 82$$

$$CF_2 = 861.59$$

$$N_2 = 180 - 82 = 98$$

Table 13-26 Calculating the annual return

Keys	Display	Description
$\boxed{3} \boxed{5} \boxed{0} \boxed{0} \boxed{0} \boxed{+/-} \boxed{CF_0}$	CF0 -35,000.00	Enters 35,000 for loan amount.
$\boxed{RCL} \boxed{PMT} \boxed{+/-} \boxed{-} \boxed{7} \boxed{5} \boxed{4} \boxed{CF_j}$	CF1 107.59	Enters net payment for first 82 months.
$\boxed{8} \boxed{2} \boxed{\rightarrow} \boxed{CF_j/N_j}$	n1 82.00	Enters number of times payment occurs.
$\boxed{RCL} \boxed{PMT} \boxed{+/-} \boxed{CF_j}$	CF2 861.59	Enters net payment for next 98 months.
$\boxed{1} \boxed{8} \boxed{0} \boxed{-} \boxed{8} \boxed{2} \boxed{\rightarrow} \boxed{CF_j/N_j}$	n2 98.00	Enters number of times payment occurs.
$\boxed{\rightarrow} \boxed{CST} \boxed{IRR/YR}$	10.16	Calculates annual return.

Net Future Value

The net future value can be calculated by using the TVM keys to *slide* the net present value (NPV) forward on the cash flow diagram.

Example: Value of a Fund

You have made the following deposits over the past two years into a money market fund earning 8.8%. What is the current balance of the account?

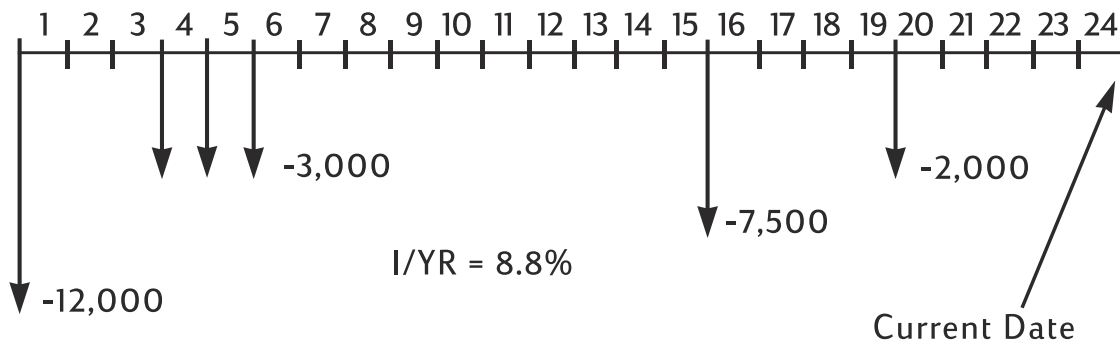

Figure 23 Cash flow diagram

Appendix A: Batteries and Answers to Common Questions

Power and Batteries

The calculator is powered by two 3-volt lithium button-cell batteries, CR2032.

When changing batteries, use only fresh button-cell batteries. Both batteries must be changed at the same time.

Do not use rechargeable batteries.

Low Power Annunciator

When the low battery-power annunciator (☹) comes on, you should replace the batteries as soon as possible. If the battery annunciator is on and the display dims, you may lose data. The **All Clear** message is displayed if data is lost due to low power.

Installing Batteries

Warning! There is a danger of explosion if batteries are incorrectly replaced.

Replace only with the same type of battery or with equivalent batteries (as recommended by the manufacturer). Dispose of used batteries according to the manufacturer's instructions.

- The calculator is powered by two 3-volt CR2032 coin batteries.
 - When changing batteries, use only fresh coin-cell batteries. Do not use rechargeable batteries.
 - Do not mutilate, puncture, or dispose of batteries in fire. The batteries can burst or explode, releasing hazardous chemicals.
 - Do not use new and old batteries together, and do not mix batteries of different types.
1. Have two fresh CR2032 batteries at hand. Only touch the batteries by their edges. Wipe each battery with a lint-free cloth to remove dirt and oil.
 2. Make sure the calculator is off. When changing the batteries, change the batteries one at a time to avoid clearing the memory. As a back-up, write down any data that you have stored and might need for later use.
 3. Turn the calculator over and pry off the battery cover.

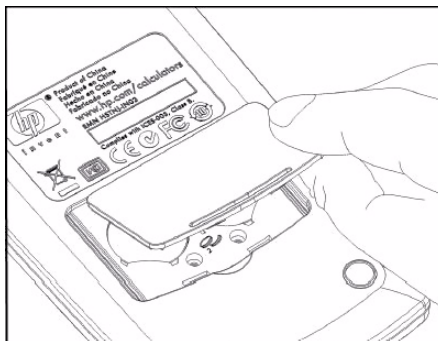

Accessing the battery compartment

4. Gently remove one battery.
5. Insert the new battery, making sure that the positive sign (+) battery is facing outward.
6. Gently remove the other battery.

7. Insert the other new battery, making sure that the positive sign (+) battery is facing outward.
8. Replace the battery-compartment lid.
9. Press .

If the calculator does not turn on, follow the procedures below.

Determining if the Calculator Requires Service

Use these guidelines to determine if the calculator requires service. If these procedures confirm that the calculator is not functioning properly, refer to the Warranty, Environmental, and Contact Information located on the product CD.

The calculator won't turn on:

This condition most likely indicates that the batteries have run out. Install new batteries.

If the calculator still does not turn on when you press \circ :



1. Reset the calculator (see below) and, if necessary,
2. Erase the memory (see below).

The **All Clear** message should now be displayed. If this is not the case, the calculator requires service.

Resetting the calculator:

1. Turn the calculator over and remove the battery cover.
2. Insert the end of a paper clip into the small, round hole located between the batteries. Insert the clip gently as far as it will go. Hold for one second and then remove the clip.
3. Press .
4. If the calculator is still not responding, erase the memory (see below) and repeat steps 1 to 3 above one more time.

Erasing the calculator's memory:

1. Press and hold down the  key.
2. Press and hold down the  and then the  key so all three keys are pressed simultaneously.
3. Release all three keys.

Memory is cleared and **All Clear** should be displayed.

The calculator doesn't respond to keystrokes:

1. Reset the calculator (see above) and, if necessary,
2. Erase the memory (see above).

The **All Clear** message should now be displayed. If this is not the case, the calculator requires service.

The calculator responds to keystrokes, but you suspect that it is malfunctioning:

1. It is likely that you've made a mistake in operating the calculator. Try rereading portions of the manual, and check *Answers to Common Questions* below.
2. Contact the Calculator Support department. The contact information is listed on the product CD.

Answers to Common Questions



Hewlett-Packard is committed to providing you with ongoing support. For more information on calculators and calculator learning products, visit www.hp.com/calculators. You also may contact HP Customer Support. Contact information and phone numbers are available on the product CD included in the package along with your calculator.

Please read *Answers to Common Questions* before contacting us. Our experience has shown that many of our customers have similar questions about our products. If you don't find an answer to your question, you can contact us using the contact information and phone numbers listed on the product CD.

Q: I'm not sure if the calculator is malfunctioning, or if I'm doing something incorrectly. How can I determine if the calculator is operating properly?

A: See *Determining If the Calculator Requires Service*.

Q: My numbers contain commas instead of periods as decimal points. How do I restore the periods?

A: Press   (Ch. 2 *Getting Started*).





Q: How do I change the number of decimal places that the HP 10bII+ displays?

A: Press   and the number of decimal places that you want (Ch. 2 *Getting Started*).

Q: What does an **E** in a number (for example, **2.51E-13**) mean?

A: Exponent of ten. For example, 2.51×10^{-13} (Ch. 2 *Getting Started*).

Q: Why do I get a wrong answer or the **No Solution** message when using TVM?

A: Be sure to enter a value for four of the five TVM values before you solve for the fifth, even if one of the values is zero. (Don't forget to store a zero for  if you completely pay off a loan.) Clearing all the TVM registers (  ) before entering your known values accomplishes the same thing. Check to see that the calculator is in the appropriate payment mode (Begin or End mode) and that *P/YR* is set correctly.

Q: How can I change the sign of a number in a list of cash flows?

A: You must edit or replace the cash flow entry (Ch. 8 *Cash Flow Calculations*).

Q: What does **PEND** in the display mean?

A: An arithmetic operation is pending (in progress).

Q: What does **INPUT** in the display mean?

A:The  key has been pressed (Ch. 2 *Getting Started*).

Q: Why is *IRR/YR* larger than I expected?

A: This is *IRR* per year. To see a periodic *IRR*, divide *IRR/YR* by *P/YR*.

Environmental Limits

To maintain product reliability, you should avoid getting the calculator wet and observe the following temperature and humidity limits:

- Operating temperature: 0° to 40°C (32° to 104°F).
- Storage temperature: -20° to 65°C (-4° to 149°F).
- Operating and storage humidity: 90% relative humidity at 40°C (104°F) maximum.

Appendix B: More About Calculations

IRR/YR Calculations

The calculator determines *IRR/YR* for a set of cash flows using mathematical formulas that search for the answer. The process finds a solution by estimating an answer and then using that estimate to do another calculation. This is called an *iterative* process.

In most cases, the calculator finds the desired answer, since there is usually only one solution to the calculation. However, calculating *IRR/YR* for certain sets of cash flows is more complex. There may be more than one (or no) mathematical solution to the problem.

Possible Outcomes of Calculating IRR/YR

These are the possible outcomes of an *IRR/YR* calculation:

- **Case 1.** The calculator displays a positive answer. This is the only positive answer. However, one or more negative answers may exist.
- **Case 2.** The calculator displays a negative answer and no message. This is the only answer.
- **Case 3.** The calculator displays: **No Solution**. There is no answer. This situation might be the result of an error, such as a mistake in keying in the cash flows. A common mistake that results in this message is putting the wrong sign on a cash flow. A valid cash-flow series for an *IRR/YR* calculation must have at least one positive and one negative cash flow.

Range of Numbers

The largest positive and negative numbers available on the calculator are $\pm 9.99999999999 \times 10^{499}$; the smallest positive and negative numbers available are $\pm 1 \times 10^{-499}$. Underflow briefly displays **UFLO** and then displays zero. Refer to the messages **OFLO** and **UFLO** in Appendix C.

Equations

Business Percentages and Break-even Calculations

$$MAR = \left(\frac{PRC - COST}{PRC} \right) \times 100 \qquad MU = \left(\frac{PRC - COST}{COST} \right) \times 100$$

$$\%CHG = \left(\frac{NEW - OLD}{OLD} \right) \times 100 \qquad PROFIT = (SP - VC) \times UNITS - FC$$

Probability

$$P = \frac{n!}{(n-r)!}$$

$$C = \frac{n!}{(n-r)!r!}$$

Time Value of Money (TVM)

Payment Mode Factor: $S = 0$ for End mode; 1 for Begin mode.

$$i\% = \frac{I/YR}{P/YR}$$

$$0 = PV + \left(1 + \frac{i\% \times S}{100}\right) \times PMT \times \left(\frac{1 - \left(1 + \frac{i\%}{100}\right)^{-N}}{\frac{i\%}{100}}\right) + FV \times \left(1 + \frac{i\%}{100}\right)^{-N}$$

Amortization

ΣINT = accumulated interest

ΣPRN = accumulated principal

i = periodic interest rate

BAL is initially PV rounded to the current display setting.

PMT is initially PMT rounded to the current display setting.

$$i = \frac{I/YR}{P/YR \times 100}$$

For each payment amortized:

$$INT' = BAL \times i \text{ (} INT' \text{ is rounded to the current display setting; } INT' = 0 \text{ for period 0 in Begin mode.)}$$

$$INT = INT' \text{ (with sign of } PMT)$$

$$PRN = PMT + INT'$$

$$BAL_{new} = BAL_{old} + PRN$$

$$\Sigma INT_{new} = \Sigma INT_{old} + INT$$

$$\Sigma PRN_{new} = \Sigma PRN_{old} + PRN$$

Interest Rate Conversions

$$EFF\% = \left(\left(1 + \frac{NOM\%}{100 \times P/YR} \right)^{P/YR} - 1 \right) \times 100$$

Cash-Flow Calculations

$i\%$ = periodic interest rate.

j = the group number of the cash flow.

CF_j = amount of the cash flow for group j .

n_j = number of times the cash flow occurs for group j .

k = the group number of the last group of cash flows.

$N_j = \sum_{1 \leq l < j} n_l$ = total number of cash flows prior to group j .

$$NPV = CF_0 + \sum_{j=1}^k CF_j \times \left(\frac{1 - \left(1 + \frac{i\%}{100}\right)^{-n_j}}{\frac{i\%}{100}} \right) \times \left(1 + \frac{i\%}{100}\right)^{-N_j}$$

When $NPV = 0$, the solution for $i\%$ is the periodic internal rate of return.

$$NFV = NPV \times SPFV(i\% : N) \text{ where } N = \sum_{j=1}^k n_j$$

$$TOTAL = \sum_{j=0}^k (n_j \times CF_j)$$

$$COUNT = \sum_{j=0}^k n_j$$

Bonds

Reference: Lynch, John J. Jr. and Jan Mayle, *Stanford Securities Calculation Methods, Securities Industry Association, New York, 1986.*

A = accrued days, the number of days from beginning of coupon period to settlement date.

E = number of days in coupon bracketing settlement date. By convention, E is 180 (or 360) if calendar basis is 30/360.

DSC = number of days from settlement date to next coupon date. (DSC = E - A).

M = coupon periods per year (1 = annual, 2 = semiannual).

N = number of coupon periods between settlement and redemption dates. If N has a fractional part (settlement not on coupon date), then round it to the next higher whole number.

Y = annual yield as a decimal fraction, YLD% / 100.

For one or fewer coupon period to redemption:

Note: coupon (CPN) is a percentage (CPN%) in both cases.

$$PRICE = \left[\frac{CALL + \frac{CPN}{M}}{1 + \left(\frac{DSC}{E} \times \frac{Y}{M} \right)} \right] - \left(\frac{A}{E} \times \frac{CPN}{M} \right)$$

For more than one coupon period to redemption:

$$\left[\frac{CALL}{\left(1 + \frac{Y}{M}\right)^{N-1 + \frac{DSC}{E}}} \right] + \left[\sum_{k=1}^N \frac{\frac{CPN}{M}}{\left(1 + \frac{Y}{M}\right)^{k-1 + \frac{DSC}{E}}} \right] - \left(\frac{A}{E} \times \frac{CPN}{M} \right)$$

The end of month convention is used to determine coupon dates in the following exceptional situations. This affects calculations for YLD%, PRICE, and ACCRU.

- If the maturity date falls on the last day of the month, then the coupon payments will also fall on the last day of the month. For example, a semiannual bond that matures on September 30 will have coupon payment dates on March 31 and September 30.
- If the maturity date of a semiannual bond falls on August 29 or 30, then the February coupon payment dates will fall on the last day of February (28, or 29 in leap years).

Depreciation

For the given year number (YR) and with Factor ($FACT$) as a percentage:

$$SL = \frac{BASIS - SALV}{LIFE}$$

$$SOYD = \frac{BASIS - SALV}{LIFE \times \frac{(LIFE + 1)}{2}} \times (LIFE - YR + 1)$$

$$DB = \frac{BASIS \times \frac{FACT}{100}}{LIFE} \times \left(1 - \frac{\left(\frac{FACT}{100} \right)^{(YR-1)}}{LIFE} \right)$$

For the last year of depreciation, DB equals the remaining depreciable value for the prior year.

Statistics

$$\bar{x} = \frac{\sum x}{n}, \bar{y} = \frac{\sum y}{n}, x_w = \frac{\sum xy}{\sum y}$$

$$S_x = \sqrt{\frac{\sum x^2 - \frac{(\sum x)^2}{n}}{n-1}}$$

$$S_y = \sqrt{\frac{\sum y^2 - \frac{(\sum y)^2}{n}}{n-1}}$$

$$\sigma_x = \sqrt{\frac{\sum x^2 - \frac{(\sum x)^2}{n}}{n}} \quad \sigma_y = \sqrt{\frac{\sum y^2 - \frac{(\sum y)^2}{n}}{n}}$$

$$r = \frac{\sum xy - \frac{\sum x \sum y}{n}}{\sqrt{\left(\sum x^2 - \frac{(\sum x)^2}{n} \right) \left(\sum y^2 - \frac{(\sum y)^2}{n} \right)}}$$

$$m = \frac{\sum xy - \frac{\sum x \sum y}{n}}{\sum x^2 - \frac{(\sum x)^2}{n}}$$

$$b = \bar{y} - m\bar{x} \quad \hat{x} = \frac{y-b}{m} \quad \hat{y} = mx + b$$

Forecasting

Name	Fit
Best Fit	Automatically selects fit
Linear	$m \cdot x + b$
Logarithm	$m \cdot \ln(x) + b$
Exponential	$b \cdot e^{(m \cdot x)}$
Power	$b \cdot x^m$
Exponent	$b \cdot m^x$
Inverse	$m/x + b$

Appendix C: Messages

Clear Messages



Press  or  to clear a message from the display.

Table C-1 Messages



Message Displayed	Description
ALL CLEAR	Memory has been erased (Ch. 2).
COPR HP 2010	Copyright message.
Oflo	(Overflow). The magnitude of a result is too large for the calculator to handle. Message is displayed for a moment, then the overflow result is returned ($\pm 9.999999999999999E499$). The overflow message is also displayed if an intermediate TVM or cashflow calculation results in an overflow condition.
Uflo	(Underflow). An intermediate result in TVM is too small for the HP 10bII+ to process. This message is also briefly displayed if any calculation underflows. In this case, it is followed by zero.
no Solution	No solution exists for values entered (Appendix B).
not Found	A solution for IRR/YR or I/YR may or may not exist. If you are attempting to solve I/YR , you may be able to perform the calculation using IRR/YR . If you are attempting an IRR/YR calculation, refer to (Appendix B).
Error I_Yr	Invalid value in I/Yr register or error solving for I/Yr .
Error P_Yr	Invalid value in P/Yr register or error solving for P/Yr .
Error N	Invalid value in N register or error solving for N .
Error LN	An invalid number was entered for the LN function.
Error 0 / 0	An attempt was made to divide 0 by 0.
Error / 0	An attempt was made to divide by 0.
Algebraic	Algebraic calculation mode is active.
Chain	Chain calculation mode is active.
Error days	An invalid date or range was attempted with the  $D.MY/M.DY$ INPUT function.
Error ddays	An invalid date or range was attempted with the  $MU \Delta DAYS$ function.
CFLOW CLR	cashflow memory was cleared.
TVM CLR	tvm registers were cleared.
BR EV CLR	breakeven registers were cleared.

Table C-1 Messages

Message Displayed	Description
BOND CLR	bond registers were cleared.
STAT CLR	statistical memory and registers were cleared.
Best Fit	The calculator selected the best fit regression which is subsequently flashed for 1 second.
running	Displays if a calculation takes longer than .25 seconds.
User Stop	An <i>IRR/YR</i> , <i>I/YR</i> , or amortization calculation was interrupted by pressing  .

17 Warranty, Regulatory, and Contact Information

Replacing the Batteries

Warning! There is a danger of explosion if batteries are incorrectly replaced. Replace only with the same type of battery or with equivalent batteries (as recommended by the manufacturer). Dispose of used batteries according to the manufacturer's instructions. Do not mutilate, puncture, or dispose of batteries in fire. The batteries can burst or explode, releasing hazardous chemicals.

- The calculator is powered by two 3-volt CR2032 coin batteries.
 - When changing batteries, use only fresh coin-cell batteries. Do not use rechargeable batteries.
 - Do not mutilate, puncture, or dispose of batteries in fire. The batteries can burst or explode, releasing hazardous chemicals.
 - Do not use new and old batteries together, and do not mix batteries of different types.
1. Have two fresh CR2032 batteries at hand. Only touch the batteries by their edges. Wipe each battery with a lint-free cloth to remove dirt and oil.
 2. Make sure the calculator is off. When changing the batteries, change the batteries one at a time to avoid clearing the memory. As a back-up, write down any data that you have stored and might need for later use.
 3. Turn the calculator over and pry off the battery cover.
 4. Gently remove one battery.
 5. Insert the new battery, making sure that the positive sign (+) battery is facing outward.
 6. Gently remove the other battery.
 7. Insert the other new battery, making sure that the positive sign (+) battery is facing outward.
 8. Replace the battery-compartment lid.
 9. Press .
 10. If the calculator does not turn on, follow the procedures in the section titled, *Determining if the Calculator Requires Service* in Appendix A of the *HP 10bII+ Financial Calculator User's Guide*.

HP Limited Hardware Warranty and Customer Care

This HP Limited Warranty gives you, the end-user customer, express limited warranty rights from HP, the manufacturer. Please refer to HP's Web site for an extensive description of your limited warranty entitlements. In addition, you may also have other legal rights under applicable local law or special written agreement with HP.

Limited Hardware Warranty Period

Duration: 12 months total (may vary by region, please visit www.hp.com/support for latest information).

General Terms

EXCEPT FOR THE WARRANTIES SPECIFICALLY PROVIDED FOR IN SUBSEQUENT PARAGRAPHS OF THIS SECTION, HP MAKES NO OTHER EXPRESS WARRANTY OR CONDITION WHETHER WRITTEN OR ORAL. TO THE EXTENT ALLOWED BY LOCAL LAW, ANY IMPLIED WARRANTY OR CONDITION OF MERCHANTABILITY, SATISFACTORY QUALITY, OR FITNESS FOR A PARTICULAR PURPOSE IS LIMITED TO THE DURATION OF THE EXPRESS WARRANTY SET FORTH IN THE SUBSEQUENT PARAGRAPHS OF THIS SECTION. Some countries, states or provinces do not allow limitations on the duration of an implied warranty, so the above limitation or exclusion might not apply to you. This warranty gives you specific legal rights and you might also have other rights that vary from country to country, state to state, or province to province. **TO THE EXTENT ALLOWED BY LOCAL LAW, THE REMEDIES IN THIS WARRANTY STATEMENT ARE YOUR SOLE AND EXCLUSIVE REMEDIES. EXCEPT AS INDICATED ABOVE, IN NO EVENT WILL HP OR ITS SUPPLIERS BE LIABLE FOR LOSS OF DATA OR FOR DIRECT, SPECIAL, INCIDENTAL, CONSEQUENTIAL (INCLUDING LOST PROFIT OR DATA), OR OTHER DAMAGE, WHETHER BASED IN CONTRACT, TORT, OR OTHERWISE.** Some countries, States or provinces do not allow the exclusion or limitation of incidental or consequential damages, so the above limitation or exclusion may not apply to you. **FOR CONSUMER TRANSACTIONS IN AUSTRALIA AND NEW ZEALAND: THE WARRANTY TERMS CONTAINED IN THIS STATEMENT, EXCEPT TO THE EXTENT LAWFULLY PERMITTED, DO NOT EXCLUDE, RESTRICT OR MODIFY AND ARE IN ADDITION TO THE MANDATORY STATUTORY RIGHTS APPLICABLE TO THE SALE OF THIS PRODUCT TO YOU.** Notwithstanding the above disclaimers, HP expressly warrants to you, the end-user customer, that HP hardware, accessories and supplies will be free from defects in materials and workmanship after the date of purchase, for the period specified above. If HP receives notice of such defects during the warranty period, HP will, at its option, either repair or replace products which prove to be defective. Replacement products may be either new or like-new. HP also expressly warrants to you that HP software will not fail to execute its programming instructions after the date of purchase, for the period specified above, due to defects in material and workmanship when properly installed and used. If HP receives notice of such defects during the warranty period, HP will replace software media which does not execute its programming instructions due to such defects.

Exclusions

HP does not warrant that the operation of HP products will be uninterrupted or error free. If HP is unable, within a reasonable time, to repair or replace any product to a condition as warranted, you will be entitled to a refund of the purchase price upon prompt return of the product with proof of purchase. HP products may contain remanufactured parts equivalent to new in performance or may have been subject to incidental use. Warranty does not apply to defects resulting from (a) improper or inadequate maintenance or calibration, (b) software, interfacing, parts or supplies not supplied by HP, (c) unauthorized modification or misuse, (d) operation outside of the published environmental specifications for the product, or (e) improper site preparation or maintenance. HP MAKES NO OTHER EXPRESS WARRANTY

OR CONDITION WHETHER WRITTEN OR ORAL. TO THE EXTENT ALLOWED BY LOCAL LAW, ANY IMPLIED WARRANTY OR CONDITION OF MERCHANTABILITY, SATISFACTORY QUALITY, OR FITNESS FOR A PARTICULAR PURPOSE IS LIMITED TO THE DURATION OF THE EXPRESS WARRANTY SET FORTH ABOVE. Some countries, states or provinces do not allow limitations on the duration of an implied warranty, so the above limitation or exclusion might not apply to you. This warranty gives you specific legal rights and you might also have other rights that vary from country to country, state to state, or province to province. TO THE EXTENT ALLOWED BY LOCAL LAW, THE REMEDIES IN THIS WARRANTY STATEMENT ARE YOUR SOLE AND EXCLUSIVE REMEDIES. EXCEPT AS INDICATED ABOVE, IN NO EVENT WILL HP OR ITS SUPPLIERS BE LIABLE FOR LOSS OF DATA OR FOR DIRECT, SPECIAL, INCIDENTAL, CONSEQUENTIAL (INCLUDING LOST PROFIT OR DATA), OR OTHER DAMAGE, WHETHER BASED IN CONTRACT, TORT, OR OTHERWISE. Some countries, States or provinces do not allow the exclusion or limitation of incidental or consequential damages, so the above limitation or exclusion may not apply to you. The only warranties for HP products and services are set forth in the express warranty statements accompanying such products and services. HP shall not be liable for technical or editorial errors or omissions contained herein. FOR CONSUMER TRANSACTIONS IN AUSTRALIA AND NEW ZEALAND: THE WARRANTY TERMS CONTAINED IN THIS STATEMENT, EXCEPT TO THE EXTENT LAWFULLY PERMITTED, DO NOT EXCLUDE, RESTRICT OR MODIFY AND ARE IN ADDITION TO THE MANDATORY STATUTORY RIGHTS APPLICABLE TO THE SALE OF THIS PRODUCT TO YOU.

Regulatory Information

Federal Communications Commission Notice

This equipment has been tested and found to comply with the limits for a Class B digital device, pursuant to Part 15 of the FCC Rules. These limits are designed to provide reasonable protection against harmful interference in a residential installation. This equipment generates, uses, and can radiate radio frequency energy and, if not installed and used in accordance with the instructions, may cause harmful interference to radio communications. However, there is no guarantee that interference will not occur in a particular installation. If this equipment does cause harmful interference to radio or television reception, which can be determined by turning the equipment off and on, the user is encouraged to try to correct the interference by one or more of the following measures:

- Reorient or relocate the receiving antenna.
- Increase the separation between the equipment and the receiver.
- Connect the equipment into an outlet on a circuit different from that to which the receiver is connected.
- Consult the dealer or an experienced radio or television technician for help.

Modifications

The FCC requires the user to be notified that any changes or modifications made to this device that are not expressly approved by Hewlett-Packard Company may void the user's authority to operate the equipment.

Declaration of Conformity for Products Marked with FCC Logo, United States Only

This device complies with Part 15 of the FCC Rules. Operation is subject to the following two conditions:

1. This device may not cause harmful interference
2. This device must accept any interference received, including interference that may cause undesired operation.

If you have questions about the product that are not related to this declaration, write to:

Hewlett-Packard Company
P. O. Box 692000, Mail Stop 530113
Houston, TX 77269-2000

For questions regarding this FCC declaration, write to:

Hewlett-Packard Company
P. O. Box 692000, Mail Stop 510101
Houston, TX 77269-2000
or call HP at 281-514-3333

To identify your product, refer to the part, series, or model number located on the product.

Canadian Notice

This Class B digital apparatus meets all requirements of the Canadian Interference-Causing Equipment Regulations.

Avis Canadien

Cet appareil numérique de la classe B respecte toutes les exigences du Règlement sur le matériel brouilleur du Canada.

European Union Regulatory Notice

Products bearing the CE marking comply with the following EU Directives:

- Low Voltage Directive 2006/95/EC
- EMC Directive 2004/108/EC
- Ecodesign Directive 2009/125/EC, where applicable

CE compliance of this product is valid if powered with the correct CE-marked AC adapter provided by HP. Compliance with these directives implies conformity to applicable harmonized European standards (European Norms) that are listed in the EU Declaration of Conformity issued by HP for this product or product family and available (in English only) either within the product documentation or at the following web site: **www.hp.eu/certificates** (type the product number in the search field). The compliance is indicated by one of the following conformity markings placed on the product:



For non-telecommunications products and for EU harmonized telecommunications products, such as Bluetooth® within power class below 10mW.



For EU non-harmonized telecommunications products (If applicable, a 4-digit notified body number is inserted between **CE** and **!**).

Please refer to the regulatory label provided on the product. The point of contact for regulatory matters is:

Hewlett-Packard GmbH, Dept./MS: HQ-TRE, Herrenberger Strasse 140, 71034 Boeblingen, GERMANY.

Japanese Notice

この装置は、クラスB情報技術装置です。この装置は、家庭環境で使用することを目的としていますが、この装置がラジオやテレビジョン受信機に近接して使用されると、受信障害を引き起こすことがあります。

取扱説明書に従って正しい取り扱いをして下さい。 VCCI-B

Disposal of Waste Equipment by Users in Private Household in the European Union



This symbol on the product or on its packaging indicates that this product must not be disposed of with your other household waste. Instead, it is your responsibility to dispose of your waste equipment by handing it over to a designated collection point for the recycling of waste electrical and electronic equipment. The separate collection and recycling of your waste equipment at the time of disposal will help to conserve natural resources and ensure that it is recycled in a manner that protects human health and the environment. For more

information about where you can drop off your waste equipment for recycling, please contact your local city office, your household waste disposal service or the shop where you purchased the product.

Perchlorate Material - special handling may apply

This calculator's Memory Backup battery may contain perchlorate and may require special handling when recycled or disposed in California.

Customer Care

In addition to the one year hardware warranty, your HP calculator also comes with one year of technical support. If you need assistance with warranty, please refer to the warranty information on the product CD. HP customer care can be reached by either email or telephone. Before calling please locate the call center nearest you from the list provided. Have your proof of purchase and calculator serial number ready when you call. Telephone numbers are subject to change, and local and national telephone rates may apply. A complete list is available on the web at: www.hp.com/support.

Contact Information

Table 17-1 Contact Information

Country/ Region	Contact	Country/ Region	Contact
Algeria	www.hp.com/support	Anguila	1-800-711-2884
Antigua	1-800-711-2884	Argentina	0-800-555-5000
Aruba	800-8000; 800-711-2884	Austria Österreich	01 360 277 1203
Bahamas	1-800-711-2884	Barbados	1-800-711-2884
Belgique (Français)	02 620 00 85	Belgium (English)	02 620 00 86
Bermuda	1-800-711-2884	Bolivia	800-100-193
Botswana	www.hp.com/support	Brazil Brasil	0-800-709-7751
British Virgin Islands	1-800-711-2884	Bulgaria	www.hp.com/support
Canada	800-HP-INVENT	Cayman Island	1-800-711-2884
Chile	800-360-999	China 中国	800-820-9669
Costa Rica	0-800-011-0524	Croatia	www.hp.com/support
Curacao	001-800-872-2881 + 800-711-2884	Czech Republic Česká republikaik	296 335 612
Denmark	82 33 28 44	Dominica	1-800-711-2884
Dominican Republic	1-800-711-2884	Egypt	www.hp.com/support

Country/ Region	Contact	Country/ Region	Contact
El Salvador	800-6160	Ecuador	1-999-119; 800-711-2884 (Andinatel) 1-800-225-528; 800-711-2884 (Pacifitel)
Estonia	www.hp.com/support	Finland Suomi	09 8171 0281
France	01 4993 9006	French Antilles	0-800-990-011; 800-711-2884
French Guiana	0-800-990-011; 800-711-2884	Germany Deutschland	069 9530 7103
Ghana	www.hp.com/support	Greece Ελλάδα	210 969 6421
Grenada	1-800-711-2884	Guadelupe	0-800-990-011; 800-711-2884
Guatemala	1-800-999-5105	Guyana	159; 800-711-2884
Haiti	183; 800-711-2884	Honduras	800-0-123; 800-711-2884
Hong Kong 香港特別行 政區	800-933011	Hungary	<u>www.hp.com/support</u>
India	1-800-114772	Indonesia	(21)350-3408
Ireland	01 605 0356	Italy Italia	02 754 19 782
Jamaica	1-800-711-2884	Japan 日本	00531-86-0011
Kazakhstan	www.hp.com/support	Latvia	www.hp.com/support
Lebanon	www.hp.com/support	Lithuania	www.hp.com/support
Luxembourg	2730 2146	Malaysia	1800-88-8588
Martinica	0-800-990-011; 877-219-8671	Mauritius	www.hp.com/support
Mexico México	01-800-474-68368 (800 HP INVENT)	Montenegro	www.hp.com/support
Montserrat	1-800-711-2884	Morocco	www.hp.com/support
Namibia	www.hp.com/support	Netherlands	020 654 5301
Netherland Antilles	001-800-872-2881; 800-711-2884	New Zealand	0800-551-664
Nicaragua	1-800-0164; 800-711-2884	Norway Norwegen	23500027
Panama Panamá	001-800-711-2884	Paraguay	(009) 800-541-0006

Country/ Region	Contact	Country/ Region	Contact
Peru Perú	0-800-10111	Philippines	(2)-867-3351
Poland Polska	www.hp.com/support	Portugal	021 318 0093
Puerto Rico	1-877 232 0589	Romania	www.hp.com/support
Russia Россия	495-228-3050	Saudi Arabia	www.hp.com/support
Serbia	www.hp.com/support	Singapore	6272-5300
Slovakia	www.hp.com/support	South Africa	0800980410
South Korea 한국	00798-862-0305	Spain España	913753382
St Kitts & Nevis	1-800-711-2884	St Lucia	1-800-478-4602
St Marteen	1-800-711-2884	St Vincent	01-800-711-2884
Suriname	156; 800-711-2884	Swaziland	www.hp.com/support
Sweden Sverige	08 5199 2065	Switzerland	022 827 8780
Switzerland (Suisse Français)	022 827 8780	Switzerland (Schweiz Deutsch)	01 439 5358
Switzerland (Svizzeera Italiano)	022 567 5308	Taiwan 臺灣	00801-86-1047
Thailand ไทย	(2)-353-9000	Trinidad & Tobago	1-800-711-2884
Tunisia	www.hp.com/support	Turkey Türkiye	www.hp.com/support
Turks & Caicos	01-800-711-2884	UAE	www.hp.com/support
United Kingdom	0207 458 0161	Uruguay	0004-054-177
US Virgin Islands	1-800-711-2884	United States	800-HP INVENT
Venezuela	0-800-474-68368 (0-800 HP INVENT)	Vietnam Việt Nam	+65-6272-5300
Zambia	www.hp.com/support		

产品中有毒有害物质或元素的名称及含量
根据中国《电子信息产品污染控制管理办法》

部件名称	有毒有害物质或元素					
	铅 (Pb)	汞 (Hg)	镉 (Cd)	六价铬 (Cr(VI))	多溴联苯 (PBB)	多溴二苯醚 (PBDE)
PCA	X	0	0	0	0	0
外觀殼 /字鍵	0	0	0	0	0	0

0：表示该有毒有害物质在该部件所有均质材料中的含量均在SJ/T 11363-2006标准规定的限量要求以下。

X：表示该有毒有害物质至少在该部件的某一均质材料中的含量超出SJ/T 11363-2006标准规定的限量要求。

表中标有“X”的所有部件都符合欧盟RoHS法规

“欧洲议会和欧盟理事会2003年1月27日关于电子电器设备中限制使用某些有害物质的2002/95/EC号指令”

注：环保使用期限的参考标识取决于产品正常工作的温度和湿度等条件

A

- Advance payments 72
- Algebraic mode
 - calculations 28
- Amortization 74
 - equations II
 - range of payments 76
 - single payment 77
 - TVM keys used 75
- Angle format
 - selecting 35
- Annuity account 70
- Annunciators 30
- Arithmetic operators 26
- At a Glance
 - quick reference guide 1

B

- Balloon payment 65
- Batteries I
 - installing I
- Battery
 - replacing the batteries 1, 6
- Bonds 105
 - clear memory 105
 - example 106
 - keys used 105
 - resetting bond keys 108
- Break-even 109
 - example 16, 110
 - keys used 109
 - resetting keys 112

C

- Calendar 99
- Calendar format 99
- Calendar keys 99
- Cash flow
 - equations III
- Cash flows
 - application 87
 - calculating NPV and NFV 95
 - clearing memory 88
 - discounting 91
 - keys used 88
 - organizing 91
 - periods 56
 - recognizing one 59
 - signs of 56
 - storage of 89
 - storing IRR and NPV 98
 - viewing and editing 93

- Chain mode
 - calculations 27
- Clearing
 - backspace 29
 - messages in the display 30
- Comma
 - interchanging with period 43
- Comma separator III
- Constants
 - using 49
- Cursor 29
- Customer care and contact information 6

D

- Date calculations 101
- Date format 99
 - bonds 106
- Date keys 99
- Decimal
 - specifying display of decimal places 42
- Depreciation 83
 - resetting TVM keys 86
 - TVM keys used 83
- Display
 - full precision 42
- Display format 41

E

- Environmental limits IV
- Equations
 - amortization II
 - bonds IV
 - cash-flow calculations III
 - depreciation V
 - forecasting V
 - interest rate conversions II
 - margins and markups I
 - statistical V
 - TVM II
- Error messages I

F

- Factorial 126
- FAQ I, III
- Frequently Asked Questions I, III

H

- Home mortgage 64
- Hyperbolic functions 35

I

- Individual retirement account 69

In-line functions 37
Interest
 compound interest 57
 interest rates 57
 simple interest 56
Interest rate conversions 79
Investments
 different compounding periods 79
IRR
 calculating IRR 90
IRR/YR I
IRR/YR calculations
 possible outcomes I
K
Keyboard iv
 map legend iv
Keys
 360/ACT 99
 Accint (bonds) 105
 advanced probability distributions 128
 Alg/Chain 26
 Amort 62
 backspace 29
 basic functions 24
 Beg/End 62
 boxed key functions 25
 business percentages 45
 C STAT 113
 call (bonds) 105
 CFj 87
 clear 29
 clear all 30
 clear memory 29
 clearing functions 25
 CPN% (bonds) 105
 CST (cost business) 47
 date 99
 DB (declining balance) 83
 DISP 42
 DMY/MDY 99
 E 43
 eff% 79
 estimation of x 113
 estimation of y 113
 FC (break-even) 109
 FV 61
 I/YR 61
 input 32
 K 49
 M 51
 MAR (margin) 47
 matdate (bonds) 105

mean of x weighted by y 113
means of x and y 113
MU (markup) 47
N 61
NFV 88
Nj 87
nom% 79
NPV 88
number of days 99
off 23
on 23
one-number functions 33
P/YR 61
parentheses 28
percent 45
period/comma 43
plus, minus, multiply, divide 26
PMT 61
population standard deviation 113
PRC (price business) 47
price (bonds) 105
profit (break-even) 109
PV 61
RAND 127
regression models 113
RND 43
sample standard deviation 113
semi/ann (bonds) 105
setdate (bonds) 105
shift keys 25
SL (straight line) 83
SOYD 83
SP (break-even) 109
statistics 32
STO (store) 52
swap 32
two-number functions 39
units (break-even) 109
VC (break-even) 109
xP/YR 61
YTM (bonds) 105

L

Last answer 41
Lease calculations 71
Legal notice ii
Loan calculations 62

M

Manual conventions 23
Margin 47
Markup 47
Memory

- clearing II
- Messages I
 - calculator status 44
 - list of I
- Modes
 - TVM begin and end 62

N

- Negative numbers 29
- Net future value 95
- Net present value 95
- Number of days 101
- Number storage 49
- Numbers
 - display format 41
 - range of I

O

- One-number functions 33
 - arithmetic with 39
- Operating conditions IV
- Operating modes 26

P

- Parentheses
 - use in calculations 28
- Percent
 - dividing by 100 45
 - percent change 46
- Percentages
 - business 45
- Period
 - interchanging with comma 43
- Pi 36
- Probability
 - advanced distributions 128
 - combinations 126
 - conversions from lower tail 133
 - inverse normal lower tail 130
 - inverse Student's T lower tail 132
 - keys used 128
 - normal lower tail 129
 - permutations 126
 - Student's T and inverse 128
 - Student's T lower tail 131
 - Z and inverse 128

Q

- Questions I, III

R

- Random number and seed 127

- Registers
 - M register 51
 - using numbered registers 51
- Regulatory Information 3
- Reset II
- Rounding numbers 43

S

- Savings calculations 67
- Scientific notation 43
- Screen display iv
- Service II
- Statistics
 - calculations that return two values 119
 - clearing data 114
 - entering data 114
 - keys used 113
 - linear regression, estimation, and regression modes 121
 - mean, standard deviation and summation 120
 - memory and storage 114
 - one-variable 115
 - regression models and variables 125
 - summary of calculations 119
 - two-variable 115
 - viewing and editing data 116
 - weighted mean 115, 124
- Storage registers
 - arithmetic with 49

T

- Trigonometric functions 35
- Troubleshooting II
- TVM
 - equations II
 - keys 61
 - recognizing one 58
- TVM keys
 - resetting 82
- Two number functions 37
- Two-number functions
 - arithmetic with 39

W

- Warranty 1