

Open Frame Touch Monitor

HO 165 PTB

15.6" / 39,6cm Diagonal
LED Backlight – Format 16:9

- 1920 x 1080 Resolution Full HD 1080P
- 10-Point Touch P-Cap Technology
- 170° Wide Viewing Angle
- Triple Input: HDMI + DP + VGA
- **IP65 Rating Level**
- **Display Protection: Thickness 3.9mm**
- **24/7 Operating**
- **Built-in Speakers**
- 12 Volt External Power Supply
- Touch-Through Glass
- Sturdy Metal Case
- VESA Mount and Multiple Mounting Options
- Orientation: Landscape, Portrait, Face-Up

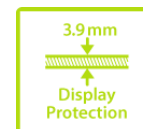
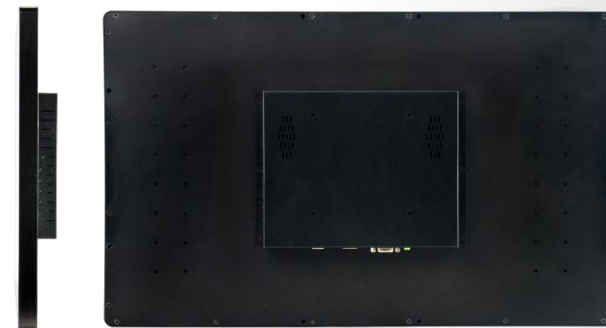

15.6" / 39,6 cm

Part. No.: HO 165 PTB

SIZE, RESOLUTION

15.6"
15.6"
16:9 Aspect Ratio

FULL HD
1920 x 1080
1920 x 1080

CONNECTIVITY, IP LEVEL

VGA
HDMI
Display Port

IP 65
IP 65
Water & Dust
Protection

VIEWING ANGLE, VESA

170°
170° Wide
Viewing Angle

VESA
VESA
Wall-Mountable

OTHER FEATURES

24/7
designed for
Operating
24 Hours / 7 Days

Stereo
Speakers

Display Size	39.6 cm / 15.6" Diagonal
Panel Type	TFT – LED Backlight
Aspect Ratio	16:9
Resolution (H x V)	1920 x 1080 Full HD
Brightness	250 cd/m ² (Panel) – 212 cd/m ² (Monitor)
Contrast (Typ.)	700:1 (Typical) – 10M:1 (Active Contrast)
Display Area	345,23 x 194,54 mm
Viewing Angle L/R; U/D	170° H / 170° V (CR > 10)
Response Time	25 msec
Pixel Pitch	0.17925 (H) X 0.17925 (V) mm
Touch Type	Projected Capacitive Type – 10 Point Touch Material Glass + Glass Cover Glass+LOCA+ITO (Indium Tin Oxide) Glass
Display Colors	262K Colors
Horizontal Frequency	31.5 ~ 80 kHz
Vertical Frequency	60 ~ 75 Hz
Max Display Frequency	1920 x 1080 @ 60Hz
Input 1	VGA
Input 2	HDMI
Input 3 / 4	Display Port / USB for Touch
Speakers	Yes, 1.5W x 2
Power Consumption	On: 6.98W; Stand-by: 0.21W; Off: 0.20W
AC Power Range	External Power Supply: 12 Volt / 2.5A Input: AC 100 ~ 240 Volt; 50 ~ 60 Hz
Product Dimensions	387.3 x 39.8 x 236.4 mm (W x D x H)
Packing Dimensions	- x - x - mm (W x D x H) (TBC)
Net / Gross Weight	2.46 Kg / - Kg (TBC)

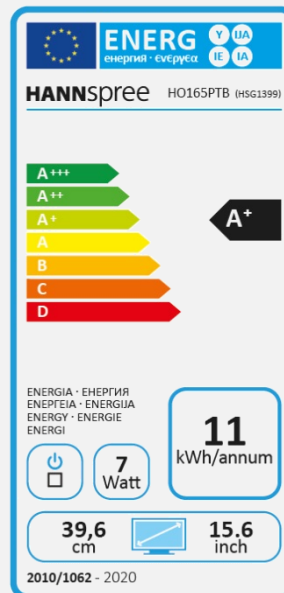

VESA Mounting	100 x 100 mm
Display Protection	TP Module Protection Thickness 3,9
Hardness / Transmittance	≥6H Toughened hard panel surface / ≥85%
IP Rating Level	IP 65 ** (Front), Water and Dust Protection
Control	Menu/Exit,Bri (+),Vol (-) , Input/Enter,Power
LED Backlight life	15.000 hours
Accessory	Power Adaptor; EU and UK Power Cables (1.5mt); HDMI Cable (1.5mt); USB 2.0 (B-A) Cable (1.8mt)
Certifications	CE, RoHS, EU Energy Label
On Screen Display	8 Languages
Color	9300, 6500, 5300, User Mode
Preset Mode	Standard, Text, Movie, Game Modes
Orientation	Landscape, Portrait, Face-Up

Supplier's Name	HANNspree
Model Name	HO165PTB
Energy Efficiency Class	A+
Screen Size (Centimetres)	39,6
Screen Size (Inches)	15.6
On mode power Consumption (W)	7
Annual Energy Consumption* (kWh)	11
Standby-mode Power Consumption (W)	0,21
Off-mode Power Consumption (W)	0,20
Screen Resolution	1920 x 1080

PART. NO.:
HO 165 PTB



4 711404 023033 >

HANNSpree

HO 165 PTB
15.6" Open Frame Touch Monitor

Experts in **Display**



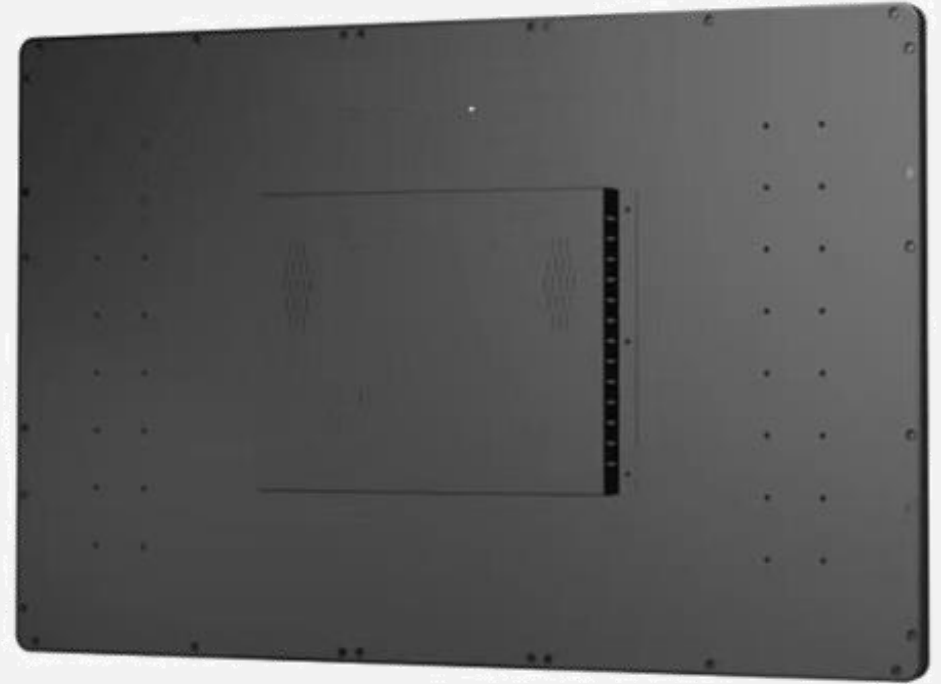
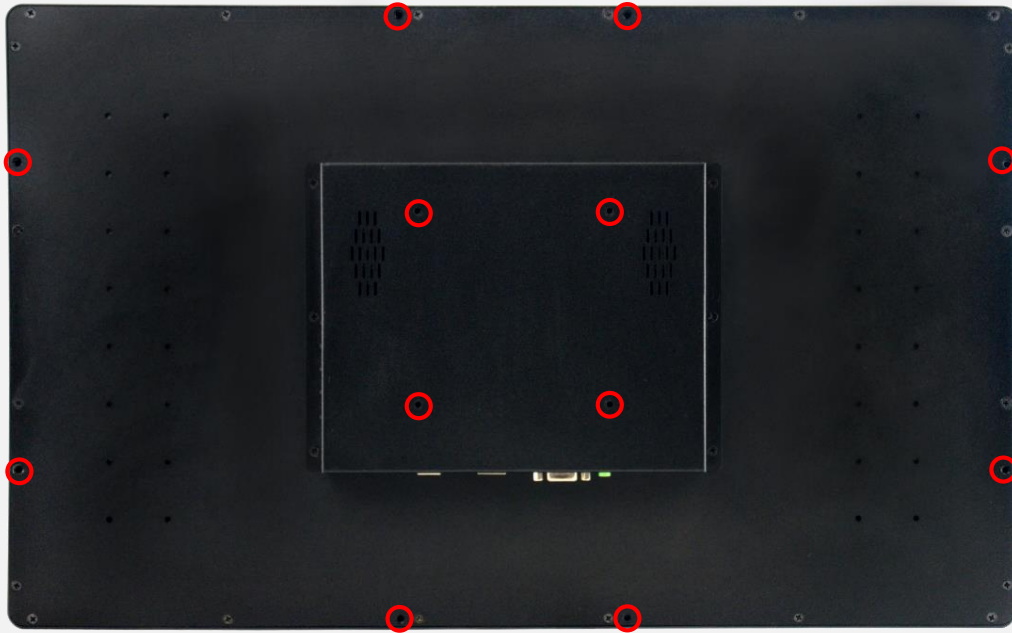

Front Cover :

Full Flat Design

Screws: M4 x 10mm (max), pitch 0.7, UNC type

HO 165 PTB 15.6" Open Frame Touch Monitor

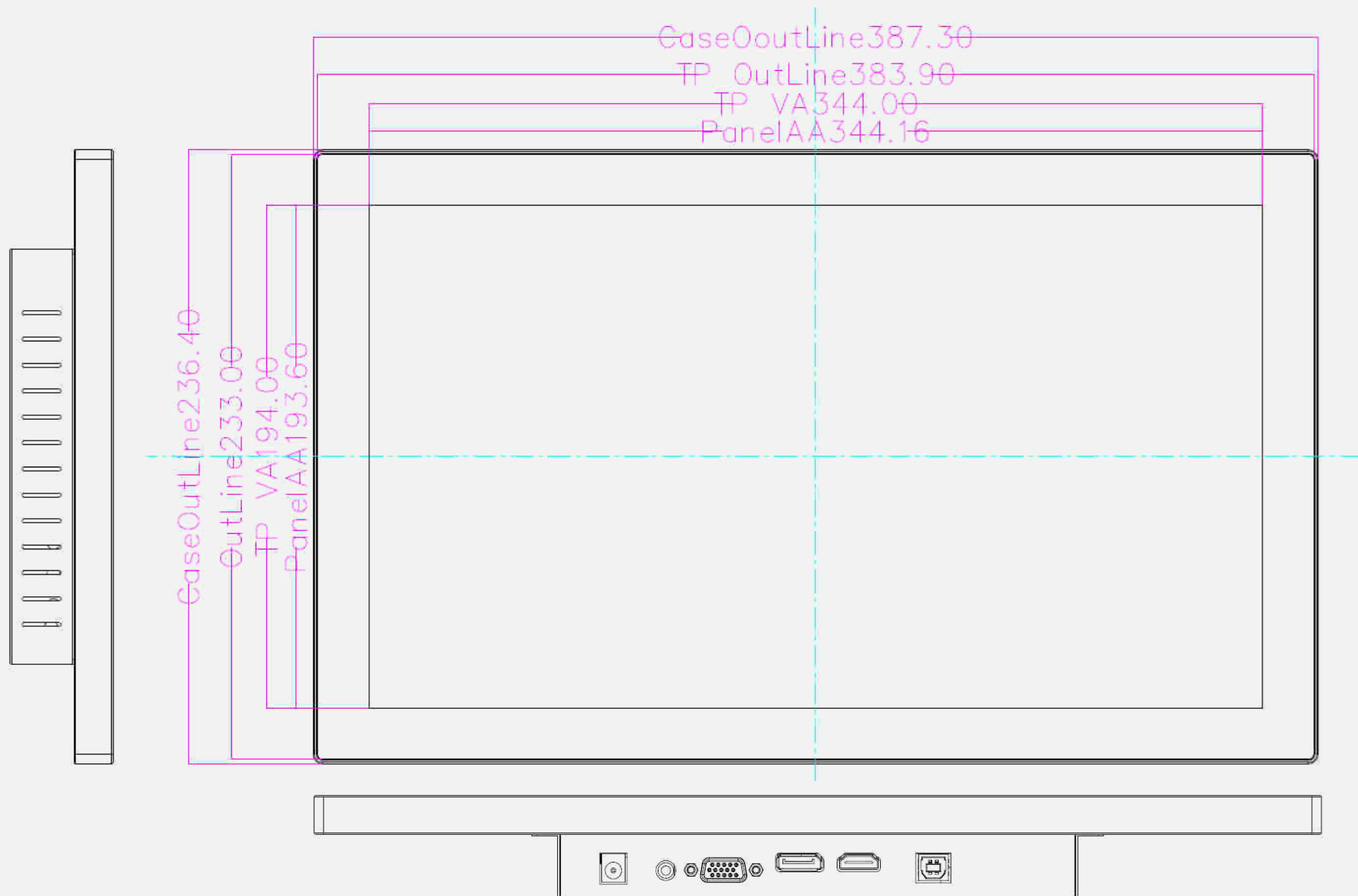

HO 165 PTB 15.6" Open Frame Touch Monitor

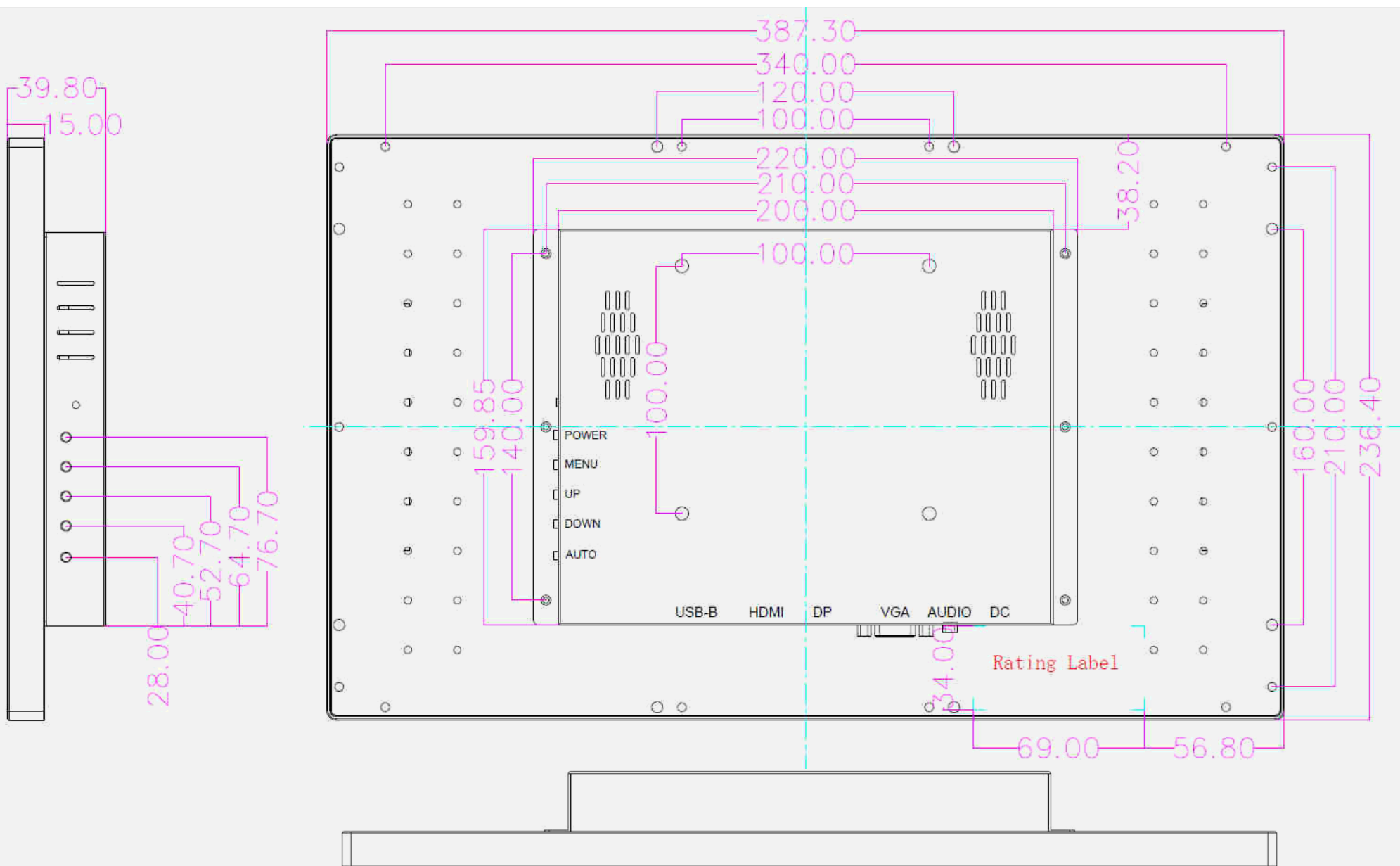

HANNspree

HO 165 PTB
15.6" Open Frame Touch Monitor

Experts in **Display**

