

ZÜMO® 396

Owner's Manual

© 2018 Garmin Ltd. or its subsidiaries

All rights reserved. Under the copyright laws, this manual may not be copied, in whole or in part, without the written consent of Garmin. Garmin reserves the right to change or improve its products and to make changes in the content of this manual without obligation to notify any person or organization of such changes or improvements. Go to www.garmin.com for current updates and supplemental information concerning the use of this product.

Garmin® and the Garmin logo are trademarks of Garmin Ltd. or its subsidiaries, registered in the USA and other countries. zūmo®, Garmin Express™ and TracBack® are trademarks of Garmin Ltd. or its subsidiaries. These trademarks may not be used without the express permission of Garmin.

Android™ is a trademark of Google Inc. The Bluetooth® word mark and logos are owned by the Bluetooth SIG, Inc., and any use of such name by Garmin is under license. Foursquare® is a trademark of Foursquare Labs, Inc. in the U.S. and in other countries. microSD® is a trademark of SD-3C. Windows® is a registered trademarks of Microsoft Corporation in the United States and/or other countries. Mac® is a trademark of Apple Computer, Inc. The Pandora logos are trademarks of Pandora Media, Inc. Pandora is only available in certain countries. Please visit <http://www.pandora.com/legal>. TripAdvisor® is a registered trademark of TripAdvisor LLC. Windows®, Windows Vista®, and Windows XP® are registered trademarks of Microsoft Corporation in the United States and other countries. Wi-Fi® is a registered trademark of Wi-Fi Alliance.

Table of Contents

| | | | |
|---|----------|--|-----------|
| Installation | 1 | Finding a Location by Category..... | 8 |
| Mounting Your Device in a Motorcycle..... | 1 | Searching Within a Category..... | 8 |
| Powered Motorcycle Mount..... | 1 | Navigating to Points of Interest Within a Venue..... | 8 |
| Installing the Handlebar Base..... | 1 | Location Search Results..... | 9 |
| Attaching the Power Cables to the Motorcycle Mount..... | 1 | Location Search Results on the Map..... | 9 |
| Attaching the Base Plate to the Motorcycle Mount..... | 2 | Changing the Search Area..... | 9 |
| Attaching the Base Plate to the Handlebar Base..... | 2 | Parking..... | 9 |
| Installing Your Device in the Motorcycle Mount..... | 2 | Finding Parking Near Your Current Location..... | 9 |
| Removing Your Device from the Motorcycle Mount..... | 2 | Finding Parking Near a Specified Location..... | 9 |
| Mounting Your Device in an Automobile..... | 2 | Understanding Parking Colors and Symbols..... | 9 |
| Getting Started | 2 | Search Tools..... | 9 |
| Device Overview..... | 3 | Finding an Address..... | 9 |
| Turning the Device On or Off..... | 3 | Finding an Intersection..... | 9 |
| Acquiring GPS Signals..... | 3 | Finding a City..... | 10 |
| Status Bar Icons..... | 3 | Finding a Location Using Coordinates..... | 10 |
| Using the On-Screen Buttons..... | 3 | Foursquare..... | 10 |
| Adjusting the Volume..... | 3 | Connecting to Your Foursquare Account..... | 10 |
| Using the Audio Mixer..... | 3 | Searching Foursquare Points of Interest..... | 10 |
| Adjusting the Screen Brightness..... | 3 | Viewing Foursquare Location Details..... | 10 |
| Rider Awareness Features and Alerts | 3 | Checking in with Foursquare..... | 10 |
| Enabling or Disabling Rider Alerts..... | 4 | TripAdvisor®..... | 10 |
| Red Light and Speed Cameras..... | 4 | Finding TripAdvisor Points of Interest..... | 10 |
| Incident Detection and Notifications..... | 4 | Viewing Recently Found Locations..... | 10 |
| Setting Up an Incident Contact..... | 4 | Clearing the List of Recently Found Locations..... | 10 |
| Cancelling an Incident Notification..... | 4 | Viewing Current Location Information..... | 10 |
| Disabling Incident Notifications..... | 4 | Finding Emergency Services and Fuel..... | 10 |
| Viewing Helmet Law Notifications..... | 4 | Getting Directions to Your Current Location..... | 10 |
| Searching for Helmet Laws..... | 5 | Adding a Shortcut..... | 10 |
| Navigating to Your Destination | 5 | Removing a Shortcut..... | 10 |
| Routes..... | 5 | Saving Locations..... | 11 |
| Starting a Route..... | 5 | Saving a Location..... | 11 |
| Changing the Route Calculation Mode..... | 5 | Saving Your Current Location..... | 11 |
| Taking a Route Using Adventurous Routing..... | 5 | Editing a Saved Location..... | 11 |
| Starting a Route by Using the Map..... | 5 | Assigning Categories to a Saved Location..... | 11 |
| Going Home..... | 5 | Deleting a Saved Location..... | 11 |
| Your Route on the Map..... | 5 | Using the Map | 11 |
| Active Lane Guidance..... | 5 | Map Tools..... | 11 |
| Viewing Turns and Directions..... | 6 | Viewing a Map Tool..... | 11 |
| Viewing the Entire Route on the Map..... | 6 | Enabling Map Tools..... | 11 |
| Arriving at Your Destination..... | 6 | Up Ahead..... | 11 |
| Parking Near Your Destination..... | 6 | Viewing Upcoming Locations..... | 11 |
| Finding Your Last Parking Spot..... | 6 | Customizing the Up Ahead Categories..... | 12 |
| Changing Your Active Route..... | 6 | Trip Information..... | 12 |
| Adding a Location to Your Route..... | 6 | Viewing Trip Data from the Map..... | 12 |
| Shaping Your Route..... | 6 | Viewing the Trip Information Page..... | 12 |
| Taking a Detour..... | 6 | Viewing the Trip Log..... | 12 |
| Stopping the Route..... | 6 | Resetting Trip Information..... | 12 |
| Using Suggested Routes..... | 7 | Viewing Upcoming Traffic..... | 12 |
| Avoiding Delays, Tolls, and Areas..... | 7 | Viewing Traffic on the Map..... | 12 |
| Avoiding Traffic Delays on Your Route..... | 7 | Searching for Traffic Incidents..... | 12 |
| Avoiding Toll Roads..... | 7 | Customizing the Map..... | 12 |
| Avoiding Toll Stickers..... | 7 | Customizing the Map Layers..... | 12 |
| Avoiding Road Features..... | 7 | Changing the Map Data Field..... | 12 |
| Custom Avoidances..... | 7 | Changing the Map Perspective..... | 12 |
| Navigating Off Road..... | 7 | Live Services, Traffic, and Smartphone Features | 12 |
| Fuel Tracking..... | 7 | Pairing with Your Phone and Connecting to Smartphone | |
| Enabling Fuel Tracking..... | 7 | Link..... | 13 |
| Setting a Low Fuel Warning..... | 8 | Bluetooth Feature Status Icons..... | 13 |
| Resetting the Fuel Tank Mileage..... | 8 | Garmin Live Services..... | 13 |
| Enabling Dynamic Fuel Stops..... | 8 | Subscribing to Garmin Live Services..... | 13 |
| Finding and Saving Locations | 8 | Pairing Your Phone and Headset..... | 13 |
| Points of Interest..... | 8 | Sending a Location from Your Smartphone to Your Device..... | 13 |
| Finding a Location Using the Search Bar..... | 8 | Smart Notifications..... | 14 |
| | | Receiving Notifications..... | 14 |
| | | Viewing the List of Notifications..... | 14 |
| | | Hands-Free Calling..... | 14 |

| | | | |
|--|-----------|---|-----------|
| Placing a Call | 14 | Setting a Simulated Location | 20 |
| Receiving a Call | 14 | Bluetooth Settings | 20 |
| Using the Call History | 14 | Wi-Fi® Settings | 20 |
| Using In-Call Options | 15 | Driver Assistance Settings | 20 |
| Saving a Home Phone Number | 15 | Display Settings | 20 |
| Setting Up Bluetooth Features for Your Apple Device | 15 | Traffic Settings | 20 |
| Connecting to the Smartphone Link App on Your Apple Device | 15 | Units and Time Settings | 21 |
| Disabling Hands-Free Calling for Your Apple Device | 15 | Setting the Time | 21 |
| Disabling Smartphone Link Data and Smart Notifications for Your Apple Device | 15 | Language and Keyboard Settings | 21 |
| Setting Up Bluetooth Features for Your Smartphone with Android™ | 15 | Device and Privacy Settings | 21 |
| Connecting to the Smartphone Link App on Your Android Smartphone | 15 | Restoring Settings | 21 |
| Disabling Bluetooth Features for Your Smartphone with Android | 15 | Device Information | 21 |
| Disconnecting a Bluetooth Device | 16 | Viewing Regulatory and Compliance Information | 21 |
| Deleting a Paired Phone | 16 | Specifications | 21 |
| Traffic | 16 | Charging the Device | 21 |
| Receiving Traffic Data Using Smartphone Link | 16 | Device Maintenance | 21 |
| Receiving Traffic Data Using a Traffic Receiver | 16 | Garmin Support Center | 21 |
| Traffic Receiver Subscriptions | 16 | Map and Software Updates | 21 |
| Enabling Traffic | 16 | Connecting to a Wi-Fi Network | 21 |
| Viewing Traffic on the Map | 16 | Updating Maps and Software Using a Wi-Fi Network | 22 |
| Searching for Traffic Incidents | 16 | Product Updates | 22 |
| Using the Apps | 16 | Device Care | 23 |
| Viewing the Owner's Manual on Your Device | 16 | Cleaning the Outer Casing | 23 |
| Trip Planner | 16 | Cleaning the Touchscreen | 23 |
| Planning a Trip | 17 | Avoiding Theft | 23 |
| Editing and Reordering Locations in a Trip | 17 | Resetting the Device | 23 |
| Discovering Attractions Along Your Trip | 17 | Removing the Device, Mount, and Suction Cup | 23 |
| Changing Routing Options for a Trip | 17 | Removing the Device from the Mount | 23 |
| Navigating to a Saved Trip | 17 | Removing the Mount from the Suction Cup | 23 |
| Editing and Saving Your Active Route | 17 | Removing the Suction Cup from the Windshield | 23 |
| Sharing a Route | 17 | Changing the Fuse in the Vehicle Power Cable | 23 |
| LiveTrack | 17 | Troubleshooting | 23 |
| Setting Up LiveTrack Sharing and Inviting Viewers | 17 | The suction cup will not stay on my windshield | 23 |
| Starting LiveTrack Sharing | 18 | My device is not acquiring satellite signals | 23 |
| Tracks | 18 | The device does not charge in my vehicle | 23 |
| Viewing and Saving Track Information | 18 | My battery does not stay charged for very long | 23 |
| Media Player | 18 | My device does not connect to my phone or Smartphone Link | 23 |
| Adding the Media Player Tool to the Map | 18 | My device does not appear as a removable drive on my computer | 24 |
| Changing the Media Source | 18 | My device does not appear as a portable device on my computer | 24 |
| Pandora Service | 18 | My device does not appear as either a portable device or a removable drive or volume on my computer | 24 |
| Using the Compass | 18 | The Smartphone Link app affects the battery charge level on my smartphone | 24 |
| TracBack® | 18 | Appendix | 24 |
| Following Your Recent Track | 18 | Installing a Memory Card for Maps and Data | 24 |
| Saving Your Recent Track as a Trip | 19 | Data Management | 24 |
| Viewing the Weather Forecast | 19 | About Memory Cards | 24 |
| Viewing Weather Near a Different City | 19 | Connecting the Device to Your Computer | 24 |
| Viewing the Weather Radar | 19 | Transferring Data From Your Computer | 25 |
| Viewing Weather Alerts | 19 | Disconnecting the USB Cable | 25 |
| Checking Road Conditions | 19 | Viewing GPS Signal Status | 25 |
| Creating a Round-Trip Route | 19 | Purchasing Additional Maps | 25 |
| photoLive Traffic Cameras | 19 | Purchasing Accessories | 25 |
| Viewing and Saving photoLive Traffic Cameras | 19 | Index | 26 |
| Viewing photoLive Traffic Cameras on the Map | 19 | | |
| Saving a Traffic Camera | 19 | | |
| Viewing Previous Routes and Destinations | 19 | | |
| zūmo Settings | 20 | | |
| Map and Vehicle Settings | 20 | | |
| Enabling Maps | 20 | | |
| Navigation Settings | 20 | | |
| Calculation Mode Settings | 20 | | |

Installation

Mounting Your Device in a Motorcycle

Powered Motorcycle Mount

⚠ WARNING

Garmin® strongly recommends having an experienced installer with the proper knowledge of electrical systems install the device. Incorrectly wiring the power cable can result in damage to the vehicle or the battery and can cause bodily injury.

See the *Important Safety and Product Information* guide in the product box for product warnings and other important information.

The device must be mounted in a suitable and secure location on your motorcycle, based on available power sources and safe cable routing.

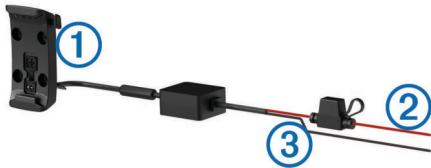

| | |
|---|---|
| ① | Motorcycle cradle |
| ② | 12 to 24 Vdc system power (red) with in-line fuse |
| ③ | System ground (black) |

Installing the Handlebar Base

The device includes parts for two handlebar installation solutions. Custom mounts may require additional hardware.

Installing the U-bolt and Handlebar Base

- 1 Place the U-bolt ① around the handlebar ②, and thread the ends through the handlebar base ③.

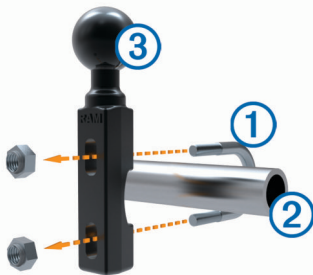

- 2 Tighten the nuts to secure the base.

NOTE: The recommended torque is 50 lbf-in (5.65 N-m). Do not exceed torque of 80 lbf-in (9.04 N-m).

Installing the Handlebar Base to the Clutch-Clamp or Brake-Clamp Brackets

- 1 Remove the two factory bolts on your clutch-clamp or brake-clamp bracket ①.

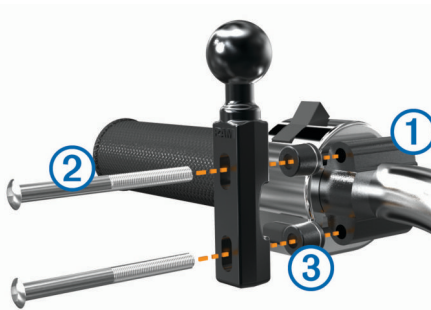

NOTE: Both 1/4 in. standard and M6 bolts are included. Match the size of the factory bolts on your clutch-clamp or brake-clamp bracket.

- 2 Thread the new bolts ② through the handlebar base, spacers ③, and clutch-clamp or brake-clamp bracket.
- 3 Tighten the bolts to secure the base.

Attaching the Power Cables to the Motorcycle Mount

- 1 Thread the power cable connector ① through the top of the opening in the motorcycle mount.



- 2 Slide the cable down to the bottom of the opening ② and pull the cable back until it is snug.
- 3 Screw the black screw ③ into the back of the mount ④ to hold the cable in place.



- 4 Thread the weather cap ⑤ through the top hole and press it into the hole.



Attaching the Base Plate to the Motorcycle Mount

NOTICE

Direct, sustained contact with the base plate, or any part of the motorcycle, may damage the mount over time. To prevent this kind of damage, you must place the mounting spacers between the mount and base plate, and make sure that no part of the device or mount touches the motorcycle.

- 1 Thread the M4 x 20 mm panhead screws ① through the washers ②, cradle, spacers ③, and base plate ④.



- 2 Tighten the nuts to secure the base plate.

Attaching the Base Plate to the Handlebar Base

- 1 Align the ball of the handlebar base ① and the ball of the base plate ② with each end of the double-socket arm ③.



- 2 Insert each ball into the double-socket arm.
- 3 Tighten the knob slightly.
- 4 Adjust for optimal viewing and operation.
- 5 Tighten the knob to secure the mount.

Installing Your Device in the Motorcycle Mount

- 1 Fit the left side of your device into the cradle.



- 2 Push the right side of the device forward until it snaps into place.
- 3 If the latch ① on the mount stays up after you insert the device, press it down.

Removing Your Device from the Motorcycle Mount

- 1 Press the release button on the bottom of the mount.
- 2 Lift out the device.

Mounting Your Device in an Automobile

NOTICE

Before mounting the device, check the local laws pertaining to windshield mounting.

⚠ WARNING

This product contains a lithium-ion battery. To prevent the possibility of personal injury or product damage caused by battery exposure to extreme heat, store the device out of direct sunlight.

Do not use the suction cup mount on a motorcycle.

See the *Important Safety and Product Information* guide in the product box for product warnings and other important information.

NOTE: The automobile mount is not included with all device models. Go to garmin.com to purchase optional accessories.

- 1 Plug the automotive power cable ① into the port ② on the mount.



- 2 Remove the clear plastic from the suction cup ③.
- 3 Clean and dry your windshield and the suction cup with a lint-free cloth.
- 4 Press the suction cup to the windshield, and flip the lever ④ back toward the windshield.
- 5 Snap the cradle ⑤ onto the suction cup arm.
- 6 Fit one side of your device into the cradle.
- 7 Press the device into the cradle until it snaps into place.
- 8 Plug the other end of the automotive power cable into a power outlet.

Getting Started

⚠ WARNING

See the *Important Safety and Product Information* guide in the product box for product warnings and other important information.

- Update the maps and software on your device (*Product Updates*, page 22).
- Mount the device and connect it to power.
- Pair your Bluetooth® phone and headset (*Pairing Your Phone and Headset*, page 13) (optional).
- Acquire GPS signals (*Acquiring GPS Signals*, page 3).
- Adjust the screen brightness (*Adjusting the Screen Brightness*, page 3).
- Navigate to your destination (*Starting a Route*, page 5).

Device Overview



| | |
|---|---------------------------|
| ① | Power button |
| ② | microSD® memory card slot |
| ③ | USB power and data port |

Turning the Device On or Off

- To turn the device on, press the power key, or connect the device to power.
- To put the device in power saving mode, press the power key while the device is on.

While in power saving mode, the screen is off and the device uses very little power, but it can wake instantly for use.

TIP: You can charge your device faster by putting it in power saving mode while charging the battery.

- To turn off the device completely, hold the power key until a prompt appears on the screen, and select **Off**.

The prompt appears after five seconds. If you release the power key before the prompt appears, the device enters power saving mode.

Acquiring GPS Signals

When you turn on your navigation device, the GPS receiver must collect satellite data and establish the current location. The time required to acquire satellite signals varies based on several factors, including how far you are from the location where you last used your navigation device, whether you have a clear view of the sky, and how long it has been since you last used your navigation device. The first time you turn on your navigation device, it may take several minutes to acquire satellite signals.

- Turn on the device.
- Wait while the device locates satellites.
- If necessary, go to an open area, away from tall buildings and trees.

in the status bar indicates the satellite signal strength. When at least half the bars are filled, the device is ready for navigation.

Status Bar Icons

The status bar is located at the top of the main menu. The status bar icons display information about features on the device. You can select some icons to change settings or view additional information.

| | |
|-------------|---|
| | GPS signal status. Hold to view GPS accuracy and acquired satellite information (Viewing GPS Signal Status, page 25). |
| | Bluetooth technology status. Select to view the Bluetooth settings (Bluetooth Settings, page 20). |
| | Wi-fi signal strength. Select to change the wi-fi settings (Wi-Fi® Settings, page 20). |
| | Connected to hands-free calling. Select to place a phone call (Hands-Free Calling, page 14). |
| | Active transportation mode. Select to change the transportation mode. |
| 9:10 | Current time. Select to set the time (Setting the Time, page 21). |

| | |
|--------------|---|
| | Battery charge level. |
| | Sharing LiveTrack data. The number of invited viewers appears on the icon. Select to open the LiveTrack app (LiveTrack, page 17). |
| | Smartphone Link status. Select to connect to the Smartphone Link app and receive live traffic data and other live services (Pairing with Your Phone and Connecting to Smartphone Link, page 13). When the icon is blue, the device is connected to the Smartphone Link app. |
| 53° F | Temperature. Select to view the weather forecast (Viewing the Weather Forecast, page 19). |
| | Fuel status. Select to view fuel tracking information (Fuel Tracking, page 7). |

Using the On-Screen Buttons

On-screen buttons allow you to navigate the pages, menus, and menu options on your device.

- Select to return to the previous menu screen.
- Hold to quickly return to the main menu.
- Select or to scroll through lists or menus.
- Hold or to scroll faster.
- Select to see a context-based menu of options for the current screen.

Adjusting the Volume

- Select **Volume**.
- Select an option:
 - Use the slider bar to adjust the volume.
 - Select to mute the device.
 - Select for additional options.

Using the Audio Mixer

You can use the audio mixer to set the volume levels for different audio types, such as navigation prompts or phone calls. The level for each audio type is a percentage of the master volume.

- Select **Volume**.
- Select > **Audio Mixer**.
- Use the sliders to adjust the volume for each audio type.

Adjusting the Screen Brightness

- Select **Settings** > **Display** > **Brightness**.
- Use the slider bar to adjust the brightness.

Rider Awareness Features and Alerts

NOTICE

The rider alerts and speed limit features are for information only and do not replace your responsibility to abide by all posted speed limit signs and to use safe driving judgment at all times. Garmin is not responsible for any traffic fines or citations you receive for failing to follow all applicable traffic laws and signs.

Your device provides features that can help encourage safer riding and increase efficiency, even when you are riding in a familiar area. The device plays an audible tone or message and displays information for each alert. You can enable or disable the audible tone or message for each type of alert. Not all alerts are available in all areas.

School zone or nearby school: The device plays a tone and displays the distance to and speed limit (if available) for an upcoming school or school zone.

Speed limit reduction: The device plays a tone and displays the upcoming reduced speed limit so you can be prepared to reduce your speed.

Speed limit exceeded: The device plays a tone and displays a red border on the speed limit icon when you exceed the posted speed limit for the current road.

Railroad crossing: The device plays a tone and displays the distance to an upcoming railroad crossing.

Animal crossing: The device plays a tone and displays the distance to an upcoming animal crossing area.

Curve: The device plays a tone and displays the distance to a curve in the road.

Slower traffic: The device plays a tone and displays the distance to slower traffic when you approach slower traffic at a higher speed. Your device must be receiving traffic information to use this feature (*Receiving Traffic Data Using Smartphone Link, page 16*).

Fatigue warning: The device plays a tone and suggests upcoming rest stops after you have been driving for more than two hours without stopping.

Enabling or Disabling Rider Alerts

You can turn off individual audible rider alerts. Visual alerts appear even when the audible alert is disabled.

- 1 Select **Settings > Driver Assistance > Audible Rider Alerts**.
- 2 Select or clear the check box next to each alert.

Red Light and Speed Cameras

NOTICE

Garmin is not responsible for the accuracy of or the consequences of using a red light or speed camera database.

NOTE: This feature is not available for all regions or product models.

Information about red light and speed camera locations is available in some areas for some product models. The device alerts you when you approach a reported speed or red light camera.

- Live red light and safety camera data is available as a subscription from Garmin Live Services using the Smartphone Link app (*Garmin Live Services, page 13*).
- To maintain an updated database of red light and speed camera locations, your device must have an active subscription to download and store safety camera data. Go to garmin.com/speedcameras to check availability and compatibility, or to purchase a subscription or one-time update. You can purchase a new region or extend an existing subscription at any time.

NOTE: In some regions, some product bundles include pre-loaded red light and speed camera data with free lifetime updates.

- You can use the Garmin Express™ software (garmin.com/express) to update the camera database stored on your device. You should update your device frequently to receive the most up-to-date camera information.

Incident Detection and Notifications

WARNING

The device allows you to send your location to an emergency contact. This is a supplemental feature and should not be relied upon as a primary method to obtain emergency assistance. The Smartphone Link app does not contact emergency services on your behalf.

Your zūmo device uses built-in sensors to detect a possible vehicle incident.

- If you set up an incident contact, the device can send an automated text message to that contact when it detects an

incident and your vehicle stops moving. This can help alert the contact to your situation if you are not able to call or send a message. This feature requires a connection to Smartphone Link and an active mobile data connection to send a message.

- If you have not set up an incident contact, the device automatically displays the nearest address or geographic coordinates when it detects an incident. This feature is helpful if you need to tell emergency personnel your location. You can select **More** to view the Where Am I? page.

Setting Up an Incident Contact

Before you can set up an incident detection contact, you must complete these tasks:

- Connect your device to Smartphone Link (*Pairing with Your Phone and Connecting to Smartphone Link, page 13*).
- Select **Settings > Bluetooth**, select your phone name, and verify the **Phone calls** option is enabled.

The device must have access to the Smartphone Link app and to your smartphone phone book during the incident contact setup. If you do not want to use your device for hands-free calling, you can disable the Phone calls option after the incident contact setup is complete.

- 1 Select **Settings > Driver Assistance > Incident Notification > Continue**.

A list of your smartphone contacts appears.

- 2 Select a contact, and select **Next**.
- 3 Verify the contact's phone number, and select **Next**.
- 4 Enter your name or nickname, and select **Done**.
- 5 Review the sample incident message, and select **Next**.

- 6 Follow the on-screen instructions to inform your contact that you have added them as an incident contact.

NOTE: The incident notification message includes the name or nickname you entered, but it is not sent from your phone number. The message is sent using a third-party service, and you should inform your incident contact that the incident message will come from an unknown number.

- 7 Select **OK**.
- 8 Review the information, and select **Save**.

Cancelling an Incident Notification

When the device detects an incident, a message and a voice prompt inform you that a notification will be sent to your incident contact. A 60-second countdown timer starts when the incident is detected, and the device sends the notification automatically when the timer expires. If you do not want to send the notification, you can cancel it.

Before the timer expires, select **Cancel**.

Disabling Incident Notifications

While incident notifications are disabled, the device does not send an SMS notification when it detects an incident.

- 1 Select **Settings > Driver Assistance > Incident Notification**.
- 2 Clear the **Incident Detection SMS** check box.

Viewing Helmet Law Notifications

Helmet law and eye protection notifications may appear on your zūmo device the first time your device acquires satellites and when your device approaches a location with motorcycle safety rules.

NOTICE

Garmin recommends that all riders wear helmets for safety. Helmet law notifications are for reference only, are subject to change, and are not intended to be considered legal advice.

Helmet law notifications are available in the U.S. and Canada only.

Select the notification to view more details.

Searching for Helmet Laws

You can search for helmet laws by state or province.

- 1 Select **Apps > Helmet Guide**.
- 2 Select a state or province.

Navigating to Your Destination

Routes

A route is a path from your current location to one or more destinations.

- The device calculates a recommended route to your destination based on the preferences you set, including the route calculation mode (*Changing the Route Calculation Mode, page 5*) and avoidances (*Avoiding Delays, Tolls, and Areas, page 7*).
- You can start navigating to your destination quickly using the recommended route, or you can select an alternate route (*Starting a Route, page 5*).
- If there are specific roads you need to use or avoid, you can customize the route.
- You can add multiple destinations to a route.

Starting a Route

- 1 Select **Where To?**, and search for a location.
- 2 Select a location.
- 3 Select an option:
 - To start navigating using the recommended route, select **Go!**.
 - To choose an alternate route, select **Y**, and select a route. Alternate routes appear to the right of the map.
 - To edit the course of the route, select **Y > Edit Route**, and add shaping points to the route.

The device calculates a route to the location and guides you using voice prompts and information on the map (*Your Route on the Map, page 5*). A preview of the major roads in your route appears at the edge of the map for several seconds.

If you need to stop at additional destinations, you can add the locations to your route.

Changing the Route Calculation Mode

- 1 Select **Settings > Navigation > Calculation Mode**.
- 2 Select an option:
 - Select **Faster Time** to calculate routes that are faster to drive but can be longer in distance.
 - Select **Garmin Adventurous Routing™** to calculate routes that prefer curvy roads.
 - Select **Off Road** to calculate point-to-point routes (without roads).
 - Select **Shorter Distance** to calculate routes that are shorter in distance but can take more time to drive.

Taking a Route Using Adventurous Routing

Your device can calculate routes that prefer curvy roads, hills, and fewer highways. This feature can provide a more enjoyable ride, but it may increase the time or distance to your destination.

NOTE: This feature is not available on all device models or for all map regions.

- 1 Select **Settings > Navigation > Calculation Mode > Garmin Adventurous Routing™ > Save**.

- 2 Select **Garmin Adventurous Routing™**.
- 3 Use the **Prefer Curves** slider to include more or fewer curves.
- 4 Use the **Prefer Hills** slider to include more or fewer hills.
- 5 Use the **Avoid Major Highways** slider to include more or fewer highways.
- 6 Start a route (*Starting a Route, page 5*).

Starting a Route by Using the Map

You can start route by selecting a location from the map.

- 1 Select **View Map**.
- 2 Drag and zoom the map to display the area to search.
- 3 If necessary, select **Q** to filter the displayed points of interest by category.
Location markers (📍 or a blue dot) appear on the map.
- 4 Select an option:
 - Select a location marker.
 - Select a point, such as a street, intersection, or address location.
- 5 Select **Go!**.

Going Home

The first time you start a route home, the device prompts you to enter your home location.

- 1 Select **Where To? > Go Home**.
- 2 If necessary, enter your home location.

Editing Your Home Location

- 1 Select **Where To? > ≡ > Set Home Location**.
- 2 Enter your home location.

Your Route on the Map

As you travel, the device guides you to your destination using voice prompts and information on the map. Instructions for your next turn or exit, or other actions appear across the top of the map.

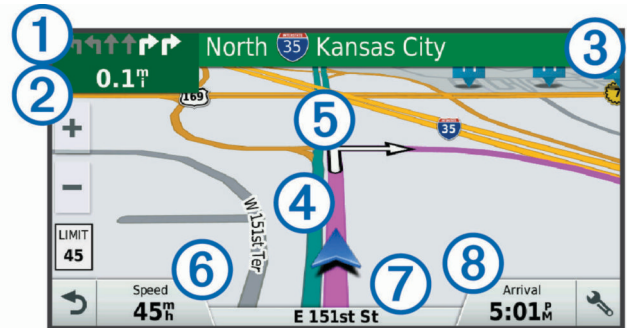

| | |
|---|---|
| ① | Next action in the route. Indicates the next turn, exit, or other action and the lane in which you should travel, if available. |
| ② | Distance to the next action. |
| ③ | Name of the street or exit associated with the next action. |
| ④ | Route highlighted on the map. |
| ⑤ | Next action in the route. Arrows on the map indicate the location of upcoming actions. |
| ⑥ | Vehicle speed. |
| ⑦ | Name of the road on which you are traveling. |
| ⑧ | Estimated arrival time. |
| | TIP: You can touch this field to change the information it shows. |

Active Lane Guidance

As you approach some turns, exits, or interchanges in your route, a detailed simulation of the road appears beside the map,

if available. A colored line ① indicates the proper lane for the turn.

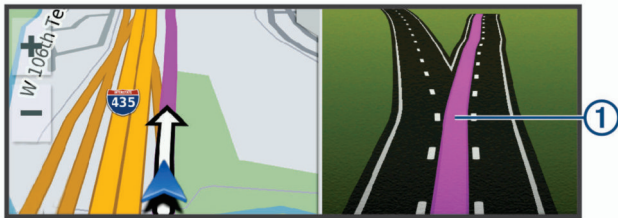

Viewing Turns and Directions

While navigating a route, you can view upcoming turns, lane changes, or other directions for your route.

1 From the map, select an option:

- To view upcoming turns and directions as you navigate, select > **Turns**.

The map tool displays the next four turns or directions beside the map. The list updates automatically as you navigate the route.

- To view the complete list of turns and directions for the entire route, select the text bar at the top of the map.

2 Select a turn or direction (optional).

Detailed information appears. An image of the junction may appear for junctions on major roadways, if available.

Viewing the Entire Route on the Map

1 While navigating a route, select anywhere on the map.

2 Select .

Arriving at Your Destination

When you approach your destination, the device provides information to help you complete your route.

- indicates the location of your destination on the map, and a voice prompt announces you are approaching your destination.
- When you approach some destinations, the device automatically prompts you to search for parking. You can select **Yes** to find nearby parking areas ([Parking Near Your Destination](#), page 6).
- When you stop at your destination, the device automatically ends the route. If the device does not detect your arrival automatically, you can select **Stop** to end your route.

Parking Near Your Destination

Your device can help you find a parking spot near your destination. When you approach some destinations, the device automatically prompts you to search for parking.

1 Select an option:

- When the device prompts you, select **Yes** to search for nearby parking.
- If the device does not prompt you, select **Where To? > Categories > Parking**, and select > **My Destination**.

2 Select **Filter Parking**, and select one or more categories to filter parking by availability, type, price, or payment methods (optional).

NOTE: Detailed parking data is not available in all areas or for all parking locations.

3 Select a parking location, and select **Go! > Add as Next Stop**.

The device guides you to the parking area.

Finding Your Last Parking Spot

When you disconnect the device from vehicle power while the device is on, your current location is saved as a parking spot.

Select **Apps > Last Spot**.

Changing Your Active Route

Adding a Location to Your Route

Before you can add a location to your route, you must be navigating a route ([Starting a Route](#), page 5).

You can add locations to the middle or end of your route. For example, you can add a fuel station as the next destination in your route.

TIP: To create complex routes with multiple destinations or scheduled stops, you can use the trip planner to plan, schedule, and save a trip ([Planning a Trip](#), page 17).

1 From the map, select > **Where To?**

2 Search for a location.

3 Select a location.

4 Select **Go!**.

5 Select an option:

- To add the location as the next destination in your route, select **Add as Next Stop**.
- To add the location to the end of your route, select **Add as Last Stop**.
- To add the location and edit the order of destinations in your route, select **Add to Active Route**.

The device re-calculates the route to include the added location and guides you to the destinations in order.

Shaping Your Route

Before you can shape your route, you must start a route ([Starting a Route](#), page 5).

You can manually shape your route to change its course. This allows you to direct the route to use a certain road or go through a certain area without adding a destination to the route.

1 Touch anywhere on the map.

2 Select .

The device enters route shaping mode.

3 Select a location on the map.

TIP: You can select to zoom in on the map and select a more precise location.

The device recalculates the route to travel through the selected location.

4 If necessary, select an option:

- To add more shaping points to the route, select additional locations on the map.
- To remove a shaping point, select .

5 When you are finished shaping the route, select **Go!**.

Taking a Detour

You can take a detour for a specified distance along your route or detour around specific roads. This is useful if you encounter construction zones, closed roads, or poor road conditions.

1 From the map, select > **Change Route**.

TIP: If the Change Route tool is not in the map tools menu, you can add it ([Enabling Map Tools](#), page 11).

2 Select an option:

- To detour your route for a specific distance, select **Detour by Distance**.
- To detour around a specific road on the route, select **Detour by Road**.
- To find a new route, select **Detour**.

Stopping the Route

From the map, select > **Stop**.

Using Suggested Routes

Before you can use this feature, you must save at least one location and enable the travel history feature (*Device and Privacy Settings*, page 21).

Using the myTrends™ feature, your device predicts your destination based on your travel history, the day of the week, and the time of day. After you have driven to a saved location several times, the location may appear in the navigation bar on the map, along with the estimated time of travel, and traffic information.

Select the navigation bar to view a suggested route to the location.

Avoiding Delays, Tolls, and Areas

Avoiding Traffic Delays on Your Route

Before you can avoid traffic delays, you must be receiving traffic information (*Receiving Traffic Data Using Smartphone Link*, page 16).

By default, the device optimizes your route to avoid traffic delays automatically. If you have disabled this option in the traffic settings (*Traffic Settings*, page 20), you can view and avoid traffic delays manually.

- 1 While navigating a route, select  > **Traffic**.
- 2 Select **Alternate Route**, if available.
- 3 Select **Go!**.

Avoiding Toll Roads

Your device can avoid routing you through areas that require tolls, such as toll roads, toll bridges, or congestion areas. The device may still include a toll area in your route if no other reasonable routes are available.

- 1 Select **Settings > Navigation**.
- 2 Select an option:
NOTE: The menu changes based on your area and the map data on your device.
 - Select **Toll Roads**.
 - Select **Tolls and Fees > Toll Roads**.
- 3 Select an option:
 - To be asked each time before routing through a toll area, select **Always Ask**.
 - To always avoid tolls, select **Avoid**.
 - To always allow tolls, select **Allow**.
- 4 Select **Save**.

Avoiding Toll Stickers

NOTE: This feature is not available in all areas.

The map data on your device may contain detailed toll sticker information for some countries. You can avoid or allow toll stickers for each country.

- 1 Select **Settings > Navigation > Tolls and Fees > Toll Stickers**.
- 2 Select a country.
- 3 Select an option:
 - To be asked each time before routing through a toll area, select **Always Ask**.
 - To always avoid tolls, select **Avoid**.
 - To always allow tolls, select **Allow**.
- 4 Select **Save**.

Avoiding Road Features

- 1 Select **Settings > Navigation > Avoidances**.
- 2 Select the road features to avoid on your routes, and select **Save**.

Custom Avoidances

Custom avoidances allow you select specific areas or sections of road to avoid. When the device calculates a route, it avoids these areas and roads unless no other reasonable route is available.

Avoiding a Road

- 1 Select **Settings > Navigation > Custom Avoidances**.
- 2 Select **Add Avoid Road**.
- 3 Select the starting point of the section of road to avoid, and select **Next**.
- 4 Select the ending point of the road section, and select **Next**.
- 5 Select **Done**.

Avoiding an Area



- 1 Select **Settings > Navigation > Custom Avoidances**.
- 2 If necessary, select **Add Avoidance**.
- 3 Select **Add Avoid Area**.
- 4 Select the upper-left corner of the area to avoid, and select **Next**.
- 5 Select the lower-right corner of the area to avoid, and select **Next**.
The selected area is shaded on the map.
- 6 Select **Done**.

Disabling a Custom Avoidance

You can disable a custom avoidance without deleting it.

- 1 Select **Settings > Navigation > Custom Avoidances**.
- 2 Select an avoidance.
- 3 Select  > **Disable**.

Deleting Custom Avoidances

- 1 Select **Settings > Navigation > Custom Avoidances**.
- 2 Select an option:
 - To delete all custom avoidances, select .
 - To delete one custom avoidance, select the avoidance, and select  > **Delete**.

Navigating Off Road

If you are not following roadways as you navigate, you can use Off Road mode.

- 1 Select **Settings > Navigation**.
- 2 Select **Calculation Mode > Off Road > Save**.
The next route will be calculated as a straight line to the location.

Fuel Tracking

You can set your device to estimate your fuel usage, warn you when you approach the maximum estimated fuel distance, and suggest fuel stops based on your estimated fuel range. When fuel tracking is enabled,  indicates the current fuel status.

White: Fuel tracking is disabled, or the device is not connected to the motorcycle mount.

Green: The estimated fuel range is above the fuel tank warning level.

Orange: The estimated fuel range is below the fuel tank warning level.

Red: The estimated distance remaining on the tank is 0.

Enabling Fuel Tracking

Before you can enable fuel tracking, the device must be in motorcycle mode or off road mode and placed in the motorcycle mount.

When you enable fuel tracking, a fuel gauge appears on the trip computer (*Viewing the Trip Information Page*, page 12).

- 1 Fill your fuel tank.
- 2 Select **Apps > Fuel Settings > Fuel Tracking**.
- 3 Select **Distance Per Tank**.
- 4 Enter the distance the vehicle travels on a tank of gas and select **Done**.

Setting a Low Fuel Warning

You can set the device to warn you when the tank is low on fuel.

NOTE: The device must be connected to the motorcycle mount to give low fuel warnings.

- 1 Enable fuel tracking (*Enabling Fuel Tracking, page 7*).
- 2 Select **Remaining Fuel Warning**.
- 3 Enter a distance, and select **Done**.

When you have only enough fuel left to travel the distance you entered, a low fuel warning appears on the map page.

Resetting the Fuel Tank Mileage

When you refill your fuel tank, you should reset the fuel tank mileage on your device to more accurately track your remaining fuel.

Select **Apps > Fuel Settings > Reset Fuel Tank**.

Enabling Dynamic Fuel Stops

Before you can enable dynamic fuel stops, the device must be in motorcycle mode, placed in the motorcycle mount, and fuel tracking must be enabled.

You can set the device to suggest fuel stops based on your estimated fuel range.

Select **Apps > Fuel Settings > Dynamic Fuel Stops**.

Finding and Saving Locations

The maps loaded in your device contain locations, such as restaurants, hotels, auto services, and detailed street information. The Where To? menu helps you find your destination by providing several methods to browse, search, and save this information.

- Enter search terms to quickly search all location information (*Finding a Location Using the Search Bar, page 8*).
- Browse or search pre-loaded points of interest by category (*Points of Interest, page 8*).
- Search and check into Foursquare® points of interest (*Searching Foursquare Points of Interest, page 10*).
- Use search tools to find specific locations, such as addresses, intersections, or geographic coordinates (*Search Tools, page 9*).
- Search near a different city or area (*Changing the Search Area, page 9*).
- Save your favorite locations to find them quickly in the future (*Saving Locations, page 11*).
- Return to recently found locations (*Viewing Recently Found Locations, page 10*).

Points of Interest

A point of interest is a place that you may find useful or interesting. Points of interest are organized by category and can include popular travel destinations such as gas stations, restaurants, hotels, and entertainment venues.

Finding a Location Using the Search Bar

You can use the search bar to search for locations by entering a category, brand name, address, or city name.

- 1 Select **Where To?**
- 2 Select **Enter Search** in the search bar.
- 3 Enter all or part of the search term.

Suggested search terms appear below the search bar.

- 4 Select an option:
 - To search for a type of business, enter a category name (for example, "movie theaters").
 - To search for a business name, enter all or part of the name.
 - To search for an address near you, enter the house number and street name.
 - To search for an address in another city, enter the house number, street name, city, and state.
 - To search for a city, enter the city and state.
 - To search for coordinates, enter latitude and longitude coordinates.
- 5 Select an option:
 - To search using a suggested search term, select the term.
 - To search using the text you entered, select **Q**.
- 6 If necessary, select a location.

Finding a Location by Category

- 1 Select **Where To?**
- 2 Select a category, or select **Categories**.
- 3 If necessary, select a subcategory.
- 4 Select a location.

Searching Within a Category

After you have performed a search for a point of interest, certain categories may display a Quick Search list that shows the last four destinations you selected.

- 1 Select **Where To? > Categories**.
- 2 Select a category.
- 3 Select an option:
 - Select a destination from the quick search list on the right side of the screen.
The quick search list provides a list of recently found locations in the selected category.
 - Select a subcategory, if necessary, and select a destination.

Navigating to Points of Interest Within a Venue

NOTE: This feature may not be available in all areas or for all product models.

You can create a route to a point of interest (POI) within a larger venue, such as a store in a shopping mall or a specific terminal in an airport.

- 1 Select **Where To? > Enter Search**.
- 2 Select an option:
 - To search for the venue, enter the name or address of the venue, select **Q**, and go to step 3.
 - To search for the POI, enter the name of the POI, select **Q**, and go to step 5.
- 3 Select the venue.
A list of categories appears below the venue, such as restaurants, car rentals, or terminals.
- 4 Select a category.
- 5 Select the POI, and select **Go!**

The device creates a route to the parking area or venue entrance closest to the POI. When you arrive at the destination, a checkered flag indicates the recommended parking area. A labeled point indicates the location of the POI within the venue.

Exploring a Venue

NOTE: This feature may not be available in all areas or for all product models.

You can view a list of all points of interest located within each venue.

- 1 Select a venue.
- 2 Select **i** > **Explore this Venue**.

Location Search Results

By default, the location search results appear in a list, with the nearest location at the top. You can scroll down to view more results.



| | |
|--------------|---|
| ① | Select a location to view the option menu. |
| ② i | Select to view detailed information about the selected location. |
| ③ P | Select to find parking areas near the location. |
| ④ Y | Select to view alternate routes to the locations. |
| ⑤ Go! | Select to start navigating to the location using the recommended route. |
| ⑥ Map | Select to view the search results on the map. |

Location Search Results on the Map

You can view the results of a location search on the map instead of in a list.

From the location search results, select **Map**. The nearest location appears at the center of the map, and basic information about the selected location appears at the bottom of the map.



| | |
|--------------|---|
| ① | Drag the map to view additional search results. |
| ② | Additional search results. Select to view another location. |
| ③ | Selected location summary. Select to view detailed information about the selected location. |
| ④ Go! | Select to start navigating to the location using the recommended route. |
| ⑤ Map | Select to view the search results in a list. |

Changing the Search Area

By default, the device searches near your current location. You can also search other areas, such as near your destination, near another city, or along your active route.

- 1 Select **Where To?**.
- 2 Select **Location**.
- 3 Select an option.

Parking

Your zūmo device includes detailed parking data, which can help you find nearby parking based on the likelihood of available parking spots, type of parking area, price, or accepted payment methods.

In some areas, live parking data is available while your zūmo device is connected to Smartphone Link (*Pairing with Your Phone and Connecting to Smartphone Link*, page 13). While your device is receiving live parking data, you can view real-time parking trends.

NOTE: Detailed parking data is not available in all areas or for all parking locations. Garmin is not responsible for the accuracy or timeliness of live parking data.

Finding Parking Near Your Current Location

- 1 Select **Where To? > Categories > Parking**.
- 2 Select **Filter Parking**, and select one or more categories to filter parking by availability, type, price, or payment methods (optional).
NOTE: Detailed parking data is not available in all areas or for all parking locations.
- 3 Select a parking location.
- 4 Select **Go!**.

Finding Parking Near a Specified Location

- 1 Search for a location.
- 2 From the location search results, select a location.
- 3 Select **P**.
A list of parking areas near the selected location appears.
- 4 Select **Filter Parking**, and select one or more categories to filter parking by availability, type, price, or payment methods (optional).
NOTE: Detailed parking data is not available in all areas or for all parking locations.
- 5 Select a parking location.
- 6 Select **Go!**.

Understanding Parking Colors and Symbols

Parking locations that include detailed parking data are color-coded to show the likelihood of finding parking. Symbols indicate the type of parking available (street or lot), relative pricing information, and payment type.

You can view the legend for these colors and symbols on the device.

From the parking search results, select **i**.

Search Tools

Search tools allow you to search for specific types of locations by responding to on-screen prompts.

Finding an Address

NOTE: The order of the steps may change depending on the map data loaded on your device.

- 1 Select **Where To?**.
- 2 If necessary, select **Searching near:** to change the search area (*Changing the Search Area*, page 9).
- 3 Select **Address**.
- 4 Follow the on-screen instructions to enter address information.
- 5 Select the address.

Finding an Intersection

You can search for an intersection or junction between two streets, highways, or other roads.

- 1 Select **Where To? > Categories > Intersections**.

- 2 Follow the on-screen instructions to enter street information.
- 3 Select the intersection.

Finding a City

- 1 Select **Where To?** > **Categories** > **Cities**.
- 2 Select an option:
 - Select a city from the list of nearby cities.
 - To search near another location, select **Searching near:** (*Changing the Search Area*, page 9).
 - To search for a city by name, select **Enter Search**, enter a city name, and select **Q**.

Finding a Location Using Coordinates

You can find a location using latitude and longitude coordinates. This can be helpful when geocaching.

- 1 Select **Where To?** > **Categories** > **Coordinates**.
- 2 If necessary, select , and change the coordinate format or datum.
- 3 Enter the latitude and longitude coordinates.
- 4 Select **View on Map**.

Foursquare

Foursquare is a location-based social network. Your device includes pre-loaded Foursquare points of interest, which are indicated by the Foursquare logo in your location search results.

For additional features, you can connect to your Foursquare account using Smartphone Link on your compatible smartphone. When you connect to your Foursquare account using Smartphone Link, you can view Foursquare location details, check in to a location, and search for points of interest in the online Foursquare database.

Connecting to Your Foursquare Account

- 1 Connect your device to Smartphone Link (*Pairing with Your Phone and Connecting to Smartphone Link*, page 13).
- 2 On your smartphone, open the Smartphone Link app.
- 3 Open the Smartphone Link app settings, and select **Foursquare®** > **Login**.
- 4 Enter your Foursquare login information.

Searching Foursquare Points of Interest

You can search for Foursquare points of interest loaded on your device. When you connect to your Foursquare account using Smartphone Link, the search provides the most up-to-date results from the online Foursquare database and customized results from your Foursquare user account.

Select **Where To?** > **Categories** > **Foursquare®**.

Viewing Foursquare Location Details

Before you can view Foursquare location details, you must connect to a supported phone running Smartphone Link and log in to your Foursquare account.

You can view detailed Foursquare location information, such as user ratings, restaurant pricing information, and hours of operation.

- 1 From the location search results, select a Foursquare point of interest.
- 2 Select .

Checking in with Foursquare

Before you can check in with Foursquare, you must connect to a supported phone running Smartphone Link and log in to your Foursquare account.

- 1 Select **Apps** > **Foursquare®** > **Check In**.
- 2 Select a point of interest.
- 3 Select  > **Check In**.

TripAdvisor®

Your device includes TripAdvisor points of interest and ratings. TripAdvisor ratings appear automatically in the search results list for applicable points of interest. You can also search for nearby TripAdvisor points of interest and sort by distance or popularity.

Finding TripAdvisor Points of Interest

- 1 Select **Where To?** > **Categories** > **TripAdvisor**.
- 2 Select a category.

A list of nearby TripAdvisor points of interest for the category appears.
- 3 Select **Sort Results** to sort the search results by distance or popularity (optional).

Viewing Recently Found Locations

Your device stores a history of the last 50 locations you have found.

Select **Where To?** > **Recent**.

Clearing the List of Recently Found Locations

Select **Where To?** > **Recent** >  > **Clear** > **Yes**.

Viewing Current Location Information

You can use the Where Am I? page to view information about your current location. This feature is helpful if you need to tell emergency personnel your location.

From the map, select the vehicle.

Finding Emergency Services and Fuel

You can use the Where Am I? page to find the nearest hospitals, police stations, and fuel stations.

- 1 From the map, select the vehicle.
- 2 Select **Hospitals**, **Police Stations**, or **Fuel**.

A list of locations for the selected service appears, with the nearest locations at the top.
- 3 Select a location.
- 4 Select an option:
 - To navigate to the location, select **Go!**
 - To view the phone number and other location details, select .

Getting Directions to Your Current Location

If you need to tell another person how to get to your current location, your device can give you a list of directions.

- 1 From the map, select the vehicle.
- 2 Select  > **Directions to Me**.
- 3 Select a starting location.
- 4 Select **Select**.

Adding a Shortcut

You can add shortcuts to the Where To? menu. A shortcut can point to a location, a category, or a search tool.

The Where To? menu can contain up to 36 shortcut icons.

- 1 Select **Where To?** > **Add Shortcut**.
- 2 Select an item.

Removing a Shortcut

- 1 Select **Where To?** >  > **Remove Shortcut(s)**.
- 2 Select a shortcut to remove.
- 3 Select the shortcut again to confirm.
- 4 Select **Save**.

Saving Locations

Saving a Location

- 1 Search for a location (*Finding a Location by Category*, page 8).
- 2 From the search results, select a location.
- 3 Select **i**.
- 4 Select **≡** > **Save**.
- 5 If necessary, enter a name, and select **Done**.

Saving Your Current Location

- 1 From the map, select the vehicle icon.
- 2 Select **Save**.
- 3 Enter a name, and select **Done**.
- 4 Select **OK**.

Editing a Saved Location

- 1 Select **Where To?** > **Saved**.
- 2 If necessary, select a category.
- 3 Select a location.
- 4 Select **i**.
- 5 Select **≡** > **Edit**.
- 6 Select an option:
 - Select **Name**.
 - Select **Phone Number**.
 - Select **Categories** to assign categories to the saved location.
 - Select **Change Map Symbol** to change the symbol used to mark the saved location on a map.
- 7 Edit the information.
- 8 Select **Done**.

Assigning Categories to a Saved Location

You can add custom categories to organize your saved locations.

NOTE: Categories appear in the saved locations menu after you have saved at least 12 locations.

- 1 Select **Where To?** > **Saved**.
- 2 Select a location.
- 3 Select **i**.
- 4 Select **≡** > **Edit** > **Categories**.
- 5 Enter one or more category names, separated by commas.
- 6 If necessary, select a suggested category.
- 7 Select **Done**.

Deleting a Saved Location

NOTE: Deleted locations cannot be recovered.

- 1 Select **Where To?** > **Saved**.
- 2 Select **≡** > **Delete Saved Places**.
- 3 Select the box next to the saved locations to delete, and select **Delete**.

Using the Map

You can use the map to navigate a route (*Your Route on the Map*, page 5) or to view a map of your surroundings when no route is active.

- 1 Select **View Map**.
- 2 Touch anywhere on the map.
- 3 Select an option:
 - Drag the map to pan left, right, up, or down.

- To zoom in or out, select **+** or **-**.
- To switch between North Up and 3-D views, select **▲**.
- To filter the displayed points of interest by category, select **Q**.
- To start a route, select a location on the map, and select **Go!** (*Starting a Route by Using the Map*, page 5).

Map Tools

Map tools provide quick access to information and device functions while you view the map. When you activate a map tool, it appears in a panel at the edge of the map.

Stop: Stops navigation of the active route.

Change Route: Allows you to take a detour or skip locations in your route.

Up Ahead: Displays upcoming locations along the route or the road on which you are traveling (*Up Ahead*, page 11).

Turns: Displays a list of upcoming turns in your route (*Viewing Turns and Directions*, page 6).

Trip Data: Displays customizable trip data, such as speed or mileage (*Viewing Trip Data from the Map*, page 12).

Volume: Adjusts the master audio volume.

Brightness: Adjusts the screen brightness.

Phone: Displays a list of recent phone calls from your connected phone, and displays in-call options while a phone call is active (*Using In-Call Options*, page 15).

LiveTrack: Allows you to start and stop LiveTrack sharing (*LiveTrack*, page 17).

Traffic: Displays traffic conditions along your route or in your area (*Viewing Upcoming Traffic*, page 12).

Weather: Displays weather conditions for your area.

photoLive: Displays live traffic cameras from your photoLive subscription (*photoLive Traffic Cameras*, page 19).

Report Camera: Allows you to report a speed or red light camera. This tool is available only when you have speed or red light camera data on your device and you have an active connection to the Smartphone Link app (*Pairing with Your Phone and Connecting to Smartphone Link*, page 13).

Viewing a Map Tool

- 1 From the map, select **📍**.
- 2 Select a map tool.
The map tool appears in a panel at the edge of the map.
- 3 When you are done using the map tool, select **✕**.

Enabling Map Tools

By default, only the most commonly used map tools are enabled in the map tools menu. You can add up to 12 tools to the menu.

- 1 From the map, select **📍** > **⚙️**.
- 2 Select the check box next to each tool to add.
- 3 Select **Save**.



Up Ahead

The Up Ahead tool provides information about upcoming locations along your route or the road on which you are traveling. You can view upcoming points of interest, such as restaurants, fuel stations, or rest areas. When traveling on a highway, you can also view information and available services for upcoming exits and cities, similar to the information on highway road signs.

You can customize three categories to show in the Up Ahead tool.

Viewing Upcoming Locations



- 1 From the map, select **📍** > **Up Ahead**.

- 2 Select an option:
 - To view the next upcoming location in each category, select , if necessary.
 - To view information and available services for upcoming highway exits or cities, select .

NOTE: This option is available only while you are traveling on a highway or when your route includes a highway.
- 3 Select an item to view a list of locations for that category, exit, or city.

Customizing the Up Ahead Categories

You can change the location categories that appear in the Up Ahead tool.

- 1 From the map, select  > **Up Ahead**.
- 2 Select a category.
- 3 Select .
- 4 Select an option:
 - To move a category up or down in the list, select and drag the arrow next to the category name.
 - To change a category, select the category.
 - To create a custom category, select a category, select **Custom Search**, and enter the name of a business or category.
- 5 Select **Done**.

Trip Information

Viewing Trip Data from the Map

Before you can view trip data on the map, you must add the tool to the map tools menu ([Enabling Map Tools, page 11](#)).

From the map, select  > **Trip Data**.

Customizing the Trip Data Fields

Before you can customize the data that appears in the trip data map tool, you must add the trip data tool to the map tools menu ([Enabling Map Tools, page 11](#)).

- 1 From the map, select  > **Trip Data**.
- 2 Select a trip data field.
- 3 Select an option.

The new trip data field appears in the trip data map tool.

Viewing the Trip Information Page

The trip information page displays your speed and provides statistics about your trip.

NOTE: If you make frequent stops, leave the device turned on, so it can accurately measure elapsed time during the trip.

From the map, select **Speed**.

Viewing the Trip Log

Your device keeps a trip log, which is a record of the path you have traveled.

- 1 Select **Settings > Map & Vehicle > Map Layers**.
- 2 Select the **Trip Log** check box.

Resetting Trip Information

- 1 From the map, select **Speed**.
- 2 Select  > **Reset Field(s)**.
- 3 Select an option:
 - When not navigating a route, select **Select All** to reset every data field except the speedometer, on the first page.
 - Select **Reset Trip Data** to reset the information on the trip computer.
 - Select **Reset Max. Speed** to reset the maximum speed.
 - Select **Reset Trip B** to reset the odometer.

Viewing Upcoming Traffic

You can view traffic incidents coming up along your route or along the road on which you are traveling.

- 1 While navigating a route, select  > **Traffic**.
The nearest upcoming traffic incident appears in a panel on the right side of the map.
- 2 Select the traffic incident to view additional details.

Viewing Traffic on the Map

The traffic map shows color-coded traffic flow and delays on nearby roads.

- 1 From the main menu, select **Apps > Traffic**.
- 2 If necessary, select  > **Legend** to view the legend for the traffic map.

Searching for Traffic Incidents

- 1 From the main menu, select **Apps > Traffic**.
- 2 Select  > **Incidents**.
- 3 Select an item in the list.
- 4 If there is more than one incident, use the arrows to view additional incidents.

Customizing the Map

Customizing the Map Layers

You can customize which data appear on the map, such as icons for points of interest and road conditions.

- 1 Select **Settings > Map & Vehicle > Map Layers**.
- 2 Select the layers to include on the map, and select **Save**.

Changing the Map Data Field

- 1 From the map, select a data field.
NOTE: You cannot customize Speed.
- 2 Select a type of data to display.

Changing the Map Perspective

- 1 Select **Settings > Map & Vehicle > Driving Map View**.
- 2 Select an option:
 - Select **Track Up** to display the map in two dimensions (2-D), with your direction of travel at the top.
 - Select **North Up** to display the map in 2-D with north at the top.
 - Select **3-D** to display the map in three dimensions.
- 3 Select **Save**.

Live Services, Traffic, and Smartphone Features

To get the most from your zūmo device, you should pair the device with your smartphone and connect to the Smartphone Link app. The Smartphone Link app allows your device to receive live data, including live traffic data, parking trends, red light and speed cameras, and other live services.

Live traffic data: Sends real-time traffic data to your device, such as traffic incidents and delays, construction zones, and road closings ([Traffic, page 16](#)).

Live parking information: Sends real-time parking trends to your device, where available ([Parking, page 9](#)).

Garmin Live Services: Provides free and paid services to send live data to your device, such as red light and speed cameras, or traffic cameras ([Garmin Live Services, page 13](#)).

Weather information: Sends real-time weather conditions and alerts to your device (*Viewing the Weather Forecast*, page 19).

LiveTrack: Allows you to share your trip with selected contacts in real time (*LiveTrack*, page 17).

Smart Notifications: Displays phone notifications and messages on your device. This feature is not available for all languages.

Hands-Free calling: Allows you to place and receive phone calls using your device, and allows you to use the device as a hands-free speaker phone.

Send locations to device: Allows you to send locations from your smartphone to your navigation device.

Foursquare check in: Allows you to check into Foursquare locations using your navigation device (*Checking in with Foursquare*, page 10).

Pairing with Your Phone and Connecting to Smartphone Link

You must pair your zūmo device with your phone and connect to Smartphone Link to use some features, such as live traffic and parking information, hands-free calling, and other connected features.

After the devices are paired, they connect automatically when they are turned on and within range.





- 1 From the app store on your phone, install the Smartphone Link app.
- 2 Place the zūmo device and your phone within 3 m (10 ft.) of each other.
- 3 On the zūmo device, select **Settings > Bluetooth**, and select the **Bluetooth** check box.
- 4 Select **Search for Devices**.
- 5 On your phone, enable Bluetooth wireless technology, and set the phone to be discoverable.
See your phone owner's manual for more information.
- 6 On the zūmo device, select **OK**.
The zūmo device begins searching for nearby Bluetooth devices, and a list of Bluetooth devices appears. It may take up to a minute for your phone to appear in the list.
- 7 Select your phone from the list, and select **OK**.
- 8 On your phone, confirm the pairing request.
- 9 On your phone, open the Smartphone Link app.
If you are pairing with an Apple® device, a security code appears on the zūmo screen.
- 10 If necessary, enter the security code on your phone within 30 seconds.

Bluetooth Feature Status Icons

Status icons appear in the Bluetooth settings next to each paired device.

Select **Settings > Bluetooth**.

- A gray icon indicates the feature is disabled or disconnected for that device.
- A colored icon indicates the feature is connected and active for that device.

| | |
|--|---------------------------------------|
|  | Hands-free calling |
|  | Smart notifications |
|  | Smartphone Link features and services |
|  | Media streaming |
|  | Headset is connected |

Garmin Live Services

Before you can use Garmin Live Services, your device must be connected to Smartphone Link (*Pairing with Your Phone and Connecting to Smartphone Link*, page 13).

Garmin Live Services provides free and subscription-based plans that send live data to your device, such as traffic conditions, weather, and red light and speed cameras.

Some services, such as weather, are available as separate apps on your device. Other services, such as traffic, enhance the existing navigation features on your device. Features that require access to Garmin Live Services display the Smartphone Link symbol and appear only when the device is connected to Smartphone Link.

Subscribing to Garmin Live Services



Some zūmo Live Services require a paid subscription. In the Smartphone Link app, you can purchase a lifetime subscription as an in-app purchase. The subscription is tied to the app store account for your smartphone.

- 1 On your smartphone, open the Smartphone Link app.
- 2 Select **My Account**.
A list of available services and subscription prices appears.
- 3 Select a service.
- 4 Select the price.
- 5 Select **Subscribe**.
- 6 Follow the on-screen instructions to complete the purchase.

Pairing Your Phone and Headset

You must pair your zūmo device with your phone and Bluetooth headset to use several Bluetooth features. After the devices are paired, they connect automatically when they are turned on and within range.

Some features require the Smartphone Link app. You can connect to the Smartphone Link app during the pairing process or later.

- 1 On your phone, enable Bluetooth wireless technology, and set the phone to be discoverable.
See your phone owner's manual for more information.
- 2 Place the zūmo device and your phone within 3 m (10 ft.) of each other.
- 3 On the zūmo device, select **Settings > Bluetooth > **.
- 4 Follow the on-screen instructions to pair your phone with your device.
- 5 On the zūmo device, select .
TIP: If the initial Bluetooth settings screen does not appear, you can select **Settings > Bluetooth > Search for Devices** to pair your headset.
- 6 Follow the on-screen instructions to pair your headset with your device.
- 7 From the app store on your phone, install and open the Smartphone Link app (optional).
If you are pairing with an Apple device, a security code appears on the zūmo screen.
- 8 If necessary, enter the security code on your phone within 30 seconds.

Sending a Location from Your Smartphone to Your Device

You can search for a location using the Smartphone Link app on your phone and send it to your zūmo device.

- 1 On your smartphone, open the Smartphone Link app.

2 Select an option:

- To find a nearby location, select **Find Nearby Places**, and enter all or part of an address or the name of a place.
- To find a nearby Foursquare point of interest, select **Foursquare**, and select a point of interest from the list.
- To choose a location on the map, select **Pick Location**, and touch the location on the map.
- To find an address from your contact list, select **Search Contacts**, and select a contact name.

The selected location appears on the map.

3 Select **Send**.

The Smartphone Link app sends the location to your zūmo.

4 On your zūmo device, select an option:

- To start navigating to the location, select **Go!**.
- To view details about the location, or to save the location to your favorites, select **i**.
- To accept the location without starting navigation, select **OK**.

The location appears in the recently found locations on your zūmo device.

Smart Notifications

While your device is connected to the Smartphone Link app, you can view notifications from your smartphone on your zūmo device, such as text messages, incoming calls, and calendar appointments.

NOTE: You may need to wait a few minutes to receive notifications on your navigation device after it connects to the Smartphone Link app.  appears colored in the Bluetooth settings when smart notifications are connected and active ([Bluetooth Feature Status Icons](#), page 13).

Receiving Notifications

WARNING

Do not read or reply to notifications while driving.

Before your zūmo device can receive notifications, you must connect it to your smartphone and to the Smartphone Link app. From most pages, a popup appears when the device receives a notification from your smartphone. If the device is moving, you must verify you are a passenger and not the driver before you can view notifications.

NOTE: If you are viewing the map, notifications appear in a map tool.

- To ignore a notification, select **OK**.
The popup closes, but the notification remains active on your phone.
- To view a notification, select **View**.
- To listen to the notification, select **View > Play**.
The device reads the notification using text-to-speech technology. This feature is not available for all languages.
- To perform additional actions, such as dismissing the notification from your phone, select **View**, and select an option.

NOTE: Additional actions are available for only some notification types and must be supported by the app generating the notification.

Receiving Notifications while Viewing the Map

WARNING

Do not read or reply to notifications while driving.

Before your zūmo device can receive notifications, you must connect it to your smartphone and to the Smartphone Link app.

When you are viewing the map, new notifications appear in a map tool at the edge of the screen. If the device is moving, you must verify you are a passenger and not the driver before you can view notifications.

- To ignore a notification, select **X**, or wait for popup to expire.
The popup closes, but the notification remains active on your phone.
- To view a notification, select the notification text.
- To listen to the notification, select **Play Message**.
The device reads the notification using text-to-speech technology. This feature is not available for all languages.
- To perform additional actions, such as dismissing the notification from your phone, select **View**, and select an option.

NOTE: Additional actions are available for only some notification types and must be supported by the app generating the notification.

Viewing the List of Notifications

You can view a list of all active notifications.

1 Select **Apps > Smart Notifications**.

The list of notifications appears. Unread notifications appear black, and previously read notifications appear gray.

2 Select an option:

- To view a notification, select the notification description.
- To listen to a notification, select **▶**.

The device reads the notification using text-to-speech technology. This feature is not available for all languages.

Hands-Free Calling

NOTE: While most phones and headsets are supported and can be used, it cannot be guaranteed that a particular phone or headset can be used. All features may not be available for your phone.

Using Bluetooth wireless technology, your device can connect to your mobile phone and wireless headset or helmet to become a hands-free device. To determine whether your device with Bluetooth technology is compatible with your device, go to www.garmin.com/bluetooth.

Placing a Call

Dialing a Number

- 1 Select **Apps > Phone > Dial**.
- 2 Enter the number.
- 3 Select **Dial**.

Calling a Contact in Your Phone Book

Your phone book is loaded from your phone to the device each time your phone and the device connect. It may take a few minutes for the phone book to be available. Some phones do not support this feature.

- 1 Select **Apps > Phone > Phone Book**.
- 2 Select a contact.
- 3 Select **Call**.

Calling a Location

- 1 Select **Apps > Phone > Browse Categories**.
- 2 Select a point of interest.
- 3 Select **Call**.

Receiving a Call

When you receive a call, select **Answer** or **Ignore**.

Using the Call History





Your call history is loaded from your phone to the device each time your phone and the device connect. It may take a few

minutes for the call history to be available. Some phones do not support this feature.

- 1 Select **Apps > Phone > Call History**.
- 2 Select a category.
A list of calls appears, with the most recent calls at the top.
- 3 Select a call.

Using In-Call Options

While on a call, you can select in-call options from the map.

- To transfer audio to your phone, select .
TIP: You can use this feature if you want to turn off your device and remain on the call, or if you need privacy.
- To use the dial pad, select .
TIP: You can use this feature to use automated systems, such as voice mail.
- To mute the microphone, select .
- To hang up, select .

Saving a Home Phone Number

TIP: After you save a home number, you can edit the home number by editing “Home” in your list of saved locations (*Editing a Saved Location, page 11*).

- 1 Select **Apps > Phone >  > Set Home Number**.
- 2 Enter your phone number.
- 3 Select **Done**.

Calling Home

Before you can call home, you must enter a phone number for your home location.

Select **Apps > Phone > Call Home**.

Setting Up Bluetooth Features for Your Apple Device

By default, all compatible Bluetooth features are enabled when you pair your phone. You can enable, disable, or customize certain features.

Connecting to the Smartphone Link App on Your Apple Device



Before you can connect to the Smartphone Link app, you must pair and connect your zūmo device with your phone.

If you did not connect to the Smartphone Link app during the pairing process, you can connect to it for additional Bluetooth features. The Smartphone Link app communicates with your phone using Bluetooth Smart technology. The first time you connect to the Smartphone Link app on an Apple device, you must enter a Bluetooth Smart security code.

- 1 From the app store on your phone, install the Smartphone Link app.
NOTE: You may need to update to the latest version of your phone's operating system.
- 2 On your phone, open the Smartphone Link app.
A security code appears on the zūmo device screen.
- 3 On your phone, enter the code.



Disabling Hands-Free Calling for Your Apple Device

You can disable hands-free calling and remain connected to your phone for Smartphone Link data and notifications.

- 1 Select **Settings > Bluetooth**.
- 2 Select the phone name used for hands-free calling.
TIP: Your phone may connect to hands-free calling and data using two different names.  and  appear colored next to the phone name used for hands-free calling.
- 3 Clear the **Phone calls** check box.



Disabling Smartphone Link Data and Smart Notifications for Your Apple Device

You can disable Smartphone Link data and smart notifications and remain connected to your phone for hands-free calling.

- 1 Select **Settings > Bluetooth**.
- 2 Select the phone name connected to Smartphone Link data and notifications.
TIP: Your phone may connect to hands-free calling and data using two different names.  and  appear blue next to the phone name used for data and notifications.
- 3 Clear the **Smartphone services** check box.

Showing or Hiding Notification Categories for Your Apple Device

You can filter the notifications shown on your device by showing or hiding categories.

- 1 Select **Settings > Bluetooth**.
- 2 Select the phone name connected to Smartphone Link data and notifications.
TIP: Your phone may connect to hands-free calling and data using two different names.  and  appear colored next to the phone name used for data and notifications.
- 3 Select **Smart Notifications**.
- 4 Select the check box next to each notification to show.

Setting Up Bluetooth Features for Your Smartphone with Android™

By default, all compatible Bluetooth features are enabled when you pair your phone. You can enable, disable, or customize certain features.

Connecting to the Smartphone Link App on Your Android Smartphone

Before you can connect to the Smartphone Link app, you must pair and connect your zūmo device with your phone.

If you did not connect to the Smartphone Link app during the pairing process, you can connect to it for additional Bluetooth features.

- 1 From the app store on your phone, install the Smartphone Link app.
- 2 On your phone, open the Smartphone Link app.

Disabling Bluetooth Features for Your Smartphone with Android

You can disable specific Bluetooth features and remain connected to other features.

- 1 Select **Settings > Bluetooth**.
- 2 Select the phone name.
- 3 Select an option:
 - To disable hands-free calling, clear the **Phone calls** check box.
 - To disable Smartphone Link data and smart notifications, clear the **Smartphone Link** check box.
 - To disable specific app notifications, use the settings in the Smartphone Link app.

Showing or Hiding Notifications for Your Smartphone with Android

You can use the Smartphone Link app to select which types of notifications appear on your zūmo device.

- 1 On your phone, open the Smartphone Link app.
- 2 Select .
- 3 Verify the **Smart Notifications** check box is selected.
- 4 From the **Notifications** section, select **Settings**.
A list of notification categories and apps appears.

5 Select an option:

- To enable or disable a notification, select the toggle switch next to the category or app name.
- To add an app to the list, select **+**.

Disconnecting a Bluetooth Device

You can temporarily disconnect a Bluetooth device without deleting it from the paired devices list. The Bluetooth device can connect to your zūmo device automatically in the future.

- 1 Select **Settings > Bluetooth**.
- 2 Select the device to disconnect.
- 3 Clear the check box next to the name of your paired device.

Deleting a Paired Phone

You can delete a paired phone to prevent it from automatically connecting to your device in the future.

- 1 Select **Settings > Bluetooth**.
- 2 Select the phone, and select **Unpair device**.

Traffic

NOTICE

Garmin is not responsible for the accuracy or timeliness of the traffic information.

Your device can provide information about traffic on the road ahead or on your route. You can set your device to avoid traffic when calculating routes, and to find a new route to your destination if a large traffic delay occurs on your active route (*Traffic Settings, page 20*). The traffic map allows you to browse the map for traffic delays in your area.

To provide traffic information, your device must be receiving traffic data.

- Your device receives free traffic data through the Smartphone Link app (*Receiving Traffic Data Using Smartphone Link, page 16*).
- All product models can receive traffic data using an over-the-air traffic receiver cable accessory (*Receiving Traffic Data Using a Traffic Receiver, page 16*). Go to your product page at garmin.com to find and purchase a compatible traffic receiver cable accessory.

Traffic data is not available in all areas. For information about traffic coverage areas, go to www.garmin.com/traffic.

Receiving Traffic Data Using Smartphone Link

Your device can receive free traffic data through the Smartphone Link app.

- 1 Connect your device to Smartphone Link (*Pairing with Your Phone and Connecting to Smartphone Link, page 13*).
- 2 On your zūmo device, select **Settings > Traffic**, and verify the **Traffic** check box is selected.

Receiving Traffic Data Using a Traffic Receiver

NOTICE

Heated (metallized) windshields could degrade the performance of the traffic receiver.

A traffic receiver receives traffic data from an over-the-air broadcast signal, where available. An over-the-air traffic receiver cable is available as an accessory for all product models. Go to your product page at garmin.com to find and purchase a

compatible traffic receiver cable accessory. Traffic data is not available in all areas.

Connect the device to vehicle power using the traffic receiver cable (*Mounting Your Device in an Automobile, page 2*).

When you are within a traffic coverage area, your device can display traffic information and help you avoid traffic delays.

Traffic Receiver Subscriptions

A regional traffic data subscription is included with most traffic receivers. You can add subscriptions for additional regions to your traffic receiver. For more information, go to garmin.com/traffic.

Viewing Traffic Subscriptions

Select **Settings > Traffic > Subscriptions**.

Adding a Subscription

You can purchase traffic subscriptions for other regions or countries.

- 1 From the main menu, select **Traffic**.
- 2 Select **Subscriptions > +**.
- 3 Write down the FM traffic receiver unit ID.
- 4 Go to www.garmin.com/fmtraffic to purchase a subscription and get a 25-character code.

The traffic subscription code cannot be reused. You must obtain a new code each time you renew your service. If you own multiple FM traffic receivers, you must obtain a new code for each receiver.

- 5 Select **Next** on the device.
- 6 Enter the code.
- 7 Select **Done**.

Enabling Traffic

You can enable or disable traffic data.

- 1 Select **Settings > Traffic**.
- 2 Select the **Traffic** check box.

Viewing Traffic on the Map

The traffic map shows color-coded traffic flow and delays on nearby roads.

- 1 From the main menu, select **Apps > Traffic**.
- 2 If necessary, select **≡ > Legend** to view the legend for the traffic map.

Searching for Traffic Incidents

- 1 From the main menu, select **Apps > Traffic**.
- 2 Select **≡ > Incidents**.
- 3 Select an item in the list.
- 4 If there is more than one incident, use the arrows to view additional incidents.

Using the Apps

Viewing the Owner's Manual on Your Device

You can view the complete owner's manual on the device screen in many languages.

- 1 Select **Apps > Owner's Manual**.
The owner's manual appears in the same language as the software text.
- 2 Select **Q** to search the owner's manual (optional).

Trip Planner

You can use the trip planner to create and save a trip, which you can navigate later. This can be useful for planning a delivery

route, a vacation, or a road trip. You can edit a saved trip to further customize it, including reordering locations, optimizing the order of stops, adding suggested attractions, and adding shaping points.



You can also use the trip planner to edit and save your active route.

Planning a Trip

A trip can include many destinations, and it must include at least a starting location and one destination. The starting location is the location from which you plan to start your trip. If you start navigating the trip from a different location, the device gives you the option to route to your starting location first. For a round trip, the starting location and final destination can be the same.

- 1 Select **Apps > Trip Planner > New Trip**.
- 2 Select **Select Start Location**.
- 3 Choose a location for your starting point, and select **Select**.
- 4 Select **Select Destination**.
- 5 Choose a location for a destination, and select **Select**.
- 6 Select **Add Location** to add more locations (optional).
- 7 After you have added all the necessary locations, select **Next > Save**.
- 8 Enter a name, and select **Done**.

Editing and Reordering Locations in a Trip

- 1 Select **Apps > Trip Planner > Saved Trips**.
- 2 Select a saved trip.
- 3 Select a location.
- 4 Select an option:
 - To move the location up or down, select , and drag the location to a new position in the trip.
 - To add a new location after the selected location, select .
 - To remove the location, select .

Optimizing the Order of Destinations in a Trip

The device can automatically optimize the order of destinations in your trip to create a shorter, more efficient route. The starting location and final destination are not changed when you optimize the order.

While editing a trip, select  > **Optimize Order**.

Discovering Attractions Along Your Trip

The device can suggest interesting or popular attractions to add to your trip.

- 1 While editing a trip, select  > **Suggest Attractions**.
- 2 Select an attraction to view more information.
- 3 Select **Select** to add the attraction to your trip.

Changing Routing Options for a Trip

You can customize how the device calculates the route when you start your trip.

- 1 Select **Apps > Trip Planner > Saved Trips**.
- 2 Select a saved trip.
- 3 Select the vehicle profile icon, and select the vehicle you plan to use while navigating the trip (optional).
- 4 Select .
- 5 Select an option:
 - To add shaping points to your trip, select **Shape Route**, and follow the on-screen instructions.
 - To change the calculation mode for the trip, select **Route Preference** (*Changing the Route Calculation Mode*, page 5).

Navigating to a Saved Trip

- 1 Select **Apps > Trip Planner > Saved Trips**.
- 2 Select a saved trip.
- 3 Select **Go!**.
- 4 Select the first location to navigate to, and select **Start**.

The device calculates a route from your current location to the selected location, and then it guides you to the remaining trip destinations in order.

Editing and Saving Your Active Route

If a route is active, you can use the trip planner to edit and save your route as a trip.

- 1 Select **Apps > Trip Planner > My Active Route**.
- 2 Edit your route using any of the trip planner features.

The route recalculates each time you make a change.
- 3 Select **Save** to save your route as a trip, which you can navigate again later (optional).

Sharing a Route

You can share routes with other zūmo devices.

- 1 Select **Apps > Share Route**.
- 2 Select an option:
 - To share a route using Smartphone Link, select **Smartphone Link**.
 - To share a route using a Bluetooth connection, select **Bluetooth**.
 - To copy the route to a microSD card, select **Memory Card**.
- 3 Select a route.
- 4 Select **Done**.
- 5 Follow the on-screen instructions on your zūmo device to complete the sharing process.

LiveTrack

NOTICE

Use caution when sharing your location information with others.

The LiveTrack feature lets you share your trip with contacts from your smartphone and your social networking accounts, such as Facebook and Twitter. While you are sharing, viewers can track your current location, recently visited locations, and the path of your recent travels in real time.

This feature requires a smartphone running the Smartphone Link app.

Setting Up LiveTrack Sharing and Inviting Viewers

The first time you use the LiveTrack feature, you must set up the feature and invite viewers.

- 1 Connect to **Smartphone Link** (*Pairing Your Phone and Headset*, page 13).
- 2 On your smartphone, open the Smartphone Link app, and select **LiveTrack**.
- 3 Enter a user name, and select **Next**.
- 4 Enter one or more contacts to invite.

You can enter either the contact name or email address.
- 5 Select **Start LiveTrack**.

The app starts sharing your LiveTrack data. Invited viewers receive an email with a link to view your LiveTrack data.
- 6 Select  to share the LiveTrack link using a social network, messaging app, or other sharing app (optional).

Starting LiveTrack Sharing

NOTICE

Use caution when sharing your location information with others.

Before you can start sharing, you must set up the LiveTrack feature ([Setting Up LiveTrack Sharing and Inviting Viewers](#), page 17).

You can start sharing your LiveTrack data using your zūmo device or the Smartphone Link app.

- On your zūmo device, select **Apps > LiveTrack > Start LiveTrack**.
- On your smartphone, open the Smartphone Link app, and select **LiveTrack > Start LiveTrack**.

A link to view your LiveTrack data is posted to your enabled social network accounts, and an email with the link is sent to your invited contacts. While you are sharing, viewers can click the link to track your current location, recently visited locations, and the path of your recent travels in real time.

 appears in the zūmo status bar while LiveTrack sharing is active. The number of invited viewers also appears.

TIP: By default, the LiveTrack sharing session ends automatically after 24 hours. In the Smartphone Link app, you can select **LiveTrack > Extend LiveTrack** to extend the duration of the LiveTrack sharing session, or you can stop sharing at any time.

Stopping LiveTrack Sharing

You can stop LiveTrack sharing at any time using your zūmo device or the Smartphone Link app.

- On your zūmo device, select **Apps > LiveTrack > Stop LiveTrack**.
- On your smartphone, open the Smartphone Link app, and select **LiveTrack > Stop LiveTrack**.

Viewers receive a message that the LiveTrack session has ended, and they can no longer track your location.

Tracks

A track is a recording of your path. The track log contains information about the recorded path, including time, location, and elevation information.

Viewing and Saving Track Information

- 1 Select **Apps > Tracks > Active**.
- 2 Select an option:
 - To view all track segments, select **All Segments**.
 - To view a specific track segment, select a segment.The track is displayed on the map.
- 3 Select .
- 4 Select an option:
 - To save the track, select **Save Track**.
 - To save the track as a trip, select **Save as Trip**.
 - To view an elevation plot of the track, select **Elevation Profile**.

Media Player

The media player can play music or audio from these sources.

- Music files stored on your zūmo device.
- Bluetooth audio from a paired phone.
- Pandora® internet radio.

Adding the Media Player Tool to the Map

The media player map tool enables you to control the media player from your map.

- 1 Select **Settings > Map & Vehicle > Map Tools > Media Player**.
- 2 Open the map.
- 3 Select  > **Media Player**.
The media player controls appear on the map.

Changing the Media Source

You can change the source from which media is played on your device.

- 1 Select **Apps > Media Player > ⋮**.
- 2 Select a media source.

Pandora Service

Pandora is free personalized radio that offers effortless and endless music enjoyment and discovery. Pandora integration requires a compatible mobile device with the Pandora application installed. For more information on compatible mobile devices visit www.pandora.com/everywhere/mobile.

NOTE: Pandora is currently available in the United States, Australia, and New Zealand.

Downloading the Pandora Application





Before you can use the Pandora service on your device, you must download and install the Pandora app to your smartphone.

- 1 On your compatible smartphone, open the application store and search for Pandora.
- 2 Install the Pandora app.

See the owner's manual for your smartphone or mobile media device for more information.

Using Pandora

Before you can use the Pandora service, you must pair your compatible smartphone with your device ([Pairing Your Phone and Headset](#), page 13).

- 1 On your device, select **Apps > Pandora®**.
- 2 Connect your compatible smartphone to your device.
- 3 Launch the Pandora application on your smartphone.
- 4 On your zūmo device, select an option:
 - To play a song, select .
 - To pause a song, select .
 - To skip a song, select .
 - If you like a song, select  to hear more songs like it.
 - If you dislike a song, select  to prevent it from being played in the future.

Changing Stations

- 1 Select **Apps > Pandora®**.
- 2 Select .
- 3 Select a station.

Using the Compass

NOTE: You must be moving for the compass to determine your direction.

You can navigate using a GPS compass.

Select **Apps > Compass**.

TracBack®

Following Your Recent Track

The TracBack feature records the most recent segment of your movement. You can retrace your recent track back to a previous location.

- 1 Select **Apps > TracBack**.
Your recent track appears on the map.
- 2 Select **Go!**.

Saving Your Recent Track as a Trip

You can save your recent track as a trip, which you can navigate later using the trip planner ([Navigating to a Saved Trip](#), page 17).

- 1 Select **TracBack**.
Your recent track appears on the map.
- 2 Select  > **Save as Trip**.
- 3 Enter a name, and select **Done**.

Viewing the Weather Forecast

Before you can use this feature, your device must be receiving weather data. You can connect your device to the Smartphone Link app to receive weather data ([Pairing with Your Phone and Connecting to Smartphone Link](#), page 13).

- 1 Select **Apps > Weather**.
The device shows the current weather conditions and a forecast for the next several days.
- 2 Select a day.
The detailed forecast for that day appears.

Viewing Weather Near a Different City

- 1 Select **Apps > Weather > Current Location**.
- 2 Select an option:
 - To view weather for a favorite city, select a city in the list.
 - To add a favorite city, select **Add City**, and enter a city name.

Viewing the Weather Radar

Before you can use this feature, you must purchase Advanced Weather service using Smartphone Link.

You can view an animated, color-coded radar map of current weather conditions, as well as a weather icon on the map. The weather icon changes to show weather in the vicinity, such as rain, snow, and thunderstorms.

- 1 Select **Apps > Weather**.
- 2 If necessary, select a city.
- 3 Select  > **Weather Radar**.

Viewing Weather Alerts

Before you can use this feature, you must purchase the Advanced Weather service using Smartphone Link.

NOTE: This feature is not available in all areas.

While you are traveling with your device, weather alerts may appear on the map. You can also view a map of weather alerts near your current location or near a selected city.

- 1 Select **Apps > Weather**.
- 2 If necessary, select a city.
- 3 Select  > **Weather Alerts**.

Checking Road Conditions

Before you can use this feature, you must purchase Advanced Weather service using Smartphone Link.

- 1 Select **Apps > Weather**.
- 2 If necessary, select a city.
- 3 Select  > **Road Conditions**.

Creating a Round-Trip Route

The device can create a round-trip route using a specified starting location and a distance, duration, or destination.

- 1 From the home screen, select **Apps > Round Trip**.
- 2 Select **Start Location**.
- 3 Select a location, and select **Select**.
- 4 Select **Trip Attributes**.

- 5 Select an option:
 - Select **Choose a Distance** to plan your route by distance.
 - Select **Choose a Duration** to plan your route based on time.
 - Select **Choose a Destination** to plan your route based on a specified location.
- 6 Enter a distance, duration, or destination.
- 7 Select an option:
 - If you entered a distance or duration, select **Done > Calculate**.
 - If you selected a destination, select **Select**.
- 8 Select a route, and select **Go!**.

photoLive Traffic Cameras

Before you can use this feature, you must be connected to Smartphone Link, and you must have a subscription to the photoLive service ([Subscribing to Garmin Live Services](#), page 13).

photoLive traffic cameras provide live images of traffic conditions on major roadways and intersections.

The photoLive service is not available in all areas.

Viewing and Saving photoLive Traffic Cameras

You can view live images from nearby traffic cameras. You can also save traffic cameras for areas you travel frequently.

- 1 Select **Apps > photoLive**.
- 2 Select **Touch to Add**.
- 3 Select a road.
- 4 Select a traffic camera location.
A preview of the live image from the camera appears next to a map of the camera's location. You can select the image preview to view the full-sized image.
- 5 Select **Save** to save the camera (optional).
A thumbnail image preview of the camera is added to the main screen of the photoLive app.

Viewing photoLive Traffic Cameras on the Map

The photoLive map tool shows traffic cameras from the road ahead of you.

- 1 From the map, select  > **photoLive**.
The device shows the live image from the nearest traffic camera on the road ahead, along with the distance to the camera. When you pass the camera, the device loads the live image of the next camera on the road.
- 2 If no cameras are found for the road, select **Find Cameras** to view or save nearby traffic cameras (optional).

Saving a Traffic Camera

- 1 Select **Apps > photoLive**.
- 2 Select **Touch to Add**.
- 3 Select a road.
- 4 Select an intersection.
- 5 Select **Save**.

Viewing Previous Routes and Destinations

Before you can use this feature, you must enable the travel history feature ([Device and Privacy Settings](#), page 21).

You can view your previous routes and places you have stopped on the map.

Select **Apps > Where I've Been**.

zūmo Settings

Map and Vehicle Settings

Select **Settings > Map & Vehicle**.

Vehicle: Sets the vehicle icon that represents your position on the map.

Driving Map View: Sets the perspective on the map.

Map Detail: Sets the level of detail on the map. More detail may cause the map to draw slower.

Map Theme: Changes the color of the map data.

Map Tools: Sets the shortcuts that appear in the map tools menu.

Map Layers: Sets the data that appears on the map page (*Customizing the Map Layers, page 12*).

Auto Zoom: Automatically selects the zoom level for optimal use of your map. When disabled, you must zoom in or out manually.

Skip Next Stop Confirmation: Sets a confirmation message to appear when skipping a location on your route.

myMaps: Sets which installed maps the device uses.

Enabling Maps

You can enable map products installed on your device.

TIP: To purchase additional map products, go to <http://buy.garmin.com>.

- 1 Select **Settings > Map & Vehicle > myMaps**.
- 2 Select a map.

Navigation Settings

Select **Settings > Navigation**.

Route Preview: Shows a preview of the major roads in your route when you start navigation.

Calculation Mode: Sets the route calculation method.

Garmin Adventurous Routing™: Sets route preferences for navigating curvy roads, hills, and highways.

Off-Route Recalculation: Sets recalculation preferences when navigating away from an active route.

Avoidances: Sets road features to avoid on a route.

Custom Avoidances: Allows you to avoid specific roads or areas.

Toll Roads: Sets preferences for avoiding toll roads.

Tolls and Fees: Sets preferences for avoiding toll roads and toll stickers.

NOTE: This feature is not available in all areas.

Restricted Mode: Disables all functions that require significant operator attention.

GPS Simulator: Stops the device from receiving a GPS signal, and saves battery power.

Calculation Mode Settings

Select **Settings > Navigation > Calculation Mode**.

The route calculation is based on road speeds and vehicle acceleration data for a given route.

Faster Time: Calculates routes that are faster to drive but can be longer in distance.

Shorter Distance: Calculates routes that are shorter in distance but can take more time to drive.

Off Road: Calculates a direct line from your location to your destination.

Garmin Adventurous Routing™: Calculates routes that prefer curvy roads.

NOTE: This feature is not available in all areas.

Setting a Simulated Location

If you are indoors or not receiving satellite signals, you can use the GPS simulator to plan routes from a simulated location.

- 1 Select **Settings > Navigation > GPS Simulator**.
- 2 From the main menu, select **View Map**.
- 3 Tap the map twice to select an area.
The address of the location appears at the bottom of the screen.
- 4 Select the location description.
- 5 Select **Set Location**.

Bluetooth Settings

Select **Settings > Bluetooth**.

Bluetooth: Enables Bluetooth wireless technology.

Search for Devices: Searches for nearby Bluetooth devices.

Friendly Name: Allows you to enter a friendly name that identifies your device on other devices with Bluetooth wireless technology.

Wi-Fi® Settings

The wireless network settings allow you to manage Wi-Fi networks.

Select **Settings > Wi-Fi**.

Wi-Fi: Enables the Wi-Fi radio.

Saved Networks: Allows you to edit or remove saved networks.

Search for Networks: Searches for nearby Wi-Fi networks (*Connecting to a Wi-Fi Network, page 21*).

Driver Assistance Settings

Select **Settings > Driver Assistance**.

Audible Rider Alerts: Enables an audible alert for each type of driver alert (*Rider Awareness Features and Alerts, page 3*).

Speeding Alert: Alerts you when you are exceeding the speed limit.

Fatigue Warning: Alerts you when you have been driving for a long period without a break.

Automatic Incident Detection: Enables the device to detect a possible vehicle incident.

Incident Notification: Allows you to set up a contact to be notified when the device detects a possible vehicle incident.

Proximity Alerts: Alerts you when you approach speed cameras or red light cameras.

Display Settings

Select **Settings > Display**.

Color Mode: Allows you to select day or night color mode. If you select the Auto option, the device automatically switches to day or night colors based on the time of day.

Brightness: Allows you to adjust the display brightness.

Display Timeout: Allows you to set the amount of idle time before your device enters sleep mode while using battery power.

Screenshot: Allows you to take a picture of the device screen. Screenshots are saved in the Screenshot folder of the device storage.

Traffic Settings

From the main menu, select **Settings > Traffic**.

Traffic: Enables traffic.

Current Provider: Sets the traffic provider to use for traffic data. The Auto option selects the best available traffic data automatically.

Subscriptions: Lists the current traffic subscriptions.

Optimize Route: Enables the device to use optimized alternate routes automatically or upon request (*Avoiding Traffic Delays on Your Route*, page 7).

Traffic Alerts: Sets the traffic delay severity for which the device displays a traffic alert.

Units and Time Settings

To open the Units and Time settings page, from the main menu, select **Settings > Units & Time**.

Current Time: Sets the device time.

Time Format: Allows you to select a 12-hour, 24-hour, or UTC display time.

Units: Sets the unit of measure used for distances.

Position Format: Sets the coordinate format and datum used for geographical coordinates.

Setting the Time

- 1 From the main menu, select the time.
- 2 Select an option:
 - To set the time automatically using GPS information, select **Automatic**.
 - To set the time manually, drag the numbers up or down.

Language and Keyboard Settings

To open the Language and Keyboard settings, from the main menu, select **Settings > Language & Keyboard**.

Voice Language: Sets the language for voice prompts.

Text Language: Sets all on-screen text to the selected language.

NOTE: Changing the text language does not change the language of user-entered data or map data, such as street names.

Keyboard Language: Enables keyboard languages.

Device and Privacy Settings

Select **Settings > Device**.

About: Displays the software version number, the unit ID number, and information on several other software features.

Regulatory: Displays regulatory markings and information.

EULAs: Displays the end-user license agreements.

NOTE: You need this information when you update the system software or purchase additional map data.

Device Data Reporting: Shares anonymous data to improve the device.

Travel History: Allows the device to record information for the myTrends, Where I've Been, and Trip Log features.

Clear Travel History: Clears your travel history for the myTrends, Where I've Been, and Trip Log features.

Restoring Settings

You can restore a category of settings or all settings to the factory default values.

- 1 Select **Settings**.
- 2 If necessary, select a settings category.
- 3 Select  > **Restore**.

Device Information

Viewing Regulatory and Compliance Information

- 1 From the settings menu, swipe to the bottom of the menu.

- 2 Select **Device > Regulatory**.

Specifications

| | |
|--|---|
| Water resistance | IEC 60529 IPX7* |
| Operating temperature range | From -20° to 55°C (from -4° to 131°F) |
| Charging temperature range | From 0° to 45°C (from 32° to 113°F) |
| Power input (vehicle power cable, motorcycle, or external power) | From 12 to 24 Vdc |
| Battery type | Lithium-ion battery |
| Battery voltage range | From 3.5 to 4.1 V |
| Wireless frequencies/protocols | Wi-Fi: 2.4 GHz @ 15 dBm nominal Bluetooth: 2.4 GHz @ 9 dBm nominal |

*The device withstands incidental exposure to water of up to 1 m for up to 30 min. For more information, go to www.garmin.com/waterrating.

Charging the Device

NOTE: This Class III product shall be powered by an LPS power supply.

You can charge the battery in the device using any of these methods.

- Connect the device to vehicle power.
- Connect the device to an optional power adapter accessory, such as a wall power adapter.

You can purchase an approved Garmin AC-DC adapter suitable for home or office use from a Garmin dealer or www.garmin.com. The device may charge slowly when connected to a third-party adapter.

Device Maintenance

Garmin Support Center

Go to support.garmin.com for help and information, such as product manuals, frequently asked questions, videos, and customer support.

Map and Software Updates

For the best navigation experience, you should keep the maps and software on your device up to date. Map updates ensure your device has the latest available map data. Software updates provide improvements to features and performance.

You can update your device using two methods.

- You can connect the device to a Wi-Fi network to update directly on the device (recommended). This option allows you to update your device conveniently without connecting it to a computer.
- You can connect the device to a computer and update it using the Garmin Express application. This option allows you to install map data onto a memory card if the updated maps are too large to fit on the internal storage.

Connecting to a Wi-Fi Network

The first time you turn on the device, it prompts you to connect to a Wi-Fi network and register your device. You can also connect to a Wi-Fi network using the settings menu.

- 1 Select **Settings > Wi-Fi**.
- 2 If necessary, select **Wi-Fi** to enable Wi-Fi technology.
- 3 Select **Search for Networks**.
The device displays a list of nearby Wi-Fi networks.
- 4 Select a network.
- 5 If necessary, enter the password for the network, and select **Done**.

The device connects to the network, and the network is added to the list of saved networks. The device reconnects to this network automatically when it is within range.

Updating Maps and Software Using a Wi-Fi Network

NOTICE

Map and software updates may require the device to download large files. Regular data limits or charges from your Internet service provider apply. Contact your Internet service provider for more information about data limits or charges.

You can update the maps and software by connecting your device to a Wi-Fi network that provides access to the Internet. This allows you to keep your device up to date without connecting it to a computer.

1 Connect the device to a Wi-Fi network ([Connecting to a Wi-Fi Network, page 21](#)).

While connected to a Wi-Fi network, the device checks for available updates. When an update is available,  appears on the Settings icon in the main menu.

2 Select **Settings > Updates**.

The device checks for available updates. When an update is available, **Update Available** appears below Map or Software.

3 Select an option:

- To install all available updates, select **Install All**.
- To install only map updates, select **Map > Install All**.
- To install only software updates, select **Software > Install All**.

4 Read the license agreements, and select **Accept All** to accept the agreements.

NOTE: If you do not agree with the license terms, you can select **Reject**. This stops the update process. You cannot install updates until you accept the license agreements.

5 Using the included USB cable, connect the device to external power, and select **Continue** ([Charging the Device, page 21](#)).

For the best results, a USB wall charger that provides at least 1 A power output is recommended. Many USB power adapters for smartphones, tablets, or portable media devices may be compatible.

6 Keep the device connected to external power and within range of the Wi-Fi network until the update process is complete.

TIP: If a map update is interrupted or canceled before it completes, your device may be missing map data. To repair missing map data, you must update the maps again using either Wi-Fi or Garmin Express.

Product Updates

On your computer, install Garmin Express (www.garmin.com/express).

This provides easy access to these services for Garmin devices:

- Software updates
- Map updates
- Product registration

Updating Maps and Software with Garmin Express

You can use Garmin Express software to download and install the latest map and software updates for your device. Garmin Express is available for Windows® and Mac® computers.

1 On your computer, go to www.garmin.com/express.



2 Select an option:

- To install on a Windows computer, select **Download for Windows**.
- To install on a Mac computer, select **Download for Mac**.

3 Open the downloaded file, and follow the on-screen instructions to complete the installation.

4 Start Garmin Express.

5 Connect your zūmo device to your computer using a USB cable.



6 When your zūmo device prompts you to enter file transfer mode, select **Yes**.

7 On your computer, click **Add a Device**.

The Garmin Express software detects your device.

8 Click **Add Device**.

9 Follow the on-screen instructions to register your device and add it to the Garmin Express software.

When setup is complete, the Garmin Express software searches for map and software updates for your device.

10 Select an option:

- To install all available updates, click **Install All**.
- To install a single update, click **View Details** and select an update.

NOTE: If a map update is too large for the internal storage of the device, the software may prompt you to install a microSD card in your device to add storage space ([Installing a Memory Card for Maps and Data, page 24](#)).

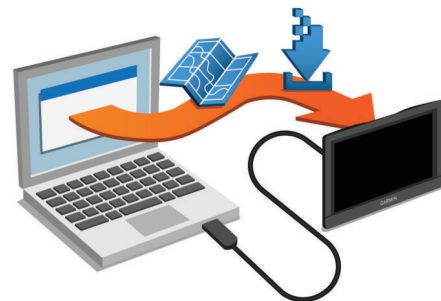

The Garmin Express software downloads and installs the updates onto your device. Map updates are very large, and this process may take a long time on slower Internet connections.

Device Care

NOTICE

Avoid dropping your device.

Do not store the device where prolonged exposure to extreme temperatures can occur, because it can cause permanent damage.

Never use a hard or sharp object to operate the touchscreen, or damage may result.

Cleaning the Outer Casing

NOTICE

Avoid chemical cleaners and solvents that can damage plastic components.

- 1 Clean the outer casing of the device (not the touchscreen) using a cloth dampened with a mild detergent solution.
- 2 Wipe the device dry.

Cleaning the Touchscreen

- 1 Use a soft, clean, lint-free cloth.
- 2 If necessary, lightly dampen the cloth with water.
- 3 If using a dampened cloth, turn off the device and disconnect the device from power.
- 4 Gently wipe the screen with the cloth.

Avoiding Theft

- Remove the device and mount from sight when not in use.
- Remove the residue left on the windshield by the suction cup.
- Do not keep your unit in the glove compartment.
- Register your device using the Garmin Express software (garmin.com/express).

Resetting the Device

You can reset your device if it stops functioning.

Hold the power key for 12 seconds.

Removing the Device, Mount, and Suction Cup

Removing the Device from the Mount

- 1 Press the release tab or button on the mount.
- 2 Tilt the bottom of the device upward, and lift the device from the mount.

Removing the Mount from the Suction Cup

- 1 Turn the device mount to the right or left.
- 2 Apply pressure until the socket on the mount releases the ball on the suction cup.

Removing the Suction Cup from the Windshield

- 1 Flip the lever on the suction cup toward you.
- 2 Pull the tab on the suction cup toward you.

Changing the Fuse in the Vehicle Power Cable

NOTICE

When replacing the fuse, do not lose any of the small pieces and make sure they are put back in the proper position. The vehicle power cable does not work unless it is assembled correctly.

If your device does not charge in your vehicle, you may need to replace the fuse located at the tip of the vehicle adapter.

- 1 Rotate the end piece ① counter clockwise to unlock it.

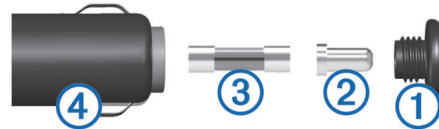

TIP: You may need to use a coin to remove the end piece.

- 2 Remove the end piece, the silver tip ②, and the fuse ③.
- 3 Insert a new fast-blow fuse that has the same current, such as 1 A or 2 A.
- 4 Place the silver tip in the end piece.
- 5 Push in the end piece and rotate it clockwise to lock it back into the vehicle power cable ④.

Troubleshooting

The suction cup will not stay on my windshield

- 1 Clean the suction cup and windshield with rubbing alcohol.
- 2 Dry with a clean, dry cloth.
- 3 Mount the suction cup (*Mounting Your Device in an Automobile*, page 2).

My device is not acquiring satellite signals

- Verify the GPS simulator is turned off (*Navigation Settings*, page 20).
- Take your device out of parking garages and away from tall buildings and trees.
- Remain stationary for several minutes.

The device does not charge in my vehicle

- Check the fuse in the vehicle power cable (*Changing the Fuse in the Vehicle Power Cable*, page 23).
- Verify the vehicle is turned on and is supplying power to the power outlet.
- Verify the interior temperature of the vehicle is within the charging temperature range indicated in the specifications.
- Verify the fuse is not broken in the vehicle power outlet.

My battery does not stay charged for very long

- Decrease the screen brightness (*Display Settings*, page 20).
- Shorten the display timeout (*Display Settings*, page 20).
- Decrease the volume (*Adjusting the Volume*, page 3).
- Turn off the wi-fi radio when it is not in use (*Wi-Fi Settings*, page 20).
- Put the device in power saving mode when not in use (*Turning the Device On or Off*, page 3).
- Keep your device away from extreme temperatures.
- Do not leave your device in direct sunlight.

My device does not connect to my phone or Smartphone Link

- Select **Settings > Bluetooth**.
The Bluetooth option must be enabled.
- Enable Bluetooth wireless technology on your phone and bring your phone within 10 m (33 ft.) of the device.
- On your smartphone, open the Smartphone Link app, and select **■ > ►** to restart the Smartphone Link background services.
- Verify your phone is compatible.

Go to www.garmin.com/bluetooth for more information.

- Complete the pairing process again.

To repeat the pairing process, you must unpair your phone and device (*Disconnecting a Bluetooth Device*, page 16), and complete the pairing process (*Pairing with Your Phone and Connecting to Smartphone Link*, page 13).

My device does not appear as a removable drive on my computer

On most computers, the device connects using Media Transfer Protocol (MTP). In MTP mode, the device appears as a portable device and not as a removable drive.

My device does not appear as a portable device on my computer

On Mac computers and some Windows computers, the device connects using USB mass storage mode. In USB mass storage mode, the device appears as a removable drive or volume, and not as a portable device. Windows versions prior to Windows XP Service Pack 3 use USB mass storage mode.

My device does not appear as either a portable device or a removable drive or volume on my computer

- 1 Disconnect the USB cable from your computer.
- 2 Turn off the device.
- 3 Connect the USB cable to your device and to a USB port on your computer.

TIP: The USB cable must connect to a USB port on your computer, not to a USB hub.



The device turns on automatically and goes into MTP mode or USB mass storage mode. A picture of the device connected to a computer appears on the device screen.

NOTE: If you have several network drives mapped on your computer, Windows may have trouble assigning drive letters to your Garmin drives. For information about assigning drive letters, see the help file for your operating system.

The Smartphone Link app affects the battery charge level on my smartphone

The Smartphone Link app uses Bluetooth wireless technology to send data to and receive data from your device. It is normal for an active Bluetooth connection to consume some battery power. The app also periodically checks for updates to available services, which may consume additional battery power.

You can change the battery usage settings in the Smartphone Link app to reduce the amount of battery power the app uses.

- 1 From the Smartphone Link app on your smartphone, select .
- 2 Scroll to the **Battery Usage** section, and select **Settings**.
- 3 Select one or more options:
 - Clear the **Bluetooth Auto-Connect** check box.
Disabling this option may save a small amount of battery power, but it prevents the app from connecting to your zūmo device automatically. While this option is disabled, you must select  from the Smartphone Link main menu each time you want to connect your device to Smartphone Link.
 - Clear the **Live Services Check** check box.
On some smartphones, disabling this option may significantly reduce the battery power used by the app. While this option is disabled, you must manually refresh the Smartphone Link main menu to receive updated information about available live services.

Appendix

Installing a Memory Card for Maps and Data

You can install a memory card to increase the storage space for maps and other data on your device. You can purchase memory cards from an electronics supplier, or go to www.garmin.com/maps to purchase a memory card with pre-loaded Garmin mapping software. The device supports microSD memory cards from 4 to 64 GB.

- 1 Locate the map and data memory card slot on your device (*Device Overview*, page 3).
- 2 Pull up the weather cap from the microSD card slot.
- 3 Slide the microSD card slot cover toward the center of the device.

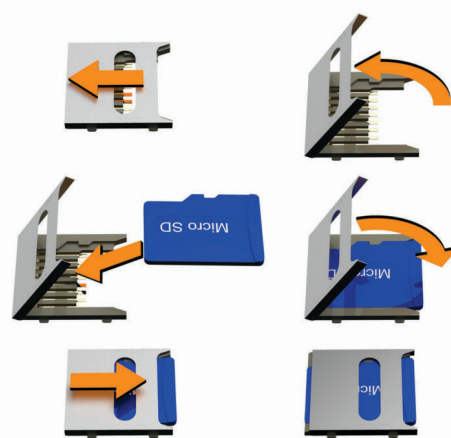

- 4 Pull the microSD card slot cover up.
- 5 Insert a microSD card into the slot.
NOTE: Confirm the microSD card fits flush against the card slot contacts.
- 6 Close the SD card cover.
- 7 Slide the SD card cover toward the outside edge of the device until it clicks.

Data Management

You can store files on your device. The device has a memory card slot for additional data storage.

NOTE: The device is not compatible with Windows 95, 98, Me, Windows NT®, and Mac OS 10.3 and earlier.

About Memory Cards

You can purchase memory cards from an electronics supplier, or purchase pre-loaded Garmin mapping software (www.garmin.com). In addition to map and data storage, the memory card can be used to store files such as maps, images, geocaches, routes, waypoints, and custom POIs.

Connecting the Device to Your Computer

You can connect the device to your computer using a USB cable.

- 1 Plug the small end of the USB cable into the port on the device.
- 2 Plug the larger end of the USB cable into a port on your computer.
- 3 When your zūmo device prompts you to enter file transfer mode, select **Yes**.

A picture of your device connected to a computer appears on the device screen.

Depending on your computer operating system, the device appears as either a portable device, a removable drive, or a removable volume.

Transferring Data From Your Computer

- 1 Connect the device to your computer ([Connecting the Device to Your Computer](#), page 24).

Depending on your computer operating system, the device appears as either a portable device, a removable drive, or a removable volume.

- 2 On your computer, open the file browser.

- 3 Select a file.

- 4 Select **Edit > Copy**.

- 5 Browse to a folder on the device.

NOTE: For a removable drive or volume, you should not place files in the Garmin folder.

- 6 Select **Edit > Paste**.

Disconnecting the USB Cable

If your device is connected to your computer as a removable drive or volume, you must safely disconnect your device from your computer to avoid data loss. If your device is connected to your Windows computer as a portable device, it is not necessary to safely disconnect.

- 1 Complete an action:

- For Windows computers, select the **Safely Remove Hardware** icon in the system tray, and select your device.
- For Mac computers, drag the volume icon to the trash.

- 2 Disconnect the cable from your computer.

Viewing GPS Signal Status

Hold  for three seconds.

Purchasing Additional Maps

- 1 Go to your device product page at [garmin.com](#).
- 2 Click the **Maps** tab.
- 3 Follow the on-screen instructions.

Purchasing Accessories

Go to [garmin.com/accessories](#).

Index

Symbols

- 2-D map view **12**
- 3-D map view **12**

A

- accessories **25**
- active lane guidance **5**
- addresses, finding **9**
- alerts
 - audio **20**
 - proximity points **20**
- answering calls **14**
- audio, proximity points **20**
- avoidances
 - area **7**
 - deleting **7**
 - disabling **7**
 - road **7**
 - road features **7**
 - tolls **7**

B

- battery
 - charging **21, 23**
 - maximizing **23**
 - problems **23**
- Bluetooth **20**
- Bluetooth technology **12–14, 23**
 - disconnecting a device **16**
 - pairing a headset **13**
 - pairing a phone **13**
- Bluetooth Technology
 - disabling calls **15**
 - managing phones **15**
- brightness **3**

C

- cables, motorcycle mount **1**
- calls **14, 15**
 - answering **14**
 - contacts **14**
 - dialing **14**
 - history **14**
 - home **15**
 - placing **14**
- cameras
 - red light **4**
 - speed **4**
- changing the search area **9**
- charging the device **21, 23**
- cleaning the device **23**
- cleaning the touchscreen **23**
- compass **18**
- computer, connecting **24**
- connecting **21**
- coordinates **10**
- current location **10**

D

- deleting
 - paired Bluetooth device **16**
 - trips **17**
- destinations **19**. *See* locations
 - arriving **6**
- detours **6**
- device care **23**
- dialing **14**
- directions **6**
- disconnecting, Bluetooth device **16**
- display settings **20**
- driving directions **6**

E

- editing, saved trips **17**
- emergency services **10**
- EULAs **21**

F

- files, transferring **25**
- finding locations. **8–10, 13** *See also* locations
 - addresses **9**
 - categories **8**
 - cities **10**
 - coordinates **10**
 - intersections **9**
- Foursquare **10**
- fuel
 - stations **10**
 - tracking **7, 8**
- fuse, changing **23**

G

- Garmin Connect **12**
- Garmin Express, updating software **22**
- Garmin Live Services **13**
 - subscribing to **13**
- geocaching **10**
- going home **5**
- GPS **3, 25**

H

- hands-free phone calls **13, 15**
- headset, pairing **13**
- helmet laws **5**
- home
 - calling **15**
 - editing location **5**
 - going **5**
 - phone number **15**

I

- icons, status bar **3**
- ID number **21**
- incident contact **4**
- incident notification **4**
- intersections, finding **9**

K

- keyboard
 - language **21**
 - layout **21**

L

- language
 - keyboard **21**
 - voice **21**
- latitude and longitude **10**
- LiveTrack **17, 18**
- location **9**
- locations **9, 19**
 - calling **14**
 - current **10, 11**
 - recently found **10**
 - saving **11**
 - searching for **8, 9**
 - simulated **20**
 - venues **8**
- low-fuel warning **8**

M

- map layers, customizing **12**
- map view
 - 2-D **12**
 - 3-D **12**
- maps **5, 11, 12, 20**
 - data field **5, 12**
 - detail level **20**
 - layers **12**
 - purchasing **25**
 - symbols **5**
 - theme **20**
 - tools **11**
 - updating **21, 22**
 - viewing routes **5, 6**
- media player **18**
- memory card **3, 24**
 - installing **24**
- microSD card **3, 24**

- motorcycle mount **1**
 - cables **1**
- mount, removing **23**
- mounting the device
 - automobile **2**
 - motorcycle **1**
 - removing from mount **2, 23**
 - suction cup **23**
- myTrends, routes **7**

N

- navigation **5, 6, 8**
 - off-road **7**
 - settings **20**
- next turn **5**
- notifications **4, 13–15**

O

- off-road navigation **7**
- on-screen buttons **3**
- owner's manual **16**

P

- pairing
 - disconnecting **16**
 - headset **13**
 - phone **13, 23**
- parking **6, 9**
 - last spot **6**
- phone
 - disconnecting **16**
 - pairing **13, 23**
- phone book **14**
- phone calls **14**
 - answering **14, 15**
 - dialing **15**
 - muting **15**
 - voice dial **15**
- photoLive **19**
- points of interest (POI) **8, 10**
 - venues **8**
- power cables **21**
 - changing the fuse **23**
- power key **3**
- product support **16**

Q

- Quick Search **8**

R

- recently found locations **10**
- red light cameras **4**
- removing mount **23**
- resetting
 - device **23**
 - trip data **12**
- restoring settings **21**
- rider alerts **3, 4**
- road conditions, weather **19**
- routes **5, 19**
 - adding a point **6, 17**
 - adventurous routing **5**
 - calculating **5**
 - calculation mode **5, 17, 20**
 - myTrends **7**
 - shaping **6**
 - starting **5, 9**
 - stopping **6**
 - suggested **7**
 - viewing on the map **5, 6**

S

- satellite signals
 - acquiring **3**
 - viewing **25**
- saved locations **17**
 - categories **11**
 - deleting **11**
 - editing **11**
- saving
 - current location **11**

- locations **18**
- screen, brightness **3**
- screenshots **20**
- search bar **8**
- settings **20, 21**
- shaping a route **6**
- sharing **17**
 - LiveTrack **17, 18**
- shortcuts
 - adding **10**
 - deleting **10**
- simulated locations **20**
- sleep mode **3**
- Smartphone Link **13, 15, 16**
 - connecting **13, 15**
 - disabling calls **15**
- software
 - updating **21, 22**
 - version **21**
- specifications **21**
- speed cameras **4**
- subscriptions, Garmin Live Services **13**
- suction cup **23**

T

- theft, avoiding **23**
- time settings **21**
- tolls, avoiding **7**
- tools, maps **11**
- TracBack **18, 19**
- tracks **18**
- traffic **12, 16, 20**
 - adding subscriptions **16**
 - alternate route **7**
 - cameras **19**
 - incidents **12, 16**
 - map **12, 16**
 - receiver **16**
 - searching for delays **12, 16**
- traffic cameras, viewing **19**
- travel history **21**
- trip information **12**
 - resetting **12**
 - viewing **12**
- trip log, viewing **12**
- trip planner **16, 17**
 - editing a trip **17**
 - shaping points **17**
- TripAdvisor **10**
- troubleshooting **23, 24**
- turn list **6**

U

- unit ID **21**
- up ahead **11**
 - customizing **12**
- updating
 - maps **21, 22**
 - software **21, 22**
- USB, disconnecting **25**

V

- venues **8**
- volume, adjusting **3**

W

- weather **19**
 - radar **19**
 - road conditions **19**
- Where Am I? **10, 11**
- Wi-Fi **20–22**

