

Dell Latitude 3450 Owner's Manual

Regulatory Model: P51G
Regulatory Type: P51G001



Notes, Cautions, and Warnings

 **NOTE:** A NOTE indicates important information that helps you make better use of your computer.

 **CAUTION:** A CAUTION indicates either potential damage to hardware or loss of data and tells you how to avoid the problem.

 **WARNING:** A WARNING indicates a potential for property damage, personal injury, or death.

Copyright © 2014 Dell Inc. All rights reserved. This product is protected by U.S. and international copyright and intellectual property laws. Dell™ and the Dell logo are trademarks of Dell Inc. in the United States and/or other jurisdictions. All other marks and names mentioned herein may be trademarks of their respective companies.

2014 - 08

Rev. A00

Contents

1 Working on Your Computer.....	5
Before Working Inside Your Computer.....	5
Turning Off Your Computer.....	6
After Working Inside Your Computer.....	7
2 Removing and Installing Components.....	8
Recommended Tools.....	8
Removing the Base Cover.....	8
Installing the Base Cover.....	9
Removing the Battery.....	10
Installing the Battery.....	11
Removing the Hard Drive.....	12
Installing the Hard Drive.....	14
Removing the WLAN Card.....	14
Installing the WLAN Card.....	15
Removing the System Fan.....	15
Installing the System Fan.....	17
Removing the Keyboard.....	17
Installing the Keyboard.....	19
Removing the Back Cover.....	23
Installing the Back Cover.....	25
Removing the Heatsink.....	26
Installing the Heatsink.....	26
Removing the I/O Board.....	27
Installing the I/O Board.....	27
Removing the Coin-Cell Battery.....	28
Installing the Coin-Cell Battery.....	28
Removing the Display Assembly.....	29
Installing the Display Assembly.....	30
Removing the Display Bezel.....	30
Installing the Display Bezel.....	32
Removing the Display Panel.....	32
Installing the Display panel.....	34
Removing the Display Hinge.....	34
Installing the Display Hinge.....	35
Removing the Camera.....	35
Installing the Camera.....	36
Removing the System Board.....	36

Installing the System Board.....	38
Removing the Speakers.....	38
Installing the Speakers.....	39
Removing the Power Connector.....	40
Installing the Power Connector.....	41
3 System Setup.....	42
Boot Sequence.....	42
Navigation Keys.....	42
System Setup Options.....	43
Updating the BIOS	51
System and Setup Password.....	52
Assigning a System Password and Setup Password.....	52
Deleting or Changing an Existing System and/or Setup Password.....	53
4 Diagnostics.....	54
Enhanced Pre-Boot System Assessment (ePSA) Diagnostics.....	54
Device Status Lights.....	55
Battery Status Lights.....	55
5 Specifications.....	56
6 Contacting Dell.....	61

Working on Your Computer

Before Working Inside Your Computer

Use the following safety guidelines to help protect your computer from potential damage and to help to ensure your personal safety. Unless otherwise noted, each procedure included in this document assumes that the following conditions exist:

- You have read the safety information that shipped with your computer.
- A component can be replaced or--if purchased separately--installed by performing the removal procedure in reverse order.

 **WARNING:** Disconnect all power sources before opening the computer cover or panels. After you finish working inside the computer, replace all covers, panels, and screws before connecting to the power source.

 **WARNING:** Before working inside your computer, read the safety information that shipped with your computer. For additional safety best practices information, see the Regulatory Compliance Homepage at www.dell.com/regulatory_compliance

 **CAUTION:** Many repairs may only be done by a certified service technician. You should only perform troubleshooting and simple repairs as authorized in your product documentation, or as directed by the online or telephone service and support team. Damage due to servicing that is not authorized by Dell is not covered by your warranty. Read and follow the safety instructions that came with the product.

 **CAUTION:** To avoid electrostatic discharge, ground yourself by using a wrist grounding strap or by periodically touching an unpainted metal surface, such as a connector on the back of the computer.

 **CAUTION:** Handle components and cards with care. Do not touch the components or contacts on a card. Hold a card by its edges or by its metal mounting bracket. Hold a component such as a processor by its edges, not by its pins.

 **CAUTION:** When you disconnect a cable, pull on its connector or on its pull-tab, not on the cable itself. Some cables have connectors with locking tabs; if you are disconnecting this type of cable, press in on the locking tabs before you disconnect the cable. As you pull connectors apart, keep them evenly aligned to avoid bending any connector pins. Also, before you connect a cable, ensure that both connectors are correctly oriented and aligned.

 **NOTE:** The color of your computer and certain components may appear differently than shown in this document.

To avoid damaging your computer, perform the following steps before you begin working inside the computer.

1. Ensure that your work surface is flat and clean to prevent the computer cover from being scratched.
2. Turn off your computer (see Turning off Your Computer).

3. If the computer is connected to a docking device (docked), undock it.

 **CAUTION: To disconnect a network cable, first unplug the cable from your computer and then unplug the cable from the network device.**

4. Disconnect all network cables from the computer.
5. Disconnect your computer and all attached devices from their electrical outlets.
6. Close the display and turn the computer upside-down on a flat work surface.

 **NOTE: To avoid damaging the system board, you must remove the main battery before you service the computer.**

7. Remove the main battery.
8. Turn the computer top-side up.
9. Open the display.
10. Press the power button to ground the system board.

 **CAUTION: To guard against electrical shock, always unplug your computer from the electrical outlet before opening the display.**

 **CAUTION: Before touching anything inside your computer, ground yourself by touching an unpainted metal surface, such as the metal at the back of the computer. While you work, periodically touch an unpainted metal surface to dissipate static electricity, which could harm internal components.**

11. Remove any installed ExpressCards or Smart Cards from the appropriate slots.

Turning Off Your Computer

 **CAUTION: To avoid losing data, save and close all open files and exit all open programs before you turn off your computer.**

1. Shut down the operating system:

- In Windows 8.1:

- Using a touch-enabled device:

- a. Swipe in from the right edge of the screen, opening the Charms menu and select **Settings**.
- b. Select the  and then select **Shut down**.

Or

- * On the Home screen, touch the  and then select **Shut down**.

- Using a mouse:

- a. Point to upper-right corner of the screen and click **Settings**.
- b. Click the  and select **Shut down**.

Or

- * On the Home screen, click  and then select **Shut down**.

- In Windows 7:

1. Click **Start** .
2. Click **Shut Down**.

or

1. Click **Start** .
2. Click the arrow in the lower-right corner of the **Start** menu as shown below, and then click



Shut Down

2. Ensure that the computer and all attached devices are turned off. If your computer and attached devices did not automatically turn off when you shut down your operating system, press and hold the power button for about 6 seconds to turn them off.

After Working Inside Your Computer

After you complete any replacement procedure, ensure you connect any external devices, cards, and cables before turning on your computer.

 **CAUTION: To avoid damage to the computer, use only the battery designed for this particular Dell computer. Do not use batteries designed for other Dell computers.**

1. Connect any external devices, such as a port replicator or media base, and replace any cards, such as an ExpressCard.
2. Connect any telephone or network cables to your computer.

 **CAUTION: To connect a network cable, first plug the cable into the network device and then plug it into the computer.**

3. Replace the battery.
4. Connect your computer and all attached devices to their electrical outlets.
5. Turn on your computer.

Removing and Installing Components

This section provides detailed information on how to remove or install the components from your computer.

Recommended Tools

The procedures in this document may require the following tools:

- Small flat-blade screwdriver
- #0 Phillips screwdriver
- #1 Phillips screwdriver
- Small plastic scribe

Removing the Base Cover

1. Follow the procedures in [Before Working Inside Your Computer](#).
2. Perform the following steps as shown in the illustration:
 - a. Loosen the captive screws that secure the base cover to the computer [1].
 - b. Pry the base cover along the edges to loosen it [2].



3. Perform the following steps as shown in the illustration:
 - a. Lift the base cover partially at a 45-degree angle [1].
 - b. Remove the base cover from the computer [2].



Installing the Base Cover

1. Perform the following steps as shown in the illustration:
 - a. Align the base cover on the computer [1].
 - b. Lower the base cover towards the computer in the direction indicated [2].



2. Starting from the sides, press on the locations indicated by the arrows. This will snap the base cover to the computer.

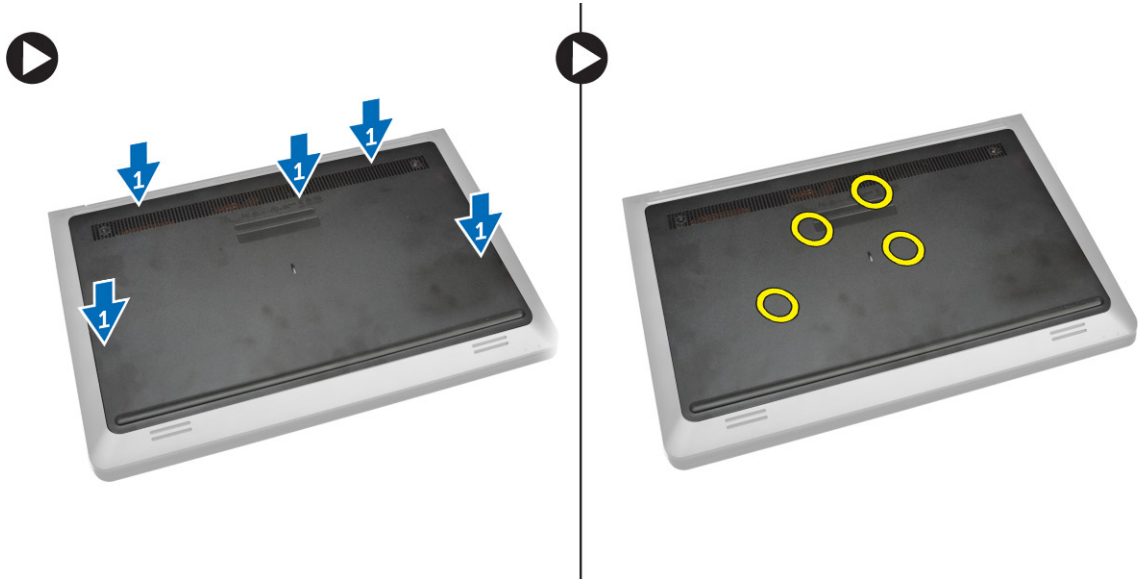

3. Tighten the screws that secure the base cover to the computer.
4. Follow the procedures in [After Working Inside Your computer.](#)

Removing the Battery

1. Follow the procedures in [Before Working Inside Your Computer.](#)
2. Remove [base cover](#)
3. Perform the following steps as shown in the illustration:
 - a. Loosen the screw that secures the battery to the computer [1].
 - b. Lift the battery [2].

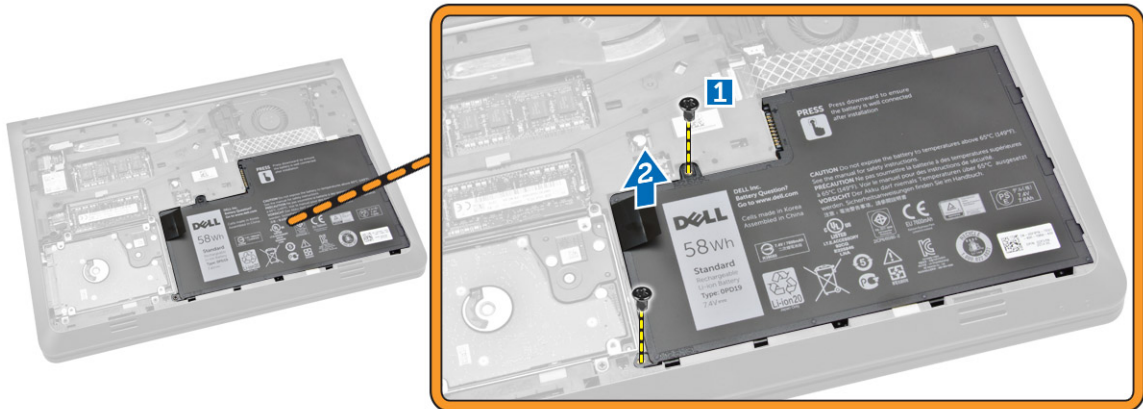

4. Lift the battery partially at a 45-degree angle.

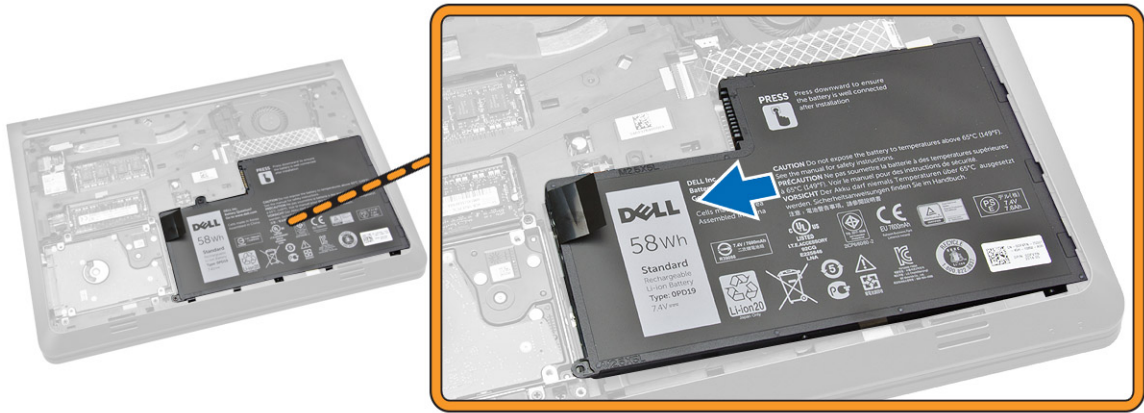

5. Remove the battery from the computer.

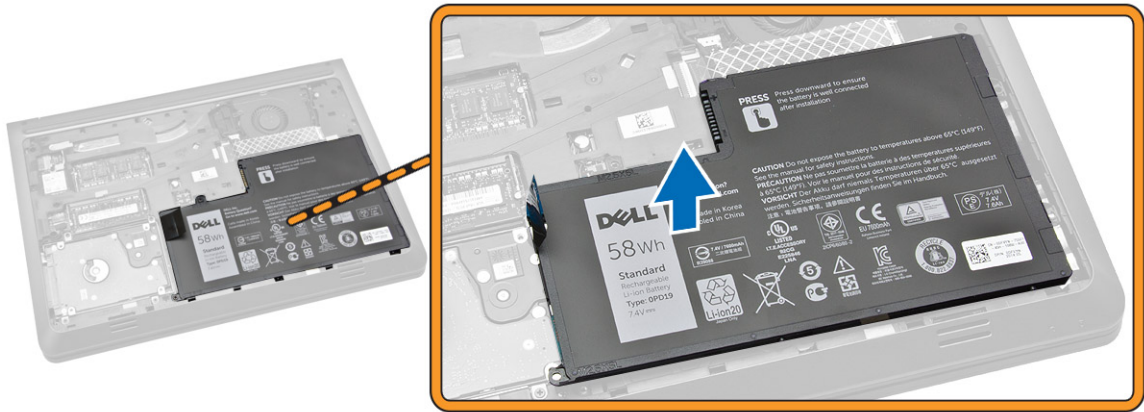

Installing the Battery

1. Place the battery in its slots.
2. Press the location indicated in the picture to ensure proper connection after installation.

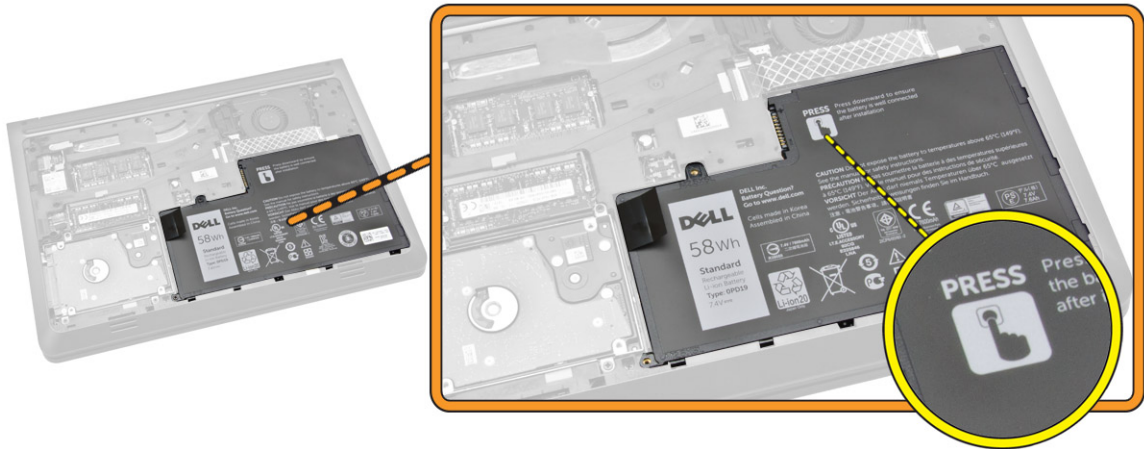

3. Tighten the screw to secure the battery to the computer.
4. Install the [base cover](#).
5. Follow the procedures in [After Working Inside Your computer](#).

Removing the Hard Drive

1. Follow the procedures in [Before Working Inside Your Computer](#).
2. Remove:
 - a. [base cover](#)
 - b. [battery](#)
3. Perform the following steps as shown in the illustration:
 - a. Loosen the screw that secures the hard drive to the computer [1].
 - b. Lift the hard drive partially at a 45-degree angle [2].
 - c. Slide the hard drive from the computer [3].

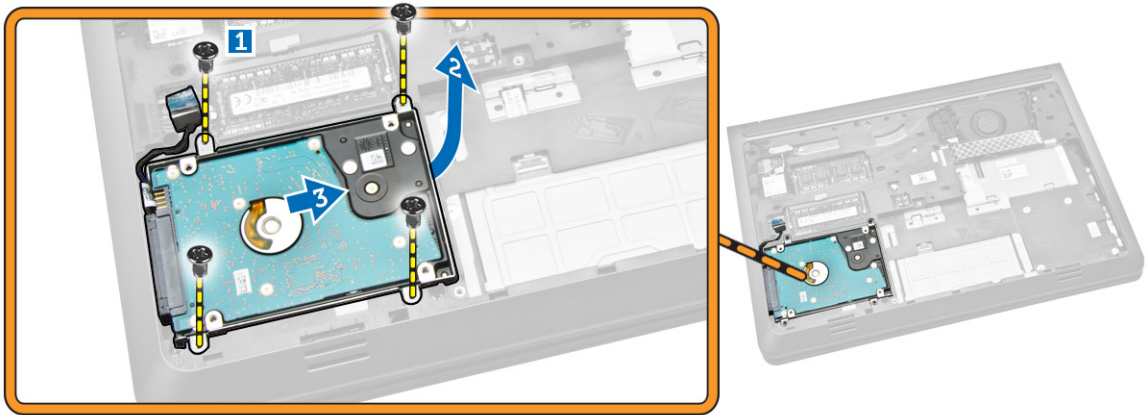
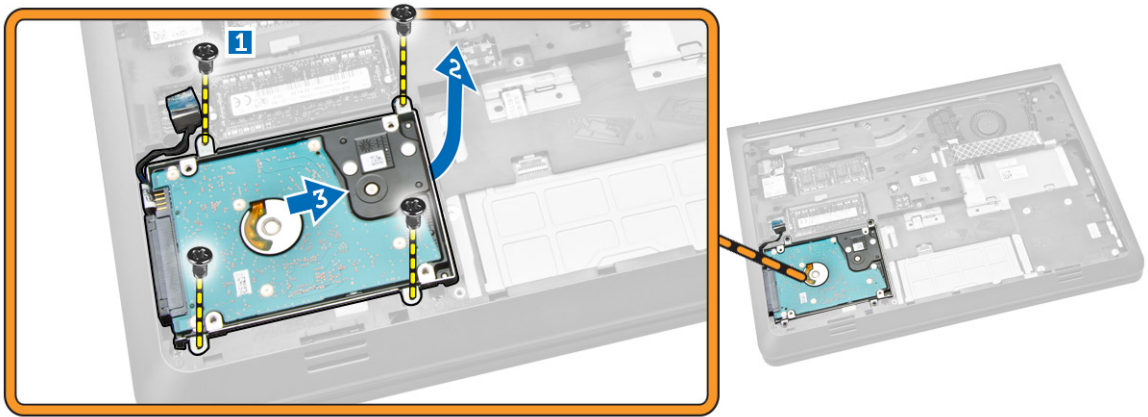

4. Perform the following steps as shown in the illustration:
- a. Disconnect the hard drive cable and slide the hard drive [1].
 - b. Lift the hard drive from the computer [2].

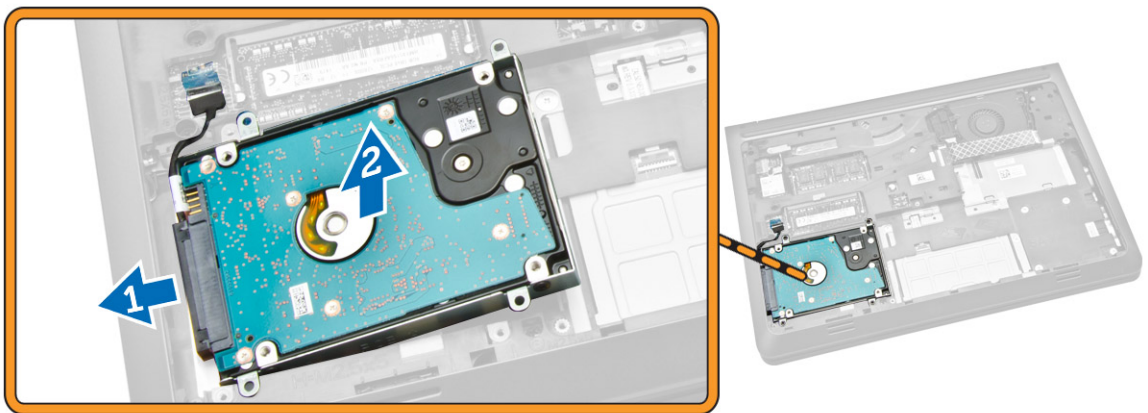

Installing the Hard Drive

1. Connect the hard drive cable.
2. Place the hard drive inside the computer.
3. Tighten the screw that secures the hard drive to the computer.
4. Install:
 - a. [battery](#)
 - b. [base cover](#)
5. Follow the procedures in [After Working Inside Your computer](#).

Removing the WLAN Card

1. Follow the procedures in [Before Working Inside Your Computer](#).
2. Remove:
 - a. [base cover](#)
 - b. [battery](#)
3. Perform the following steps as shown in the illustration:
 - a. Loosen the screw that secures the WLAN card to the computer [1].
 - b. Lift the tab in the direction indicated [2].
 - c. Disconnect the cables that connect the WLAN card to the computer [3].

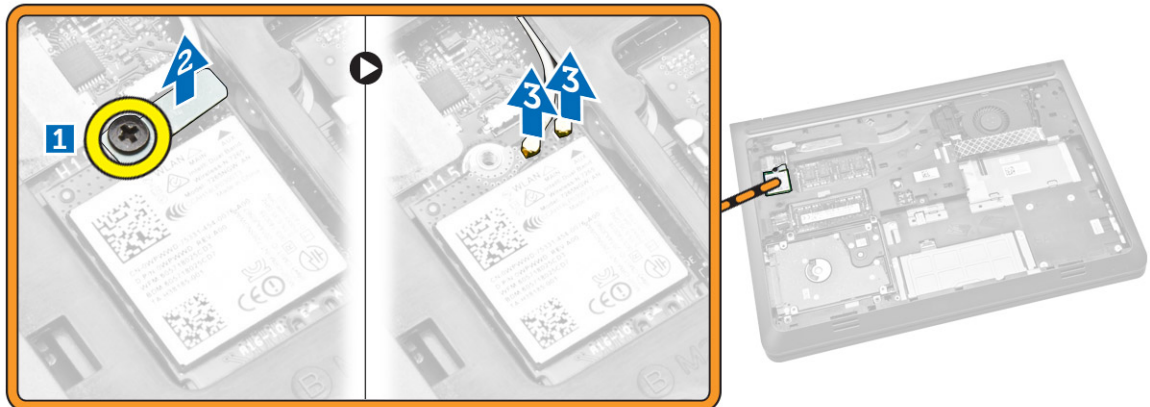

4. Remove the WLAN card from the computer.

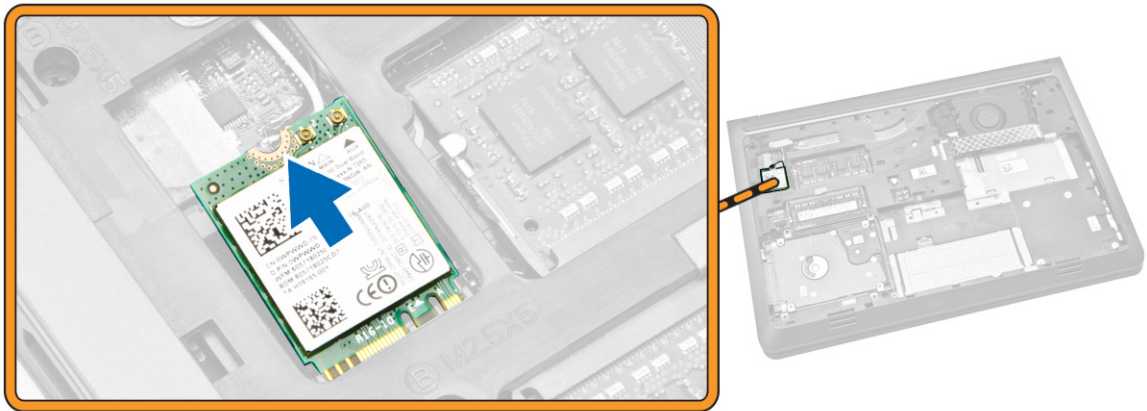

Installing the WLAN Card

1. Place the WLAN card in its slot on the computer.
2. Connect the WLAN antenna cables to their connectors on the WLAN Card.
3. Press the locking tab.
4. Tighten the screw that secures the WLAN card to the computer.
5. Install:
 - a. [battery](#)
 - b. [base cover](#)
6. Follow the procedures in [After Working Inside Your computer](#).

Removing the System Fan

1. Follow the procedures in [Before Working Inside Your Computer](#).
2. Remove:
 - a. [base cover](#)
 - b. [battery](#)
3. Perform the following steps as shown in the illustration:
 - a. Lift the locking tab [1].
 - b. Disconnect the tape that secures the system fan [2].
 - c. Lift the tape that secures the system fan [3].

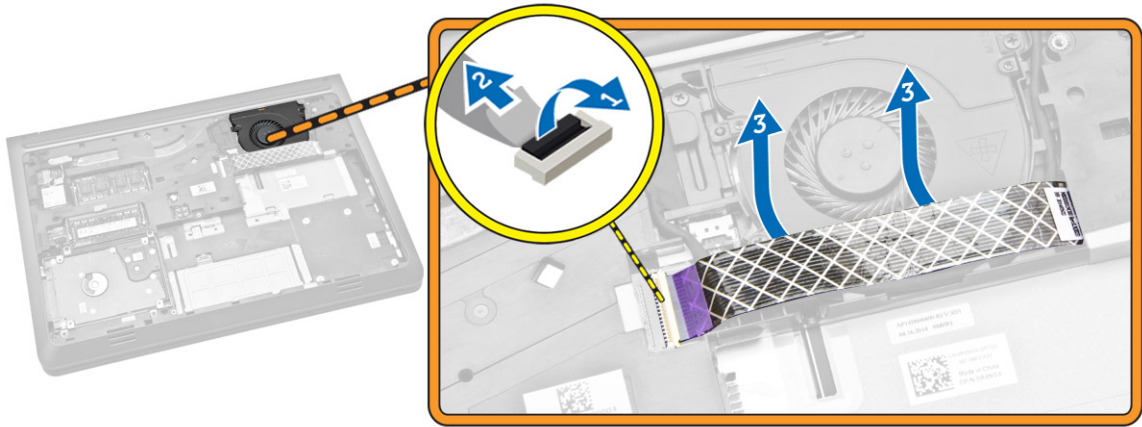

4. Perform the following steps as shown in the illustration:
 - a. Disconnect the fan cable from the computer [1].
 - b. Unroute the cable from the slot [2].

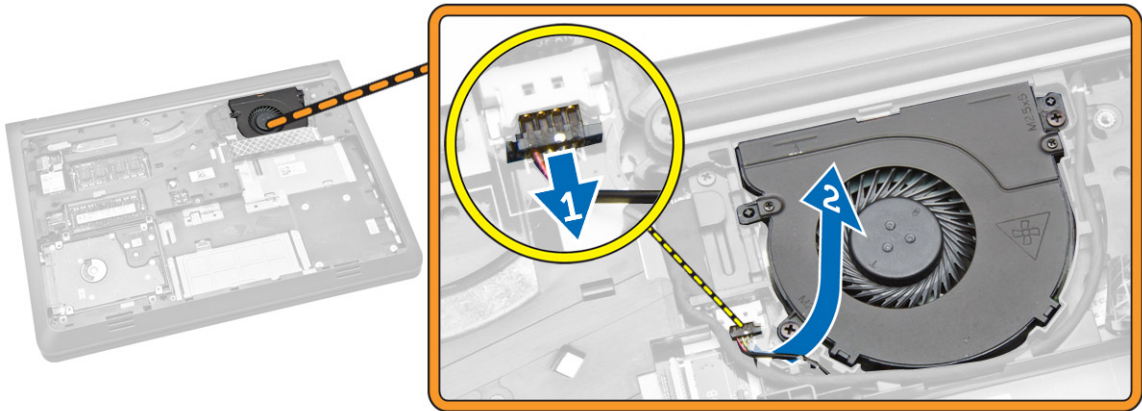

5. Perform the following steps as shown in the illustration:
 - a. Loosen the screw that secures the system fan to the computer [1].
 - b. Lift the system fan from the computer [2].

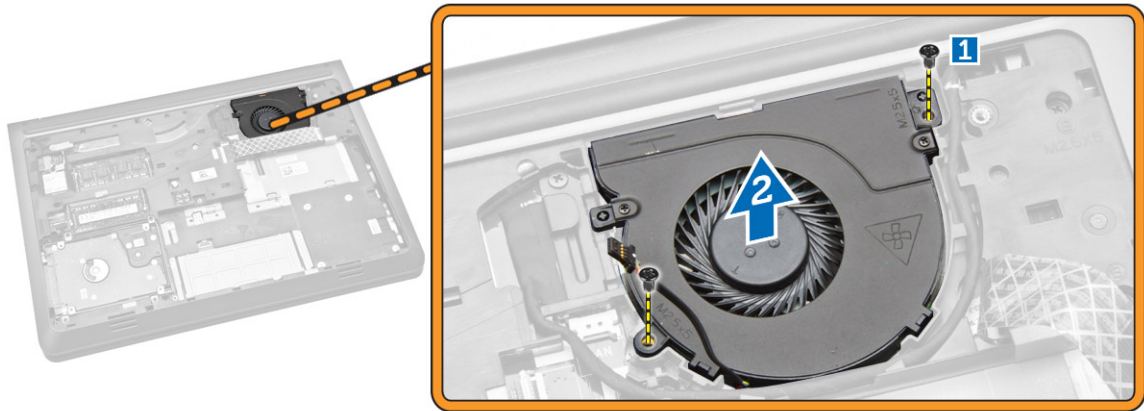

Installing the System Fan

1. Place the system fan on its slots in the computer.
2. Tighten the screw to secure the system fan to the computer.
3. Route the cable to the slot.
4. Connect the fan cable to the computer.
5. Affix the adhesive tape.
6. Press the locking tab.
7. Install
 - a. [battery](#)
 - b. [base cover](#)
8. Follow the procedures in [After Working Inside Your computer](#).

Removing the Keyboard

1. Follow the procedures in [Before Working Inside Your Computer](#).
2. Remove:
 - a. [base cover](#)
 - b. [battery](#)
3. Release the keyboard by prying the tabs on the palmrest assembly.



4. Perform the following steps as shown in the illustration:
 - a. Lift the keyboard from the computer [1].
 - b. Flip the keyboard to access the keyboard cable [2].

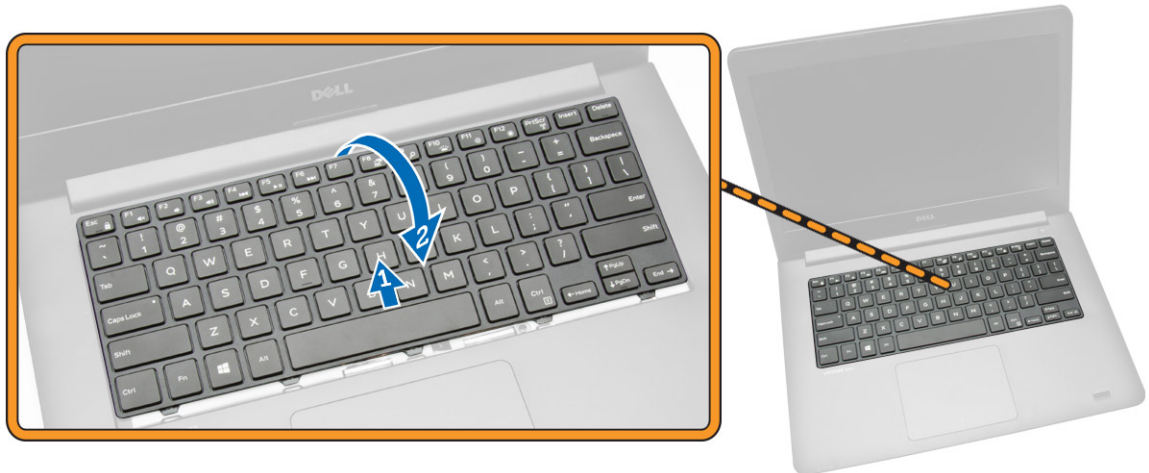

5. Perform the following steps as shown in the illustration:
 - a. Lift the locking tab [1].
 - b. Disconnect the cable from the locking tab [2].
 - c. Disconnect the keyboard cable from the computer [3].

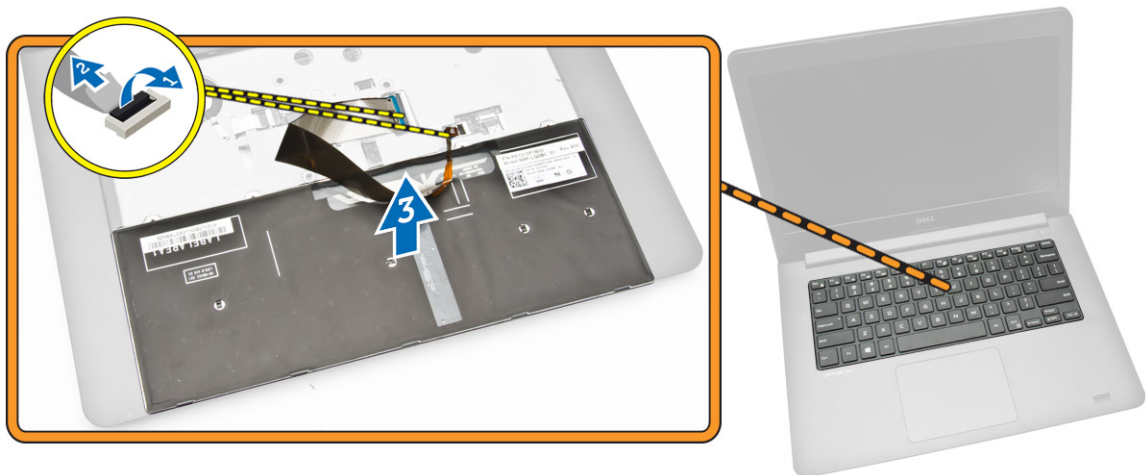

Installing the Keyboard

Procedure

 **NOTE:** If you are installing a new keyboard, fold the cables the same way they are folded on the old keyboard.

1. Slide the keyboard and keyboard-backlight cables into the respective connectors and press down the latches to secure the cables.
2. Turn the keyboard over, slide the tabs on the keyboard into the slots on the palm-rest assembly, and snap the keyboard into place.

 **CAUTION: Do not apply excess pressure while folding the cables.**

The cables on the keyboard are not folded when you receive a replacement keyboard. Follow these instructions to fold the cables on the replacement keyboard the same way they are folded on the old keyboard.

1. Place the keyboard on a flat and clean surface.

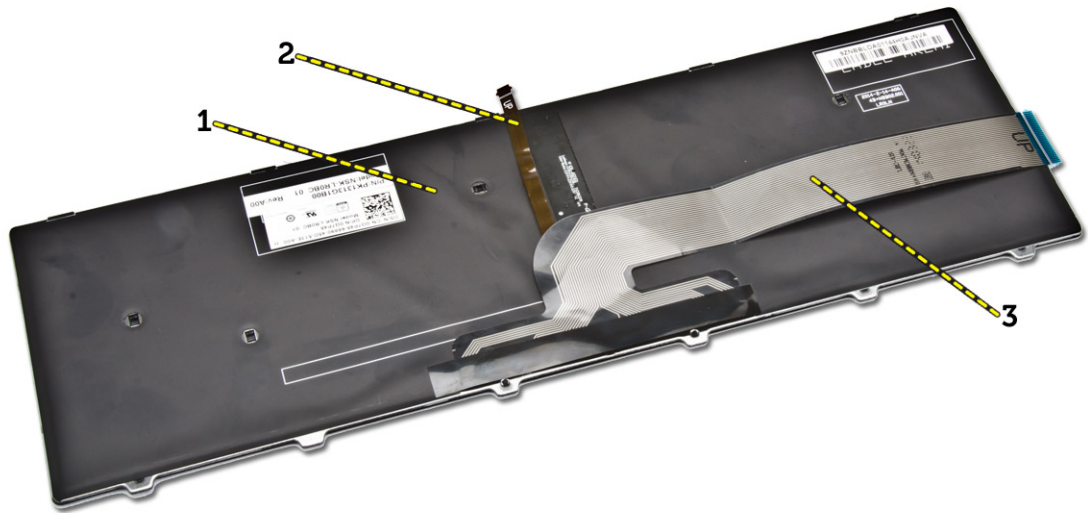

- 1) keyboard
- 2) keyboard-backlight cable
- 3) keyboard cable

⚠ CAUTION: Do not apply excess pressure while folding the cables.

2. Lift the keyboard cable.



3. Gently fold the keyboard-backlight cable at the fold line



4. Fold the keyboard-backlight second fold cable at the fold line.



5. Fold the keyboard-backlight third fold cable at the fold line.



6. Connect the keyboard cable to its connector on the system board.
7. Align the keyboard to the palmrest as indicated and press down to snap it into place.

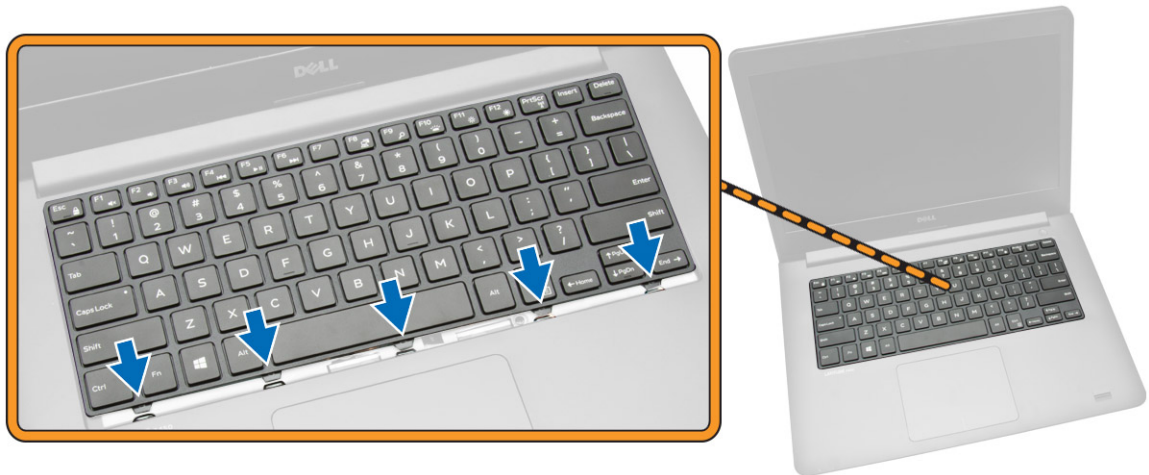

8. Press on the sides of the keyboard followed by the locations marked in the picture to firmly seat it.

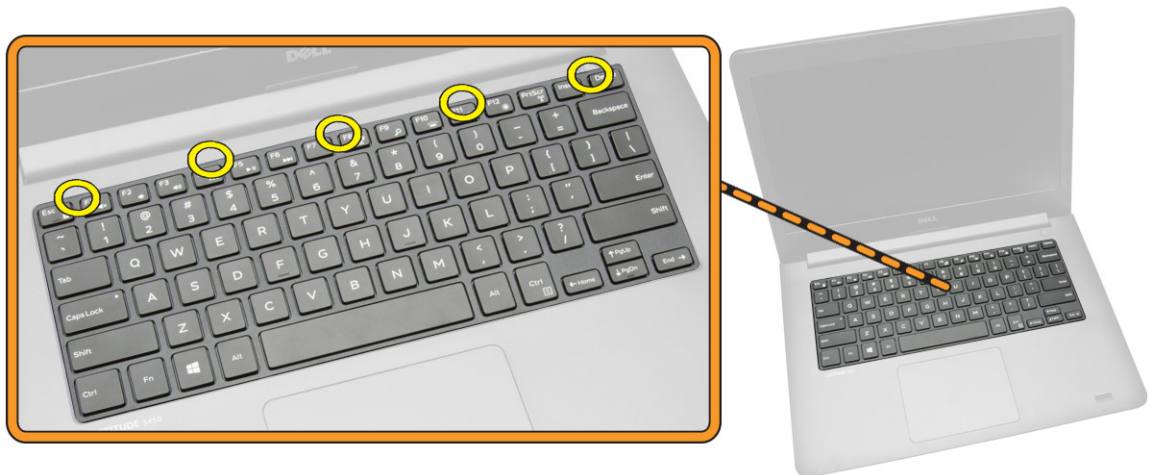

9. Press the locations indicated in the picture to complete the keyboard installation.

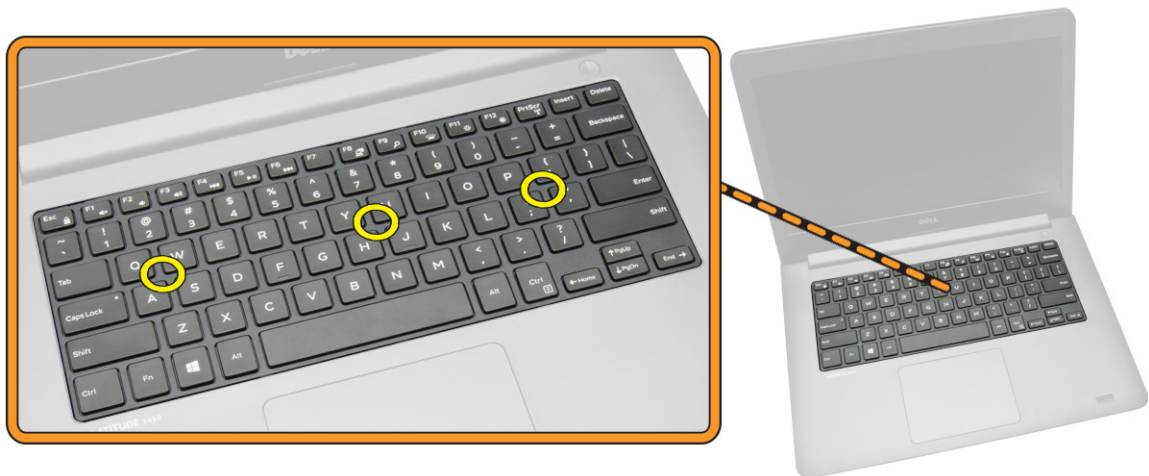

10. Install:
- [Battery](#)
 - [Base Cover](#)

Removing the Back Cover

- Follow the procedures in [Before Working Inside Your Computer](#).
- Remove:
 - [base cover](#)
 - [battery](#)
 - [hard drive](#)
 - [system fan](#)
 - [keyboard](#)
- Flip the computer and remove the screw that secures the palmrest assembly to the system board.



4. Perform the following steps as shown in the illustration:
 - a. Remove the screw that secures the display cable to the computer [1].
 - b. Lift the tab that secures the display cable to the computer [2].
 - c. Peel the tape that secures the hard drive connector [3].
 - d. Disconnect the hard drive connector [4].

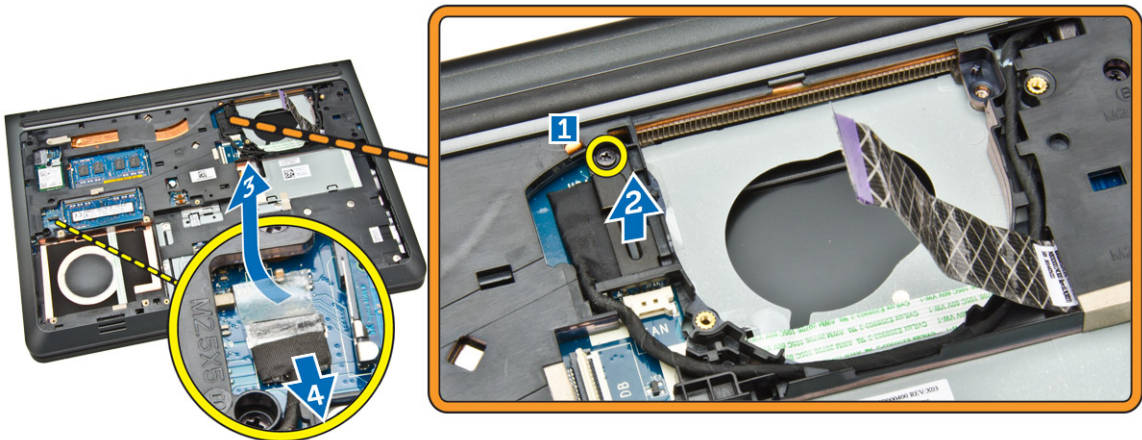

5. Perform the following steps as shown in the illustration:
 - a. Disconnect the display cable [1].
 - b. Unroute the cable from the slot [2].

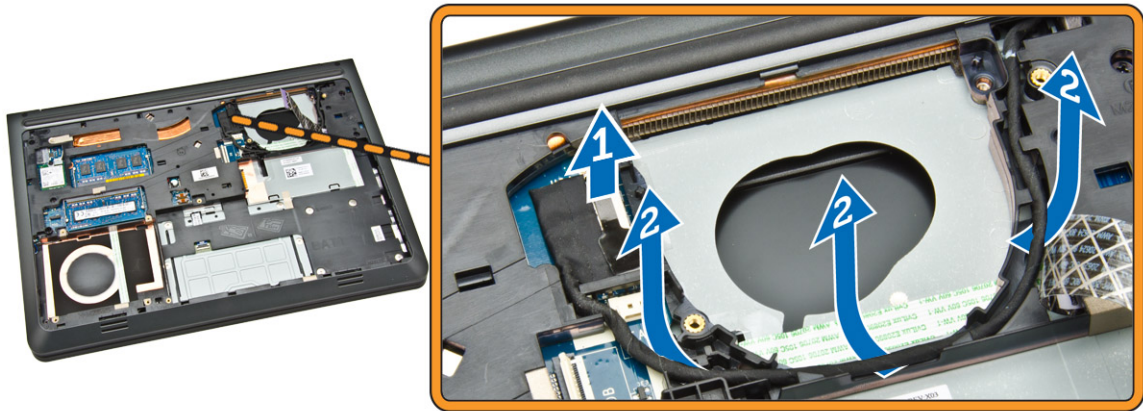

6. Perform the following steps as shown in the illustration:
 - a. Remove the screw that secures the bottom cover to the computer [1].
 - b. Pry the edges of the bottom cover [2].
 - c. Lift the back cover [3].

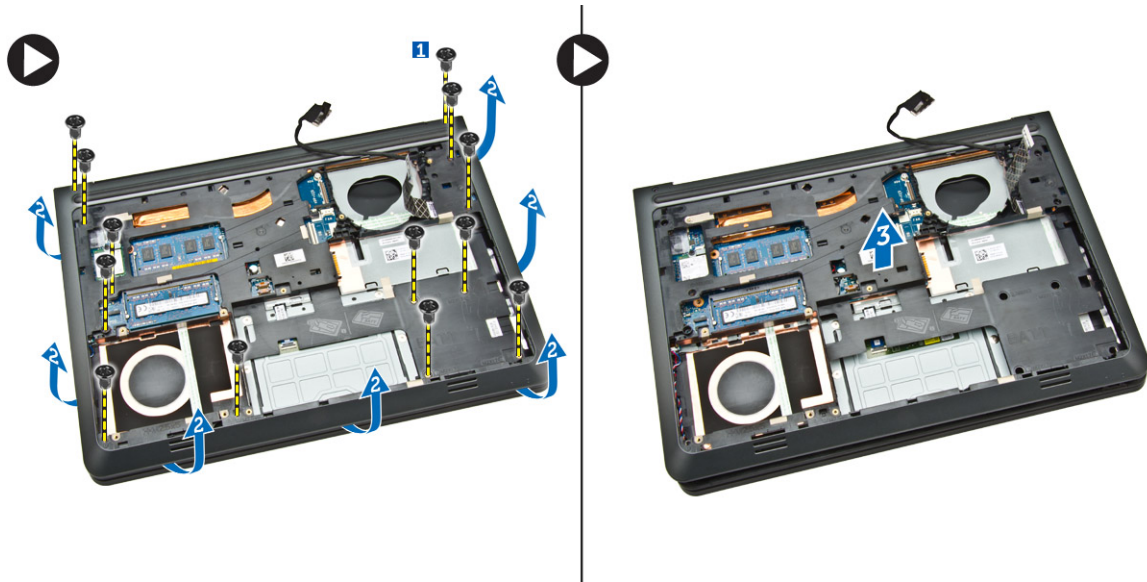

Installing the Back Cover

1. Place the back cover on the computer.
2. Tighten the screw to secure the back cover to the computer.
3. Route the display cable to the slot.
4. Connect the display cable.
5. Press the tab until the display cable is secured.
6. Tighten the screw.
7. Connect the hard drive connector and affix the adhesive tape.

8. Flip the computer and tighten the screw that secures the palmrest assembly.
9. Install:
 - a. [keyboard](#)
 - b. [system fan](#)
 - c. [hard drive](#)
 - d. [battery](#)
 - e. [base cover](#)
10. Follow the procedures in [After Working Inside Your computer](#).

Removing the Heatsink

1. Follow the procedures in [Before Working Inside Your Computer](#).
2. Remove:
 - a. [base cover](#)
 - b. [battery](#)
 - c. [hard drive](#)
 - d. [WLAN card](#)
 - e. [system fan](#)
 - f. [keyboard](#)
 - g. [back cover](#)
3. Perform the following steps as shown in the illustration:
 - a. Loosen the screws that secure the heatsink to the computer [1].
 - b. Lift the heatsink from the computer [2].

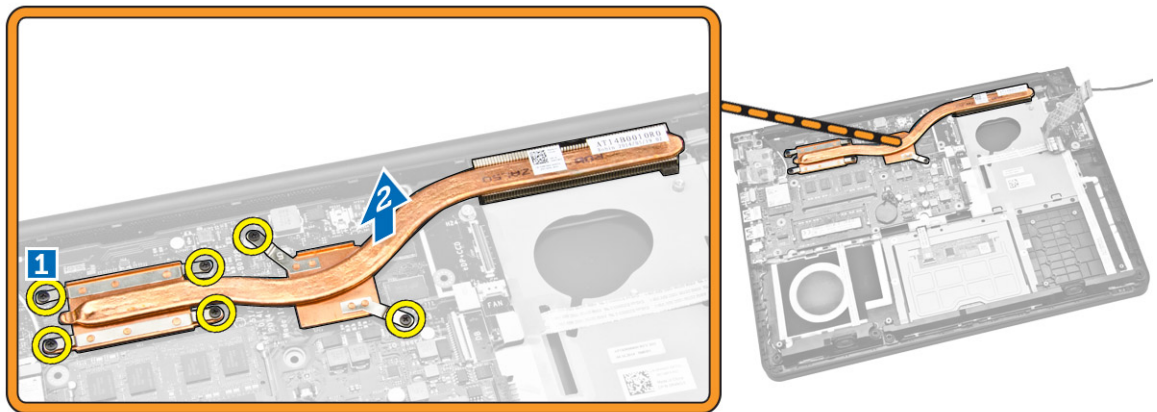

Installing the Heatsink

1. Place the heatsink in its slot on the computer.
2. Tighten the screws to secure the heatsink to the computer.
3. Install:
 - a. [back cover](#)
 - b. [keyboard](#)
 - c. [system fan](#)

- d. [WLAN card](#)
 - e. [hard drive](#)
 - f. [battery](#)
 - g. [base cover](#)
4. Follow the procedures in [After Working Inside Your computer](#).

Removing the I/O Board

1. Follow the procedures in [Before Working Inside Your Computer](#).
2. Remove:
 - a. [base cover](#)
 - b. [battery](#)
 - c. [hard drive](#)
 - d. [WLAN card](#)
 - e. [system fan](#)
 - f. [keyboard](#)
 - g. [back cover](#)
3. Perform the following steps as shown in the illustration:
 - a. Remove the screw that secures the I/O board to the system board [1].
 - b. Lift the I/O board from the system board [2].

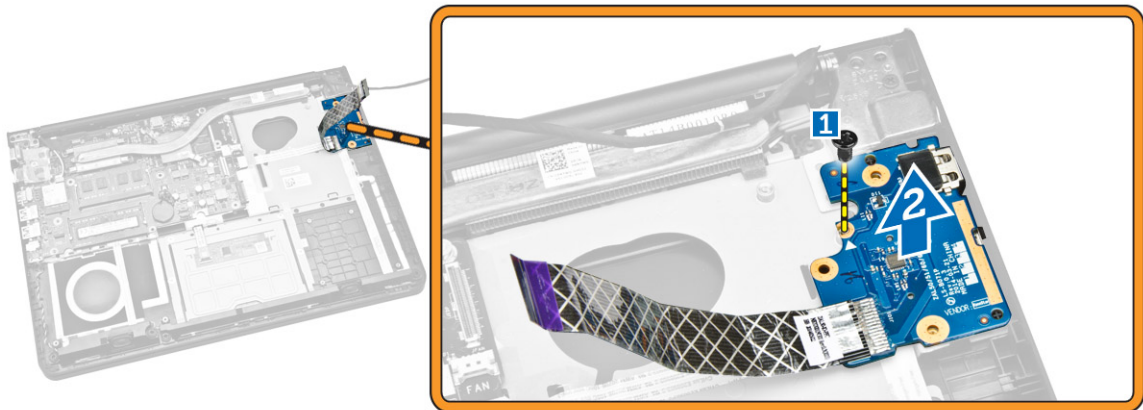

Installing the I/O Board

1. Place the I/O board on the computer.
2. Tighten the screw to secure the I/O board to the computer.
3. Install:
 - a. [back cover](#)
 - b. [keyboard](#)
 - c. [system fan](#)
 - d. [WLAN card](#)
 - e. [hard drive](#)
 - f. [battery](#)

- g. [base cover](#)
- 4. Follow the procedures in [After Working Inside Your computer.](#)

Removing the Coin-Cell Battery

1. Follow the procedures in [Before Working Inside Your Computer.](#)
2. Remove:
 - a. [base cover](#)
 - b. [battery](#)
 - c. [hard drive](#)
 - d. [WLAN card](#)
 - e. [system fan](#)
 - f. [keyboard](#)
 - g. [back cover](#)
3. Perform the following steps as shown in the illustration:
 - a. Disconnect the coin-cell cable from the computer [1].
 - b. Lift the coin-cell battery from the computer [2].

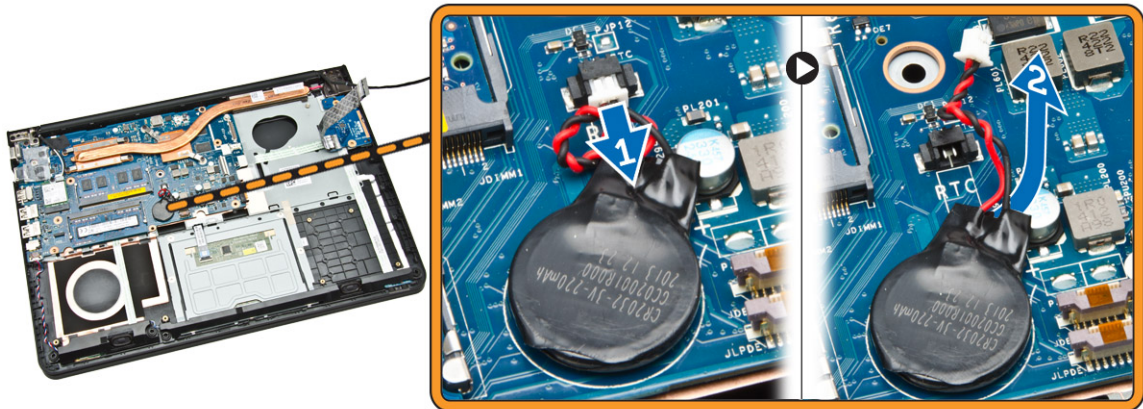

Installing the Coin-Cell Battery

1. Place the Coin-cell battery on the computer.
2. Connect the coin-cell battery cable to the computer..
3. Install:
 - a. [back cover](#)
 - b. [keyboard](#)
 - c. [system fan](#)
 - d. [WLAN card](#)
 - e. [hard drive](#)
 - f. [battery](#)
 - g. [base cover](#)
4. Follow the procedures in [After Working Inside Your computer.](#)

Removing the Display Assembly

1. Follow the procedures in [Before Working Inside Your Computer](#).
2. Remove:
 - a. [base cover](#)
 - b. [battery](#)
 - c. [hard drive](#)
 - d. [WLAN card](#)
 - e. [system fan](#)
 - f. [keyboard](#)
 - g. [back cover](#)
3. Perform the following steps as shown in the illustration:
 - a. Disconnect the display assembly cable from the computer [1].
 - b. Loosen the screw that secures the display assembly [2].
 - c. Lift the display assembly from the computer [3].

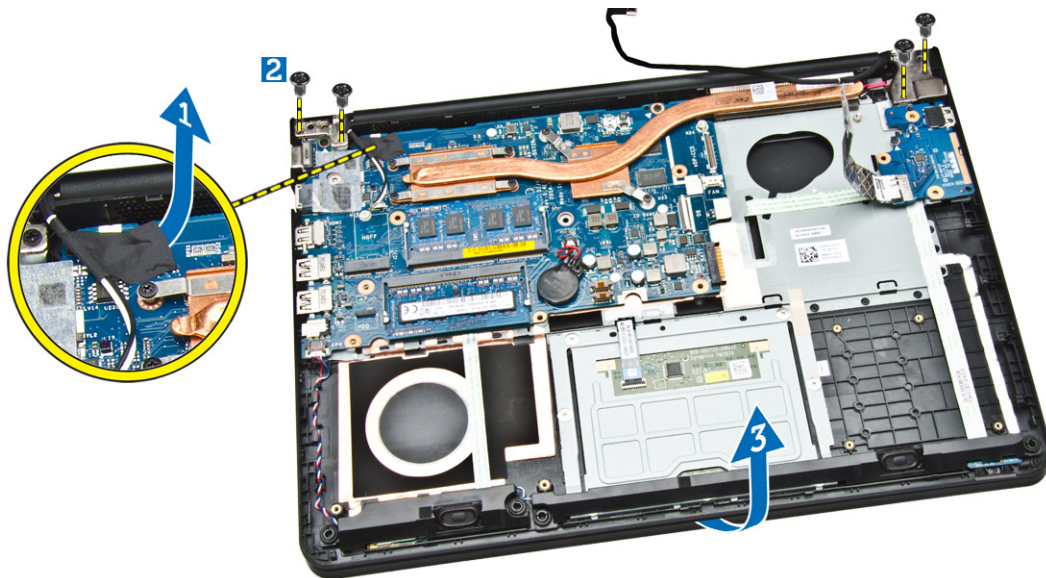

4. Remove the display assembly from the computer.

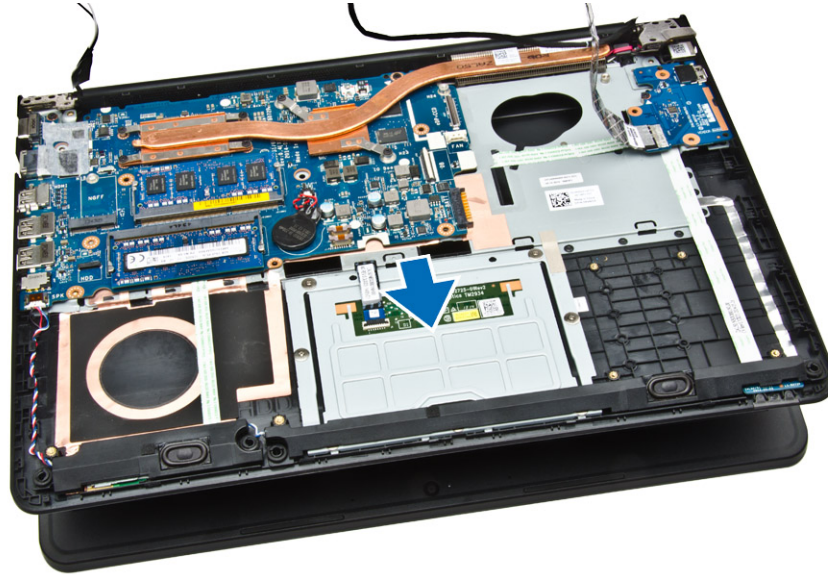

Installing the Display Assembly

1. Place the display assembly on the computer.
2. Tighten the screw to secure the display assembly to the computer.
3. Press the hinge cap to the computer.
4. Connect the display assembly cable to the computer.
5. Install:
 - a. [back cover](#)
 - b. [keyboard](#)
 - c. [system fan](#)
 - d. [WLAN card](#)
 - e. [hard drive](#)
 - f. [battery](#)
 - g. [base cover](#)
6. Follow the procedures in [After Working Inside Your computer](#).

Removing the Display Bezel

1. Follow the procedures in [Before Working Inside Your Computer](#).
2. Remove:
 - a. [base cover](#)
 - b. [battery](#)
 - c. [hard drive](#)
 - d. [WLAN card](#)
 - e. [system fan](#)
 - f. [keyboard](#)
 - g. [display assembly](#)
3. Pry out right side of the hinge cover.

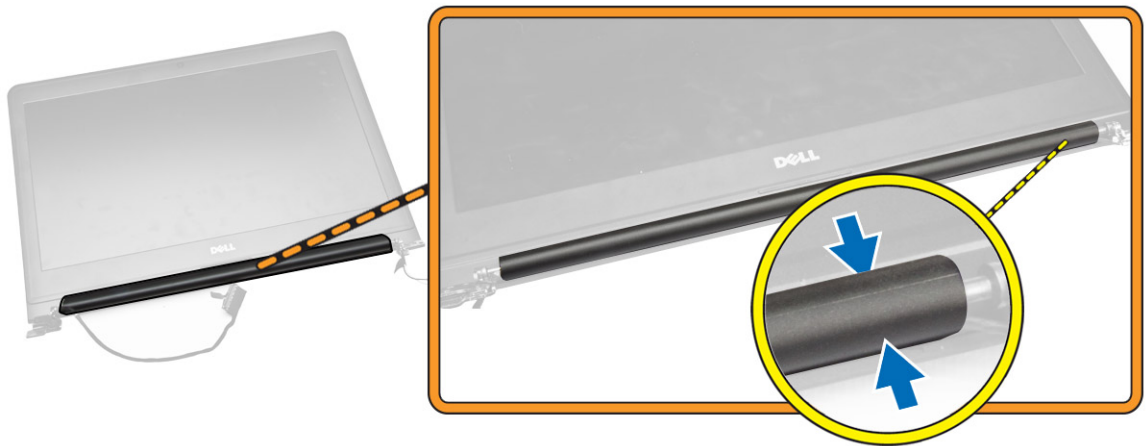

4. Pry the left side of the hinge cover.

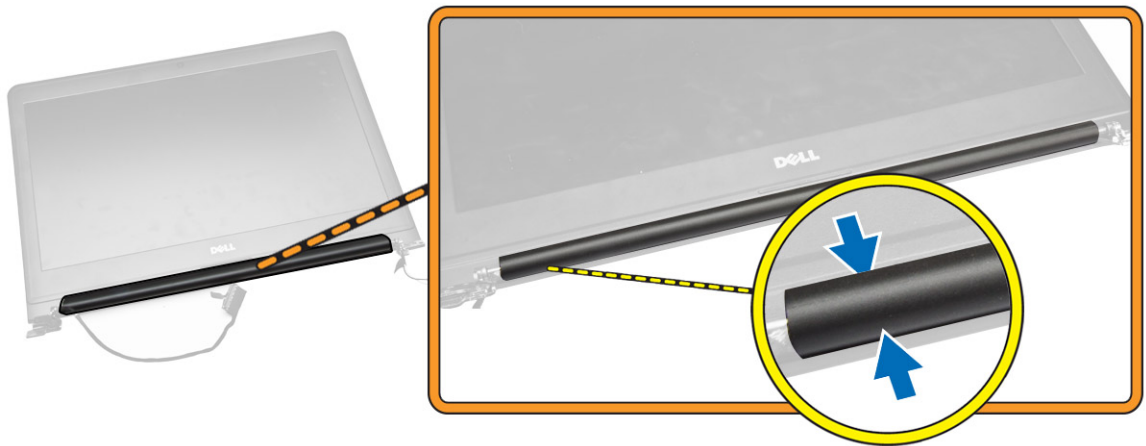

5. Pry the centre hinge cover and lift it from the computer.

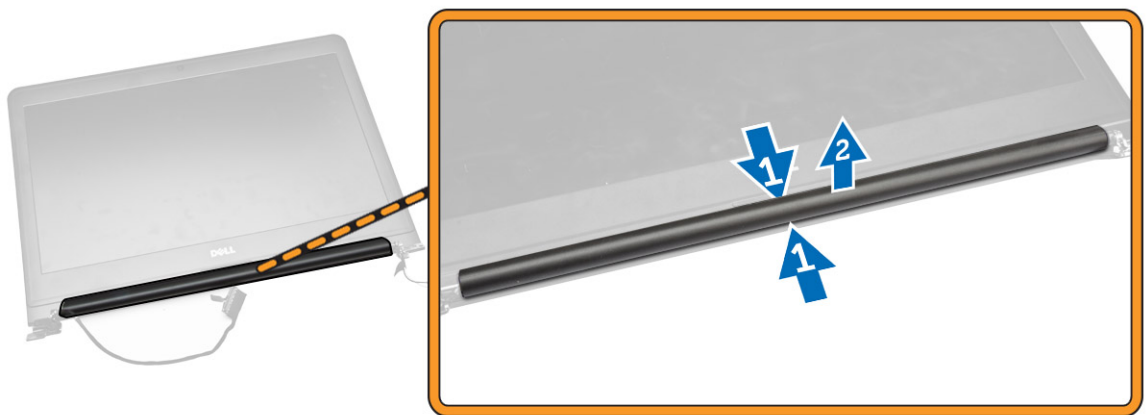

6. Perform the following steps as shown in the illustration

- a. Pry the edges of the hinge cap [1].
- b. Lift the display hinge [2].

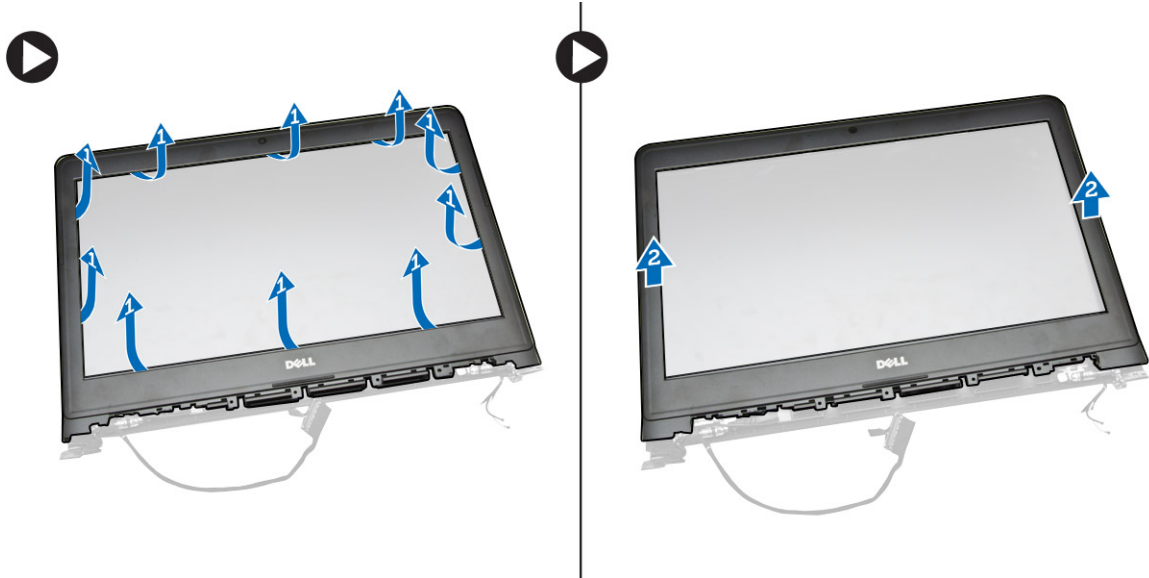

Installing the Display Bezel

1. Align the display bezel and snap it in place.
2. Connect the display assembly cable.
3. Install:
 - a. [display assembly](#)
 - b. [base cover](#)
 - c. [keyboard](#)
 - d. [system fan](#)
 - e. [WLAN card](#)
 - f. [hard drive](#)
 - g. [battery](#)
 - h. [base cover](#)
4. Follow the procedures in [After Working Inside Your computer](#).

Removing the Display Panel

1. Follow the procedures in [Before Working Inside Your Computer](#).
2. Remove:
 - a. [base cover](#)
 - b. [battery](#)
 - c. [hard drive](#)
 - d. [WLAN card](#)
 - e. [system fan](#)
 - f. [keyboard](#)
 - g. [display assembly](#)
 - h. [display bezel](#)

3. Perform the following steps as shown in the illustration:
 - a. Loosen the screws that secure the display panel [1].
 - b. Lift the display panel [2].



4. Perform the following steps as shown in the illustration:
 - a. Remove the tape that secures the display panel [1].
 - b. Lift the tab [2].

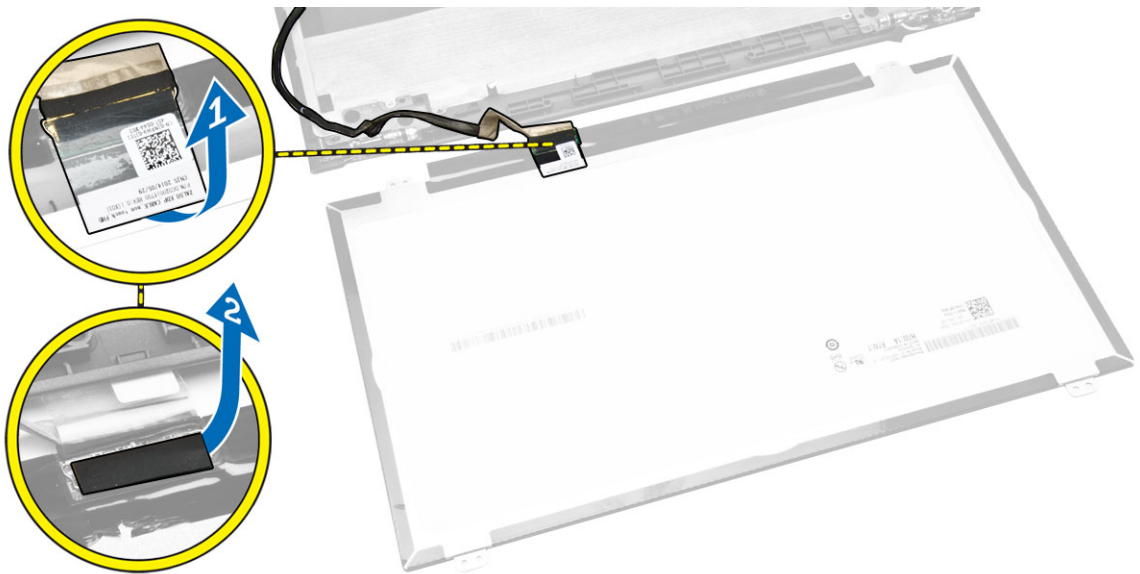

5. Perform the following steps as shown in the illustration:
 - a. Disconnect the display panel cable [1].
 - b. Lift the display panel [2].



Installing the Display panel

1. Connect the display cable to the display panel.
2. Affix the tape to secure the display cable.
3. Place the display panel on the display assembly.
4. Tighten the screws to secure the display panel to the display assembly.
5. Install:
 - a. [display bezel](#)
 - b. [display assembly](#)
 - c. [back cover](#)
 - d. [keyboard](#)
 - e. [system fan](#)
 - f. [WLAN card](#)
 - g. [hard drive](#)
 - h. [battery](#)
 - i. [base cover](#)
6. Follow the procedures in [After Working Inside Your computer](#).

Removing the Display Hinge

1. Follow the procedures in [Before Working Inside Your Computer](#).
2. Remove:
 - a. [base cover](#)
 - b. [battery](#)
 - c. [hard drive](#)
 - d. [WLAN card](#)
 - e. [system fan](#)
 - f. [keyboard](#)
 - g. [display assembly](#)

- h. [display bezel](#)
 - i. [display panel](#)
3. Perform the following steps as shown in the illustration:
- a. Loosen the screws that secure the display hinge [1].
 - b. Lift the display hinge [2].

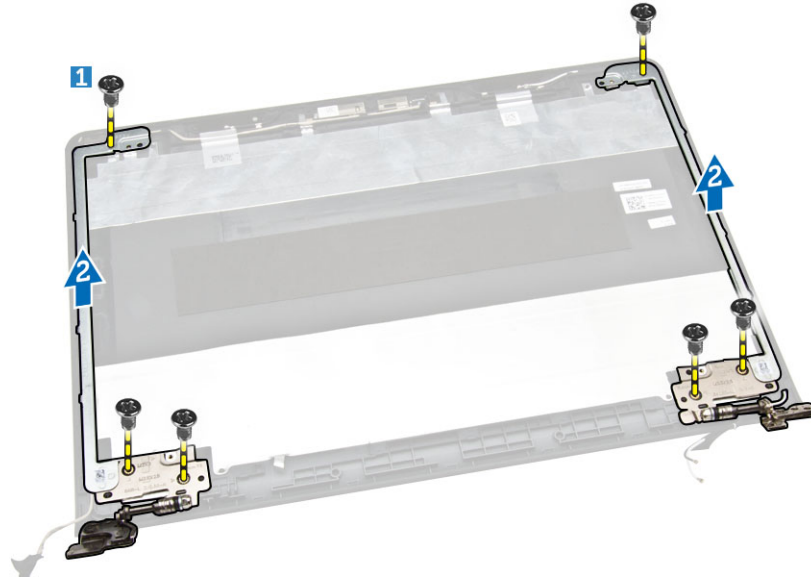

Installing the Display Hinge

1. Place the display hinges in its place.
2. Tighten the screws to secure the display hinges to the display assembly.
3. Install:
 - a. [display panel](#)
 - b. [display bezel](#)
 - c. [display assembly](#)
 - d. [back cover](#)
 - e. [keyboard](#)
 - f. [system fan](#)
 - g. [WLAN card](#)
 - h. [hard drive](#)
 - i. [battery](#)
 - j. [base cover](#)
4. Follow the procedures in [After Working Inside Your computer](#).

Removing the Camera

1. Follow the procedures in [Before Working Inside Your Computer](#).
2. Remove:
 - a. [base cover](#)
 - b. [battery](#)

- c. [display bezel](#)
3. Perform the following steps as shown in the illustration:
 - a. Disconnect the camera cable from the connector on the camera module [1].
 - b. Lift and remove the camera from the display assembly [2].

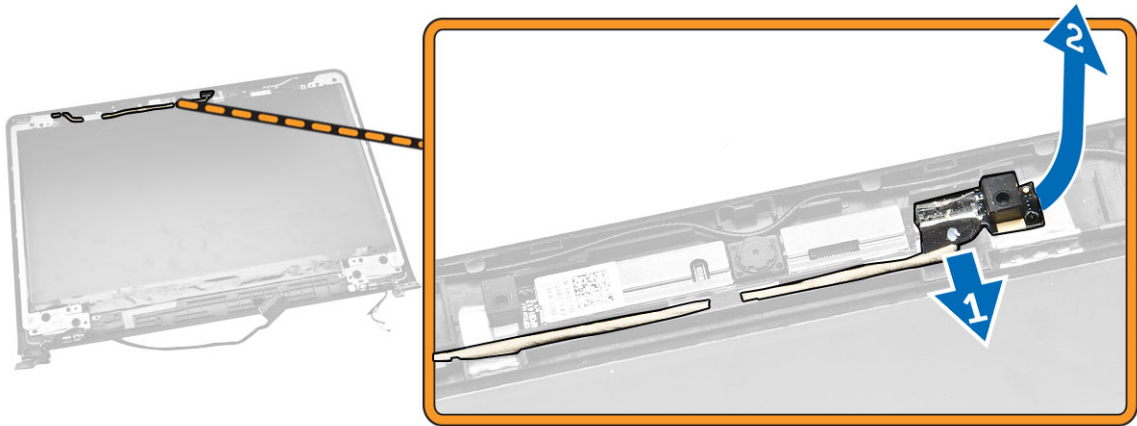

Installing the Camera

1. Connect the camera cable to the connector on the camera module.
2. Align the camera module in its position on the computer.
3. Install:
 - a. [display bezel](#)
 - b. [battery](#)
 - c. [base cover](#)
4. Follow the procedures in [After Working Inside Your computer](#).

Removing the System Board

1. Follow the procedures in [Before Working Inside Your Computer](#).
2. Remove:
 - a. [base cover](#)
 - b. [battery](#)
 - c. [hard drive](#)
 - d. [WLAN card](#)
 - e. [system fan](#)
 - f. [keyboard](#)
 - g. [back cover](#)
 - h. [heatsink](#)
3. Perform the following steps as shown in the illustration:
 - a. Lift the locking tab [1].
 - b. Disconnect the LED and touchpad cables [2].

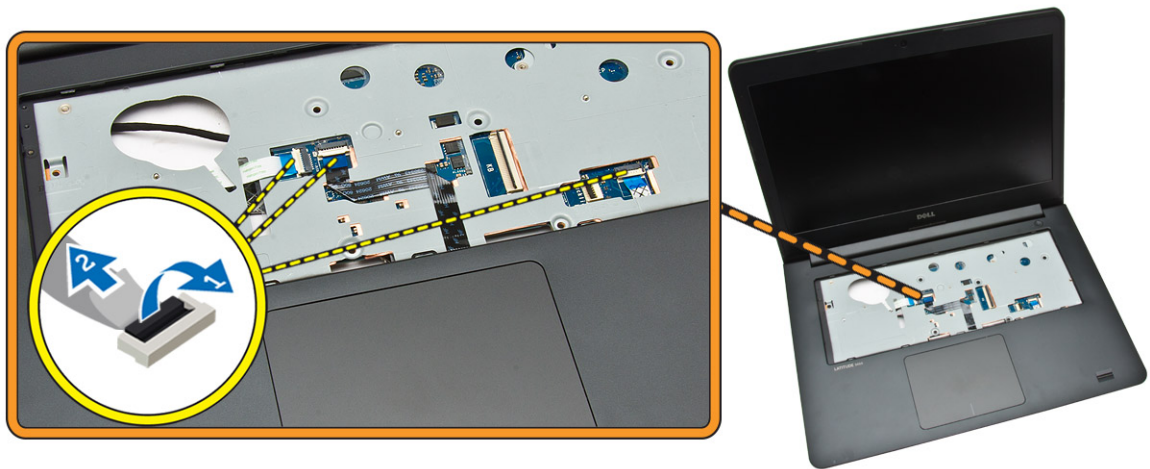

4. Perform the following steps as shown in the illustration:
 - a. Disconnect the speaker cable [1].
 - b. Disconnect the power connector [2].

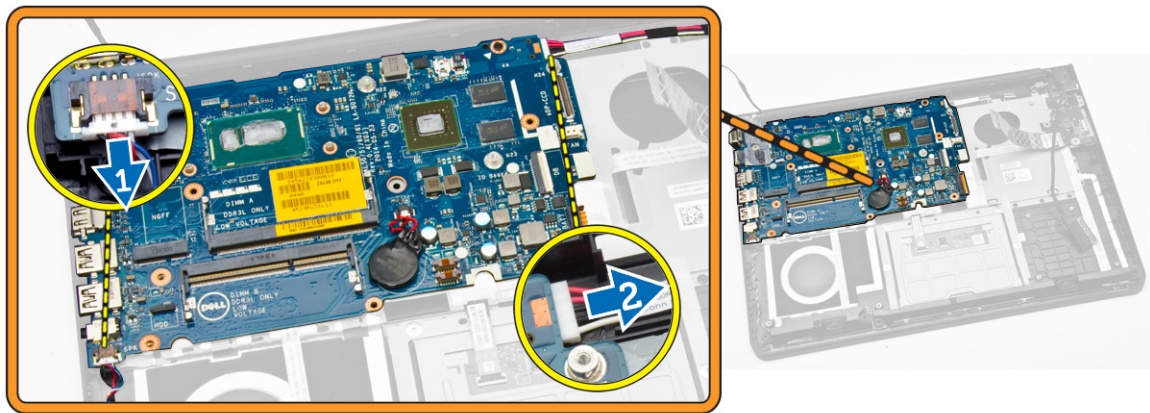

5. Perform the following steps as shown in the illustration:
 - a. Remove the screw that secures the system board to the computer [1].
 - b. Lift the system board [2].

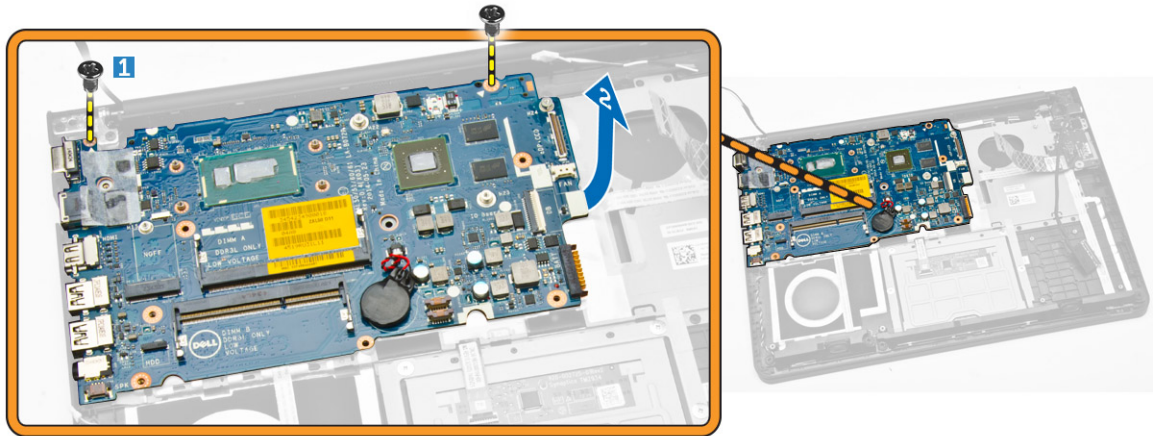

Installing the System Board

1. Install the power connector .
2. Place the system board on the computer.
3. Tighten the screw to secure the system board to the computer.
4. Connect the speaker.
5. Connect the LED and touchpad cables.
6. Press the locking tab.
7. Install:
 - a. [heatsink](#)
 - b. [back cover](#)
 - c. [keyboard](#)
 - d. [system fan](#)
 - e. [WLAN card](#)
 - f. [hard drive](#)
 - g. [battery](#)
 - h. [base cover](#)
8. Follow the procedures in [After Working Inside Your computer](#).

Removing the Speakers

1. Follow the procedures in [Before Working Inside Your Computer](#).
2. Remove:
 - a. [base cover](#)
 - b. [battery](#)
 - c. [hard drive](#)
 - d. [system fan](#)
 - e. [keyboard](#)
 - f. [back cover](#)
3. Perform the following steps as shown in the illustration:
 - a. Disconnect the speaker cables [1].

- b. Unroute the speaker cables [2].

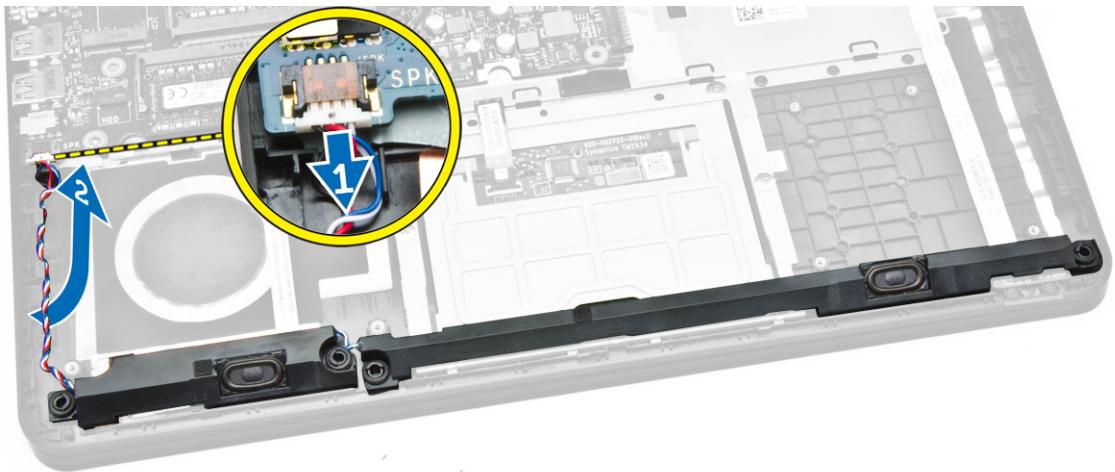

4. Remove the speakers from the computer

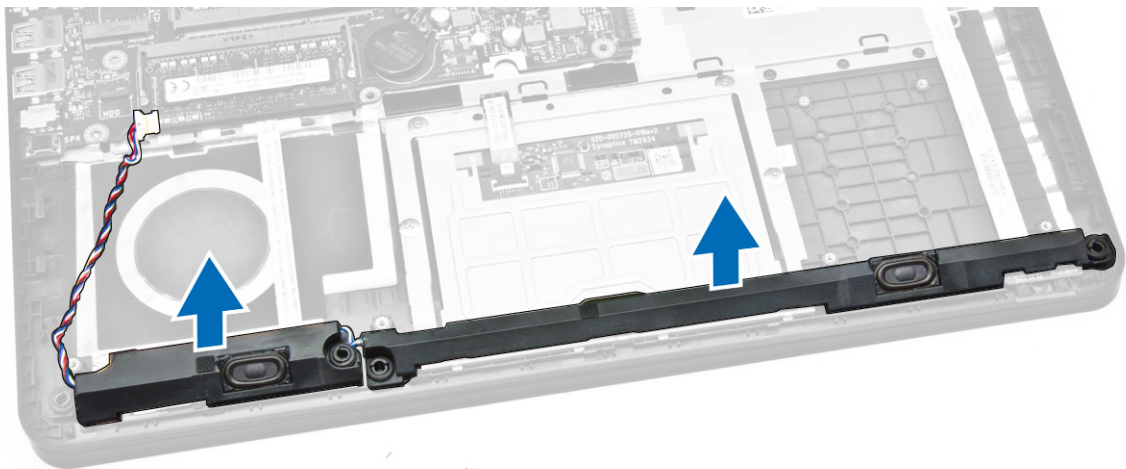

Installing the Speakers

1. Place the speaker in the computer.
2. Route the speaker cables.
3. Connect the speaker cables.
4. Install:
 - a. [base cover](#)
 - b. [keyboard](#)
 - c. [system fan](#)
 - d. [hard drive](#)
 - e. [battery](#)
 - f. [base cover](#)
5. Follow the procedures in [After Working Inside Your computer](#).

Removing the Power Connector

1. Follow the procedures in [Before Working Inside Your Computer](#).
2. Remove:
 - a. [base cover](#)
 - b. [battery](#)
 - c. [hard drive](#)
 - d. [WLAN card](#)
 - e. [system fan](#)
 - f. [keyboard](#)
 - g. [back cover](#)
 - h. [display assembly](#)
 - i. [system board](#)
3. Perform the following steps as shown in the illustration:
 - a. Disconnect the power connector cable [1].
 - b. Unroute the cable [2].

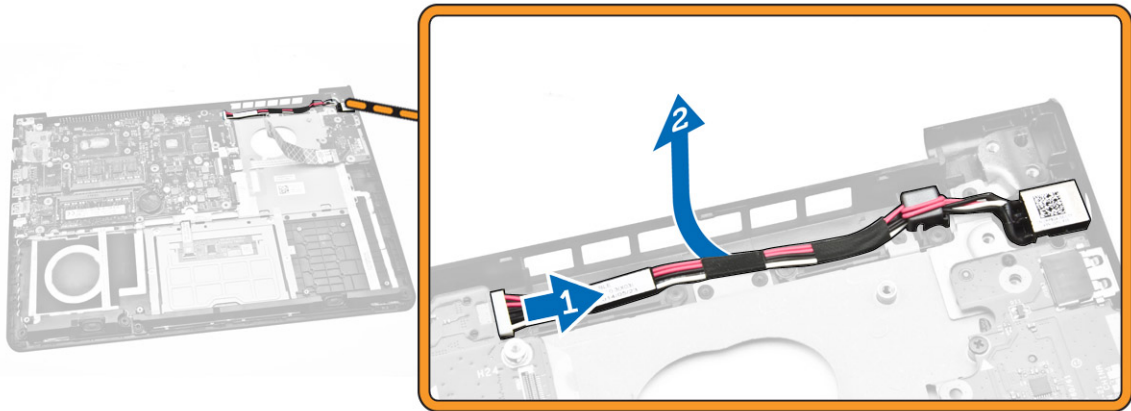

4. Remove the power connector from the computer.



Installing the Power Connector

1. Place the power connector on computer.
2. Route the power cable.
3. Connect the power connector cable.
4. Install:
 - a. [system board](#)
 - b. [display assembly](#)
 - c. [back cover](#)
 - d. [keyboard](#)
 - e. [system fan](#)
 - f. [WLAN card](#)
 - g. [hard drive](#)
 - h. [battery](#)
 - i. [base cover](#)
5. Follow the procedures in [After Working Inside Your computer](#).

System Setup

System Setup enables you to manage your computer hardware and specify BIOS-level options. From the System Setup, you can:

- Change the NVRAM settings after you add or remove hardware
- View the system hardware configuration
- Enable or disable integrated devices
- Set performance and power management thresholds
- Manage your computer security

Boot Sequence

Boot Sequence allows you to bypass the System Setup-defined boot device order and boot directly to a specific device (for example: optical drive or hard drive). During the Power-on Self Test (POST), when the Dell logo appears, you can:

- Access System Setup by pressing <F2> key
- Bring up the one-time boot menu by pressing <F12> key

The one-time boot menu displays the devices that you can boot from including the diagnostic option. The boot-menu options are:

- Removable Drive (if available)
- STXXXX Drive

 **NOTE:** XXX denotes the SATA drive number.

- Optical Drive
- Diagnostics

 **NOTE:** Choosing Diagnostics, will display the **ePSA diagnostics** screen.

The boot sequence screen also displays the option to access the System Setup screen.

Navigation Keys

The following table displays the system setup navigation keys.



 **NOTE:** For most of the system setup options, changes that you make are recorded but do not take effect until you re-start the system.

Table 1. Navigation Keys

Keys	Navigation
Up arrow	Moves to the previous field.
Down arrow	Moves to the next field.
<Enter>	Allows you to select a value in the selected field (if applicable) or follow the link in the field.
Spacebar	Expands or collapses a drop-down list, if applicable.
<Tab>	Moves to the next focus area.
	 NOTE: For the standard graphics browser only.
<Esc>	Moves to the previous page till you view the main screen. Pressing <Esc> in the main screen displays a message that prompts you to save any unsaved changes and restarts the system.
<F1>	Displays the System Setup help file.

System Setup Options

 **NOTE:** Depending on the computer and its installed devices, the items listed in this section may or may not appear.

Table 2. General

Option	Description
System Information	<p>This section lists the primary hardware features of your computer.</p> <ul style="list-style-type: none"> • System Information: Displays BIOS Version, Service Tag, Asset Tag, Ownership Tag, Ownership Date, Manufacture Date, and the Express Service Code. • Memory Information: Displays Memory Installed, Memory Available, Memory Speed, Memory Channels Mode, Memory Technology, DIMM A Size, DIMM B Size, • Processor Information: Displays Processor Type, Core Count, Processor ID, Current Clock Speed, Minimum Clock Speed, Maximum Clock Speed, Processor L2 Cache, Processor L3 Cache, HT Capable, and 64-Bit Technology. • Device Information: Displays Primary Hard Drive, LOM MAC Address, Video Controller, Video BIOS Version, Video Memory, Panel Type, Native Resolution, Audio Controller, Wi-Fi Device, Cellular Device, Bluetooth Device.
Battery Information	Displays the battery status and the type of AC adapter connected to the computer.
Boot Sequence	<p>Boot Sequence</p> <p>Allows you to change the order in which the computer attempts to find an operating system. The options are:</p> <ul style="list-style-type: none"> • Diskette Drive • Internal HDD • USB Storage Device • CD/DVD/CD-RW Drive • Onboard NIC

Option	Description
	By default, all the options are checked. You can also deselect any option or change the boot order.
Boot List Option	Allows you to change the boot list option. <ul style="list-style-type: none"> • Legacy • UEFI
Advanced Boot Options	This option allows you the legacy option ROMs to load. By default, the Enable Legacy Option ROMs is enabled.
Date/Time	Allows you to change the date and time.

Table 3. System Configuration

Option	Description
Integrated NIC	Allows you to configure the integrated network controller. The options are: <ul style="list-style-type: none"> • Disabled • Enabled • Enabled w/PXE: This option is enabled by default.
SATA Operation	Allows you to configure the internal SATA hard-drive controller. The options are: <ul style="list-style-type: none"> • Disabled • AHCI: This option is enabled by default.
Drives	Allows you to configure the SATA drives on board. All drives are enabled by default. The options are: <ul style="list-style-type: none"> • SATA-0: This option is selected by default.
SMART Reporting	This field controls whether hard drive errors for integrated drives are reported during system startup. This technology is part of the SMART (Self Monitoring Analysis and Reporting Technology) specification. This option is disabled by default. <ul style="list-style-type: none"> • Enable SMART Reporting
USB Configuration	This field configures the integrated USB controller. If Boot Support is enabled, the system is allowed to boot any type of USB Mass Storage Devices (HDD, memory key, floppy). If USB port is enabled, device attached to this port is enabled and available for OS. If USB port is disabled, the OS cannot see any device attached to this port. <ul style="list-style-type: none"> • Enable Boot Support • Enable External USB Port • Enable USB3.0 Controller



Option	Description
	 NOTE: USB keyboard and mouse always work in the BIOS setup irrespective of these settings.
Audio	This field enables or disables the integrated audio controller. By default, the Enable Audio option is selected.
Keyboard Illumination	<p>This field lets you choose the operating mode of the keyboard illumination feature.</p> <p>The keyboard brightness level can be set from 0% to 100%</p> <ul style="list-style-type: none"> • Disabled • Dim • Bright <p>This option is disabled by default.</p>
Keyboard Backlight with AC	<p>The Keyboard Backlight with AC option does not affect the main keyboard illumination feature. Keyboard Illumination will continue to support the various illumination levels. This field has an effect when the backlight is enabled.</p> <ul style="list-style-type: none"> • Keyboard Backlight with AC <p>This option is disabled by default.</p>
Unobtrusive Mode	This option, when enabled, pressing Fn+F7 turns off all light and sound emissions in the system. To resume normal operation, press Fn+F7 again. This option is disabled by default.
Miscellaneous Devices	<p>Allows you to enable or disable the following devices:</p> <ul style="list-style-type: none"> • Enable Microphone • Enable Camera • Enable Media Card • Disable Media Card <p> NOTE: All devices are enabled by default.</p> <p>You can also enable or disable Media Card.</p>

Table 4. Video

Option	Description
LCD Brightness	Allows you to set the display brightness depending up on the power source (On Battery and On AC).







 **NOTE:** The Video setting will only be visible when a video card is installed into the system.

Table 5. Security

Option	Description
Admin Password	<p>Allows you to set, change, or delete the administrator (admin) password.</p> <p> NOTE: You must set the admin password before you set the system or hard drive password. Deleting the admin password automatically deletes the system password and the hard drive password.</p> <p> NOTE: Successful password changes take effect immediately.</p> <p>Default Setting: Not set</p>
System Password	<p>Allows you to set, change or delete the system password.</p> <p> NOTE: Successful password changes take effect immediately.</p> <p>Default Setting: Not set</p>
Internal HDD-0 Password	<p>Allows you to set, change or delete the password on the system's internal hard-disk drive.</p> <p> NOTE: Successful password changes take effect immediately.</p> <p>Default Setting: Not set</p>
Strong Password	<p>Allows you to enforce the option to always set strong passwords.</p> <p>Default Setting: Enable Strong Password is not selected.</p> <p> NOTE: If Strong Password is enabled, Admin and System passwords must contain at least one uppercase character, one lowercase character and be at least 8 characters long.</p>
Password Configuration	<p>Allows you to determine the minimum and maximum length of Administrator and System passwords.</p>
Password Bypass	<p>Allows you to enable or disable the permission to bypass the System and the Internal HDD password, when they are set. The options are:</p> <ul style="list-style-type: none"> • Disabled • Reboot bypass <p>Default Setting: Disabled</p>
Password Change	<p>Allows you to enable the disable permission to the System and Hard Drive passwords when the admin password is set.</p> <p>Default Setting: Allow Non-Admin Password Changes is selected.</p>
Non-Admin Setup Changes	<p>Allows you to determine whether changes to the setup options are allowed when an Administrator Password is set. If disabled the setup options are locked by the admin password.</p>
Computrace	<p>Allows you to activate or disable the optional Computrace software The options are:</p> <ul style="list-style-type: none"> • Deactivate

Option	Description
	<ul style="list-style-type: none"> • Disable • Activate <p> NOTE: The Activate and Disable options will permanently activate or disable the feature and no further changes will be allowed</p> <p>Deactivate (default)</p>
CPU XD Support	Allows you to enable the Execute Disable mode of the processor. Enable CPU XD Support (default)
Admin Setup Lockout	Allows you to prevent users from entering Setup when an Administrator password is set. Default Setting: Enable Admin Setup Lockout is not selected.

Table 6. Secure Boot



Option	Description
Secure Boot Enable	<p>This option enables or disables the Secure Boot Feature.</p> <ul style="list-style-type: none"> • Disabled • Enabled <p>Default Setting: The option is enabled.</p>
Expert Key Management	<p>Allows you to manipulate the security key databases only if the system is in Custom Mode. The Enable Custom Mode option is disabled by default. The options are:</p> <ul style="list-style-type: none"> • PK • KEK • db • dbx <p>If you enable the Custom Mode, the relevant options for PK, KEK, db, and dbx appear. The options are:</p> <ul style="list-style-type: none"> • Save to File- Saves the key to a user-selected file • Replace from File- Replaces the current key with a key from a user-selected file • Append from File- Adds a key to the current database from a user-selected file • Delete- Deletes the selected key • Reset All Keys- Resets to default setting • Delete All Keys- Deletes all the keys <p> NOTE: If you disable the Custom Mode, all the changes made will be erased and the keys will restore to default settings.</p>

Table 7. Performance

Option	Description
Multi Core Support	<p>This field specifies whether the process will have one or all cores enabled. The performance of some applications will improve with the additional cores. This option is enabled by default. Allows you to enable or disable multi-core support for the processor. The installed processor supports two cores. If you enable Multi Core Support, two cores will be enabled. If you disable Multi Core Support, one core will be enabled.</p> <ul style="list-style-type: none"> • Enable Multi Core Support <p>Default Setting: The option is enabled.</p>
Intel SpeedStep	<p>Allows you to enable or disable the Intel SpeedStep feature.</p> <ul style="list-style-type: none"> • Enable Intel SpeedStep <p>Default Setting: The option is enabled.</p>
C States Control	<p>Allows you to enable or disable the additional processor sleep states.</p> <ul style="list-style-type: none"> • C states <p>Default Setting: The option is enabled.</p>
Intel TurboBoost	<p>Allows you to enable or disable the Intel TurboBoost mode of the processor.</p> <ul style="list-style-type: none"> • Enable Intel TurboBoost <p>Default Setting: The option is enabled.</p>
Hyper-Thread Control	<p>Allows you to enable or disable the HyperThreading in the processor.</p> <ul style="list-style-type: none"> • Disabled • Enabled <p>Default Setting: The option is enabled.</p>

Table 8. Power Management

Option	Description
AC Behavior	<p>Allows you to enable or disable the computer from turning on automatically when an AC adapter is connected.</p> <p>Default Setting: Wake on AC is not selected.</p>
Auto On Time	<p>Allows you to set the time at which the computer must turn on automatically. The options are:</p> <ul style="list-style-type: none"> • Disabled (default) • Every Day • Weekdays • Select Days

Option	Description
USB Wake Support	<p>Allows you to enable USB devices to wake the system from Standby.</p> <p> NOTE: This feature is only functional when the AC power adapter is connected. If the AC power adapter is removed during Standby, the system setup will remove power from all of the USB ports to conserve battery power.</p> <ul style="list-style-type: none"> • Enable USB Wake Support <p>Default Setting: The option is disabled.</p>
Wireless Radio Control	<p>Allows you to enable or disable the feature that automatically switches from wired or wireless networks without depending on the physical connection.</p> <ul style="list-style-type: none"> • Control WLAN Radio <p>Default Setting: The option is disabled.</p>
Wake on LAN/WLAN	<p>Allows you to enable or disable the feature that powers on the computer from the Off state when triggered by a LAN signal.</p> <ul style="list-style-type: none"> • Disabled: This option is enabled by default • LAN Only • WLAN Only • LAN or WLAN • LAN with PXE Boot
Block Sleep	<p>This option lets you block entering to sleep (S3 state) in Operating System environment.</p> <p>Block Sleep (S3 state) - This option is disabled by default.</p>
Peak Shift	<p>This option enables you to minimize the AC power consumption during the peak power times of day. After you enable this option, your system runs only in battery even if the AC is attached.</p>
Advanced Battery Charge Configuration	<p>This option enables you to maximize the battery health. By enabling this option, your system uses the standard charging algorithm and other techniques, during the non-work hours to improve the battery health.</p> <p>Disabled (default)</p>
Primary Battery Charge Configuration	<p>Allows you to select the charging mode for the battery. The options are:</p> <ul style="list-style-type: none"> • Adaptive (Latitude E5250) • Standard - Fully charges your battery at a standard rate. • ExpressCharge - The battery charges over a shorter period of time using Dell's fast charging technology. This option is enabled by default. • Primarily AC use (Latitude E5250) • Custom (Latitude E5250) <p>If Custom Charge is selected, you can also configure Custom Charge Start and Custom Charge Stop.</p>

Option	Description
	 NOTE: All charging mode may not be available for all the batteries. To enable this option, disable the Advanced Battery Charge Configuration option.

Table 9. POST Behavior

Option	Description
Adapter Warnings	<p>Allows you to enable or disable the system setup (BIOS) warning messages when you use certain power adapters.</p> <p>Default Setting: Enable Adapter Warnings</p>
Keypad (Embedded)	<p>Allows you to choose one of two methods to enable the keypad that is embedded in the internal keyboard.</p> <ul style="list-style-type: none"> • Fn Key Only: This option is enabled by default. • By Numlock
Numlock Enable	<p>Allows you to enable the Numlock option when the computer boots.</p> <p>Enable Network</p> <p>This option is enabled by default.</p>
Fn Key Emulation	<p>Allows you to set the option where the <Scroll Lock> key is used to simulate the <Fn> key feature.</p> <p>Enable Fn Key Emulation (default)</p>
Fn Lock Hot Key	<p>Allows the hot key combination <Fn> +<Esc> toggle the primary behavior of F1–F12, between the standard and secondary functions.</p> <ul style="list-style-type: none"> • Lock Mode Disable/Standard. This option is enabled by default. • Lock Mode Enable/Secondary
Fastboot	<p>Allows you to speed up the boot process by bypassing some of the compatibility steps. The options are:</p> <ul style="list-style-type: none"> • Minimal • Thorough (default) • Auto
Extended BIOS POST Time	<p>Allows you to create an additional pre-boot delay. The options are:</p> <ul style="list-style-type: none"> • 0 seconds. This option is enabled by default. • 5 seconds • 10 seconds

Table 10. Virtualization Support

Option	Description
Virtualization	Allows you to enable or disable the Intel Virtualization Technology.

Option	Description
	<ul style="list-style-type: none"> • Enable Intel Virtualization Technology (default)

Table 11. Wireless

Option	Description
Wireless Switch	<p>Allows to set the wireless devices that can be controlled by the wireless switch. The options are:</p> <ul style="list-style-type: none"> • WLAN • Bluetooth <p>All the options are enabled by default.</p>
Wireless Device Enable	<p>Allows you to enable or disable the internal wireless devices.</p> <ul style="list-style-type: none"> • WLAN • Bluetooth <p>All the options are enabled by default.</p>

Table 12. Maintenance

Option	Description
Service Tag	Displays the Service Tag of your computer.
Asset Tag	Allows you to create a system asset tag if an asset tag is not already set. This option is not set by default.

Table 13. System Logs

Option	Description
BIOS Events	Allows you to view and clear the System Setup (BIOS) POST events.
Thermal Events	Allows you to view and clear the System Setup (Thermal) events.
Power Events	Allows you to view and clear the System Setup (Power) events.

Updating the BIOS

It is recommended to update your BIOS (system setup), on replacing the system board or if an update is available. For laptops, ensure that your computer battery is fully charged and connected to a power outlet

1. Re-start the computer.
2. Go to dell.com/support.
3. Enter the **Service Tag** or **Express Service Code** and click **Submit**.



NOTE: To locate the Service Tag, click **Where is my Service Tag?**

 **NOTE:** If you cannot find your Service Tag, click **Detect My Product**. Proceed with the instructions on screen.

4. If you are unable to locate or find the Service Tag, click the Product Category of your computer.
5. Choose the **Product Type** from the list.
6. Select your computer model and the **Product Support** page of your computer appears.
7. Click **Get drivers** and click **View All Drivers**.
The Drivers and Downloads page opens.
8. On the Drivers and Downloads screen, under the **Operating System** drop-down list, select **BIOS**.
9. Identify the latest BIOS file and click **Download File**.
You can also analyze which drivers need an update. To do this for your product, click **Analyze System for Updates** and follow the instructions on the screen.
10. Select your preferred download method in the **Please select your download method below window**; click **Download File**.
The **File Download** window appears.
11. Click **Save** to save the file on your computer.
12. Click **Run** to install the updated BIOS settings on your computer.
Follow the instructions on the screen.

System and Setup Password

You can create a system password and a setup password to secure your computer.

Password Type	Description
System password	Password that you must enter to log on to your system.
Setup password	Password that you must enter to access and make changes to the BIOS settings of your computer.

 **CAUTION:** The password features provide a basic level of security for the data on your computer.

 **CAUTION:** Anyone can access the data stored on your computer if it is not locked and left unattended.

 **NOTE:** Your computer is shipped with the system and setup password feature disabled.

Assigning a System Password and Setup Password

You can assign a new **System Password** and/or **Setup Password** or change an existing **System Password** and/or **Setup Password** only when **Password Status** is **Unlocked**. If the Password Status is **Locked**, you cannot change the System Password.

 **NOTE:** If the password jumper is disabled, the existing System Password and Setup Password are deleted and you need not provide the system password to log on to the computer.

To enter a system setup, press <F2> immediately after a power-on or re-boot.

1. In the **System BIOS** or **System Setup** screen, select **System Security** and press <Enter>.
The **System Security** screen appears.
2. In the **System Security** screen, verify that **Password Status** is **Unlocked**.
3. Select **System Password**, enter your system password, and press <Enter> or <Tab>.

Use the following guidelines to assign the system password:

- A password can have up to 32 characters.
- The password can contain the numbers 0 through 9.
- Only lower case letters are valid, upper case letters are not allowed.
- Only the following special characters are allowed: space, ("), (+), (,), (-), (.), (/), (:), (|), (\), (|), (').

Re-enter the system password when prompted.

4. Type the system password that you entered earlier and click **OK**.
5. Select **Setup Password**, type your system password and press <Enter> or <Tab>. A message prompts you to re-type the setup password.
6. Type the setup password that you entered earlier and click **OK**.
7. Press <Esc> and a message prompts you to save the changes.
8. Press <Y> to save the changes.
The computer reboots.

Deleting or Changing an Existing System and/or Setup Password

Ensure that the **Password Status** is Unlocked (in the System Setup) before attempting to delete or change the existing System and/or Setup password. You cannot delete or change an existing System or Setup password, if the **Password Status** is Locked.

To enter the System Setup, press <F2> immediately after a power-on or reboot.

1. In the **System BIOS** or **System Setup** screen, select **System Security** and press <Enter>. The **System Security** screen is displayed.
2. In the **System Security** screen, verify that **Password Status** is **Unlocked**.
3. Select **System Password**, alter or delete the existing system password and press <Enter> or <Tab>.
4. Select **Setup Password**, alter or delete the existing setup password and press <Enter> or <Tab>.
 **NOTE:** If you change the System and/or Setup password, re-enter the new password when prompted. If you delete the System and/or Setup password, confirm the deletion when prompted.
5. Press <Esc> and a message prompts you to save the changes.
6. Press <Y> to save the changes and exit from the System Setup.
The computer reboots.

Diagnostics

If you experience a problem with your computer, run the ePSA diagnostics before contacting Dell for technical assistance. The purpose of running diagnostics is to test your computer's hardware without requiring additional equipment or risking data loss. If you are unable to fix the problem yourself, service and support personnel can use the diagnostics results to help you solve the problem.

Enhanced Pre-Boot System Assessment (ePSA) Diagnostics

The ePSA diagnostics (also known as system diagnostics) performs a complete check of your hardware. The ePSA is embedded with the BIOS and is launched by the BIOS internally. The embedded system diagnostics provides a set of options for particular devices or device groups allowing you to:

- Run tests automatically or in an interactive mode
- Repeat tests
- Display or save test results
- Run thorough tests to introduce additional test options to provide extra information about the failed device(s)
- View status messages that inform you if tests are completed successfully
- View error messages that inform you of problems encountered during testing





CAUTION: Use the system diagnostics to test only your computer. Using this program with other computers may cause invalid results or error messages.



NOTE: Some tests for specific devices require user interaction. Always ensure that you are present at the computer terminal when the diagnostic tests are performed.

1. Power-on the computer.
2. As the computer boots, press the <F12> key as the Dell logo appears.
3. On the boot menu screen, select the **Diagnostics** option.
The **Enhanced Pre-boot System Assessment** window is displayed, listing all devices detected in the computer. The diagnostics starts running the tests on all the detected devices.
4. If you wish to run a diagnostic test on a specific device, press <Esc> and click **Yes** to stop the diagnostic test.
5. Select the device from the left pane and click **Run Tests**.
6. If there are any issues, error codes are displayed.
Note the error code and contact Dell.

Device Status Lights

Icon	Description
	Turns on when you turn on the computer and blinks when the computer is in a power management mode.
	Turns on steadily or blinks to indicate battery charge status.

Battery Status Lights

If the computer is connected to an electrical outlet, the battery light operates as follows:

Alternately blinking amber light and white light	An unauthenticated or unsupported non-Dell AC adapter is attached to your laptop.
Alternately blinking amber light with steady white light	Temporary battery failure with AC adapter present.
Constantly blinking amber light	Fatal battery failure with AC adapter present.
Light off	Battery in full charge mode with AC adapter present.
White light on	Battery in charge mode with AC adapter present.

Specifications



 **NOTE:** Offerings may vary by region. For more information regarding the configuration of your computer, click Start  (**Start icon**) → **Help and Support**, and then select the option to view information about your computer.

Table 14. System Information

Feature	Description
DRAM bus width	64 bits
Flash EPROM	8 MB

Table 15. Processor

Feature	Description
Type	Intel Core i3 and i5
L1 cache	64 KB
L2 cache	256 KB
L3 cache	Up to 4 MB

Table 16. Memory

Feature	Description
Memory connector	two internally accessible DDR3L connectors
Memory capacity	2 GB ,4 GB, and 8 GB
Memory type	1600 MHz (dual channel DDR3L configuration)
Minimum memory	2 GB
Maximum memory	16 GB (8x2) GB

Table 17. Audio

Feature	Description
Type	4 channel high definition audio
Controller	Realtek ALC3234
Stereo conversion	24-bit (analog-to-digital and digital-to-analog)
Interface	Intel HDA bus
Speakers	2 W x 2 W

Feature	Description
Volume controls	program menu and keyboard media-control keys

Table 18. Video

Feature	Description
Video type	Integrated on system board / discrete
Video controller:	
UMA	Intel HD Graphics 4400 (shared memory)
Discrete	
Latitude 3450	NVIDIA GeForce Nvidia GeForce 830M (2GB DDR3)
Latitude 3550	NVIDIA GeForce Nvidia GeForce 830M (2GB DDR3)
Data bus:	
Latitude 3450	64 bits
Latitude 3550	64 bits

Table 19. Camera

Feature	Description
Camera resolution	0.92 megapixels
Video resolution (maximum)	1280 x 720 (HD) at 30 fps (maximum)
Diagonal viewing angle	66°

Table 20. Communication

Feature	Description
Network adapter	10/100/1000 Mbps Ethernet LAN on Motherboard (LOM)
Wireless	<ul style="list-style-type: none"> • Wi-Fi 802.11 b/g/n and 802.11a/b/g/n/ac • Bluetooth 4.0

Table 21. Ports and Connectors

Feature	Description
Audio	one headphone/microphone combo port (headset)
Video	one 15-pin VGA port one 19-pin HDMI port
Network adapter	one RJ-45 port
USB:	
Latitude 3450	<ul style="list-style-type: none"> • two USB 3.0 ports (rear one with window debug) • one USB 2.0 port

Feature	Description
Latitude 3550	<ul style="list-style-type: none"> two USB 3.0 ports (rear one with window debug) two USB 2.0 ports
 NOTE:	The powered USB 3.0 connector also supports Microsoft Kernel Debugging. The ports are identified in the documentation shipped with your computer.
Media card reader	one 3-in-1 slot
Memory Card Reader	one (SD, SDHC, SDXC, MS, MS Pro)
Fingerprint Reader	one (optional)

Table 22. Display

Feature	Latitude 3450	Latitude 3550
Type	14.0 inches HD WLED	15.6 inches HD WLED
Height	205.60 mm	360 mm
Width	320.90 mm	224.3 mm
Diagonal	14.0 inches	15.6 inches
Active area (X/Y)	309.40 mm x 173.95 mm (12.18 inches x 6.85 inches)	344.23 x 193.54 mm (13.55 inches x 7.61 inches)
Maximum resolution	1366 x 768 pixels	1366 x 768 pixels
Maximum brightness	200 nits	200 nits
Operating angle	0° (closed) to Min 135°	0° (closed) to Min 135°
Refresh rate	60 Hz	60 Hz
Minimum viewing angles:		
Horizontal	40°/40°	40°/40°
Vertical	10°/30°	10°/30°
Pixel pitch	0.265 mm x 0.265 mm	0.252 mm x 0.252 mm
External display		VGA

Table 23. Keyboard

Feature	Description
Number of keys:	
Latitude 3450	US 80, Brazil 82, UK 81, and Japan 84
Latitude 3550	US 101, Brazil 104, UK 102, and Japan 105

Table 24. Touchpad

Feature	Description
X-axis	102.4 mm (4.03 inches)
Y-axis	7.4 mm (3.04 inches)

Table 25. Battery

Feature	Description
Type	<ul style="list-style-type: none"> 3-cell "smart" lithium ion (43 WHr) 4-cell "smart" lithium ion (58 WHr)
Dimensions:	
Height	<ul style="list-style-type: none"> 3-cell – 7.8 mm 4-cell – 7.8 mm
Width	<ul style="list-style-type: none"> 3-cell – 124.7 mm 4-cell – 124.7 mm
Depth	<ul style="list-style-type: none"> 3-cell – 208.25 mm 4-cell – 208.25 mm
Weight	<ul style="list-style-type: none"> 3-cell – 283 g 4-cell – 350 g
Lifespan	300 discharge/charge cycles
Voltage	<ul style="list-style-type: none"> 3-cell – 11.1 VDC 4-cell – 7.4 VDC
Temperature range:	
Operating	0 °C to 50 °C (32 °F to 122 °F)
Non-Operating	-20 °C to 65 °C (-4 °F to 149 °F)
Coin-cell battery	3 V CR2032 lithium ion

Table 26. AC Adapter

Feature	Description
Type	65 W and 90 W
Input voltage	100 VAC to 240 VAC
Input current (maximum)	1.50 A/1.60 A/1.70 A/2.50 A
Input frequency	50 Hz–60 Hz
Output power	65 W/90 W
Output current	3.34 A/4.62 A
Rated output voltage	19.50 VDC

Feature	Description
Temperature range:	
Operating	0 °C to 40 °C (32 °F to 104 °F)
Non-Operating	-40 °C to 70 °C (-40 °F to 158 °F)

Table 27. Physical

Physical	Latitude 3450	Latitude 3550
Height:		
Non-touchscreen	22.2 mm (0.87 inches)	22.3 mm (0.88 inches)
Touchscreen	23.0 mm (0.90 inches)	23.2 mm (0.91 inches)
Width:		
Non-touchscreen	245.9 mm (9.68 inches)	258.95 mm (10.19 inches)
Touchscreen	246.1 mm (9.69 inches)	259.2 mm (10.20 inches)
Depth:		
Non-touchscreen	342 mm (13.46 inches)	380.4 mm (14.98 inches)
Touchscreen	342 mm (13.46 inches)	380.4 mm (14.98 inches)
Weight (minimum):		
Non-touchscreen	1.89 kg (4.18 lb)	2.15 kg (4.75 lb)
Touchscreen	2.04 kg (4.51 lb)	2.36 kg (5.21 lb)

Table 28. Environmental

Feature	Description
Temperature:	
Operating	0 °C to 35 °C (32 °F to 95 °F)
Storage	-40 °C to 65 °C (-40 °F to 149 °F)
Relative humidity (maximum):	
Operating	10 % to 90 % (non-condensing)
Storage	10 % to 95 % (non-condensing)
Altitude (maximum):	
Operating	-15.2 m to 3048 m (-50 to 10,000 ft) 0° to 35°C
Non-Operating	-15.2 m to 10,668 m (-50 ft to 35,000 ft)
Airborne contaminant level	G1 as defined by ISA-S71.04-1985

Contacting Dell

 **NOTE:** If you do not have an active Internet connection, you can find contact information on your purchase invoice, packing slip, bill, or Dell product catalog.

Dell provides several online and telephone-based support and service options. Availability varies by country and product, and some services may not be available in your area. To contact Dell for sales, technical support, or customer service issues:

1. Go to **dell.com/support**.
2. Select your support category.
3. Verify your country or region in the **Choose a Country/Region** drop-down list at the bottom of the page.
4. Select the appropriate service or support link based on your need.