

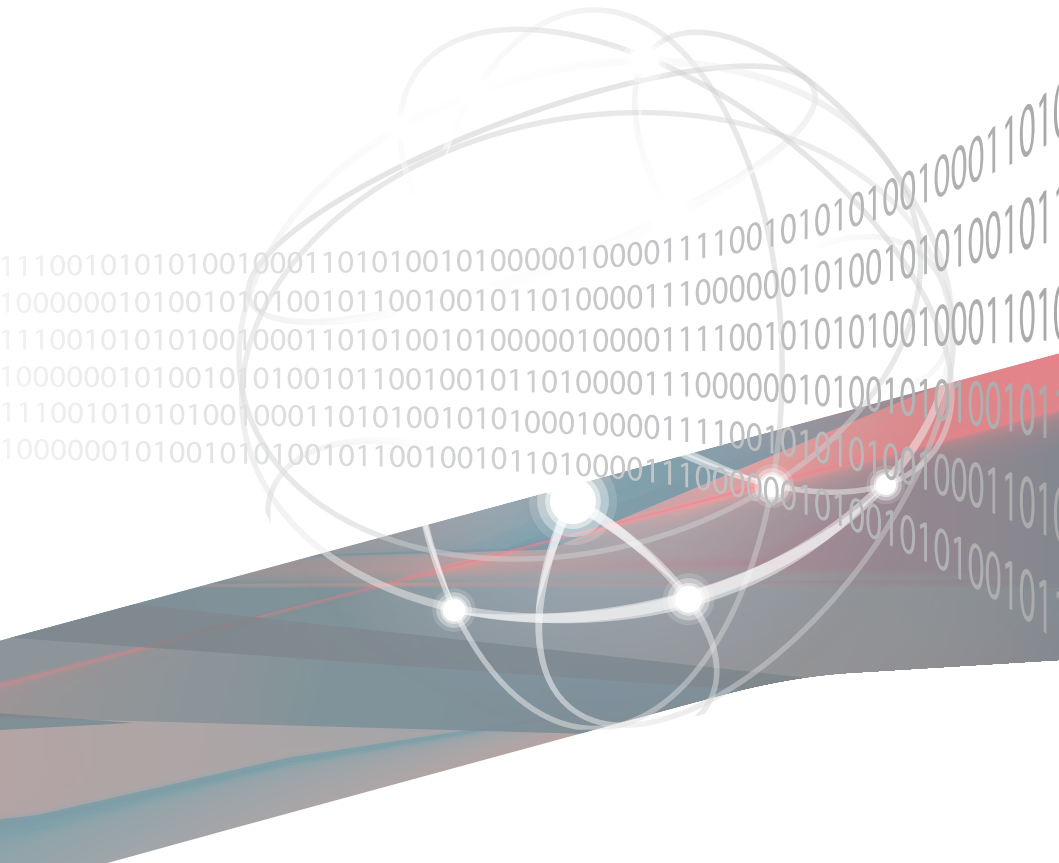

RS520A-E11-RS24U

2U Rackmount Server User Guide



E18706
Revised Edition V2
July 2021

Copyright © 2021 ASUSTeK COMPUTER INC. All Rights Reserved.

No part of this manual, including the products and software described in it, may be reproduced, transmitted, transcribed, stored in a retrieval system, or translated into any language in any form or by any means, except documentation kept by the purchaser for backup purposes, without the express written permission of ASUSTeK COMPUTER INC. ("ASUS").

ASUS provides this manual "as is" without warranty of any kind, either express or implied, including but not limited to the implied warranties or conditions of merchantability or fitness for a particular purpose. In no event shall ASUS, its directors, officers, employees, or agents be liable for any indirect, special, incidental, or consequential damages (including damages for loss of profits, loss of business, loss of use or data, interruption of business and the like), even if ASUS has been advised of the possibility of such damages arising from any defect or error in this manual or product.

Specifications and information contained in this manual are furnished for informational use only, and are subject to change at any time without notice, and should not be construed as a commitment by ASUS. ASUS assumes no responsibility or liability for any errors or inaccuracies that may appear in this manual, including the products and software described in it.

Product warranty or service will not be extended if: (1) the product is repaired, modified or altered, unless such repair, modification or alteration is authorized in writing by ASUS; or (2) the serial number of the product is defaced or missing.

Products and corporate names appearing in this manual may or may not be registered trademarks or copyrights of their respective companies, and are used only for identification or explanation and to the owners' benefit, without intent to infringe.

Contents

Safety information.....	vii
About this guide.....	ix

Chapter 1: Product Introduction

1.1	System package contents.....	1-2
1.2	Serial number label.....	1-3
1.3	System specifications	1-4
1.4	Front panel features.....	1-7
1.5	Rear panel features.....	1-7
1.6	Internal features	1-8
1.7	LED information	1-9
1.7.1	Front panel LEDs	1-9
1.7.2	Storage device status LED.....	1-10
1.7.3	LAN (RJ-45) LEDs	1-11
1.7.4	Rear panel LEDs.....	1-11
1.7.5	Q-Code table.....	1-12

Chapter 2: Hardware Information

2.1	Chassis cover.....	2-2
2.1.1	Removing the rear cover.....	2-2
2.1.2	Removing the mid cover	2-3
2.2	Air ducts.....	2-4
2.2.1	Removing the air ducts	2-4
2.2.2	Installing the air ducts	2-4
2.3	Central Processing Unit (CPU)	2-5
2.3.1	Installing the CPU and heatsink.....	2-5
2.4	System memory	2-10
2.4.1	Overview	2-10
2.4.2	Memory Configurations.....	2-10
2.4.3	Installing a DIMM	2-11
2.4.4	Removing a DIMM	2-11
2.5	Storage devices.....	2-12
2.5.1	Installing a 2.5" hot-swap SATA/SAS/NVMe storage device....	2-12
2.6	Expansion slot.....	2-14
2.6.1	Installing an expansion card to the left PCIe riser card bracket (on selected models).....	2-15
2.6.2	Installing an expansion card to the right PCIe riser card bracket (on selected models).....	2-18

Contents

- 2.6.3 Installing a ASUS PIKE II card to the right PCIe riser card bracket 2-22
- 2.6.4 Installing an OCP 3.0 card to the OCP 3.0 slot 2-24
- 2.6.5 Installing an M.2 (NGFF) card 2-25
- 2.6.6 Configuring an expansion card 2-27
- 2.7 Cable connections 2-28**
- 2.8 Backplane cabling 2-29**
- 2.9 Storage device configuration and cabling 2-30**
 - 2.9.1 24 x NVMe storage device configuration and cabling (on selected models) 2-31
 - 2.9.2 16 x NVMe and 8 x SAS/SATA storage device configuration and cabling 2-33
 - 2.9.3 12 x NVMe and 12 x SAS/SATA storage device configuration and cabling 2-35
- 2.10 Removable/optional components 2-37**
 - 2.10.1 System fans 2-37
 - 2.10.2 Redundant power supply module 2-39

Chapter 3: Installation Options

- 3.1 Tool-less Friction Rail Kit 3-2**
 - 3.1.1 Installing the tool-less rack rail 3-2
 - 3.1.2 Rail kit dimensions 3-4
- 3.2 Ball bearing Rail Kit 3-5**
 - 3.2.1 Attaching the rack rails 3-6
- 3.3 Cable management arm (optional for 1200 mm rack rails) 3-11**
 - 3.3.1 Attaching the cable management arm 3-11

Chapter 4: Motherboard Information

- 4.1 Motherboard layout 4-2**
- 4.2 Jumpers 4-4**
- 4.3 Internal LEDs 4-9**
- 4.4 Internal connectors 4-11**

Chapter 5: BIOS Setup

- 5.1 Managing and updating your BIOS 5-2**
 - 5.1.1 ASUS CrashFree BIOS 3 utility 5-2
 - 5.1.2 ASUS EZ Flash Utility 5-3
 - 5.1.3 BUPDATER utility 5-4

Contents

5.2	BIOS setup program	5-6
5.2.1	BIOS menu screen.....	5-7
5.2.2	Menu bar	5-7
5.2.3	Menu items.....	5-8
5.2.4	Submenu items	5-8
5.2.5	Navigation keys.....	5-8
5.2.6	General help.....	5-8
5.2.7	Configuration fields	5-8
5.2.8	Pop-up window.....	5-8
5.2.9	Scroll bar	5-8
5.3	Main menu	5-9
5.3.1	System Language [English]	5-9
5.3.2	System Date [Day xx/xx/xxxx].....	5-9
5.3.3	System Time [xx:xx:xx]	5-9
5.4	Performance Tuning menu	5-10
5.5	Advanced menu	5-11
5.5.1	Trusted Computing.....	5-12
5.5.2	PSP Firmware Versions	5-12
5.5.3	Redfish Host Interface Settings.....	5-12
5.5.4	APM Configuration	5-13
5.5.5	Onboard LAN Configuration	5-13
5.5.6	Serial Port Console Redirection	5-14
5.5.7	CPU Configuration	5-17
5.5.8	PCI Subsystem Settings	5-17
5.5.9	USB Configuration	5-18
5.5.10	Network Stack Configuration.....	5-19
5.5.11	CSM Configuration.....	5-20
5.5.12	NVMe Configuration.....	5-21
5.5.13	SATA Configuration	5-22
5.5.14	AMD Mem Configuration Status.....	5-22
5.6	Chipset menu	5-23
5.7	Security menu	5-26
5.8	Boot menu	5-30
5.9	Tool menu	5-31
5.10	Save & Exit menu	5-32

Contents

- 5.11 AMD CBS menu.....5-33**
 - 5.11.1 CPU Common Options..... 5-34
 - 5.11.2 DF Common Options 5-39
 - 5.11.3 UMC Common Option..... 5-42
 - 5.11.4 NBIO Common Options 5-53
 - 5.11.5 FCH Common Options..... 5-60
 - 5.11.6 NTB Common Options 5-65
 - 5.11.7 Soc Miscellaneous Control..... 5-67
 - 5.11.8 Workload Tuning..... 5-68
- 5.12 Event Logs menu 5-69**
 - 5.12.1 Change Smbios Event Log Settings 5-69
 - 5.12.2 View Smbios Event Log 5-70
- 5.13 Server Mgmt menu..... 5-71**

Chapter 6: Driver Installation

- 6.1 Running the Support DVD..... 6-2**

Appendix

- KMPA-U16 block diagram A-2**
- Notices A-3**
- Service and Support A-7**

Safety information

Electrical Safety

- Before installing or removing signal cables, ensure that the power cables for the system unit and all attached devices are unplugged.
- To prevent electrical shock hazard, disconnect the power cable from the electrical outlet before relocating the system.
- When adding or removing any additional devices to or from the system, ensure that the power cables for the devices are unplugged before the signal cables are connected. If possible, disconnect all power cables from the existing system before you add a device.
- If the power supply is broken, do not try to fix it by yourself. Contact a qualified service technician or your dealer.

Operation Safety

- Any mechanical operation on this server must be conducted by certified or experienced engineers.
- Before operating the server, carefully read all the manuals included with the server package.
- Before using the server, ensure all cables are correctly connected and the power cables are not damaged. If any damage is detected, contact your dealer as soon as possible.
- To avoid short circuits, keep paper clips, screws, and staples away from connectors, slots, sockets and circuitry.
- Avoid dust, humidity, and temperature extremes. Place the server on a stable surface.
- If you encounter technical problems with the product, contact a qualified service technician or your retailer.



This product is equipped with a three-wire power cable and plug for the user's safety. Use the power cable with a properly grounded electrical outlet to avoid electrical shock.

Lithium-Ion Battery Warning

CAUTION! Danger of explosion if battery is incorrectly replaced. Replace only with the same or equivalent type recommended by the manufacturer. Dispose of used batteries according to the manufacturer's instructions.

Heavy System

CAUTION! This server system is heavy. Ask for assistance when moving or carrying the system.

Optical Drive Safety Information

Laser Safety Information



To prevent exposure to the optical drive's laser, do not attempt to disassemble or repair the optical drive by yourself. For your safety, contact a professional technician for assistance.

About this guide

Audience

This user guide is intended for system integrators, and experienced users with at least basic knowledge of configuring a server.

Contents

This guide contains the following parts:

1. Chapter 1: Product Introduction

This chapter describes the general features of the server, including sections on front panel and rear panel specifications.

2. Chapter 2: Hardware Information

This chapter lists the hardware setup procedures that you have to perform when installing or removing system components.

3. Chapter 3: Installation Options

This chapter describes how to install optional components into the barebone server.

4. Chapter 4: Motherboard Information

This chapter gives information about the motherboard that comes with the server. This chapter includes the motherboard layout, jumper settings, and connector locations.

5. Chapter 5: BIOS Setup

This chapter tells how to change system settings through the BIOS Setup menus and describes the BIOS parameters.

6. Chapter 6: Driver Installation

This chapter provides instructions for installing the necessary drivers for different system components.

Conventions

To ensure that you perform certain tasks properly, take note of the following symbols used throughout this manual.



DANGER/WARNING: Information to prevent injury to yourself when trying to complete a task.



CAUTION: Information to prevent damage to the components when trying to complete a task.



IMPORTANT: Instructions that you **MUST** follow to complete a task.



NOTE: Tips and additional information to help you complete a task.

Typography

Bold text

Indicates a menu or an item to select.

Italics

Used to emphasize a word or a phrase.

<Key>

Keys enclosed in the less-than and greater-than sign means that you must press the enclosed key.

Example: <Enter> means that you must press the Enter or Return key.

<Key1>+<Key2>+<Key3>

If you must press two or more keys simultaneously, the key names are linked with a plus sign (+).

Example: <Ctrl>+<Alt>+

Command

Means that you must type the command exactly as shown, then supply the required item or value enclosed in brackets.

Example: At the DOS prompt, type the command line:
format A: /S

References

Refer to the following sources for additional information, and for product and software updates.

1. **ASUS Control Center (ACC) user guide**

This manual tells how to set up and use the proprietary ASUS server management utility. Visit asuscontrolcenter.asus.com for more information.

2. **ASUS websites**

The ASUS websites provide updated information for all ASUS hardware and software products. Visit <https://www.asus.com> for more information.

Product Introduction

1

This chapter describes the general features of the chassis kit. It includes sections on front panel and rear panel specifications.

1.1 System package contents

Check your system package for the following items.

Model Name	RS520A-E11-RS24U
Chassis	ASUS R2P-C 2U Rackmount Chassis
Motherboard	ASUS KMPA-U16 Server Board
Component	1+1 800W 80PLUS Platinum or 850W 80PLUS Titanium or 1200W 80PLUS Platinum Redundant Power Supply 1 x 2.5-inch Storage Device Backplane 24 x 2.5-inch Storage Device Trays or Dummy Trays 4 x System Fans (80 mm x 80 mm x 38 mm)
Accessories	1 x AMD EPYC™ Support DVD 1 x Bag of Screws 1 x CPU Heatsink 2 x AC Power Cable
Optional Items	1 x 800W 80PLUS Platinum Power Supply or 1 x 850W 80PLUS Titanium Power Supply or 1 x 1200W 80PLUS Platinum Power Supply (Second PSU) 2 x Riser card (16 NVMe configuration & 12 NVMe configuration) System redundant fan kit 1 x Friction Rail Kit or Ball-bearing rail kit ASUS PIKE II 3008/3108 card



If any of the above items is damaged or missing, contact your retailer.

1.2 Serial number label

The product's serial number contains 12 characters such as xxSxxxxxxx and printed on the sticker at the server's front cover.

The correct serial number of the product is required if you need to request for support from the ASUS Technical Support team.

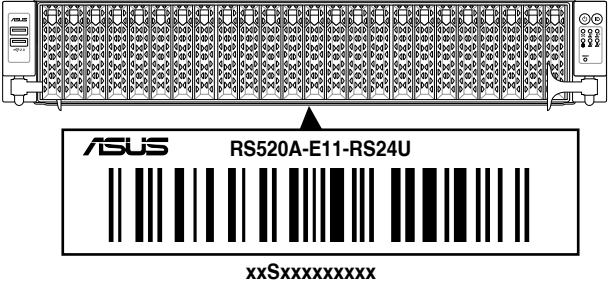

1.3 System specifications

The ASUS RS520A-E11-RS24U features the ASUS KMPA-U16 server board. The server supports AMD EPYC™ 7002/7003 Series processors plus other latest technologies through the chipsets onboard.

Model Name		RS520A-E11-RS24U
Motherboard		KMPA-U16
Processor Support		1 x Socket SP3 (LGA 4094) AMD EPYC™ 7002/7003 Series xGMI (External Global Memory Interface Link)
Core Logic		System on Chip (SoC)
Memory	Total Slots	16 (8-channel per CPU, 16 DIMM per CPU)
	Capacity	Maximum up to 4096GB
	Memory Type	DDR4 3200/2933 RDIMM/LRDIMM/3DS LRDIMM * Please refer to www.asus.com for latest memory AVL update
	Memory Size	64GB, 32GB, 16GB RDIMM 64GB, 128GB LRDIMM 64GB, 128GB, 256GB (LRDIMM 3DS/ 3DS RDIMM) * Refer to www.asus.com/support for more information
Expansion Slots	Total PCI/PCIe/ PIKE Slots	Up to 5
	Slot Type	<u>24 x NVMe</u> 1 x PCIe x16 slot (Gen4 x8 link, LP)(CPU1) (GPU card support limited)
		<u>16 x NVMe or 12 x NVMe</u> Up to 5 PCIe Gen4 slots + 1 OCP3.0 2 x PCIe x16 slot (Gen4 x16 link, FHFL)(CPU1) or Dual-slot GPU cards or 4 x PCIe x16 slot (Gen4 x8 link, FHFL)(CPU1) 1 x PCIe x16 slot (Gen4 x8 link, LP)(CPU1) 1 x OCP 3.0 Mezzanine slot (CPU1)
		M.2
	Micro SD Card slot	1
	Proprietary Slot 1	1 x PCIe x16 slot (Gen4 x8 link, for pike card only)
	Proprietary Slot 2	-
Storage	SATA Controller	Integrated in CPU
	SAS Controller	<u>Optional kits:</u> ASUS PIKE II 3008 8-port SAS 12Gb/s HBA card ASUS PIKE II 3108 8-port SAS HW 12Gb/s RAID card

(continued on the next page)

Model Name		RS520A-E11-RS24U
Storage Bays	Front Storage Bays	24 x 2.5" hot-swap drive bays - 24 x NVMe or - 16 x NVMe + 8x SAS/SATA(from pike card) or - 12 x NVMe + 12x SAS/SATA * SAS support only from optional SAS HBA/RAID card
Networking		1 x Dual Port Intel® I350-AM2 Gigabit LAN controller 1 x Management Port Optional OCP Adapter: Up to 100Gb/s Ethernet / InfiniBand Adapter
VGA		Aspeed AST2600 64MB
Graphic		Up to 2 x Dual slot or 4 x Single slot GPU cards supported
Front I/O Ports		2 x USB 3.2 Gen1 ports
Rear I/O Ports		2 x USB 3.2 Gen1 ports 1 x VGA port 1 x RJ-45 Mgmt LAN port 2 x RJ-45 1GbE LAN ports
Switch/LED		Front Switch/LED: 1 x Power Switch (w/ LED) 1 x Reset Switch 1 x Location Switch (w/ LED) 1 x HDD Access LED 1 x Message LED LAN 1-2 LED Rear Switch/LED: 1 x Port80 LED (Q-Code) 1 x Power Switch w/ LED 1 x Location Switch w/ LED 1 x Message LED
Security Options		TPM-SPI PFR
OS Support		Windows® Server 2019 64 bit Windows® Server 2016 RedHat® Enterprise Linux SuSE® Linux Enterprise Server CentOS Ubuntu VMware * Please find the latest OS support from https://www.asus.com/

(continued on the next page)

Model Name		RS520A-E11-RS24U
Management Solution	Software	ASUS Control Center
	Out of Band Remote Management	On-Board ASMB10-iKVM for KVM-over-IP
Regulatory Compliance		BSMI, CE, RCM, FCC(Class A)
Dimension		840mm x 449mm x 88.1mm (2U) 33.07in x 17.68in x 3.47in
Net Weight Kg (CPU, DRAM & HDD not included)		25.57 Kg
Gross Weight Kg (CPU, DRAM & HDD not included, Packing include)		35.36 Kg
Power Supply (different configuration by region)		1+1 Redundant 800W 80 PLUS Platinum Power Supply Rating: 100-127/200-240Vac, 10A/5A (for each inlet), 50-60Hz Class I 1+1 Redundant 850W 80 PLUS Titanium Power Supply Rating: 100-127/200-240Vac, 11A/5A (for each inlet), 47-63Hz or 240Vdc, 4A 1+1 Redundant 1200W 80 PLUS Platinum Power Supply Rating: 100-127/200-240Vac, 10A/8A (for each inlet), 50-60Hz or 240Vdc, 6A 240Vdc Only for China
Environment		Operation temperature: 10° ~ 35° Non operation temperature: -40° ~ 60° Non operation humidity: 20% ~ 90% (Non condensing)

*Specifications are subject to change without notice.

1.4 Front panel features

The barebone server displays a simple yet stylish front panel with easily accessible features. The power and reset buttons, LED indicators are located on the front panel.



Refer to section 1.7 LED information for the LED descriptions.

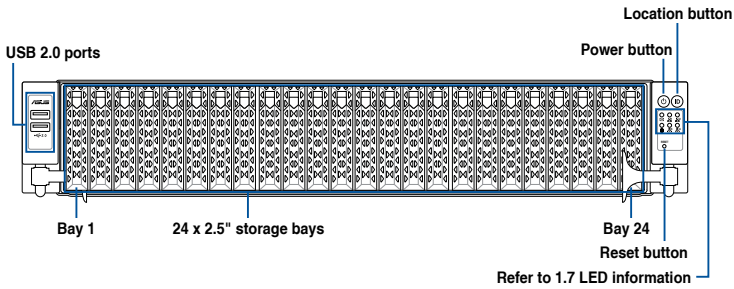

- Bay 1 to bay 24 supports NVMe for 24 NVMe configuration.
 - Bay 5 to bay 20 supports NVMe; others support SATA/SAS* from HBA/RAID for 16 NVMe configuration.
 - Bay 5 to bay 16 supports NVMe, others supports SATA/SAS* for 12 NVMe configuration.
- * SAS support only from HBA/RAID card.

1.5 Rear panel features

The rear panel includes the expansion slots, and system power sockets. The middle part includes the I/O shield with openings for the rear panel connectors on the motherboard.

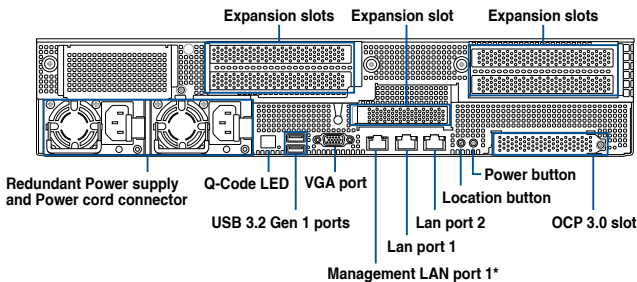

*This port is for ASUS ASMB10-iKVM only.

1.6 Internal features

The barebone server includes the basic components as shown.

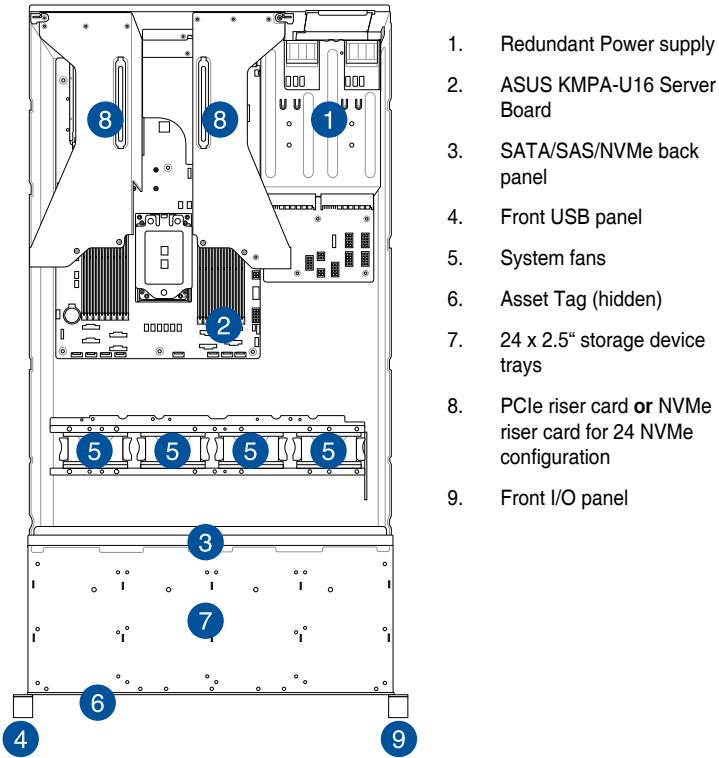

The barebone server does not include a floppy disk drive. Connect a USB floppy disk drive to any of the USB ports on the front or rear panel if you need to use a floppy disk.



A protection film is pre-attached to the front cover before shipping. Please remove the protection film before turning on the system for proper heat dissipation.

WARNING
HAZARDOUS MOVING PARTS
KEEP FINGERS AND OTHER BODY PARTS AWAY

1.7 LED information

1.7.1 Front panel LEDs

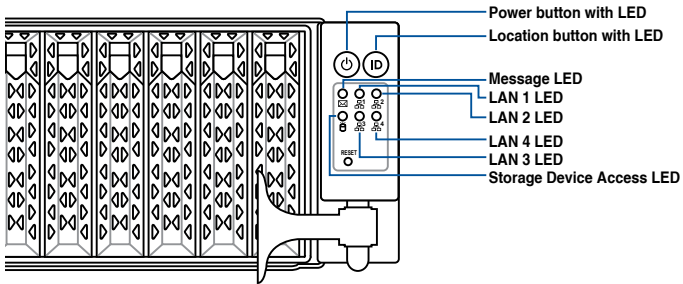

LED	Icon	Display status	Description
Power button with LED		ON	System power on
Storage Device Access LED		OFF	No activity
		Blinking	Read/write data into the storage device
Message LED		OFF	System is normal; no incoming event
		ON	With the onboard ASMB10-iKVM: a hardware monitor event is indicated
Location button with LED		ON	Location switch is pressed
		OFF	Normal status (Press the location switch again to turn off)
LAN LEDs		OFF	No LAN connection
		Blinking	LAN is transmitting or receiving data
		ON	LAN connection is present

1.7.2 Storage device status LED

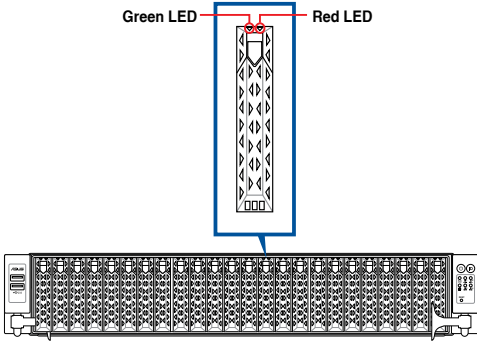

Storage Device LED Description		
Status (RED)	ON	Storage device has failed
	Blinking	RAID rebuilding or locating
Activity (GREEN)	ON	Storage device power ON
	Blinking	Read/write data from/into the SATA/SAS storage device
	OFF	Storage device not found

1.7.3 LAN (RJ-45) LEDs

Intel® I350-AM2 1G LAN port LEDs

ACT/LINK LED SPEED LED



ACT/LINK LED		SPEED LED	
Status	Description	Status	Description
OFF	No link	OFF	10 Mbps connection
GREEN	Linked	ORANGE	100 Mbps connection
BLINKING	Data activity	GREEN	1 Gbps connection

Dedicated Management LAN port (DM_LAN1) LED indications

ACT/LINK LED SPEED LED



ACT/LINK LED		SPEED LED	
Status	Description	Status	Description
OFF	No link	OFF	10 Mbps connection
GREEN	Linked	ORANGE	100 Mbps connection
BLINKING	Data activity	GREEN	1 Gbps connection

1.7.4 Rear panel LEDs

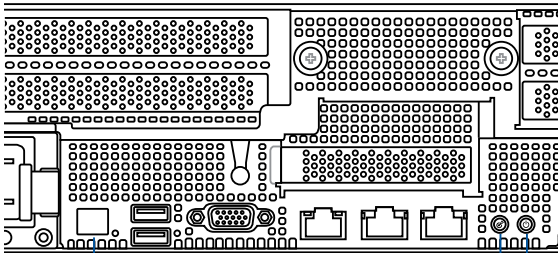

Q-Code LED

Location button with LED

Power button with LED

1.7.5 Q-Code table

AMD EPYC™ 7002 Series processors

Action	PHASE	POST CODE	TYPE	DESCRIPTION
SEC Start up	Security Phase	0x01	Progress	First post code
		0x02	Progress	Load BSP microcode
		0x03	Progress	Perform early platform Initialization
		0x04	Progress	Set cache as ram for PEI phase
		0x05	Progress	Establish Stack
		0x06	Progress	CPU Early Initialization
PSP Boot	PSP Boot Loader phase (Error Post Codes)	0x00	Error	General - Success
		0x01	Error	Generic Error Code
		0x02	Error	Generic Memory Error
		0x03	Error	Buffer Overflow
		0x04	Error	Invalid Parameter(s)
		0x05	Error	Invalid Data Length
		0x06	Error	Data Alignment Error
		0x07	Error	Null Pointer Error
		0x08	Error	Unsupported Function
		0x09	Error	Invalid Service ID
		0x0A	Error	Invalid Address
		0x0B	Error	Out of Resource Error
		0x0C	Error	Timeout
		0x0D	Error	data abort exception
		0x0E	Error	prefetch abort exception
		0x0F	Error	Out of Boundary Condition Reached
		0x10	Error	Data corruption
		0x11	Error	Invalid command
		0x12	Error	The package type provided by BR is incorrect
		0x13	Error	Failed to retrieve FW header during FW validation
		0x14	Error	Key size not supported
		0x15	Error	Agesa0 verification error
		0x16	Error	SMU FW verification error
		0x17	Error	OEM SINGING KEY verification error
		0x18	Error	Generic FW Validation error
		0x19	Error	RSA operation fail - bootloader
		0x1A	Error	CCP Passthrough operation failed - internal status
		0x1B	Error	AES operation fail
		0x1C	Error	CCP state save failed
		0x1D	Error	CCP state restore failed
		0x1E	Error	SHA256 operation fail - internal status
		0x1F	Error	ZLib Decompression operation fail
		0x20	Error	HMAC-SHA256 operation fail - internal status
		0x21	Error	Booted from boot source not recognized by PSP
		0x22	Error	PSP directory entry not found
		0x23	Error	PSP failed to set the write enable latch
		0x24	Error	PSP timed out because spirom took too long
		0x25	Error	Cannot find BIOS directory
0x26	Error	SpiRom is not valid		
0x27	Error	slave die has different security state from master		
0x28	Error	SMI interface init failure		
0x29	Error	SMI interface generic error		
0x2A	Error	invalid die ID executes MCM related function		
0x2B	Error	invalid MCM configuration table read from bootrom		
0x2C	Error	Valid boot mode wasn't detected		
0x2D	Error	NVStorage init failure		
0x2E	Error	NVStorage generic error		
0x2F	Error	MCM 'error' to indicate slave has more data to send		
0x30	Error	MCM error if data size exceeds 32B		
0x31	Error	Invalid client id for SVC MCM call		
0x32	Error	MCM slave status register contains bad bits		
0x33	Error	MCM call was made in a single die environment		
0x34	Error	PSP secure mapped to invalid segment (should be 0x400_0000)		
0x35	Error	No physical x86 cores were found on die		
0x36	Error	Insufficient space for secure OS (range of free SRAM to SVC stack base)		
0x37	Error	SYSHUB mapping memory target type is not supported		
0x38	Error	Attempt to unmap permanently mapped TLB to PSP secure region		

(continued on the next page)

Action	PHASE	POST CODE	TYPE	DESCRIPTION
		0x39	Error	Unable to map an SMN address to AXI space
		0x3A	Error	Unable to map a SYSHUB address to AXI space
		0x3B	Error	The count of CCXs or cores provided by bootrom is not consistent
		0x3C	Error	Uncompressed image size doesn't match value in compressed header
		0x3D	Error	Compressed option used in case where not supported
		0x3E	Error	Fuse info on all dies don't match
		0x3F	Error	PSP sent message to SMU; SMU reported an error
		0x40	Error	Function RunPostX86ReleaseUnitTests failed in memcmp()
		0x41	Error	Interface between PSP to SMU not available.
		0x42	Error	Timer wait parameter too large
		0x43	Error	Test harness module reported an error
		0x44	Error	x86 wrote C2PMSG_0 interrupting PSP
		0x45	Error	A write to an L3 register failed
		0x46	Error	Mini-BL
		0x47	Error	Mini-BL CCP HMAC Unit-test failed
		0x48	Error	Potential stack corruption in jump to Mini BL
		0x49	Error	Error in Validate and Loading AGESA APOB SVC call
		0x4A	Error	Correct fuse bits for DIAG_BL loading not set
		0x4B	Error	The UmcProgramKeys() function was not called by AGESA
		0x4C	Error	Secure unlock error
		0x4D	Error	Syshub register programming mismatch during readback
		0x4E	Error	Family ID in MPO_SFUSE_SEC[7:3] not correct
		0x4F	Error	An operation was invoked that can only be performed by the GM
		0x50	Error	Failed to acquire host controller semaphore to claim ownership of SMB
		0x51	Error	Timed out waiting for host to complete pending transactions
		0x52	Error	Timed out waiting for slave to complete pending transactions
		0x53	Error	Unable to kill current transaction on host
		0x54	Error	One of: Illegal command
		0x55	Error	An SMBus transaction collision detected
		0x56	Error	Transaction failed to be started or processed by host
		0x57	Error	An unsolicited SMBus interrupt was received
		0x58	Error	An attempt to send an unsupported PSP-SMU message was made
		0x59	Error	An error/data corruption detected on response from SMU for sent msg
		0x5A	Error	MCM Steady-state unit test failed
		0x5B	Error	S3 Enter failed
		0x5C	Error	AGESA BL did not set PSP SMU reserved addresses via SVC call
		0x5E	Error	CxSecBisiEn not set in fuse RAM
		0x5F	Error	Received an unexpected result
		0x60	Error	VMG Storage Init failed
		0x61	Error	Failure in mbedTLS user app
		0x62	Error	An error occurred whilst attempting to SMN map a fuse register
		0x63	Error	Fuse burn sequence/operation failed due to internal SOC error
		0x64	Error	Fuse sense operation timed out
		0x65	Error	Fuse burn sequence/operation timed out waiting for burn done
		0x66	Error	Failure status indicating that the given SecureOS has been
		0x67	Error	This PSP FW was revoked
		0x68	Error	The platform model/vendor id fuse is not matching the BIOS public key token
		0x69	Error	The BIOS OEM public key of the BIOS was revoked for this platform
		0x6A	Error	PSP level 2 directory not match expected value.
		0x6B	Error	BIOS level 2 directory not match expected value.
		0x6C	Error	HVB validation failure for BIOS RTM volume (OEM public/signature failed to validate).
		0x6D	Error	Generic error indicating the CCP HAL initialization failed
		0x94	Error	Knoll failed to idle correctly after being reset
		0x95	Error	Bad status returned by I2CKnollCheck
		0x96	Error	NACK to general call (no device on Knoll I2C bus)
		0x97	Error	Null pointer passed to I2CKnollCheck
		0x98	Error	Invalid device-ID found during Knoll authentication
		0x99	Error	Error during Knoll/Prom key derivation
		0x9A	Error	Null pointer passed to Crypto function
		0x9B	Error	Error in checksum from wrapped Knoll/Prom keys
		0x9C	Error	Knoll returned an invalid response to a command
		0x9D	Error	Bootloader failed in Knoll Send Command function
		0x9E	Error	No Knoll device found by verifying MAC

(continued on the next page)

Action	PHASE	POST CODE	TYPE	DESCRIPTION
		0xA0	Progress	Bootloader successfully entered C Main
		0xA1	Progress	Master initialized C2P / slave waited for master to init C2P
		0xA2	Progress	HMAC key successfully derived
		0xA3	Progress	Master got Boot Mode and sent boot mode to all slaves
		0xA4	Progress	SpiRom successfully initialized
		0xA5	Progress	BIOS Directory successfully read from SPI to SRAM
		0xA6	Progress	Early unlock check
		0xA7	Progress	Inline Aes key successfully derived
		0xA8	Progress	Inline-AES key programming is done
		0xA9	Progress	Inline-AES key wrapper derivation is done
		0xAA	Progress	Bootloader successfully loaded HW IP configuration values
		0xAB	Progress	Bootloader successfully programmed MBAT table
		0xAC	Progress	Bootloader successfully loaded SMU FW
		0xAD	Progress	PSP and SMU configured WAFL
		0xAE	Progress	User mode test harness completed successfully
		0xAF	Progress	Bootloader loaded Agesa0 from SpiRom
		0xB0	Progress	AGESA phase has completed
		0xB1	Progress	RunPostDramTrainingTests() completed successfully
		0xB2	Progress	SMU FW Successfully loaded to SMU Secure DRAM
		0xB3	Progress	Sent all required boot time messages to SMU
		0xB4	Progress	Validated and ran Security Gasket binary
		0xB5	Progress	UMC Keys generated and programmed
		0xB6	Progress	Inline AES key wrapper stored in DRAM
		0xB7	Progress	Completed FW Validation step
		0xB8	Progress	Completed FW Validation step
		0xB9	Progress	BIOS copy from SPI to DRAM complete
		0xBA	Progress	Completed FW Validation step
		0xBB	Progress	BIOS load process fully complete
		0xBC	Progress	Bootloader successfully release x86
		0xBD	Progress	Early Secure Debug completed
		0xBE	Progress	GetFWVersion command received from BIOS is completed
		0xBF	Progress	SMInfo command received from BIOS is completed
		0xC0	Progress	Successfully entered WarmBootResume()
		0xC1	Progress	Successfully copied SecureOS image to SRAM
		0xC2	Progress	Successfully copied trustlets to PSP Secure Memory
		0xC3	Progress	About to jump to Secure OS (SBL about to copy and jump)
		0xC4	Progress	Successfully restored CCP and UMC state on S3 resume
		0xC5	Progress	PSP SRAM HMAC validated by Mini BL
		0xC6	Progress	About to jump to -t-base in Mini BL
		0xC7	Progress	VMG ECDH unit test started
		0xC8	Progress	VMG ECDH unit test passed
		0xC9	Progress	VMG ECC CDH primitive unit test started
		0xCA	Progress	VMG ECC CDH primitive unit test passed
		0xCB	Progress	VMG SP800-108 KDF-CTR HMAC unit test started
		0xCC	Progress	VMG SP800-108 KDF-CTR HMAC unit test passed
		0xCD	Progress	VMG LAUNCH * test started
		0xCE	Progress	VMG LAUNCH * test passed
		0xCF	Progress	MP1 has been taken out of reset
		0xD0	Progress	PSP and SMU Reserved Addresses correct
		0xD1	Progress	Reached Naples steady-state WFI loop
		0xD2	Progress	Knoll device successfully initialized
		0xD3	Progress	32-byte RandOut successfully returned from Knoll
		0xD4	Progress	32-byte MAC successfully received from Knoll.
		0xD5	Progress	Knoll device verified successfully
		0xD6	Progress	Done enabling power for Knoll
		0xD7	Progress	Enter recovery mode due to trustlet validation fail.
		0xD8	Progress	Enter recovery mode due to OS validation fail.
		0xD9	Progress	Enter recovery mode due to OEM public key not found.

PSP Boot

PSP Boot Loader phase (Status Post Codes)

(continued on the next page)

Action	PHASE	POST CODE	TYPE	DESCRIPTION	
Quick VGA	PEI(Pre-EFI Initialization) phase	0x10	Progress	PEI Core Entry	
		0x11	Progress	PEI cache as ram CPU initial	
		0x15	Progress	NB Initialization before installed memory	
		0x19	Progress	SB Initialization before installed memory	
		0x32	Progress	CPU POST-Memory Initialization	
		0x33	Progress	CPU Cache Initialization	
		0x34	Progress	Application Processor(s) (AP) Initialization	
		0x35	Progress	BSP Selection	
		0x36	Progress	CPU Initialization	
	0x37	Progress	Pre-memory NB Initialization		
	0x3B	Progress	Pre-memory SB Initialization		
	0x4F	Progress	DXE Initial Program Load(IPL)		
	0x60	Progress	DXE Core Started		
	DXE(Driver Execution Environment) phase	0x61	Progress	DXE NVRAM Initialization	
		0x62	Progress	SB run-time Initialization	
		0x63	Progress	CPU DXE Initialization	
		0x68	Progress	PCI HB Initialization	
		0x69	Progress	NB DXE Initialization	
		0x6A	Progress	NB DXE SMM Initialization	
		0x70	Progress	SB DXE Initialization	
		0x71	Progress	SB DXE SMM Initialization	
		0x72	Progress	SB DEVICES Initialization	
		0x78	Progress	ACPI Module Initialization	
		0x79	Progress	CSM Initialization	
	0xD0	Progress	CPU PM Structure Initialization		
	Normal boot	BDS(Boot Device Selection) phase	0x90	Progress	BDS started
			0x91	Progress	Connect device event
			0x92	Progress	PCI Bus Enumeration
			0x93	Progress	PCI Bus Enumeration
			0x94	Progress	PCI Bus Enumeration
			0x95	Progress	PCI Bus Enumeration
			0x96	Progress	PCI Bus Enumeration
			0x97	Progress	Console output connect event
			0x98	Progress	Console input connect event
			0x99	Progress	AMI Super IO start
			0x9A	Progress	AMI USB Driver Initialization
			0x9B	Progress	AMI USB Driver Initialization
			0x9C	Progress	AMI USB Driver Initialization
			0x9D	Progress	AMI USB Driver Initialization
0xb2			Progress	Legacy Option ROM Initialization	
0xb3			Progress	Reset system	
0xb4			Progress	USB hotplug	
0xb6			Progress	NVRAM clean up	
0xb7			Progress	NVRAM configuration reset	
0xA0			Progress	IDE, AHCI Initialization	
0xA1			Progress	IDE, AHCI Initialization	
0xA2			Progress	IDE, AHCI Initialization	
0xA3			Progress	IDE, AHCI Initialization	
0x00-0xFF			Progress	Wait BMC ready	
0xA8			Progress	BIOS Setup Utility password verify	
0xA9			Progress	BIOS Setup Utility start	
0xAB			Progress	BIOS Setup Utility input wait	
0xAD			Progress	Ready to boot event	
0xAE			Progress	Legacy boot event	
Operating system phase		0xAA	Progress	APIC mode	
		0xAC	Progress	PIC mode	

AMD EPYC™ 7003 Series processors

Action	PHASE	POST CODE	TYPE	DESCRIPTION
SEC Start up	Security Phase	0x01	Progress	First post code
		0x02	Progress	Load BSP microcode
		0x03	Progress	Perform early platform Initialization
		0x04	Progress	Set cache as ram for PEI phase
		0x05	Progress	Establish Stack
		0x06	Progress	CPU Early Initialization
PSP Boot	PSP Boot Loader phase (Error Post Codes)	0x00	error	General - Success
		0x01	error	Generic Error Code
		0x02	error	Generic Memory Error
		0x03	error	Buffer Overflow
		0x04	error	Invalid Parameter(s)
		0x05	error	Invalid Data Length
		0x06	error	Data Alignment Error
		0x07	error	Null Pointer Error
		0x08	error	Unsupported Function
		0x09	error	Invalid Service ID
		0x0A	error	Invalid Address
		0x0B	error	Out of Resource Error
		0x0C	error	Timeout
		0x0D	error	data abort exception
		0x0E	error	prefetch abort exception
		0x0F	error	Out of Boundary Condition Reached
		0x10	error	Data corruption
		0x11	error	Invalid command
		0x12	error	The package type provided by BR is incorrect
		0x13	error	Failed to retrieve FW header during FW validation
		0x14	error	Key size not supported
		0x15	error	Agesa0 verification error
		0x16	error	SMU FW verification error
		0x17	error	OEM SINGING KEY verification error
		0x18	error	Generic FW Validation error
		0x19	error	RSA operation fail - bootloader
		0x1A	error	CCP Passthrough operation failed - internal status
		0x1B	error	AES operation fail
		0x1C	error	CCP state save failed
		0x1D	error	CCP state restore failed
		0x1E	error	SHA256/384 operation fail - internal status
		0x1F	error	ZLib Decompression operation fail
		0x20	error	HMAC-SHA256/384 operation fail - internal status
		0x21	error	Booted from boot source not recognized by PSP
		0x22	error	PSP directory entry not found
		0x23	error	PSP failed to set the write enable latch
		0x24	error	PSP timed out because spirom took too long
		0x25	error	Cannot find BIOS directory
		0x26	error	SpiRom is not valid
0x27	error	slave die has different security state from master		
0x28	error	SMI interface init failure		
0x29	error	SMI interface generic error		
0x2A	error	invalid die ID executes MCM related function		
0x2B	error	invalid MCM configuration table read from bootrom		
0x2C	error	Valid boot mode wasn't detected		
0x2D	error	NVStorage init failure		
0x2E	error	NVStorage generic error		
0x2F	error	MCM 'error' to indicate slave has more data to send		
0x30	error	MCM error if data size exceeds 32B		
0x31	error	Invalid client id for SVC MCM call		
0x32	error	MCM slave status register contains bad bits		
0x33	error	MCM call was made in a single die environment		
0x34	error	PSP secure mapped to invalid segment (should be 0x400_0000)		
0x35	error	No physical x86 cores were found on die		
0x36	error	Insufficient space for secure OS (range of free SRAM to SVC stack base)		
0x37	error	SYSHUB mapping memory target type is not supported		
0x38	error	Attempt to unmap permanently mapped TLB to PSP secure region		
0x39	error	Unable to map an SMN address to AXI space		

(continued on the next page)

Action	PHASE	POST CODE	TYPE	DESCRIPTION
PSP Boot	PSP Boot Loader phase (Error Post Codes)	0x3A	error	Unable to map a SYSHUB address to AXI space
		0x3B	error	The count of CCXs or cores provided by bootrom is not consistent
		0x3C	error	Uncompressed image size doesn't match value in compressed header
		0x3D	error	Compressed option used in case where not supported
		0x3E	error	Fuse info on all dies don't match
		0x3F	error	PSP sent message to SMU; SMU reported an error
		0x40	error	Function RunPostX86ReleaseUnitTests failed in memcmp()
		0x41	error	Interface between PSP to SMU not available.
		0x42	error	Timer wait parameter too large
		0x43	error	Test harness module reported an error
		0x44	error	x86 wrote C2PMSG_0 interrupting PSP, but the command has an invalid format
		0x45	error	Failed to read from SPI the Bios Directory or Bios Combo Directory
		0x46	error	Mini-BL, validation of the PSP SRAM image failed on HMAC compare
		0x47	error	Failed to read the combo bios header
		0x48	error	Potential stack corruption in jump to Mini BL
		0x49	error	Error in Validate and Loading AGESA APOB SVC call
		0x4A	error	Correct fuse bits for DIAG_BL loading not set
		0x4B	error	The UmcProgramKeys() function was not called by AGESA
		0x4C	error	Unconditional Unlock based on serial numbers failure
		0x4D	error	Syshub register programming mismatch during readback
		0x4E	error	Family ID in MPO_SFUSE_SEC[7:3] not correct
		0x4F	error	An operation was invoked that can only be performed by the GM
		0x50	error	Failed to acquire host controller semaphore to claim ownership of SMB
		0x51	error	Timed out waiting for host to complete pending transactions
		0x52	error	Timed out waiting for slave to complete pending transactions
		0x53	error	Unable to kill current transaction on host, to force idle
		0x54	error	One of: Illegal command, Unclaimed cycle, or Host time out
		0x55	error	An smbus transaction collision detected, operation restarted
		0x56	error	Transaction failed to be started or processed by host, or not completed
		0x57	error	An unsolicited smbus interrupt was received
		0x58	error	An attempt to send an unsupported PSP-SMU message was made
		0x59	error	An error/data corruption detected on response from SMU for sent msg
		0x5A	error	MCM Steady-state unit test failed
		0x5B	error	S3 Enter failed
		0x5C	error	AGESA BL did not set PSP SMU reserved addresses via SVC call
		0x5E	error	CcxSecBisiEn not set in fuse RAM
		0x5F	error	Received an unexpected result
		0x60	error	VMG Storage Init failed
		0x61	error	failure in mbedTLS user app
		0x62	error	An error occurred whilst attempting to SMN map a fuse register
		0x63	error	Fuse burn sequence/operation failed due to internal SOC error
		0x64	error	Fuse sense operation timed out
		0x65	error	Fuse burn sequence/operation timed out waiting for burn done
		0x66	error	The PMU FW Public key certificate loading or authentication fails
		0x67	error	This PSP FW was revoked
		0x68	error	The platform model/vendor id fuse is not matching the BIOS public key token
		0x69	error	The BIOS OEM public key of the BIOS was revoked for this platform
0x6A	error	PSP level 2 directory not match expected value.		
0x6B	error	BIOS level 2 directory not match expected value.		
0x6C	error	Reset image not found		
0x6D	error	Generic error indicating the CCP HAL initialization failed		
0x6E	error	failure to copy NVRAM to DRAM.		
0x6F	error	Invalid key usage flag		
0x71	error	RSMU signaled a security violation		
0x72	error	Error programming the WAFL PCS registers		
0x73	error	Error setting wafl PCS threshold value		
0x74	error	Error loading OEM trustlets		
0x75	error	Recovery mode across all dies is not sync'd		
0x76	error	Uncorrectable WAFL error detected		
0x77	error	Fatal MP1 error detected		
0x78	error	Bootloader failed to find OEM signature		
0x79	error	Error copying BIOS to DRAM		
0x7A	error	Error validating BIOS image signature		

(continued on the next page)

Action	PHASE	POST CODE	TYPE	DESCRIPTION
PSP Boot	PSP Boot Loader phase (Status Post Codes)	0x7B	error	
		0x7C	error	Platform Vendor ID and/or Model ID binding violation
		0x7D	error	Bootloader detects BIOS request boot from SPI-ROM, which is unsupported for PSB.
		0x7E	error	Requested fuse is already blown, reblow will cause ASIC malfunction
		0x7F	error	Error with actual fusing operation
		0x80	error	(Local Master PSP on P1 socket) Error reading fuse info
		0x81	error	(Local Master PSP on P1 socket) Platform Vendor ID and/or Model ID binding violation
		0x82	error	(Local Master PSP on P1 socket) Requested fuse is already blown, reblow will cause ASIC malfunction
		0x83	error	(Local Master PSP on P1 socket) Error with actual fusing operation
		0x84	error	SEV FW Rollback attempt is detected
		0x85	error	/ SEV download FW command fail to broadcast and clear the IsInSRAM field on slave dies
		0x86	error	Agesa error injection failure
		0x87	error	Uncorrectable TWIX error detected
		0x88	error	Error programming the TWIX PCS registers
		0x89	error	Error setting TWIX PCS threshold value
		0x8A	error	SW CCP queue is full, cannot add more entries
		0x8B	error	CCP command description syntax error detected from input
		0x8C	error	Return value stating that the command has not yet been scheduled
		0x8D	error	The command is scheduled and being worked on
		0x8E	error	The DXIO PHY SRAM Public key certificate loading or authentication fails
		0x8F	error	TPM binary size exceeds limit allocated in Private DRAM, need to increase the limit
		0x90	error	The TWIX link for a particular CCD is not trained Fatal error
		0x91	error	Security check failed (not all dies are in same security state)
		0x92	error	FW type mismatch between the requested FW type and the FW type embedded in the FW binary header
		0x93	error	SVC call input parameter address violation
		0x94	error	Knoll failed to idle correctly after being reset
		0x95	error	Bad status returned by I2CKnollCheck
		0x96	error	NACK to general call (no device on Knoll I2C bus)
		0x97	error	Null pointer passed to I2CKnollCheck
		0x98	error	Invalid device-ID found during Knoll authentication
0x99	error	Error during Knoll/Prom key derivation		
0x9A	error	Null pointer passed to Crypto function		
0x9B	error	Error in checksum from wrapped Knoll/Prom keys		
0x9C	error	Knoll returned an invalid response to a command		
0x9D	error	Bootloader failed in Knoll Send Command function		
0x9E	error	No Knoll device found by verifying MAC		
0x9F	error	The maximum allowable error post code		
Quick VGA	PEI(Pre-EFI Initialization) phase	0x10	Progress	PEI Core Entry
		0x11	Progress	PEI cache as ram CPU initial
	DXE(Driver Execution Environment) phase	0x15	Progress	NB Initialization before installed memory
		0x19	Progress	SB Initialization before installed memory
		0x32	Progress	CPU POST-Memory Initialization
		0x33	Progress	CPU Cache Initialization
		0x34	Progress	Application Processor(s) (AP) Initialization
		0x35	Progress	BSP Selection
		0x36	Progress	CPU Initialization
		0x37	Progress	Pre-memory NB Initialization
		0x3B	Progress	Pre-memory SB Initialization
		0x4F	Progress	DXE Initial Program Load(IPL)
		0x60	Progress	DXE Core Started
		0x61	Progress	DXE NVRAM Initialization
		0x62	Progress	SB run-time Initialization
		0x63	Progress	CPU DXE Initialization
		0x68	Progress	PCI HB Initialization
		0x69	Progress	NB DXE Initialization
		0x6A	Progress	NB DXE SMM Initialization
		0x70	Progress	SB DXE Initialization
0x71	Progress	SB DXE SMM Initialization		
0x72	Progress	SB DEVICES Initialization		
0x78	Progress	ACPI Module Initialization		
0x79	Progress	CSM Initialization		
0xD0	Progress	CPU PM Structure Initialization		

(continued on the next page)

Action	PHASE	POST CODE	TYPE	DESCRIPTION
Normal boot	BDS(Boot Device Selection) phase	0x90	Progress	BDS started
		0x91	Progress	Connect device event
		0x92	Progress	PCI Bus Enumeration
		0x93	Progress	PCI Bus Enumeration
		0x94	Progress	PCI Bus Enumeration
		0x95	Progress	PCI Bus Enumeration
		0x96	Progress	PCI Bus Enumeration
		0x97	Progress	Console output connect event
		0x98	Progress	Console input connect event
		0x99	Progress	AMI Super IO start
		0x9A	Progress	AMI USB Driver Initialization
		0x9B	Progress	AMI USB Driver Initialization
		0x9C	Progress	AMI USB Driver Initialization
		0x9D	Progress	AMI USB Driver Initialization
		0xb2	Progress	Legacy Option ROM Initialization
		0xb3	Progress	Reset system
		0xb4	Progress	USB hotplug
		0xb6	Progress	NVRAM clean up
		0xb7	Progress	NVRAM configuration reset
		0xA0	Progress	IDE, AHCI Initialization
		0xA1	Progress	IDE, AHCI Initialization
		0xA2	Progress	IDE, AHCI Initialization
		0xA3	Progress	IDE, AHCI Initialization
		0x00-0xFF	Progress	Wait BMC ready
		0xA8	Progress	BIOS Setup Utility password verify
		0xA9	Progress	BIOS Setup Utility start
		0xAB	Progress	BIOS Setup Utility input wait
		0xAD	Progress	Ready to boot event
		0xAE	Progress	Legacy boot event
		Operating system phase	0xAA	Progress
	0xAC		Progress	PIC mode

Hardware Information

2

This chapter lists the hardware setup procedures that you have to perform when installing or removing system components.

2.1 Chassis cover

2.1.1 Removing the rear cover

1. Remove the two (2) screws on both sides of the rear cover with a Phillips screwdriver.

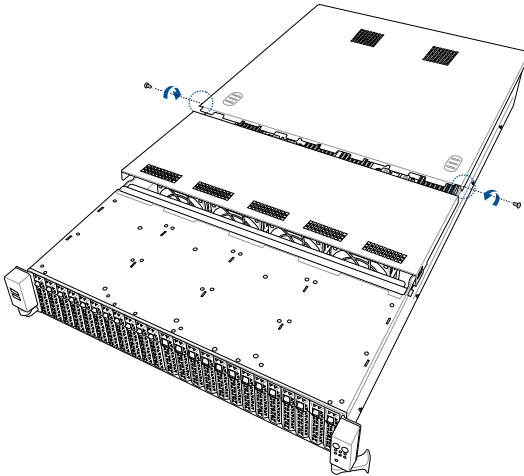

2. Push the buttons on both sides to release the rear cover from the chassis.
3. Slide the rear cover towards the rear panel to disengage it from the chassis.
4. Lift the rear cover from the chassis.

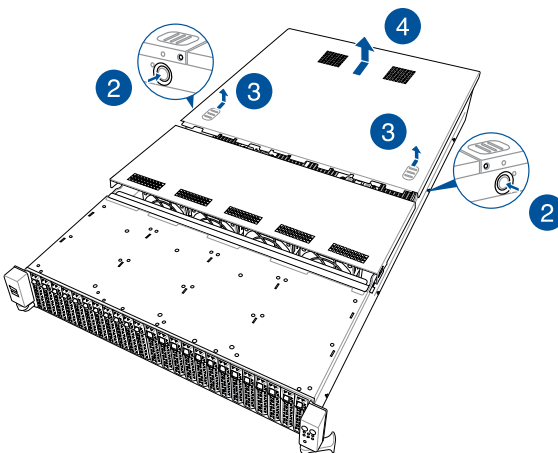

2.1.2 Removing the mid cover

1. Remove the two (2) screws on both sides of the mid cover with a Phillips screwdriver.

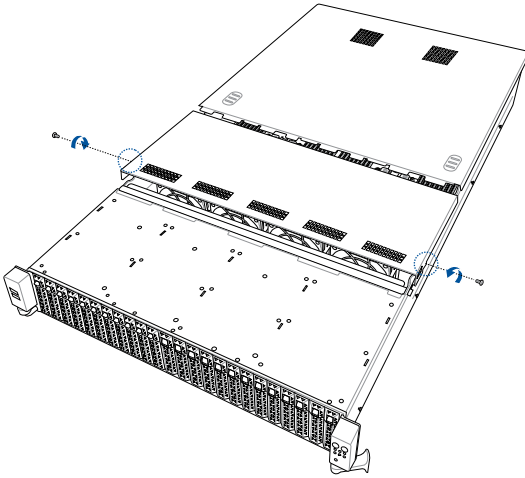

2. Push the buttons on both sides to release the mid cover from the chassis.
3. Slide the mid cover towards the rear panel to disengage it from the chassis.
4. Lift the mid cover from the chassis.

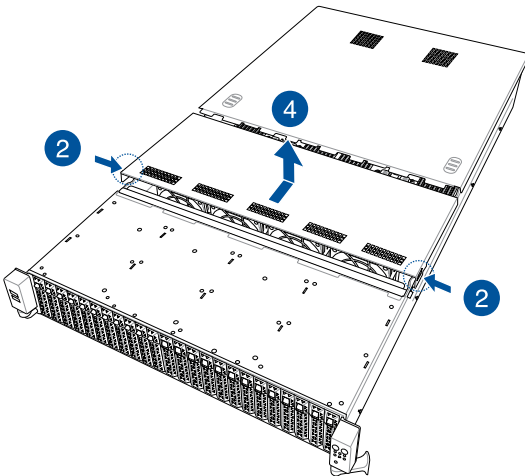

2.2 Air ducts

2.2.1 Removing the air ducts

Remove the two (2) screws from the air ducts, then gently lift the air ducts vertically out of the chassis.

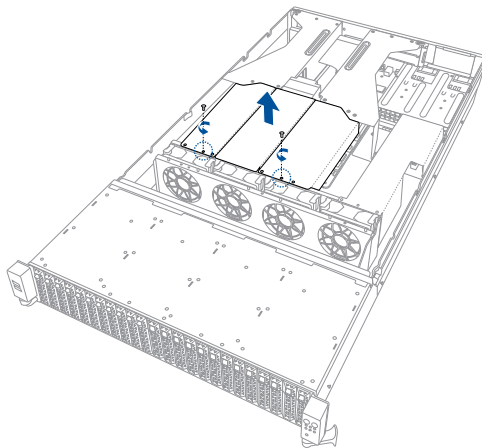

2.2.2 Installing the air ducts

Align the air duct notch holes to the notches in the system, then install the air ducts into the chassis and secure it with the two (2) screws removed previously.

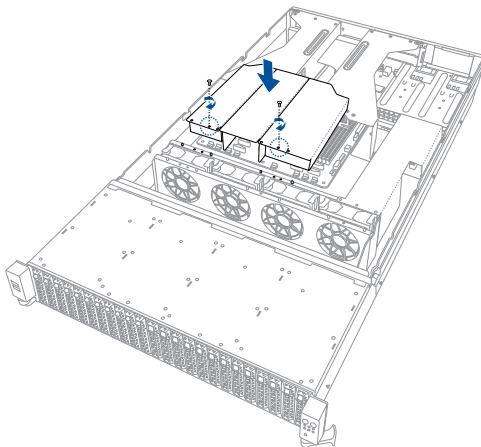

2.3 Central Processing Unit (CPU)

The motherboard comes with a surface mount Socket SP3 designed for the AMD EPYC™ 7002/7003 Series.



- Upon purchase of the motherboard, ensure that the PnP cap is on the socket and the socket contacts are not bent. Contact your retailer immediately if the PnP cap is missing, or if you see any damage to the PnP cap/socket contacts/motherboard components. ASUS will shoulder the cost of repair only if the damage is shipment/transit-related.
- Keep the cap after installing the motherboard. ASUS will process Return Merchandise Authorization (RMA) requests only if the motherboard comes with the cap on the Socket SP3.
- The product warranty does not cover damage to the socket contacts resulting from incorrect CPU installation/removal, or misplacement/loss/incorrect removal of the PnP cap.

2.3.1 Installing the CPU and heatsink

To install the CPU and heatsink:

1. Remove the rear cover. For more information, refer to **Chassis cover**.
2. Remove the air ducts. For more information, refer to **Air ducts**.
3. Loosen the thumbscrew of the left riser bracket located at the rear of the system then pull the riser bracket vertically out of the chassis.

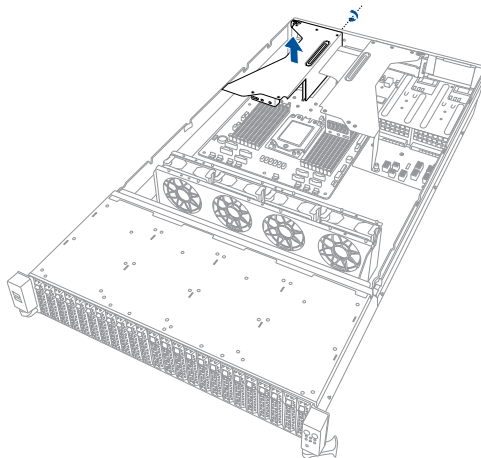

4. Locate the CPU socket on your motherboard..

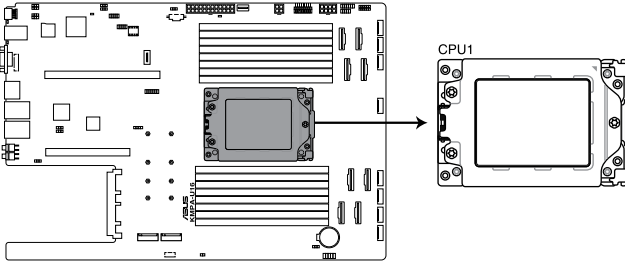

KMPA-U16 CPU TR4 Socket

5. Loosen each screw one by one in the sequence shown on the socket to open the load plate.

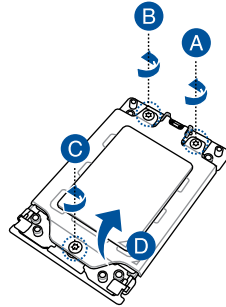

6. Slightly lift open the rail frame.

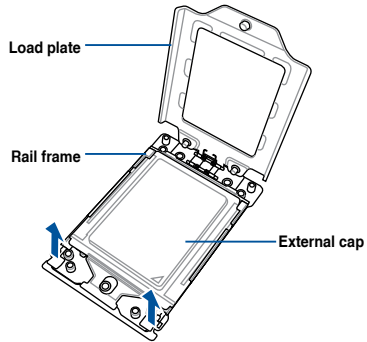

- Slide the external cap out of the rail frame.

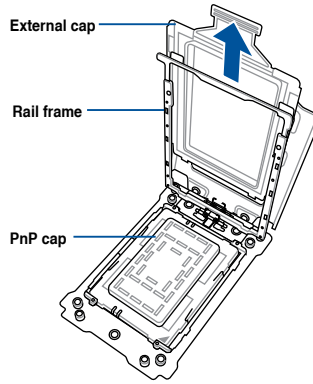

- Slide the carrier frame with CPU into the rail frame, then remove the PnP cap.



The carrier frame with CPU fits in only one correct orientation. DO NOT force the carrier frame with CPU into the rail frame.

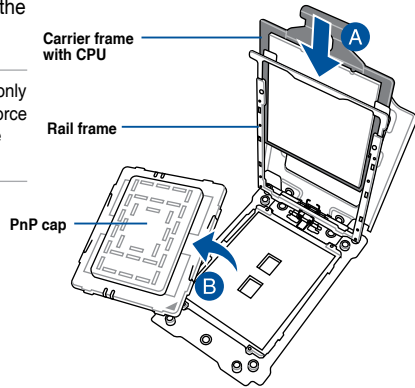

- Gently push the rail frame just enough to let it sit on top of the CPU socket.

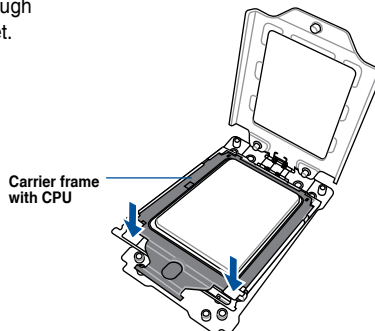

10. Close the load plate just enough to let it sit on top of the CPU, then secure each screw one by one in the sequence shown on the socket to completely secure the load plate.



The load plate screws are T20 models. A torque value of 16.1 ± 1.2 kgf-cm (14.0 ± 1.0 lbf-in) is recommended.

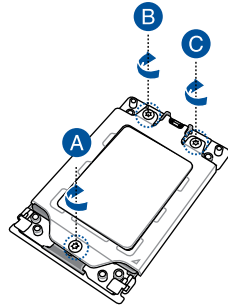

11. Twist each of the four screws with a screwdriver just enough to attach the heatsink to the motherboard. When the four screws are attached, tighten them one by one in the sequence shown in the illustration to completely secure the heatsink.



The heatsink screws are T20 models. A torque value of 16.1 ± 1.2 kgf-cm (14.0 ± 1.0 lbf-in) is recommended.

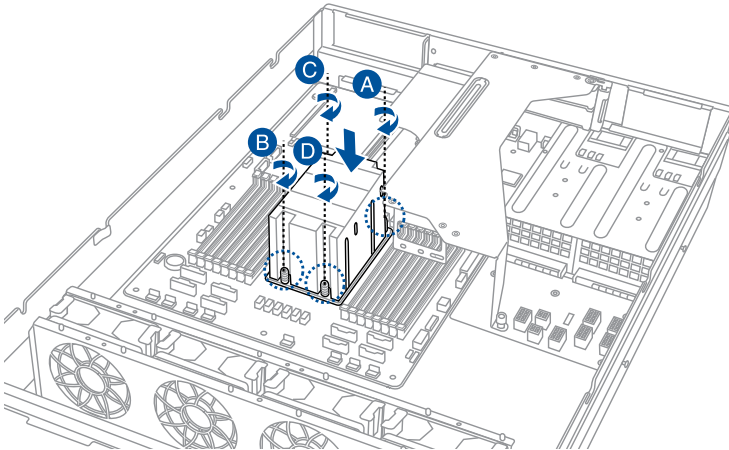

- Align the left PCIe riser card bracket to the notch holes on the chassis and the **PCIe1** slot on the motherboard. Please refer to the illustration below for the locations of the notch holes on the chassis.



Ensure that no cables are below or in the way of the PCIe riser card bracket when installing it to the chassis.

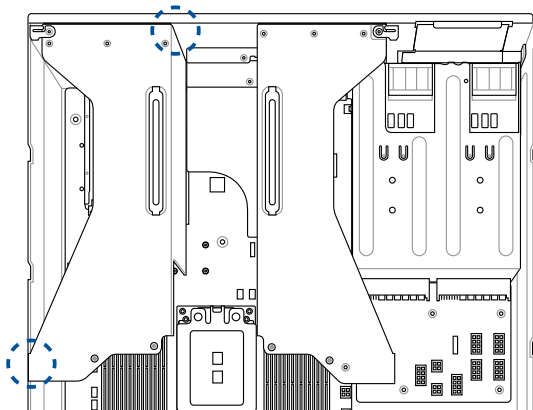

- Push the left PCIe riser card bracket down until it is seated firmly in the chassis.



Ensure that no cables are below or in the way of the PCIe riser card bracket when installing it to the chassis.

- Secure the left PCIe riser card bracket with the thumbscrews.

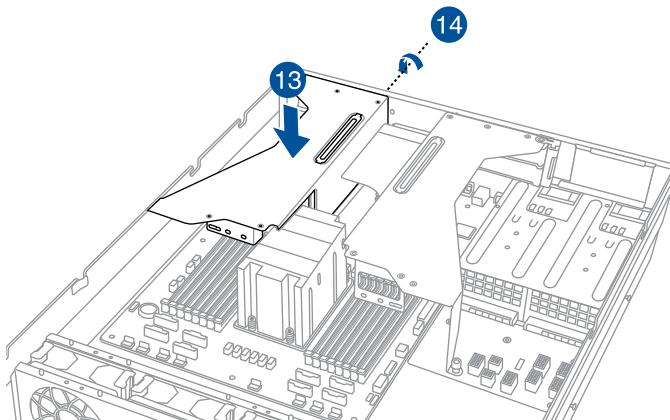

- Reinstall the air ducts to complete the CPU and heatsink installation. For more information, refer to **Air ducts**.

2.4 System memory

2.4.1 Overview

The motherboard comes with 16 Double Data Rate 4 (DDR4) Dual Inline Memory Modules (DIMM) sockets.

The figure illustrates the location of the DDR4 DIMM sockets:

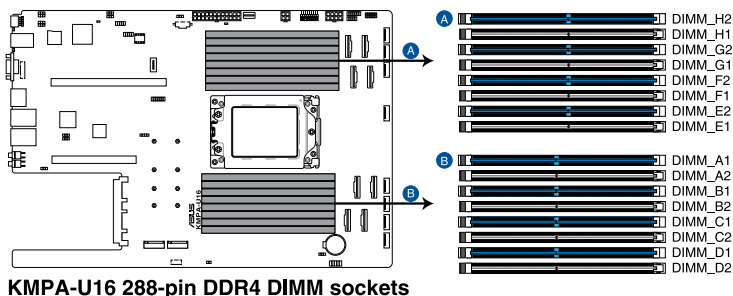

2.4.2 Memory Configurations

You may install 16GB, 32GB, or 64GB RDIMM into the DIMM sockets. If you are not sure on which slots to install the DIMMS, you can use the recommended memory configuration in this section for reference.

	Memory configurations															
	DIMM															
	A1	A2	B1	B2	C1	C2	D1	D2	E1	E2	F1	F2	G1	G2	H1	H2
1 DIMM						✓										
2 DIMMs						✓		✓								
4 DIMMs						✓		✓						✓		✓
6 DIMMs		✓				✓		✓		✓				✓		✓
8 DIMMs		✓		✓		✓		✓		✓		✓		✓	✓	✓
10 DIMMs		✓		✓		✓	✓	✓	✓	✓		✓		✓	✓	✓
12 DIMMs		✓	✓	✓		✓	✓	✓	✓	✓		✓	✓	✓	✓	✓
14 DIMMs		✓	✓	✓	✓	✓	✓	✓	✓	✓	✓	✓	✓	✓	✓	✓
16 DIMMs	✓	✓	✓	✓	✓	✓	✓	✓	✓	✓	✓	✓	✓	✓	✓	✓



- 6 DIMM configuration is recommended for AMD EPYC™ 7003 Series processors under the condition that only 6 channels are to be populated.
- 6 DIMM configuration is not recommended for AMD EPYC™ 7002 Series processors.
- When mixing 2DPC and 1DPC, ensure that each channel's total DIMM size should be equal. The DIMM size of 2DPC should equal to that of 1DPC, for example, if 2DPC is using a 32GB memory module (32GB * 2), then a 64GB memory module should be installed for 1DPC.
- All memory modules for 2DPC should be the same.
- Always install DIMMs with the same CAS latency. For optimum compatibility, it is recommended that you obtain memory modules from the same vendor.

2.4.3 Installing a DIMM



Ensure to unplug the power supply before adding or removing DIMMs or other system components. Failure to do so may cause severe damage to both the motherboard and the components.

1. Unlock a DIMM socket by pressing the retaining clips outward.
2. Align a DIMM on the socket such that the notch on the DIMM matches the DIMM slot key on the socket.

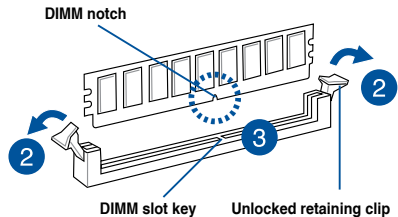

A DIMM is keyed with a notch so that it fits in only one direction. DO NOT force a DIMM into a socket in the wrong direction to avoid damaging the DIMM.

3. Hold the DIMM by both of its ends then insert the DIMM vertically into the socket. Apply force to both ends of the DIMM simultaneously until the retaining clips snaps back into place.

Ensure that the DIMM is sitting firmly on the DIMM slot.

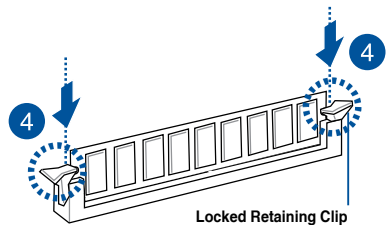

Always insert the DIMM into the socket VERTICALLY to prevent DIMM notch damage.

2.4.4 Removing a DIMM

1. Remove the chassis cover. For more information, see the section **Chassis cover**.
2. Simultaneously press the retaining clips outward to unlock the DIMM.
3. Remove the DIMM from the socket.

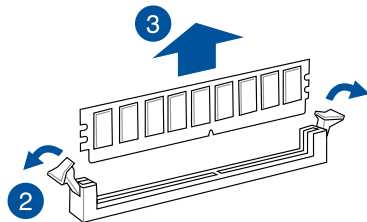

Support the DIMM lightly with your fingers when pressing the retaining clips. The DIMM might get damaged when it flips out with extra force.

2.5 Storage devices

The system supports twenty-four (24) 2.5" hot-swap SATA/SAS/NVMe storage devices (up to 8 x NVMe/SATA + 16 x NVMe/SATA/SAS). The storage device installed on the storage device tray connects to the motherboard SATA/SAS/NVMe ports via the SATA/SAS/NVMe backplane.

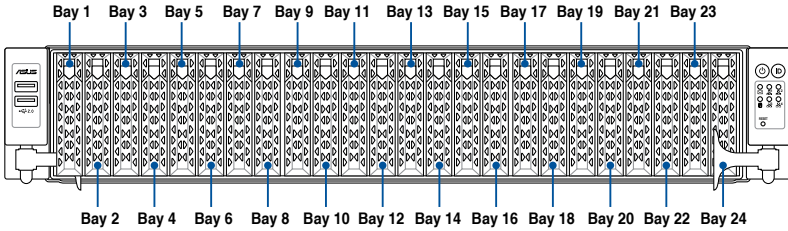

- Bay 1 to bay 24 supports NVMe for 24 NVMe configuration.
- Bay 5 to bay 20 supports NVMe; others support SATA/SAS* from HBA/RAID for 16 NVMe configuration.
- Bay 5 to bay 16 supports NVMe, others supports SATA/SAS* for 12 NVMe configuration.

* SAS support only from HBA/RAID card.

2.5.1 Installing a 2.5" hot-swap SATA/SAS/NVMe storage device

1. Press the spring lock then pull the tray lever outward to release the storage device tray. The storage device tray ejects slightly after you pull out the lever.
2. Firmly hold the tray lever and pull the storage device tray out of the bay.

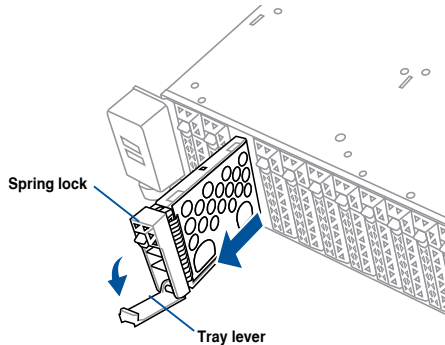

3. Prepare the 2.5" storage device and the bundled set of screws.
4. Place the 2.5" storage device into the storage device tray then secure it with four screws.

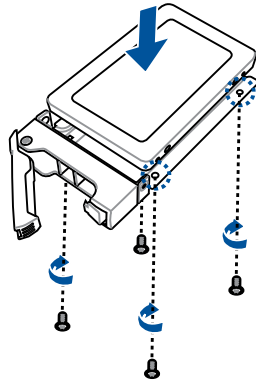

5. Push the storage device tray and storage device assembly all the way into the depth of the bay until the tray lever and spring lock clicks and secures the storage device tray in place.

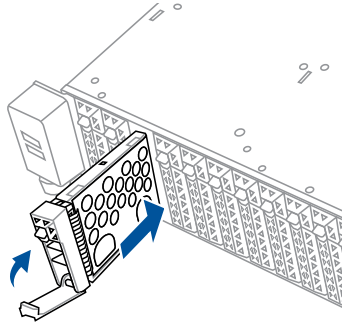

- When installed, the SATA/SAS/NVMe connector on the storage device connects to the SATA/SAS/NVMe interface on the backplane.
- The storage device tray is correctly placed when its front edge aligns with the bay edge.

6. Repeat steps 1 to 5 to install the other SATA/SAS/NVMe storage devices.

2.6 Expansion slot

The barebone server comes with a maximum of five (5) PCIe slots (on selected models). These slots are pre-installed with two (2) riser card brackets for installing PCIe expansion cards. You need to remove these expansion card brackets if you want to install PCIe expansion cards.

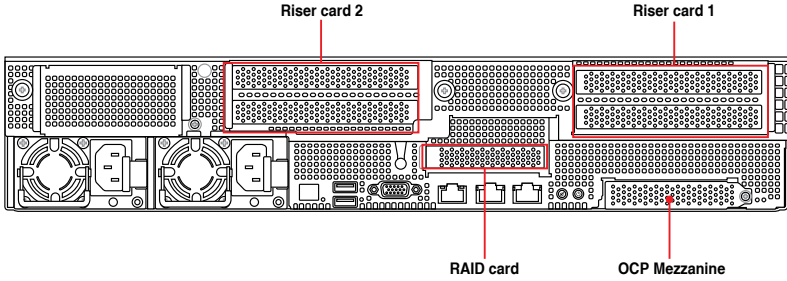

Riser card bracket 1

PCIe slot	Operation mode	
	Mode 1	Mode 2
Slot 1*	x16	x8
Slot 2*	-	x8
Slot 3 (Internal)	x8	x8

Riser card bracket 2

PCIe slot	Operation mode	
	Mode 1	Mode 2
Slot 4*	x16	x8
Slot 5*	-	x8

* Slot 1, 2, 4, and 5 will not be available for 24 NVMe configuration.

2.6.1 Installing an expansion card to the left PCIe riser card bracket (on selected models)

The pre-installed left PCIe riser card bracket on the PCIE1 slot has two PCIe x16 slots. The two PCIe x16 slots provides x16 Gen4 links, with the top PCIe slot's signal provided from CPU1 and the bottom PCIe slot's signal coming from CPU2.

To install PCIe x16 (Gen4 x16 link) proprietary cards, such as a graphics card to the left PCIe riser card bracket:

1. Loosen the thumbscrews (A) securing the left PCIe riser card bracket to the chassis, then lift the left PCIe riser card bracket upwards (B) out of the chassis to detach it from the PCIe x16 slot on the motherboard.

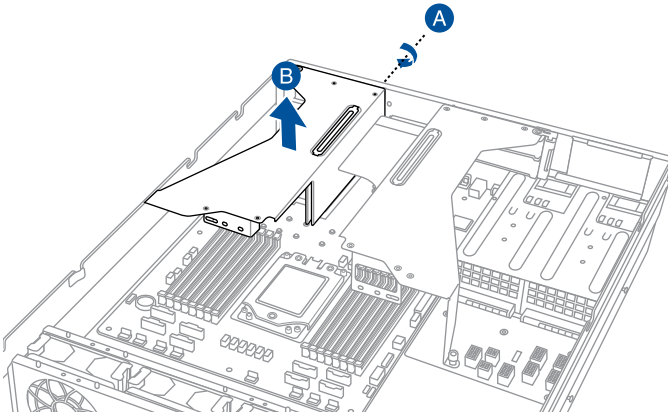

2. Prepare your expansion card and flip the left PCIe riser card bracket over.
3. Flip the metal bracket lock open (A) then slide the two metal brackets out of the left PCIe riser card bracket (B) and remove them.

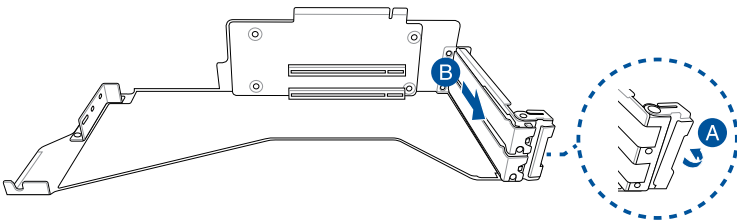

4. Install your expansion card to the PCIe x16 slot on the left PCIe riser card bracket (A), then secure your expansion card to the PCIe riser card bracket using the bundled screws (B). The illustration below is an example of a graphics card.



The amount of screws required may vary between expansion cards, only secure a bundled screw if a screw hole on the expansion card is aligned with the screw hole on the PCIe riser card.

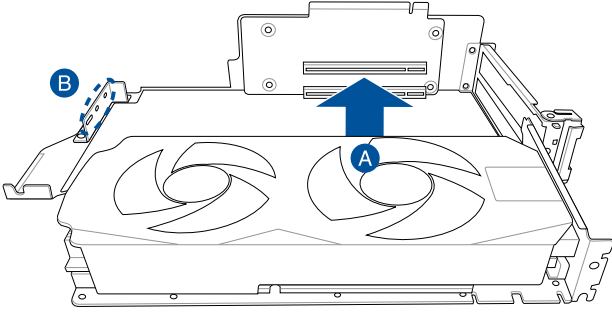

5. Once your expansion card is installed, flip the metal bracket lock back to secure the expansion card to the left PCIe riser card bracket.

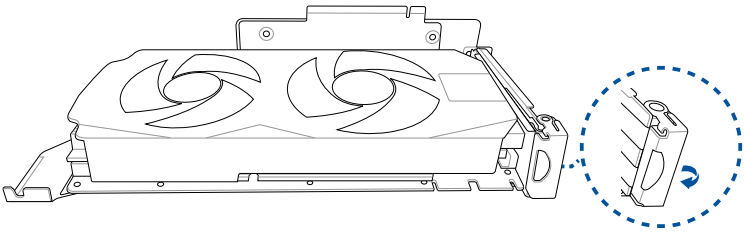

6. Align the left PCIe riser card bracket to the notch holes on the chassis and the **PCIe1** slot on the motherboard. Please refer to the illustration below for the locations of the notch holes on the chassis.



Ensure that no cables are below or in the way of the PCIe riser card bracket when installing it to the chassis.

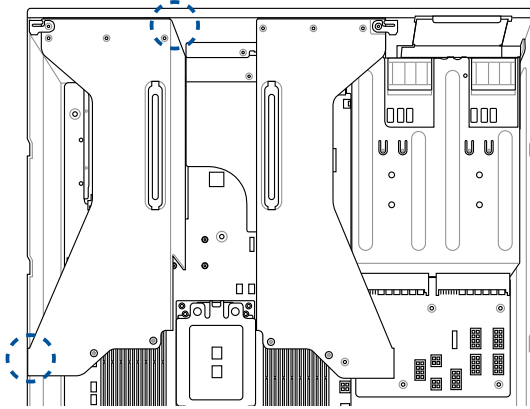

7. Push the left PCIe riser card bracket down until it is seated firmly in the chassis.



Ensure that no cables are below or in the way of the PCIe riser card bracket when installing it to the chassis.

8. Secure the left PCIe riser card bracket with the thumbscrews.

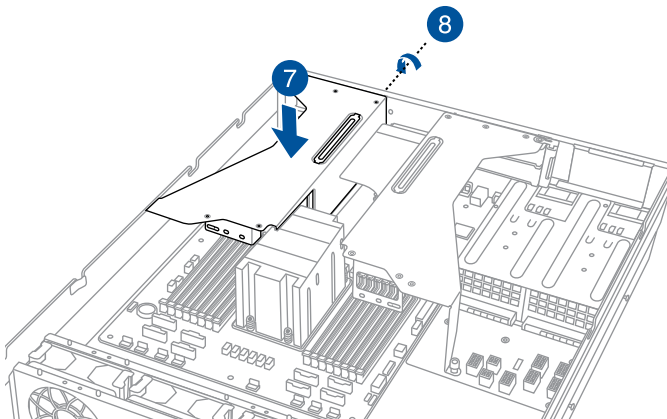

2.6.2 Installing an expansion card to the right PCIe riser card bracket (on selected models)

The pre-installed right PCIe riser card bracket on the PCIe2 slot has three PCIe x16 slots, two PCIe x16 slots and one PCIe x8 slot. The two PCIe x16 slots provides x16 Gen4 links, with the top PCIe slot's signal provided from CPU1 and the bottom PCIe slot's signal coming from CPU2. The PCIe x8 slot is reserved only for a PIKE II card.

To install PCIe x16 (Gen4 x16 link) proprietary cards, such as a graphics card to the right PCIe riser card bracket:

1. Remove the screw from the PSU air duct, then lift and remove the PSU air duct from the chassis.

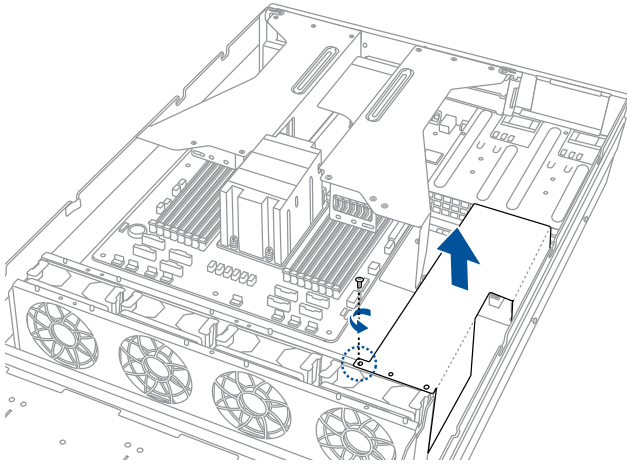

2. Loosen the two (2) thumbscrews (A) securing the right PCIe riser card bracket to the chassis, then lift the right PCIe riser card bracket upwards (B) out of the chassis to detach it from the PCIe x16 slot on the motherboard.

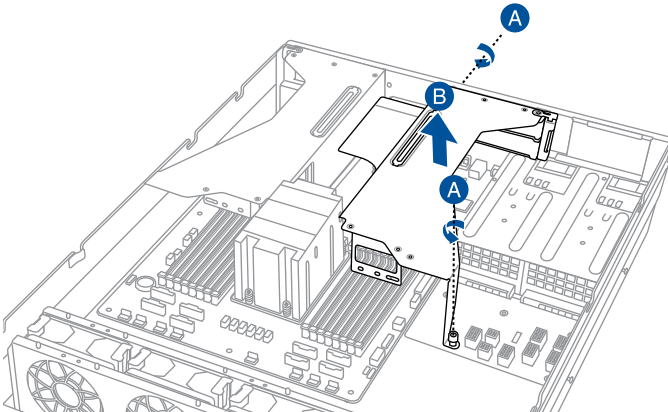

3. Prepare your expansion card and flip the right PCIe riser card bracket over.
4. Flip the metal bracket lock open (A) then slide the two metal brackets out of the right PCIe riser card bracket (B) and remove them.

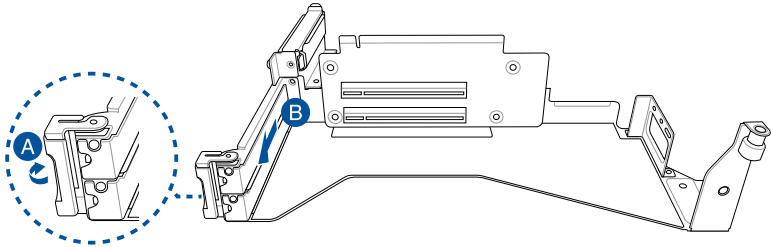

5. Install your expansion card to the PCIe x16 slot on the right PCIe riser card bracket (A), then secure your expansion card to the PCIe riser card bracket using the bundled screws (B). The illustration below is an example of a graphics card.



The amount of screws required may vary between expansion cards, only secure a bundled screw if a screw hole on the expansion card is aligned with the screw hole on the PCIe riser card.

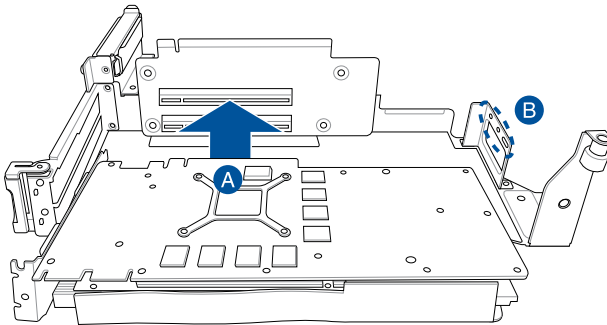

6. Once your expansion card is installed, flip the metal bracket lock back to secure the expansion card to the right PCIe riser card bracket.

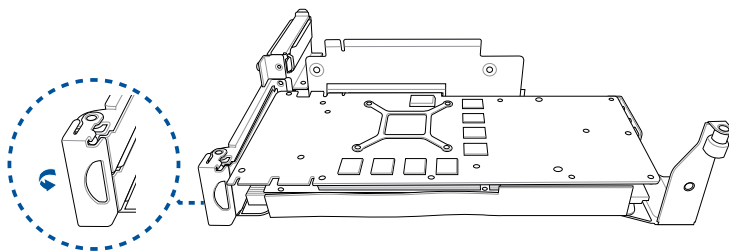

7. Align the right PCIe riser card bracket to the notch hole on the rear of the chassis and the **PCIe2** slot on the motherboard. Please refer to the illustration below for the location of the notch hole on the rear of the chassis.



Ensure that no cables are below or in the way of the PCIe riser card bracket when installing it to the chassis.

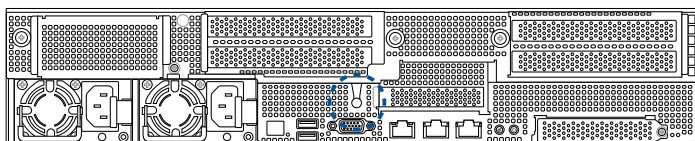

8. Push the right PCIe riser card bracket down until it is seated firmly in the chassis.



Ensure that no cables are below or in the way of the PCIe riser card bracket when installing it to the chassis.

9. Secure the right PCIe riser card bracket with the two (2) thumbscrews.

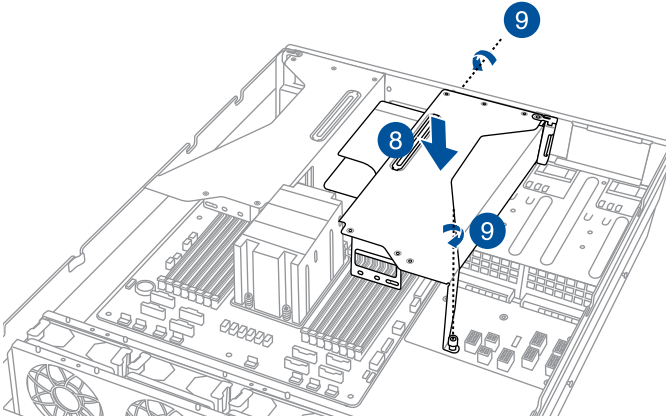

10. Replace the PSU airduct and secure it using the screw removed previously.

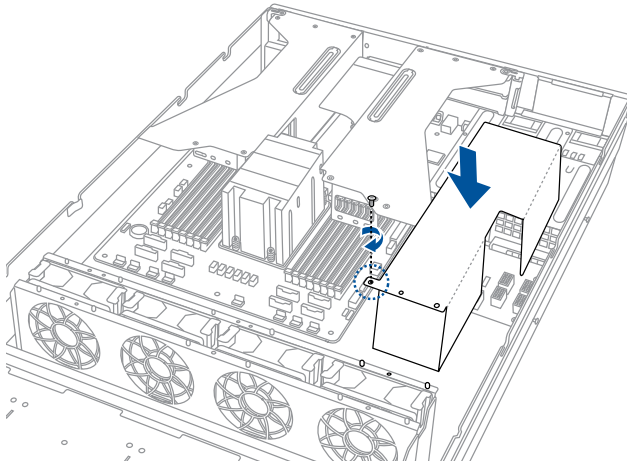

2.6.3 Installing a ASUS PIKE II card to the right PCIe riser card bracket

To install a ASUS PIKE II card to the right PCIe riser card:

1. Follow step 1 of the **Installing an expansion card to the right PCIe riser card bracket (on selected models)** section to remove the right PCIe riser card bracket.
2. Prepare your ASUS PIKE II card and flip the right PCIe riser card bracket over.
3. Slightly pull the lock latch outwards (A), then rotate the lock latch clockwise (B) and remove the metal bracket (C).

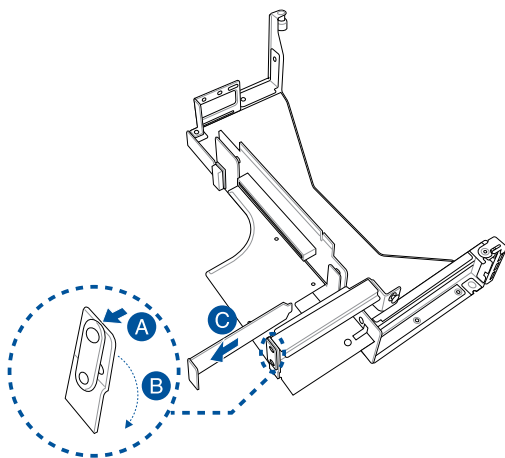

4. Insert the ASUS PIKE II card into the PCIe x8 slot on the right PCIe riser card (A), then rotate the lock latch counter-clockwise (B) until the lock latch secures the ASUS PIKE II card in place.

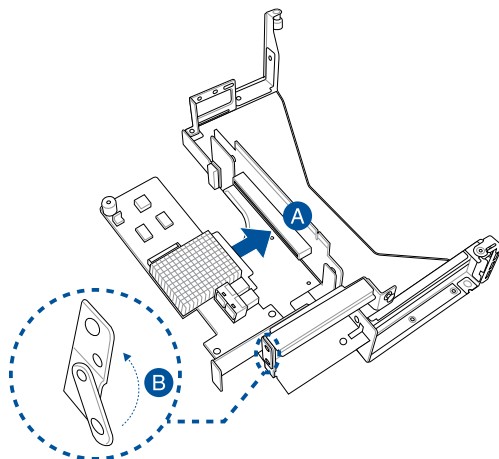

5. Connect the mini SAS HD cables to the ASUS PIKE II card.

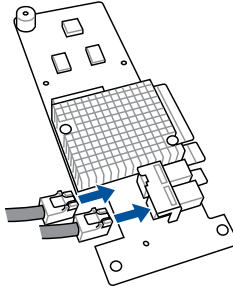

6. Follow steps 6 to 7 of the **Installing an expansion card to the right PCIe riser card bracket (on selected models)** section to reinstall the right PCIe riser card bracket to the system.

2.6.4 Installing an OCP 3.0 card to the OCP 3.0 slot

To install the OCP 3.0 card to the server system:

1. Remove the screw securing the metal bracket of the OCP 3.0 slot (A), then remove the metal bracket (B).

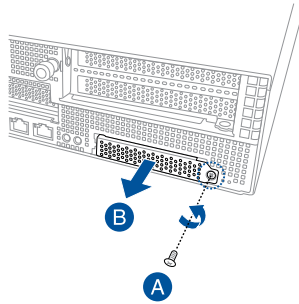

2. Insert and push the OCP 3.0 card all the way into the OCP 3.0 slot (A), then secure the OCP 3.0 card using the thumbscrew (B).

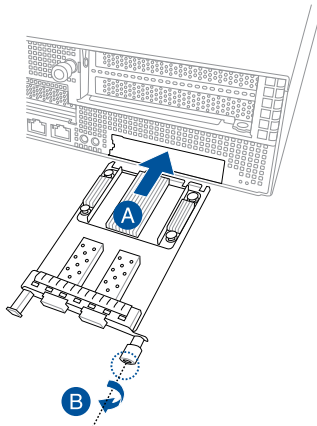

2.6.5 Installing an M.2 (NGFF) card

You may install an M.2 card (supports up to 22110) to the onboard M.2 (NGFF) slot on the motherboard.



NGFF1 supports x4 PCIe link only when a single M.2 card is installed to NGFF1 slot. If both NGFF1 and NGFF2 slots are occupied, both slots will support x2 PCIe link.

1. Loosen the thumbscrews (A) securing the left PCIe riser card bracket to the chassis, then lift the left PCIe riser card bracket upwards (B) out of the chassis to detach it from the PCIe x16 slot on the motherboard.

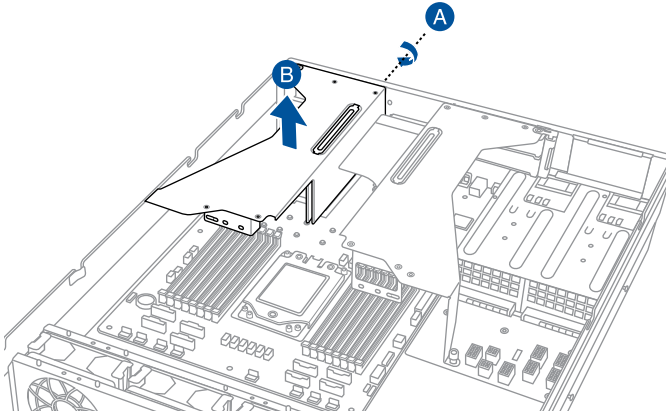

2. Locate the M.2 connector (NGFF1 or NGFF2) on the motherboard.

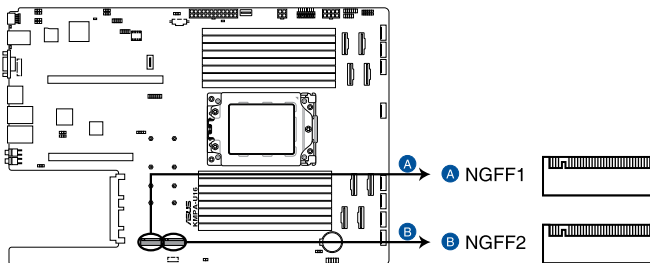

KMPA-U16 NGFF connectors

3. Select an appropriate screw hole on the motherboard for your M.2 card, then secure the bundled stand to the motherboard.
4. Insert the M.2 into the M.2 (NGFF) slot, then secure it using the bundled screw.

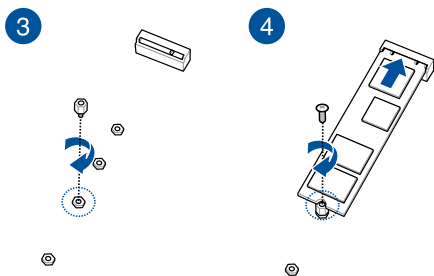

5. Follow steps 6 to 8 in **Installing an expansion card to the left PCIe riser card bracket (on selected models)** section to replace the left PCIe riser card bracket.

2.6.6 Configuring an expansion card

After installing the expansion card, configure it by adjusting the software settings.

1. Turn on the system and change the necessary BIOS settings, if any. See Chapter 5 for information on BIOS setup.
2. Assign an IRQ to the card. Refer to the following tables.
3. Install the software drivers for the expansion card.

Standard Interrupt assignments

IRQ	Priority	Standard function
0	1	System Timer
1	2	Keyboard Controller
2	-	Programmable Interrupt
3*	11	Communications Port (COM2)
4*	12	Communications Port (COM1)
5*	13	--
6	14	Floppy Disk Controller
7*	15	--
8	3	System CMOS/Real Time Clock
9*	4	ACPI Mode when used
10*	5	IRQ Holder for PCI Steering
11*	6	IRQ Holder for PCI Steering
12*	7	PS/2 Compatible Mouse Port
13	8	Numeric Data Processor
14*	9	Primary IDE Channel
15*	10	Secondary IDE Channel

* These IRQs are usually available for ISA or PCI devices.

2.7 Cable connections



- The bundled system cables are pre-connected before shipment. You do not need to disconnect these cables unless you are going to remove pre-installed components to install additional devices.
- Refer to Chapter 4 for detailed information on the connectors.

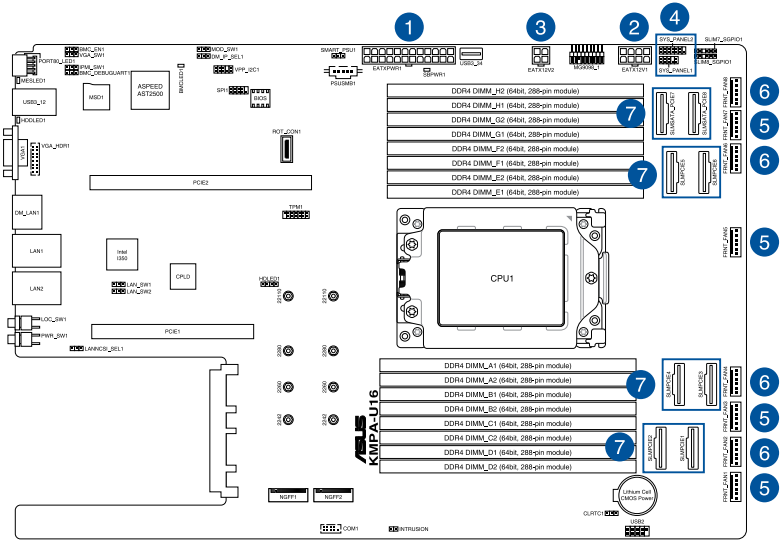

Pre-connected system cables

1. 24-pin EATXPWR1 power connector (connected to power board)
2. 8-pin EATX12V1 power connector (connected to power board)
3. 4-pin EATX12V2 power connector (connected to power board)
4. Panel connector (connected to front I/O board)
5. FRNT_FAN1, FRNT_FAN3, FRNT_FAN5, FRNT_FAN7 System fan connectors (from motherboard to system fans)
6. FRNT_FAN2, FRNT_FAN4, FRNT_FAN6, FRNT_FAN8 System fan connectors (optional, from motherboard to system fans)
7. Slim PCIe connectors (connected to backplane)

2.8 Backplane cabling

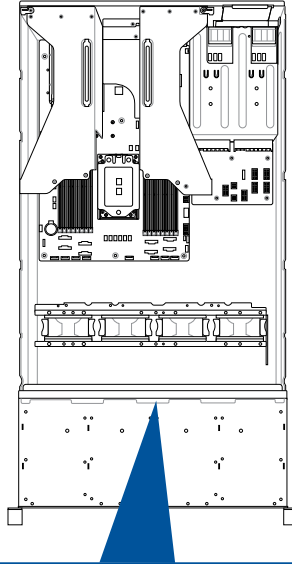

Connects to SLMPCIE connectors on the motherboard, and left and right PCIe riser cards for NVMe support on Bay 1 to Bay 24 depending on your storage device configuration. For more information on storage device configurations, please refer to Storage device configuration and cabling section.

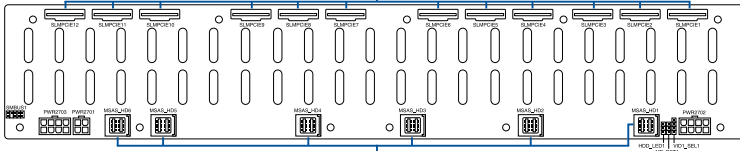

Connects to ASUS PIKE II card or to the SLSMPCIE connectors on the motherboard for SAS/SATA support on Bay 1 to Bay 24 depending on your storage device configuration. For more information on storage device configurations, please refer to Storage device configuration and cabling section.

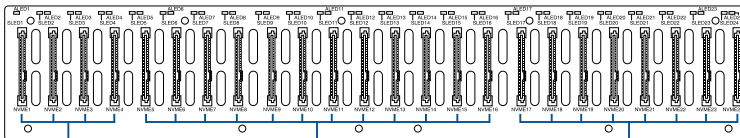

Connects to NVMe/SAS/SATA storage devices (SAS support requires an optional ASUS PIKE II card)

Connects to NVMe storage devices

Connects to NVMe/SAS/SATA storage devices (SAS support requires an optional ASUS PIKE II card)

2.9 Storage device configuration and cabling

This section illustrates some storage configurations that is recommended with your server system. Before you start installing or removing the storage device cables, ensure that you have installed the correct storage devices into the supported bays.



Refer to section **Storage Devices** for details on how to install storage devices.

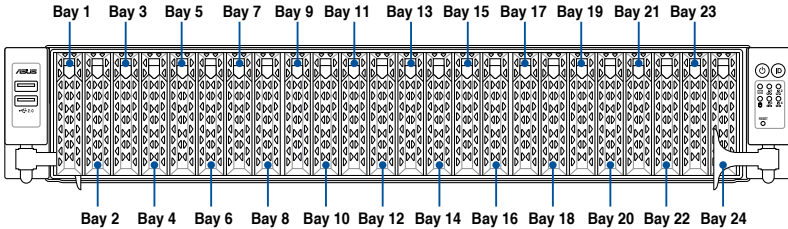

- Bay 1 to bay 24 supports NVMe for 24 NVMe configuration.
- Bay 5 to bay 20 supports NVMe; others support SATA/SAS* from HBA/RAID for 16 NVMe configuration.
- Bay 5 to bay 16 supports NVMe, others supports SATA/SAS* for 12 NVMe configuration.

* SAS support only from HBA/RAID card.

2.9.1 24 x NVMe storage device configuration and cabling (on selected models)



The illustrations in this section are for reference only and may vary between models.

Backplane connector	Cable	Connect to
SLMPCIE1	Slimline PCIe to Slimline PCIe	SLMPCIE1 on left PCIe riser card bracket
SLMPCIE2	Slimline PCIe to Slimline PCIe	SLMPCIE2 on left PCIe riser card bracket
SLMPCIE3	Slimline PCIe to Slimline PCIe	SLMPCIE1 on motherboard
SLMPCIE4	Slimline PCIe to Slimline PCIe	SLMPCIE2 on motherboard
SLMPCIE5	Slimline PCIe to Slimline PCIe	SLMPCIE3 on motherboard
SLMPCIE6	Slimline PCIe to Slimline PCIe	SLMPCIE4 on motherboard
SLMPCIE7	Slimline PCIe to Slimline PCIe	SLMPCIE5 on motherboard
SLMPCIE8	Slimline PCIe to Slimline PCIe	SLMPCIE6 on motherboard
SLMPCIE9	Slimline PCIe to Slimline PCIe	SLMSATAPCIE7 on motherboard
SLMPCIE10	Slimline PCIe to Slimline PCIe	SLMSATAPCIE8 on motherboard
SLMPCIE11	Slimline PCIe to Slimline PCIe	SLMPCIE1 on right PCIe riser card bracket
SLMPCIE12	Slimline PCIe to Slimline PCIe	SLMPCIE2 on right PCIe riser card bracket

1. Install the storage devices into the supported bays.



Refer to section **Storage Devices** for details on how to install storage devices.

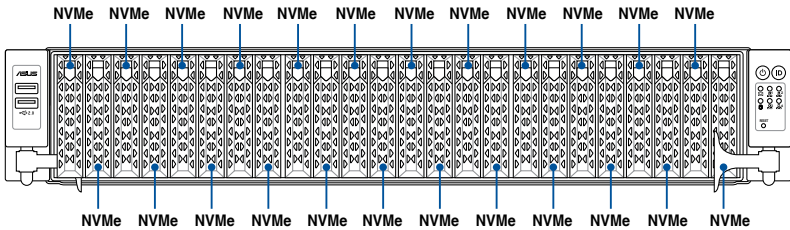

2. Connect the Slimline PCIe cables to the motherboard, PCIe risers, and the backplane.

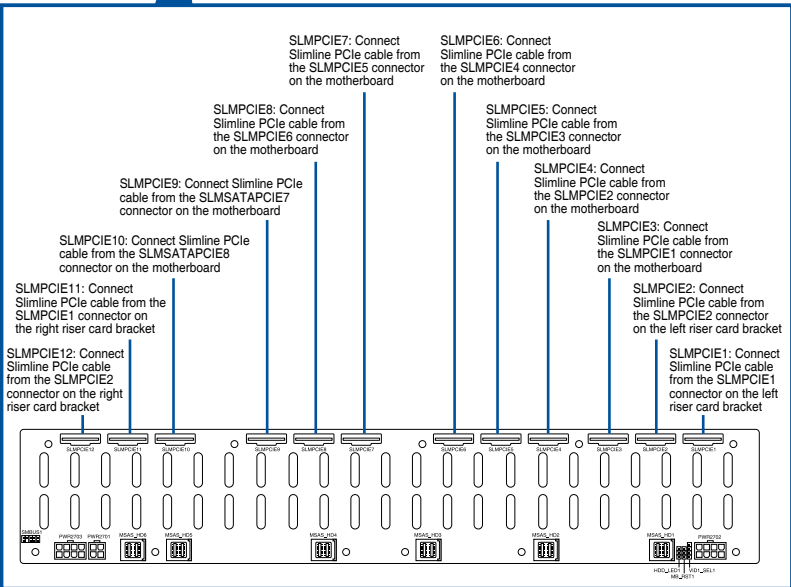
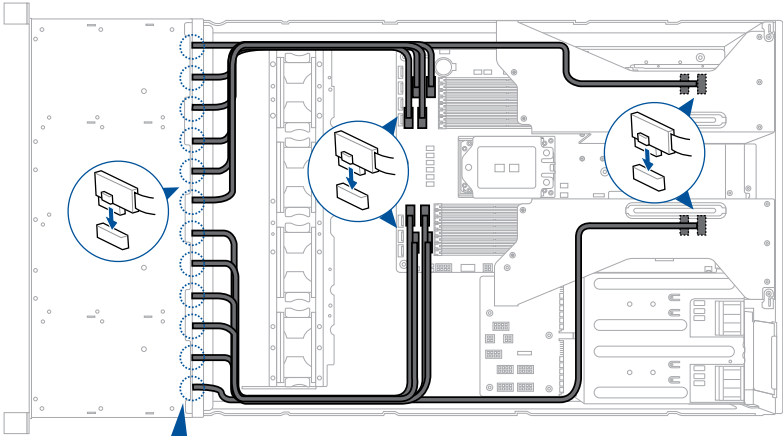

2.9.2 16 x NVMe and 8 x SAS/SATA storage device configuration and cabling



- The illustrations in this section are for reference only and may vary between models.
- This configuration requires an ASUS PIKE II card.

Backplane connector	Cable	Connect to
SLMPCIE3	Slimline PCIe to Slimline PCIe	SLMPCIE1 on motherboard
SLMPCIE4	Slimline PCIe to Slimline PCIe	SLMPCIE2 on motherboard
SLMPCIE5	Slimline PCIe to Slimline PCIe	SLMPCIE3 on motherboard
SLMPCIE6	Slimline PCIe to Slimline PCIe	SLMPCIE4 on motherboard
SLMPCIE7	Slimline PCIe to Slimline PCIe	SLMPCIE5 on motherboard
SLMPCIE8	Slimline PCIe to Slimline PCIe	SLMPCIE6 on motherboard
SLMPCIE9	Slimline PCIe to Slimline PCIe	SLMSATAPCIE7 on motherboard
SLMPCIE10	Slimline PCIe to Slimline PCIe	SLMSATAPCIE8 on motherboard
MSAS_HD1	Mini SAS HD to Mini SAS HD	ASUS PIKE II card
MSAS_HD6	Mini SAS HD to Mini SAS HD	ASUS PIKE II card

1. Install the storage devices into the supported bays.



Refer to section **Storage Devices** for details on how to install storage devices.

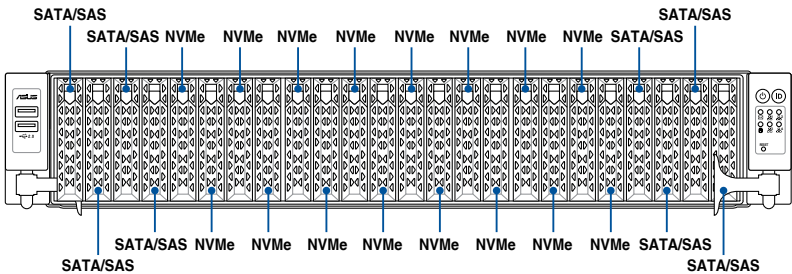

2. Connect the Slimline PCIe cables to the motherboard and the backplane.
3. Connect the Mini SAS HD cables to the ASUS PIKE II card and the backplane.

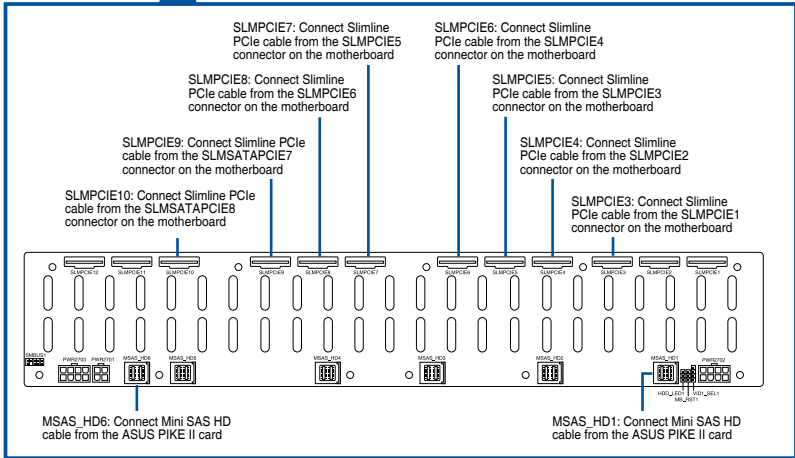
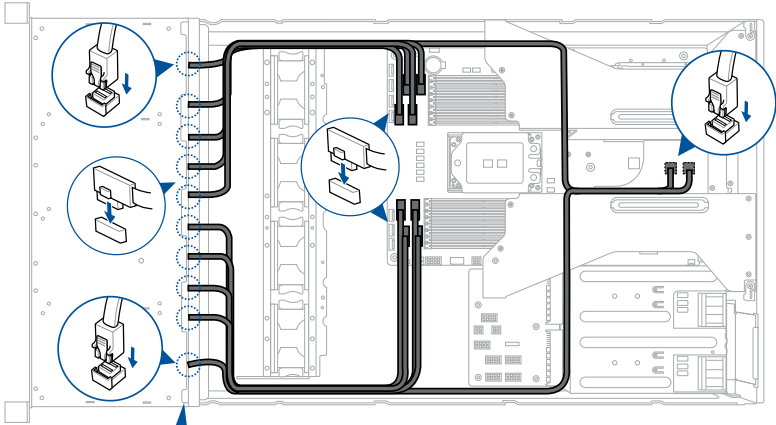

2.9.3 12 x NVMe and 12 x SAS/SATA storage device configuration and cabling



The illustrations in this section are for reference only and may vary between models.

Backplane connector	Cable	Connect to
SLMPCIE3	Slimline PCIe to Slimline PCIe	SLMPCIE1 on motherboard
SLMPCIE4	Slimline PCIe to Slimline PCIe	SLMPCIE2 on motherboard
SLMPCIE5	Slimline PCIe to Slimline PCIe	SLMPCIE3 on motherboard
SLMPCIE6	Slimline PCIe to Slimline PCIe	SLMPCIE4 on motherboard
SLMPCIE7	Slimline PCIe to Slimline PCIe	SLMPCIE5 on motherboard
SLMPCIE8	Slimline PCIe to Slimline PCIe	SLMPCIE6 on motherboard
MSAS_HD1	Slimline PCIe to Mini SAS HD	SLMSATAPCIE7 on motherboard
MSAS_HD5 and MSAS_HD6	Slimline PCIe to Mini SAS HD	SLMSATAPCIE8 on motherboard

1. Install the storage devices into the supported bays.



Refer to section **Storage Devices** for details on how to install storage devices.

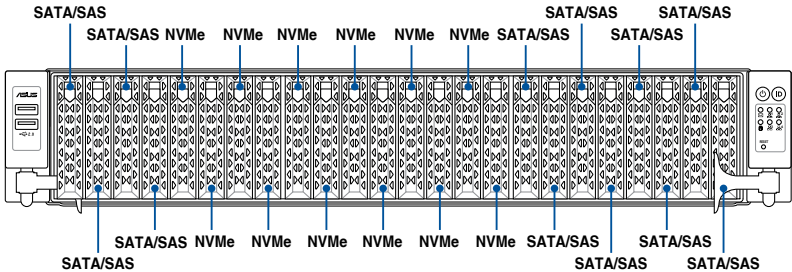

2. Connect the Slimline PCIe cables to the motherboard and the backplane.
3. Connect the Slimline PCIe to Mini SAS HD cables to the motherboard and the backplane.

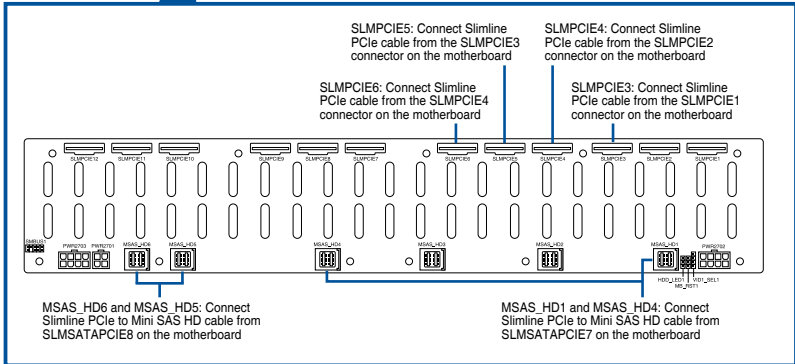
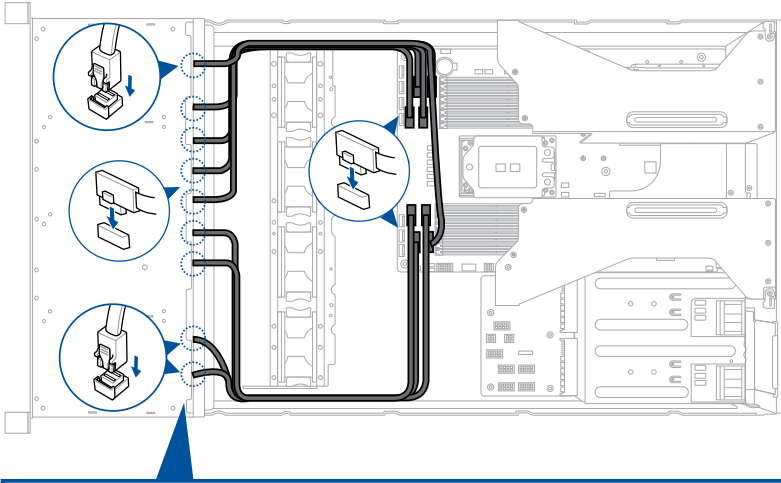

2.10 Removable/optional components

This section explains how to install optional components into the system and covers the following components:

1. System fans
2. Redundant power supply module



Ensure that the system is turned off before removing any components.



You may need to remove previously installed component or factory shipped components when installing optional components.

2.10.1 System fans

To remove the system fans:

1. Locate the fan you want to replace.
2. Press the retaining clip (A) and lift upward (B) to remove the fan.

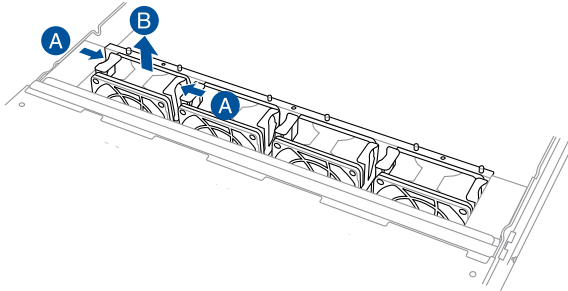

To reinstall the system fans:

1. Prepare the fan with the same model and size.
2. Install the fan to the fan cage.

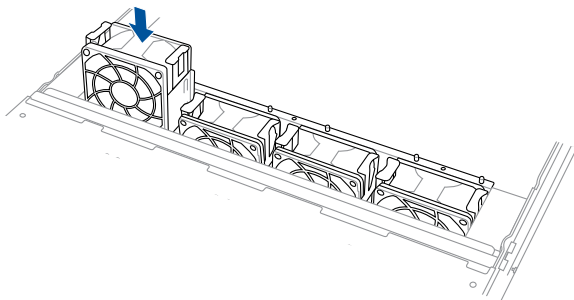

The fan can only be installed in one direction. If the fan cannot be installed, turn it around and try again.

2.10.2 Redundant power supply module

To replace a failed redundant power supply module:

1. Lift up the power supply module lever.
2. Hold the power supply module lever and press the PSU latch, then pull the power supply module out of the system chassis.

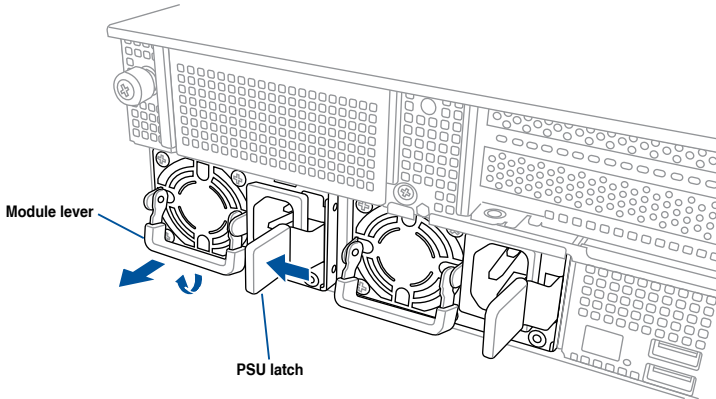

3. Prepare the replacement power supply module.
4. Insert the replacement power supply module into the chassis then push it inwards until the latch locks into place.

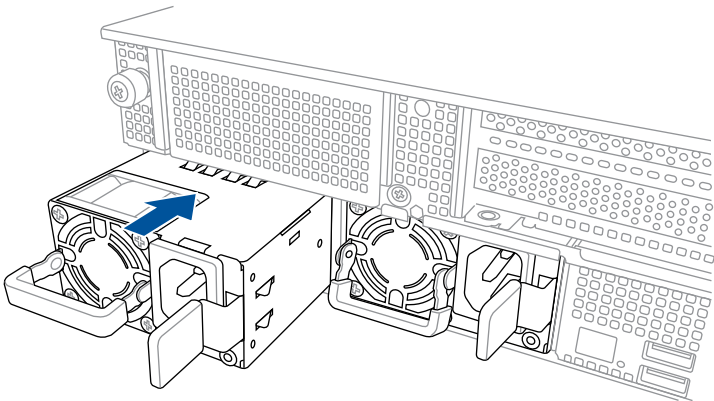

Installation Options

3

This chapter describes how to install the optional components and devices into the barebone server.

3.1 Tool-less Friction Rail Kit

The tool less design of the rail kit allows you to easily install the rack rails into the server rack without the need for additional tools. The kit also comes with a metal stopping bracket that can be installed to provide additional support and stability to the server.

The tool-less rail kit package includes:

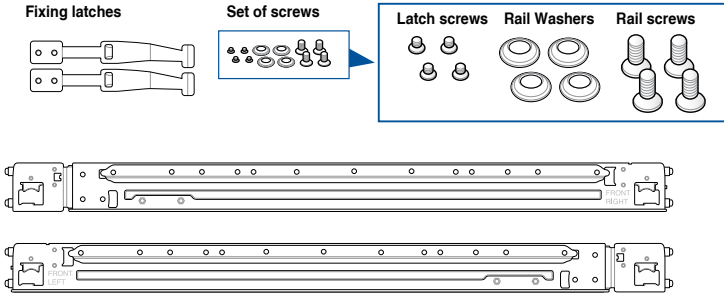

3.1.1 Installing the tool-less rack rail

To install the tool-less rack rails into the rack:

1. Secure the two fixing latches to the two sides of the server using the set of latch screws.



The locations of the screw holes vary with different server models. Refer to your server user manual for details.

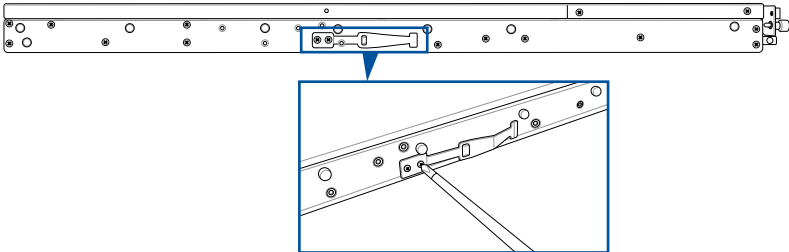

2. Select a desired space and place the appropriate rack rail (left and right) on opposite positions on the rack.



A 1U space is consists of three square mounting holes with two thin lips on the top and the bottom.

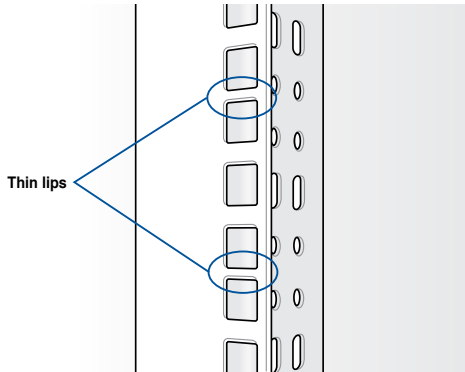

3. Press the spring lock, then insert the studs into the selected square mounting holes on the rack post.
4. Press the spring lock on the other end of rail then insert the stud into the mounting hole on the rack post. Extend the rack rail, if necessary.
5. Perform steps 3 to 4 for the other rack rail.



Ensure that the installed rack rails (left and right) are aligned, secured, and stable in place.

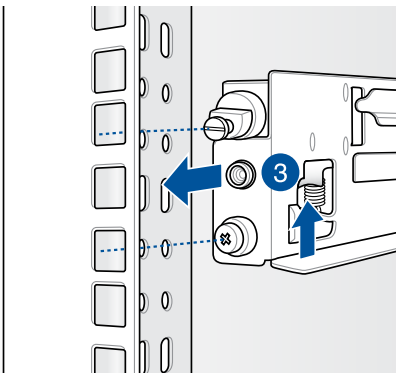

6. Lift the server chassis and insert it into the rack rail.



- Ensure that the rack rail cabinet and the rack posts are stable and standing firmly on a level surface.
- We strongly recommend that at least two able-bodied persons perform the steps described in this guide.
- We recommend the use of an appropriate lifting tool or device, if necessary.

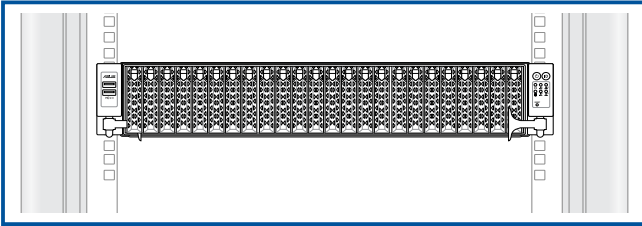

Ensure to include the side knots on the two sides of the server in the rack rail holders.



The illustrations shown above are for reference only.

3.1.2 Rail kit dimensions

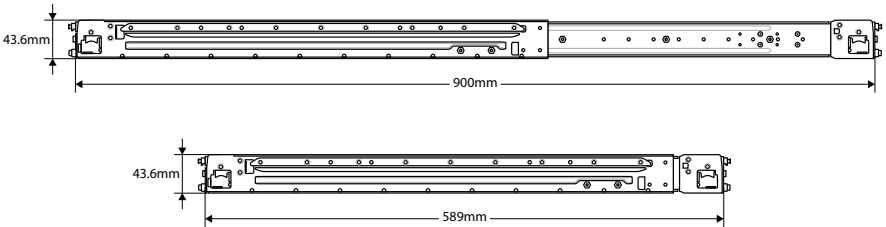



3.2 Ball bearing Rail Kit

The rail kit package includes:

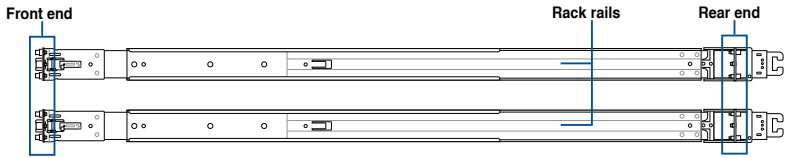
2 x 1200 mm rack rails (or 2 x 1000 mm rack rails)



 4 x #6-32X4L screws

 4 x M4X4L screws

 8 x ϕ 17.1 screws

 8 x #10-32 screws
(or 10 x #10-32 screws for 1000 mm rack rails)

 2 x M5X20L screws



- The bundled screw package includes different types of screws for you to choose from, not all screws are required for the installation.
- Package content and specifications are subject to change without notice.

3.2.1 Attaching the rack rails



- Ensure that the rack rail cabinet and the rack posts are stable and standing firmly on a level surface.
- We strongly recommend that at least two able-bodied persons perform the steps described in this guide.
- We recommend the use of an appropriate lifting tool or device, if necessary.



- The installation steps in this section uses a **1200 mm rack rail** as an example, the installation steps for a **1000 mm rack rail** is exactly the same.
- The illustrations in this section are for reference only.

Installing the rack rail

To install the rack rails into the rack:

1. Select a desired space on the rack.



A 1U space consists of three square mounting holes with two thin lips on the top and the bottom.

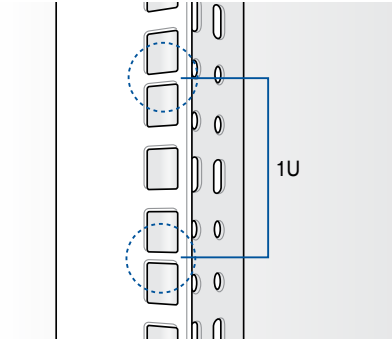

2. Align and insert the front end of the appropriate rack rail (left and right) into the front rack post.

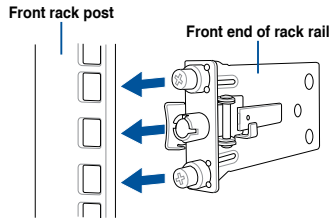

3. Press the spring lock on the rear end of the rack rail and insert the studs into the selected mounting holes on the rear rack post.

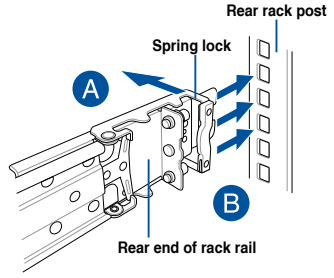

4. Slide the intermediate rail out of the outer rail until it clicks to a stop.

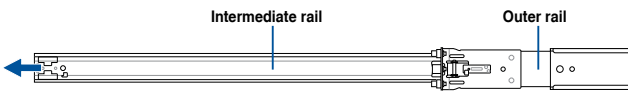

5. Slide the inner rail out of the intermediate rail until it clicks to a stop. Slide the white release tab outwards and remove the inner rail completely from the intermediate rail.

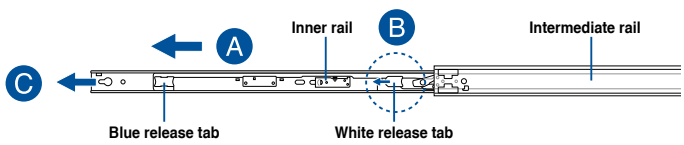

The blue release tab is available on 1200 mm rack rails. This blue release tab is used to further extend or retract the inner rail.

6. Repeat steps 2 to 5 for the other rack rail.



Ensure that the installed rack rails (left and right) are aligned, secured, and stable in place.

7. Remove the three (3) screws from both left and right sides of the server system chassis, then remove the metal plate.



The illustration below only shows one side of the server system chassis, but the screws on the other side should be at the same place.

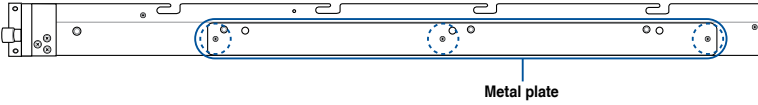

8. Align the inner rails with the studs on both sides of the server system, install the inner rails to the server system, then slide the inner rails toward the rear of the server system until it locks in place.

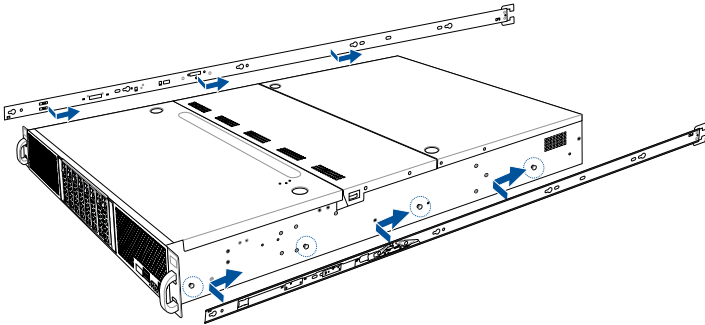

9. Secure the inner rails on both sides of the server system using the #6-32X4L screws.

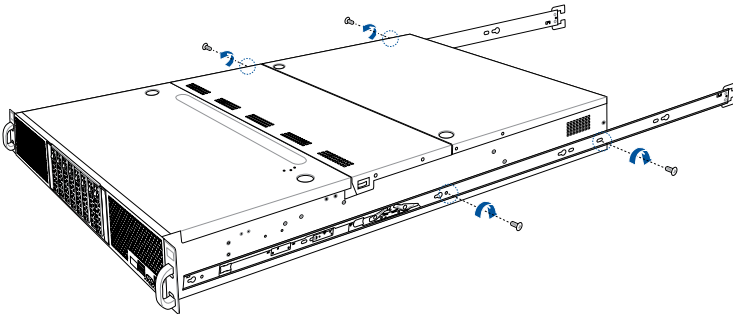

10. Align the server system and gently insert it into the rack rails.

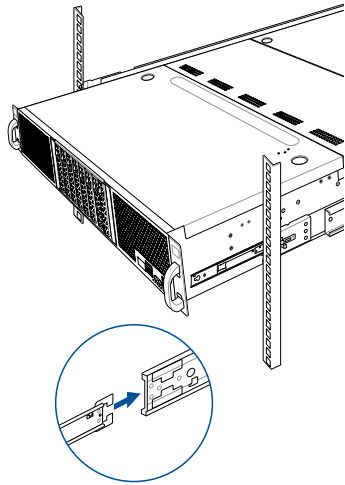

11. (optional) Use the M5X20L screws to secure the rack rails to the rack post.

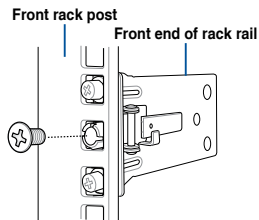

12. Gently push the server system until it is completely installed into the rack rail.
(optional) For 1200 mm rack rails, if the inner rail clicks to a stop while you are installing the server system into the rack rails, slide the blue release tab outwards and gently push the server system until it is completely installed into the rack rail.

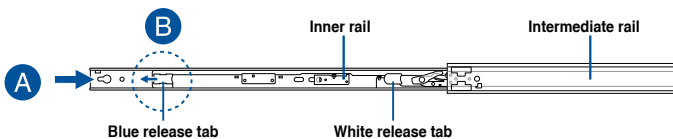

The blue release tab is available on 1200 mm rack rails. This blue release tab is used to further extend or retract the inner rail.

RS520A-E11 Front View

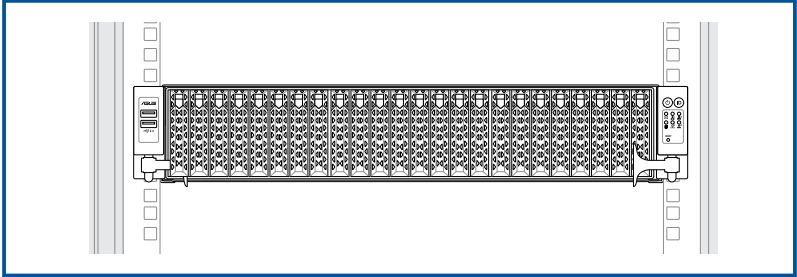

3.3 Cable management arm (optional for 1200 mm rack rails)

You can install an additional cable management arm (CMA) to the rack rails to help you manage the cables from your server system. The CMA is designed with movable parts that allow you to move the server system along the rack rail without the need to remove the CMA.

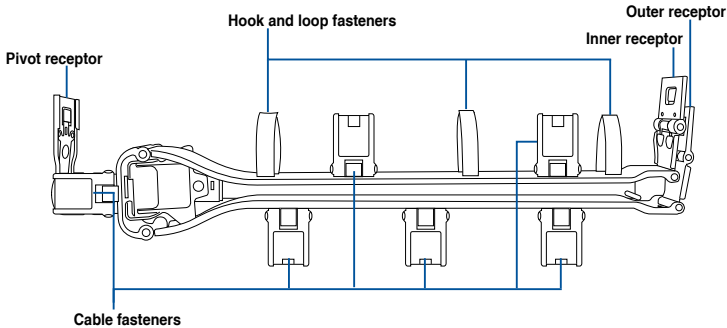

3.3.1 Attaching the cable management arm

Installing the cable management arm

To install the cable management arm:

1. Install the rack rails into the rack.



Refer to section **Rail Kit** for the steps on installing the rack rails into the rack.

2. Press the round button on the pivot receptor, then rotate the pivot receptor to the left or right for a left pivot configuration or right pivot configuration.

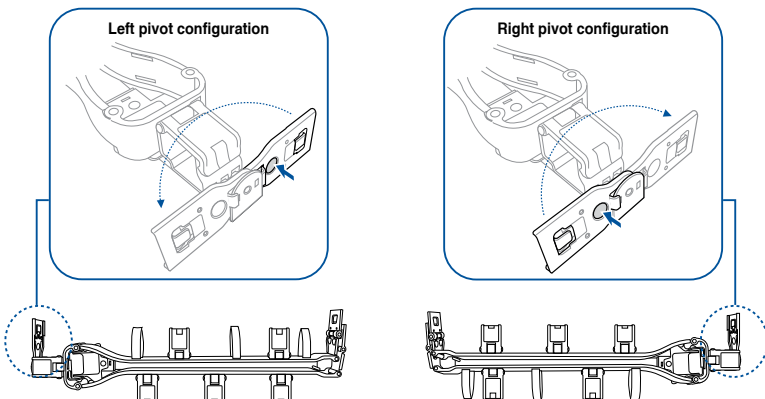

3. Align the three receptors on the CMA with the connectors on the rack rails.

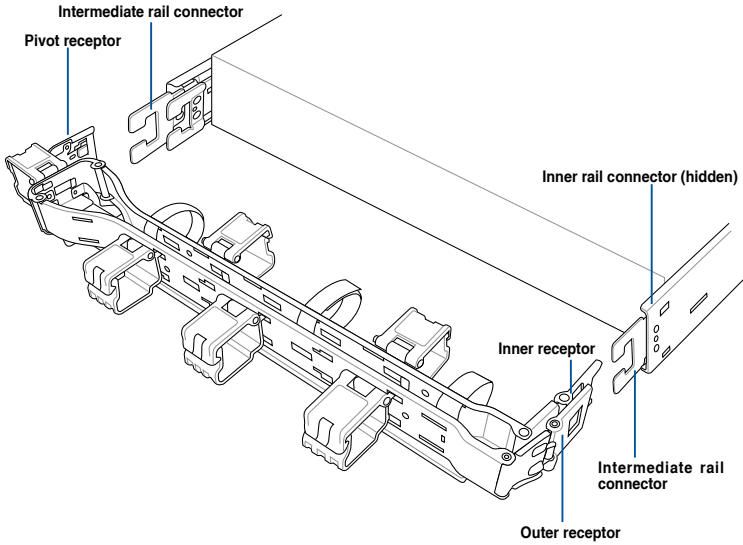

The installation steps in this section uses a **Left pivot configuration** as an example, the installation steps for a **Right pivot configuration** is similar.

4. Align and connect the inner receptor on the CMA with the connector on the inner rail.

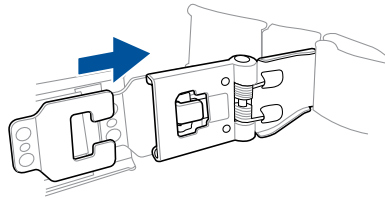

5. Align and connect the outer receptor on the CMA with the connector on the intermediate rail.

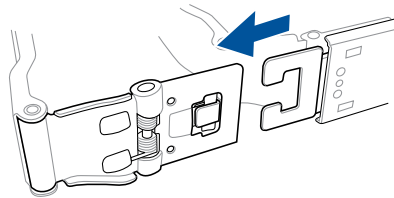

- Align and connect the pivot receptor on the CMA with the connector on the other intermediate rail.

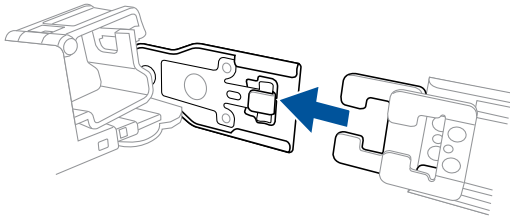

- Pass the cables from the server system through the hook and loop fasteners and the cable fasteners on the CMA to complete.

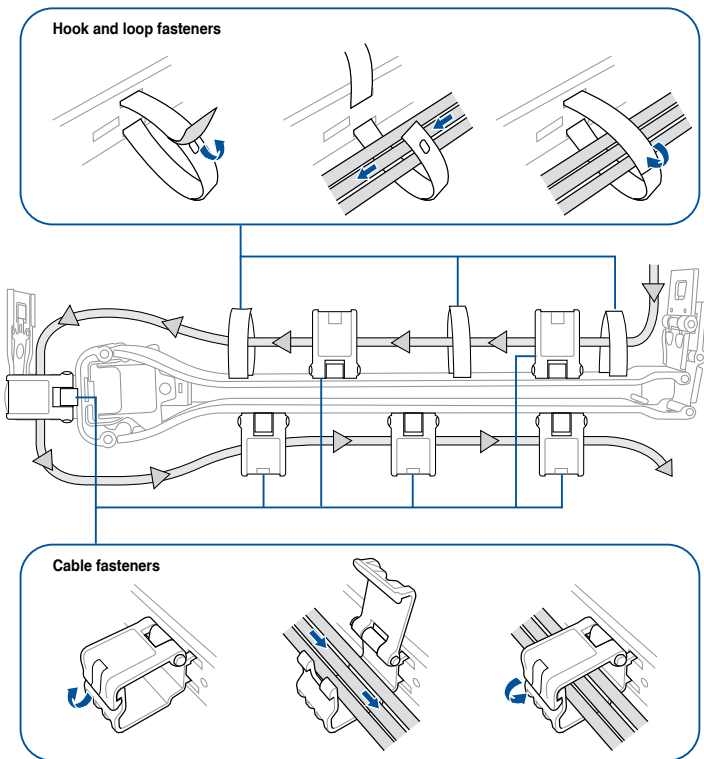

Motherboard Information

4

This chapter includes the motherboard layout and brief descriptions of the jumpers and internal connectors.

Layout contents

Jumpers	Page
1. Clear RTC RAM (3-pin CLRTC1)	4-4
2. VGA controller setting (3-pin VGA_SW1)	4-5
3. LANNCSI setting (3-pin LANNCSI_SEL1)	4-5
4. Baseboard Management Controller setting (3-pin BMC_EN1)	4-6
5. DMLAN setting (3-pin DM_IP_SEL1)	4-6
6. IPMI SW setting (3-pin IPMI_SW1)	4-7
7. Smart Ride Through (SmaRT) setting (3-pin SMART_PSU1)	4-7
8. LAN controller settings (3-pin LAN_SW1-2)	4-8

Onboard LEDs	Page
1. Standby Power LED (SBPWR1)	4-9
2. Baseboard Management Controller LED (BMCLED1)	4-9
3. Message LED (MESLED1)	4-10
4. Hard disk activity LED (HDDLED1)	4-10

Internal connectors	Page
1. Slim PCIe connector (SLIMPCIE1-10)	4-11
2. Slim SATA PCIe connector (SLMSATA_PCIE7-8)	4-11
3. USB 2.0 connector (10-1 pin USB2)	4-12
4. USB 3.2 Gen 1 connector (USB3_34)	4-12
5. Chassis Intrusion (2-pin INTRUSION1)	4-13
6. Serial port connector (10-1 pin COM1)	4-13
7. System fan connectors (6-pin FRNT_FAN1-8)	4-14
8. TPM connector (14-1 pin TPM1)	4-15
9. M.2 (NGFF) card connector (NGFF1-2)	4-15
10. Power connectors (24-pin EATXPWR; 8-pin EATX12V1; 4-pin EATX12V2)	4-16
11. VGA connector (16-pin VGA_HDR1)	4-16
12. Micro SD card slot (MSD1)	4-17
13. Hard disk activity LED connector (4-pin HDLED1)	4-17
14. System panel connector (10-1 pin SYS_PANEL1; 14-1 pin SYS_PANEL2)	4-18
15. VPP_I2C1 connector (10-1 pin VPP_I2C1)	4-19
16. BMC Debug UART connector (3-pin BMC_DEBUGUART1)	4-19
17. Smart Ride Through (SmaRT) setting (3-pin SMART_PSU1)	4-20
18. SLMPCIE SGPIO connector (6-1 pin SLM7_SGPIO1, SLM8_SGPIO1)	4-20

4.2 Jumpers

1. Clear RTC RAM (3-pin CLRTC1)

This jumper allows you to clear the Real Time Clock (RTC) RAM in CMOS. You can clear the CMOS memory of date, time, and system setup parameters by erasing the CMOS RTC RAM data. The onboard button cell battery powers the RAM data in CMOS, which include system setup information such as system passwords.

To erase the RTC RAM:

1. Turn OFF the computer and unplug the power cord.
2. Move the jumper cap from pins 1–2 (default) to pins 2–3. Keep the cap on pins 2–3 for about 5–10 seconds, then move the cap back to pins 1–2.
3. Plug the power cord and turn ON the computer.
4. Hold down the key during the boot process and enter BIOS setup to re-enter data.



Except when clearing the RTC RAM, never remove the cap on CLRTC1 jumper default position. Removing the cap will cause system boot failure!



If the steps above do not help, remove the onboard battery and move the jumper again to clear the CMOS RTC RAM data. After the CMOS clearance, reinstall the battery.

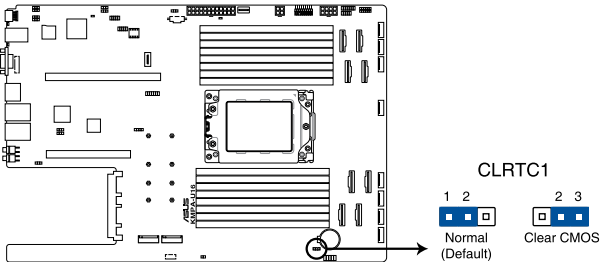

KMPA-U16 Clear RTC RAM setting

2. VGA controller setting (3-pin VGA_SW1)

This jumper allows you to enable or disable the onboard VGA controller. Set to pins 1–2 to activate the VGA feature.

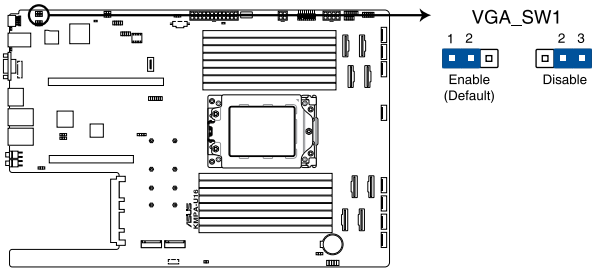

KMPA-U16 VGA setting

3. LANNCSE setting (3-pin LANNCSE_SEL1)

This jumper allows you to select which LAN NCSI function to use.

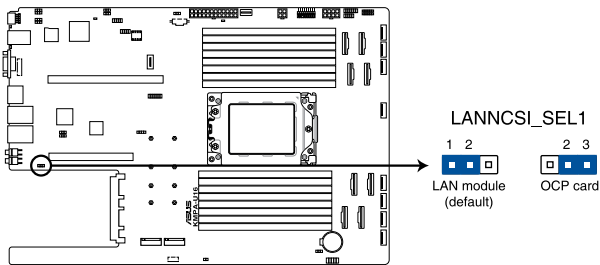

KMPA-U16 LANNCSE setting

4. Baseboard Management Controller setting (3-pin BMC_EN1)

This jumper allows you to enable (default) or disable on-board BMC. Ensure to set this BMC jumper to enabled to avoid system fan control and hardware monitor error.

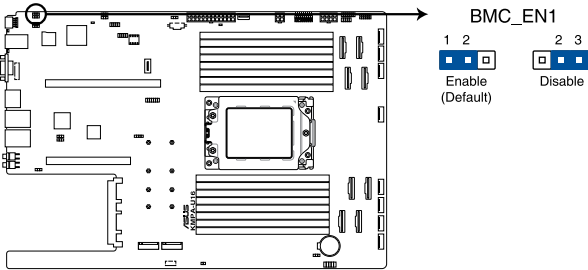

KMPA-U16 BMC setting

5. DMLAN setting (3-pin DM_IP_SEL1)

This jumper allows you to select the DMLAN setting. Set to pins 2-3 to force the DMLAN IP to static mode (IP=10.10.10.10, submask=255.255.255.0).

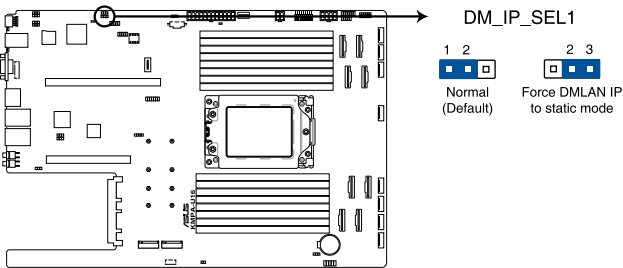

KMPA-U16 DM_IP_SEL1 setting

6. IPMI SW setting (3-pin IPMI_SW1)

This jumper allows you to select which protocol in the GPU sensor to function.

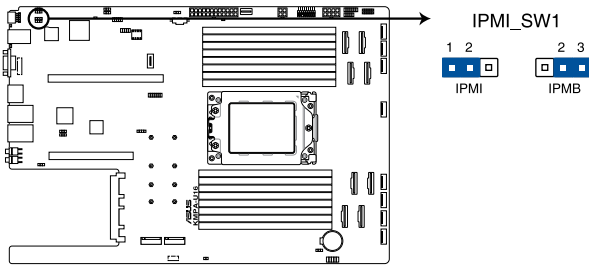

KMPA-U16 IPMI_SW1 setting

7. Smart Ride Through (SmaRT) setting (3-pin SMART_PSU1)

This jumper allows you to enable or disable the Smart Ride Through (SmaRT) function. This feature is enabled by default. Set to pins 2-3 to disable it. When enabled, SmaRT allows uninterrupted operation of the system during an AC loss event.

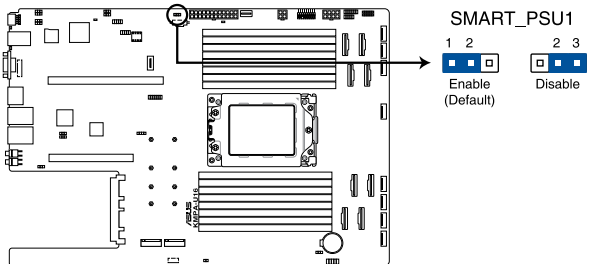

KMPA-U16 Smart Ride Through setting

8. LAN controller settings (3-pin LAN_SW1-2)

These jumpers allow you to enable or disable the onboard LAN_SW1 or LAN_SW2. Set to pins 1-2 to activate the Gigabit LAN feature.

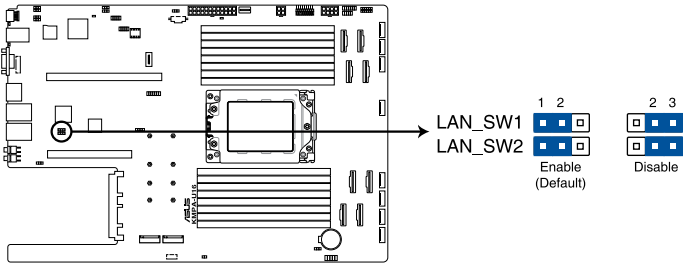

KMPA-U16 LAN setting

4.3 Internal LEDs

1. Standby Power LED (SBPWR1)

The motherboard comes with a standby power LED. The green LED lights up to indicate that the system is ON, in sleep mode, or in soft-off mode. This is a reminder that you should shut down the system and unplug the power cable before removing or plugging in any motherboard component. The illustration below shows the location of the onboard LED.

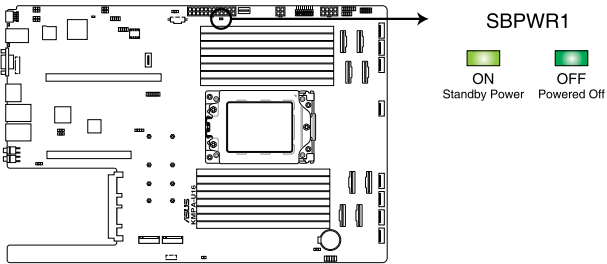

KMPA-U16 Standby Power LED

2. Baseboard Management Controller LED (BMCLED1)

The BMC LED lights up to indicate that the on-board BMC is functional.

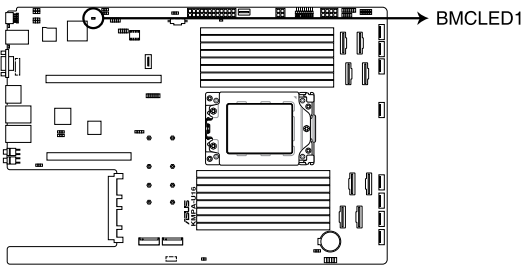

KMPA-U16 BMC LED

3. Message LED (MESLED1)

This onboard LED lights up to red when there is a BMC event log is generated.

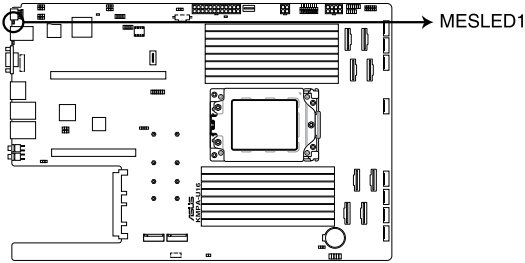

KMPA-U16 MESLED

4. Hard disk activity LED (HDDLED1)

This LED is for the storage devices connected to the onboard SATA, or SATA/SAS add-on card. The read or write activities of any device connected to the onboard SATA, or SATA/SAS add-on card causes the rear panel LED to light up.

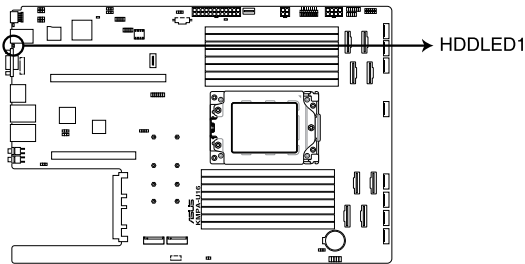

KMPA-U16 Storage device activity LED

4.4 Internal connectors

1. Slim PCIe connector (SLMPCIE1-6)

Connects the PCIe signal to the front riser card or NVMe port on the backplane.

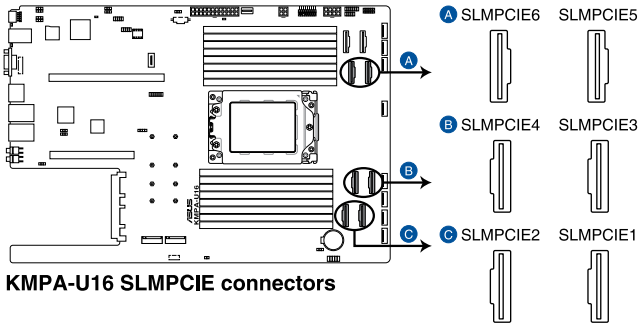

2. Slim SATA PCIe connector (SLMSATA_PCIE7-8)

Connects PCIe or SATA signal to backplane to support NVMe or SATA drives.

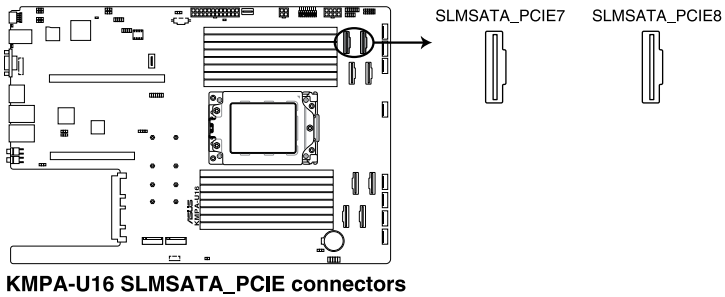

3. USB 2.0 connector (10-1 pin USB2)

This connector is for USB 2.0 ports. Connect the USB module cable to the connector, and then install the module to a slot opening at the back of the system chassis. The USB connectors comply with USB 2.0 specification that supports up to 480 Mbps connection speed.

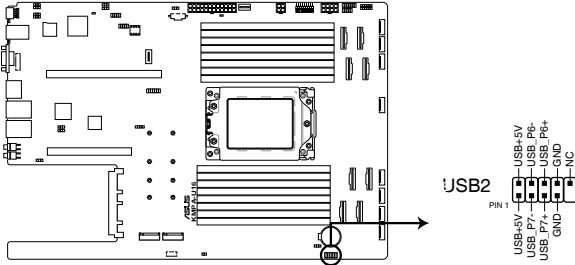

KMPA-U16 USB 2.0 connector



The USB port module is purchased separately.

4. USB 3.2 Gen 1 connector (USB3_34)

The USB 3.2 Gen 1 connector provides data transfer speeds of up to 5 Gb/s. The Type-A connector allows you to directly connect a USB flash drive.

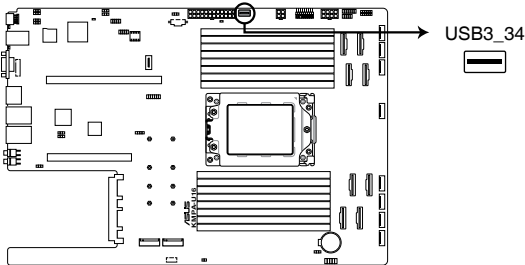

KMPA-U16 USB 3.2 Gen 1 connector

5. Chassis Intrusion (2-pin INTRUSION1)

These leads are for the intrusion detection feature for chassis with intrusion sensor or microswitch. When you remove any chassis component, the sensor triggers and sends a high level signal to these leads to record a chassis intrusion event. The default setting is to short the CHASSIS# and the GND pin by a jumper cap to disable the function.

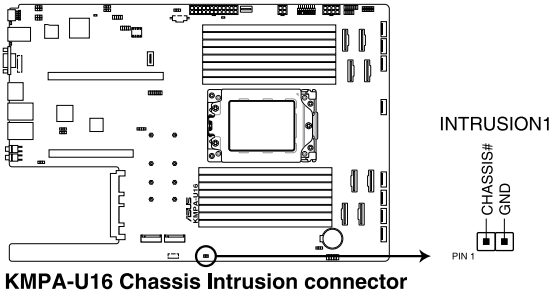

6. Serial port connector (10-1 pin COM1)

This connector is for a serial (COM) port. Connect the serial port module cable to this connector, then install the module to a slot opening at the back of the system chassis.

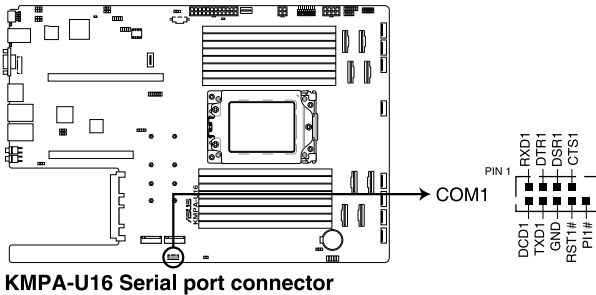

The COM module is purchased separately.

7. System fan connectors (6-pin FRNT_FAN1-8)

The fan connectors support cooling fans of 0.8A–1.0A (12 W max.) or a total of 6.4 A–8.0 A (96 W max.) at +12V. Connect the fan cables to the fan connectors on the motherboard, making sure that the black wire of each cable matches the ground pin of the connector.



DO NOT forget to connect the fan cables to the fan connectors. Insufficient air flow inside the system may damage the motherboard components. These are not jumpers! DO NOT place jumper caps on the fan connectors!

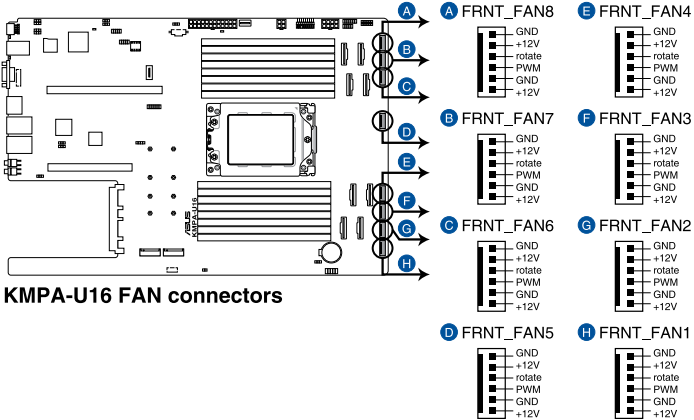

8. TPM connector (14-pin TPM1)

This connector supports a Trusted Platform Module (TPM) system, which can securely store keys, digital certificates, passwords, and data. A TPM system also helps enhance network security, protects digital identities, and ensures platform integrity.

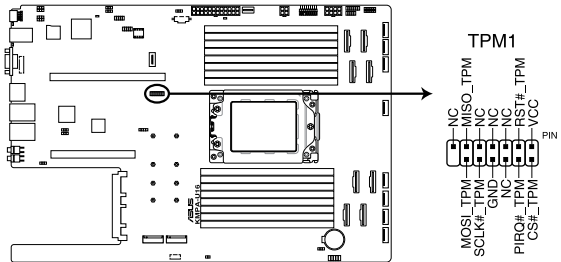

KMPA-U16 TPM connector

9. M.2 (NGFF) card connector (NGFF1-2)

These connectors allow you to install M.2 devices.

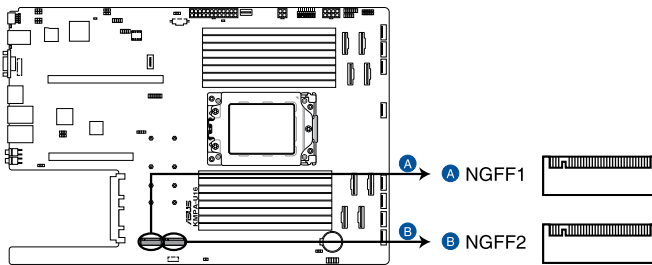

KMPA-U16 NGFF connectors



This connector supports type 2242 / 2260 / 2280 / 22110 devices on both PCI-E and SATA interface.



The M.2 (NGFF) device is purchased separately

10. Power connectors (24-pin EATXPWR; 8-pin EATX12V1; 4-pin EATX12V2)

These connectors are for the power supply plugs that connects to the power board. The power supply plugs are designed to fit these connectors in only one orientation. Find the proper orientation and push down firmly until the connectors completely fit.

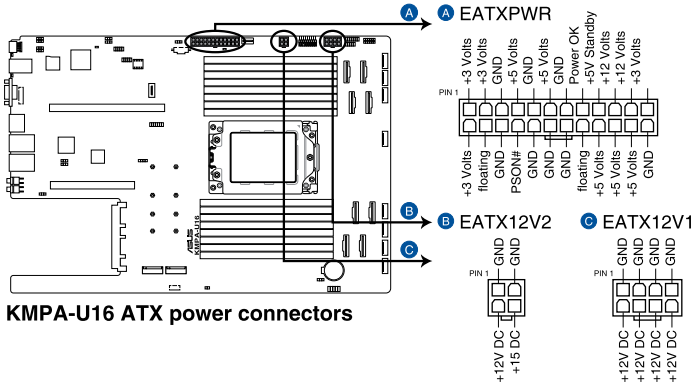

DO NOT connect VGA cards to these connectors. Doing so may cause system boot errors and permanent damage to your motherboard or device.

11. VGA connector (16-pin VGA_HDR1)

This connector supports the VGA High Dynamic-Range interface.

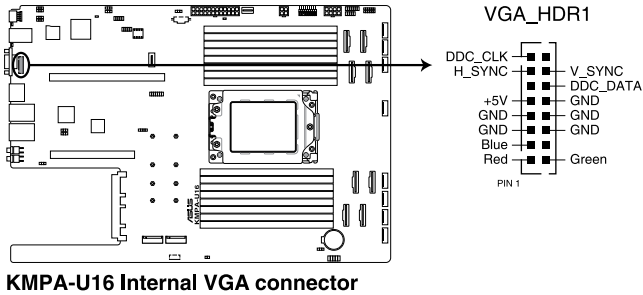

12. Micro SD card slot (MSD1)

Your motherboard supports SD Memory Card v2.00 (SDHC) / v3.00 (SDXC).

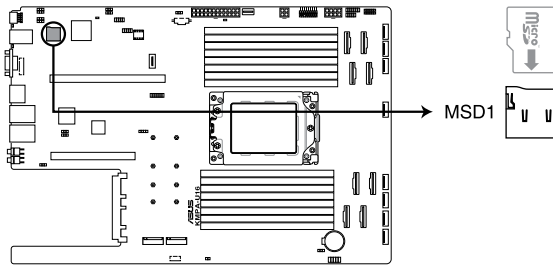

KMPA-U16 MSD1



Disconnect all power (including redundant PSUs) from the existing system before you add or remove a Memory Card, then reboot the system to access the Memory Card.



Some memory cards may not be compatible with your motherboard. Ensure that you use only compatible memory cards to prevent loss of data, damage to your device, or memory card, or both.

13. Storage device activity LED connector (4-pin HDLED1)

This LED connector is for the storage add-on card cable connected to the SATA or SAS add-on card. The read or write activities of any device connected to the SATA or SAS add-on card causes the front panel LED to light up.

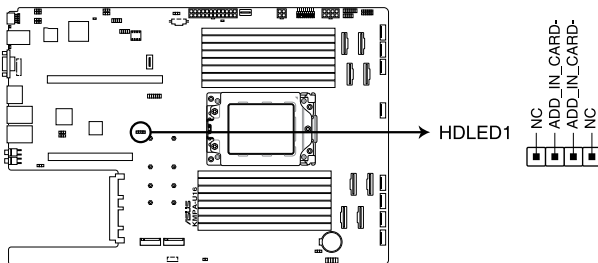

KMPA-U16 Storage device activity LED connector

14. System panel connector (10-1 pin SYS_PANEL1; 14-1 pin SYS_PANEL2)

This connector supports several chassis-mounted functions.

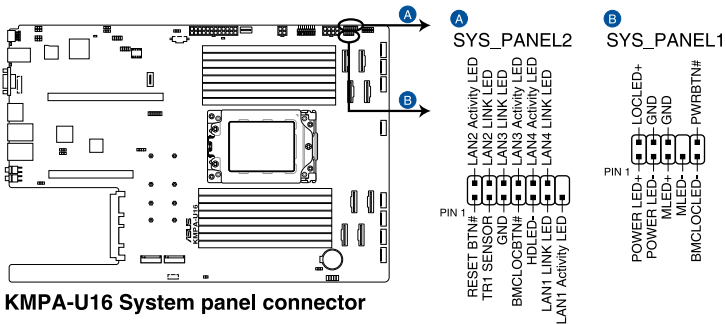

KMPA-U16 System panel connector

- **System power LED (POWERLED)**

This 2-pin connector is for the system power LED. Connect the chassis power LED cable to this connector. The system power LED lights up when you turn on the system power, and blinks when the system is in sleep mode.

- **Message LED (2-pin MLED)**

This 2-pin connector is for the message LED cable that connects to the front message LED. The message LED is controlled by the BMC to indicate an abnormal event occurrence.

- **Locator LED connector (BMCLOCLED, LOCLEDD)**

This connector allows you to connect the Locator LED. The Location LED helps visually locate and identify the server in error on a server rack.

- **Power Button/Soft-off Button connector (PWRBTN)**

The 3-1 pin connector allows you to connect the system power button. Press the power button to power up the system, or put the system into sleep or soft-off mode (depending on the operating system settings).

- **LAN activity LED connector (LAN1_LED, LAN2_LED, LAN3_LED, LAN4_LED)**

This 2-pin connector allows you to connect the Gigabit LAN Activity LED.

- **Reset button connector (RESET)**

This connector allows you to connect the chassis-mounted reset button. Press the reset button to reboot the system.

- **TR1 Sensor connector (TR1 SENSOR)**

This connector allows detection of the environmental temperature of the front panel. • Locator button connector (BMCLOCBTN#)

This connector allows you to connect the Locator button. Press the button to light up the Locator LED.

- **Storage Device Activity LED connector (HDLED)**

This connector allows you to connect the Storage Device Activity LED. The Storage Device Activity LED lights up or blinks when data is read from or written to the storage device or storage device add-on card.

15. VPP_I2C1 connector (10-1 pin VPP_I2C1)

This connector is used for the sensor readings.

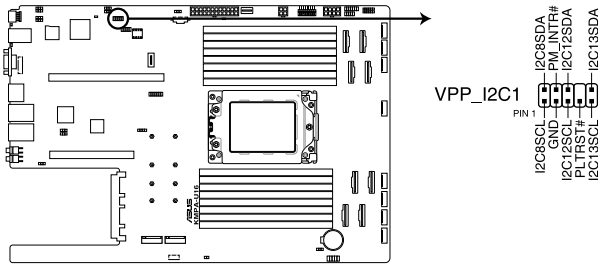

KMPA-U16 VPP_I2C1 connector

16. BMC Debug UART connector (3-pin BMC_DEBUGUART1)

This connector is used for reading the BMC UART Debug log.

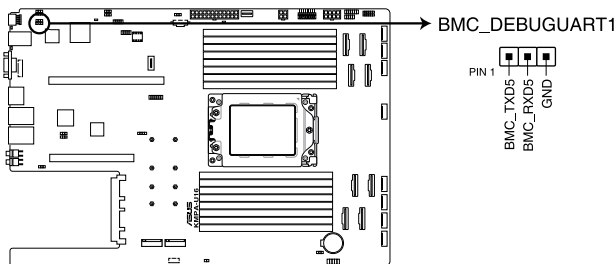

KMPA-U16 BMC_DEBUGUART1 connector

17. Smart Ride Through (Smart) setting (3-pin SMART_PSU1)

This jumper allows you to enable or disable the Smart Ride Through (SmaRT) function. This feature is enabled by default. Set to pins 2-3 to disable it. When enabled, SmaRT allows uninterrupted operation of the system during an AC loss event.

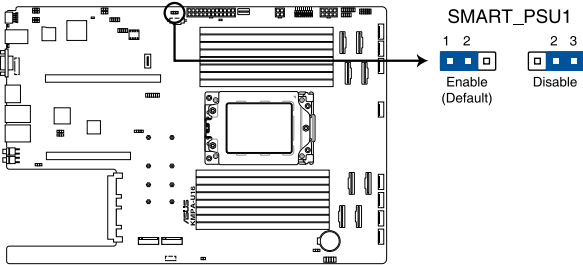

KMPA-U16 Smart Ride Through setting

18. SLMPCIE SGPIO connector (6-1 pin SLM7_SGPIO1, SLM8_SGPIO1)

This connector is the SGPIO header for controlling the HDD LED function.

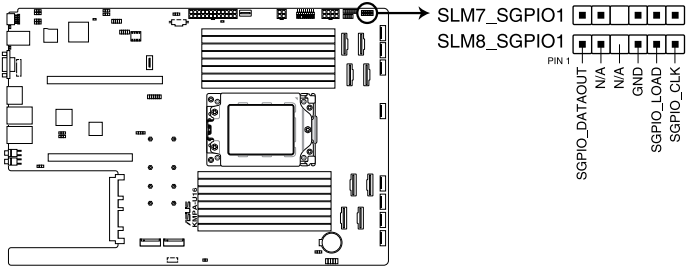

KMPA-U16 SLM7_SGPIO1 connector

BIOS Setup

5

This chapter tells how to change the system settings through the BIOS Setup menus. Detailed descriptions of the BIOS parameters are also provided.

5.1 Managing and updating your BIOS

The following utilities allow you to manage and update the motherboard Basic Input/Output System (BIOS) setup:

1. **ASUS CrashFree BIOS 3**

To recover the BIOS using a bootable USB flash disk drive when the BIOS file fails or gets corrupted.

2. **ASUS EzFlash**

Updates the BIOS using a USB flash disk.

3. **BUPDATER**

Updates the BIOS in DOS mode using a bootable USB flash disk drive.

Refer to the corresponding sections for details on these utilities.



Save a copy of the original motherboard BIOS file to a bootable USB flash disk drive in case you need to restore the BIOS in the future. Copy the original motherboard BIOS using the BUPDATER utility.

5.1.1 **ASUS CrashFree BIOS 3 utility**

The ASUS CrashFree BIOS 3 is an auto recovery tool that allows you to restore the BIOS file when it fails or gets corrupted during the updating process. You can update a corrupted BIOS file using a USB flash drive that contains the updated BIOS file.



Prepare a USB flash drive containing the updated motherboard BIOS before using this utility.

Recovering the BIOS from a USB flash drive

To recover the BIOS from a USB flash drive:

1. Insert the USB flash drive with the original or updated BIOS file to one USB port on the system.
2. The utility will automatically recover the BIOS. It resets the system when the BIOS recovery finished.



DO NOT shut down or reset the system while recovering the BIOS! Doing so would cause system boot failure!



The recovered BIOS may not be the latest BIOS version for this motherboard. Visit the ASUS website at www.asus.com to download the latest BIOS file.

5.1.2 ASUS EZ Flash Utility

The ASUS EZ Flash Utility feature allows you to update the BIOS without having to use a DOS-based utility.



Before you start using this utility, download the latest BIOS from the ASUS website at www.asus.com.

To update the BIOS using EZ Flash Utility:

1. Insert the USB flash disk that contains the latest BIOS file into the USB port.
2. Enter the BIOS setup program. Go to the **Tool** menu then select **Start ASUS EzFlash**. Press <Enter>.

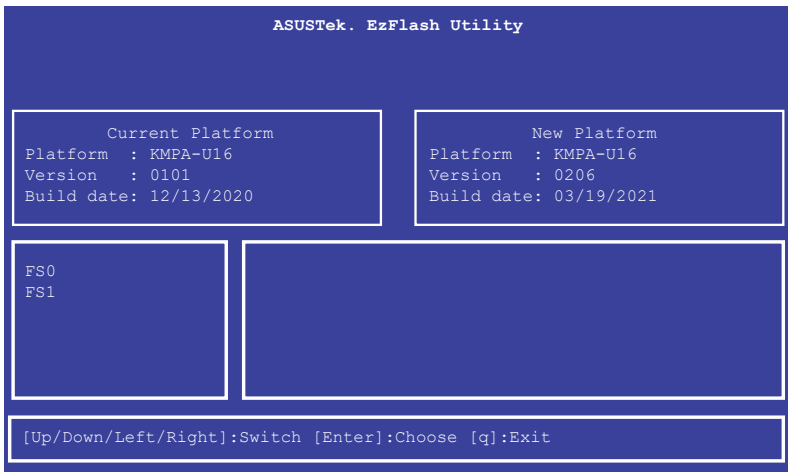

3. Press Left arrow key to switch to the **Drive** field.
4. Press the Up/Down arrow keys to find the USB flash disk that contains the latest BIOS, then press <Enter>.
5. Press Right arrow key to switch to the **Folder Info** field.
6. Press the Up/Down arrow keys to find the BIOS file, and then press <Enter> to perform the BIOS update process. Reboot the system when the update process is done.



- This function can support devices such as a USB flash disk with FAT 32/16 format and single partition only.
- DO NOT shut down or reset the system while updating the BIOS to prevent system boot failure!



Ensure to load the BIOS default settings to ensure system compatibility and stability. Press <F5> and select **Yes** to load the BIOS default settings.

5.1.3 BUPDATER utility



The succeeding BIOS screens are for reference only. The actual BIOS screen displays may not be the same as shown.

The BUPDATER utility allows you to update the BIOS file in the DOS environment using a bootable USB flash disk drive with the updated BIOS file.

Updating the BIOS file

To update the BIOS file using the BUPDATER utility:

1. Visit the ASUS website at www.asus.com and download the latest BIOS file for the motherboard. Save the BIOS file to a bootable USB flash disk drive.
2. Copy the BUPDATER utility (BUPDATER.exe) from the ASUS support website at www.asus.com/support to the bootable USB flash disk drive you created earlier.
3. Boot the system in DOS mode, then at the prompt, type:

```
BUPDATER /i[filename].CAP
```

where [filename] is the latest or the original BIOS file on the bootable USB flash disk drive, then press <Enter>.

```
A:\>BUPDATER /i[file name].CAP
```

- The utility verifies the file, then starts updating the BIOS file.

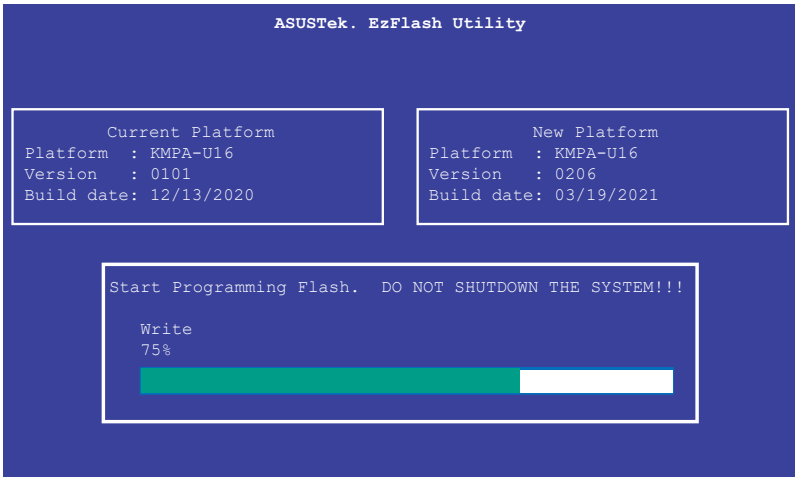

DO NOT shut down or reset the system while updating the BIOS to prevent system boot failure!

- The utility returns to the DOS prompt after the BIOS update process is completed. Reboot the system from the hard disk drive.

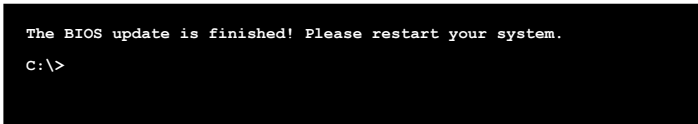

5.2 BIOS setup program

This motherboard supports a programmable firmware chip that you can update using the provided utility described in section **5.1 Managing and updating your BIOS**.

Use the BIOS Setup program when you are installing a motherboard, reconfiguring your system, or prompted to “Run Setup.” This section explains how to configure your system using this utility.

Even if you are not prompted to use the Setup program, you can change the configuration of your computer in the future. For example, you can enable the security password feature or change the power management settings. This requires you to reconfigure your system using the BIOS Setup program so that the computer can recognize these changes and record them in the CMOS RAM of the firmware chip.

The firmware chip on the motherboard stores the Setup utility. When you start up the computer, the system provides you with the opportunity to run this program. Press during the Power-On Self-Test (POST) to enter the Setup utility; otherwise, POST continues with its test routines.

If you wish to enter Setup after POST, restart the system by pressing <Ctrl>+<Alt>+<Delete>, or by pressing the reset button on the system chassis. You can also restart by turning the system off and then back on. Do this last option only if the first two failed.

The Setup program is designed to make it as easy to use as possible. Being a menu-driven program, it lets you scroll through the various sub-menus and make your selections from the available options using the navigation keys.



-
- The default BIOS settings for this motherboard apply for most conditions to ensure optimum performance. If the system becomes unstable after changing any BIOS settings, load the default settings to ensure system compatibility and stability. Press <F5> and select **Yes** to load the BIOS default settings.
 - The BIOS setup screens shown in this section are for reference purposes only, and may not exactly match what you see on your screen.
 - Visit the ASUS website (www.asus.com) to download the latest BIOS file for this motherboard.
-

5.2.1 BIOS menu screen

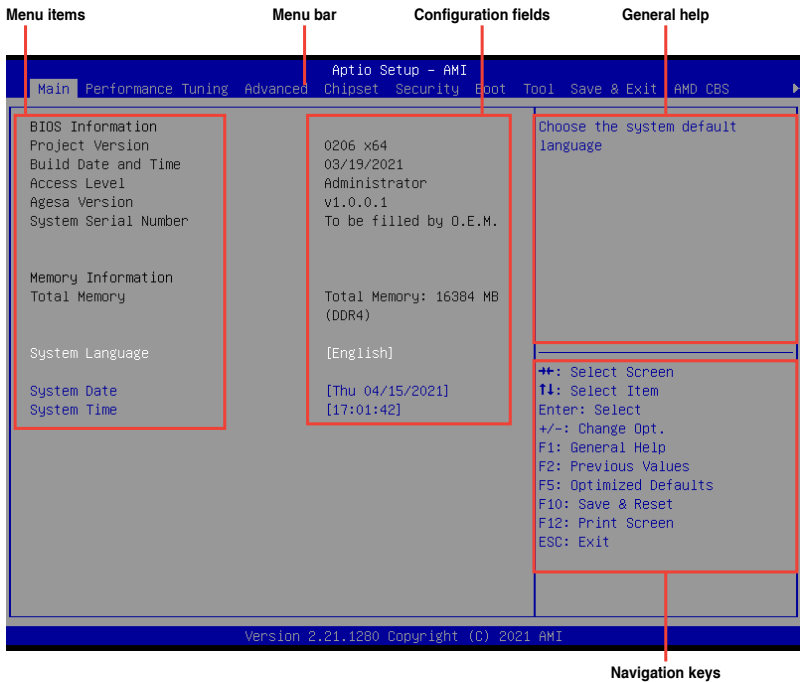

5.2.2 Menu bar

The menu bar on top of the screen has the following main items:

- Main** For changing the basic system configuration
- Performance Tuning** For changing the performance settings
- Advanced** For changing the advanced system settings
- Chipset** For changing the chipset settings
- Security** For changing the security settings
- Boot** For changing the system boot configuration
- Tool** For configuring options for special functions
- Save & Exit** For selecting the exit options
- AMD CBS** For configuring AMD CBS settings
- Event Logs** For changing the event log settings
- Server Mgmt** For changing the Server Mgmt settings

To select an item on the menu bar, press the right or left arrow key on the keyboard until the desired item is highlighted.

5.2.3 Menu items

The highlighted item on the menu bar displays the specific items for that menu. For example, selecting **Main** shows the Main menu items.

The other items (such as **Advanced**) on the menu bar have their respective menu items.

5.2.4 Submenu items

A solid triangle before each item on any menu screen means that the item has a submenu. To display the submenu, select the item then press <Enter>.

5.2.5 Navigation keys

At the bottom right corner of a menu screen are the navigation keys for the BIOS setup program. Use the navigation keys to select items in the menu and change the settings.

5.2.6 General help

At the top right corner of the menu screen is a brief description of the selected item.

5.2.7 Configuration fields

These fields show the values for the menu items. If an item is user-configurable, you can change the value of the field opposite the item. You cannot select an item that is not user-configurable.

A configurable field is enclosed in brackets, and is highlighted when selected. To change the value of a field, select it and press <Enter> to display a list of options.

5.2.8 Pop-up window

Select a menu item and press <Enter> to display a pop-up window with the configuration options for that item.

5.2.9 Scroll bar

A scroll bar appears on the right side of a menu screen when there are items that do not fit on the screen. Press the Up / Down arrow keys or <Page Up> / <Page Down> keys to display the other items on the screen.

5.3 Main menu

When you enter the BIOS Setup program, the Main menu screen appears. The Main menu provides you an overview of the basic system information, and allows you to set the system date, time, and language settings.

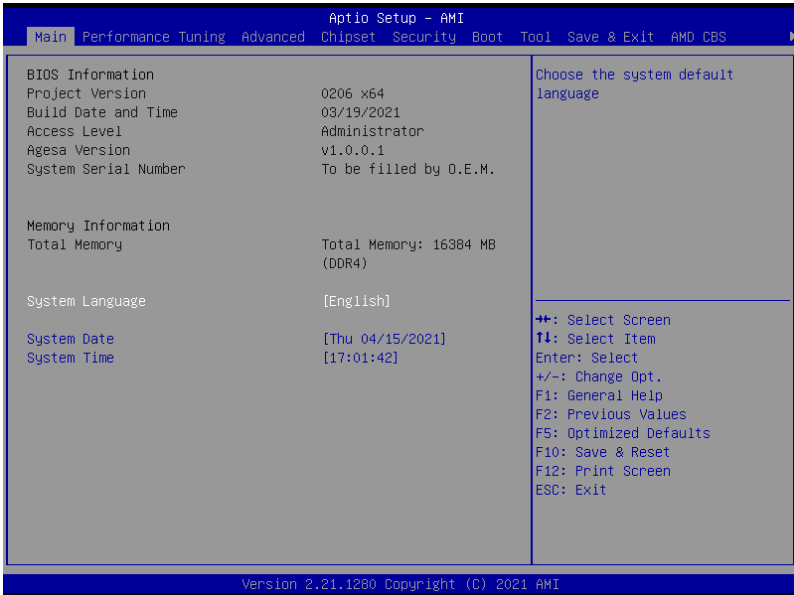

5.3.1 System Language [English]

Allows you to select the system default language.

5.3.2 System Date [Day xx/xx/xxxx]

Allows you to set the system date.

5.3.3 System Time [xx:xx:xx]

Allows you to set the system time.

5.4 Performance Tuning menu

The Performance Tuning menu items allow you to change performance related settings for different scenarios.

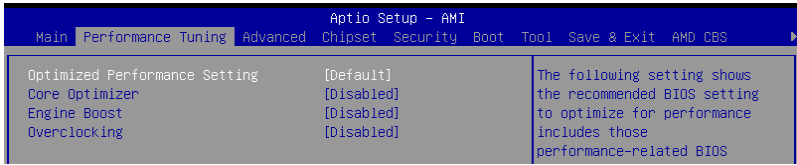

Optimized Performance Setting [Default]

Allows you to select performance settings for different scenarios.

[Default] Default settings.

[By Benchmark] Optimize for different kinds of benchmarks. Select this option, then select a benchmark type from the >> list.

[By Workload] Optimize for different kinds of workloads. Select this option, then select a workload type from the >> list.



Core Optimizer and **Engine Boost** appear only when you set **Optimized Performance Setting** to [Default] or [By Benchmark].

Core Optimizer [Disabled]

Allows you to keep the processor operating at the turbo highest frequency for the maximum performance. For Windows Server 2019, please set `Powercfg /setacvalueindex scheme_current sub_processor perfautonomous 1 & Powercfg /setactive scheme_current` to enable this feature. For Linux, please set `cpupower frequency-set -g performance`.

Configuration options: [Disabled] [Enabled]



Linux support may vary by version of the OS.

Engine Boost [Disabled]

Enable this item to boost the CPU's frequency.

Configuration options: [Disabled] [Enabled]



Operate with an ambient temperature of 25°C or lower for optimized performance.

Overclocking [Disabled]

Enable this item to increase the CPU's clock. Please use an external PCIe storage controller for your hard drives when enabling this feature.

Configuration options: [Disabled] [Enabled]



Please note that overclocking might cause component damage or system crashes, which may reduce the lifespan of the system and the CPU. Use this tool at your own risk.

5.5 Advanced menu

The Advanced menu items allow you to change the settings for the CPU and other system devices.



Take caution when changing the settings of the Advanced menu items. Incorrect field values can cause the system to malfunction.

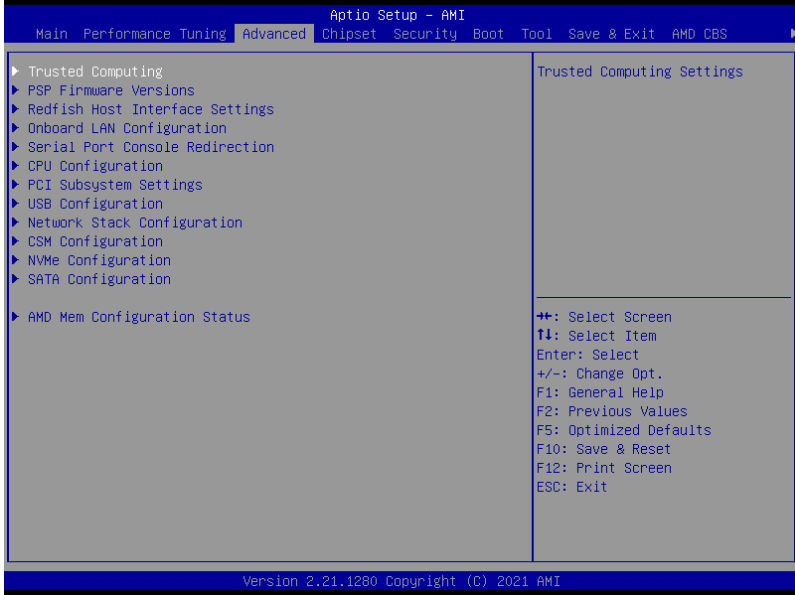

5.5.1 Trusted Computing

Aptio Setup - AMI		
Advanced		
Configuration		
Security Device Support	[Enable]	Enables or Disables BIOS support for security device. O.S. will not show Security Device. TCG EFI protocol and
NO Security Device Found		

Configuration

Security Device Support [Enable]

Allows you to enable or disable the BIOS support for security device. O.S. will not show Security Device. TCG EFI protocol and INT1A interface will not be available.

Configuration options: [Disable] [Enable]

5.5.2 PSP Firmware Versions

This page displays the PSP firmware versions.

Aptio Setup - AMI		
Advanced		
PSP Firmware Versions		
PSP Directory Level 1 (Fixed)		
PSP Recovery BL Ver	FF.13.0.50	
SMU FW Version	0.45.63.0	
ABL Version	10015012	
PSP Directory Level 2 (Updateable)		
PSP BootLoader Version	0.13.0.50	
SMU FW Version	0.45.63.0	
ABL Version	10015012	

5.5.3 Redfish Host Interface Settings

Allows you to configure the Advance Power Management (APM) settings.

Aptio Setup - AMI		
Advanced		
Redfish Host Interface Settings		Enable/Disable AMI Redfish
Redfish	[Disabled]	

Redfish [Disabled]

Allows you to enable or disable Redfish.

Configuration options: [Disabled] [Enabled]

5.5.4 APM Configuration

Allows you to configure the Advance Power Management (APM) settings.

Aptio Setup - AMI		
Advanced		
Restore AC Power Loss	[Last State]	Select AC power state when power is re-applied after a power failure.
Power On By PCI-E	[Disabled]	
Power On By RTC	[Disabled]	

Restore AC Power Loss [Last State]

- [Power Off] The system goes into off state after an AC power loss.
- [Power On] The system will reboot after an AC power loss.
- [Last State] The system goes into either off or on state, whatever the system state was before the AC power loss.

Power On By PCI-E [Disabled]

- [Disabled] Disables the PCIE devices to generate a wake event.
- [Enabled] Enables the PCIE devices to generate a wake event.

Power On By RTC [Disabled]

- [Disabled] Disables RTC to generate a wake event.
- [Enabled] When set to [Enabled], the items **RTC Alarm Date (Days)** and **Hour/Minute/Second** will become user-configurable with set values.

5.5.5 Onboard LAN Configuration

Aptio Setup - AMI	
Advanced	
▶ Onboard I350 LAN Configuration	Onboard I350 LAN Enable/Disable

Onboard I350 LAN Configuration

Intel I350 LAN1

LAN Enable [JumperState]

Allows you to enable or disable the Intel LAN.
Configuration options: [Disabled] [JumperState]



The following item appears only when **LAN Enable** is set to [JumperState].

ROM Type [PXE]

Allows you to select the Intel LAN ROM type.
Configuration options: [Disabled] [PXE]

Intel I350 LAN2

LAN Enable [JumperState]

Allows you to enable or disable the Intel LAN.
Configuration options: [Disabled] [Enabled]



The following item appears only when **LAN Enable** is set to **[JumperState]**.

ROM Type [Disabled]

Allows you to select the Intel LAN ROM type.

Configuration options: [Disabled] [PXE]

5.5.6 Serial Port Console Redirection

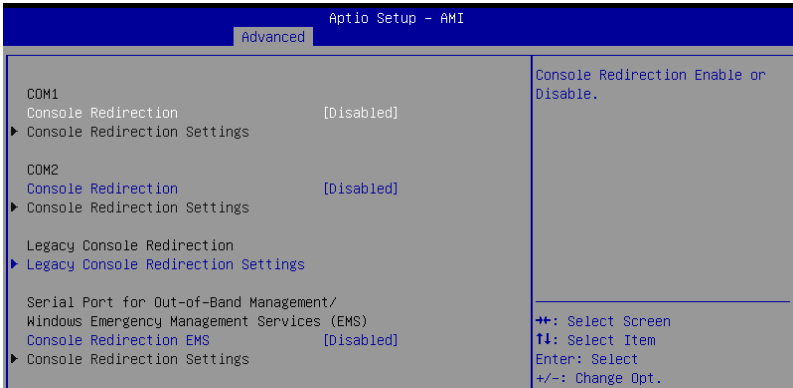

COM1/COM2

Console Redirection [Disabled]

Allows you to enable or disable the console redirection feature.

Configuration options: [Disabled] [Enabled]



The following item appears only when **Console Redirection** is set to **[Enabled]**.

Console Redirection Settings

These items become configurable only when you enable the **Console Redirection** item. The settings specify how the host computer and the remote computer (which the user is using) will exchange data. Both computers should have the same or compatible settings.

Terminal Type [ANSI]

Allows you to set the terminal type.

[VT100] ASCII char set.

[VT100+] Extends VT100 to support color, function keys, etc.

[VT-UTF8] Uses UTF8 encoding to map Unicode chars onto 1 or more bytes.

[ANSI] Extended ASCII char set.

Bits per second [115200]

Selects serial port transmission speed. The speed must be matched on the other side. Long or noisy lines may require lower speeds.

Configuration options: [9600] [19200] [38400] [57600] [115200]

Data Bits [8]

Configuration options: [7] [8]

Parity [None]

A parity bit can be sent with the data bits to detect some transmission errors. [Mark] and [Space] parity do not allow for error detection.

[None] None

[Even] parity bit is 0 if the num of 1's in the data bits is even

[Odd] parity bit is 0 if num of 1's in the data bits is odd

[Mark] parity bit is always 1

[Space] parity bit is always 0

Stop Bits [1]

Stop bits indicate the end of a serial data packet. (A start bit indicates the beginning.) The standard setting is 1 stop bit. Communication with slow devices may require more than 1 stop bit.

Configuration options: [1] [2]

Flow Control [None]

Flow control can prevent data loss from buffer overflow. When sending data, if the receiving buffers are full, a "stop" signal can be sent to stop the data flow. Once the buffers are empty, a "start" signal can be sent to re-start the flow. Hardware flow control uses two wires to send start/stop signals.

Configuration options: [None] [Hardware RTS/CTS]

VT -UTF8 Combo Key Support [Enabled]

This allows you to enable the VT -UTF8 Combination Key Support for ANSI/VT100 terminals.

Configuration options: [Disabled] [Enabled]

Recorder Mode [Disabled]

With this mode enabled only text will be sent. This is to capture Terminal data.

Configuration options: [Disabled] [Enabled]

Resolution 100x31 [Enabled]

This allows you enable or disable extended terminal resolution.

Configuration options: [Disabled] [Enabled]

Putty Keypad [VT100]

This allows you to select the FunctionKey and Keypad on Putty.

Configuration options: [VT100] [LINUX] [XTERMR6] [SCO] [ESCN] [VT400]

Legacy Console Redirection Settings

Legacy Console Redirection Port [COM1]

Allows you to select a COM port to display redirection of Legacy OS and Legacy OPRM Messages.

Configuration options: [COM1] [COM2]

Resolution [80x24]

This allows you to set the number of rows and columns supported on the Legacy OS.

Configuration options: [80x24] [80x25]

Redirection After POST [Always Enable]

This setting allows you to specify if Bootloader is selected than Legacy console redirection.

Configuration options: [Always Enable] [Bootloader]

Serial Port for Out-of-Band Management/ Windows Emergency Management Services (EMS)

Console Redirection [Disabled]

Allows you to enable or disable the console redirection feature.

Configuration options: [Disabled] [Enabled]



The following item appears only when **Console Redirection** is set to **[Enabled]**.

Console Redirection Settings

Out-of-Band Mgmt Port [COM1]

Microsoft Windows Emergency Management Services (EMS) allow for remote management of a Windows Server OS through a serial port.

Configuration options: [COM1] [COM2]

Terminal Type [VT-UTF8]

Microsoft Windows Emergency Management Services (EMS) allow for remote management of a Windows Server OS through a serial port.

Configuration options: [VT100] [VT100+] [VT-UTF8] [ANSI]

Bits per second [115200]

Microsoft Windows Emergency Management Services (EMS) allow for remote management of a Windows Server OS through a serial port.

Configuration options: [9600] [19200] [57600] [115200]

Flow Control [None]

Microsoft Windows Emergency Management Services (EMS) allow for remote management of a Windows Server OS through a serial port.

Configuration options: [None] [Hardware RTS/CTS] [Software Xon/Xoff]

5.5.7 CPU Configuration

This page displays the CPU node information.

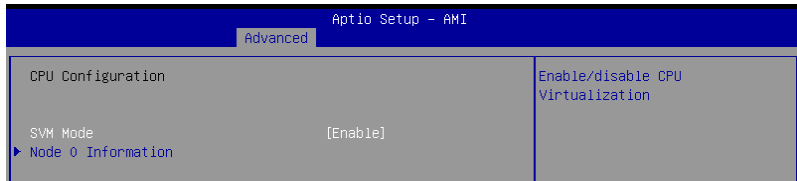

SVM Mode [Enable]

Allows you enable or disable CPU Virtualization.

Configuration options: [Disabled] [Enable]

Node 0 Information

Allows you to view memory information related to Node 0.

5.5.8 PCI Subsystem Settings

Allows you to configure PCI, PCI-X, and PCI Express Settings.

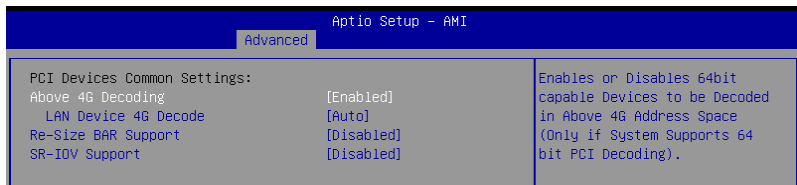

Above 4G Decoding [Enabled]

Allows you to enable or disable 64-bit capable devices to be decoded in above 4G address space. It only works if the system supports 64-bit PCI decoding.

Configuration options: [Disabled] [Enabled]



The following items appear only when **Above 4G Decoding** is set to **[Enabled]**.

LAN Device 4G Decode [Auto]

LAN Device 4G Decode.

Configuration options: [Auto] [Above_4G]

Re-Size BAR Support [Disabled]

If system has Resizable BAR capable PCIe Devices, this option enables or disables Resizable BAR Support. (Only if system supports 64-bit PCI Decoding).

Configuration options: [Disabled] [Auto]



To enable Re-Size BAR Support for harnessing full GPU memory, please set CSM (Compatibility Support Module) to [Disabled].

SR-IOV Support [Disabled]

This option enables or disables Single Root IO Virtualization Support if the system has SR-IOV capable PCIe devices.

Configuration options: [Disabled] [Enabled]

5.5.9 USB Configuration

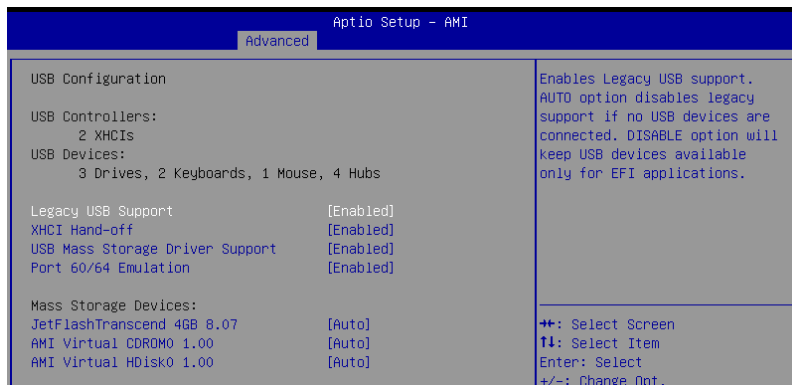

Legacy USB Support [Enabled]

Allows you to enable or disable Legacy USB device support.

Configuration options: [Enabled] [Disabled] [Auto]

XHCI Hand-off [Enabled]

Allows you to enable or disable workaround for OSES without XHCI hand-off support. The XHCI ownership change should be claimed by XHCI driver.

Configuration options: [Enabled] [Disabled]

USB Mass Storage Driver Support [Enabled]

Allows you to enable or disable the USB Mass Storage driver support.

Configuration options: [Disabled] [Enabled]

Port 60/64 Emulation [Enabled]

Allows you to enable or disable I/O port 60h/64h emulation support. This should be enabled for the complete keyboard legacy support for non-USB aware OSES.

Configuration options: [Disabled] [Enabled]

Mass Storage Devices

Allows you to select the mass storage device emulation type for devices connected.

Configuration options: [Auto] [Floppy] [Forced FDD] [Hard Disk] [CD-ROM]

5.5.10 Network Stack Configuration

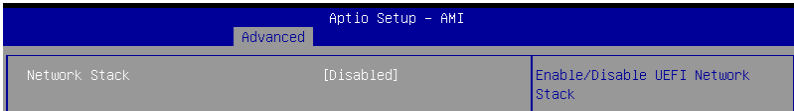

Network stack [Disabled]

Enables or disables the network stack feature.

Configuration options: [Disable] [Enable]



The following item appears only when **Network stack** is set to **[Enabled]**.

Ipv4 PXE Support [Disabled]

Enables or disables the Ipv4 PXE Boot Support. If disabled, Ipv4 PXE boot option will not be created.

Configuration options: [Disabled] [Enabled]

Ipv4 HTTP Support [Disabled]

Enables or disables the Ipv4 HTTP Boot Support. If disabled, Ipv4 HTTP boot option will not be created.

Configuration options: [Disabled] [Enabled]

Ipv6 PXE Support [Disabled]

Enables or disables the Ipv6 PXE Boot Support. If disabled, Ipv6 PXE boot option will not be created.

Configuration options: [Disabled] [Enabled]

Ipv6 HTTP Support [Disabled]

Enables or disables the Ipv6 HTTP Boot Support. If disabled, Ipv6 HTTP boot option will not be created.

Configuration options: [Disabled] [Enabled]

PXE boot wait time [0]

Set the wait time to press ESC key to abort the PXE boot. Use the <+> or <-> to adjust the value. The values range from 0 to 5.

Media detect count [1]

Set the number of times presence of media will be checked. Use the <+> or <-> to adjust the value. The values range from 1 to 50.

5.5.11 CSM Configuration

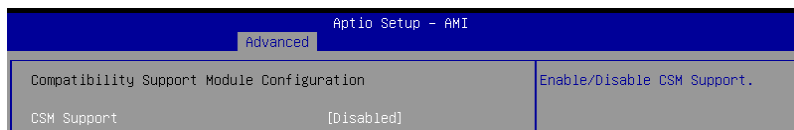

CSM Support [Disabled]

This option allows you to enable or disable CSM Support.

Configuration options: [Disabled] [Enabled]



The following items appear only when **CSM Support** is set to **[Enabled]**.

GateA20 Active [Upon Request]

This allows you to set the GA20 option.

Configuration options: [Upon Request] [Always]

Option ROM Messages [Force BIOS]

This allows you to set the display mode for option ROM.

Configuration options: [Force BIOS] [Keep Current]

INT19 Trap Response [Immediate]

The BIOS reaction on INT19 trapping by Option ROM.

[Immediate] Execute the trap right away.

[Postponed] Execute the trap during legacy boot.

HDD Connection Order [Adjust]

This option allows you to select the HDD Connection Order. Some OS require HDD handles to be adjusted, i.e. OS is installed on drive 80h.

Configuration options: [Adjust] [Keep]

Boot Option filter [UEFI and Legacy]

This option allows you to control the Legacy/UEFI ROMs priority.

Configuration options: [UEFI and Legacy] [Legacy only] [UEFI only]

Network [UEFI]

This option allows you to control the execution of UEFI and Legacy Network OpROM.

Configuration options: [Do Not Launch] [UEFI] [Legacy]

Storage [UEFI]

This option allows you to control the execution of UEFI and Legacy Storage OpROM.

Configuration options: [Do Not Launch] [UEFI] [Legacy]

Video [Legacy]

This option allows you to control the execution of UEFI and Legacy Video OpROM.

Configuration options: [Do Not Launch] [UEFI] [Legacy]

Other PCI devices [UEFI]

This item determines the OpROM execution policy for devices other than Network, Storage, or Video.

Configuration options: [Do Not Launch] [UEFI] [Legacy]

5.5.12 NVMe Configuration

This page will display the NVMe controller and drive information.



Device



The devices and names shown in the NVMe configuration list depends on the connected devices. If no devices are connected, **No NVMe Device Found** will be displayed.

Self Test Option [Short]

This option allows you to select either Short or Extended Self Test. Short option will take couple of minutes, and the extended option will take several minutes to complete. Configuration options: [Short] [Extended]

Self Test Action [Controller Only Test]

Allows you to select either to test Controller alone or Controller and NameSpace. Selecting Controller and Namespace option will take a lot longer to complete the test. Configuration options: [Controller Only Test] [Controller and NameSpace Test]

Run Device Self Test

Press <Enter> to perform device self test for the corresponding Option and Action selected by the user. Pressing the <ESC> key will abort the test. The results shown below is the most recent result logged in the device.

5.5.13 SATA Configuration

This page will display the SATA controller and drive information.

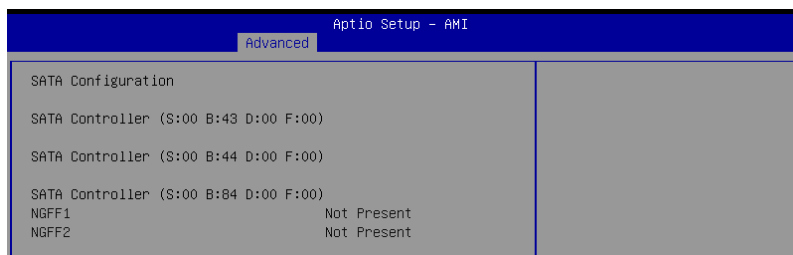

5.5.14 AMD Mem Configuration Status

The items in this menu display the memory configuration (initialized by ABL) status.

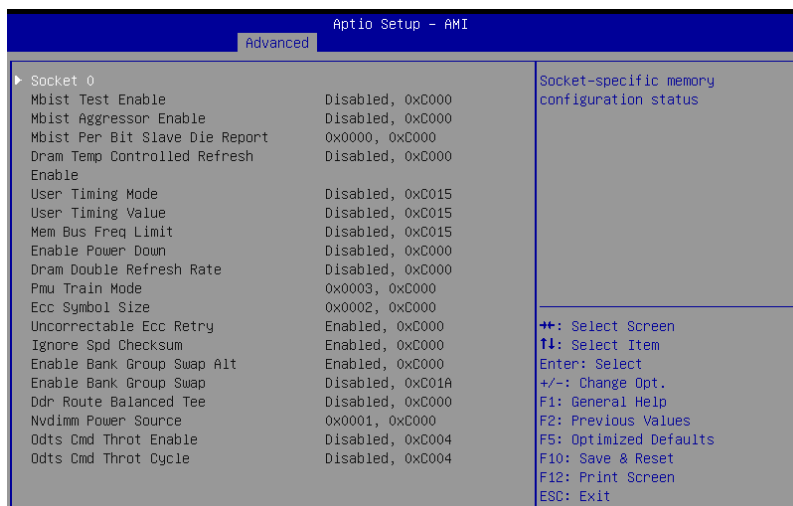

5.6 Chipset menu

The Chipset menu items allow you to change the Chipset settings.

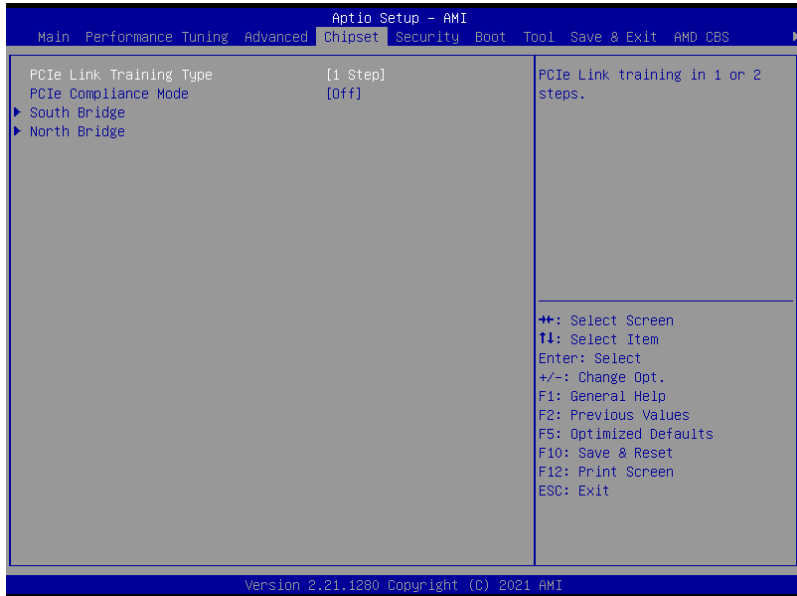

PCIe Link Training Type [1 Step]

Allows you to select PCIe Link Training in 1 or 2 steps.

Configuration options: [1 Step] [2 Step]

PCIe Compliance Mode [Off]

Allows you to turn the PCIe Compliance Mode on or off.

South Bridge

SB Debug Configuration

SB SATA DEBUG Configuration

The items in this submenu contains options for SATA DEBUG Configuration.

Aggressive Link PM Capability [Enabled]

Indicates whether Host Bus Adapter (HBA) can support Auto-generating Link Requests to the partial or slumber states when there are no commands to process.

Configuration options: [Disabled] [Enabled]

Port Multiplier Capability [Enabled]

Indicates whether Host Bus Adapter (HBA) can support a port multiplier.

Configuration options: [Disabled] [Enabled]

SATA Ports Auto Clock Control [Enabled]

Allows you to enable or disable SATA Ports Auto Clock Control.

Configuration options: [Disabled] [Enabled]

SATA Partial State Capability [Enabled]

Indicates whether Host Bus Adapter (HBA) can support transitions to the partial state.

Configuration options: [Disabled] [Enabled]

SATA FIS Based Switching [Enabled]

Indicates whether Host Bus Adapter (HBA) can support port multiplier FIS-based switching.

Configuration options: [Disabled] [Enabled]

SATA Command Completion Coalescing Support [Disabled]

Indicates whether Host Bus Adapter (HBA) can support command completion coalescing.

Configuration options: [Disabled] [Enabled]

SATA Slumber State Capability [Enabled]

Indicates whether Host Bus Adapter (HBA) can support transitions to the slumber state.

Configuration options: [Disabled] [Enabled]

SATA Target Support 8 Devices [Disabled]

Indicates whether SATA target support 8 devices function.

Configuration options: [Disabled] [Enabled]

Generic Mode [Disabled]

Allows you to SATA disable Generic Mode.

Configuration options: [Disabled] [Enabled]

SATA AHCI Enclosure [Disabled]

Allows you to enable or disable SATA AHCI Enclosure Management.

Configuration options: [Disabled] [Enabled]

SATA SGPIO 0 [Disabled]

Allows you to enable or disable SATA Serial General Purpose Input/Output (SGPIO) 0.

Configuration options: [Disabled] [Enabled]

SB FUSION DEBUG Configuration

The items in this submenu contains options for SB FUSION DEBUG Configuration.

TimerTick Tracking [Disabled]

Configuration options: [Disabled] [Enabled]

Clock Interrupt Tag [Disabled]

Configuration options: [Disabled] [Enabled]

SB MISC DEBUG Configuration

The items in this submenu contains options for SB DEBUG Configuration.

SB Clock Spread Spectrum [Enabled]

Allows you to enable or disable CG1_PLL Spread Spectrum.

Configuration options: [Disabled] [Enabled]

HPET In SB [Enabled]

Allows you to enable or disable the HPET Function Switch.

Configuration options: [Disabled] [Enabled]

MsiDis in HPET [Enabled]

Expose MSI capability in HPET Capability register.

Configuration options: [Disabled] [Enabled]

North Bridge

Socket 0 Information

This item displays the memory information on Socket 0.

5.7 Security menu

This menu allows a new password to be created or a current password to be changed. The menu also enables or disables the Secure Boot state and lets the user configure the System Mode state.

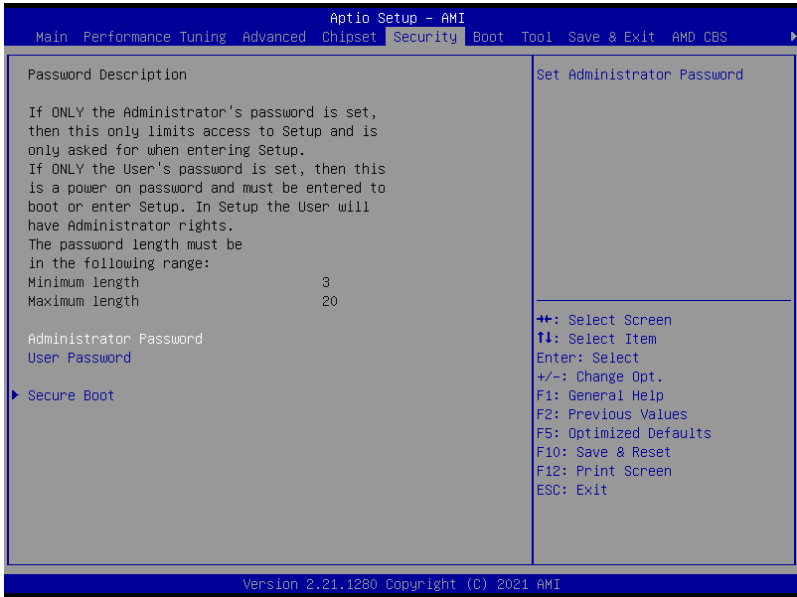

Administrator Password

To set an administrator password:

1. Select the Administrator Password item and press <Enter>.
2. From the Create New Password box, key in a password, then press <Enter>.
3. Confirm the password when prompted.

To change an administrator password:

1. Select the Administrator Password item and press <Enter>.
2. From the Enter Current Password box, key in the current password, then press <Enter>.
3. From the Create New Password box, key in a new password, then press <Enter>.
4. Confirm the password when prompted.



To clear the administrator password, follow the same steps as in changing an administrator password, but press <Enter> when prompted to create/confirm the password.

User Password

To set a user password:

1. Select the User Password item and press <Enter>.
2. From the Create New Password box, key in a password, then press <Enter>.
3. Confirm the password when prompted.

To change a user password:

1. Select the User Password item and press <Enter>.
2. From the Enter Current Password box, key in the current password, then press <Enter>.
3. From the Create New Password box, key in a new password, then press <Enter>.
4. Confirm the password when prompted.

To clear a user password:

1. Select the Clear User Password item and press <Enter>.
2. Select **Yes** from the Warning message window then press <Enter>.

Secure Boot

Allows you to customize the Secure Boot settings.



Secure Boot [Disabled]

Secure Boot feature is Active if Secure Boot is set to **[Enabled]**, Platform Key(PK) is enrolled, and the system is in User mode. A mode change requires a platform reset.
Configuration options: [Disabled] [Enabled]

Secure Boot Mode [Custom]

Allows you to set the Secure Boot selector. In Custom mode, Secure Boot Policy variables can be configured by a physically present user without fill authentication.
Configuration options: [Custom] [Standard]



The following items are only available when **Secure Boot Mode** is set to **[Custom]**.

Restore Factory Keys

This option will force the system to User Mode, and install factory default Secure Boot key databases.

Reset to Setup Mode

This option will delete all Secure Boot key databases from NVRAM.

Key Management

This item only appears when the item **Secure Boot Mode** is set to **[Custom]**. The Key Management item allows you to modify Secure Boot variables and set Key Management page.

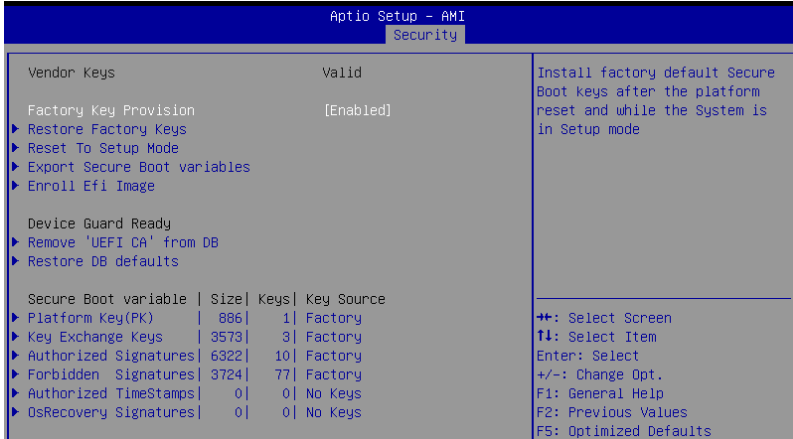

Factory Key Provision [Enabled]

Allows you to provision factory default Secure Boot keys when the system is in Setup Mode.

Configuration options: [Disabled] [Enabled]

Restore Factory Keys

This item will install all Factory Default keys.

Reset to Setup Mode

This item appears only when you load the default Secure Boot keys. Allows you to clear all default Secure Boot keys.

Export Secure Boot Variables

This item will ask you if you want to save all secure boot variables. Select Yes if you want to save all secure boot variables, otherwise select No.

Enroll Efi Image

This item will allow the image to run in Secure Boot mode.

Configuration options: [Set New] [Append]

Device Guard Ready

Remove 'UEFI CA' from DB

Remove Microsoft UEFI CA from Secure Boot DB.

Restore DB defaults

Restore DB variable to factory defaults.

Platform Key (PK)

Configuration options: [Details] [Export] [Update] [Delete]

Key Exchange Keys (KEK) / Authorized Signatures (DB) / Forbidden Signatures (DBX)

Configuration options: [Details] [Export] [Update] [Append] [Delete]

Authorized TimeStamps (DBT) / OsRecovery Signatures

Configuration options: [Update] [Append]

5.8 Boot menu

The Boot menu items allow you to change the system boot options.

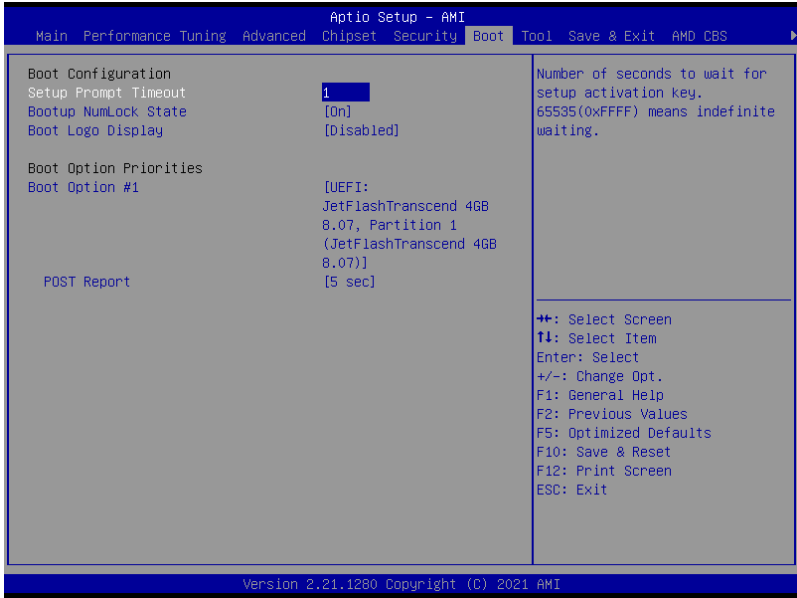

Setup Prompt Timeout [1]

Allows you to set the number of seconds that the firmware waits before initiating the original default boot selection. 65535(0xFFFF) means indefinite waiting. Use the <+> or <-> to adjust the value.

Bootup NumLock State [On]

Allows you to select the power-on state for the NumLock.
Configuration options: [Off] [On]

Quiet Boot [Disabled]

Allows you to enable or disable Quiet Boot option.
Configuration options: [Disabled] [Enabled]

Boot Option Priorities

These items specify the boot device priority sequence from the available devices. The number of device items that appears on the screen depends on the number of devices installed in the system.



- To select the boot device during system startup, press <F8> when ASUS Logo appears.
- To access Windows OS in Safe Mode, please press <F8> after POST.

POST Report [5 sec]

Allows you to set the desired POST Report waiting time from 1 to 10 seconds.
Configuration options: [1 sec] - [10 sec] [Until Press ESC]

5.9 Tool menu

The Tool menu items allow you to configure options for special functions. Select an item then press <Enter> to display the submenu.

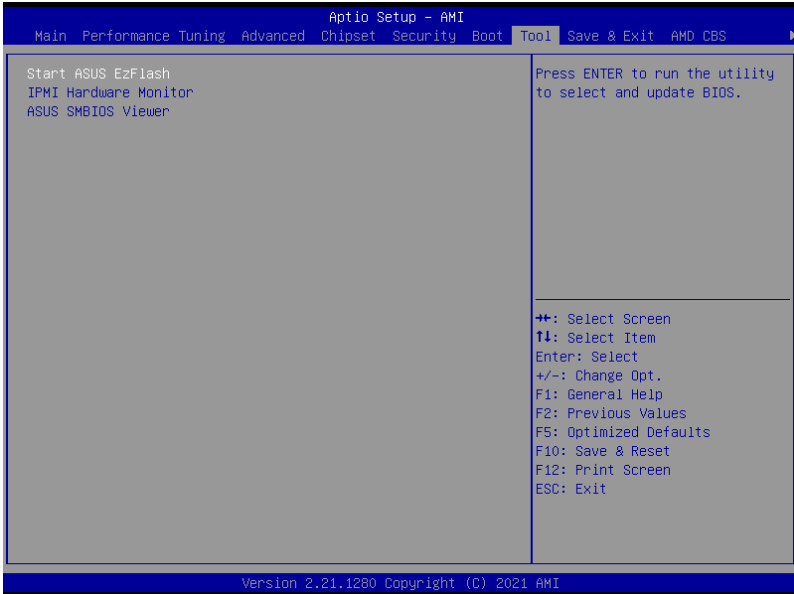

Start ASUS EzFlash

Allows you to run ASUS EzFlash BIOS ROM Utility when you press <Enter>. Refer to the ASUS EzFlash Utility section for details.

IPMI Hardware Monitor

Allows you to run the IPMI hardware monitor.

ASUS SMBIOS Viewer

Allows you to run the ASUS SMBIOS Viewer

5.10 Save & Exit menu

The Exit menu items allow you to save or discard your changes to the BIOS items.

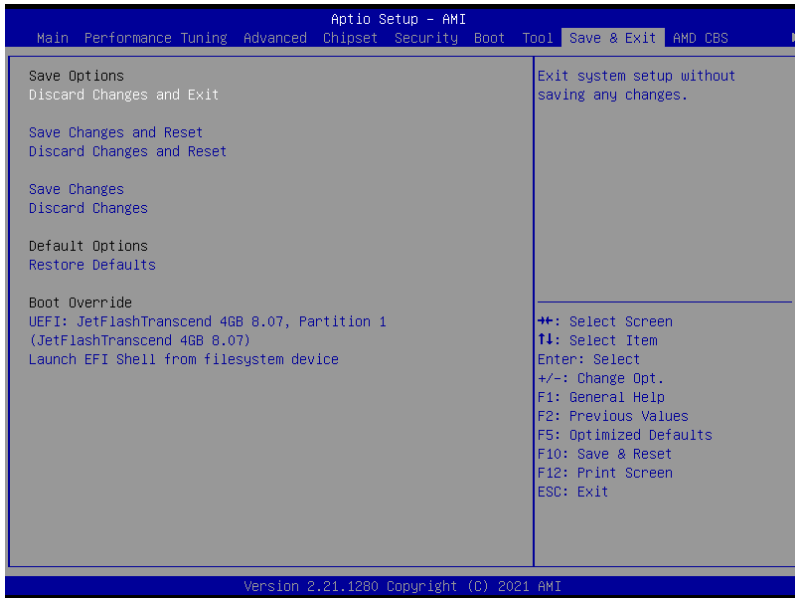

Pressing <Esc> does not immediately exit this menu. Select one of the options from this menu or <F10> from the legend bar to exit.

Discard Changes and Exit

Exit system setup without saving any changes.

Save Changes and Reset

Reset system after saving the changes.

Save Changes

Save changes done so far to any of the setup options.

Discard Changes

Discard changes done so far to any of the setup options.

Restore Defaults

Restore/load default values for all the setup options.

Boot Override

These items displays the available devices. The device items that appears on the screen depends on the number of devices installed in the system. Click an item to start booting from the selected device.

5.11 AMD CBS menu

The items in this menu shows the AMD Common BIOS Specifications.



The **AMD CBS** menu will appear under the **Advanced** menu for AMD EPIC™ 7003 Series processors.

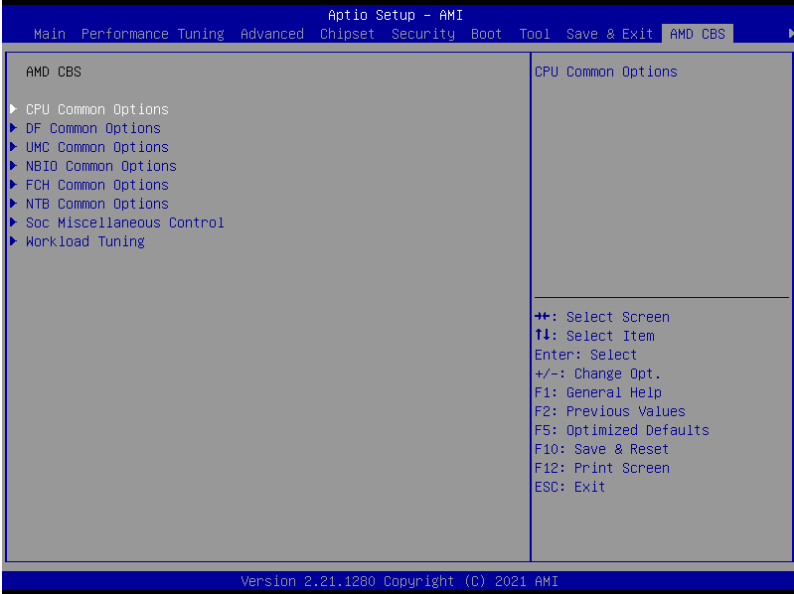

5.11.1 CPU Common Options

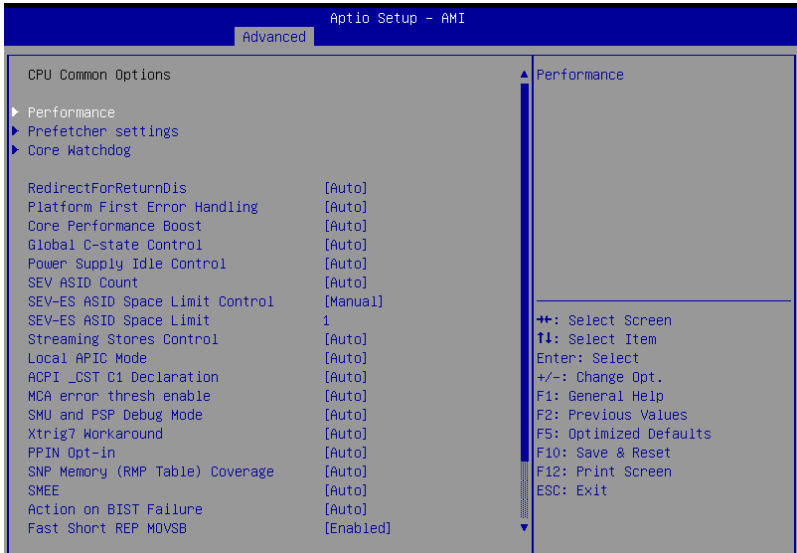

Performance

OC Mode [Normal Operation]

Configuration options: [Normal Operation] [Customized]



The following items appear only when **OC Mode** is set to **[Customized]**.

Custom Core Pstates

This option allows you to enable Core Pstates. Read the disclaimer and select I Accept to continue.



Damage caused by use of your AMD processor outside of specification or in excess of factory settings are not covered by your system manufacturers warranty.



The following items appear only when **[Accept]** is selected for **Custom Core Pstates**.

Custom Pstate0 [Auto]

Configuration options: [Auto] [Custom]



The following items appear only when **Custom Pstate0** is set to **[Custom]**.

Pstate0 Freq (MHz) [0]

Allows you to specify core frequency (MHz).

CCD/Core/Thread Enablement

This option allows you to enable CCD/Core/Thread Enablement.



S3 is not supported on systems where cores/threads have been removed/disabled.

CCD Control [Auto]

Sets the number of CCDs to be used. Once this option has been used to remove any CCDs, a POWER CYCLE is required in order for future selections to take effect.

Configuration options: [Auto] [2 CCDs] [3 CCDs] [4 CCDs] [6 CCDs]

Core Control [Auto]

Sets the number of cores to be used. Once this option has been used to remove any cores, a POWER CYCLE is required in order for future selections to take effect.

Configuration options: [Auto] [ONE (1 + 0)] [TWO (2 + 0)] [THREE (3 + 0)] [FOUR (4 + 0)] [FIVE (5 + 0)] [SIX (6 + 0)] [SEVEN (7 + 0)]

SMT Control [Auto]

Can be used to disable symmetric multithreading. To re-enable SMT, a POWER CYCLE is needed after selecting the **[Enable]** option. Select [Auto] based on BIOS PCD (PcdAmdSmtMode) default setting.

Configuration options: [Disable] [Enable] [Auto]



S3 is not supported on systems where cores/threads have been removed/disabled.

Prefetcher settings

L1 Stream HW Prefetcher [Auto]

Allows you to enable or disable L1 Stream HW Prefetcher.

Configuration options: [Disable] [Enable] [Auto]

L1 Stride Prefetcher [Auto]

Uses memory access history of individual instructions to fetch additional lines when each access is a constant distance from the previous.

Configuration options: [Disable] [Enable] [Auto]

L1 Region Prefetcher [Auto]

Uses memory access history to fetch additional lines when the data access for a given instruction tends to be followed by other data accesses.

Configuration options: [Disable] [Enable] [Auto]

L2 Stream HW Prefetcher [Auto]

Allows you to enable or disable L2 Stream HW Prefetcher.

Configuration options: [Disable] [Enable] [Auto]

L2 Up/Down Prefetcher [Auto]

Uses memory access history to determine whether to fetch the next or previous line for all memory access.

Configuration options: [Disable] [Enable] [Auto]

Core Watchdog

Core Watchdog Timer Enable [Auto]

Allows you to enable or disable CPU Watchdog Timer.
Configuration options: [Disable] [Enable] [Auto]



The following items are only available when **Core Watchdog Timer Enable** is set to **[Enabled]**.

Core Watchdog Timer Interval [Auto]

Configuration options: [21.461s] [10.730s] [5.364s] [2.681s] [1.340s] [669.41ms] [334.05ms] [166.37ms] [82.53ms] [40.61ms] [20.970ms] [10.484ms] [5.241ms] [2.620ms] [1.309ms] [654.08us] [326.4us] [162.56us] [80.64us] [39.68us] [Auto]

Core Watchdog Timer Severity [Auto]

Allows you to specify the CPU watch dog timer severity.
Configuration options: [No Error] [Transparent] [Corrected] [Deferred] [Uncorrected] [Fatal] [Auto]

RedirectForReturnDis [Auto]

This option is from a workaround for GCC/C000005 issue for XV Core on CZ A0, setting MSRC001_1029 Decode Configuration (DE_CFG) bit 14 [DecfgNoRdrctForReturns] to 1.
Configuration options: [Auto] [1] [0]

Platform First Error Handling [Auto]

This option is from a workaround for GCC/C000005 issue for XV Core on CZ A0, setting MSRC001_1029 Decode Configuration (DE_CFG) bit 14 [DecfgNoRdrctForReturns] to 1.
Configuration options: [Auto] [1] [0]

Core Performance Boost [Auto]

This option allows you to enable or disable CPB.
Configuration options: [Disabled] [Auto]

Global C-state Control [Auto]

This option allows you to control IO based C-state generation and DF C-states.
Configuration options: [Disabled] [Enabled] [Auto]

Power Supply Idle Control [Auto]

Configuration options: [Low Current Idle] [Typical Current Idle] [Auto]

SEV ASID Count [Auto]

This field specifies the maximum valid ASID, which affects the maximum system physical address space. 16TB of physical address space is available for systems that support 253 ASIDs, while 8TB of physical address space is available for systems that support 509 ASIDs.
Configuration options: [253 ASIDs] [509 ASIDs] [Auto]

SEV-ES ASID Space Limit Control [Auto]

Configuration options: [Auto] [Manual]



The following item appears only when **SEV-ES ASID Space Limit Control** is set to **[Manual]**.

SEV-ES ASID Space Limit [Auto]

SEV Vms using ASIDs below the SEV-ES ASID Space Limit must enable the SEV-ES feature. ASIDs from SEV-ES ASID Space Limit to (SEV ASID Count + 1) can only be used with SEV VMs. If this field is set to (SEV ASID Count + 1), all ASIDs are forced to be SEV-ES ASIDs. Hence, the valid values for this field is 1 - (SEV ASID Count + 1).

Configuration options: [1] – [520]

Streaming Stores Control [Auto]

Allows you to enable or disable the streaming stores functionality.

Configuration options: [1] – [520]

Local APIC Mode [Auto]

Configuration options: [Compatibility] [XAPIC] [X2APIC] [Auto]

ACPI _CST C1 Operation [Auto]

Determines whether or not to declare the C1 state to the OS.

Configuration options: [Disabled] [Enabled] [Auto]

MCA error thresh enable [Auto]

Allows you to enable or disable MCA error thresholding.

Configuration options: [False] [True] [Auto]



The following item appears only when **MCA error thresh enable** is set to **[True]**.

MCA error thresh count [FF5]

Allows you to set the effective error threshold count = 4095(0xFFFF) - <this value> (e.g. the default value of 0xFF5 results in a threshold of 10).

SMU and PSP Debug Mode [Auto]

When this option is set to **[Enabled]**, specific uncorrected errors detected by the PSP FW or SMU FW will hang and not reset the system.

Configuration options: [Disabled] [Enabled] [Auto]

Xtrig7 Workaround [Auto]

This workaround is only applicable for Rev A.

[Auto]	The bronze workaround is applied.
[No Workaround]	Applied for Rev B, and changing the selection for this option will not result in any changes.
[Bronze Workaround]	DbReq and PDM function as expected, breakpoint redirect capability compromised.
[Silver Workaround]	DbReq, PDM, and breakpoint redirect function as expected, SCAN capability compromised.

PPIN Opt-in [Auto]

Allows you to enable or disable the PPIN feature.

Configuration options: [Disabled] [Enabled] [Auto]

SNP Memory (RMP Table) Coverage [Auto]

Setting this option to [Enabled] will cover the entire system's memory.

Configuration options: [Disabled] [Enabled] [Custom] [Auto]



The following item appears only when **SNP Memory (RMP Table) Coverage** is set to **[Custom]**.

Amount of Memory to Cover [0]

Allows you to specify MB of System Memory to be covered in Hex.

SMEE [Auto]

Allows you to enable or disable secure memory encryption control.

Configuration options: [Disabled] [Enabled] [Auto]

Action on BIST Failure [Auto]

Allows you to set action to take when a CCD BIST failure is detected.

Configuration options: [Do Nothing] [Down-CCD] [Auto]

Fast Short REP MOVSB [Enabled]

Default set to 1, can be set to zero for analysis purposes as long as OS supports it.

Configuration options: [Disabled] [Enabled]

Enhanced REP MOVSB/STOSB [Enabled]

Default set to 1, can be set to zero for analysis purposes as long as OS supports it.

Configuration options: [Disabled] [Enabled]

REP-MOV/STOS Streaming [Enabled]

Allows REP-MOV/STOS to use non-caching streaming stores for large sizes.

Configuration options: [Disabled] [Enabled]

X3D [Auto]

Allows you to set the override of X3D technology.

Configuration options: [Auto] [Disable] [1 stack] [2 stacks] [4 stacks]

IBS hardware workaround [Auto]

Set this option if using IBS execution sampling without software workaround for erratum 1,285. May impact performance.

Configuration options: [Auto] [Enabled]

5.11.2 DF Common Options

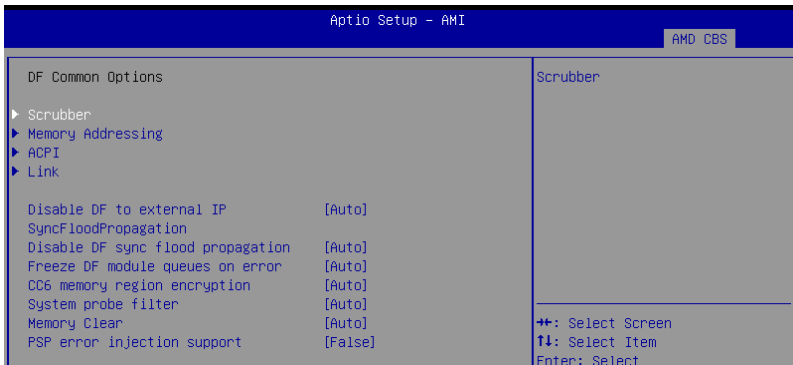

Scrubber

DRAM scrub time [Auto]

Allows you to set a number of hours to scrub memory.

Configuration options: [Disabled] [1 hour] [4 hours] [8 hours] [16 hours] [24 hours] [48 hours] [Auto]

Poison scrubber control [Auto]

Configuration options: [Disabled] [Enabled] [Auto]

Redirect scrubber control [Auto]

Configuration options: [Disabled] [Enabled] [Auto]

Redirect scrubber limit [Auto]

Configuration options: [2] [4] [8] [Infinite] [Auto]

Periodic Directory Rinse [Auto]

Configuration options: [Disabled] [Enabled] [Auto]

Memory Addressing

NUMA nodes per socket [Auto]

Specifies the number of desired NUMA nodes per socket. Zero will attempt to interleave the two sockets together.

Configuration options: [NPS1] [NPS2] [NPS4] [Auto]

Memory interleaving [Auto]

This item allows for disabling memory interleaving. Note that NUMA nodes per socket will be honored regardless of this setting.

Configuration options: [Disabled] [Auto]

Memory interleaving size [Auto]

This item controls the memory interleaving size. The valid values are AUTO, 256 bytes, 512 bytes, 1 Kbytes, or 2 Kbytes. This also determines the starting address of the interleave (bit 8, 9, 10, or 11).

Configuration options: [256 Bytes] [512 Bytes] [1 KB] [2 KB] [Auto]

1TB remap [Auto]

Attempt to remap DRAM out of the space just below the 1TB boundary. The ability to remap depends on DRAM configuration, NPS, and interleaving selection, and may not always be possible.

Configuration options: [Do not remap] [Attempt to remap] [Auto]

DRAM map inversion [Auto]

Inverting the map will cause the highest memory channels to get assigned the lowest addresses in the system.

Configuration options: [Disabled] [Enabled] [Auto]

Location of private memory regions [Auto]

Controls whether or not the private memory regions (PSP, SMU, and CC6) are at the top of DRAM or distributed. Note that distributed requires memory on all dies. Note that it will always be at the top of DRAM id some dies don't have memory regardless of this option's setting.

Configuration options: [Distributed] [Consolidated] [Consolidated to 1st DRAM pair] [Auto]

ACPI

ACPI SRAT L3 Cache As NUMA Domain [Auto]

[Disabled] Memory Addressing \ NUMA nodes per socket will be declared.

[Enabled] Each CCX in the system will be declared as a separate NUMA Domain.

[Auto] Auto.

ACPI SLIT Distance Control [Auto]

This option determines how the SLIT distances are declared.

Configuration options: [Manual] [Auto]



The following item appears only when **ACPI SLIT Distance Control** is set to **[Auto]**.

ACPI SLIT remote relative distance [Auto]

Allows you to set the remote socket distance for 2P systems as near (2.8) or far (3.2).

Configuration options: [Near] [Far] [Auto]



The following items appear only when **ACPI SLIT Distance Control** is set to **[Manual]**.

ACPI SLIT same socket distance [C]

Specify the distance to other physical domains within the same socket.

ACPI SLIT remote socket distance [20]

Specify the distance to domains the remote socket.

ACPI SLIT local SLink distance [32]

Specify the distance to an SLink domain on the same socket.

ACPI SLIT remote SLink distance [3C]

Specify the distance to an SLink domain on the other socket.

ACPI SLIT local inter-SLink distance [FF]

Specify the distance between two SLink domains on the same socket.

ACPI SLIT remote inter-SLink distance [FF]

Specify the distance between two SLink domains, each on a different socket.

Link

GMI encryption control [Auto]

Allows you to control the GMI link encryption.

Configuration options: [Disabled] [Enabled] [Auto]

xGMI encryption control [Auto]

Allows you to control the xGMI link encryption.

Configuration options: [Disabled] [Enabled] [Auto]

CAKE CRC perf bounds control [Auto]

Configuration options: [Auto] [Manual]



The following item appears only when **CAKE CRC perf bounds control** is set to **[Manual]**.

CAKE CRC perf bounds [64]

This item specifies the amount of performance loss that is acceptable to enable CRC protection. Units are in 0.00001%, RangeL disabled (0) - 10% (1000000).

xGMI Link Configuration [Auto]

Allows you to configure the number of xGMI2 links used on a multi-socket system.

Configuration options: [Auto] [2 xGMI Links] [3 xGMI Links] [4 xGMI Links]

4-link xGMI max speed [Auto]

Configuration options: [6.4Gbps] [7.467Gbps] [8.533Gbps] [9.6Gbps] [10.667Gbps] [11Gbps] [12Gbps] [13Gbps] [14Gbps] [15Gbps] [16Gbps] [17Gbps] [18Gbps] [19Gbps] [20Gbps] [21Gbps] [22Gbps] [23Gbps] [24Gbps] [25Gbps] [Auto]

3-link xGMI max speed [Auto]

Configuration options: [6.4Gbps] [7.467Gbps] [8.533Gbps] [9.6Gbps] [10.667Gbps] [11Gbps] [12Gbps] [13Gbps] [14Gbps] [15Gbps] [16Gbps] [17Gbps] [18Gbps] [19Gbps] [20Gbps] [21Gbps] [22Gbps] [23Gbps] [24Gbps] [25Gbps] [Auto]

xGMI TXEQ Mode [Auto]

Allows you to select the XGMI TXEQ/RX vetting mode.

Configuration options: [TXEQ_Disabled] [TXEQ_Lane] [TXEQ_Link] [TXEQ_RX_Vet] [Auto]

xGMI 18GACOFB [Auto]

Allows you to enable or disable the 18GACOFB control.

Configuration options: [Auto] [Enable] [Disable]

Disable DF to external downstream IP SyncFloodPropagation [Auto]

Allows you to enable or disable Error propagation to UMC or any downstream slaves e.g. FCH. Use this to avoid reset in failure scenario.

Configuration options: [Sync Flood disabled] [Sync Flood enabled] [Auto]

Disable DF sync flood propagation [Auto]

Allows you to enable or disable propagation from PIE to other DF components and eventually to SDP ports.

Configuration options: [Sync Flood disabled] [Sync Flood enabled] [Auto]

Freeze DF module queues on error [Auto]

Allows you to enable or disable freezing of all DF queues on error and also forces a sync flood on HWA even if MCAs are disabled.

Configuration options: [Disabled] [Enabled] [Auto]

CC6 memory region encryption [Auto]

Allows you to control whether or not the CC6 save/restore memory is encrypted.

Configuration options: [Disabled] [Enabled] [Auto]

System probe filter [Auto]

Allows you to control whether or not the probe filter is enabled. Has no effect on parts where the probe filter is fuse disabled.

Configuration options: [Disabled] [Enabled] [Auto]

Memory Clear [Auto]

Allows you to enable or disable memory clear. When this item is set to [Disabled], BIOS does not implement MemClear after memory training (only if non-ECC DIMMs are used).

Configuration options: [Disabled] [Enabled] [Auto]

PSP error injection support [False]

Configuration options: [False] [True]

5.11.3 UMC Common Option

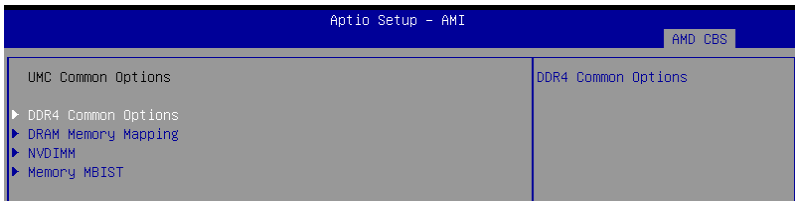

DDR4 Common Options

DRAM Timing Configuration

Allows you to enable DRAM timing configuration.



Damage caused by use of your AMD processor outside of specification or in excess of factory settings are not covered by your system manufacturers warranty.



The following items appear only when **[Accept]** is selected for **DRAM Timing Configuration**.

Overclock [Auto]

Configuration options: [Auto] [Enabled]



The following items appear only when **Overclock** is set to **[Enabled]**.

Memory Clock Speed [Auto]

Specifies the memory clock frequency.

Configuration options: [Auto] [667MHz] [800MHz] [933MHz] [1067MHz] [1200MHz] [1333MHz] [1467MHz] [1600MHz] [1633MHz] [1667MHz] [1700MHz] [1733MHz] [1767MHz] [1800MHz] [400MHz]

Tcl [Auto]

Specifies the CAS latency.

Configuration options: [Auto] [8 Clk] [9 Clk] [0Ah Clk] [0Bh Clk] [0Ch Clk] [0Dh Clk] [0Eh Clk] [0Fh Clk] [10h Clk] [11h Clk] [12h Clk] [13h Clk] [14h Clk] [15h Clk] [16h Clk] [17h Clk] [18h Clk] [19h Clk] [1Ah Clk] [1Bh Clk] [1Ch Clk] [1Dh Clk] [1Eh Clk] [1Fh Clk] [20h Clk] [21h Clk]

Trcdrd [Auto]

Specifies the RAS# Active to CAS# Read Delay Time.

Configuration options: [Auto] [8 Clk] [9 Clk] [0Ah Clk] [0Bh Clk] [0Ch Clk] [0Dh Clk] [0Eh Clk] [0Fh Clk] [10h Clk] [11h Clk] [12h Clk] [13h Clk] [14h Clk] [15h Clk] [16h Clk] [17h Clk] [18h Clk] [19h Clk] [1Ah Clk] [1Bh Clk]

Trcdwr [Auto]

Specifies the RAS# Active to CAS# Write Delay Time.

Configuration options: [Auto] [8 Clk] [9 Clk] [0Ah Clk] [0Bh Clk] [0Ch Clk] [0Dh Clk] [0Eh Clk] [0Fh Clk] [10h Clk] [11h Clk] [12h Clk] [13h Clk] [14h Clk] [15h Clk] [16h Clk] [17h Clk] [18h Clk] [19h Clk] [1Ah Clk] [1Bh Clk]

Trp [Auto]

Specifies the Row Precharge Delay Time.

Configuration options: [Auto] [8 Clk] [9 Clk] [0Ah Clk] [0Bh Clk] [0Ch Clk] [0Dh Clk] [0Eh Clk] [0Fh Clk] [10h Clk] [11h Clk] [12h Clk] [13h Clk] [14h Clk] [15h Clk] [16h Clk] [17h Clk] [18h Clk] [19h Clk] [1Ah Clk] [1Bh Clk]

Tras [Auto]

Specifies the Active to Precharge Delay Time.

Configuration options: [Auto] [15h Clk] [16h Clk] [17h Clk] [18h Clk] [19h Clk] [1Ah Clk] [1Bh Clk] [1Ch Clk] [1Dh Clk] [1Eh Clk] [1Fh Clk] [20h Clk] [21h Clk] [22h Clk] [23h Clk] [24h Clk] [25h Clk] [26h Clk] [27h Clk] [28h Clk] [29h Clk] [2Ah Clk] [2Bh Clk] [2Ch Clk] [2Dh Clk] [2Eh Clk] [2Fh Clk] [30h Clk] [31h Clk] [32h Clk] [33h Clk] [34h Clk] [35h Clk] [36h Clk] [37h Clk] [38h Clk] [39h Clk] [3Ah Clk]

Trc Ctrl [Auto]

Specifies Trc.

Configuration options: [Auto] [Manual]



The following item appears only when **Trc Ctrl** is set to **[Manual]**.

Trc [39]

Specifies Active to Active/Refresh Delay Time. Valid values 87h-1Dh.

TrrdS [Auto]

Specifies the Activate to Activate Delay Time, different back group (tRRD_S).

Configuration options: [Auto] [4 Clk] [5 Clk] [6 Clk] [7 Clk] [8 Clk] [9 Clk] [0Ah Clk] [0Bh Clk] [0Ch Clk]

TrrdL [Auto]

Specifies the Activate to Activate Delay Time, same back group (tRRD_L).

Configuration options: [Auto] [4 Clk] [5 Clk] [6 Clk] [7 Clk] [8 Clk] [9 Clk] [0Ah Clk] [0Bh Clk] [0Ch Clk]

Tfaw Ctrl [Auto]

Specifies Tfaw.

Configuration options: [Auto] [Manual]



The following item appears only when **Tfaw Ctrl** is set to **[Manual]**.

Tfaw [1]

Specifies the Four Activate Window Time. Valid values 36h-6h.

TwtrS [Auto]

Specifies the Minimum Write to Read Time, different bank group.

Configuration options: [Auto] [2 Clk] [3 Clk] [4 Clk] [5 Clk] [6 Clk] [7 Clk] [8 Clk] [9 Clk] [0Ah Clk] [0Bh Clk] [0Ch Clk] [0Dh Clk] [0Eh Clk]

TwtrL [Auto]

Specifies the Minimum Write to Read Time, same bank group.

Configuration options: [Auto] [2 Clk] [3 Clk] [4 Clk] [5 Clk] [6 Clk] [7 Clk] [8 Clk] [9 Clk] [0Ah Clk] [0Bh Clk] [0Ch Clk] [0Dh Clk] [0Eh Clk]

Twr Ctrl [Auto]

Specifies Twr.

Configuration options: [Auto] [Manual]



The following item appears only when **Twr Ctrl** is set to **[Manual]**.

Twr [12]

Specifies the Minimum Write Recovery Time. Valid values 51h-Ah.

Trcpage Ctrl [Auto]

Specifies Trcpage.

Configuration options: [Auto] [Manual]



The following item appears only when **Trcpage Ctrl** is set to **[Manual]**.

Trcpage [0]

SDRAM Optional Features (tMAW MAC). Valid values 3FFh-0h.

TrdrdScL Ctrl [Auto]

Specifies TrdrdScL.

Configuration options: [Auto] [Manual]



The following item appears only when **TrdrdScL Ctrl** is set to **[Manual]**.

TrdrdScL [3]

Specifies the CAS to CAS Delay Time, same bank group. Valid values Fh-1h.

TwrwrScL Ctrl [Auto]

Specifies TwrwrScL.

Configuration options: [Auto] [Manual]



The following item appears only when **TwrwrScL Ctrl** is set to **[Manual]**.

TwrwrScL [3]

Specifies the CAS to CAS Delay Time, same bank group. Valid values 3Fh-1h.

Trfc Ctrl [Auto]

Specifies Trfc.

Configuration options: [Auto] [Manual]



The following item appears only when **Trfc Ctrl** is set to **[Manual]**.

Trfc [138]

Specifies the Refresh Recovery Delay Time (tRFC1). Valid values 3DEh-3Ch.

Trfc2 Ctrl [Auto]

Specifies Trfc2.

Configuration options: [Auto] [Manual]



The following item appears only when **Trfc2 Ctrl** is set to **[Manual]**.

Trfc2 [C0]

Specifies the Refresh Recovery Delay Time (tRFC2). Valid values 3DEh-3Ch.

Trfc4 Ctrl [Auto]

Specifies Trfc4.

Configuration options: [Auto] [Manual]



The following item appears only when **Trfc4 Ctrl** is set to **[Manual]**.

Trfc4 [84]

Specifies the Refresh Recovery Delay Time (tRFC4). Valid values 3DEh-3Ch.

Tcwl [Auto]

Specifies the CAS Write Latency.

Configuration options: [Auto] [9 Clk] [0Ah Clk] [0Bh Clk] [0Ch Clk] [0Eh Clk] [10h Clk] [12h Clk] [14h Clk]

Trtp [Auto]

Specifies the Read CAS# to Precharge Delay Time.

Configuration options: [Auto] [5 Clk] [6 Clk] [7 Clk] [8 Clk] [9 Clk] [0Ah Clk] [0Bh Clk] [0Ch Clk] [0Dh Clk] [0Eh Clk]

Tcke [Auto]

Specifies the CKE minimum high and low pulse width in memory clock cycles.

Configuration options: [Auto] [1 Clk] [2 Clk] [3 Clk] [4 Clk] [5 Clk] [6 Clk] [7 Clk] [8 Clk] [9 Clk] [0Ah Clk] [0Bh Clk] [0Ch Clk] [0Dh Clk] [0Eh Clk] [0Fh Clk] [10h Clk] [11h Clk] [12h Clk] [13h Clk] [14h Clk] [15h Clk] [16h Clk] [17h Clk] [18h Clk] [19h Clk] [1Ah Clk] [1Bh Clk] [1Ch Clk] [1Dh Clk] [1Eh Clk] [1Fh Clk]

Trdwr [Auto]

Specifies the Read to Write turnaround timing.

Configuration options: [Auto] [1 Clk] [2 Clk] [3 Clk] [4 Clk] [5 Clk] [6 Clk] [7 Clk] [8 Clk] [9 Clk] [0Ah Clk] [0Bh Clk] [0Ch Clk] [0Dh Clk] [0Eh Clk] [0Fh Clk] [10h Clk] [11h Clk] [12h Clk] [13h Clk] [14h Clk] [15h Clk] [16h Clk] [17h Clk] [18h Clk] [19h Clk] [1Ah Clk] [1Bh Clk] [1Ch Clk] [1Dh Clk] [1Eh Clk] [1Fh Clk]

Twrrd [Auto]

Specifies the Write to Read turnaround timing.

Configuration options: [Auto] [1 Clk] [2 Clk] [3 Clk] [4 Clk] [5 Clk] [6 Clk] [7 Clk] [8 Clk] [9 Clk] [0Ah Clk] [0Bh Clk] [0Ch Clk] [0Dh Clk] [0Eh Clk] [0Fh Clk]

TwrrSc [Auto]

Specifies the Write to Write turnaround timing in the same chipselect.

Configuration options: [Auto] [1 Clk] [2 Clk] [3 Clk] [4 Clk] [5 Clk] [6 Clk] [7 Clk] [8 Clk] [9 Clk] [0Ah Clk] [0Bh Clk] [0Ch Clk] [0Dh Clk] [0Eh Clk] [0Fh Clk]

TwrrSd [Auto]

Specifies the Write to Write turnaround timing in the same DIMM.

Configuration options: [Auto] [1 Clk] [2 Clk] [3 Clk] [4 Clk] [5 Clk] [6 Clk] [7 Clk] [8 Clk] [9 Clk] [0Ah Clk] [0Bh Clk] [0Ch Clk] [0Dh Clk] [0Eh Clk] [0Fh Clk]

TwrrDd [Auto]

Specifies the Write to Write turnaround timing in a different DIMM.

Configuration options: [Auto] [1 Clk] [2 Clk] [3 Clk] [4 Clk] [5 Clk] [6 Clk] [7 Clk] [8 Clk] [9 Clk] [0Ah Clk] [0Bh Clk] [0Ch Clk] [0Dh Clk] [0Eh Clk] [0Fh Clk]

TrdrdSc [Auto]

Specifies the Read to Read turnaround timing in the same chipselect.

Configuration options: [Auto] [1 Clk] [2 Clk] [3 Clk] [4 Clk] [5 Clk] [6 Clk] [7 Clk] [8 Clk] [9 Clk] [0Ah Clk] [0Bh Clk] [0Ch Clk] [0Dh Clk] [0Eh Clk] [0Fh Clk]

TrdrdSd [Auto]

Specifies the Read to Read turnaround timing in the same DIMM.

Configuration options: [Auto] [1 Clk] [2 Clk] [3 Clk] [4 Clk] [5 Clk] [6 Clk] [7 Clk] [8 Clk] [9 Clk] [0Ah Clk] [0Bh Clk] [0Ch Clk] [0Dh Clk] [0Eh Clk] [0Fh Clk]

TrdrdDd [Auto]

Specifies the Read to Read turnaround timing in a different DIMM.

Configuration options: [Auto] [1 Clk] [2 Clk] [3 Clk] [4 Clk] [5 Clk] [6 Clk] [7 Clk] [8 Clk] [9 Clk] [0Ah Clk] [0Bh Clk] [0Ch Clk] [0Dh Clk] [0Eh Clk] [0Fh Clk]

ProcODT [Auto]

Specifies the Processor ODT.

Configuration options: [Auto] [High Impedance] [480 ohm] [240 ohm] [160 ohm] [120 ohm] [96 ohm] [80 ohm] [68.6 ohm] [60 ohm] [53.3 ohm] [48 ohm] [43.6 ohm] [40 ohm] [36.9 ohm] [34.3 ohm] [32 ohm] [30 ohm] [28.2 ohm]

DRAM Controller Configuration**DRAM Power Options****Power Down Enable [Auto]**

Allows you to enable or disable power down mode.

Configuration options: [Disabled] [Enabled] [Auto]

Power Down Entry Delay [BB8]

Allows you to specify value at UMC::CH::DramTiming17 [19:8] PwrDownDly.

SubUrgRefLowerBound [4]

Specifies the stored refresh limit required to enter sub-urgent refresh mode.

Constraint: SubUrgRefLowerBound <= UrgRefLimit. Valid value: 6~1

UrgRefLimit [6]

Specifies the stored refresh limit required to enter urgent refresh mode.

Constraint: SubUrgRefLowerBound <= UrgRefLimit. Valid value: 6~1

DRAM Maximum Activate Count [Auto]

Override DIMM SPD Byte 7 [3:0]. Maximum Activate Count (MAC). When set to [Auto] it will be based on SPD setting.

Configuration options: [Untested MAC] [700 K] [600 K] [500 K] [400 K] [300 K] [200 K] [Unlimited MAC] [Auto]

DRAM Refresh Rate [7.8 usec]

Configuration options: [7.8 usec] [3.9 usec]

Self-Refresh Exit Staggering [Disabled]

Tcksrx += (Trfc/n * (UMC_Number % 4)), here n = 3 or 4.

Configuration options: [Disabled] [Trfc / 3] [Trfc / 4]



Does not apply the extra addition if set to [Disabled].

Cmd2T

Select between 1T and 2T mode on ADDR/CMD.

Configuration options: [Auto] [1T] [2T]

Gear Down Mode

Configuration options: [Auto] [Disabled] [Enabled]

CAD Bus Configuration**CAD Bus Timing User Controls [Auto]**

Allows you to set the CAD bus signals to Auto or Manual.

Configuration options: [Auto] [Manual]



The following items appear only when you set **CAD Bus Timing User Controls** to **[Manual]**.

AddrCmdSetup [0]

Allows you to setup time on CAD bus signals.
Configuration options: [0] – [39]

CsOdtSetup [0]

Allows you to setup time on CAD bus signals.
Configuration options: [0] – [39]

CkeSetup [0]

Allows you to setup time on CAD bus signals.
Configuration options: [0] – [39]

CAD Bus Drive Strength User Controls [Auto]

Allows you to set the CAD bus signals to Auto or Manual.
Configuration options: [Auto] [Manual]



The following items appear only when you set **CAD Bus Drive Strength User Controls** to **[Manual]**.

ClkDrvStren [Auto]

Configuration options: [Auto] [120.0 Ohm] [60.0 Ohm] [40.0 Ohm] [30.0 Ohm] [24.0 Ohm] [20.0 Ohm]

AddrCmdDrvStren [Auto]

Configuration options: [Auto] [120.0 Ohm] [60.0 Ohm] [40.0 Ohm] [30.0 Ohm] [24.0 Ohm] [20.0 Ohm]

CsOdtDrvStren [Auto]

Configuration options: [Auto] [120.0 Ohm] [60.0 Ohm] [40.0 Ohm] [30.0 Ohm] [24.0 Ohm] [20.0 Ohm]

CkeDrvStren [Auto]

Configuration options: [Auto] [120.0 Ohm] [60.0 Ohm] [40.0 Ohm] [30.0 Ohm] [24.0 Ohm] [20.0 Ohm]

Data Bus Configuration

Data Bus Configuration User Controls [Auto]

Allows you to specify the mode for drive strength.
Configuration options: [Auto] [Manual]



The following items appear only when you set **Data Bus Configuration User Controls** to **[Manual]**.

RttNom [Auto]

Configuration options: [Rtt_Nom Disable] [RZQ/4] [RZQ/2] [RZQ/6] [RZQ/1] [RZQ/5] [RZQ/3] [RZQ/7] [Auto]

RttWr [Auto]

Configuration options: [Dynamic ODT Off] [RZQ/2] [RZQ/1] [Hi-Z] [RZQ/3] [Auto]

RttPark [Auto]

Configuration options: [Rtt_PARK Disable] [RZQ/4] [RZQ/2] [RZQ/6] [RZQ/1] [RZQ/5] [RZQ/3] [RZQ/7] [Auto]

Common RAS

Data Poisoning [Auto]

Configuration options: [Enabled] [Disabled] [Auto]

DRAM Post Package Repair [Disable]

Allows you to enable or disable DRAM POST Package Repair.

Configuration options: [Enable] [Disable]

RCD Parity [Auto]

Configuration options: [Enabled] [Disabled] [Auto]

DRAM Address Command Parity Retry [Auto]

Configuration options: [Enabled] [Disabled] [Auto]



The following item appears only when you set **DRAM Address Command Parity Retry** to **[Enabled]**.

Max Parity Error Replay [8]

The values in hex, 1, 2, or 3 is invalid.

Configuration options: [0] – [39]

Write CRC Enable [Auto]

Configuration options: [Enabled] [Disabled] [Auto]

DRAM Write CRC Enable and Retry Limit [Auto]

Configuration options: [Enabled] [Disabled] [Auto]



The following item appears only when you set **DRAM Write CRC Enable and Retry Limit** to **[Enabled]**.

Max Write CRC Error Replay [8]

The values in hex, 1, 2, or 3 is invalid.

Configuration options: [0] – [39]

Disable Memory Error Injection [True]

Configuration options: [False] [True]

ECC Configuration

DRAM ECC Symbol Size [Auto]

Configuration options: [x4] [x8] [x16] [Auto]

DRAM ECC Enable [Auto]

This option allows you to enable or disable DRAM ECC. Auto will set ECC to enable.

Configuration options: [Disabled] [Enabled] [Auto]

DRAM UECC Retry [Auto]

This option allows you to enable or disable DRAM UECC Retry.

Configuration options: [Disabled] [Enabled] [Auto]

Security

TSME [Auto]

Configuration options: [Disabled] [Enabled] [Auto]

Data Scramble [Auto]

Configuration options: [Disabled] [Enabled] [Auto]

Phy Configuration

PMU Training

DFE Read Training [Auto]

Perform 2D Read Training with DFE on.

Configuration options: [Disabled] [Enabled] [Auto]

FFE Write Training [Auto]

Perform 2D Read Write Training with FFE on.

Configuration options: [Disabled] [Enabled] [Auto]

PMU Pattern Bits Control [Auto]

Configuration options: [Auto] [Manual]

PMU Pattern Bits [0]

Configuration options: [0] - [9]

DRAM Memory Mapping

Chipselect Interleaving [Auto]

Allows you to set interleave memory blocks across the DRAM chip selects for node 0.

Configuration options: [Disabled] [Auto]

BankGroupSwap [Auto]

Configuration options: [Enabled] [Disabled] [Auto]

BankGroupSwapAlt [Auto]

Configuration options: [Enabled] [Disabled] [Auto]

Address Hash Bank [Auto]

Allows you to enable or disable bank address hashing.

Configuration options: [Enabled] [Disabled] [Auto]

Address Hash CS [Auto]

Allows you to enable or disable CS address hashing.

Configuration options: [Enabled] [Disabled] [Auto]

Address Hash Rm [Auto]

Allows you to enable or disable RM address hashing.

Configuration options: [Enabled] [Disabled] [Auto]

SPD Read Optimization [Auto]

Allows you to enable or disable SPD Read Optimization, if set to **[Enabled]**, SPD reads are skipped for Reserved fields and most of upper 256 Bytes. If set to **[Disabled]**, read all 512 SPD Bytes.

Configuration options: [Enabled] [Disabled] [Auto]

NVDIMM

Disable NVDIMM-N Feature [No]

Allows you to disable NVDIMM-N feature for memory margin tool.

Configuration options: [No] [Yes]

Memory MBIST

MBIST Enable [Disabled]

Allows you to enable or disable Memory MBIST.
Configuration options: [Enabled] [Disabled]



The following items appear only when **MBIST Enable** is set to **[Enabled]**.

MBIST Test Mode [Auto]

Allows you to select the MBIST Test Mode - Interface Mode (Tests Single and Multiple CS transactions and Basic Connectivity) or Data Eye Mode (Measures Voltage vs. Timing).

Configuration options: [Interface Mode] [Data Eye Mode] [Both] [Auto]

MBIST Aggressors [Auto]

Allows you to enable or disable Memory Aggressor test.

Configuration options: [Enabled] [Disabled] [Auto]

MBIST Per Bit Slave Die Reporting [Auto]

Reports 2D Data Eye Results in ABL Log for each DQ, Chipselect, and Channel.

Configuration options: [Enabled] [Disabled] [Auto]

Data Eye

Pattern Select [PRBS]

Configuration options: [PRBS] [SS0] [Both]

Pattern Length [3]

This token helps to determine the pattern length. The possible options are N=3...12.

Configuration options: [3] – [9]

Aggressor Channel [1 Aggressor Channel]

This helps read the aggressors channels. If set to **[Enabled]**, you can read from one or more than one aggressor channel. The default is set to **[Disabled]**.

Configuration options: [Disabled] [1 Aggressor Channel] [3 Aggressor Channels] [7 Aggressor Channels]

Aggressor Static Lane Control [Disabled]

Configuration options: [Disabled] [Enabled]



The following items appear only when **Aggressor Static Lane Control** is set to **[Enabled]**.

Aggressor Static Lane Select Upper 32 bits [0]

Static Lane Select for Upper 32 bits. The bit mask represents the bits to be read.

Configuration options: [0] - [99999999]

Aggressor Static Lane Select Lower 32 bits [0]

Static Lane Select for Lower 32 bits. The bit mask represents the bits to be read.

Configuration options: [0] - [99999999]

**Aggressor Static Lane Select ECC [0]**

Static Lane Select for ECC Lanes. The bit mask represents the bits to be read.

Configuration options: [0] - [9]

Aggressor Static Lane Value [0]

Configuration options: [0] - [9]

Target Static Lane Control [Disabled]

Configuration options: [Disabled] [Enabled]

The following items appear only when **Target Static Lane Control** is set to **[Enabled]**.

Target Static Lane Select Upper 32 bits [0]

Static Lane Select for Upper 32 bits. The bit mask represents the bits to be read.

Configuration options: [0] - [999999999]

Target Static Lane Select Lower 32 bits [0]

Static Lane Select for Lower 32 bits. The bit mask represents the bits to be read.

Configuration options: [0] - [999999999]

Target Static Lane Select ECC [0]

Static Lane Select for ECC Lanes. The bit mask represents the bits to be read.

Configuration options: [0] - [9]

Target Static Lane Value [0]

Configuration options: [0] - [9]

Worst Case Margin Granularity [Per Chip Select]

Configuration options: [Per Chip Select] [Per Nibble]

Read Voltage Sweep Step Size [1]

This option determines the step size for Read Data Eye voltage sweep.

Configuration options: [1] [2] [4]

Read Timing Sweep Step Size [1]

This option supports step size for Read Data Eye.

Configuration options: [1] [2] [4]

Write Voltage Sweep Step Size [1]

This option determines the step size for write Data Eye voltage sweep.

Configuration options: [1] [2] [4]

Write Timing Sweep Step Size [1]

This option supports step size for write Data Eye.

Configuration options: [1] [2] [4]

Memory Healing BIST [Disabled]

Allows you to enable a full memory test. The testing will increase the boot time. BIOS mem BIST tests the full memory after training. Failing memory will be repaired using soft or hard PPR depending on the PPC configuration. The test will take 3 minutes per 16GN of installed memory. Self-Healing BIST runs the JEDEC DRAM self healing if the device supports the feature. The DRAM will do a hard repair for failing memory. The test will take 10 seconds per memory rank per channel.

Configuration options: [Disabled] [BIOS Mem BIST] [Self-Healing Mem BIST] [BIOS and Self-Healing Mem BIST]



The following items appear only when **Memory Healing BIST** is set to **[BIOS Mem BIST]**.

Mem BIST Test Select [Vendor Tests Enabled]

Select the vendor specific tests to use with BIOS memory healing BIST.
Configuration options: [Vendor Tests Enabled] [Vendor Tests Disabled] [All Tests - All Vendors]

Mem BIST Post Package Repair Type [Soft Repair]

For DRAM errors found in the BIOS memory BIST select the repair type, soft, hard, or test only and do not attempt to repair.
Configuration options: [Soft Repair] [Hard Repair] [No Repairs - Test only]

5.11.4 NBIO Common Options

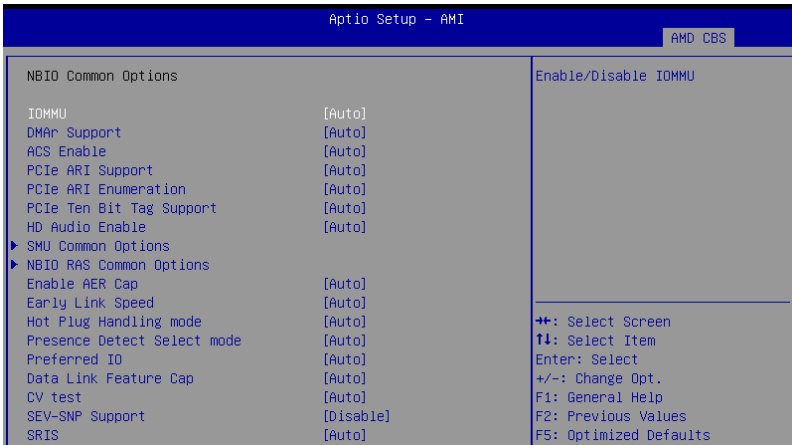

IOMMU [Auto]

Allows you to enable or disable IOMMU.
Configuration options: [Disabled] [Enabled] [Auto]

DMAR Support [Auto]

Allows you to enable DMAR system protection during POST.
Configuration options: [Disable] [Enable] [Auto]



The following item appears only when **Enable AER Cap** is set to **[Auto]** or **[Enable]**.

ACS Enable [Auto]

AER must be enabled for ACS enable to work.
Configuration options: [Disable] [Enable] [Auto]

PCIe ARI Support [Auto]

This item enables Alternative Routing-ID Interpretation.
Configuration options: [Disable] [Enable] [Auto]

PCIe ARI Enumeration [Auto]

Allows ARI Forwarding for each downstream port.
Configuration options: [Disable] [Enable] [Auto]

PCIe Ten Bit Tag Support [Auto]

This item enables PCIe ten bit tags for supported devices. [Auto] = [Disabled].
Configuration options: [Disable] [Enable] [Auto]

HD Audio Enable [Auto]

Configuration options: [Disabled] [Enable] [Auto]

SMU Common Options

Determinism Control [Auto]

[Auto] Use the fused Determinism.

[Manual] User can set customized Determinism.



The following item appears only when **Determinism Control** is set to **[Manual]**.

Determinism Slider [Power]

Configuration options: [Auto] [Power] [Performance]

Fan Control

Fan Table Control [Auto]

[Auto] Use the default fan table.

[Manual] User can set customized fan table.



The following item appears only when **Fan Table Control** is set to **[Manual]**.

Low Temperature [0]

Allows you to set the low temperature in °C.

Medium Temperature [0]

Allows you to set the medium temperature in °C.

High Temperature [0]

Allows you to set the high temperature in °C.

Critical Temperature [0]

Allows you to set the critical temperature in °C.

Low Pwm [0]

Allows you to set the low Pwm from 0-100.

Medium Pwm [0]

Allows you to set the medium Pwm from 0-100.

High Pwm [0]

Allows you to set the high Pwm from 0-100.

Temperature Hysteresis [0]

Allows you to set the temperature hysteresis in °C.

Pwm Frequency [25kHz]

Configuration options: [100Hz] [25kHz]

Fan Polarity [Negative]

Configuration options: [Negative] [Positive]

cTDP Control [Auto]

[Auto] Use the fused TDP.

[Manual] User can set customized TDP.



The following item appears only when **cTDP Control** is set to **[Manual]**.

cTDP [280]

Allows you to customize cTDP.

EfficiencyModeEn [Auto]

[Auto] Use performance optimized CCLK DPM settings.

[Enabled] Use power efficiency optimized CCLK DPM settings.

Power Package Limit Control [Auto]

[Auto] Use the fused PPT.

[Manual] User can set customized PPT.



The following item appears only when **Power Package Limit Control** is set to **[Manual]**.

Power Package Limit [280]

Allows you to customize PPT.

xGMI Link Width Control [Auto]

[Auto] Use default xGMI link width controller settings.

[Manual] User can set custom xGMI link width controller settings.



The following items appear only when **xGMI Link Width Control** is set to **[Manual]**.

xGMI Force Link Width Control [Unforce]

[Unforce] Do not force the xGMI to a fixed width.

[Force] Force the xGMI to the user specified width.



The following item appears only when **xGMI Force Link Width Control** is set to **[Force]**.

xGMI Force Link Width [2]

[0] Force xGMI link width to x2.

[1] Force xGMI link width to x8.

[2] Force xGMI link width to x16.

xGMI Max Link Width Control [Auto]

[Auto] Use default xGMI max supported link width.

[Manual] User can set custom xGMI max link width.



The following item appears only when **xGMI Max Link Width Control** is set to **[Manual]**.

xGMI Max Link Width [1]

[0] Set max xGMI link width to x8.

[1] Set max xGMI link width to x16.

APBDIS [Auto]

[0] Not APBDIS (mission mode)

[1] APBDIS

[Auto] Auto

DF Cstates [Auto]

Allows you to enable or disable DF C-states.

Configuration options: [Disabled] [Enabled] [Auto]

CPPC [Auto]

Configuration options: [Disabled] [Enabled] [Auto]

HSMP Support [Auto]

This option allows you to enable or disable HSMP support.

Configuration options: [Disabled] [Enabled] [Auto]

DLWM Support [Auto]

This option allows you to enable or disable DLWM support.

Configuration options: [Disabled] [Enabled] [Auto]

Boost FmaxEn [Auto]

[Auto] Use the default Fmax.

[Manual] User can set the boost Fmax.



The following item appears only when **Boost FmaxEn** is set to **[Manual]**.

BoostFmax [0]

Allows you to specify the boost Fmax frequency limit to apply to all cores (MHz).

EDC Current Tracking [Disable]

The generation of a correctable MCE when the telemetry current value is over the set threshold defined by EDC Current Tracking Current Threshold.

Configuration options: [Disable] [Enable]



The following items appears only when **EDC Current Tracking** is set to **[Enable]**.

EDC Tracking Current Threshold [0]

The current threshold in AMPs for EDC Current Tracking feature.

EDC Tracking Report Interval [1]

Reporting interval. Every nth observed excursion results in SMU logging a correctable MCE.

LCLK Frequency Control

Root Complex 0x00 LCLK Frequency [Auto]

Set Root Complex LCLK Frequency (Bus range 0x00-0x3F).

[Auto] Dynamic Frequency Control (Enhanced PIO setting will be in effect).

[593MHz] Set LCLK Frequency at 593MHz (Overrides Enhanced PIO setting).

Root Complex 0x40 LCLK Frequency [Auto]

Set Root Complex LCLK Frequency (Bus range 0x40-0x7F).

[Auto] Dynamic Frequency Control (Enhanced PIO setting will be in effect).

[593MHz] Set LCLK Frequency at 593MHz (Overrides Enhanced PIO setting).

Root Complex 0x80 LCLK Frequency [Auto]

Set Root Complex LCLK Frequency (Bus range 0x80-0xBF).

[Auto] Dynamic Frequency Control (Enhanced PIO setting will be in effect).

[593MHz] Set LCLK Frequency at 593MHz (Overrides Enhanced PIO setting).

Root Complex 0xC0 LCLK Frequency [Auto]

Set Root Complex LCLK Frequency (Bus range 0xC0-0xFF).

[Auto] Dynamic Frequency Control (Enhanced PIO setting will be in effect).

[593MHz] Set LCLK Frequency at 593MHz (Overrides Enhanced PIO setting).

DF PState Mode Select [Auto]

[Normal] Normal

[Limit Highest] FCLK is limited to DF Pstate FCLK Limit, only the highest DF Pstate is used.

[Limit All] FCLK is limited to DF Pstate FCLK limit, all DF Pstates are used.

[Auto] Auto

EDC Control [Auto]

[Auto] Use the fused VDDCR_CPU EDC limit.

[Manual] User can set customized VDDCR_CPU EDC limit.



The following items appears only when **EDC Control** is set to **[Manual]**.

EDC [0]

Allows you to set the VDDCR_CPU EDC Limit [A].

EDC Platform Limit [0]

Allows you to set the EDC Platform Limit [W].

NBIO RAS Common Options

NBIO RAS Control [Auto]

Configuration options: [Disabled] [MCA] [Legacy] [Auto]

Egress Poison Severity High [30011]

Each bit set to 1 enables HIGH severity on the associated IOHC egress port. A bit of 0 indicates LOW severity.

Egress Poison Severity Low [4]

Each bit set to 1 enables HIGH severity on the associated IOHC egress port. A bit of 0 indicates LOW severity.

NBIO SyncFlood Generation [Auto]

This value may be used to mask SyncFlood caused by NBIO RAS options. When set to TRUE, SyncFlood from NBIO is masked. When set to FALSE, NBIO is capable of generating SyncFlood.

Configuration options: [Disabled] [Enabled] [Auto]

NBIO SyncFlood Reporting [Auto]

This value may be used to enable SyncFlood reporting to APML. When set to TRUE, SyncFlood will be reported to APML. When set to FALSE, the reporting will be disabled.

Configuration options: [Disabled] [Enabled] [Auto]

Egress Poison Mask High [FFFFFFF]

These set the enable mask for masking of errors logged in EGRESS_POISON_STATUS. For each bit set to 1, errors are masked. For each bit set to 0, errors trigger response actions.

Egress Poison Mask Low [FFFFFFB]

These set the enable mask for masking of errors logged in EGRESS_POISON_STATUS. For each bit set to 1, errors are masked. For each bit set to 0, errors trigger response actions.

Uncorrected Converted to Poison Enable Mask High [30000]

These set the enable mask for masking of uncorrectable parity errors on internal arrays. For each bit set to 1, a system fatal error event is triggered for UCP errors on arrays associated with that egress port. For each bit set to 0, errors are masked.

Uncorrected Converted to Poison Enable Mask Low [4]

These set the enable mask for masking of uncorrectable parity errors on internal arrays. For each bit set to 1, a system fatal error event is triggered for UCP errors on arrays associated with that egress port. For each bit set to 0, errors are masked.

System Hub Watchdog Timer [a28]

This value specifies the timer interval of the SYSHUB Watchdog Timer in milliseconds.

SLink Read Response OK [Disabled]

This value specifies whether SLINK read response errors are converted to an Okay response. When this value is set to TRUE, read response errors are converted to Okay responses with data of all FFs. When set to FALSE, read response errors are not converted.

Configuration options: [Disabled] [Enabled]

SLink Read Response Error Handling [Log Errors in MCA]

This value specifies whether SLINK write response errors are converted to an Okay response. When this value is set to 0, write response errors will be logged in the MCA. When set to 1, write response errors will trigger an MCOMMIT error. When this value is set to 2, write response errors are converted.

Configuration options: [Enabled] [Trigger MCOMMIT Error] [Log Errors in MCA]

Log Poison Data from SLINK [Disabled]

This value specifies whether poison data propagated from SLINK will generate a deferred error. When this value is set to TRUE, deferred errors are enabled. When set to FALSE, errors are not generated.

Configuration options: [Disabled] [Enabled]

PCIe Aer Reporting Mechanism [Auto]

This value selects the method of reporting AER errors from PCI Express. A value of 0 indicates that the hardware will report the error through MCA. A value of 1 allows OS First handling of the errors through generation of a system control interrupt (SCI). A value of 2 allows Firmware First handling of the errors through generation of a system control interrupt (SCI).

Configuration options: [Firmware First] [OS First] [Auto]

Edpc Control [Auto]

Configuration options: [Disabled] [Enabled] [Auto]

NBIO Poison Consumption [Auto]

Configuration options: [Disabled] [Enabled] [Auto]

Sync Flood on PCIe Fatal Error [Auto]

Configuration options: [Auto] [True] [False]

Enable AER Cap [Auto]

Allows you to enable or disable Advanced Error Reporting Capability.

Configuration options: [Enable] [Disabled] [Auto]

Early Link Speed [Auto]

Allows you to set Early Link Speed.

Configuration options: [Auto] [Gen1] [Gen2]

Hot Plug Handling mode [Auto]

Allows you to control the Hot Plug Handling mode.

Configuration options: [OS First] [Firmware First] [Auto]

Presence Detect Select mode [Auto]

Allows you to control the Presence Detect Select mode.

Configuration options: [OR] [AND] [Auto]

Preferred IO [Auto]

Allows you to select the preferred IO select type.
Configuration options: [Bus] [Auto]

Data Link Feature Cap [Auto]

Allows you to set Data Link Feature Capability.
Configuration options: [Enabled] [Disabled] [Auto]

CV test [Auto]

Set this to [Enabled] to support running PCIECV tool. Selecting [Auto] will preserve h/w defaults.
Configuration options: [Auto] [Disabled] [Enabled]

SEV-SNP Support [Disable]

Configuration options: [Disabled] [Enabled]

SRIS [Auto]

Configuration options: [Auto] [Disable] [Enable]

5.11.5 FCH Common Options

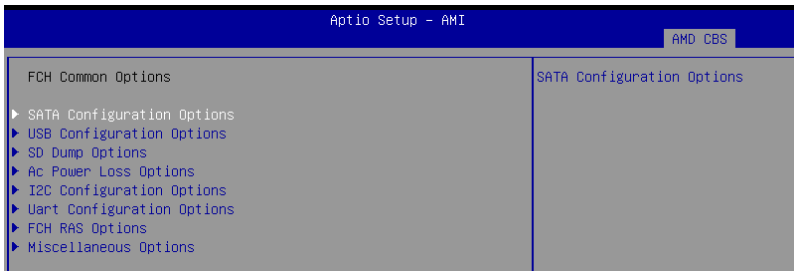

SATA Configuration Options

SATA Enable [Auto]

Allows you to enable or disable OnChip SATA controller.
Configuration options: [Disabled] [Enabled] [Auto]



The following item appears only when **SATA Enable** is set to [Enabled].

SATA Mode [AHCI]

Allows you to select the OnChip SATA Type.
Configuration options: [AHCI] [AHCI as ID 0x7904] [Auto]

Sata RAS Support [Auto]

Allows you to enable or disable Sata RAS Support.
Configuration options: [Disabled] [Enabled] [Auto]

Sata Disabled AHCI Prefetch Function [Auto]

Allows you to enable or disable Sata Disabled AHCI Prefetch Function.
Configuration options: [Disabled] [Enabled] [Auto]

Aggressive SATA Device Sleep Port 0 [Auto]

Configuration options: [Disabled] [Enabled] [Auto]



The following item appears only when **Aggressive SATA Device Sleep Port 0** is set to **[Enabled]**.

DevSleep0 Port Number [0]

Allows you to set the DEVSLP port 0.
Configuration options: [0] - [7]

Aggressive SATA Device Sleep Port 1 [Auto]

Configuration options: [Disabled] [Enabled] [Auto]



The following item appears only when **Aggressive SATA Device Sleep Port 1** is set to **[Enabled]**.

DevSleep1 Port Number [0]

Allows you to set the DEVSLP port 1.
Configuration options: [0] - [7]

SATA Controller options

SATA Controller Enable

Sata0 Enable [Auto]

Allows you to enable or disable Sata0. Each IOD has 4 Sata Controllers.
Configuration options: [Disabled] [Enabled] [Auto]

Sata1 Enable [Auto]

Allows you to enable or disable Sata1. Each IOD has 4 Sata Controllers.
Configuration options: [Disabled] [Enabled] [Auto]

Sata2 Enable [Auto]

Allows you to enable or disable Sata2. Each IOD has 4 Sata Controllers.
Configuration options: [Disabled] [Enabled] [Auto]

Sata3 Enable [Auto]

Allows you to enable or disable Sata3. Each IOD has 4 Sata Controllers.
Configuration options: [Disabled] [Enabled] [Auto]

Sata4 (Socket1) Enable [Auto]

Allows you to enable or disable Sata4 on Socket 1 (IOD1). Each IOD has 4 Sata Controllers.
Configuration options: [Disabled] [Enabled] [Auto]

Sata5 (Socket1) Enable [Auto]

Allows you to enable or disable Sata5 on Socket 1 (IOD1). Each IOD has 4 Sata Controllers.
Configuration options: [Disabled] [Enabled] [Auto]

Sata6 (Socket1) Enable [Auto]

Allows you to enable or disable Sata6 on Socket 1 (IOD1). Each IOD has 4 Sata Controllers.
Configuration options: [Disabled] [Enabled] [Auto]

Sata7 (Socket1) Enable [Auto]

Allows you to enable or disable Sata7 on Socket 1 (IOD1). Each IOD has 4 Sata Controllers.

Configuration options: [Disabled] [Enabled] [Auto]

SATA Controller eSATA**SATA Controller DevSlp****Socket1 DevSlp****Socket1 DevSlp0 Enable [Auto]**

Only Sata0 on each IOD/socket supports DevSlp.

Configuration options: [Disabled] [Enabled] [Auto]



The following item appears only when **Socket1 DevSlp0 Enable** is set to **[Enabled]**.

DevSleep0 Port Number [0]

Allows you to set DEVSLP port 0.

Configuration options: [0] - [7]

Socket1 DevSlp1 Enable [Auto]

Only Sata0 on each IOD/socket supports DevSlp.

Configuration options: [Disabled] [Enabled] [Auto]



The following item appears only when **Socket1 DevSlp1 Enable** is set to **[Enabled]**.

DevSleep0 Port Number [1]

Allows you to set DEVSLP port 1.

Configuration options: [0] - [7]

SATA Controller SGPIO**Sata0 SGPIO [Auto]**

Allows you to enable or disable SataSgpio on Sata0.

Configuration options: [Disabled] [Enabled] [Auto]

Sata1 SGPIO [Auto]

Allows you to enable or disable SataSgpio on Sata1.

Configuration options: [Disabled] [Enabled] [Auto]

Sata2 SGPIO [Auto]

Allows you to enable or disable SataSgpio on Sata2.

Configuration options: [Disabled] [Enabled] [Auto]

Sata3 SGPIO [Auto]

Allows you to enable or disable SataSgpio on Sata3.

Configuration options: [Disabled] [Enabled] [Auto]

Sata4 SGPIO [Auto]

Allows you to enable or disable SataSgpio on Sata4.

Configuration options: [Disabled] [Enabled] [Auto]

Sata5 SGPIO [Auto]

Allows you to enable or disable SataSgpio on Sata5.

Configuration options: [Disabled] [Enabled] [Auto]

Sata6 SGPIO [Auto]

Allows you to enable or disable SataSgpio on Sata6.

Configuration options: [Disabled] [Enabled] [Auto]

Sata7 SGPIO [Auto]

Allows you to enable or disable SataSgpio on Sata7.

Configuration options: [Disabled] [Enabled] [Auto]

USB Configuration Options

XHCI Controller0 enable [Auto]

Allows you to enable or disable USB3 controller.

Configuration options: [Enabled] [Disabled] [Auto]

XHCI Controller1 enable [Auto]

Allows you to enable or disable USB3 controller.

Configuration options: [Enabled] [Disabled] [Auto]

USB ecc SMI Enable [Auto]

MCM USB enable

XHCI2 enable (Socket1) [Auto]

Allows you to enable or disable USB3 controller.

Configuration options: [Disabled] [Enabled] [Auto]

XHCI3 enable (Socket1) [Auto]

Allows you to enable or disable USB3 controller.

Configuration options: [Disabled] [Enabled] [Auto]

SD Dump Options

SD Configuration Mode [SD Dump disabled]

Configuration options: [SD Dump disabled] [SD Dump enabled]

Ac Power Loss Options

AC Loss Control [Always On]

Allows you to select Ac Loss Control Method.

Configuration options: [Always Off] [Always On] [Reserved] [Previous] [Auto]

I2C Configuration Options

I2C 0 Enable [Auto]

Configuration options: [Disabled] [Enabled] [Auto]

I2C 1 Enable [Auto]

Configuration options: [Disabled] [Enabled] [Auto]

I2C 2 Enable [Auto]

Configuration options: [Disabled] [Enabled] [Auto]

I2C 3 Enable [Auto]

Configuration options: [Disabled] [Enabled] [Auto]

I2C 4 Enable [Auto]

Configuration options: [Disabled] [Enabled] [Auto]

I2C 5 Enable [Auto]

Configuration options: [Disabled] [Enabled] [Auto]

Uart Configuration Options

Uart 0 Enable [Auto]

Uart 0 has no HW FC is Uart 2 is enabled.
Configuration options: [Disabled] [Enabled] [Auto]



The following item appears only when **Uart 0 Enable** is set to **[Enabled]**.

Uart 0 Legacy Options [Auto]

Configuration options: [Disabled] [0x2E8] [0x2F8] [0x3E8] [0x3F8] [Auto]

Uart 1 Enable [Auto]

Uart 1 has no HW FC is Uart 3 is enabled.
Configuration options: [Disabled] [Enabled] [Auto]



The following item appears only when **Uart 1 Enable** is set to **[Enabled]**.

Uart 1 Legacy Options [Auto]

Configuration options: [Disabled] [0x2E8] [0x2F8] [0x3E8] [0x3F8] [Auto]

Uart 2 Enable (no HW FC) [Auto]

Configuration options: [Disabled] [Enabled] [Auto]



The following item appears only when **Uart 2 Enable (no HW FC)** is set to **[Enabled]**.

Uart 2 Legacy Options [Auto]

Configuration options: [Disabled] [0x2E8] [0x2F8] [0x3E8] [0x3F8] [Auto]

Uart 3 Enable (no HW FC) [Auto]

Configuration options: [Disabled] [Enabled] [Auto]



The following item appears only when **Uart 3 Enable (no HW FC)** is set to **[Enabled]**.

Uart 3 Legacy Options [Auto]

Configuration options: [Disabled] [0x2E8] [0x2F8] [0x3E8] [0x3F8] [Auto]

FCH RAS Options

ALink RAS Support [Auto]

Configuration options: [Disabled] [Enabled] [Auto]

Reset after sync flood [Auto]

Enable AB to forward downstream sync-flood message to system controller.
Configuration options: [Disabled] [Enabled] [Auto]

Miscellaneous Options

Boot Timer Enable [Auto]

[Disabled] Force PMx44 bit 27 = 1.

[Enabled] Force PMx44 bit 27 = 0.

[Auto] PMx44 bit 27 = PcdBootTimerEnable.

5.11.6 NTB Common Options

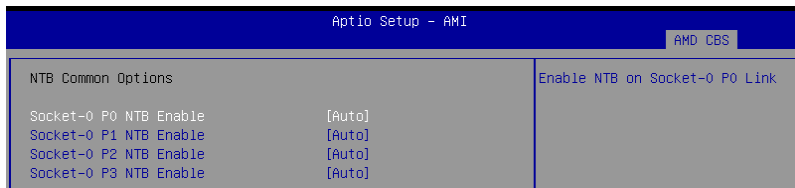

Socket-0 P0 NTB Enable [Auto]

Allows you to enable NTB on Socket-0 P0 Link.

Configuration options: [Auto] [Enable]



The following items appear only when **Socket-0 P0 NTB Enable** is set to **[Enabled]**.

Socket-0 P0 Start Lane [0]

Allows you to set the NTB Start Lane on Socket-0 P0 Link.

Configuration options: [0] - [15]

Socket-0 P0 End Lane [15]

Allows you to set the NTB End Lane on Socket-0 P0 Link.

Configuration options: [0] - [15]

Socket-0 P0 Link Speed [Auto]

Allows you to select the Link Speed for Socket-0 P0.

Configuration options: [Max Speed] [Gen 1] [Gen 2] [Gen 3] [Auto] [Gen 4]

Socket-0 P0 NTB Mode [Auto]

Allows you to select the NTB Mode for Socket-0 P0 Link.

Configuration options: [Auto] [NTB Disabled] [NTB Primary] [NTB Secondary]

Socket-0 P1 NTB Enable [Auto]

Allows you to enable NTB on Socket-0 P1 Link.

Configuration options: [Auto] [Enable]



The following items appear only when **Socket-0 P1 NTB Enable** is set to **[Enabled]**.

Socket-0 P1 Start Lane [32]

Allows you to set the NTB Start Lane on Socket-0 P1 Link.

Configuration options: [32] - [47]

Socket-0 P1 End Lane [47]

Allows you to set the NTB End Lane on Socket-0 P1 Link.
Configuration options: [32] - [47]

Socket-0 P1 Link Speed [Auto]

Allows you to select the Link Speed for Socket-0 P1.
Configuration options: [Max Speed] [Gen 1] [Gen 2] [Gen 3] [Auto] [Gen 4]

Socket-0 P1 NTB Mode [Auto]

Allows you to select the NTB Mode for Socket-0 P1 Link.
Configuration options: [Auto] [NTB Disabled] [NTB Primary] [NTB Secondary]

Socket-0 P2 NTB Enable [Auto]

Allows you to enable NTB on Socket-0 P2 Link.
Configuration options: [Auto] [Enable]



The following items appear only when **Socket-0 P2 NTB Enable** is set to **[Enabled]**.

Socket-0 P2 Start Lane [80]

Allows you to set the NTB Start Lane on Socket-0 P2 Link.
Configuration options: [80] - [95]

Socket-0 P2 End Lane [95]

Allows you to set the NTB End Lane on Socket-0 P2 Link.
Configuration options: [80] - [95]

Socket-0 P2 Link Speed [Auto]

Allows you to select the Link Speed for Socket-0 P2.
Configuration options: [Max Speed] [Gen 1] [Gen 2] [Gen 3] [Auto] [Gen 4]

Socket-0 P2 NTB Mode [Auto]

Allows you to select the NTB Mode for Socket-0 P2 Link.
Configuration options: [Auto] [NTB Disabled] [NTB Primary] [NTB Secondary]

Socket-0 P3 NTB Enable [Auto]

Allows you to enable NTB on Socket-0 P3 Link.
Configuration options: [Auto] [Enable]



The following items appear only when **Socket-0 P3 NTB Enable** is set to **[Enabled]**.

Socket-0 P3 Start Lane [112]

Allows you to set the NTB Start Lane on Socket-0 P3 Link.
Configuration options: [112] - [127]

Socket-0 P3 End Lane [127]

Allows you to set the NTB End Lane on Socket-0 P3 Link.
Configuration options: [112] - [127]

Socket-0 P3 Link Speed [Auto]

Allows you to select the Link Speed for Socket-0 P3.

Configuration options: [Max Speed] [Gen 1] [Gen 2] [Gen 3] [Auto] [Gen 4]

Socket-0 P3 NTB Mode [Auto]

Allows you to select the NTB Mode for Socket-0 P3 Link.

Configuration options: [Auto] [NTB Disabled] [NTB Primary] [NTB Secondary]

5.11.7 Soc Miscellaneous Control

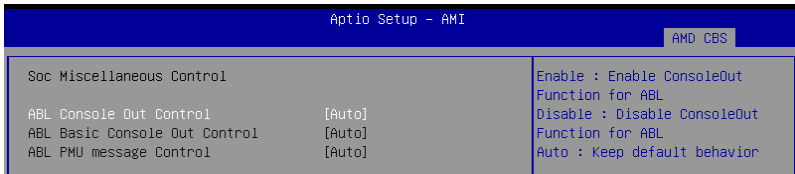

ABL Console Out Control [Auto]

[Disable] Disable ConsoleOut Function for ABL.

[Enable] Enable ConsoleOut Function for ABL.

[Auto] Keep default behavior.



The following items appear only when **ABL Console Out Control** is set to **[Enable]**.

ABL Basic Console Out Control [Auto]

[Disable] Disable Basic ConsoleOut Function for ABL.

[Enable] Enable Basic ConsoleOut Function for ABL.

[Auto] Keep default behavior.

ABL PMU message Control [Auto]

Allows you to control the total number of PMU debug messages. Several major controls are listed below:

1. Detailed debug messages (e.g. Eye delays)
2. Coarse debug messages (e.g. rank information)
3. Stage completion
4. Firmware completion message only

Configuration options: [Detailed debug message] [Coarse debug messages] [Stage completion] [Firmware completion message only] [Auto]

5.11.8 Workload Tuning

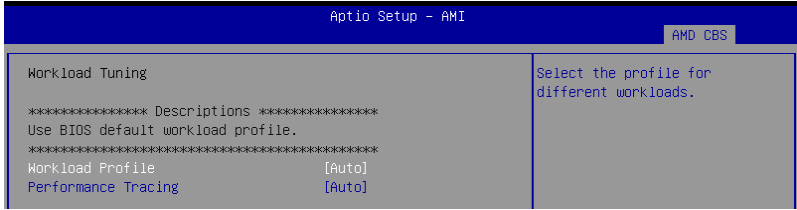

Workload Profile [Auto]

Allows you to select the profile for different workloads.

[Disabled]	Don't use any workload profile.
[CPU Intensive]	Tuned for CPU intensive workloads, providing optimal integer and floating point performance.
[Java Throughput]	Tuned for the highest level of throughput with java workloads.
[Java Latency]	Tuned for the latency sensitive java workloads, to meet critical SLA's.
[Power Efficiency]	Tuned for optimal power efficiency.
[Memory Throughput Intensive]	Tuned for the highest memory throughput available.
[Storage IO Intensive]	Tuned for the highest storage IO bandwidth.
[NIC Throughput Intensive]	Tuned for maximum TCP/IP and RDMA network throughput.
[NIC Latency Intensive]	Tuned for network performance where the kernel performs L3 packet forwarding.
[Accelerator Throughput]	Tuned to maximum peer-to-peer PCIe throughput with accelerators such as GPU's.
[VMware vSphere Optimized]	Tuned for general virt+P3+Q4.
[Linux KVM Optimized]	Tuned for general virtualization performance when using Linux KVM.
[Container Optimized]	Optimized for container performance.
[RDBMS Optimized]	Tuned for relational databases.
[Big Data Analytics Optimized]	Tuned for big data analytics.
[IOT Gateway]	Tuned for throughput analytics as observed by IOT gateways.
[HPC Optimized]	Tuned for general HPC performance.
[OpenStack NFV]	Tuned for Openstack based NFV workloads.
[OpenStack for RealTime Kernel]	Tuned for Openstack with RealTime kernel enabled.
[Auto]	Use BIOS default workload profile.

Performance Tracing [Auto]

Allows you to enable or disable allow capturing performance traces.

Configuration options: [Disabled] [Enabled] [Auto]

5.12 Event Logs menu

The Event Logs menu items allow you to change the event log settings and view the system event logs.

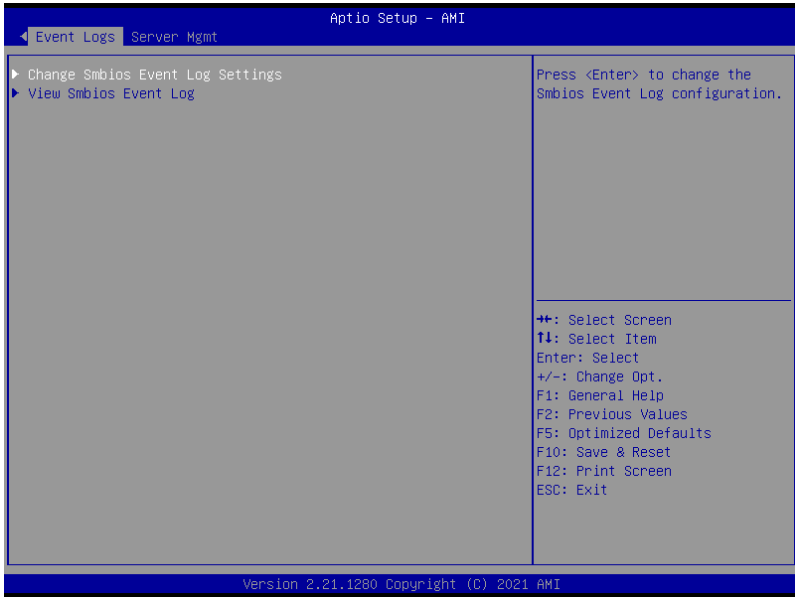

5.12.1 Change Smbios Event Log Settings

Press <Enter> to change the Smbios Event Log configuration.



All values changed here do not take effect until computer is restarted.

Enabling/Disabling Options

Smbios Event Log [Enabled]

Change this to enable or disable all features of Smbios Event Logging during boot.
Configuration options: [Disabled] [Enabled]



The following items appear only when **Smbios Event Log** is set to **[Enabled]**.

Erasing Settings

Erase Event Log [No]

Choose options for erasing Smbios Event Log. Erasing is done prior to any logging activation during reset.

Configuration options: [No] [Yes, Next reset] [Yes, Every reset]

When Log is Full [Do Nothing]

Choose options for reactions to a full Smbios Event Log.
Configuration options: [Do Nothing] [Erase Immediately]

Custom Options

Log EFI Status Code [Enabled]

This option allows you to enable or disable logging of the EFI Status Codes.
Configuration options: [Disabled] [Enabled]



The following item appears only when **Log EFI Status Code** is set to **[Enabled]**.

Convert EFI Status Codes to Standard Smbios Type [Disabled]

This option allows you to enable or disable converting of EFI Status Codes to Standard Smbios Type (Not all may be translated).
Configuration options: [Disabled] [Enabled]

5.12.2 View Smbios Event Log

Press <Enter> to view all smbios event logs.

5.13 Server Mgmt menu

The Server Management menu displays the server management status and allows you to change the settings.



OS Watchdog Timer [Disabled]

Allows you to start a BIOS timer which can only be shut off by Intel Management Software after the OS loads.

Configuration options: [Disabled] [Enabled]



The following items are configurable only when the **OS Watchdog Timer** is set to **[Enabled]**.

OS Wtd Timer Timeout [10]

Allows you to set the time in minutes for the OS Boot Watchdog Timer Expiration. Not available if OS Boot Watchdog Timer is disabled.

Configuration options: [1] - [30]

OS Wtd Timer Policy [Reset]

Allows you to configure the how the system should respond if the OS Boot Watchdog Timer expires. Not available if OS Boot Watchdog Timer is disabled.

Configuration options: [Do Nothing] [Reset] [Power Down]

System Event Log

Allows you to change the SEL event log configuration.

Erase SEL [No]

Allows you to choose options for erasing SEL.

Configuration options: [No] [Yes, On next reset] [Yes, On every reset]



All values changed here do not take effect until computer is restarted.

BMC network configuration

The sub-items in this configuration allow you to configure the BMC network parameters.

Configure IPV4 support

DM_LAN1/

Configuration Address source [Previous State]

Allows you to configure LAN channel parameters statistically or dynamically (by BIOS or BMC). [Previous State] option will not modify any BMC network parameters during BIOS phase.

Configuration options: [Previous State] [Static] [DynamicBmcDhcp]



The following items are available only when **Configuration Address source** is set to [Static].

Station IP address

Allows you to set the station IP address.

Subnet mask

Allows you to set the subnet mask. We recommend that you use the same Subnet Mask you have specified on the operating system network for the used network card.

Router IP Address

Allows you to set the router IP address.

Router MAC Address

Allows you to set the router MAC address. **Shared LAN**

Configure IPV6 support

DM_LAN1

IPV6 Support [Enabled]

Allows you to enable or disable LAN1 IPV6 Support.

Configuration options: [Disabled] [Enabled]



The following item appears only when **IPv6 Support** is set to **[Enabled]**.

Configuration Address source [Previous State]

Allows you to configure LAN channel parameters statistically or dynamically (by BIOS or BMC). **[Previous State]** option will not modify any BMC network parameters during BIOS phase.

Configuration options: [Previous State] [Static] [DynamicBmcDhcp]



The following items are available only when **Configuration Address source** is set to **[Static]**.

Station IPv6 address

Allows you to set the station IPv6 address.

Prefix Length

Allows you to set the prefix length (maximum of Prefix Length is 128).

Configuration Router Lan1 Address source [Previous State]

Select to configure LAN channel parameters statically or dynamically (by BIOS or by BMC). Unspecified option will not modify any BMC network parameters during BIOS phase.



The following items are available only when **Configuration Router Lan1 Address source** is set to **[Static]**.

IPv6 Router1 IP address

Allows you to change the IPv6 Router1 IP Address.

IPv6 Router1 Prefix Length Lan1

Allows you to change the IPv6 Router Prefix Length.

IPv6 Router1 Prefix Value Lan1

Allows you to change the IPv6 Router Prefix Value.

Shared LAN

IPv6 Support [Enabled]

Allows you to enable or disable LAN1 IPv6 Support.

Configuration options: [Disabled] [Enabled]



The following item appears only when **IPv6 Support** is set to **[Enabled]**.

Configuration Address source [Previous State]

Allows you to configure LAN channel parameters statistically or dynamically (by BIOS or BMC). **[Previous State]** option will not modify any BMC network parameters during BIOS phase.

Configuration options: [Previous State] [Static] [DynamicBmcDhcp]

Station IPv6 address

Allows you to set the station IPv6 address.

Prefix Length

Allows you to set the prefix length (maximum of Prefix Length is 128).

Configuration Router Lan2 Address source [Previous State]

Select to configure LAN channel parameters statically or dynamically (by BIOS or by BMC). Unspecified option will not modify any BMC network parameters during BIOS phase.



The following items are available only when **Configuration Router Lan2 Address source** is set to **[Static]**.

IPv6 Router1 IP address

Allows you to change the IPv6 Router1 IP Address.

IPv6 Router1 Prefix Length Lan2

Allows you to change the IPv6 Router Prefix Length.

IPv6 Router1 Prefix Value Lan2

Allows you to change the IPv6 Router Prefix Value.

View System Event Log

Allows you to view the system event log records.

Driver Installation

6

This chapter provides instructions for installing the necessary drivers for different system components.

6.1 Running the Support DVD

The support DVD that is bundled with your motherboard contains drivers, management applications, and utilities that you can install to maximize the features of your motherboard.



- The contents of the support DVD are subject to change at any time without notice. Visit the ASUS website (www.asus.com) for the latest updates on software and utilities.
- The support DVD is supported on Windows® Server 2016 and Windows® Server 2019.

The main screen of the Support DVD contains the following tabs:

1. Drivers - Shows the available device drivers that the system detects.
2. Utilities - Displays the software applications and utilities that the motherboard supports.
3. Manual - Provides the link to the user guide(s).



You need an internet browser installed in your OS to view the User Guide.

4. Contact - Displays the ASUS contact information, e-mail addresses, and useful links if you need more information or technical support for your motherboard.

Appendix

This appendix includes additional information that you may refer to when configuring the motherboard.

KMPA-U16 block diagram

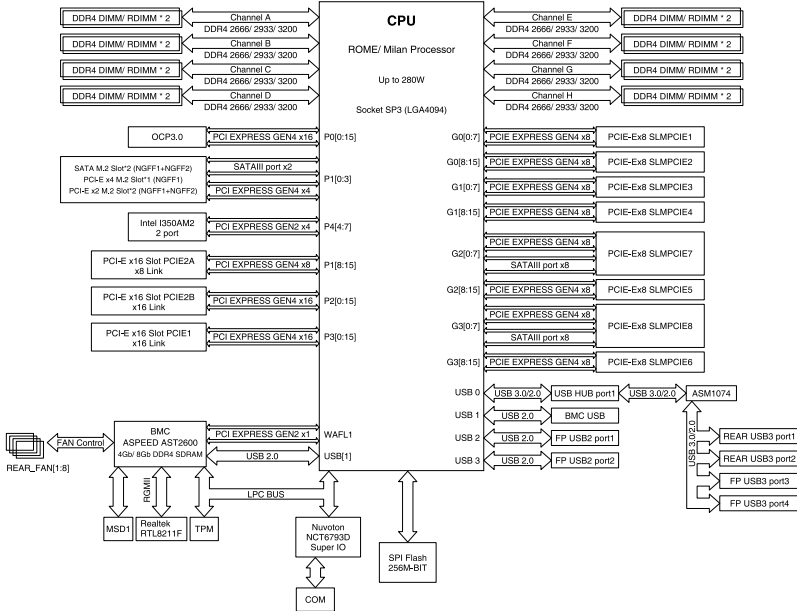

Notices

Federal Communications Commission Statement

This device complies with Part 15 of the FCC Rules. Operation is subject to the following two conditions:

- This device may not cause harmful interference.
- This device must accept any interference received including interference that may cause undesired operation.

This equipment has been tested and found to comply with the limits for a Class A digital device, pursuant to part 15 of the FCC Rules. These limits are designed to provide reasonable protection against harmful interference when the equipment is operated in a commercial environment. This equipment generates, uses, and can radiate radio frequency energy and, if not installed and used in accordance with the instruction manual, may cause harmful interference to radio communications. Operation of this equipment in a residential area is likely to cause harmful interference in which case the user will be required to correct the interference at his own expense.



The use of shielded cables for connection of the monitor to the graphics card is required to assure compliance with FCC regulations. Changes or modifications to this unit not expressly approved by the party responsible for compliance could void the user's authority to operate this equipment.

Compliance Statement of Innovation, Science and Economic Development Canada (ISED)

This device complies with Innovation, Science and Economic Development Canada licence exempt RSS standard(s). Operation is subject to the following two conditions: (1) this device may not cause interference, and (2) this device must accept any interference, including interference that may cause undesired operation of the device.

CAN ICES-003(A)/NMB-003(A)

Déclaration de conformité de Innovation, Sciences et Développement économique Canada (ISED)

Le présent appareil est conforme aux CNR d'Innovation, Sciences et Développement économique Canada applicables aux appareils radio exempts de licence. L'exploitation est autorisée aux deux conditions suivantes : (1) l'appareil ne doit pas produire de brouillage, et (2) l'utilisateur de l'appareil doit accepter tout brouillage radioélectrique subi, même si le brouillage est susceptible d'en compromettre le fonctionnement.

CAN ICES-003(A)/NMB-003(A)

Japan JATE

本製品は電気通信事業者（移動通信会社、固定通信会社、インターネットプロバイダ等）の通信回線（公衆無線LANを含む）に直接接続することができません。本製品をインターネットに接続する場合は、必ずルータ等を経由し接続してください。

Australia statement notice

From 1 January 2012 updated warranties apply to all ASUS products, consistent with the Australian Consumer Law. For the latest product warranty details please visit <https://www.asus.com/support/>. Our goods come with guarantees that cannot be excluded under the Australian Consumer Law. You are entitled to a replacement or refund for a major failure and compensation for any other reasonably foreseeable loss or damage. You are also entitled to have the goods repaired or replaced if the goods fail to be of acceptable quality and the failure does not amount to a major failure.

If you require assistance please call ASUS Customer Service 1300 2787 88 or visit us at <https://www.asus.com/support/>.



DO NOT throw the motherboard in municipal waste. This product has been designed to enable proper reuse of parts and recycling. This symbol of the crossed out wheeled bin indicates that the product (electrical and electronic equipment) should not be placed in municipal waste. Check local regulations for disposal of electronic products.



DO NOT throw the mercury-containing button cell battery in municipal waste. This symbol of the crossed out wheeled bin indicates that the battery should not be placed in municipal waste.

Japan statement notice

This product cannot be directly connected to the Internet (including public wireless LAN) of a telecom carrier (mobile network companies, landline network companies, Internet providers, etc.). When connecting this product to the Internet, be sure to connect it through a router or switch.

Declaration of compliance for product environmental regulation

ASUS follows the green design concept to design and manufacture our products, and makes sure that each stage of the product life cycle of ASUS product is in line with global environmental regulations. In addition, ASUS disclose the relevant information based on regulation requirements.

Please refer to <http://csr.asus.com/Compliance.htm> for information disclosure based on regulation requirements ASUS is complied with:

EU REACH and Article 33

Complying with the REACH (Registration, Evaluation, Authorization, and Restriction of Chemicals) regulatory framework, we publish the chemical substances in our products at ASUS REACH website at <http://csr.asus.com/english/REACH.htm>.

EU RoHS

This product complies with the EU RoHS Directive. For more details, see <http://csr.asus.com/english/article.aspx?id=35>

Japan JIS-C-0950 Material Declarations

Information on Japan RoHS (JIS-C-0950) chemical disclosures is available on <http://csr.asus.com/english/article.aspx?id=19>

India RoHS

This product complies with the “India E-Waste (Management) Rules, 2016” and prohibits use of lead, mercury, hexavalent chromium, polybrominated biphenyls (PBBs) and polybrominated diphenyl ethers (PBDEs) in concentrations exceeding 0.1% by weight in homogenous materials and 0.01% by weight in homogenous materials for cadmium, except for the exemptions listed in Schedule II of the Rule.

Vietnam RoHS

ASUS products sold in Vietnam, on or after September 23, 2011, meet the requirements of the Vietnam Circular 30/2011/TT-BCT.

Các sản phẩm ASUS bán tại Việt Nam, vào ngày 23 tháng 9 năm 2011 trở về sau, đều phải đáp ứng các yêu cầu của Thông tư 30/2011/TT-BCT của Việt Nam.

Turkey RoHS

AEEE Yönetmeliğine Uygundur

ASUS Recycling/Takeback Services

ASUS recycling and takeback programs come from our commitment to the highest standards for protecting our environment. We believe in providing solutions for you to be able to responsibly recycle our products, batteries, other components as well as the packaging materials. Please go to <http://csr.asus.com/english/Takeback.htm> for detailed recycling information in different regions.

Ecodesign Directive

European Union announced a framework for the setting of ecodesign requirements for energy-related products (2009/125/EC). Specific Implementing Measures are aimed at improving environmental performance of specific products or across multiple product types. ASUS provides product information on the CSR website. The further information could be found at <https://csr.asus.com/english/article.aspx?id=1555>.

UK: The Radio Equipment Regulations 2017 (S.I. 2017/1206)

ASUSTeK Computer Inc. hereby declares that this device is in compliance with the essential requirements and other relevant provisions of related Regulations. Full text of UKCA declaration of conformity is available at: www.asus.com/support

EU: Radio Equipment Directive (Directive 2014/53/EU)

English ASUSTeK Computer Inc. hereby declares that this device is in compliance with the essential requirements and other relevant provisions of related Directives. Full text of EU declaration of conformity is available at: www.asus.com/support

Français AsusTek Computer Inc. déclare par la présente que cet appareil est conforme aux critères essentiels et autres clauses pertinentes des directives concernées. La déclaration de conformité de l'UE peut être téléchargée à partir du site Internet suivant : www.asus.com/support

Deutsch ASUSTeK Computer Inc. erklärt hiermit, dass dieses Gerät mit den wesentlichen Anforderungen und anderen relevanten Bestimmungen der zugehörigen Richtlinien übereinstimmt. Der gesamte Text der EU-Konformitätserklärung ist verfügbar unter: www.asus.com/support

Italiano ASUSTeK Computer Inc. con la presente dichiara che questo dispositivo è conforme ai requisiti essenziali e alle altre disposizioni pertinenti con le direttive correlate. Il testo completo della dichiarazione di conformità UE è disponibile all'indirizzo: www.asus.com/support

Русский Компания ASUS заявляет, что это устройство соответствует основным требованиям и другим соответствующим условиям соответствующих директив. Подробную информацию, пожалуйста, смотрите на www.asus.com/support

Български С настоящото ASUSTeK Computer Inc. декларира, че това устройство е в съответствие със съществените изисквания и другите приложими постановления на свързаните директиви. Пълният текст на декларацията за съответствие на ЕС е достъпна на адрес: www.asus.com/support

Hrvatski ASUSTeK Computer Inc. ovim izjavljuje da je ovaj uređaj sukladan s bitnim zahtjevima i ostalim odgovarajućim odredbama vezanih direktiva. Cijeli tekst EU izjave o sukladnosti dostupan je na: www.asus.com/support

Čeština Společnost ASUSTeK Computer Inc. tímto prohlašuje, že toto zařízení splňuje základní požadavky a další příslušná ustanovení souvisejících směrnic. Plné znění prohlášení o shodě EU je k dispozici na adrese: www.asus.com/support

Dansk ASUSTeK Computer Inc. erklærer hermed, at denne enhed er i overensstemmelse med hovedkravene og andre relevante bestemmelser i de relaterede direktiver. Hele EU-overensstemmelseserklæringen kan findes på: www.asus.com/support

Nederlands ASUSTeK Computer Inc. verklaart hierbij dat dit apparaat voldoet aan de essentiële vereisten en andere relevante bepalingen van de verwante richtlijnen. De volledige tekst van de EU-verklaring van conformiteit is beschikbaar op: www.asus.com/support

Eesti Käesolevaga kinnitab ASUSTeK Computer Inc, et see seade vastab asjakohaste direktiivide oluliste nõuetele ja teistele asjaspepuutuvatele sätetele. EL vastavusdeklaratsiooni täielik tekst on saadaval järgmisel aadressil: www.asus.com/support

Suomi ASUSTeK Computer Inc. ilmoittaa täten, että tämä laite on asiaankuuluvien direktiivien olennaisten vaatimusten ja muiden tätä koskevien säädösten mukainen. EU-yhdenmukaisuusilmoituksen koko teksti on luettavissa osoitteessa: www.asus.com/support

Ελληνικά Με το παρόν, η AsusTek Computer Inc. δηλώνει ότι αυτή η συσκευή συμμορφώνεται με τις θεμελιώδεις απαιτήσεις και άλλες σχετικές διατάξεις των Οδηγιών της ΕΕ. Το πλήρες κείμενο της δήλωσης συμβατότητας είναι διαθέσιμο στη διεύθυνση: www.asus.com/support

Magyar Az ASUSTeK Computer Inc. ezennel kijelenti, hogy ez az eszköz megfelel a kapcsolódó Irányelvек lényeges követelményeinek és egyéb vonatkozó rendelkezéseinek. Az EU megfeleléségi nyilatkozat teljes szövege innen letölthető: www.asus.com/support

Latviski ASUSTeK Computer Inc. ar šo paziņo, ka šī ierīce atbilst saistīto Direktīvu būtiskajām prasībām un citiem citiem saistošajiem nosacījumiem. Pilns ES atbilstības paziņojuma teksts pieejams šeit: www.asus.com/support

Lietuviai „ASUSTeK Computer Inc.“ šiuo tvirtina, kad šis įrenginys atitinka pagrindinius reikalavimus ir kitas svarbias susijusių direktyvų nuostatas. Visą ES atitikties deklaracijos tekstą galima rasti: www.asus.com/support

Norsk ASUSTeK Computer Inc. erklærer herved at denne enheten er i samsvar med hovedsaklige krav og andre relevante forskrifter i relaterte direktiver. Fullstendig tekst for EU-samsvarserklæringen finnes på: www.asus.com/support

Polski Firma ASUSTeK Computer Inc. niniejszym oświadcza, że urządzenie to jest zgodne z zasadniczymi wymogami i innymi właściwymi postanowieniami powiązanych dyrektyw. Pełny tekst deklaracji zgodności UE jest dostępny pod adresem: www.asus.com/support

Português A ASUSTeK Computer Inc. declara que este dispositivo está em conformidade com os requisitos essenciais e outras disposições relevantes das Diretivas relacionadas. Texto integral da declaração da UE disponível em: www.asus.com/support

Română ASUSTeK Computer Inc. declară că acest dispozitiv se conformează cerințelor esențiale și altor prevederi relevante ale directivelor conexe. Textul complet al declarației de conformitate a Uniunii Europene se găsește la: www.asus.com/support

Srpski ASUSTeK Computer Inc. ovim izjavljuje da je ovaj uređaj u saglasnosti sa osnovnim zahtevima i drugim relevantnim odredbama povezanih Direktiva. Pun tekst EU deklaracije o usaglašenosti je dostupan da adresi: www.asus.com/support

Slovensky Spoločnosť ASUSTeK Computer Inc. týmto vyhlasuje, že toto zariadenie vyhovuje základným požiadavkám a ostatým príslušným ustanoveniam príslušných smerníc. Celý text vyhlásenia o zhode pre štáty EÚ je dostupný na adrese: www.asus.com/support

Slovenščina ASUSTeK Computer Inc. izjavlja, da je ta naprava skladna z bistvenimi zahtevami in drugimi ustreznimi določbami povezanih direktiv. Celotno besedilo EU-izjave o skladnosti je na voljo na spletnem mestu: www.asus.com/support

Español Por la presente, ASUSTeK Computer Inc. declara que este dispositivo cumple los requisitos básicos y otras disposiciones pertinentes de las directivas relacionadas. El texto completo de la declaración de la UE de conformidad está disponible en: www.asus.com/support

Svenska ASUSTeK Computer Inc. förklarar härmed att denna enhet överensstämmer med de grundläggande kraven och andra relevanta föreskrifter i relaterade direktiv. Fulltext av EU-försäkran om överensstämmelse finns på: www.asus.com/support

Українська ASUSTeK Computer Inc. заявляє, що цей пристрій відповідає основним вимогам та іншим відповідним положенням відповідних Директив. Повний текст декларації відповідності стандартам ЄС доступний на: www.asus.com/support

Türkçe AsusTek Computer Inc., bu aygıtın temel gereksinimlerle ve ilişkili Yönergelerin diğer ilgili koşullarıyla uyumlu olduğunu beyan eder. AB uyumluluk bildiriminin tam metni şu adreste bulunabilir: www.asus.com/support

Bosanski ASUSTeK Computer Inc. ovim izjavljuje da je ovaj uređaj usklađen sa bitnim zahtjevima i ostalim odgovarajućim odredbama vezanih direktiva. Cijeli tekst EU izjave o usklađenosti dostupan je na: www.asus.com/support

Service and Support

Visit our multi-language website at <https://www.asus.com/support>.



