



HP Engage One Serial USB Thermal Printer

User Guide

Supports the following model:

H300-E8SD-HPN0

© Copyright 2018 HP Development Company,
L.P.

Windows is either a registered trademark or
trademark of Microsoft Corporation in the
United States and/or other countries.

The information contained herein is subject to
change without notice. The only warranties for
HP products and services are set forth in the
express warranty statements accompanying
such products and services. Nothing herein
should be construed as constituting an
additional warranty. HP shall not be liable for
technical or editorial errors or omissions
contained herein.

Second Edition: July 2018

First Edition: July 2017

Document Part Number: 937442-002

About This Guide

This guide provides information on setting up and using the printer.





-  **WARNING!** Indicates a hazardous situation that, if not avoided, **could** result in death or serious injury.
 -  **CAUTION:** Indicates a hazardous situation that, if not avoided, **could** result in minor or moderate injury.
 -  **IMPORTANT:** Indicates information considered important but not hazard-related (for example, messages related to property damage). An Important alert warns the user that failure to follow a procedure exactly as described could result in loss of data or in damage to hardware or software. Also contains essential information to explain a concept or to complete a task.
 -  **NOTE:** Contains additional information to emphasize or supplement important points of the main text.
 -  **TIP:** Provides helpful hints for completing a task.
-

Table of contents

1 Product features	1
Standard features	1
Printer components	2
Rear connectors	3
2 Setting up the printer	4
Checking the packing list	4
Connecting the cables	4
Turning on the printer	5
Installing the driver	5
Best practices for opening the HP Engage One Serial USB Thermal Printer	6
Loading or changing the receipt paper	8
Testing the printer	9
3 Operating the printer	10
Configuring the printer	10
Entering the configuration mode	10
Monochrome paper print density	12
When to change the receipt paper	13
Maximum power setting	13
Printhead setting	13
Preventing printhead overheating	13
4 Maintenance guidelines	15
Cleaning the printer	15
Cleaning the thermal printhead	15
Appendix A Troubleshooting	16
Diagnostics	16
Startup diagnostics	16
Runtime diagnostics	16
Remote diagnostics	17
Solving common problems	18
Latch failsafe	19
Contacting support	19
Preparing to call technical support	20

Ordering paper rolls 20

Appendix B Technical specifications 21

HP Engage One Serial USB Thermal Printer 21

Characters appearance 22

 Print size 22

Ordering thermal paper 23

Qualified paper grades 23

 Monochrome (black ink) paper 23

Print zones for 80 mm paper 25

1 Product features

Standard features



The HP Engage One Serial USB Thermal Printer is designed to work with point of sale system hardware and program applications.

Features	
Interface	USB/RS232
Memory/firmware	8 MB flash memory, History EEROM, 4k buffer
Resident character sets	PC code pages 437 (US), 720 (Arabic), 737 (Greek), 775 (Baltic), 850 (Multilingual), 852 (Latin II), 857 (Turkish), 858 (with Eurosymbol), 860 (Portuguese), 862 (Hebrew), 863 (French Canadian), 864 (Arabic), 865 (Nordic), 866 (Cyrillic), 874 (Thai), 1250 (Windows Central Europe), 1251 (Windows Cyrillic), 1252 (Windows Latin I), 1254 (Windows Turkish), 1255 (Windows Hebrew), 1256 (Windows Arabic), 1257 (Windows Baltic), 28591 (Windows Latin 1), 28592 (Windows Latin 2), 28594 (Windows Baltic), 28596 (Windows Arabic), 28599 (Windows Turkish), 28605 (Windows Latin 9), Katakana, and KZ_1048 (Kazakh)
Downloadable fonts	Code pages 932 (Kanji), 949 (Korean), 936 (Simplified Chinese), and 950 (Traditional Chinese)
Integrated bar codes	Code 39, Code 93, Code 128, UPC-A, UPC-E, JAN8 (EAN), JAN13 (EAN), Interleaved 2 of 5, Codabar, Code 128, PDF-417 (two-dimensional), Code 128 extended, GS1 Databar, QR code, and Datamatrix
Print	Monochrome in either 44 (standard) or 56 (compressed) columns on 80 mm wide thermal paper
Paper path	80.0 mm
Print resolution	8-dots/mm
Speed	Up to 114 mm/second throughput (monochrome)
Paper sensing	Paper out
Human interface	Audible tone from speaker (software-driven), simple commands in configuration menu issued through paper feed button, green LED status light located next to the paper feed button
Cash drawer driver	Connector for one or two cash drawers (obtain a "Y" cord for two drawers)
Knife	Paper cutter standard on all units

 **NOTE:** For safety and regulatory information, refer to the *Product Notices* included with your product. To locate updates to the user guide for your product, go to <http://www.hp.com/support> to download the latest versions of HP programs and drivers. In addition, register to receive automatic notifications when updates become available.

Printer components

To install, use and maintain the receipt printer, snap open the receipt cover and drop the paper roll in place. You never need to change a printer ribbon or cartridge because it uses thermal print technology.

 **IMPORTANT:** To avoid damaging the receipt cover, do not open the cover more than 80 degrees.

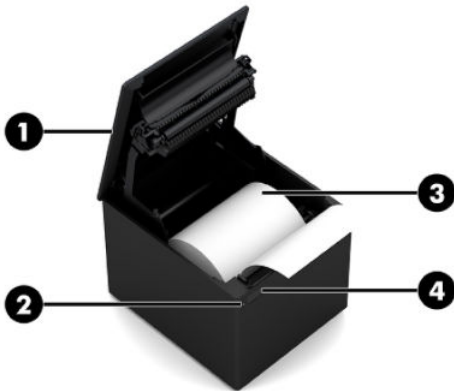

Component	Description
(1) Receipt cover	Snaps open so that you can easily drop the paper roll in place.
(2) Status LED	<ul style="list-style-type: none">On: The printer is on and operating normally.Blinking: The printer needs operator assistance. It is most likely caused by the cover not being fully shut.
(3) Receipt paper	Prints receipts using thermal print technology.
(4) Paper feed button	During normal use, the button advances the paper. It is also used to access the configuration menu. If the energy-saving feature is enabled and the printer has entered the energy-saving mode, pressing the paper feed button exits energy-saving mode and re-enables printing.

 **NOTE:** A single beep indicates the printer has successfully completed its startup routine. It should beep after being powered up or reset. If the printer beeps twice, it may be experiencing a problem. See [Troubleshooting on page 16](#) in this guide for more information.

Rear connectors

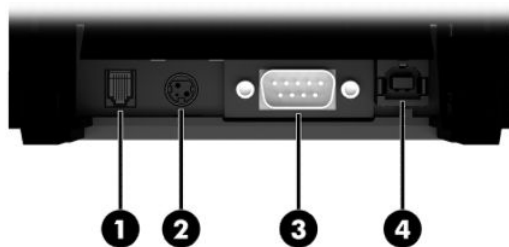

Component	Description
(1) Cash drawer port	Connects the printer to the cash drawer.
(2) Power connector	Connects the printer to a power adapter or a 24 V powered USB port for power.
(3) Serial port	Connects the printer to the POS computer.
(4) USB port	Connects the printer to the POS computer.

NOTE: Only one communication cable (USB or serial) should be connected at one time.

2 Setting up the printer

Checking the packing list

Save the packing materials in case you need to repack the printer for shipping or storage. Before installation, check that all the items listed below have been shipped.

- Printer
 - Starter roll of receipt paper
 - Test printout
 - Power cord (or AC adapter), serial cable or USB cable
- Or
- 24 V PUSB Y cable
- Or
- 24 V PUSB power only with serial cable

Connecting the cables

Before setting up the receipt printer, be sure that power is turned off to the printer, POS computer, and other attached devices.



NOTE: Place the printer on a level surface and position it in a location that allows access to cables and adequate room to open the cover. Locate the printer away from traffic areas to limit the chance of being bumped or damaged.



IMPORTANT: Connect cables to the printer before turning on power to the POS computer. The POS computer should always be turned off before connecting the communication cable.



WARNING! Using this device without a grounded outlet is a safety hazard and voids the printer Warranty, Safety, FCC and CE Mark designation.

1. Turn off the POS computer.
2. Plug the serial cable into the serial port (3) on the printer or plug the USB cable into the USB port (4) on the printer. Plug the other end of the serial or USB cable into the appropriate port on the POS computer.



NOTE: You can use either the USB cable or the serial cable as the data interface with the POS computer. *Do not use both.*

If using the serial interface, a 9-pin female to 9-pin female null modem serial cable must be used between the printer and POS computer. Make sure to tighten the screws to secure the cable and ensure a stable connection.

3. Connect one end of the power cord to the power connector (2) on the printer. Plug the other end of the power cord to an AC adapter or a 24 V powered USB port on the POS computer.

4. Connect one end of the cash drawer cable (purchased separately) to the cash drawer RJ-12 port (1) on the printer and the other end of the cable to the RJ-45 port on the cash drawer.



NOTE: The cash drawer cable connects the printer to one or two cash drawers. If installing two cash drawers, you will need to obtain a Y-cable for the cash drawers.

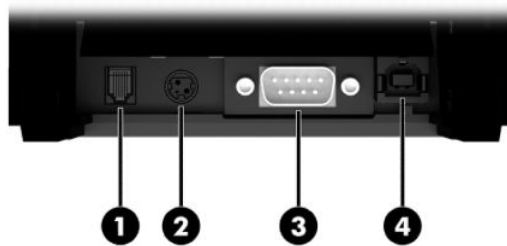

Turning on the printer

After connecting the cables to the printer and POS computer, turn on the POS computer. If the **Found New Hardware Wizard** dialog box appears, select **Cancel**.

The receipt printer will beep and the green LED will light up initializing the printer.

Installing the driver

Go to <http://www.hp.com> to download and install the driver. Select and install the OPOS driver or the JPOS driver for your POS computer's operating system.

Best practices for opening the HP Engage One Serial USB Thermal Printer

To open the receipt cover, position the printer facing forward with the paper feed button toward you. Place your fingers at the front corners (1) and lift up (2).

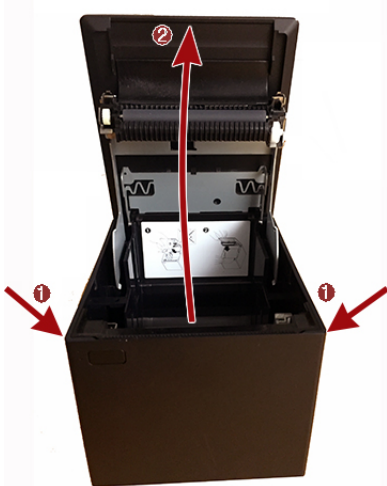

The receipt cover is designed to open a maximum of 80 degrees as shown in the image below.

CAUTION: To avoid damaging the top cover, do not use excessive force, and do not open the cover more than 80 degrees. You cannot open the cover from the rear.



TIP: The button on the front of the printer (indicated by the red arrow in the image below) is the paper feed button. It is not a cover release button.



Do not force the latch if it becomes jammed and you are unable to open the cover. If this event occurs, hold the printer upside down, locate the latch release lever and pull it toward the side of the chassis to release the latch. This will open the top cover.

 **NOTE:** If the only way to open the cover is with the release lever, replace the printer.



Loading or changing the receipt paper

 **IMPORTANT:** You must use qualified paper rolls with the HP printers. See [Qualified paper grades on page 23](#). Using unqualified paper may void the warranty.

Follow the procedure below to load the paper during installation. You will later use the same procedure to change the receipt paper. The minor difference is noted in the directions below.

1. Open the receipt cover by pushing up evenly on each side of the cover until it unsnaps, and then rotate the cover up (1).

 **IMPORTANT:** To avoid damaging the receipt cover, do not open the cover more than 80 degrees.

2. **Loading:** Remove the test printout (2). Retain the test printout with configuration listing until the printer is successfully installed.

Changing: Remove the used paper roll.

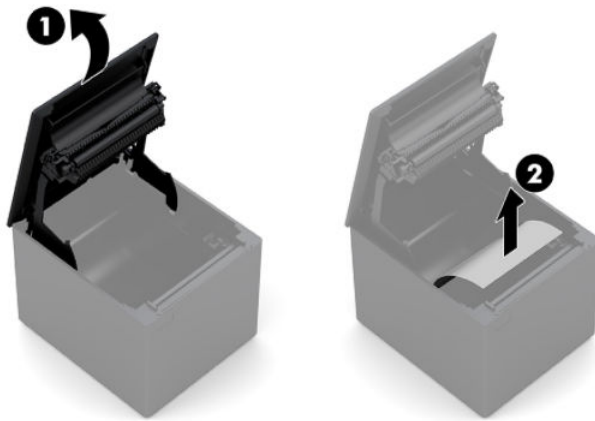

3. Tear a clean edge on the new receipt paper roll, making sure the tape has been completely removed.
4. Place the receipt paper into the paper compartment so it **unrolls from the bottom** (1). Leave a few inches of paper sticking out of the printer.
5. While holding the paper in place, close the receipt cover (2). To test that the paper is loaded correctly, advance the paper with the paper feed button.

 **NOTE:** If the paper jams, be sure that the roll is inserted correctly.

6. Tear the excess paper off against the blade in the cover (3).

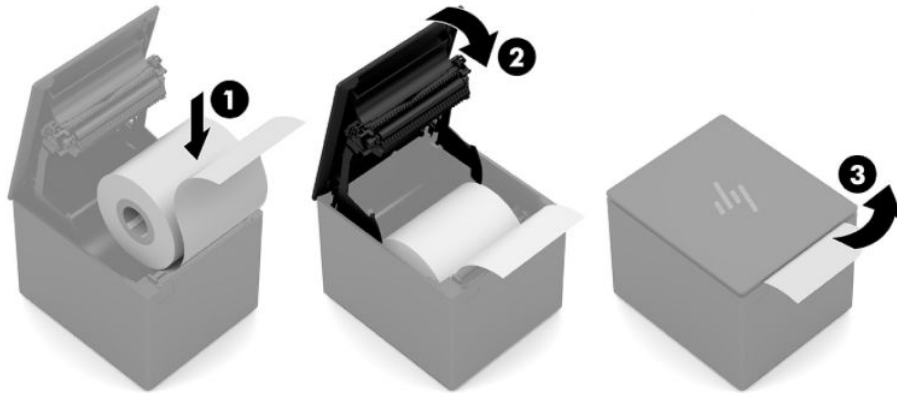

Testing the printer

If the printer is functioning normally, it will beep once. If it responds differently, see [Troubleshooting on page 16](#), or contact your regional HP authorized service provider for HP Point of Sale System products.

The printer arrives for installation pre-configured. The printer's current configuration appears on the test (diagnostics) printout. However, if you would like to run a new print test or check the configurations, you can run a diagnostics printout detailing the current configuration.

To run a diagnostics test:

1. Be sure paper is in the printer (1).
2. Open the receipt cover (2).
3. Press and hold the paper feed button (3).
4. Close the receipt cover (4), continually holding the paper feed button until the configuration printout begins.

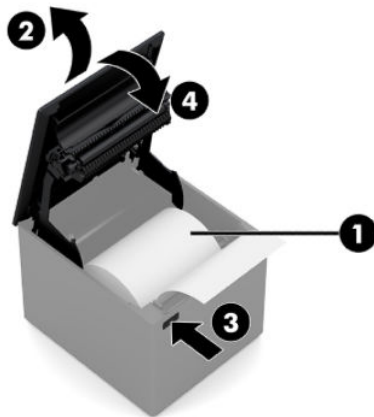

For additional instructions on configuring the printer, see [Operating the printer on page 10](#).

3 Operating the printer

Configuring the printer

The configuration menu allows you to set general printer parameters. The test prints the diagnostics form, which details settings for all functions. The printer will partially cut the paper between each variation.

The test ends with a partial cut of the paper. A complete test printout may require the use of several feet of paper.

Since the printer is usually shipped pre-configured, you should not need to change the configuration of the printer. If you make adjustments to the configuration, be careful not to inadvertently change settings that may affect the printer's performance. HP does not recommend that you change the printer configuration.



NOTE: The printer is shipped with a test printout that includes the preset configuration. If you run into problems after changing the printer configuration, use the settings as a default.

Entering the configuration mode

1. Turn off power to the printer.
2. Be sure the receipt paper (1) is loaded in the printer before proceeding (for instructions on loading the receipt paper, see [Setting up the printer on page 4](#)).
3. Close the receipt cover (2).
4. Turn on power to the printer and immediately press and hold the paper feed button (3) until the configuration printout begins.
 - The printer beeps, then prints Diagnostics Form I.
 - Press the paper feed button within two seconds after the diagnostics form has finished printing to enter the configuration main menu.
 - The printer prints Diagnostics Form II, followed by the Printer Configuration Menu, and waits for a main menu selection to be made (see the sample printout; short clicks are used, except when answering **Yes** or validating selection).

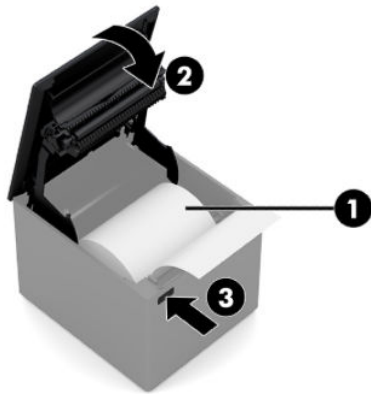

5. To communicate with the printer, press the paper feed button using either short or long clicks. Use a long click for **Yes** (more than one second) and a short click for **No**. Follow the printed instructions to make selections.
6. Continue through your menu selections until you are prompted with **Save New Parameters?**. Select **Yes**.
 - a. Reset the printer.
 - b. Open the receipt cover.
 - c. Press and hold the paper feed button while closing the receipt cover.
 - d. The diagnostic printout verifies your new settings.

The following is a sample printer configuration menu. Samples will vary depending on the printer model.

```

*** H300 - Diagnostics Form ***

Model number       : H300-E8SD-HPN0
Serial number      : 0000000000

Loader Firmware
P/N                : PN#: 189-30SL116
Date               : Sep 16 2016

Flash Firmware
Revision           : V1.54
CRC                : 0DCF
P/N                : 189-30SA154A

H/W parameters
Flash Memory Size  : 8 Mbytes
Flash Logos/Fonts  : 1600 kbytes
Flash User Storage : 576 kbytes
Flash Perm'nt Fonts : 2240 kbytes
Flash Journal Size : 640 kbytes
SRAM Size          : 512 kbytes
Head settting     : N
Motor ID           : 1
Paper Type Setting : Type 0, Monochrome
Color Density Adj  : n/a
Print Density, Mono : 100%
Max Speed          : 114 mm/sec
Paper Width        : 80 mm
Max Power          : 48w
Knife              : Enabled
Partial Cut        : 135 steps
Paper Low Sensor   : Disabled
No Paper Low Extension

Comm. Interface
Interface          : USB
RX Buffer Size     : 4096
USB Driver Type    : Printer Class
Interface          : RS232
RX Buffer Size     : 4096
Parameters
Baud Rate         : 115200
Data Bits         : 8
Stop Bit          : 1
Parity            : NONE
Flow Control      : DTR/DSR
Reception Errors  : Ignore

Resident Code Pages : 437, 720, 737, 775, 850
                    : 852, 857, 858, 860, 862...

```

```

***** MAIN MENU *****
*****

Select a sub-menu :
- EXIT                -> 1 click
- Print Current Configuration -> 2 clicks
- Set Communication Interface -> 3 clicks
- Set Diagnostics Modes    -> 4 clicks
- Set Emulation/Software Options -> 5 clicks
- Set Hardware Options     -> 6 clicks
- Set Paper Type           -> 7 clicks
- Set Firmware Features    -> 8 clicks

Enter code, then hold Button DOWN
at least 1 second to validate

```

```

***To Enter Printer Config Menu***
Press Feed Button Within the
Next Two Seconds

```

Print test and Configuration menu samples are shown above (shown approximately 60% of size).

Short clicks are used in the main menu selections.

Monochrome paper print density

This function makes it possible to adjust the energy level of the printhead to darken the printout or adjust for paper variations. An adjustment should only be made when necessary. The default setting is 100%.

 **IMPORTANT:** Choose an energy level no higher than necessary to achieve a dark printout. Failure to observe this rule may result in a printer service call or voiding of the printer warranty. Running at a higher energy level will reduce the printhead life.

When the printer prints high-density print lines (text or graphics), it automatically slows down.

To change the print density:

1. Enter the configuration menu. See [Entering the configuration mode on page 10](#).
2. Select **Set Hardware Options** from the main menu.
The printer responds, **Hardware Options Menu**.
3. When scrolled, the printer prompts, **Set Print Density?**. Select **Yes**.
A warning is printed, followed by the density adjustment selections.
Using the paper feed button, enter clicks for the selection, and then hold the button down at least 1 second to validate.

When to change the receipt paper

Change the paper when it is near the end of the roll or out. When the paper is low, you should monitor usage to avoid running out partway through a transaction. When the paper is out, you must load a new roll immediately or data may be lost.

When paper is low:

A colored stripe appears on the receipt paper (if paper is purchased with a stripe) and indicates enough paper remains for a small transaction.

When paper is out:

The green LED flashes quickly indicating the paper must be installed.



IMPORTANT: Do not try to operate the printer or POS computer if the printer runs out of paper. The printer may continue to accept data from the POS computer even though it is unable to print. Data may be lost as a result.

For instructions on how to change the receipt paper, see [Loading or changing the receipt paper on page 8](#).

Maximum power setting

The printer supports two power level settings, default and Level 1. The power level setting can be selected in the **Hardware Options** section of the configuration menu (see [Entering the configuration mode on page 10](#)):

- Default (48 W)
- Level I (55 W)

Printhead setting

The printhead energy rating and printer setting must match. The setting is preconfigured but may require changing if service to the thermal mechanism is required. The **Head Setting** on the diagnostic printout must match the letter marked on the front right of the thermal mechanism. Whenever the thermal mechanism is replaced, if the letter on the mechanism is different from the head setting, you must enter the configuration menu and set the printhead to match.

Preventing printhead overheating

There are restrictions on the duty cycle because of the heat generated by the thermal printhead when printing solid blocks (regardless of the length of the block in relation to the print line). The restrictions are ambient temperature, the percentage of time (measured against one minute) of continuous solid printing, and the amount of coverage.

The ambient temperature may be affected by factors such as direct exposure to sun or close proximity to heating elements.



IMPORTANT: When the duty cycle exceeds the limits shown in the following table, the receipt printhead will heat up and shut down. This may damage the printhead.

To avoid this problem, do one or a combination of the following:

1. Reduce the amount of coverage.
2. Reduce the time of continuous solid printing.
3. Reduce the ambient temperature.

Allowable duty cycle* (measured over one minute of continuous printing)

Amount of Solid Coverage	Ambient Temperature		
	25°C (77°F)	35°C (95°F)	50°C (122°F)
20%	100%*	50%*	20%*
40%	50%*	25%*	10%*
100%	20%*	10%*	4%*

*Duty Cycle - Percentage of time that the specified “Amount of Solid Coverage” can be printed during a one-minute period of time. For example, at 20% solid coverage and 35°C temperature, a 50% duty cycle is to be used, resulting in 30 seconds of printing and 30 seconds without printing.

For reference:

- A typical receipt with text (contains some blank spaces) is approximately 12% dot coverage.
- A full line of text characters (every cell on the line has a character in it) is approximately 25% dot coverage.
- Graphics are approximately 40% dot coverage.
- Barcodes are approximately 50% dot coverage.
- A solid black line is 100% dot coverage.

4 Maintenance guidelines

Cleaning the printer

Clean the outside of the cabinet as needed to remove dust and finger marks. Use any household cleaner made for plastics. Test it first on a small unseen area. Clean the printer paper bucket with a clean, damp cloth.

The cabinet materials and finish are durable and resistant to the following items:

- Cleaning solutions
- Cooking oils
- Lubricants
- Ultraviolet light
- Fuels

If small paper debris has accumulated inside the printer, use a can of compressed air to gently clear the debris from the printer.

Cleaning the thermal printhead

 **IMPORTANT:** Do not clean the inside of the printer with any cleaner. Do not allow cleaning spray to come in contact with the thermal printhead. Damage to the internal electronics or thermal printhead could occur.

 **NOTE:** The thermal printhead does not normally require cleaning when recommended paper grades are used. If non-recommended paper is used over an extended period, attempting to clean the printhead will have little effect on the print quality.

1. Turn off the printer and POS computer.
2. Unplug the printer from the POS computer and the cash drawer, if connected.
3. Wipe the printhead with a cotton swab moistened with rubbing alcohol.

 **IMPORTANT:** Do not use rubbing alcohol to clean any internal parts of the printer other than the printhead. Damage will occur.

If spotty or light printing problems persist after cleaning the thermal printhead, the entire thermal mechanism may need to be replaced.

 **IMPORTANT:** Using non-recommended paper over an extended period of time can result in printhead failure. See [Qualified paper grades on page 23](#) for paper specifications.

A Troubleshooting

Diagnostics

The printer performs three primary diagnostic tests that provide useful information about the printer's operating status:

- Startup diagnostics, performed during the printer's startup cycle
- Runtime diagnostics
- Remote diagnostics, maintained during normal operation and reported in the print test

Startup diagnostics

When the printer receives power or performs a hardware reset, it automatically performs the startup diagnostics (also known as level 0 diagnostics) during the startup cycle. The printer:

- Turns off the motors
- Performs boot CR check of the firmware ROM, tests external SRAM, tests EEPROM, and tests main program CRC.

Failure causes startup diagnostics to stop; the printer beeps and the LED flashes a set number of times, indicating the nature of the failure. The following table describes the specific tone and LED sequences.

LED Behavior	Failure
One blink	Boot CRC error
Two blinks	RAM failure
Three blinks	EEPROM failure
Four blinks	Memory initialization failure

To resolve the problem:

- Check to see if paper is present
- Return the knife to the home position; failure causes a fault condition
- Check if the rear cover is closed; failure does not interrupt the startup cycle

When the startup diagnostics are complete, the printer makes a two-tone beep (low then high frequency), the paper feed button is enabled, and the printer is ready for normal operation.

If the printer has not been turned on before, or a new EEPROM has been installed, the default values for the printer functions will be loaded into the EEPROM during startup.

Runtime diagnostics

Runtime diagnostics (sometimes called level 2 diagnostics) run during normal printer operation. When the following conditions occur, the printer automatically turns off the appropriate motors and disables printing to prevent damage to the printer.

- Paper out
- Cover open
- Knife unable to home
- Printhead too hot
- Voltages out of range

The LED on the operator panel will signal when these conditions occur as well as indicate printer state or mode.

LED Behavior	Printer Status
Off	No power
Fast blink	Firmware download
Fast blink	Level 0 diagnostics (occurs at power on, and on reset); paper out
Slow blink	Temperature error or voltage error
Steady on	All other issues

Remote diagnostics

Remote diagnostics (sometimes called level 3 diagnostics) keep track of the following tallies and prints them on the receipt during the print test. These tallies can be used to determine the printer's state of health.

- Model number
- Serial number
- CRC number
- Number of lines printed
- Number of knife cuts
- Number of hours the printer has been on
- Number of flash cycles
- Number of cutter jams
- Number of times the cover is opened
- Maximum temperature reached

Solving common problems

The following table lists possible problems, the possible cause of each problem, and the recommended solutions.

Problem	Possible Cause	Solution
Green LED, quick steady flashing.	Paper is out.	Load a new paper roll. See Loading or changing the receipt paper on page 8 .
	Receipt cover is open.	Close the cover.
	Knife unable to home.	Stop using the printer. Contact your regional HP authorized service provider for HP Point of Sale System products.
Green LED, slow steady flashing.	There is a problem with the printer.	Stop using the printer. Contact your regional HP authorized service provider for HP Point of Sale System products.
Printer beeps (two-tone - low frequency, high frequency).	Printer has been turned on and is ready to operate.	No action is required.
Printer beeps and flashes green LED in various combinations.	Indicates serious conditions.	Stop using the printer. Contact your regional HP authorized service provider for HP Point of Sale System products.
Colored stripe is on the receipt.	Paper is low.	Change the paper roll. See Loading or changing the receipt paper on page 8 .
Receipt does not come out all the way.	Paper is jammed.	Open the receipt cover, inspect the knife, and clear the jammed paper.
Printer starts to print, but stops while the receipt is being printed.	Paper is jammed.	Open the receipt cover, inspect the knife, and clear the jammed paper.
Receipt is not cut.	Paper is jammed.	Open the receipt cover, inspect the knife, and clear the jammed paper.
Print is light or spotty.	Paper roll is loaded incorrectly.	Check to see if the paper roll is loaded properly. See Loading or changing the receipt paper on page 8 .
	Thermal printhead is dirty.	Use the recommended thermal print paper. See Ordering thermal paper on page 23 .
	Variations in paper.	Increase the print density in Set Hardware Options of the printer configuration menu to 110% or 120% as needed.
Vertical column of print is missing.	Indicates a serious condition with the printer electronics.	Stop using the printer. Contact your regional HP authorized service provider for HP Point of Sale System products.
One side of the receipt is missing.	Indicates a serious condition with the printer electronics.	Stop using the printer. Contact your regional HP authorized service provider for HP Point of Sale System products.
Printer does not function when turned on and LED is off.	The printer is not plugged in.	Check that printer cables are properly connected at both ends.
		Check that the POS computer is turned on.
Printer does not function when turned on and LED is blinking.	Receipt cover is not fully closed.	Close and latch the receipt cover.

Problem	Possible Cause	Solution
Printer stops functioning.	Printhead has overheated.	Allow printhead to cool down.
	Interrupted data signal over USB connection.	Ensure the standard USB cable is no more than 5 meters long with no extensions; eliminate hubs.
	Faulty USB port.	Plug cable into another USB port on the POS computer.
	Printer is in energy savings mode.	Press paper feed button to revive printer.
Interruption of data.	RS-232C mode is not working.	The printer had previously been connected to a USB host. Reset the printer and check normal RS-232C faults.
Printer goes off-line.	USB is not connected properly.	If printer does not auto-recover after 5-20 seconds, reconnect the USB cable, reset the printer, reboot the POS computer, check that the USB cable is properly connected at both ends.
Printer does not open.	Receipt cover is stuck.	Release the latch failsafe.

Latch failsafe

In the event of the receipt cover becoming stuck, the printer has a failsafe to release the latches. When holding the printer upright, use your finger to pull down on the failsafe loop located on the underside of the printer. With enough force, the latches should release, and the receipt cover should open.



Contacting support

To resolve a hardware or software problem, go to <http://www.hp.com/support>. Use this site to get more information about your product, including links to discussion forums and instructions on troubleshooting. You can also find information on how to contact HP and open a support case.

Preparing to call technical support

If you can not solve a problem using the troubleshooting tips in this section, you may need to call technical support. Have the following information available when you call:

- Printer model number
- Printer serial number
- Purchase date on invoice
- Conditions under which the problem occurred
- Error messages received
- Hardware configuration
- Name and version of the hardware and software you are using

Ordering paper rolls

To order paper rolls, contact your converter of choice. See [Qualified paper grades on page 23](#) for contact information.

B Technical specifications

HP Engage One Serial USB Thermal Printer

Technical specifications	
Reliability	
MCBF printlines	29 million
MCBF knife cuts	1 million
Interface	USB or Serial
Memory	8 MB flash memory, 8 MB RAM
Dimensions and weight	
Height	103 mm (4.06")
Width	111.8 mm (4.40")
Depth	131.6 mm (5.20")
Weight	0.8 kg (1.75 lbs)
Power Requirements	
Operating voltage	24Vdc +/- 10% +5 volts for logic circuit
Power consumption	2 Amps maximum current draw
Temperature	
Operating temperature	5°C to 35°C (41°F to 95°F) 35°C to 50°C (95°F to 120°F)
Operating humidity	5% to 90% 5% to 40%
Storage:	
Temperature	-10°C to 50°C (14°F to 122°F)
Humidity	5% to 90%
Transit:	
Temperature	-40°C to 60°C (-40°F to 140°F)
Humidity	5% to 95%
Condensation	Condensation may occur when the printer is moved from cold to warm areas after shipment. The printer's design permits operation after drying out and stabilizing at room temperature.
Printing Specification	
Speed - monochrome	114 mm/sec

Technical specifications	
Receipt - columns	44/56
Paper roll size	80 mm (wide) x 83 mm (diameter)
Paper out	Standard
Resolution	203 DPI
Knife	Standard

Characters appearance

The appearance of text can be changed using the following available print modes:

- Standard
- Compressed
- Double high
- Double wide
- Upside down
- Rotated
- Underlined
- Bold
- Reverse
- Italic
- Scaled
- Strike-through
- Shading

Print size

Character sizes for the standard and compressed mode:

- Standard
 - 15.6 characters per inch
 - 44 characters per line
 - 13 x 24 dots cell size
- Compressed
 - 20.3 characters per inch
 - 56 characters per line
 - 10 x 24 dots cell size

Ordering thermal paper

The printer requires qualified thermal paper with the following dimensions:

Width	Diameter
80 +0/-0.6 mm (3.15 +0/-0.03 in.)	83 mm max. (3.27 in.)

The above figures are based on a core diameter of 22 ± 0.5 mm (0.87 in.) outside, 11.5 ± 0.5 mm (0.45 in.) inside.

The paper must not be attached at the core. Use paper with a colored stripe at the end to indicate that the paper is running low, required when the printer is positioned vertically.

Qualified paper grades

The following paper grades produced by their respective manufacturers are recommended. There are a number of paper converters qualified to provide this paper, provided the POS rolls are from these recommended grades.

To order paper rolls, contact your converter of choice.

Monochrome (black ink) paper

Qualified manufacturer	Paper grade
Appvion, Inc. (USA) 825 E. Wisconsin Avenue Appleton, WI 54192 Voice: (800) 922-1729 Fax: (800) 922-1712	Alpha 400-2.3 (was T1030) Alpha 800-2.4 (was T1012A) POS-Plus 600-2.4 Alpha 900-3.4 (was Superior) All current Appvion papers are BPA-free
Jujo Thermal Ltd. P.O. Box 92 FI-27501 Kaukua, Finland Voice: 358 (0) 10 303 200 F358 (0) 10 303 2419	AF50KS-E3 AP62KS-E3
Kanzaki Specialty Papers (USA) 20 Cummings St. Ware, MA 01082-2002 Voice: (888) 526-9254 Fax: (413) 731-8864	P30023 (was P-300) P31023 (was P-310) P35024 (was P-350) P35032 (was P-354) P39023 (BPA free, was P-390) P30521 (BPA free) P30523 (BPA free) P31523 (BPA free) P35532 (BPA free)

Qualified manufacturer	Paper grade
Koehler AG Hauptstr. 2-4 D-77704 Oberkirch, Germany Voice: (49) 7802 81-0 Fax: (49) 7802 81-4330	KT55-F20
Koehler UK Ltd. (Great Britain) 2 White Oak Square London Road Swanley, Kent BR8 7AG, U.K. Voice: (44) 1322-661010 Fax: (44) 1322 614656	KT55-F20
Mitsubishi Int'l Corp. (USA) 655 Third Ave. New York, New York 10017 Voice: (212) 605-2000 Fax: (212) 605-2597	P-5035 T-8051 TP-8065 PP-5051
OJI Paper Company Ltd. Ginza 4-chome Tokyo 104, Japan Voice: (81)3-3563-1111 Fax: (81)3-3563-1135	KF-60 PD-170R PD-160R
Thermal Solutions Intl, Inc. 6740 Broadview Ave, Suite D Jacksonville, FL 32254 Voice: (800) 479-6070, (904) 860-1966 Fax: (904) 646-4530	19018RDT Features: 30% post-consumer waste, recycled/BPA free

Print zones for 80 mm paper

Specifications of print zone for 80 mm paper:

- 576 dots (addressable) @ 8 dots/mm, centered on 80 mm
- Standard mode minimum margins: 2.0 mm (.079 inches)
- Top margin to manual tear-off: 31.7 mm (1.25 inches)
- Top margin to knife cut: 7.7 mm (0.30 inches)

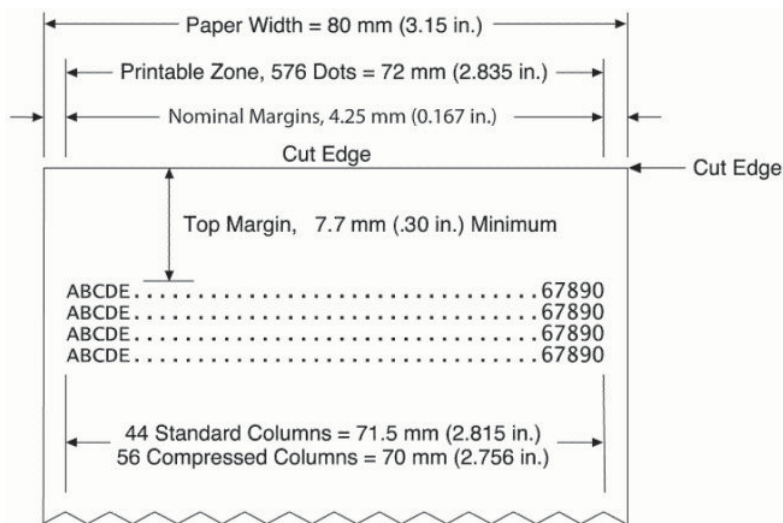

NOTE: The application centers 44 standard character cells (13 X 24 dots), or 56 compressed character cells (10 X 24 dots), or 576 addressable bits of graphics across an 80 mm wide receipt. Minimum print line height is 24 dots for text or graphics. Standard print line spacing is 27 dots (3 extra row dots).

The printer adds a 27 dot high font, so standard print spacing is 30 dots.

The printer paper-saving feature adds an 18 dot high font and reduces extra dot rows to 2, so standard print spacing is 20 dots.