

Solid-State Memory Camcorder

Operating Guide

Table of Contents	
Getting Started	
Recording	
Playback	
Editing	
Using the Menu	
Troubleshooting	
Additional Information	

NXCAM



Read this first

Before operating this unit, please read this manual thoroughly, and retain it for future reference.

Precautions when using the camcorder

- Do not hold the camcorder by the following parts, and also do not hold the camcorder by the jack covers.

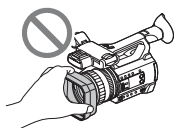

Lens hood

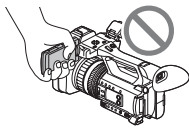

LCD screen

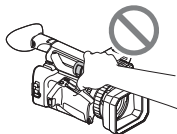

Microphone (sold separately) or
Microphone holder

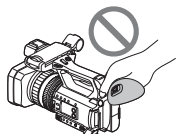

Viewfinder

addition, over a long period of use, because of the physical characteristics of the liquid crystal display, such “stuck” pixels may appear spontaneously. These problems are not a malfunction. Note that any such problems have no effect on recorded data.

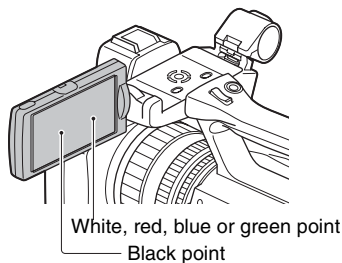

On sunlight

- Do not record the sun or leave the camcorder under the sun for a long time. The internal parts of the camcorder may be damaged. If sunlight is focused on a nearby object, it may cause a fire.
- Do not expose your camcorder's viewfinder, lens, or LCD screen to the sun or strong light source for extended periods. Doing so may cause a malfunction of the camcorder.
- Do not attempt to record the sun directly. Doing so may cause a malfunction of the camcorder.
- Do not expose the lens to beams, such as laser beams.
That may damage the image sensor and cause the camera to malfunction.

On the temperature of your camcorder and battery pack

Your camcorder has a protective function that disables recording or playback if the temperature of your camcorder or battery pack is beyond the safely operable range. In this case, a message appears on the LCD screen or in the viewfinder (p. 102).

Notes

- The camcorder is not dustproof, dripproof or waterproof. See “About handling of your camcorder” (p. 112).
- When connecting the camcorder to another device with communication cables, be sure to insert the connector plug in the correct way. Pushing the plug forcibly into the terminal will damage the terminal and may result in a malfunction of the camcorder.
- Use the camcorder in accordance with the regulations of the place where you use it.

On the LCD screen and lens

- A menu item that is grayed out is not available under the current recording or playback conditions.
- The LCD panel fitted to this unit is manufactured with high precision technology, giving a functioning pixel ratio of at least 99.99%. Thus a very small proportion of pixels may be “stuck”, either always off (black), always on (red, green, or blue), or flashing. In

On recording

- In order to stabilize memory card operation, it is recommended that you format the memory card when you use it with your camcorder for the first time. All data recorded on the memory card will be erased by formatting, and cannot be recovered. Save important data on the memory card on other media, such as a computer, before formatting the memory card.
- Before starting to record, test the recording function to make sure the picture and sound are recorded without any problems.
- Compensation for the loss of the content of recordings or the loss of recording opportunities cannot be provided, even if recording or playback is not possible due to a malfunction of the camcorder, storage media, etc., or even if images or sounds are distorted due to the limits of the capabilities of the camcorder.
- TV color systems differ depending on the countries/regions. To view your recordings on a TV, a TV of the appropriate color system for the country/region is required.
- Television programs, films, video tapes, and other materials may be copyrighted. Unauthorized recording of such materials may be contrary to the copyright laws.
- Because of the way that the image device (CMOS sensor) reads out image signals, the following phenomena may occur.
 - The subjects passing by the frame rapidly might appear crooked depending on the recording conditions. (This phenomenon may be notable in displays having high motion resolution.)
 - Horizontal lines appear on the LCD screen during recording under fluorescent lights, sodium lamps or mercury lamps. The phenomena can be reduced by adjusting the shutter speed (p. 39).

Save all your recorded image data

- To prevent your image data from being lost, save all your recorded images periodically.

To handle the recorded images on your computer

Download “Catalyst Browse” software (p. 18).

Format the recording media using [MEDIA FORMAT] if images are not recorded or played back properly

If you continue recording and deleting images on recording media for a long period of time, the files on that recording media may be fragmented. As a result, you may not be able to record and save images properly. If this happens, save images on a PC, then format the recording media (p. 70).

About the operation of the camcorder

You can operate the camcorder using the **▶/◆/◀** / **◆/SET** buttons (p. 72).

About this manual

- The on-screen displays in each local language are used for illustrating the operating procedures. Change the screen language before using your camcorder if necessary (p. 91).
- Design and specifications of recording media and other accessories are subject to change without notice.

Identifying Parts and Controls

Body

The numbers in () are reference pages.

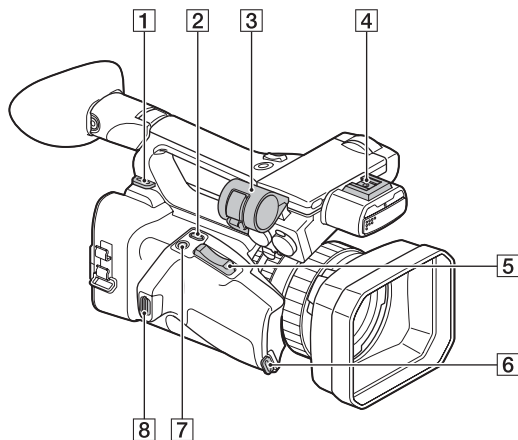

- 1** Hook for shoulder strap
- 2** ASSIGN4/LAST SCENE button (p. 56)
- 3** Microphone holder
- 4** Multi-interface shoe (p. 44, 79)
- 5** Power zoom lever (p. 32)
- 6** Grip belt attachment
- 7** ASSIGN5/FOCUS MAG button (p. 33, 58)
- 8** Grip belt attachment

Attaching the microphone (sold separately)

This section explains how to connect an external microphone (sold separately).

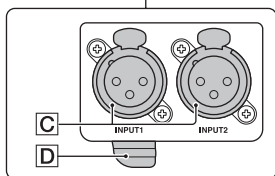
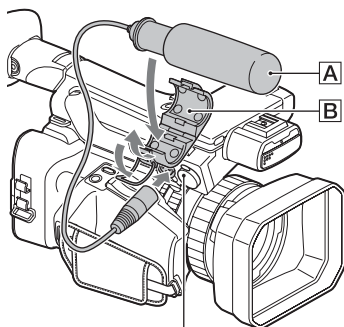

- ① Place the microphone **A** into the microphone holder **B**.
- ② Connect the plug of the microphone to the INPUT1 jack or INPUT2 jack **C**.
- ③ Place the microphone cable into the cable holder **D**.

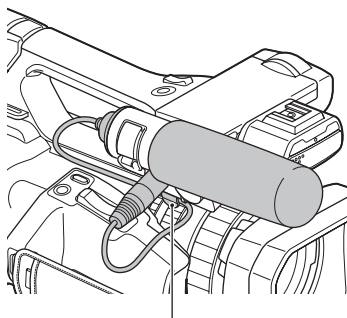

Put the cable in the outer cable holder.

Identifying Parts and Controls (Continued)

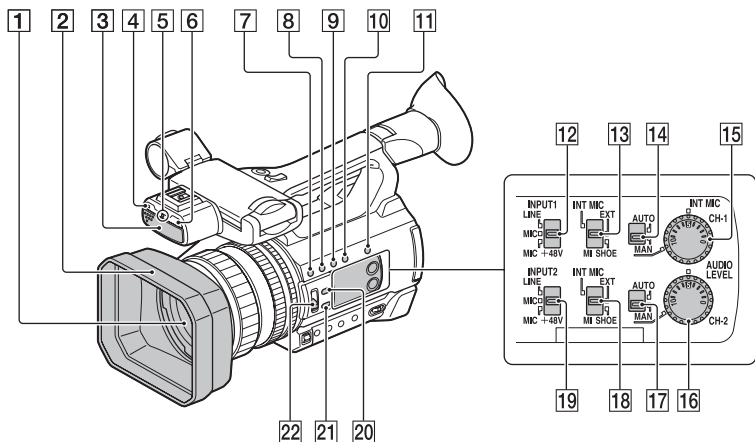

- 1** Lens (G lens)
- 2** Lens hood
- 3** Internal microphone
- 4** Remote control sensor (p. 91)
- 5** Recording lamp (p. 91)
Flashes when remaining capacity of the memory card or battery becomes low.
- 6** NIGHTSHOT light (p. 46)
- 7** ASSIGN1/WB SET button (p. 41, 58)
- 8** ASSIGN2/STATUS button (p. 58, 64)
- 9** ASSIGN3/LOW LUX button (p. 46, 58)
- 10** DISPLAY button (p. 63)
- 11** SLOT SEL button (p. 27)
- 12** INPUT1 (LINE/MIC/MIC+48V) switch (p. 42)
- 13** CH-1 (INT MIC/EXT/MI SHOE) switch (p. 42)
- 14** AUTO/MAN (CH-1) switch (p. 43)
- 15** AUDIO LEVEL (CH-1) dial (p. 43)
- 16** AUDIO LEVEL (CH-2) dial (p. 43)
- 17** AUTO/MAN (CH-2) switch (p. 43)
- 18** CH-2 (INT MIC/EXT/MI SHOE) switch (p. 42)
- 19** INPUT2 (LINE/MIC/MIC+48V) switch (p. 42)
- 20** IRIS AUTO/MAN button (p. 38)
- 21** FOCUS AUTO/MAN button (p. 33)
- 22** ND FILTER switch (p. 40)

Attaching the lens hood

Align the marks on the lens hood to those on the camcorder, and turn the lens hood in the direction of the arrow ② until it is locked.

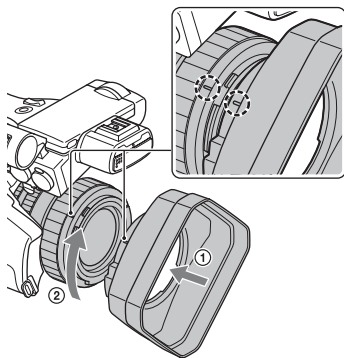

Tip

- If you attach or remove a 62 mm (2 1/2 in.) PL filter or MC protector, remove the lens hood.

Identifying Parts and Controls (Continued)

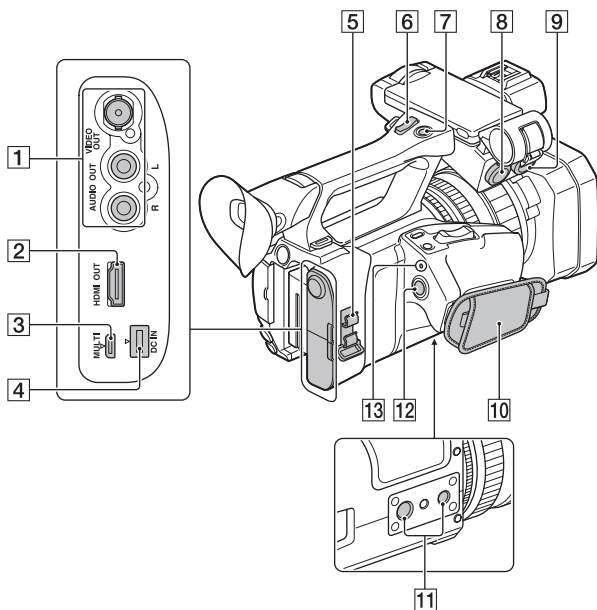

- 1 VIDEO OUT jack/AUDIO OUT jack (p. 65, 81)
- 2 HDMI OUT jack (p. 65)
- 3 Multi/Micro USB jack (p. 91)
- 4 DC IN jack (p. 19)
- 5 Cable clamber/loop clamber
- 6 Handle zoom lever (p. 32)
- 7 Handle record button (p. 28)
- 8 INPUT1 jack (p. 42)
- 9 INPUT2 jack (p. 42)
- 10 Grip belt
- 11 Tripod receptacles (1/4 inch, 3/8 inch)
Supports 1/4-20UNC and 3/8-16UNC screws.
For mounting on a tripod (sold separately, screw length 5.5 mm or shorter)

The tripod may not be able to mount in some orientations, depending on the tripod specifications.

- 12 START/STOP button (p. 28)
- 13 POWER/CHG lamp

About the cable clamber/loop clamber

Attaching the power cord, HDMI cable, and other cables, inserted in the corresponding connectors, in the cable clamber helps prevent the cords from being disconnected. However, not all HDMI cables are supported.

Attach any cables that are not in the cable clamber to the loop clamber at the bottom of the clamber using a cable tie or similar object.

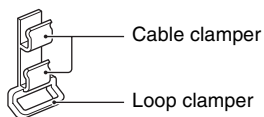

Note

Do not use the cable clamper/loop clamper for any purpose other than securing cables (for example, attaching a strap for carrying the camcorder).

Identifying Parts and Controls (Continued)

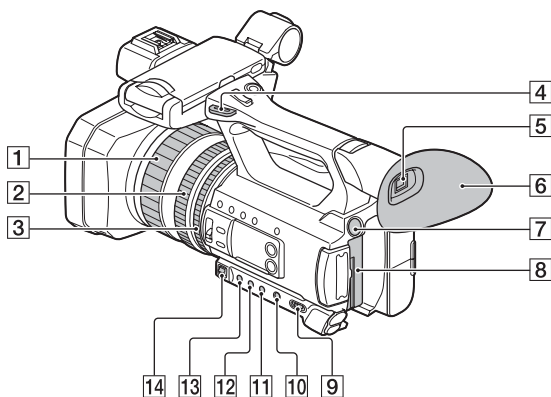

- 1** Focus ring (p. 33)
- 2** Zoom ring (p. 32)
- 3** Iris ring (p. 38)
- 4** Hook for shoulder strap
- 5** Viewfinder (p. 24)
- 6** Large eyecup (p. 24)
- 7** BATT RELEASE button (p. 20)
- 8** Battery pack (p. 19)
- 9** ON/STANDBY switch (p. 22)
- 10** FULL AUTO button (p. 45)
- 11** SHUTTER button (p. 39)
- 12** WHT BAL button (p. 41)
- 13** GAIN button (p. 39)
- 14** Manual lever (p. 39, 41)

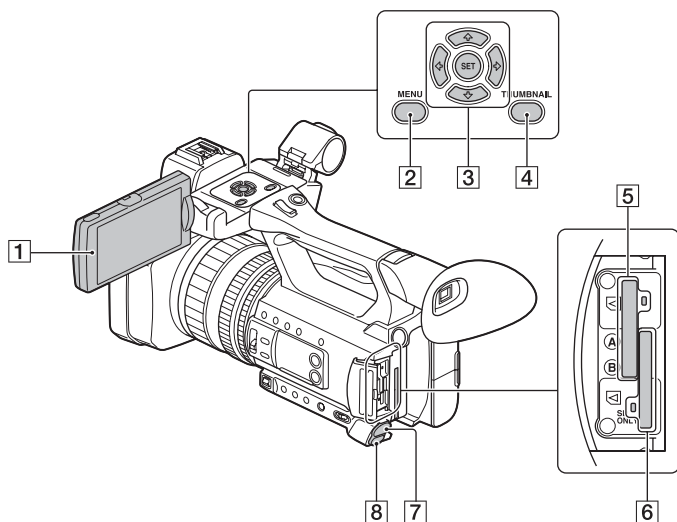

- 1** LCD screen (p. 24)
- 2** MENU button (p. 72)
- 3** \blacktriangle / \blacktriangledown / \blacktriangleleft / \blacktriangleright /SET buttons (p. 72)
- 4** THUMBNAIL button (p. 60)
- 5** Memory card slot A/Memory card access lamp (p. 26)
- 6** Memory card slot B/Memory card access lamp (p. 26)
- 7** \odot (headphones) jack
- 8** REMOTE jack (p. 91)
The REMOTE jack connects to a video deck or other devices used to control playback.

Identifying Parts and Controls (Continued)

Wireless Remote Commander

Remove the insulation sheet before using the Wireless Remote Commander.

Insulation sheet

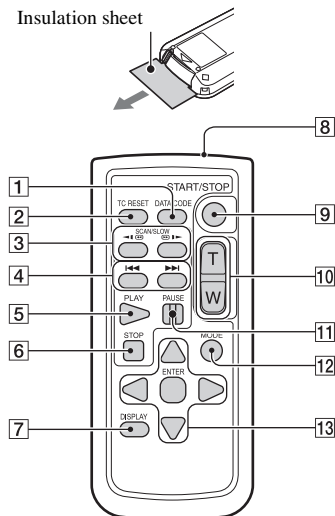

- 1 DATA CODE button (p. 63)
- 2 TC RESET button (p. 54)
- 3 SCAN/SLOW buttons (p. 60)
- 4 ◀▶ (PREV/NEXT) buttons (p. 60)
- 5 PLAY button (p. 60)
- 6 STOP button (p. 60)
- 7 DISPLAY button (p. 63)
- 8 Transmitter
- 9 START/STOP button (p. 28)
- 10 Power zoom lever
- 11 PAUSE button (p. 60)
- 12 MODE button
- 13 ◀/▶/▲/▼/ENTER buttons

Notes

- Aim the Wireless Remote Commander towards the remote sensor to operate your camcorder.
- Point the remote sensor away from strong light sources such as direct sunlight or overhead lighting. Otherwise, the Wireless Remote Commander may not function properly.
- When you are operating with the Wireless Remote Commander supplied with your camcorder, your video device may also operate. In that case, select a commander mode other than DVD2 for your video device, or cover the sensor of your video device with black paper.

To change the battery of the Wireless Remote Commander

- 1 While pressing on the tab, inset your fingernail into the slit to pull out the battery case.
- 2 Place a new battery with the + side facing up.
- 3 Insert the battery case until it clicks into place.

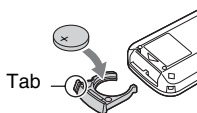

WARNING

Battery may explode if mistreated. Do not recharge, disassemble or dispose of in fire.

- When the lithium battery becomes weak, the operating distance of the Wireless Remote Commander may shorten, or the Wireless Remote Commander may not function properly. In this case, replace the battery with a Sony CR2025 lithium battery. Use of another battery may present a risk of fire or explosion.

Screen Indicators

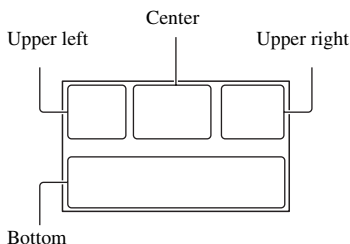

Upper left

Indicator	Meaning
	100% Remaining battery
	INTELLIGENT AUTO (face detection/scene detection/camera-shake detection) (p. 45)
	SCENE SELECTION (p. 45)
XAVCS 2160/25p 60 XAVCS 1080/50p 50 AVCHD 1080/50i FX	REC FORMAT (p. 36)
4:3	WIDE REC (p. 80)
W T	Optical zoom
Z99 cQ x1.2	Clear image zoom
Z99 dQ x2.3	Digital zoom
	SIMUL/RELAY REC
100-0001 CLI_0001	Playback folder of memory card

Center

Indicator	Meaning
	Recording media
REC STBY	Recording standby
	Warning (p. 102)
	Playback indicator (p. 60)
	Processing
	Relay recording
	HDMI REC CONTROL

Upper right

Indicator	Meaning
Omin	Estimated remaining recording time
	Recording/playback media
00:00:00:00	Time code (hour:minute:second:frame)

Bottom



Indicator	Meaning
	Face detection [ON]
PEAKING	PEAKING (p. 85)
	ZEBRA (p. 85)
	STEADYSHOT (p. 79)
	Manual focus (p. 33)
PP1 to PP6	PICTURE PROFILE (p. 47)
F5.6	Iris (p. 38)
9dB	Gain (p. 39)
100 180°	Shutter speed (p. 39)
DolbyD	AVCHD AUDIO FORMAT (p. 82)
-2.0EV	AE SHIFT (p. 78)
	Auto setting (p. 38)
	White balance (p. 41)



HISTOGRAM (p. 84)

	LOW LUX (p. 46)
	AUDIO LEVEL DISPLAY (p. 87)
DIG.EXT	Digital extender (p. 78)
	NIGHTSHOT (p. 46)
ND OFF ND1 ND2 ND3	ND filter (p. 40)

Screen Indicators (Continued)

Indicator	Meaning
 	Multi Interface Shoe video light (p. 79)
	Manual volume adjustment (p. 44)

Tip

- Indicators may look different or appear at different positions.

Data during recording

The recording date, time and condition are recorded automatically on the recording media.

They are not displayed while recording.

However, you can check them by selecting  (DISPLAY SET) → [DATA CODE] and choosing the data that you want to display, or by pressing the ASSIGN button to which the DATA CODE function is assigned, during playback.

Table of Contents

Read this first	2
Identifying Parts and Controls	4
Body	4
Wireless Remote Commander	12
Screen Indicators	13

Getting Started

Step 1: Checking supplied accessories	18
Step 2: Charging the battery pack	19
Step 3: Turning on the camcorder and setting the date and time	22
Turning on the camcorder	22
Setting the date and time	22
Step 4: Adjusting the LCD screen and viewfinder	24
Using the LCD screen	24
Using the viewfinder	24
Adjusting the viewfinder	24
Step 5: Preparing the recording media	26

Recording

Recording	28
Recording movies	28
Continuous recording on the memory cards (Relay recording)	30
Recording movies using both the memory card A and B (Simultaneous recording)	31
Changing the setting of the START/STOP button and handle record button	31
Adjusting the zoom	32
Adjusting the focus	33
Using the focus magnifier	33
Focusing on a detected face (Face detection)	34
Changing the recording setting	36
Selecting the file format and recording format	36
Setting the output destination when recording in 4K mode	36
Setting DV MODE (DV mode)	37
Adjusting the brightness	38
Adjusting the iris	38
Adjusting the gain	39
Adjusting the shutter speed	39
Adjusting the volume of light (ND filter)	40
Adjusting the color tone	41
Adjusting the white balance	41

Table of Contents (Continued)

Audio setup	42
Recording sound from the internal microphone	43
Recording sound from an external audio device	43
Recording sound from a Multi Interface Shoe compatible microphone (sold separately)	44
Adjusting the recording level	44
Useful functions	45
Selecting suitable settings automatically (auto mode setting)	45
Shooting in dimly lit locations (LOW LUX)	46
Shooting in dark conditions (NIGHTSHOT)	46
Customizing the picture quality (Picture profile)	47
Setting time data	54
Recording with the Slow & Quick Motion function	55
Reviewing the most recently recorded scene (Last Scene Review)	56
Assigning functions to the ASSIGN buttons	58







Playback

Playback	60
Playing back movies	60
Changing/checking the settings in your camcorder	63
Changing the screen display	63
Displaying recording data (Data code)	63
Checking the settings in your camcorder (Status check)	64
Connecting to a monitor or a TV	65

Editing

Protecting movies (Protect)	68
Dividing a movie	68
Deleting movies	69
Formatting recording media	70
Deleting all data from the memory card completely	70
Repairing the image database file	71

Using the Menu

Operating the menu	72
Menu items	74
 (CAMERA SET) menu	77
Settings to adjust your camcorder to the recording conditions ( STEADYSHOT, etc.)	
 (REC/OUT SET) menu	80
Recording settings, input and output settings (REC SET/VIDEO OUT, etc.)	
 (AUDIO SET) menu	82
Settings for the audio recording (AVCHD AUDIO FORMAT, etc.)	
 (DISPLAY SET) menu	84
Display settings (MARKER/DISPLAY OUTPUT, etc.)	
 (TC/UB SET) menu	88
Time code settings (TC PRESET/UB PRESET, etc.)	
 (OTHERS) menu	90
Settings while recording or other basic settings (AREA SET/BEEP, etc.)	

Troubleshooting

Troubleshooting	93
Warning indicators and messages	102

Additional Information

Recording time of movies	105
Using your camcorder abroad	107
File/folder structure on the recording media	108
Maintenance and precautions	109
About the XAVC S format	109
About the AVCHD format	109
About memory cards	109
About the "InfoLITHIUM" battery pack	110
About consumable parts	112
About handling of your camcorder	112
Specifications	115
Index	118

Step 1: Checking supplied accessories

Make sure that you have following items supplied with your camcorder. If, for any reason, there is something missing, contact your Sony dealer.

- Recording media are sold separately.

AC Adaptor (p. 19)

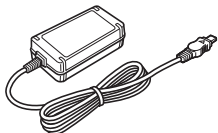

Power cord (mains lead) (p. 19)



IS1293 power cord for India.
Not supplied in some countries.



Wireless Remote Commander (RMT-845)
(p. 12)



A button-type lithium battery is already installed.

Large eyecup (p. 24)



Lens hood (p. 7)

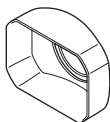

Lens cap (p. 28)



USB cable

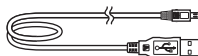

Rechargeable battery pack (NP-F570)

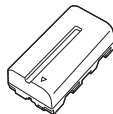

Battery charger (BC-L1)

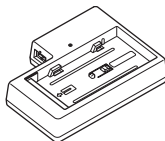

CD-ROM "Manuals for Solid-State Memory Camcorder"

Before Using This Unit

Software Downloads

When the unit is used with a PC connection, download any device drivers, plug-ins, and application software you require from the following websites.

Sony Professional products website:
 U.S.A. <http://pro.sony.com>
 Canada <http://www.sonybiz.ca>
 Latin America <http://sonypro-latin.com>
 Europe, Middle East, and Africa
<http://www.pro.sony.eu>
 Japan <http://www.sonybsc.com>
 Asia Pacific <http://pro.sony-asia.com>
 Korea <http://bp.sony.co.kr>
 China <http://pro.sony.com.cn>

Although the data regarding recorded materials are stored over multiple files and folders, you can easily handle the clips without considering its data and directory structure, by using the dedicated application software.

Step 2: Charging the battery pack

You can charge the “InfoLITHIUM” battery pack (L series) with the supplied AC Adaptor.

ⓘ Note

- You can use a large capacity battery pack, NP-F970 (sold separately), with your camcorder.

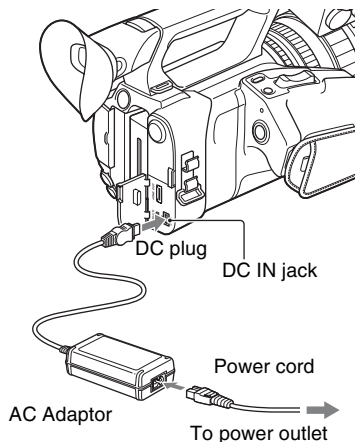

- 1 Push the battery in and slide it down into position.

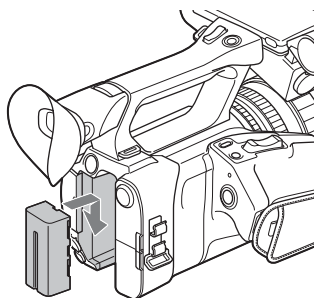

Step 2: Charging the battery pack (Continued)

- 2 Connect the DC plug to the DC IN jack of the camcorder.

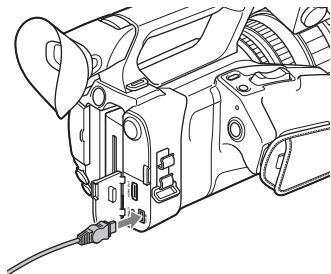

- 3 Connect the power cord (mains lead) to the AC Adaptor and the wall outlet (wall socket).

- 4 Turn the ON/STANDBY switch to STANDBY (⏻).

The CHG lamp lights up and charging starts.

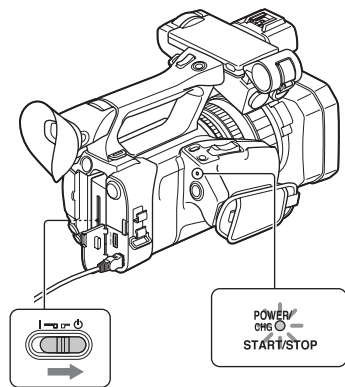

When charging ends

The CHG lamp turns off when the battery is fully charged.

Note

Even if the CHG lamp is not lit, the battery charger is not disconnected from the AC power source (mains) as long as it is connected to the wall outlet (wall socket).

Disconnect the AC Adaptor from the DC IN jack.

Tip

- You can check the remaining battery life with the status check function (p. 64).

To remove the battery pack

Turn the ON/STANDBY switch to STANDBY (⏻). Press and hold the BATT RELEASE button, and slide the battery up and out.

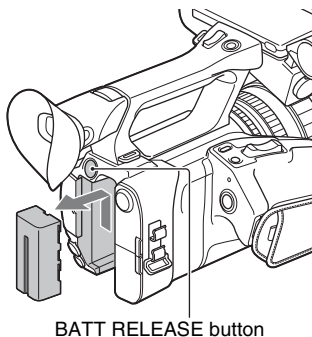

To store the battery pack

If the battery pack is not in use for a while, run down the battery and store it (p. 111).

Charging time

Approximate time (minutes) required when you charge a fully discharged battery pack.

Battery pack	Full charge time
NP-F570	260 minutes

Battery pack	Full charge time
NP-F970 (sold separately)	520 minutes

On the battery pack

- Always turn the ON/STANDBY switch to STANDBY (⏻) before changing the battery pack.
- The CHG lamp flashes during charging, or the Battery Info will not be correctly displayed under the following conditions.
 - The battery pack is not attached correctly.
 - The battery pack is damaged.
 - The battery pack is worn-out.

Using a power outlet

You can use the AC Adaptor to obtain the AC power. While you are using the AC Adaptor, the battery pack will not lose its charge even when it is attached to your camcorder.

Perform the procedure up to step 3 of “Step 2: Charging the battery pack” (p. 19).

On the AC Adaptor

- Do not short-circuit the DC plug of the AC Adaptor or battery terminal with any metallic objects. This may cause a malfunction.

To charge the battery pack using the supplied battery charger (BC-L1)

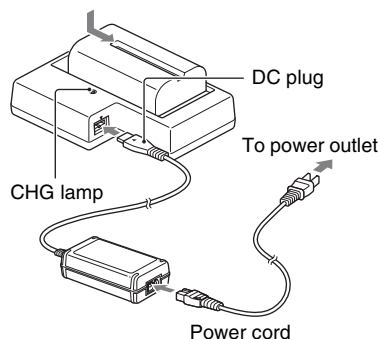

1 Connect the DC plug to the DC IN jack of the battery charger.

2 Connect the power cord (mains lead) to the AC Adaptor and the wall outlet (wall socket).

3 Push the battery in and slide it in the direction of the arrow in the diagram.

The CHG lamp lights up and charging starts.

When charging ends, the CHG lamp turns off.

Slide the battery pack out in the opposite direction and remove it from the battery charger.

Note

Even if the CHG lamp is not lit, the battery charger is not disconnected from the AC power source (mains) as long as it is connected to the wall outlet (wall socket).

Step 3: Turning on the camcorder and setting the date and time

Turning on the camcorder

Turn the ON/STANDBY switch to ON (I).

When you use your camcorder for the first time, the [CLOCK SET] screen appears.

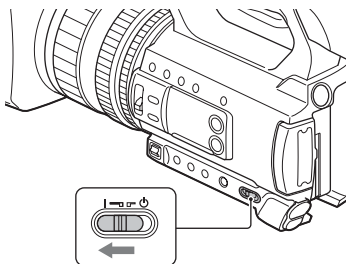

To turn off the power

Turn the ON/STANDBY switch to STANDBY (⏻).

Note

- If a warning message is displayed, follow the instructions.

Setting the date and time

Set the date and time when you use your camcorder for the first time.

Tip

- If you do not use your camcorder for about **3 months**, the built-in rechargeable battery gets discharged and the date and time settings may be cleared from the memory. In that case, charge the rechargeable battery and then set the date and time again (p. 113).

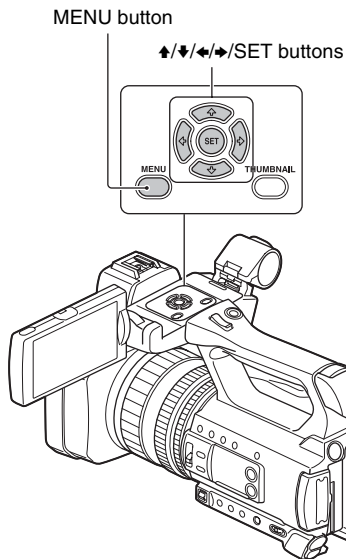

To set the date and time again, press the MENU button, and select  (OTHERS) → [CLOCK SET].

- 1** Select your area using the ▲/▼/◀/▶/SET button, then press the button.

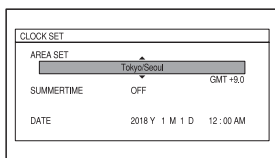

2 Set [SUMMERTIME], [Y] (year), [M] (month), [D] (day), hour and minute, using the $\uparrow/\downarrow/\leftarrow/\rightarrow$ /SET button, then press the button.

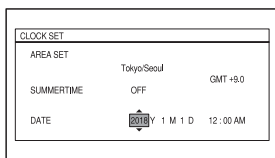

The clock starts.

- Set [SUMMERTIME] to [ON] to move the time forward 1 hour.
- You can set any year up to the year 2037.
- Midnight is indicated as 12:00 AM, and noon as 12:00 PM.

Tip

- The date and time are automatically recorded on the selected recording media, and can be displayed during playback (p. 87).

Step 4: Adjusting the LCD screen and viewfinder

Using the LCD screen

The LCD screen can be rotated in the range as illustrated below, allowing a person other than the camera operator to see the image.

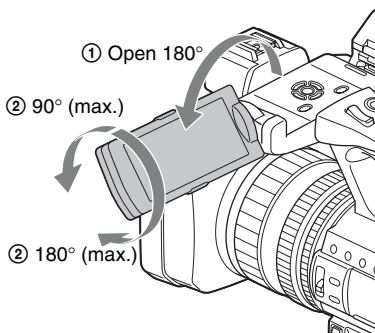

Using the viewfinder

Closing the LCD screen switches the display to the viewfinder. You can adjust the angle of the viewfinder to suit your shooting style.

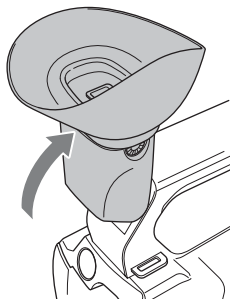

Note

The LCD screen and the viewfinder do not operate at the same time.

Adjusting the viewfinder

Diopter adjustment dial

Move it until the picture becomes clear.

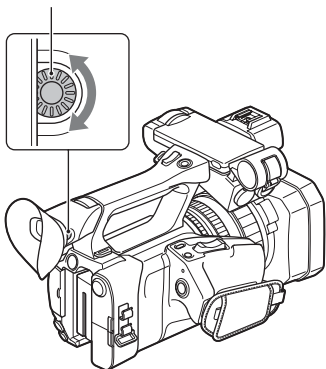

Note

- Some primary colors may become visible in the viewfinder if you change your line of sight, but this is not a malfunction. These colors are not recorded onto the memory cards.

When the picture in the viewfinder is hard to see

If you cannot see the picture in the viewfinder clearly under bright circumstances, use the supplied large eyecup. To attach the large eyecup, stretch it slightly and fit it over the groove of the eyecup attached to the camcorder. You can attach the large eyecup facing either the right or left side.

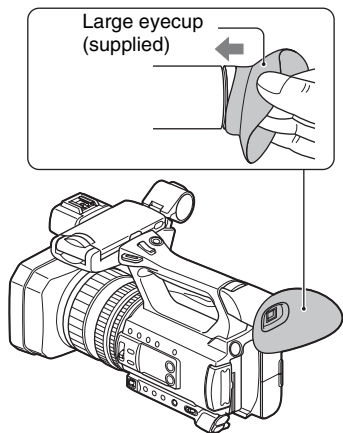
**Note**

- Do not remove the eyecup pre-attached to the camcorder.

Step 5: Preparing the recording media

SD card

File format		Supported memory cards
AVCHD		SD/SDHC/SDXC memory cards (Class 4 or U1 or faster)
	S&Q MOTION	SDHC/SDXC memory cards (Class 10 or U1 or faster)
XAVC S HD		SDXC memory cards (Class 10 or U1 or faster)
XAVC S 4K	60Mbps or slower	SDXC memory cards (Class 10 or U1 or faster)
	100Mbps	SDXC memory cards (U3)
DV		SD/SDHC/SDXC memory cards (Class 6 or faster)

“Memory Stick” media

File format	Supported memory cards
AVCHD	Memory Stick PRO Duo (Mark2), Memory Stick PRO-HG Duo
DV	Memory Stick PRO-HG Duo

Notes

- Operation with all memory cards is not assured.
- Only “Memory Stick PRO Duo” media, which is half the size of standard “Memory Stick” media, or standard size SD cards can be used with this camcorder.
- See page 105 for the recording time of memory cards.
- Movies recorded on SDXC memory cards can be imported to or played back on other equipment, such as a computer or A/V device, by connecting the camcorder to the equipment with the USB cable. However, the equipment must support the exFAT file system used for SDXC memory cards. Confirm in advance that the connecting equipment is supporting the exFAT file system. If you connect equipment not supporting the exFAT file system and the format screen appears, do not perform the format. All the data recorded will be lost.
- If unsupported media is used, you may be able to record without an error message being displayed on the screen, but the recorded data is not guaranteed.

Open the cover, and insert the memory card with the notched corner in the direction as illustrated until it clicks into place.

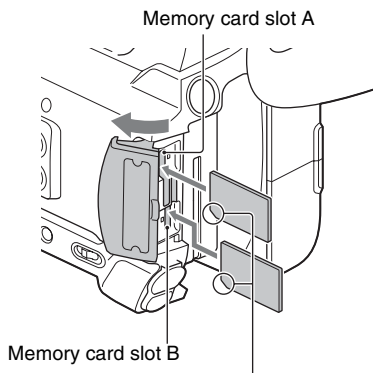

Note the direction of the notched corner.

- If you insert a memory card into the slot in the wrong direction, the memory card, the memory card slot, or image data may be damaged.
- Memory card slot A accepts either “Memory Stick PRO Duo” media or an SD card. Memory card slot B accepts an SD card only.

To eject a memory card

Lightly push the memory card once.

Notes

- If “The image database file is corrupted. The media must be restored to use again.” appears, format the memory card (p. 70).
- When inserting or ejecting the memory card, be careful of the memory card popping out and dropping.

Selecting the memory card slot to be used for recording

Press the SLOT SEL button to change which slot is selected for recording. You can confirm the selected slot on the screen.

SLOT SEL button

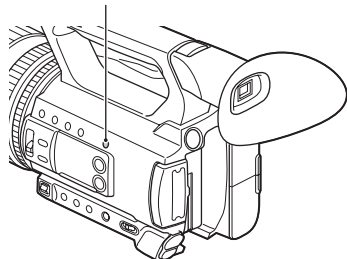

Notes

- You can only select a slot that already has a memory card inserted.
- While movies are being recorded on the memory card, you cannot switch the slot even if you press the SLOT SEL button.

Tip

- When only one slot has a memory card inserted, the slot that has the memory card is selected automatically.

If a repair memory card prompt screen appears

There may have been a problem recording to the memory card during the most-recent recording. Select [OK] to repair the card to the extent possible. Select [CANCEL] to continue without repairing.

Notes

- Correct repair may not be possible, even when repair is executed.
- Repair is not supported if an error occurs when recording in XAVC S format.

Recording

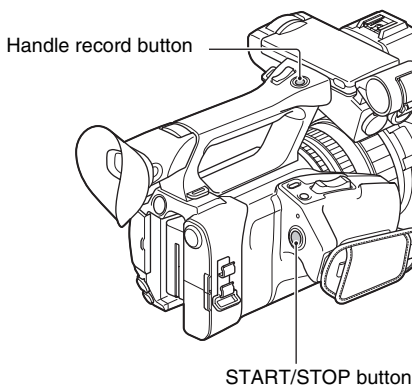

Recording movies

Your camcorder records movies on a memory card. The factory setting for recording movies is AVCHD. Do the following steps to record movies.

- 1** Press the latches on both sides of the lens cap and remove it.

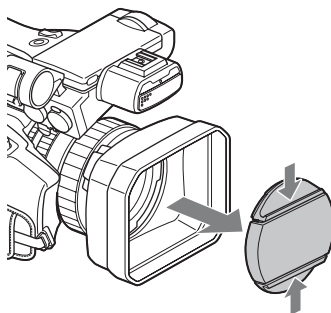

2 Turn the ON/STANDBY switch to ON (I).

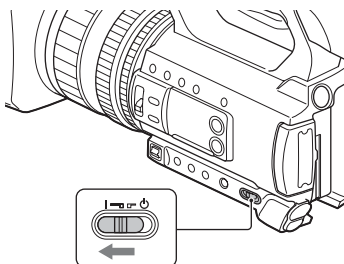

3 Press the START/STOP button (or the handle record button) to start recording.

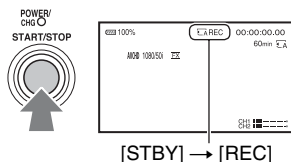

The recording lamps light up during recording.

To stop the movie recording, press the START/STOP button or the handle record button again.

Notes

- When the access lamp is lit or flashing in red, your camcorder is reading or writing data on recording media. Do not shake or apply strong force to your camcorder, do not turn the power off, and do not remove the recording media, battery pack or the AC Adaptor. The image data may be destroyed.
- See page 105 about the recording time of movies.
- If a movie file size exceeds 2 GB while recording in DV or AVCHD format, the camcorder automatically divides the file and creates a new one.
- If a movie file size exceeds 6 hours duration while recording in XAVC S (HD) format, the camcorder automatically divides the file and creates a new one.
- The menu settings, picture profile settings, and settings made using the AUTO/MAN switch are saved when you turn the camcorder off by setting the ON/STANDBY switch to STANDBY (⏻). The POWER/CHG lamp flashes while the settings are being stored.

Recording (Continued)

💡 Tips

- When recording with a setting other than DV, the aspect ratio is fixed to 16:9. When recording in DV mode, you can switch the aspect ratio to 4:3 ([**HDTV** WIDE REC], p. 80).
- For details about changing the screen display during recording, see page 63.
- For details about screen display during recording, see page 13.
- The recording lamps can be set to stay off ([REC LAMP], p. 91).

Continuous recording on the memory cards (Relay recording)

Insert memory cards each in both slots A and B, so the camcorder switches memory card A (or B) just before space on the other one runs out, and continues recording on the next memory card automatically.

Do the following setting before recording.

Press MENU → select **⇄** (REC/OUT SET) → [REC SET] → [SIMUL/RELAY REC] → [RELAY REC] with the **▲/▼/◀/▶/SET** button.

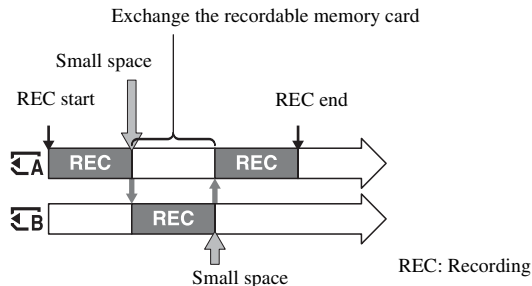

📌 Notes

- Do not eject the memory card that is currently being used for recording. When replacing a memory card while recording, replace only the one in the slot whose access lamp is off.
- Even if you press the SLOT SEL button, while recording movies, you cannot switch the slot currently being used.
- When the remaining recording time of the memory card being used is less than 1 minute and the other slot has a recordable memory card inserted, [**↔A** → **↔B**] or [**↔B** → **↔A**] appears on the camcorder screen. The indicator turns off when the memory card is switched.
- If you start recording on a memory card with the remaining recording time of less than 1 minute, the camcorder may not be able to relay-record. To relay-record without failing, make sure that the memory card has more than 1 minute when you start recording.
- Seamless playback of relay-recorded movies with this camcorder is not possible.
- You can re-combine relay-recorded movies using the “Catalyst Browse” application software.
- The maximum continuous recording time is 6 hours for XAVC S 4K, and 13 hours for XAVC S HD. (Files are split after approximately 6 hours).
When recording in AVCHD and DV, the maximum continuous recording time is approximately 13 hours.

Recording movies using both the memory card A and B (Simultaneous recording)

You can record movies on both of these recording media simultaneously.

Press MENU → select $\left[\begin{smallmatrix} \text{REC} \\ \text{OUT SET} \end{smallmatrix} \right]$ → [REC SET] → [SIMUL/RELAY REC] → [SIMULTANEOUS REC] with the $\left[\begin{smallmatrix} \blacktriangle \\ \blacktriangledown \\ \blacktriangleleft \\ \blacktriangleright \end{smallmatrix} \right]$ /SET button.

Changing the setting of the START/STOP button and handle record button

When using SIMULTANEOUS REC, you can start and stop recording on different memory cards by using the START/STOP button and the handle record button.

In the default setting, movies are recorded on both the memory card A and B at the same time when either record button is pressed.

- REC BUTTON: $\left[\begin{smallmatrix} \text{A} \\ \text{B} \end{smallmatrix} \right]$ $\left[\begin{smallmatrix} \text{A} \\ \text{B} \end{smallmatrix} \right]$
- HANDLE REC BUTTON: $\left[\begin{smallmatrix} \text{A} \\ \text{B} \end{smallmatrix} \right]$ $\left[\begin{smallmatrix} \text{A} \\ \text{B} \end{smallmatrix} \right]$

To change the setting

Press MENU → select $\left[\begin{smallmatrix} \text{REC} \\ \text{OUT SET} \end{smallmatrix} \right]$ → [REC SET] → [REC BUTTON SETTING] with the $\left[\begin{smallmatrix} \blacktriangle \\ \blacktriangledown \\ \blacktriangleleft \\ \blacktriangleright \end{smallmatrix} \right]$ /SET button.

REC BUTTON SETTING setting	Button and recording media
REC BUTTON: $\left[\begin{smallmatrix} \text{A} \\ \text{B} \end{smallmatrix} \right]$ HANDLE REC BUTTON: $\left[\begin{smallmatrix} \text{A} \\ \text{B} \end{smallmatrix} \right]$	Recording on both the memory card A and the memory card B starts and stops at the same time when either record button is pressed.
REC BUTTON: $\left[\begin{smallmatrix} \text{A} \\ \text{A} \end{smallmatrix} \right]$ HANDLE REC BUTTON: $\left[\begin{smallmatrix} \text{B} \\ \text{B} \end{smallmatrix} \right]$	Recording on the memory card A starts and stops when the START/STOP button is pressed, and on the memory card B when the handle record button is pressed.
REC BUTTON: $\left[\begin{smallmatrix} \text{B} \\ \text{B} \end{smallmatrix} \right]$ HANDLE REC BUTTON: $\left[\begin{smallmatrix} \text{A} \\ \text{A} \end{smallmatrix} \right]$	Recording on the memory card B starts and stops when the START/STOP button is pressed, and on the memory card A when the handle record button is pressed.

Adjusting the zoom

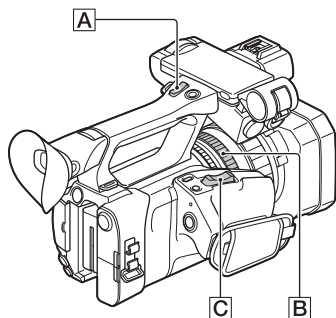

Adjusting the zoom with the power zoom lever

Press the zoom lever **C** slightly to zoom slowly, and press it further to zoom more quickly.

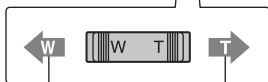
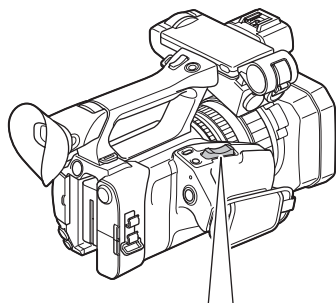

Wide angle
view: Wide



Close view:
Telephoto

💡 Tips

- When focusing, the minimum distance required between the camcorder and the subject is about 1 cm (about 13/32 in.) for wide angle and about 1 meter (about 39 3/8 in.) for telephoto.
- The focus may not be adjusted at certain zoom positions if the subject is within 1 meter (about 39 3/8 in.) from your camcorder.
- Be sure to keep your finger on the power zoom lever **C**. If you remove your finger, the operation sound of the power zoom lever **C** may also be recorded.

Adjusting the zoom with the handle zoom

Press the handle zoom lever **A** to zoom in or out.

💡 Tip

You can turn the handle zoom function on/off, and change the zoom operation speed ([HANDLE ZOOM], p. 78).

Adjusting the zoom with the zoom ring

You can zoom at the desired speed by turning the zoom ring **B**. Fine adjustment is also possible.

⚠ Note

- Turn the zoom ring **B** at a moderate speed. If you turn it too fast, the zoom may lag behind the zoom ring rotation, or the operation sound of the zoom may also be recorded.

Adjusting the focus

You can adjust the focus manually for different recording conditions.

Use this function in the following cases.

- To record a subject behind a window covered with raindrops.
- To record horizontal stripes.
- To record a subject with little contrast between the subject and its background.
- When you want to focus on a subject in the background.

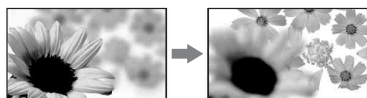

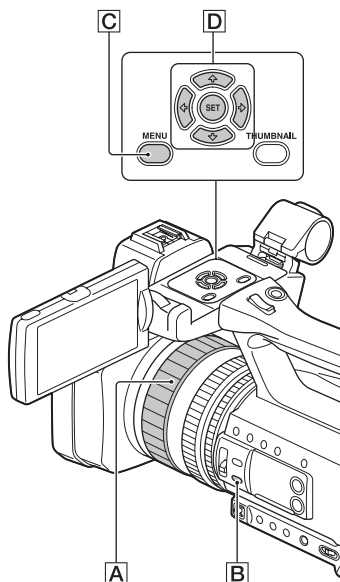

- To record a stationary subject using a tripod.



- 1** During recording or standby, press the **FOCUS AUTO/MAN button [B]** to set the focus to manual.

 appears.

- 2** Turn the focus ring **[A]** to adjust the focus.



 changes to  when the focus cannot be adjusted any farther, and changes to  when the focus cannot be adjusted any closer.

To adjust automatically

Press the **FOCUS AUTO/MAN button [B]** to set the focus to automatic.

 disappears and the automatic focus adjustment is restored.

💡 Tips

- The focal length information (the distance at which the subject is in focus; for when it is dark and hard to adjust the focus) appears for about 3 seconds in the following cases.
 - When you press the **FOCUS AUTO/MAN button [B]** to set the focus to manual and  appears on the LCD screen.
 - When you rotate the focus ring **[A]** while  is displayed.
- You can switch the focal length information between meters and feet ([**FOCUS DISPLAY**], p. 87).

Using the focus magnifier

The selected area on the LCD screen is magnified and displayed. This is useful when adjusting the focus.

[**FOCUS MAGNIFIER**] is assigned to the **ASSIGN5/FOCUS MAG** button (p. 58).

Adjusting the focus (Continued)

2 Press the ASSIGN5/FOCUS MAG button.

The center of the screen is magnified. The setting changes with each press of the button.

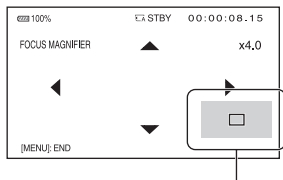

Enlarged display position

You can adjust the enlarged display position with the $\uparrow/\downarrow/\leftarrow/\rightarrow$ buttons on the camcorder. Press the SET button to set the enlarged display position back to the center.

Note

- Even though the image appears enlarged on the LCD screen, the recorded image is not enlarged.

Tip

- You can change the magnification ratio with [FOCUS MAG RATIO] (p. 86).

Focusing on a detected face (Face detection)

The camcorder detects faces and focuses on one of them (the default setting is [OFF]). [FACE DETECTION] is available only with automatic focus.

1 Press the MENU button \square .

2 Select \square (CAMERA SET) \rightarrow [FACE DETECTION] \rightarrow [ON] with the $\uparrow/\downarrow/\leftarrow/\rightarrow$ /SET button \square .

When the faces are detected, frames appear on the LCD screen.

3 Press the $\uparrow/\downarrow/\leftarrow/\rightarrow$ /SET button \square , move the selection cursor (orange colored frame) to select the priority face, then press the button again.

Selection cursor (orange colored frame)



Priority face frame (double frame)

The frame on the priority face changes to a double frame.

To cancel the priority face

Move the selection cursor (orange colored frame) onto the frame (double frame) on the priority face, using the $\uparrow/\downarrow/\leftarrow/\rightarrow$ /SET button \square , then press the button.

Notes

- Faces may not be detected depending on the recording environment, the condition of the subject or the settings.
- You may not be able to get the proper effect in some recording environments. If this happens, set [FACE DETECTION] to [OFF].
- The face detection function is disabled when using digital zoom or NIGHTSHOT.

Tips

- You can assign this function to an ASSIGN button (p. 58).
- To make it easy to detect faces, record under the following conditions:
 - Record in a moderately bright place
 - Do not obscure the face with a hat, mask, sunglasses, etc.
 - Face the front of the camera

Changing the recording setting

Selecting the file format and recording format

You can select the file format in [FILE FORMAT] and the recording format (bit-rate, image size, frame rate, and scanning system) in [REC FORMAT].

You can select either XAVC S 4K, XAVC S HD, or AVCHD in [FILE FORMAT].

Select the desired file format that best suits the shooting situation and playback equipment.

1 Press the MENU button.

2 Press the /SET button to select (REC/OUT SET) → [REC SET] → [FILE FORMAT] → the desired format.

3 Select (REC/OUT SET) → [REC SET] → [REC FORMAT] → a desired format with the /SET button.

Setting values

(Default setting in bold)

For XAVC S 4K
2160/25p 100Mbps
2160/25p 60Mbps

For XAVC S HD
1080/50p 50 Mbps
1080/25p 50 Mbps

For AVCHD
1080/50p PS
1080/50i FX
1080/50i FH
1080/50i HQ
1080/50i LP

1080/25p FX
1080/25p FH
720/50p FX
720/50p FH
720/50p HQ

About setting values

- Bit-rate
PS: max. 28 Mbps
FX: max. 24 Mbps
FH: approx. 17 Mbps (average)
HQ: approx. 9 Mbps (average)
LP: approx. 5 Mbps (average)
- Image size
2160: 3,840×2,160 (4K)
1080: 1,920×1,080 (PS, FX, FH),
1,440×1,080 (HQ, LP)
720: 1,280×720

- Frame rate
Either 50 or 25
- Scanning system
i: interlaced
p: progressive

If you select [1080/50i FX], for example, movies are recorded with following format.

- 1080: Effective scanning lines
- 50: Frame rate
- i: Scanning system
- FX: Recording mode

Tip

- When recording in DV, the recording format is fixed to 576/50i HQ.

Setting the output destination when recording in 4K mode

You can select the output for the video signal when recording in XAVC S 4K.

1 Press the MENU button.

2 Select **↔** (REC/OUT SET) → [VIDEO OUT] → [OUTPUT SELECT] → [4K REC OUTPUT] with the **↕/↗/↘/↙/SET** button.

3 Select [VF/LCD PANEL] or [EXTERNAL OUTPUT] using the **↕/↗/↘/↙/SET** button, then press the button.

Selection values:

VF/LCD PANEL: Viewfinder/LCD screen

EXTERNAL OUTPUT: External output selected in [OUTPUT SELECT].

The picture being recorded is not displayed on the viewfinder/LCD screen when [4K REC OUTPUT] is set to [EXTERNAL OUTPUT].

🔍 Notes

- The [4K REC OUTPUT] settings are enabled only when [FILE FORMAT] is set to [XAVC S 4K] in the REC/OUT SET menu.
- Any one of the following functions can be used while recording in XAVC S 4K.
 - External output while recording
 - Face detection function

Setting DV MODE (DV mode)

You can record/play back in DV mode of standard image quality.

1 Press the MENU button.

2 Select **↔** (REC/OUT SET) → [REC SET] → [DV MODE] → [YES] with the **↕/↗/↘/↙/SET** button.

The camcorder restarts in DV mode.

Functions not available in DV mode

- Slow & Quick Motion recording
- Protecting recorded movies (Protect)
 - [PROTECT] is not displayed in the menu.
- Dividing a movie
 - [DIVIDE] is not displayed in the menu.

🔍 Note

- When DV mode is selected, the audio format is fixed to LPCM.

Available menus in DV mode only

- ↔** (REC/OUT SET)
 - **DV** WIDE REC
 - CANCEL DV MODE

🔍 Note

- When you switch from DV mode to another, settings made in DV mode are initialized. If a movie file exceeds 2 GB during recording, the camcorder divides the recording into separate files by creating a new file(s) automatically. However, the divided files are displayed as a single movie on the screen of the camcorder.

Canceling DV mode

- ① Press the MENU button.
- ② Select **↔** (REC/OUT SET) → [REC SET] → [CANCEL DV MODE] → [YES] with the **↕/↗/↘/↙/SET** button.

When DV mode is canceled, the following settings return to the default.

- S&Q MOTION
- REC SET
- AVCHD AUDIO FORMAT

Adjusting the brightness

You can adjust the image brightness by adjusting the iris, gain or shutter speed, or by adjusting the light volume with the ND filter switch **B**.

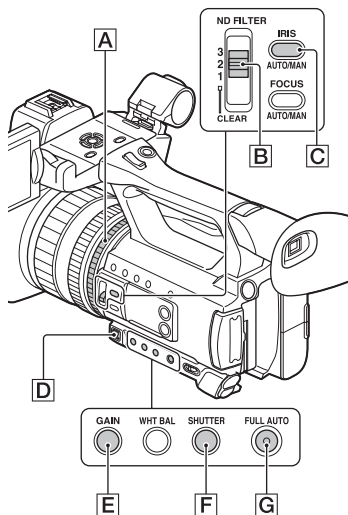

Note

- When you set the FULL AUTO button **G** on, the iris, gain, shutter speed, and white balance are adjusted automatically. You cannot adjust them manually.

Adjusting the iris

This is handy for making the background blurred or sharp.

1 Press the FULL AUTO button **G** to set auto mode off.

The FULL AUTO button lamp turns off.

2 Press the IRIS AUTO/MAN button **C** to set the iris to manual.

The **A** next to the iris value disappears.

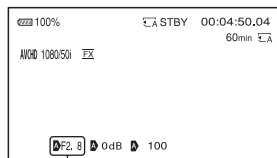

Iris value

3 Turn the iris ring **A** to adjust the value.

The volume of the light increases the more that you open the aperture (decreasing F value). The volume of the light decreases the more that you close the aperture (increasing F value).

To temporarily adjust the iris automatically

If the [IRIS PUSH AUTO] function has been assigned to an ASSIGN button (p. 58), press and hold the button to adjust the iris automatically.

To adjust automatically

Press the IRIS AUTO/MAN button **C** when the **A** mark beside the iris value is not displayed.

The iris value disappears or **A** appears next to the iris value.

Adjusting the gain

You can use this if you do not want to increase the value by AGC (automatic gain control).

1 Press the FULL AUTO button **[G]** to set auto mode off.

The FULL AUTO button lamp turns off.

2 Press the GAIN button **[E]**.

The **[A]** next to the gain value disappears, and the gain value is highlighted.

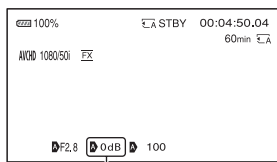

Gain value

3 Adjust the value using the manual lever **[D]**.

Setting values:

33dB, 30dB, 27dB, 24dB, 21dB, 18dB, 15dB, 12dB, 9dB, 6dB, 3dB, 0dB (default), -3dB

To adjust automatically

Press the GAIN button **[E]** while the gain value is highlighted.

The gain value disappears, or **[A]** appears next to the gain value.

Adjusting the shutter speed

You can adjust and fix the shutter speed manually. You can make a moving subject look still or emphasize the movement of a subject by adjusting the shutter speed.

1 Press the FULL AUTO button **[G]** to set auto mode off.

The FULL AUTO button lamp turns off.

2 Press the SHUTTER button **[F]**.

The **[A]** next to the shutter speed value disappears, and the shutter speed value is highlighted.

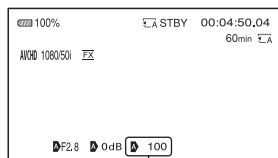

Shutter speed value

3 Adjust the value using the manual lever **[D]**.

Selection range:

You can select from 1/6 to 1/10000.

The denominator of the set shutter speed appears on the LCD screen. For example, [100] appears on the LCD screen when you set the shutter speed to 1/100 second. The larger the value on the LCD screen is, the faster the shutter speed is.

Adjusting the brightness (Continued)

Tips

- It is difficult to focus automatically at a lower shutter speed. Manual focusing with your camcorder attached to a tripod is recommended.
- When recording under fluorescent lamps, sodium lamps, or mercury lamps, the picture may flicker or change colors, or may have horizontal bands of noise.
You may be able to improve the situation by adjusting the shutter speed to 1/50 if the power frequency of your area is 50 Hz, or 1/60 in a 60 Hz area.
- You can switch the shutter speed display between seconds and degrees ([SHUTTER DISPLAY], p. 87).

To adjust automatically

Press the SHUTTER button **[F]** while the shutter speed value is highlighted. The shutter speed value disappears, or **[A]** appears next to the shutter speed value.

Adjusting the volume of light (ND filter)

You can record a subject clearly by using the ND filter switch **[B]** when the recording environment is too bright.

The ND filters 1, 2 and 3 reduce the volume of light to about 1/4, 1/16 and 1/64, respectively.

If **ND1** flashes during the iris automatic adjustment, set the ND filter to 1. If **ND2** flashes during the iris automatic adjustment, set the ND filter to 2. If **ND3** flashes during the iris automatic adjustment, set the ND filter to 3.

The ND filter indicator will stop flashing and remain on the screen.

If **NDOFF** flashes, set the ND filter **[B]** to "CLEAR." The ND filter icon will disappear from the screen.

Notes

- If you change the ND filter switch **[B]** during recording, the movie and sound may become distorted.
- When adjusting the iris manually, the ND filter icon does not flash even if the light volume should be adjusted with the ND filter.
- If the camcorder cannot detect the ND filter position (CLEAR/1/2/3), **ND** flashes on the screen. Make sure that the ND filter is set correctly.

Tip

- While recording a bright subject, diffraction may occur if you close the aperture further down, resulting in a fuzzy focus (this is a common phenomenon with video cameras). The ND filter switch **[B]** suppresses this phenomenon and gives better recording results.

Adjusting the color tone

Adjusting the white balance

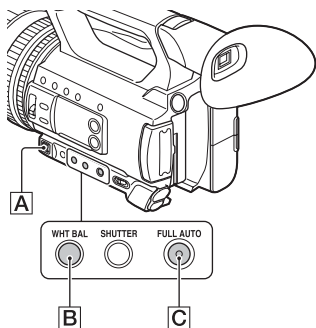

You can adjust and fix the white balance according to the lighting conditions of recording environment.

You can store white balance values in memory A (☞ A) and memory B (☞ B), respectively. Unless a white balance is readjusted, values will remain even after the power has been turned off.

When you select PRESET, [OUTDOOR], [INDOOR] or [MANU WB TEMP] is selected, according to which one you previously set with [WB PRESET] in the ☞ (CAMERA SET) menu.

💡 Tip

- You can assign [WB PRESET] to an ASSIGN button (p. 58).

1 Press the FULL AUTO button [C] to set auto mode off.

The FULL AUTO button lamp turns off.

2 Press the WHT BAL button [B].

The white balance value is highlighted.

3 Select PRESET, A, or B using the manual lever [A].

■ Setting the A/B value

Select A or B for recording with the white balance setting stored in memory A or B.

■ To use the PRESET value of white balance

Select ☞ (CAMERA SET) → [WB PRESET] and select a desired setting.

Setting values:	Example of recording conditions
Outdoor ([OUTDOOR])	<ul style="list-style-type: none">• When recording a night scene, neon lighting, fireworks, etc.• When recording a sunrise, sunset, etc.• Under daylight fluorescent lamp
Indoor ([INDOOR])	<ul style="list-style-type: none">• Where lighting conditions change, such as at a party place, etc.• Under video light, such as in a studio, etc.• Under a sodium or mercury lamp
Color temperature setting ([MANU WB TEMP])	<ul style="list-style-type: none">• You can set a desired color temperature between 2300K and 15000K with ☞ (CAMERA SET) → [WB TEMP SET] (default setting is 6500K).

To save the adjusted white balance value in memory A or B

- ① Press the FULL AUTO button [C] to set auto mode off.

Adjusting the color tone (Continued)

- Press the WHT BAL button **[B]** to highlight the white balance value.
- Select A (**[A]**) or B (**[B]**) using the manual lever.
- Press the MENU button.
- Press the **[UP]/[DOWN]/[LEFT]/[RIGHT]/[SET]** buttons to select **[CAMERA SET]** → **[WB SET]**.
- Frame a white object such as a piece of paper that fills the screen under the same lighting conditions as your subject.
- Press the SET button.
The adjusted value is stored in **[A]** or **[B]**. The stored color temperature appears for about 3 seconds.

Tip

- [WB SET]** is assigned to the ASSIGN1/WB SET button. The adjusted value is stored by pressing the ASSIGN1/WB SET button when the shooting screen is displayed, instead of performing step ④ to ⑦.

Note

- When a white balance adjustment value has not been obtained successfully, **[A]** or **[B]** starts flashing slowly. Adjust the subject appropriately and set the shutter speed to auto or around 1/50, then try adjusting the white balance again.

To restore automatic adjustment

Press the WHT BAL button **[B]**.

Note

- When you turn the FULL AUTO button **[C]** on, all other manual adjustments (iris, gain, and shutter speed) are also released.

Audio setup

The jacks, switches and dials shown below allow you to set the sound that is recorded. See page 5 for details about connecting a microphone.

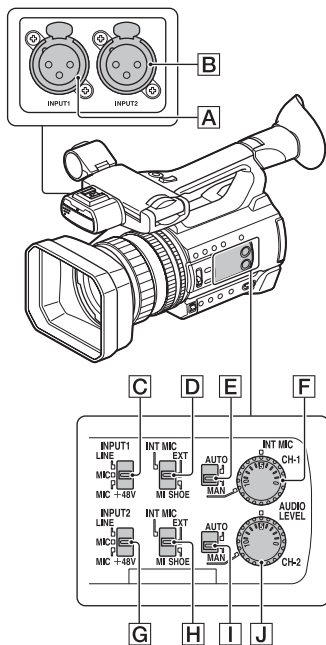

External audio input and selection

- [A]**: INPUT1 jack
- [B]**: INPUT2 jack
- [C]**: INPUT1 (LINE/MIC/MIC+48V) switch
- [G]**: INPUT2 (LINE/MIC/MIC+48V) switch

Audio source switches

- [D]**: CH-1 (INT MIC/EXT/MI SHOE) switch
- [H]**: CH-2 (INT MIC/EXT/MI SHOE) switch

Audio level controls

E: AUTO/MAN (CH-1) switch

I: AUTO/MAN (CH-2) switch

F: AUDIO LEVEL (CH-1) dial

J: AUDIO LEVEL (CH-2) dial

Recording sound from the internal microphone

You can record sound in stereo using the camcorder's internal microphone.

Internal microphone

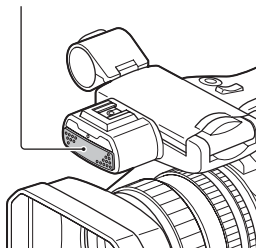

- 1 Set the CH-1 (INT MIC/EXT/MI SHOE) switch **D** and CH-2 (INT MIC/EXT/MI SHOE) switch **H** to "INT MIC."

Tips

- If the audio level is too low, set [INT MIC SENS] to [HIGH].
- To reduce wind noise, set [INT MIC WIND] to [ON].
- If the internal microphone is selected for both channels 1 and 2 (CH-1: INT MIC, CH-2: INT MIC), the sound that is output from the headphones during recording and standby will have weaker stereo effect than the sound that is actually recorded.

Recording sound from an external audio device

Use the following procedure if using a microphone or external audio device.

1 Select the audio input source.

- Set the INPUT1/INPUT2 (LINE/MIC/MIC+48V) switch (**C** or **G**) based on the device connected to INPUT1 jack **A**/INPUT2 jack **B**.
- To record using a microphone, select "MIC" or "MIC+48V." See page 5 for details about connecting a microphone.

Connected device	Switch position
External audio device (such as mixer)	LINE
Dynamic microphone or microphone with built-in battery	MIC
+48V powered (phantom power) microphone	MIC+48V

Notes

- If the switch is set to MIC+48V and you connect a device that is not compatible with +48V power, it may damage the connected device. Check the switch before connecting the device.
- To prevent unwanted noise when no audio device is connected to the INPUT1 or INPUT2 jack, set the INPUT1/INPUT2 (LINE/MIC/MIC+48V) switch (**C** or **G**) to "LINE."

2 Set the CH-1 (INT MIC/EXT/MI SHOE) switch **D** and CH-2 (INT MIC/EXT/MI SHOE) switch **H** to "EXT."

- If [INPUT CH SELECT] is set to [INPUT1/INPUT2] in the [XLR SET] menu, the audio input on the INPUT1 and INPUT2 jacks are recorded for CH-1 and CH-2, respectively.

Audio setup (Continued)

- If [INPUT CH SELECT] is set to [INPUT1/INPUT1] in the [XLR SET] menu, the audio input on the INPUT1 jack is recorded to both CH-1 and CH-2.

[XLR SET] > [INPUT CH SELECT] setting	Sound recorded to CH-1 and CH-2
INPUT1/ INPUT2	INPUT1 → CH1 INPUT2 → CH2
INPUT1/ INPUT1	INPUT1 → CH1 └→ CH2

3 Set the input level of the external audio device.

When the INPUT1/INPUT2 (LINE/MIC/MIC+48V) switch (**C** or **G**) is set to “MIC” or “MIC+48V,” the XLR microphone input level can be set using [INPUT1 TRIM]/[INPUT2 TRIM] in the menu (p. 83). Adjust the setting based on the sensitivity of the microphone.

Tip

- When using a stereo microphone that has two XLR plugs, connect the left channel (L) to the INPUT1 jack **A** and the right channel (R) to the INPUT2 jack **B**, then set the CH-1 (INT MIC/EXT/MI SHOE) switch **D** and CH-2 (INT MIC/EXT/MI SHOE) switch **H** to “EXT.”

Recording sound from a Multi Interface Shoe compatible microphone (sold separately)

You can record sound in stereo using a Multi Interface Shoe compatible microphone.

1 Connect the Multi Interface Shoe compatible microphone (sold separately) to the Multi Interface Shoe.

2 Set the CH-1 (INT MIC/EXT/MI SHOE) switch **D** and CH-2 (INT MIC/EXT/MI SHOE) switch **H** to “MI SHOE.”

Adjusting the recording level

When the CH-1 and CH-2 switches are both set to “INT MIC,” both the left and right channels are adjusted by the CH-1 switch/dial.

1 Set the AUTO/MAN switch for the channel that you want to adjust (CH-1 **E** or CH-2 **I**) to “MAN.”

 **M**₁ appears on the screen.

2 Turn the AUDIO LEVEL dial (CH-1 **F** or CH-2 **J**) to adjust the audio level.

Use headphones or an audio level meter to check that the audio level is appropriate.

To restore automatic adjustment

Set the AUTO/MAN switch for the adjusted channel (CH-1 **E** or CH-2 **I**) after manual adjustment to “AUTO.”

Useful functions

Selecting suitable settings automatically (auto mode setting)

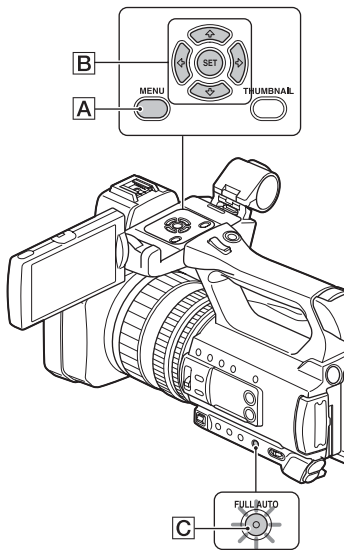

You can make optimal recordings in various situations.



1 Press the FULL AUTO button **C** to set auto mode on.

The FULL AUTO button lamp turns on.

2 Press the MENU button **A**.



3 Select  (CAMERA SET) → [AUTO MODE SET] with the /SET button **B**.







4 Press the /SET button **B**, select [AUTO], [INTELLIGENT AUTO], or [SCENE SELECTION], and press the button again.



Note

- When you select [INTELLIGENT AUTO], [STEADYSHOT] is set to [ACTIVE], and the angle of view shifts 1.08 times toward the telephoto side.



Scenes detected by INTELLIGENT AUTO



Face detection:  (Portrait),  (Baby)

Scene detection:  (Backlight),  (Landscape),  (Night Scene),  (Spotlight),  (Low Light),  (Macro)





Camera-shake detection:  (Walk),  (Tripod)

To use [SCENE SELECTION]

- Press the MENU button **A**, press the /SET button **B** and select  (CAMERA SET) → [SCENE SELECTION SET], then press the button again.
- Press the /SET button **B**, select the desired setting, then press the button again.

Setting values	Recording conditions
 Night Scene* ([NIGHT SCENE])	Shoots a night view with a proper exposure, using a tripod (sold separately).
 Sunrise & Sunset* ([SUNRISE & SUNSET])	Shoots the scenes under the glow of sunset/sunrise vividly.
 Fireworks* ([FIREWORKS])	Shoots fireworks with optimal exposure.

Useful functions (Continued)

Setting values	Recording conditions
 Landscape* ([LANDSCAPE])	Shoots distant subjects clearly. This setting also prevents your camcorder from focusing on any glass or mesh in windows between the camcorder and the subject.
 Portrait ([PORTRAIT])	Brings out the subject, such as people or flowers, while creating a soft background.
 Spotlight ([SPOTLIGHT])	Prevents people's faces from appearing excessively white when subjects are lit by strong light.
 Beach ([BEACH])	Takes the vivid blue of the ocean or a lake.

* Focuses on only distant subjects.

Shooting in dimly lit locations (LOW LUX)

You can shoot bright video, even in low light conditions, such as outdoor locations with limited street lighting or dimly lit indoors, by automatically optimizing the gain and shutter speed.

Note

This function is available only when FULL AUTO is turned on and [AUTO MODE SET] is set to "AUTO."

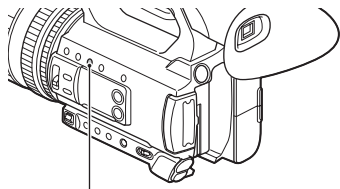

LOW LUX button

1 Press the FULL AUTO button to set auto mode on.

The FULL AUTO button lamp turns on.

2 Press the ASSIGN3/LOW LUX button.

-  is displayed.
- To cancel, press the ASSIGN3/LOW LUX button again.

Shooting in dark conditions (NIGHTSHOT)

You can shoot scenes under very dark conditions.

Note

This function is available only when FULL AUTO is turned on.

1 Press the FULL AUTO button to set auto mode on.

The FULL AUTO button lamp turns on.

2 Assign [NIGHTSHOT] to an ASSIGN button (p. 58).

3 Press the ASSIGN button.

-  is displayed.
- To cancel, press the ASSIGN button again.

Notes

- NIGHTSHOT uses infrared light. Make sure that your finger does not cover the infrared light emitter when shooting.
- Do not use NIGHTSHOT in bright conditions. Doing so may damage the camcorder.

Customizing the picture quality (Picture profile)

You can customize the picture quality by adjusting picture profile items such as [GAMMA] and [DETAIL]. You can make adjustments for the time of day, weather conditions, or just personal preference. Connect your camcorder to a TV or monitor, and adjust the picture quality while observing the picture on the TV or monitor screen.

Picture quality settings for different recording conditions have been stored in [PP1] through [PP6] as default settings.

Note

- [OFF] is set for the picture profile by default.

Picture profile number	Example setting
PP1	Example settings of a color tone with [STANDARD] gamma
PP2	Example settings of a color tone with [STILL] gamma
PP3	Example settings of natural color tone with [ITU-709] gamma
PP4	Example settings of a color tone that is faithful to [ITU-709]
PP5	Example settings of pictures recorded on cinema color negative film
PP6	Example settings of pictures screened with cinema color print film

1 Press the MENU button.

2 Select (CAMERA SET) → [PICTURE PROFILE] → the desired picture profile number using the $\uparrow/\downarrow/\leftarrow/\rightarrow$ /SET button, then press the button again.

3 Press the $\uparrow/\downarrow/\leftarrow/\rightarrow$ /SET button, select [OK], then press the button again.

You can record with the settings of the selected picture profile.

Tip

You can also select a picture profile by pressing an ASSIGN button assigned with [PICTURE PROFILE].

To cancel picture profile recording





Select [OFF] in step 2 with the $\uparrow/\downarrow/\leftarrow/\rightarrow$ /SET button, then press the button.

To change the picture profile

You can change the settings stored in [PP1] through [PP6].

- 1 In step 3, press the $\uparrow/\downarrow/\leftarrow/\rightarrow$ /SET button, select [SETTING], then press the button again.
- 2 Press the $\uparrow/\downarrow/\leftarrow/\rightarrow$ /SET button, select the item that you want to adjust, then press the button again.
- 3 Press the $\uparrow/\downarrow/\leftarrow/\rightarrow$ /SET button, adjust the picture quality, then press the button again.
- 4 Repeat steps 2 and 3 to adjust other items.
- 5 Press the $\uparrow/\downarrow/\leftarrow/\rightarrow$ /SET button, select [\hookrightarrow RETURN], then press the button again.

Useful functions (Continued)

- ⑥ Press the ////SET button, select [OK], then press the button again. The picture profile indicator is displayed.

BLACK LEVEL

To set the black level.

Item	Description and settings
	Sets the black level. -15 to +15

GAMMA

To select a gamma curve.

Item	Description and settings
[STANDARD]	Standard gamma curve
[STILL]	Gamma curve to create the tone of a still image.
[CINEMATONE1]	Gamma curve 1 for producing tone of film camera images
[CINEMATONE2]	Gamma curve 2 for producing tone of film camera images
[ITU709]	Gamma curve that corresponds to ITU-709. Gain in low intensity area: 4.5

Note

- There is no still image shooting mode on the camcorder.

BLACK GAMMA

To correct gamma in low intensity area.

Item	Description and settings
[RANGE]	Selects a correcting range. HIGH / MIDDLE / LOW
[LEVEL]	Sets the correcting level. -7 (maximum black compression) to +7 (maximum black stretch)

Useful functions (Continued)

KNEE

To set knee point and slope for video signal compression to prevent over-exposure by limiting signals in high intensity areas of the subject to the dynamic range of your camcorder.

When selecting [STANDARD] or [STILL] in [GAMMA], [KNEE] is set to off if [MODE] is set to [AUTO]. To use functions in [KNEE], set [MODE] to [MANUAL].

Item	Description and settings
[MODE]	Selects a mode either automatic or manual. [AUTO] : Sets the knee point and slope automatically. [MANUAL] : Sets the knee point and slope manually.
[AUTO SET]	Sets the maximum point and sensitivity in the automatic mode. [MAX POINT] : Sets the maximum point. 90% to 100% [SENSITIVITY] : Sets the sensitivity. HIGH / MIDDLE / LOW
[MANUAL SET]	Sets the knee point and slope manually. [POINT] : Sets the knee point. 75% to 105% [SLOPE] : Sets the knee slope. -5 (gentle) to +5 (steep) [KNEE] is set to off when you set to +5.

COLOR MODE

To set type and level of colors.

Item	Description and settings
[STANDARD]	Suitable colors when [GAMMA] is set to [STANDARD].
[STILL]	Suitable colors when [GAMMA] is set to [STILL].
[CINEMATONE1]	Film camera image-like colors good with [GAMMA] set to [CINEMATONE1].
[CINEMATONE2]	Film camera image-like colors good with [GAMMA] set to [CINEMATONE2].
[PRO]	Natural colors when [GAMMA] is set to [ITU-709].
[ITU709 MATRIX]	Colors that are faithful to the ITU-709 standard (when used with ITU-709 gamma).
[B/W]	Sets the saturation to 0 and records in black and white.

SATURATION

To set the color level.

Item	Description and settings
	-32 (light) to +32 (dark)

COLOR PHASE

To set the color phase.

Item	Description and settings
	-7 (greenish) to +7 (reddish)

COLOR DEPTH

To set the color depth for each color phase.

This function is more effective for chromatic colors and less effective for achromatic colors. The color looks deeper as you increase the setting value to more positive side, and lighter as you decrease the value to more negative side.

Item	Description and settings
[R]	-7 (light red) to +7 (deep red)
[G]	-7 (light green) to +7 (deep green)
[B]	-7 (light blue) to +7 (deep blue)
[C]	-7 (light cyan) to +7 (deep cyan)
[M]	-7 (light magenta) to +7 (deep magenta)
[Y]	-7 (light yellow) to +7 (deep yellow)

COLOR CORRECTION

To set the color correction.

Item	Description and settings
TYPE	Selects color correction type. [OFF]: Not correct colors. [COLOR REVISION]: Corrects colors stored in memory. Colors not stored in memory (displayed in black and white when [COLOR EXTRACT] is set) will not be corrected. [COLOR EXTRACT]: Displays areas in colors that are stored in the memory. The other areas are displayed in black and white. You can use this function to add effects to your movies or to confirm the colors to be stored in the memory.
MEMORY SELECTION	Selects a memory to enable. [1]: Enable memory 1 only. [2]: Enable memory 2 only. [1&2]: Enable both memory 1 and 2.

Useful functions (Continued)

Item	Description and settings
MEMORY1 COLOR	Sets colors stored in Memory 1. [PHASE]: Sets color phase. 0 (purple) to 8 (red) to 16 (yellow) to 24 (green) to 31 (blue) [PHASE RANGE]: Sets color phase range. 0 (no color selection), 1 (narrow: to select only a single color) to 31 (wide: to select multiple colors in similar color phase) [SATURATION]: Sets saturation. 0 (to select from light colors to dark colors) to 31 (to select dark color) [ONE PUSH SET]: Automatically sets [PHASE] for a subject at the center of the marker. [SATURATION] is set to 0.
MEMORY1 REVISION	Corrects colors in Memory 1. [PHASE]: Corrects the phase of the color in Memory 1. -15 to +15 (0 for no correction.) [SATURATION]: Corrects the saturation of the color in Memory 1. -15 to +15 (0 for no correction.)
MEMORY2 COLOR	Sets colors stored in Memory 2. See [MEMORY1 COLOR] for description and settings.
MEMORY2 REVISION	Corrects colors in Memory 2. See [MEMORY1 REVISION] for description and settings.

Tips

- Setting both memories to the same setting doubles the color correction effect.
- The settings of [COLOR CORRECTION] will be retained even if the power is turned off. However, if you want to correct colors that may change according to time of the day, weather, location, etc., it is recommended that you set [COLOR CORRECTION] again prior to recording.
- If you change the white balance value or the settings of [WB SHIFT], [SATURATION] or [COLOR PHASE] of the picture profile, the settings of [PHASE RANGE] and [PHASE] of the selected memory will change. When you change the white balance value or the settings of the above picture profile items after you have set [PHASE RANGE] and [PHASE], check the settings of [COLOR CORRECTION] prior to recording.
- During the automatic white balance adjustment, the white balance value automatically varies according to the lighting conditions of your recording environment. Manual white balance adjustment is recommended when you use [COLOR CORRECTION].

WB SHIFT

To set items for the white balance shift.

Items you can adjust differ depending on the filter type.

Item	Description and settings
[FILTER TYPE]	Selects a color filter type for the white balance shift. [LB-CC] : Film type (color conversion and correction) [R-B] : Video type (correction of R and B levels)
[LB[COLOR TEMP]]	Sets a color temperature offset value. -9 (bluish) to +9 (reddish)
[CC[MG/GR]]	Sets a color correct offset value. -9 (greenish) to +9 (magentish)
[R GAIN]	Sets an R level. -9 (low R level) to +9 (high R level)
[B GAIN]	Sets a B level. -9 (low B level) to +9 (high B level)

DETAIL

To set items for the detail.

Item	Description and settings
[LEVEL]	Sets the detail level. -7 to +7
[MANUAL SET]	[ON/OFF] : Turns on and off the manual detail adjustment. Set to [ON] to enable the manual detail adjustment (automatic optimization will not be performed).
	[V/H BALANCE] : Sets the vertical (V) and horizontal (H) balance of DETAIL. -2 (off to the vertical (V) side) to +2 (off to the horizontal (H) side)
	[B/W BALANCE] : Selects the balance of the lower DETAIL (B) and the upper DETAIL (W). TYPE1 (off to the lower DETAIL (B) side) to TYPE5 (off to the upper DETAIL (W) side)
	[LIMIT] : Sets the limit level of DETAIL. 0 (Low limit level: likely to be limited) to 7 (High limit level: not likely to be limited)
	[CRISPENING] : Sets the crispening level. 0 (shallow crispening level) to 7 (deep crispening level)
	[HI-LIGHT DETAIL] : Sets the DETAIL level in the high intensity areas. 0 to 4

Useful functions (Continued)















COPY

To copy the settings of the picture profile to another picture profile number.

RESET









To reset the picture profile to the default setting.

To copy the picture profile setting to another picture profile number

- ① Press the MENU button.
- ② Select  (CAMERA SET) → [PICTURE PROFILE] → the desired picture profile number using the ///SET button, then press the button again.
- ③ Press the ///SET button, then select [SETTING] → [COPY].
- ④ Press the ///SET button, select the picture profile number of the destination, then press the button again.
- ⑤ Press the ///SET button, then select [YES] → [ RETURN] → [OK].

To reset the picture profile settings













You can reset the picture profile settings by each picture profile number. You cannot reset all picture profile settings at once.

- ① Press the MENU button.
- ② Select  (CAMERA SET) → [PICTURE PROFILE] → the desired picture profile number using the ///SET button, then press the button again.
- ③ Press the ///SET button, then select [SETTING] → [RESET] → [YES] → [ RETURN] → [OK].

Setting time data

The camcorder records movies accompanied by time data, such as time code and user bit.

Setting the time code

- ① Press the MENU button, press the ///SET button and select  (TC/UB SET) → [TC PRESET], then press the button again.
- ② Press the ///SET button, select [PRESET], then press the button again.
- ③ Press the ///SET button, select the first two digits, then press the button again. You can set the time code within the following range.
00:00:00:00 to 23:59:59:24
- ④ Set other digits by repeating step ③.
- ⑤ Press the ///SET button, select [OK], then press the button again.











To reset the time code

Select [RESET] in step ② of “Setting the time code” to reset the time code (00:00:00:00).

To reset the time code using the Wireless Remote Commander

Press the TC RESET button on the Wireless Remote Commander to reset the time code (00:00:00:00).

Setting the user bits

- ① Press the MENU button, press the ///SET button and select  (TC/UB SET) → [UB PRESET], then press the button again.
- ② Press the ///SET button, select [PRESET], then press the button again.
- ③ Press the ///SET button, select the first two digits, then press the button again.
- ④ Set other digits by repeating step ③.

- ⑤ Press the **▲/▼/◀/▶/SET** button, select [OK], then press the button again.

To reset the user bits

Select [RESET] in step ② of “Setting the user bits” to reset the user bits (00 00 00 00).

Recording with the Slow & Quick Motion function

By recording with a frame rate that is different from the playback frame rate, you can record images to be played back as slow motion or quick motion images. The images recorded with the Slow & Quick Motion function will appear smoother than slow or fast-forward playback of images recorded at normal speed. You can use Slow & Quick Motion function with AVCHD.

Playback speed

The playback speeds based on the recording format and frame rate setting are as follows.

FRAME RATE	REC FORMAT	
	1080/25p	1080/50p
50	50% slow	100% (standard)
25	100% (standard)	200% quick
12	208% quick	417% quick
6	417% quick	833% quick
3	833% quick	1667% quick
2	1250% quick	2500% quick
1	2500% quick	5000% quick

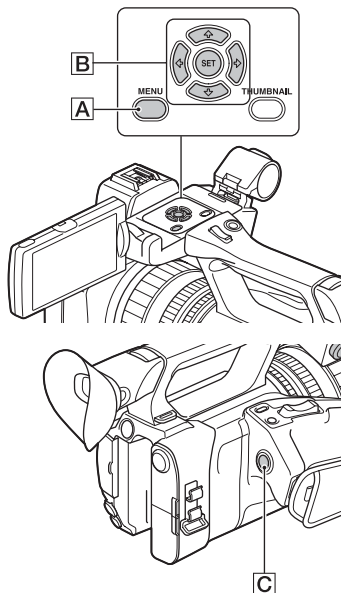

Notes

- For details about the recording media that can be used to record with Slow & Quick Motion, see page 26.
- When recording with the Quick Motion recording function, your camcorder may continue recording for some time (approximately 30 seconds at most) after you press the button to stop recording. Do not operate your camcorder while the [REC] indicator is flashing on the screen, and wait till it turns to [STBY].
- After you press the button to stop recording, your camcorder continues recording till it completes writing of the minimum unit of data (0.5 seconds of replay time).

Useful functions (Continued)

Preparation

You must set the recording format and frame rate.

- ① Press the MENU button **[A]**.
- ② Select **[CAMERA SET]** → [S&Q MOTION] → [REC FORMAT] with the **[↑/↓/←/→/SET]** button **[B]**.
- ③ Select a recording format.
Setting values:
1080/50p PS, 1080/25p FX,
1080/25p FH
- ④ Select [FRAME RATE] with the **[↑/↓/←/→/SET]** button **[B]**, and set the desired frame rate.
Setting values:
50fps, 25fps, 12fps, 6fps, 3fps, 2fps,
1fps
- ⑤ Select [↩ RETURN].

Recording in Slow & Quick Motion mode

- ① Press the **[↑/↓/←/→/SET]** button **[B]** to select **[CAMERA SET]** → [S&Q MOTION] → [EXECUTE], or assign [S&Q MOTION] to an ASSIGN button and then press the ASSIGN button.
- ② Press the START/STOP button **[C]**.
Slow & Quick Motion recording starts.

To stop Slow & Quick Motion recording

Press the START/STOP button **[C]**.

To change the frame rate setting

Hold the ASSIGN button down for about 1 second, then change the value with the **[↑/↓/←/→/SET]** button **[B]**.

Holding the ASSIGN button down again for about 1 second restores the previous setting.

To cancel Slow & Quick Motion recording

Press the ASSIGN button or the MENU button **[A]** during standby.

Notes

- When you are recording with a slow frame rate, the camcorder may continue recording for a few more seconds after you press the START/STOP button to stop recording.
- You cannot change the frame rate during Slow & Quick Motion recording. To change the frame rate, first stop Slow & Quick Motion recording.
- The time code is recorded in [REC RUN] mode during Slow & Quick Motion recording (p. 89).
- Slow & Quick Motion mode is automatically canceled when the camcorder is turned off, but the frame rate setting is retained.
- You cannot record sound during Slow & Quick Motion recording.
- You cannot use the Slow & Quick Motion function for simultaneous recording.
- You cannot use the Slow & Quick Motion function with XAVC S (HD/4K) or DV.
- You cannot use the Slow & Quick Motion function when FULL AUTO is turned on.

Reviewing the most recently recorded scene (Last Scene Review)

You can review the most recently recorded scene on the LCD screen.

[LAST SCENE REVIEW] is assigned to the ASSIGN4/LAST SCENE button (p. 58).

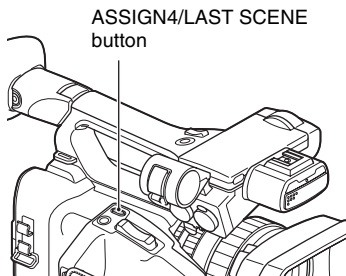

After you stop recording, press the ASSIGN4/LAST SCENE button.

The camcorder plays from the start to the end of the most recently recorded scene, then returns to standby mode.

To stop reviewing the last scene

Press the ASSIGN4/LAST SCENE button during playback. The camcorder returns to standby mode.

 Note

- If you edit the movie or remove the recording media after you stop recording, the Last Scene Review function may not work correctly.

Assigning functions to the ASSIGN buttons

Some functions can be assigned to the ASSIGN buttons.

You can assign a single function to each of the ASSIGN1 to 5 buttons.

See “Menu items” (p. 74) on the function of each item.

- DATA CODE (p. 87)
- TC/UB DISPLAY (p. 88)
- STATUS CHECK (p. 64)
- REC LAMP (p. 91)
- THUMBNAIL (p. 60)

Default function of each ASSIGN button

- ASSIGN1: WB SET (p. 41)
- ASSIGN2: STATUS CHECK (p. 64)
- ASSIGN3: LOW LUX (p. 46)
- ASSIGN4: LAST SCENE REVIEW (p. 56)
- ASSIGN5: FOCUS MAGNIFIER (p. 33)

Functions you can assign to the ASSIGN buttons

- – (no function)
- LOW LUX (p. 46)
- FOCUS MAGNIFIER (p. 33)
- LAST SCENE REVIEW (p. 56)
- WHT BAL (p. 41)
- WB PRESET (p. 77)
- WB SET (p. 41)
- AE SHIFT (p. 78)
- D. EXTENDER (p. 78)
- STEADYSHOT (p. 79)
- S&Q MOTION (p. 55)
- AUTO MODE SET (p. 45)
- SCENE SELECTION SET (p. 45)
- NIGHTSHOT (p. 46)
- IRIS PUSH AUTO (p. 38)
- FACE DETECTION (p. 34)
- COLOR BAR (p. 80)
- PICTURE PROFILE (p. 47)
- VOLUME (p. 82)
- HISTOGRAM (p. 84)
- ZEBRA (p. 85)
- PEAKING (p. 85)
- MARKER (p. 85)
- CAMERA DATA DISPLAY (p. 86)
- AUDIO LEVEL DISPLAY (p. 87)

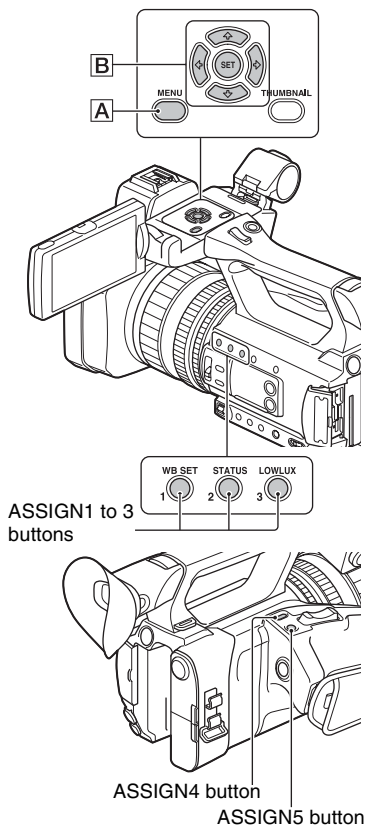

1 Press the MENU button **A**.

2 Select **OTHERS** → [ASSIGN BUTTON] with the **UP/DOWN/LEFT/RIGHT/SET** button **B**.

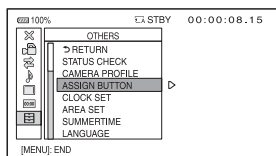

3 Press the **UP/DOWN/LEFT/RIGHT/SET** button **B**, select the ASSIGN button that you want to set, then press the button again.

4 Press the **UP/DOWN/LEFT/RIGHT/SET** button **B**, select the function that you want to assign, then press the button again.

5 Press the **UP/DOWN/LEFT/RIGHT/SET** button **B**, select [OK], then press the button again.

Playback

THUMBNAIL button

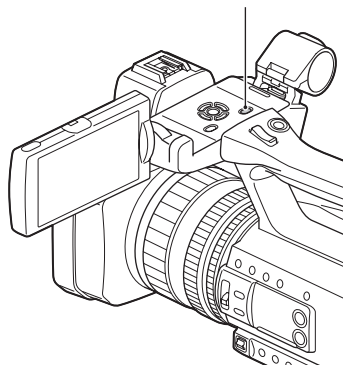

Playing back movies

- 1 Open the LCD panel.

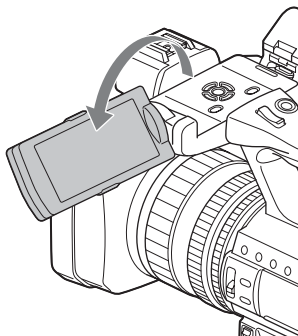

2 Press the THUMBNAIL button.

The thumbnail screen appears after a few seconds.

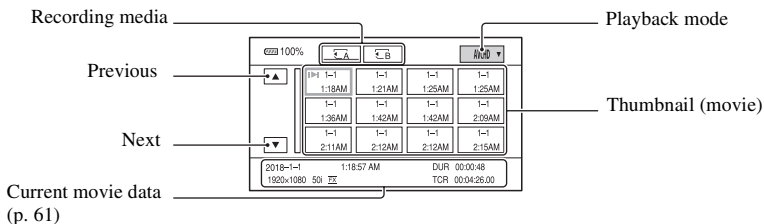

•You can turn on or off the date and time display on the thumbnails by pressing the DISPLAY button.

3 Play back movies.

① Select the recording media you want to play using the $\leftarrow/\rightarrow/\leftarrow/\rightarrow$ /SET button, then press the SET button

\leftarrow A : Memory card A

\leftarrow B : Memory card B

② Select the playback mode using the $\leftarrow/\rightarrow/\leftarrow/\rightarrow$ /SET buttons.

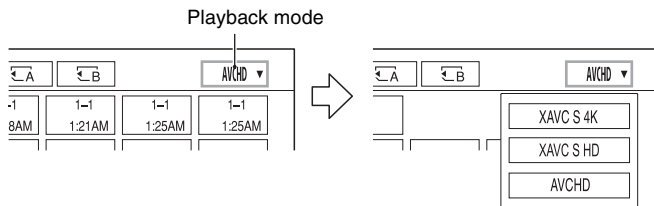

③ Select the thumbnail you want to play using the $\leftarrow/\rightarrow/\leftarrow/\rightarrow$ buttons, and press the SET button. Selecting the thumbnail will show information about the movie in the lower part of the LCD screen.

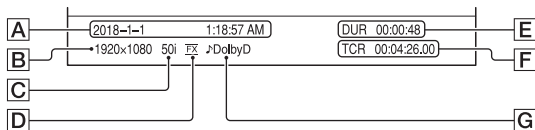

- A** Date and time of recording start
- B** Resolution
- C** Frame rate
- D** Recording mode

Playback (Continued)

E Duration

F Time code of recording start

Time code will not be displayed correctly when you play back recording media with no time code, or recording media with time code that your camcorder does not support.

G DOLBY DIGITAL recording

Displayed when audio is recorded in Dolby Digital format.

- **I** appears with the movie that has been most recently played back or recorded. Selecting it will continue playback from the previous time.

Your camcorder starts playing the selected movie.

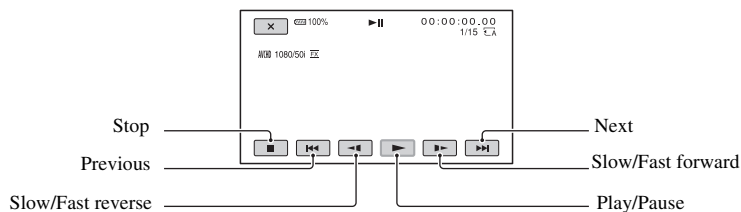

Note

- Movie files recorded in DV mode can only be played back when the camcorder is set to DV mode.

Tips

- When playback from the selected movie reaches the last movie, the screen returns to the thumbnail screen.
- Select **I** during pause to play back movies slowly.
- The playback speed increases based on the number of times that you select **⏏**.
- In DV mode, SCAN/SLOW buttons are disabled.
- In DV mode, fast forward and fast reverse during playback are 5 times faster than normal playback speed.
- When you play back a DV file recorded with a camcorder other than this camcorder, the F value may not be displayed correctly.

To adjust the volume

Press the MENU button and select **🎵** (AUDIO SET) → [VOLUME] to adjust the volume.

To return to the recording mode

Press the THUMBNAIL button.

On playing back movies

- Movies recorded using this camcorder may not be played back normally on devices other than this camcorder. Also, movies recorded on other devices may not play back properly on this camcorder.
- DV movies recorded on SD memory cards cannot be played on A/V devices of other manufacturers.

Changing/checking the settings in your camcorder

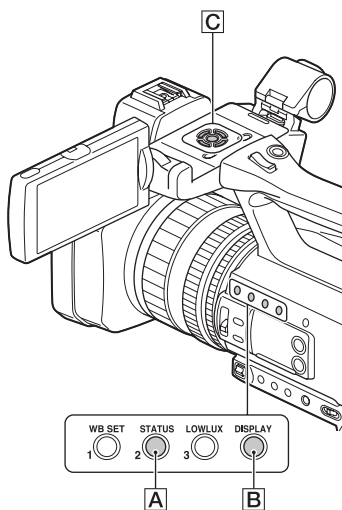

Changing the screen display

You can display information such as time code, etc., on the image.

Press the **DISPLAY** button **B**.

The screen indicators turn on (displayed) ↔ off (not displayed) each time you press the button. In recording mode, the screen changes in the order, detailed display → simple display → no display with each press of the button.

Tip

- You can display the screen indicators during playback on a TV by setting [DISPLAY OUTPUT] to [ALL OUTPUT] (p. 88).

Displaying recording data (Data code)

You can display information, including date, time and camera data automatically stored during recording on the screen during playback.

Select **DISP** (**DISPLAY SET**) → **DATA CODE** and choose the data that you want to display, or press the **ASSIGN** button to which the **DATA CODE** function is assigned, during playback or pause.

The screen changes in the order, date and time display → camera data display → no display with each press of the button.

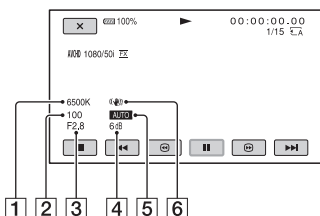

- White balance
PWB will appear during the playback of movies recorded with [MANU WB TEMP].
- Shutter speed
- Iris
- Gain
- Exposure
AUTO appears during playback of the movie recorded with the iris, gain, and shutter speed automatically adjusted.
MANUAL appears during playback of the movie recorded with the iris, gain, and shutter speed manually adjusted.

Changing/checking the settings in your camcorder (Continued)

6 Camera shake correction (Steady Shot)

Note

- When you play back the memory card on other devices, the camera data may be displayed incorrectly. Confirm the correct camera data on your camcorder.

Checking the settings in your camcorder (Status check)

You can check the settings of the following items.

- Audio setup (p. 82)
- Output signal setup (p. 81)
- Functions assigned to the ASSIGN buttons (p. 58)
- Camera setup (p. 77)
- Record button setup (p. 31)
- Recording media information
- Battery Info

Record button setup

You can check the record button setting.

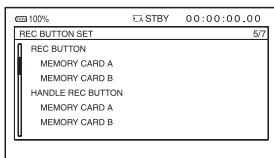

Recording media information

You can check the estimated used and free spaces.

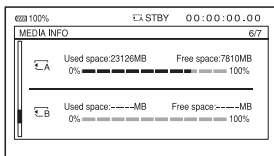

Battery Info

You can check the remaining capacity of the attached battery.

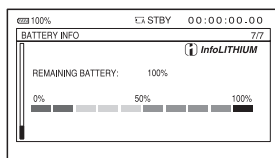

[STATUS CHECK] is assigned to the ASSIGN2/STATUS button **A** (p. 58).

1 Press the ASSIGN2/STATUS button **A**.

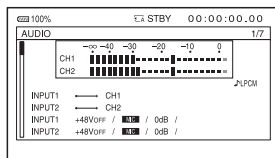

2 Press the **↑/↓/←/→/SET** button **C** to display the items.

Switches in the order AUDIO → OUTPUT → ASSIGN → CAMERA → REC BUTTON SET → MEDIA INFO → BATTERY INFO.

Setup items are displayed according to the settings of the camcorder when it is turned on.

To hide the display

Press the ASSIGN2/STATUS button **A**.

Connecting to a monitor or a TV

Playback image quality depends on the type of monitor or TV, and the jacks used to make the connection.

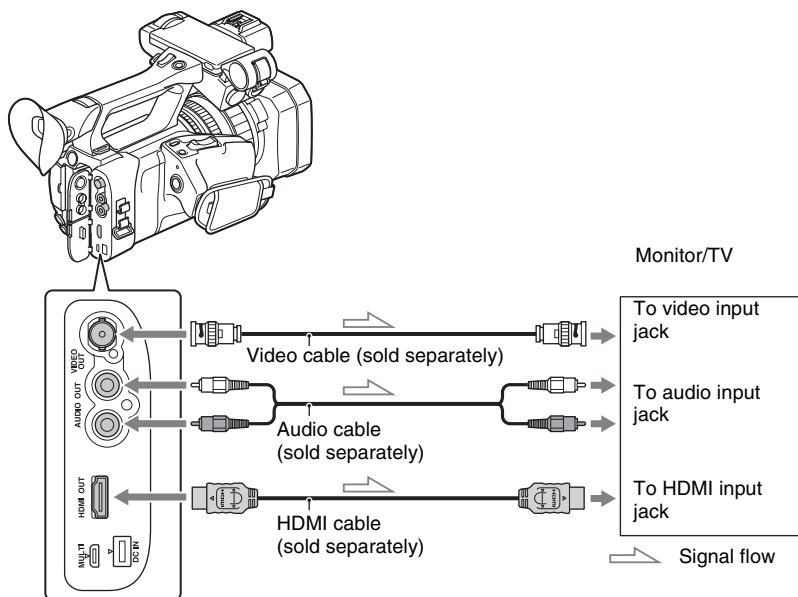

Notes

- Video signals cannot be output from HDMI OUT and VIDEO OUT jacks simultaneously.
- The output resolution of VIDEO OUT is 576i.

Connecting to a monitor or a TV (Continued)

Output resolution

The output resolution varies depending on the recording mode and [HDMI] setting.

XAVC S 4K

Menu item			
Recording format	HDMI	HDMI OUT	VIDEO OUT
REC/OUT SET> REC SET> REC FORMAT	REC/OUT SET> VIDEO OUT>HDMI		
2160/25p	2160p/1080p/576i	2160/25p	576i
	2160p/720p/576i		
	2160p/1080i/576i		
	1080p/576i	1080/50p	
	720p/576i	720/50p	
	1080i/576i	1080/50i	
	576p	576/50p	
	576i	576/50i	

XAVC S HD/AVCHD

Menu item			
Recording format	HDMI	HDMI OUT	VIDEO OUT
REC/OUT SET> REC SET> REC FORMAT	REC/OUT SET> VIDEO OUT>HDMI		
All recording formats	2160p/1080p/576i	1080/50p	576i
	2160p/720p/576i	720/50p	
	2160p/1080i/576i	1080/50i	
	1080p/576i	1080/50p	
	720p/576i	720/50p	
	1080i/576i	1080/50i	
	576p	576/50p	
	576i	576/50i	

DV Mode

Menu item	HDMI	HDMI OUT	VIDEO OUT
REC/OUT SET> REC SET> REC FORMAT	REC/OUT SET> VIDEO OUT>HDMI		
All recording formats	2160p/1080p/576i 2160p/720p/576i 2160p/1080i/576i 1080p/576i 720p/576i 1080i/576i 576p 576i	576i 576p 576i	576i

Notes

- It is recommended that you use an authorized cable with HDMI logo or a Sony HDMI cable.
- Images are not output from the HDMI OUT jack of your camcorder, if copyright protection signals are recorded in the movies.
- Images and sounds may not be reproduced correctly on some monitors or TVs.
- Do not connect the output jacks of the camcorder with the output jacks of the monitor or TV. A malfunction may be caused.
- If the frame rate in [REC FORMAT] is set to 25p, the output signal is converted to interlaced or progressive through pull-down conversion.
- If you display the edit screen while outputting signals to a monitor or TV, the menu may not be displayed correctly.
- This camcorder is not compatible with “BRAVIA” sync.

Tip

- HDMI (High-Definition Multimedia Interface) is an interface for transferring uncompressed digital audio and video signals between a TV and a connected device. By connecting a cable from the camcorder’s HDMI OUT jack to your TV, you can enjoy high image quality video and digital audio.

Protecting movies (Protect)

Protect movies to avoid deleting them by mistake.

1 Press the MENU button when the thumbnail screen is displayed.

2 Press the $\uparrow/\downarrow/\leftarrow/\rightarrow$ /SET button, then select \square (EDIT) \rightarrow [PROTECT].

3 Select the movie to be protected.

✓ is displayed on the selected images.

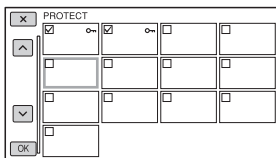

- Press the DISPLAY button to preview the image. Press \square to return to the previous screen.
- You can select up to 100 images at one time.

4 Select \square \rightarrow \square \rightarrow \square .

To undo the protection

Select a movie marked with ✓ in step 3. ✓ disappears.

Note

- You cannot protect DV images.

Dividing a movie

You can divide a movie at a designated point.

1 Press the MENU button while playing back movies.

2 Press the $\uparrow/\downarrow/\leftarrow/\rightarrow$ /SET button, then select \square (EDIT) \rightarrow [DIVIDE].

3 Select \square at the point where you want to divide.

After you select the point with \square , make fine adjustment with these buttons.

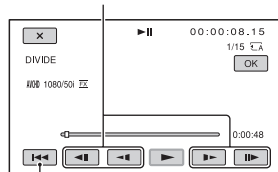

Returns to the beginning of the selected movie.

4 Select \square \rightarrow \square .

Notes

- You cannot restore movies once they are divided.
- Do not remove the battery pack, the AC Adaptor or the recording media that contains the movies from your camcorder during the operation. It may damage the recording media.
- A slight time difference may occur between the point when you press \square and the actual dividing point, as your camcorder selects the dividing point based in about half-second increments.
- Dividing movies is supported for AVCHD only.

Deleting movies

You can free media space by deleting movies from recording media.

Notes

- You cannot restore images once they are deleted.
- Do not remove the battery pack, the AC Adaptor or the recording media from your camcorder during the operation. It may damage the recording media.
- You cannot delete protected movies. Undo the protection of the movies before you try to delete them (p. 68).
- Save important movies beforehand.

Tip

- To delete all data recorded on the recording media and recover all the recordable space of the media, format the media (p. 70).



1 Press the MENU button when the thumbnail screen is displayed.

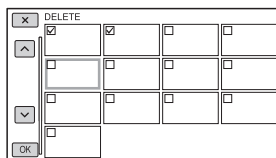

2 Press the $\uparrow/\downarrow/\leftarrow/\rightarrow$ /SET button, then select  (EDIT) \rightarrow [DELETE].

3 Select a movie to delete.

- ✓ is displayed on the selected images.



- Press the DISPLAY button to preview the image. Press  to return to the previous screen.
- You can select up to 100 images at one time.
-  appears at the upper right corner on the thumbnail of protected images.
- No checkbox appears on the thumbnail of protected images.

4 Select  \rightarrow  \rightarrow .

Formatting recording media

Formatting deletes data from the recording media to recover recordable free space.

🔌 Notes

- Connect your camcorder to the wall outlet (wall socket) using the supplied AC Adaptor to prevent your camcorder from running out of power during the operation.
- To avoid the loss of important images, you should save them before formatting recording media.
- Protected movies are also deleted.

1 Press the MENU button.

2 Press the $\uparrow/\downarrow/\leftarrow/\rightarrow$ /SET button, then select  (OTHERS) → [MEDIA FORMAT].

3 Select the recording media to be formatted.

4 Select  → .

🔌 Notes

- While [Executing...] is displayed, do not turn off the camcorder, do not operate any buttons on the camcorder, disconnect the AC Adaptor, or remove the recording media from your camcorder. (The access lamp is lit or flashing while formatting recording media.)

Deleting all data from the memory card completely

If a memory card is used repeatedly, garbage data accumulate which may prevent the image data from being written at the fixed speed. In this case, recording may stop suddenly.

If this happens, empty the memory card to avoid the writing error. Emptying the memory card can erase more data than ordinary formatting.

🔌 Notes

- If you perform this operation, all stored data are deleted. To avoid the loss of important images, you should save them before formatting the recording media.
- You cannot perform this operation unless you connect the AC Adaptor to the wall outlet (wall socket).
- Disconnect all cables except the AC Adaptor. Do not disconnect the AC Adaptor during the operation.
- Do not apply any vibrations or shocks to your camcorder during this operation.

1 Connect your camcorder to the wall outlet (wall socket) using the AC Adaptor (supplied) (p. 21).

2 Press the MENU button.

3 Press the $\uparrow/\downarrow/\leftarrow/\rightarrow$ /SET button, then select  (OTHERS) → [MEDIA FORMAT].

4 Select the recording media to be formatted.

The format screen appears.

5 Select [Empty] → .

Notes

- It may take from several minutes to several hours to empty recording media, depending on the capacity. You can check the actual time required on the LCD screen.
- If you stop the operation while [Executing...] is displayed, be sure to complete the operation by performing [MEDIA FORMAT] or emptying before you use the recording media next time.

Tip

- To prevent a data write error from occurring on the recording media, empty the media data from the camcorder before you start recording. By deleting all data using the [Empty] operation instead of the ordinary [MEDIA FORMAT] operation, you can minimize potential media write errors that might occur when recording.





Repairing the image database file

This function checks the database information and the consistency of movies on the recording media, and repairs any inconsistencies found.

Note

- Connect your camcorder to the wall outlet (wall socket) using the supplied AC Adaptor to prevent your camcorder from running out of power during the operation.

1 Press the MENU button.

2 Press the ////SET button to select  (OTHERS) → [REPAIR IMAGE DB FILE].

3 Select the recording media you want to check the database file.

4 Select .

The database file check starts. Select and quit the database file check if no inconsistency is found.

5 Select → .

Note

- If you stop the operation while “Repairing the image database file.” is displayed, be sure to complete the operation as described above before you use the recording media next time.

Operating the menu

You can change various settings or make detailed adjustments using the menu items displayed on the LCD screen.

MENU button

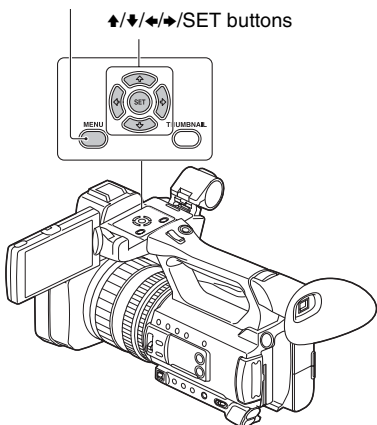

1 Press the MENU button.

The menu screen appears.

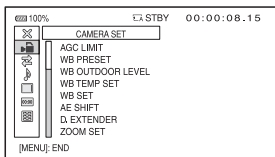

2 Press the ↑/↓/←/→/SET button, select the desired menu icon, then press the button again.

- CAMERA SET (p. 77)
- REC/OUT SET (p. 80)
- AUDIO SET (p. 82)
- DISPLAY SET (p. 84)
- TC/UB SET (p. 88)
- OTHERS (p. 90)
- EDIT (p. 77)

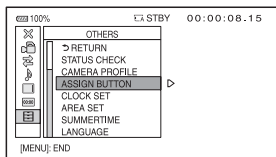

3 Press the ↑/↓/←/→/SET button, select the item that you want to set, then press the button again.

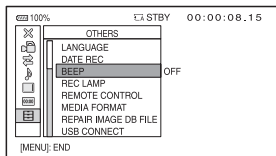

4 Press the ↑/↓/←/→/SET button, select the desired setting, then press the button again.

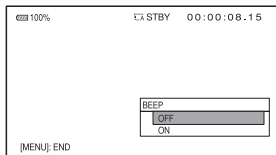

5 Press the MENU button to hide the menu screen.

To return to the previous screen, select [ RETURN].

Notes

- The available menu items vary depending on the context of your camcorder during recording or playback.
- Items and setting values not available due to other settings are grayed out.

Menu items

The function and setting value of each menu item are as follows. The default settings are marked with ▶.

(CAMERA SET) (p. 77)

AGC LIMIT	▶OFF, 24dB to 0dB
WB PRESET	▶OUTDOOR, INDOOR, MANU WB TEMP
WB OUTDOOR LEVEL	-7 to +7 (▶0)
WB TEMP SET	2300K to 15000K (▶6500K)
WB SET	
AE SHIFT	ON/OFF ▶OFF, ON LEVEL -2.0EV to +2.0EV (▶0EV)
D. EXTENDER	▶OFF, ON
ZOOM SET	ZOOM TYPE ▶OPTICAL ZOOM ONLY, ON[CLEAR IMAGE ZOOM], ON[DIGITAL ZOOM] HANDLE ZOOM ZOOM OPERATION ▶ON, OFF ZOOM SPEED 1 to 8 (▶3)
 STEADYSHOT	▶STANDARD, ACTIVE, OFF
CONVERSION LENS	▶OFF, WIDE CONVERSION
S&Q MOTION	[AVCHD] REC FORMAT 1080/50p PS, ▶1080/25p FX, 1080/25p FH FRAME RATE 1 to 50fps (▶50fps)

AUTO MODE SET	▶AUTO, INTELLIGENT AUTO, SCENE SELECTION
SCENE SELECTION SET	NIGHT SCENE, SUNRISE & SUNSET, FIREWORKS, LANDSCAPE, ▶PORTRAIT, SPOTLIGHT, BEACH
AUTO BACK LIGHT	▶OFF, ON
FACE DETECTION	▶OFF, ON
VIDEO LIGHT	▶POWER LINK, REC LINK, REC LINK+STBY, AUTO
NIGHTSHOT LIGHT	▶ON, OFF
COLOR BAR	ON/OFF ▶OFF, ON TONE ▶OFF, ON
PICTURE PROFILE	See page 47.

(REC/OUT SET) (p. 80)

REC SET

FILE FORMAT
XAVC S 4K,
XAVC S HD,
▶AVCHD

REC FORMAT
XAVC S 4K
2160/25p 100Mbps,
▶2160/25p 60Mbps

XAVC S HD
▶1080/50p 50Mbps,
1080/25p 50Mbps,

AVCHD
1080/50p PS,
▶1080/50i FX,
1080/50i FH,
1080/50i HQ,
1080/50i LP,
1080/25p FX,
1080/25p FH,
720/50p FX,
720/50p FH,
720/50p HQ

SIMUL/RELAY REC
▶OFF,
SIMULTANEOUS
REC, RELAY REC

REC BUTTON
SETTING
▶REC BUTTON:
[A] [B], HANDLE
REC BUTTON:
[A] [B]/REC
BUTTON: [A],
HANDLE REC
BUTTON: [B]/REC
BUTTON: [B],
HANDLE REC
BUTTON: [A]

DV MODE
 WIDE REC
ON, ▶OFF

CANCEL DV MODE

VIDEO OUT

OUTPUT SELECT
4K REC OUTPUT
▶VF/LCD PANEL,
EXTERNAL
OUTPUT

HDMI
2160p/1080p/576i,
2160p/720p/576i,
2160p/1080i/576i,
1080p/576i, 720p/
576i, ▶1080i/576i,
576p, 576i

DOWN CONVERT
TYPE
▶SQUEEZE,
LETTER BOX(16:9),
EDGE CROP

 WIDE CONVERT
▶SQUEEZE,
LETTER BOX(16:9),
EDGE CROP

HDMI TC OUTPUT
▶OFF, ON

HDMI REC CONTROL
▶OFF, ON

(AUDIO SET) (p. 82)

VOLUME

AVCHD AUDIO
FORMAT ▶LINEAR PCM,
DOLBY DIGITAL

AUDIO LIMIT ▶OFF, ON

INT MIC SET INT MIC SENS
▶NORMAL, HIGH
INT MIC WIND
▶OFF, ON

Menu items (Continued)

XLR SET	INPUT CH SELECT INPUT1/INPUT1, ▶INPUT1/INPUT2 XLR AGC LINK ▶SEPARATE, LINKED INPUT1 TRIM -18dB to +12dB (▶0dB) INPUT1 WIND ▶OFF, ON INPUT2 TRIM -18dB to +12dB (▶0dB) INPUT2 WIND ▶OFF, ON
---------	---

(DISPLAY SET) (p. 84)

HISTOGRAM	▶OFF, ON, ON[ZEBRA POINT]
ZEBRA	ON/OFF ▶OFF, ON LEVEL 70 to 100, 100+ (▶70)
PEAKING	ON/OFF ▶OFF, ON COLOR ▶WHITE, RED, YELLOW LEVEL HIGH, ▶MIDDLE, LOW
MARKER	ON/OFF ▶OFF, ON CENTER ▶ON, OFF ASPECT ▶OFF, 4:3, 13:9, 14:9, 15:9, 1.66:1, 1.85:1, 2.35:1 SAFETY ZONE ▶OFF, 80%, 90% GUIDEFAME ▶OFF, ON
FOCUS MAG RATIO	x4.0, x8.0, ▶x4.0/x8.0
CAMERA DATA DISPLAY	OFF, ▶ON

AUDIO LEVEL	▶ON, OFF
DISPLAY	
ZOOM DISPLAY	▶BAR, NUMBER
FOCUS DISPLAY	▶METER, FEET
SHUTTER DISPLAY	▶SECOND, DEGREE
DATA CODE	▶OFF, DATE/TIME, CAMERA DATA
LCD BRIGHT	▶NORMAL, BRIGHT
VF BRIGHT	▶NORMAL, BRIGHT
DISPLAY OUTPUT	▶LCD PANEL, ALL OUTPUT

Tips

- You can display [DATA CODE] by pressing the MENU button when the playback screen is displayed.
- [LCD BRIGHT] is available only when using a battery pack. It is grayed out when using the AC Adaptor.

(TC/UB SET) (p. 88)

TC/UB DISPLAY	▶TC, U-BIT
TC PRESET	PRESET, RESET
UB PRESET	PRESET, RESET
TC RUN	▶REC RUN, FREE RUN
TC MAKE	▶PRESET, REGENERATE
UB TIME REC	▶OFF, ON

(OTHERS) (p. 90)

STATUS CHECK	
CAMERA PROFILE	MEMORY CARD A, MEMORY CARD B
ASSIGN BUTTON	ASSIGN1, ASSIGN2, ASSIGN3, ASSIGN4, ASSIGN5
CLOCK SET	
AREA SET	
SUMMERTIME	▶OFF, ON
LANGUAGE	
DATE REC	▶OFF, ON
BEEP	▶OFF, ON
REC LAMP	▶ON, OFF
REMOTE CONTROL	▶ON, OFF

MEDIA FORMAT	MEMORY CARD A, MEMORY CARD B
REPAIR IMAGE DB FILE	MEMORY CARD A, MEMORY CARD B
USB CONNECT	
USB LUN SET	▶MULTI, SINGLE
OPERATION TIME	
VERSION DISPLAY	
INITIALIZE	



(EDIT)

PROTECT	
DIVIDE	
DELETE	





💡 Tip

- You can display the [EDIT] menu by pressing the MENU button when the THUMBNAIL or playback screen is displayed.

(CAMERA SET) menu

Settings to adjust your camcorder to the recording conditions ( STEADYSHOT, etc.)

The default settings are marked with ▶. See page 72 for details on selecting menu items.

Press the MENU button → select  (CAMERA SET) with the ////SET button.

AGC LIMIT

You can select the upper limit for the Auto Gain Control (AGC).

▶OFF, 24dB to 0dB (3dB increments)

⚠ Note

- This function is not active while you adjust the gain manually.

WB PRESET

You can use the preset white balance. For more details, see page 41.

WB OUTDOOR LEVEL

You can set an offset value to adjust the outdoor white balance when you set [WB PRESET] to [OUTDOOR].

-7 to ▶0 to +7
(bluish to normal to reddish)

WB TEMP SET

You can set the color temperature when you set [WB PRESET] to [MANU WB TEMP].

2300K to ▶6500K to 15000K (100K increments)

WB SET

See page 41.

AE SHIFT

■ ON/OFF

▶ OFF

Does not use the AE SHIFT function.

ON

Uses the AE SHIFT function. The selected value (-2.0EV for example) appears on the LCD screen.

■ LEVEL

You can adjust the brightness with the $\blacktriangle/\blacktriangledown/\blacktriangleleft/\blacktriangleright$ /SET button.

-2.0EV to ▶0EV to +2.0EV
(dark to standard to bright)

🔍 Note

- This function is not active while you adjust the iris, shutter speed, gain all manually.

💡 Tip

- You can assign [ON/OFF] to an ASSIGN button (p. 58).

D. EXTENDER

You can use 2× magnification when recording.

▶ OFF

Does not use the magnification function.

ON (DIG.EXT)

Uses the magnification function.

💡 Tip

- You can assign [ON/OFF] to an ASSIGN button (p. 58).

ZOOM SET

■ ZOOM TYPE

▶ OPTICAL ZOOM ONLY

Uses only optical zoom.
You can zoom up to 12×.

ON[CLEAR IMAGE ZOOM]

You can use the clear image zoom in addition to the optical zoom.

XAVC S 4K:

12× (optical zoom),
18× (clear image zoom)

XAVC S HD/AVCHD/DV:

12× (optical zoom),
24× (clear image zoom)

ON[DIGITAL ZOOM]

You can use the digital zoom in addition to the optical zoom and clear image zoom.

You can zoom up to 192× but the image quality deteriorates within the range where DQ is displayed.

💡 Tips

- Clear image zoom maintains an image quality that is close to the original.
- The face detection function will not be effective while using the digital zoom.

■ HANDLE ZOOM

ZOOM OPERATION

▶ ON

Turns handle zoom on.

OFF

Turns handle zoom off.

ZOOM SPEED

Zoom speed (1 to ▶3 to 8)

STEADYSHOT

You can set the camera shake reduction when shooting.

▶ STANDARD (📷)

Uses Steady Shot when shooting under relatively stable conditions.

ACTIVE (📷)

Uses Steady Shot with more powerful effect.

OFF (📷)

Does not use SteadyShot.

This setting is recommended when you use a tripod.

🔔 Note

- When [ACTIVE] is selected, the angle of view shifts 1.08 times toward the telephoto side.

💡 Tip

- You can assign this function to an ASSIGN button (p. 58).

CONVERSION LENS

Set when using a conversion lens (sold separately) that is supported by the camcorder.

This optimizes the steady shot correction and focusing for the conversion lens.

▶ OFF

Not using a conversion lens.

WIDE CONVERSION

Using a wide conversion lens.

S&Q MOTION

See page 55.

AUTO MODE SET

See page 45.

SCENE SELECTION SET

See page 45.

AUTO BACK LIGHT

You can automatically correct for backlighting.

▶ OFF

Does not correct for backlighting.

ON

Automatically corrects for backlighting.

FACE DETECTION

See page 34.

VIDEO LIGHT

This sets the lighting method for a video light (sold separately) attached to the multi-interface shoe.

▶ POWER LINK (📷)

Video light turns on/off when the camcorder power is turned on/off.

REC LINK (📷) REC

Video light turns on/off when the camcorder starts/stops recording.

REC LINK+STBY (📷) STBY

Video light turns on or switches to standby when the camcorder starts/stops recording.

AUTO (📷) AUTO

Light turns on automatically.

NIGHTSHOT LIGHT

You can record clear images with NIGHTSHOT (p. 46), which uses an infrared light when shooting.

▶ ON

Emits infrared light.

OFF

Does not emit infrared light.

🔊 Notes

- Make sure that your finger does not cover the infrared light emitter (p. 6) when shooting.
- The light is effective up to a distance of approximately 3 meters.

COLOR BAR**■ ON/OFF****▶ OFF**

Does not display color bars.

ON

Displays color bars on the LCD screen, records them on recording media, and outputs audio tone signals.

This function helps you to adjust colors when you view movies recorded with your camcorder on a TV or a monitor.

🔊 Notes

- This function is automatically set to [OFF] when you switch the format, perform the function by the MENU button, or turn off the camcorder.
- The [COLOR BAR] setting cannot be changed during recording or during Focus Magnifier operation.

■ TONE**▶ OFF**

Does not output audio tone signals.

ON

Outputs audio tone signals (1 kHz: full bit, -18dB).

Set [ON/OFF] to [ON], too.

💡 Tips

- You can assign [ON/OFF] to an ASSIGN button (p. 58).
- If you record color bars with [TONE] set to [OFF], the camcorder records sound from the microphone.

PICTURE PROFILE

See page 47.

↔ (REC/OUT SET) menu**Recording settings, input and output settings (REC SET/VIDEO OUT, etc.)**

The default settings are marked with ▶.

See page 72 for details on selecting menu items.

Press the MENU button → select ↔ (REC/OUT SET) with the ▲/▼/◀/▶/SET button.

REC SET**■ REC FORMAT**

See page 36.

■ SIMUL/RELAY REC

See page 31.

■ REC BUTTON SET

See page 31.

■ DV MODE

See page 37.

■  WIDE REC

You can set the aspect ratio when recording in DV.

▶ OFF ()

Records in 4:3.

ON

Records in 16:9.

🔊 Note

- When recording at a setting other than DV, the aspect ratio is fixed to 16:9, and the 4:3 aspect ratio is not available.

■ CANCEL DV MODE

See page 37.

VIDEO OUT

■ OUTPUT SELECT 4K REC OUTPUT

Sets the video output destination.

▶ VF/LCD PANEL EXTERNAL OUTPUT

■ HDMI

You can select the resolution of the output signal from the HDMI jacks.

2160p/1080p/576i

2160p/720p/576i

2160p/1080i/576i

1080p/576i

720p/576i

▶ 1080i/576i

576p

576i

💡 Tip

- See page 66 for the output resolution of the signal for each type of connection cable.

■ DOWN CONVERT TYPE

You can select a down convert type when you down-convert video signal.

Use this function for outputting movies recorded in 16:9.

▶ SQUEEZE Outputs a horizontally compressed image while maintaining its original height.

LETTER BOX(16:9)
Outputs a vertically compressed image while maintaining its original aspect ratio.

EDGE CROP
Outputs the central portion of the original image by cropping its right and left edges.

■ [DV] WIDE CONVERT

You can select a down convert type when you down-convert video signal.

Use this function for outputting DV movies recorded with [[DV] WIDE REC] set to [ON].

▶ SQUEEZE

Outputs a horizontally compressed image while maintaining its original height.

LETTER BOX(16:9)

Outputs a vertically compressed image while maintaining its original aspect ratio.

EDGE CROP

Outputs the central portion of the original image by cropping its right and left edges.

🔊 Notes

- When you view a movie recorded in DV with [[DV] WIDE REC] set to [ON] on a standard 4:3 TV, images may appear horizontally compressed while maintaining its original height. In such a case, select [LETTER BOX(16:9)] or [EDGE CROP].
- If you change the setting from [SQUEEZE] to another option, or from another option to [SQUEEZE], the screen will go out momentarily, and the image and sound will be intermittent.

■ HDMI TC OUTPUT

You can set whether to output time code to other professional-use devices, using HDMI.

▶ OFF

Does not overlap the time code information on HDMI output signal.

ON

Overlaps the time code information on HDMI output signal. The data is transmitted as digital data, not as a projected image, and the connected device identifies the time data by referencing the transmitted digital data.

■ HDMI REC CONTROL

When the camcorder is connected to an external recorder, you can set whether the external recorder automatically starts/stops recording based on the camcorder's operations.

▶ OFF

Does not record to an external recorder automatically based on the camcorder's operations.

ON

Records to an external recorder automatically based on the camcorder's operations.

♪ (AUDIO SET) menu

Settings for the audio recording (AVCHD AUDIO FORMAT, etc.)

The default settings are marked with ▶.

See page 72 for details on selecting menu items.

Press the MENU button → select ♪ (AUDIO SET) with the /▶/◀/SET button.

VOLUME

You can adjust the volume.

💡 Tip

- You can assign this function to an ASSIGN button (p. 58).

AVCHD AUDIO FORMAT

You can set the audio format for AVCHD recording.

▶ LINEAR PCM (LPCM)

Records in LPCM format.

DOLBY DIGITAL (DolbyD)

Records in Dolby Digital format.

⚠ Note

- The above setting can be switched only when the recording format is AVCHD.

AUDIO LIMIT

Sets the sound distortion prevention function for CH-1/CH-2.

▶ OFF

Disables the sound distortion prevention function.

ON

Activates the sound distortion prevention function.

⚠ Note

- Available only when the AUTO/MAN (CH-1/CH-2) switch is set to "MAN."

INT MIC SET

■ INT MIC SENS

You can set the audio recording sensitivity of the internal microphone.

▶ NORMAL

Sensitivity generally used for professional-use devices.

HIGH

Sensitivity generally used for consumer-use devices.

■ INT MIC WIND

You can attenuate low tone input sound in the internal microphone to reduce wind noise.

▶ OFF

Disables wind noise reduction.

ON ()

Enables wind noise reduction.

XLR SET

■ INPUT CH SELECT

Selects the signals for recording to CH-1 and CH-2 (p. 42).

INPUT1/INPUT1

Records the input on INPUT1 signal to both CH-1 and CH-2.

▶ INPUT1/INPUT2

Records the INPUT1 signal to CH-1, and the INPUT2 signal to CH-2.

■ XLR AGC LINK

Links/unlinks the AGC (Auto Gain Control) of CH-1 and CH-2 when using an external microphone.

▶ SEPARATE

Unlinks AGC (CH-1 and CH-2 are recorded with separate AGC).

LINKED ()

Links AGC (CH-1 and CH-2 are recorded with linked AGC, like stereo).

A  appears on the status check screen.

⚙ Note

- Available when the same source (LINE/MIC/MIC+48V) is selected on both INPUT1 and INPUT2 switches, and the AUTO/MAN switches for both CH-1 and CH-2 are set to “AUTO” (p. 42).

■ INPUT1 TRIM

Adjusts the input signal level when recording the signal from the INPUT1 jack.

-18dB, -12dB, -6dB, ▶0dB, +6dB, +12dB

⚙ Note

- This setting is disabled when the INPUT1 switch is set to “LINE.”

■ INPUT1 WIND

▶ OFF

Disables the wind noise reduction function for the INPUT1 jack.

ON

Activates the wind noise reduction function for the INPUT1 jack.

 appears on the status check screen.

⚙ Note

- This setting is disabled when the INPUT1 switch is set to “LINE.”

(AUDIO SET) menu (Continued)

■ INPUT2 TRIM

■ INPUT2 WIND

See the description for the corresponding functions for INPUT1.

💡 Tips



- If the recording level is set to “AUTO” and INPUT TRIM is set to [0dB], a -48 dBu input will be recorded at the reference recording level (-48 dBu corresponds to 0 dB level). For example, if a microphone with -30 dB sensitivity (0 dB = 1 V/Pa at 1 kHz) is connected and a 1 kHz 74 dB SPL sound pressure level is input (microphone output is -48 dBu), set INPUT TRIM to [0dB]. If using a microphone with -36 dB sensitivity, setting INPUT TRIM to [+6dB] will compensate for the difference in sensitivity from a microphone with -30 dB sensitivity.
- The INPUT TRIM function adjusts the input level of external microphones. For microphones with high sensitivity or to record high-level audio, adjust in the negative direction. For microphones with low sensitivity or to record low-level audio, adjust in the positive direction.
- Distortion of high-volume audio may occur in the input stage or the recording stage. To counter distortion of the input stage, adjust the level using the INPUT TRIM function. To counter distortion in the recording stage, reduce the overall level manually.
- If the INPUT TRIM is adjusted in the negative direction too far, the audio level from the microphone may become too small, adversely affecting the S/N ratio.
- Test the effect of using [XLR SET] beforehand to suit the microphone used and the sound field to record.

■ (DISPLAY SET) menu

Display settings (MARKER/DISPLAY OUTPUT, etc.)

The default settings are marked with ▶.

See page 72 for details on selecting menu items.

Press the MENU button → select  (DISPLAY SET) with the /SET button.

HISTOGRAM

The histogram displays the luminance distribution that shows how many pixels of a particular brightness exist in the image.

▶ OFF

Does not display the histogram.

ON

Displays a histogram.

A line appears at the 100% position, and the color of the zone above the line changes.

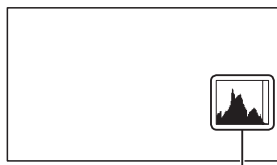

Histogram

ON[ZEBRA POINT]

The histogram shows the point where the zebra pattern appears. A line is displayed at the brightness level set with [ZEBRA].

💡 Tip

- You can assign this function to an ASSIGN button (p. 58).

ZEBRA

You can display a zebra pattern as a guide for adjusting brightness.

■ ON/OFF

▶ OFF

Does not display the zebra pattern.

ON (and level)

The zebra pattern is not recorded with the image.

■ LEVEL

You can select the brightness level.

▶ 70 to 100, or 100+

💡 Tips

- The zebra pattern is a stripe pattern that appears in areas of brightness equal to or exceeding the brightness level you have set.
- You can assign [ON/OFF] to an ASSIGN button (p. 58).

PEAKING

■ ON/OFF

▶ OFF

Does not display the peaking.

ON (PEAKING)

You can display an image on the LCD screen with its outlines enhanced.

This function helps you to adjust the focus.

■ COLOR

You can select the peaking color.

▶ WHITE, RED, YELLOW

■ LEVEL

You can select the peaking sensitivity.

HIGH, ▶ MIDDLE, LOW

🔊 Note

- The enhanced outlines will not be recorded on the recording media.

💡 Tips

- You can focus more easily using this function in combination with the expanded focus function (p. 33).
- You can assign [ON/OFF] to an ASSIGN button (p. 58).

MARKER

■ ON/OFF

▶ OFF

Does not display markers.

ON

Displays markers.

Markers are not recorded on the recording media.

■ CENTER

▶ ON

Displays a marker at the center of the LCD screen.

OFF

Does not display a center maker.



■ ASPECT

▶ OFF

Does not display the aspect ratio.

4:3, 13:9, 14:9, 15:9, 1.66:1, 1.85:1, 2.35:1

Displays markers at boundaries of display area defined by the aspect ratio.



(DISPLAY SET) menu (Continued)

SAFETY ZONE

▶ OFF

Does not display the safety zone.

80%, 90%

If you select either one, you can display markers at boundaries of display area that regular home TVs can display.



GUIDEFAME

▶ OFF

Does not display the guideframe.

ON

Displays the guideframe.

You can check the horizontal and vertical aspect of a subject.



Notes

- Only the time code is output to an external device via external output jacks when [MARKER] is set to [ON], even if [DISPLAY OUTPUT] is set to [ALL OUTPUT].
- You cannot display markers during [FOCUS MAGNIFIER].
- You cannot output markers on an external device.

Tips

- You can display all types of markers at the same time.
- You can obtain a balanced composition by positioning the subject at the cross points of the guideframe marker.
- You can assign [ON/OFF] to an ASSIGN button (p. 58).

FOCUS MAG RATIO

You can set the magnification of expanded focus.

×4.0

×8.0

▶ ×4.0/×8.0

The setting changes in the order [×4.0] → [×8.0] → [OFF] with each press of the ASSIGN/FOCUS MAG button.

CAMERA DATA DISPLAY

OFF

Does not display the iris, gain and shutter speed settings.

▶ ON

Constantly displays the iris, gain and shutter speed settings on the LCD screen.

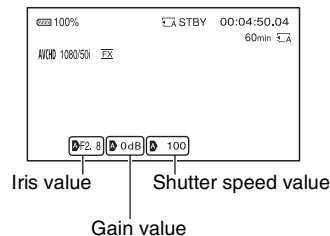

Tips

- The settings appear on the LCD screen during the manual adjustment regardless of the settings of this function.
-  indicates that the settings are automatically adjusted values.
- The displayed settings are different from the settings that will be displayed when you press the ASSIGN button to which [DATA CODE] is assigned (p. 63).
- You can assign this function to an ASSIGN button (p. 58).

AUDIO LEVEL DISPLAY

► ON

Displays the audio level meters on the LCD screen.

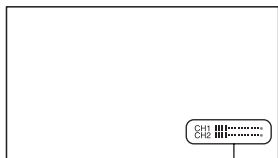

Audio level meters

OFF

Does not display the audio level meters.

Tip

- You can assign this function to an ASSIGN button (p. 58).

ZOOM DISPLAY

► BAR

Displays a bar that indicates the zoom position.

NUMBER

Displays a number that indicates the zoom position.

FOCUS DISPLAY

► METER

Displays the focal length in meters.

FEET

Displays the focal length in feet.

SHUTTER DISPLAY

► SECOND

Displays the shutter display in seconds.

DEGREE

Displays the shutter display in degrees.

The shutter speed equal to the period that your camcorder reads image data from the image sensor is defined as 360 degrees. The degree is calculated based on this definition and displayed.

- With a frame rate of 50 selected in [REC FORMAT], when the shutter speed is 1/50, the shutter angle is 360 degrees.
- With a frame rate of 25 selected in [REC FORMAT], when the shutter speed is 1/25, the shutter angle is 360 degrees.

See page 36 for details on the [REC FORMAT] setting.

Note

- When you press the ASSIGN button to which [DATA CODE] is assigned, the shutter speed is displayed in seconds regardless of this setting.

Tip

- If the shutter speed is more than 360 degrees, it is displayed as an integral multiple of 360 degrees (360 × 2, etc.).

DATA CODE

You can select the information that is displayed during playback.

► OFF

No information is displayed.

DATE/TIME

The date and time are displayed.

CAMERA DATA

Camera data is displayed.

Tip

- You can assign this function to an ASSIGN button (p. 58).
- When DISPLAY OUTPUT is set to LCD PANEL, some information still appears on the external output.

(DISPLAY SET) menu (Continued)

LCD BRIGHT

You can adjust the brightness of the LCD screen. Changes in the LCD brightness are not affect the brightness of recording images.

- ▶ **NORMAL**
BRIGHT

VF BRIGHT

You can adjust the brightness of the viewfinder. Changes in the LCD brightness are not affect the brightness of recording images.

- ▶ **NORMAL**
BRIGHT

DISPLAY OUTPUT

You can select where to output the display information, such as time code.

- ▶ **LCD PANEL**
Outputs the information to the LCD screen.
- ALL OUTPUT**
Outputs information to the HDMI OUT and VIDEO OUT jacks, and the LCD screen. Zebra, peaking and the frame on the face are also output.



Notes

- Only the time code, zebra, peaking and the frame on the face are output when [MARKER] is set to [ON] and a marker is displayed on the LCD screen.
- Even when set to LCD PANEL, some information appears on the external output.

(TC/UB SET) menu

Time code settings (TC PRESET/UB PRESET, etc.)

The default settings are marked with ▶. **See page 72 for details on selecting menu items.**

Press the MENU button → select  (TC/UB SET) with the /SET button.

TC/UB DISPLAY

You can select whether to display the time code or the user bit code.

- ▶ **TC**
Displays the time code.
- U-BIT**
Displays the user bit code.

Tip

- You can assign this function to an ASSIGN button (p. 58).

TC PRESET

See page 54.

UB PRESET

See page 54.

TC RUN

You can select how the time code advances.

► REC RUN

Advances the time code only during recording.

Select this setting to record the time code sequentially from the last time code of the previous recording.

FREE RUN

Advances the time code regardless of operation of your camcorder.

Note

- Even if the time code advances in [REC RUN] mode, the time code may not be recorded sequentially in the following cases:
 - When the recording format is changed.
 - When the recording media is removed.

TC MAKE

► PRESET

Records the newly set time code on the recording media.

REGENERATE

Reads the last time code of the previous recording from the recording media and records the new time code consecutively from the last time code during the backspace editing.

The time code runs in [REC RUN] mode regardless of the setting of [TC RUN].

UB TIME REC

► OFF

Does not save the actual time in the user bit code.

ON

Saves the actual time in the user bit code.

Note





- The last 2 digits are fixed to 00 when it is set to [ON].

(OTHERS) menu

Settings while recording or other basic settings (AREA SET/BEEP, etc.)

The default settings are marked with ►.

See page 72 for details on selecting menu items.

Press the MENU button → select  (OTHERS) with the ////SET button.

STATUS CHECK

See page 64.

CAMERA PROFILE

You can save up to 99 camera profile settings in a memory card and recall them at any time for easy setup.

In addition, if you should require multiple camcorders with the same settings, you can load the desired settings to all cameras via the memory card.

Notes





- Camera profiles for 50i models and 60i models are not compatible.
- The file may not be shown properly if the file name is changed on the computer, or the power turned off during generation.
- Formatting the memory card also deletes saved camera profiles.

Tip

- Items that can be saved include setting values for menus, picture profiles, buttons, etc. You can save these setting values all together in the camera profile.

■ LOAD

Load the camera profile, and execute the settings.





- ① Select the camera profile to be loaded with the ////SET button.
- ② Select [YES] on the confirmation screen.
The camcorder restarts, and the loaded camera profile becomes effective.

Note

- A camera profile saved on a camcorder with different model name, or edited on a computer cannot be loaded.

■ SAVE

You can save the camera profile.





- ① Select [NEW FILE] or an existing profile name with the ////SET button.
- ② Select [YES] on the confirmation screen.
The camera profile is saved.

Tips

- When you select [NEW FILE], the profile is named [01] (when saving for the first time).
- If you select an existing camera profile, the current setting values are overwritten.
- You cannot use a computer to edit saved settings.

■ DELETE

You can delete the saved camera profile.

- ① Select the camera profile to be deleted with the ////SET button.
- ② Select [YES] on the confirmation screen.

ASSIGN BUTTON

See page 58.

CLOCK SET

See page 22.

AREA SET

You can adjust the time difference without stopping the clock. When you use your camcorder abroad, you can adjust the clock to the local time.

SUMMERTIME

You can change this setting without stopping the clock. Set to [ON] to move the time forward 1 hour.

► OFF

Does not set summer time.

ON

Sets summer time.

LANGUAGE

You can select the language to be used on the LCD screen.

DATE REC

► OFF

Does not superimpose the date and time on images.

ON

Superimposes the date and time on images.

💡 Tips

- You can set this item only when the interlace scanning system is selected.
- When zebra or peaking is activated, the date and time characters are affected by the signal, but properly recorded on images.

BEEP

► OFF

Cancels the melody.

ON

Activates a melody when you start/stop recording, or when you are warned with warning indicators, etc.

REC LAMP

► ON

Turns on the recording lamp.

OFF

Turns off the recording lamp.

💡 Tip

- You can assign this function to an ASSIGN button (p. 58).

REMOTE CONTROL

► ON

Enables the supplied Wireless Remote Commander (p. 12).

OFF

Disables the supplied Wireless Remote Commander to prevent misoperation by the remote control of another device.

MEDIA FORMAT

See page 70.

REPAIR IMAGE DB FILE

See page 71.

USB CONNECT

Select this item when [USB CONNECT] does not appear on the LCD screen by connecting the camcorder to another device with the USB cable.

USB LUN SET

You can improve compatibility with external devices by limiting the functions of the USB connection.

► MULTI

Set to [MULTI] in normal conditions.

(OTHERS) menu (Continued)

SINGLE

Set to [SINGLE] if you are unable to connect using the [MULTI] setting.

OPERATION TIME

Displays the total hours of operation in 10-hour increments.

VERSION DISPLAY

Displays the current version of your camcorder. Be sure to check for firmware updates.

Note

- To perform an update, use the AC Adaptor.

INITIALIZE

You can reset all settings, including the clock setting, to their default values.

Note

- The picture profile settings are not reset.

Troubleshooting

If you run into any problems using your camcorder, follow the flow chart below.

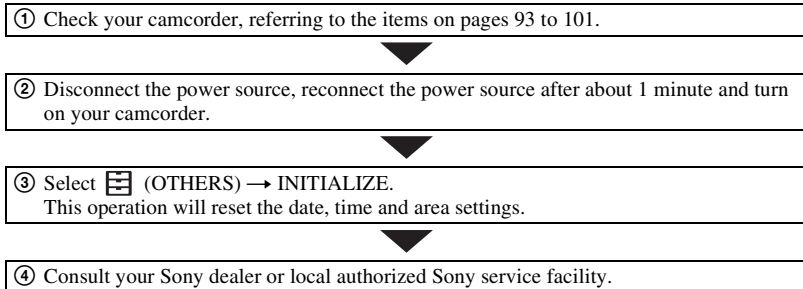

- Power sources/LCD screen/Wireless Remote Commander (p. 93)
- Memory cards (p. 95)
- Recording (p. 95)
- Playback (p. 99)
- Connecting to TV (p. 100)
- Copying/Editing/Connecting to other devices (p. 100)
- Connecting to a computer (p. 101)

Power sources/LCD screen/Wireless Remote Commander

The power does not turn on or abruptly turns off.

- Attach a charged battery pack to the camcorder (p. 19).
- Use the AC Adaptor to connect the camcorder to a wall outlet (wall socket) (p. 19).

The camcorder does not operate even when the power is set to on.

- Disconnect the power source (battery or AC Adaptor), then reconnect it after about 1 minute.
- Select [OTHERS] (OTHERS) → INITIALIZE.

The camcorder gets warm.

- Camera body may get warm with use – this is normal.

The POWER/CHG lamp is not lit while charging the battery pack.

- Turn off the power.
- Reattach the battery pack correctly.
- Re-insert the plug in the power outlet correctly.
- The battery pack is already fully charged.

The POWER/CHG lamp flashes while charging the battery pack.

- The battery pack may not be able to be charged if the temperature of the battery pack is too high or too low.
 - Reattach the battery pack correctly.
 - If the lamp continues to flash, there may be a problem with the camcorder. Disconnect the plug from the power outlet, and contact a service representative.
-

The remaining battery indicator does not indicate the correct figure.

- Ambient temperature is too high or too low, or the battery pack has not been charged enough. This is not a malfunction.
 - Fully charge the battery again. If the problem persists, the battery may be worn-out. Replace with a new battery (p. 19, 110).
 - The indicated figure may not be correct in certain circumstances. For example, when you open or close the LCD screen, it takes about 1 minute to display the correct remaining battery.
-

The battery pack discharges too quickly.

- Ambient temperature is too high or too low, or the battery pack has not been charged enough. This is not a malfunction.
 - Fully charge the battery again. If the problem persists, the battery may be worn-out. Replace with a new battery (p. 19, 110).
-

The image on the viewfinder is not clear.

- Move the viewfinder lens adjustment dial until the image appears clearly (p. 24).
-

The supplied Wireless Remote Commander does not function.

- Set [REMOTE CONTROL] to [ON] (p. 91).
 - Remove any obstructions between the Wireless Remote Commander and the remote sensor of the camcorder.
 - Keep strong light sources, such as sunlight or overhead lighting, away from the remote sensor, otherwise the Wireless Remote Commander may not function properly.
 - Change the battery. Insert a fresh battery the +/- terminals aligned correctly (p. 12).
-

Another video device malfunctions when you use the supplied Wireless Remote Commander.

- Select a commander mode other than DVD2 for your video device.
- Cover the sensor of your video device with black paper.

The camcorder does not operate normally when a device is connected to the REMOTE jack.

- The speed in response to commands from the Wireless Remote Commander may be slow.
- The camcorder settings may not be restored if a cable is connected to the REMOTE jack of the camcorder and the device on the other end of the cable is disconnected. Disconnect the cable from the REMOTE jack of the camcorder first.

Memory cards**The camcorder does not operate with the memory card inserted.**

- The memory card was formatted on a computer. Format it on this camcorder (p. 70).

The data file name is incorrect, or flashing.

- The file is damaged.
- The file format is not supported on your camcorder (p. 109).

The recording media indicator is flashing.

- Something wrong happened to recording media. Stop recording of all recording media, and repair the database file.

Images on the recording media cannot be deleted.

- You can select no more than 100 images to be deleted on the edit screen.
- The images are protected. Unprotect the images (p. 68).

Cannot play back or memory card is not recognized on another device.

- The playback device does not support playback of the memory card.

Recording**The recording does not start when you press the START/STOP button.**

- The playback screen is displayed. Finish playback operation (p. 62).
- The previously shot scene is still being written to the memory card. Shooting a new scene cannot start while writing data.
- There is no empty space on the recording media. Replace the recording media with a new one or format the recording media (p. 70). Delete unnecessary images (p. 69).
- Total number of movie scenes exceeds the recordable capacity of your camcorder (p. 106). Delete unnecessary images (p. 69).
- The temperature of your camcorder is extremely high. Turn off your camcorder and leave it for a while in a cool place.
- The temperature of your camcorder is extremely low. Turn off your camcorder and leave it for a while in a warm place.
- Something wrong happened to recording media. Stop recording of all recording media, and repair the database file.

The handle zoom does not work.

- Set [HANDLE ZOOM] > [ZOOM OPERATION] to ON (p. 78).
-

The access lamp remains lit even after recording was stopped.

- Your camcorder is recording the scene you have just shot on the memory card.
-

The imaging field looks different.

- The imaging field may look different depending on the condition of your camcorder. This is not a malfunction.
-

The actual recording time for movies is less than the estimated recording time of the recording media.

- Depending on the recording conditions, the time available for recording may be shorter, for example when recording a fast moving object, for example (p. 105).
-

Recording stops.

- Recording may stop if the camcorder is subjected to repeated vibration.
-

The camcorder does not keep the setting changes.

- Some menu items return to the default setting when the power is turned off.
 - The [FOCUS MAGNIFIER] setting is not stored.
 - The battery pack or AC Adaptor was disconnected while the power was turned on. Before disconnecting the battery pack or AC Adaptor, turn off the power and make sure that the access lamp is turned off.
-

There is a time difference between the point when the START/STOP button is pressed and the point that the recording movie actually starts or stops.

- On your camcorder, there may be a slight time difference between the point where you press the START/STOP button and the actual point that recording movie starts/stops. This is not a malfunction.
-

The aspect ratio (16:9 (wide)/4:3) cannot be changed.

- When recording at a setting other than DV, the aspect ratio of the movie cannot be changed.
-

Automatic focus does not function.

- Set the focus to "AUTO" to enable the automatic focus function (p. 33).
- Adjust the focus manually if the automatic focus does not work properly (p. 33).

Image stabilization is not working.

- Set [STEADYSHOT] to [ACTIVE] or [STANDARD].
- SteadyShot image stabilization may not be able to correct the image if the shaking is too large, even if [STEADYSHOT] is set to [ACTIVE] or [STANDARD].

Image cannot be recorded or played back properly.

- If you continue recording and deleting images on recording media for a long period of time, the files on that media may become fragmented. As a result, you may not be able to record and save images properly.
Back up the image data, then format the media using [MEDIA FORMAT].

Menu items are grayed out or do not work.

- You cannot select grayed out display items in the current recording/playback situation.
- There are some functions you cannot activate simultaneously. The following list shows examples of unworkable combinations of functions and menu items.

Cannot use (menu disabled)	Situation
[ON/OFF] of [AE SHIFT]	All of iris, gain and shutter speed are set manually.
[ZEBRA], [PEAKING]	[COLOR BAR] is set to [ON].
[ON/OFF] of [MARKER]	[FOCUS MAGNIFIER] is set to [ON].
[TC PRESET]	[TC MAKE] is set to [REGENERATE].
[COLOR BAR]	Movies are being recorded. [FOCUS MAGNIFIER] is set to [ON]. When the file format is XAVC S 4K.
[D. EXTENDER]	When the file format is XAVC S 4K.
[AUTO MODE SET]	When the file format is XAVC S 4K.

The settings of menu items change.

- When the FULL AUTO button is set to AUTO, settings related to picture quality automatically change.

Iris, gain, shutter speed, or white balance cannot be adjusted manually.

- Press the FULL AUTO button to set auto mode off.

Tiny spots in white, red, blue, or green appear on the LCD screen.

- This phenomenon appears when using a slow shutter speed (p. 39). This is not a malfunction.

The subjects passing by the frame very fast appear crooked.

- This is called focal plane phenomenon. This is not a malfunction. Because of the way that the image device (CMOS sensor) reads out image signals, the subjects passing by the frame rapidly might appear crooked depending on the recording conditions.
-

Horizontal stripes appear on the image.

- This occurs when recording pictures under a fluorescent lamp, sodium lamp, or mercury lamp. This is not a malfunction. This can be improved by changing the shutter speed (p. 39).
-

Black bands appear when you record a TV screen or computer screen.

- Adjust the shutter speed (p. 39).
-

Fine patterns flicker, diagonal lines look jagged.

- Adjust [DETAIL] to the negative side (p. 53).
-

The time code is not recorded in sequence.

- The time code may not be recorded sequentially if you change the settings of [REC FORMAT].
-

Image color is not correct.

- Cancel NIGHTSHOT (p. 46).
-

The image is not visible because the screen is too bright.

- Press the FULL AUTO button to set auto mode on.
 - Cancel NIGHTSHOT (p. 46).
-

Cannot adjust [LCD BRIGHT].

- [LCD BRIGHT] cannot be adjusted in the following cases.
 - The LCD screen is in the stowed position with the screen facing outward.
 - When using the AC Adaptor.

Playback

Also refer to “Memory cards” (p. 95).

The desired images cannot be found.

Images cannot be played back.

- Select the recording media and image quality of the image you want to play back on the thumbnail screen (p. 60).
- Image data cannot be played back if you have modified file names or folders, or have edited the data on a computer. This is not a malfunction.
- Images recorded on other devices may not be played back, or displayed in incorrect size. This is not a malfunction.
- Display the thumbnail screen, select the thumbnail you want to play using the $\blacktriangle/\blacktriangledown/\blacktriangleleft/\blacktriangleright$ buttons, and press the SET button (p. 61).

The data file name is incorrect, or flashing.

- The file is damaged.
- The file format is not supported on your camcorder (p. 109).
- Only the file name is displayed, if the folder structure does not conform to the universal standard.

Audio is not recorded properly.

- If an external microphone or other device is connected or disconnected while recording a movie, the audio may not be recorded properly. Audio is recorded properly by restoring the connection state of the microphone that was in force at the start of recording.
- Audio is not recorded if the AUDIO LEVEL dial is adjusted so that the volume is set to the minimum.

No sound or only a low sound is heard.

- Turn up the volume (p. 62).

“---” is displayed on the LCD screen.

- Bars will be displayed for the camera data of the movies recorded with [COLOR BAR] set to [ON].

Multi ch appears on the LCD screen.

- Multi ch appears when you play back movies recorded with 5.1ch surround sound. 5.1ch surround sound is down-mixed to 2ch stereo and played back on your camcorder.

Connecting to TV

Neither image nor sound is played back on the TV connected with the HDMI cable.

- Images are not output from the HDMI OUT jack if copyright protection signals are recorded in the images.
- Signals are not output from the HDMI OUT jack when the USB jack is connected.

Neither image nor sound is played back on the TV, projector, or AV amplifier connected with the HDMI cable.

- If you cannot view images or hear sound on the TV, projector, or AV amplifier connected with the HDMI cable, try disconnecting and connecting the HDMI cable, or turn on your camcorder again.

The image appears distorted on a 4:3 TV.

- This happens when viewing a movie recorded in the 16:9 (wide) mode on a 4:3 TV. Select  (REC/OUT SET) → [VIDEO OUT] → [DOWN CONVERT TYPE] and set the appropriate down conversion type (p. 81).

Black zone appears at top and bottom of a 4:3 TV screen.

- This happens when viewing a movie recorded in the 16:9 (wide) mode on a 4:3 TV. This is not a malfunction.

Copying/Editing/Connecting to other devices

Time code and other information appear on the display of the connected device.

- Set [DISPLAY OUTPUT] to [LCD PANEL] (p. 88).

Copy cannot be done correctly using the A/V connecting cable (sold separately).

- The A/V connecting cable (sold separately) is not connected properly. Make sure that the A/V connecting cable (sold separately) is connected to the input jack of the device.

Sound cannot be added to the recording media after recording.

- You cannot add sound to the recording media after recording on your camcorder.

Copy cannot be done correctly using the HDMI cable.

- You cannot copy movies using the HDMI cable.

Cannot divide movies.

- The following types of movie cannot be divided.
 - Movies with a very short recording duration.
 - XAVC S 4K and XAVC S HD movies
- Cancel file protection and then try to divide.

Connecting to a computer

The computer does not recognize the camcorder.

- Disconnect the cable from the computer, then connect it again securely.
- Disconnect the cable from your computer and camcorder. Reboot your computer, and connect your computer and camcorder following the steps in the correct order.

Movies cannot be viewed or copied to the computer.

- Disconnect the cable from the computer, then connect it again.
- You need to install “Catalyst Browse” to copy movies from your camcorder to your computer.

Warning indicators and messages

Self-diagnosis display/Warning indicators

When an error occurs, a warning indicator appears on the LCD screen or in the viewfinder.

You can fix some problems associated with the symptoms yourself. If the problem persists even after you have tried a couple of times, contact your Sony dealer or local authorized Sony service facility.

C:04:□□

- The battery pack is not an “InfoLITHIUM” battery pack. Use an “InfoLITHIUM” battery pack (p. 110).

C:06:□□

- The battery pack is too hot. Replace the battery pack, or remove the battery pack and put it in a cool place.

C:13:□□

- Remove the recording media. After installing them again, operate your camcorder.

C:32:□□

- Remove the power source. Reconnect it and operate your camcorder again.

E:□□□□

- Try steps ② to ④ on page 93.

(Battery level warning)

- The battery pack is nearly used up.
- Depending on the operation, environment, or battery conditions, the indicator may flash, even if around 10% is displayed as the battery remaining figure.

(Warning indicators pertaining to battery pack temperature)

- The battery pack is too hot. Replace the battery pack, or remove the battery pack and put it in a cool place.

(Warning indicator pertaining to the video light)

- The battery level is too low.

(Warning indicators pertaining to memory cards)

Slow flashing

- Free space for recording images are running out. For the type of memory cards you can use with your camcorder, see page 26.
- No memory card is inserted (p. 26).

Fast flashing

- There is not enough free space for recording images. Delete unnecessary images (p. 69), or format the memory card (p. 70) after you save the images to your computer or another device.
- The image database file may be damaged (p. 71).

(Warning indicators pertaining to memory card formatting)*

- The memory card is damaged.
- The memory card is not formatted correctly (p. 70).

(Warning indicators pertaining to incompatible memory cards)*

- Incompatible memory card is inserted (p. 26).

(Warning indicators pertaining to the write-protect of the memory card)*

- The write-protect switch is set to lock position on the memory card.
 - Access to the memory card was restricted on another device.
-

* When [BEEP] is set to [ON] (p. 91), you hear a melody when the warning indicators appear on the LCD screen.

Description of warning messages

If a warning message is displayed, follow the instructions.

Memory cards

Inconsistencies found in image database file. Do you want to repair the image database file?

Inconsistencies found in image database file. Cannot record or play HD movies. Do you want to repair the image database file?

- You cannot record or play back movies because no movie management information exists. Select [OK] to repair.
-

Inconsistencies found in the image database file. Back up and recover. Recover, then import using the included PC software.

- Inconsistencies occur in the image database file because movie management information is damaged. If you select [OK], the management file is repaired after backing up the movie. The backed up movies cannot be recognized. If you connect to a computer on which "Catalyst Browse" is installed, you can copy the backed up movies.

However, the loading of all moves is not guaranteed.

Buffer overflow. Writing to the media was not completed in time.



- You have performed recording and erasing operations repeatedly, or a memory card that has been formatted by other device is used. Back up the data to another device (such as a computer HDD), and then [Empty] the memory card on the camcorder (p. 70).
 - The size of the inserted memory card is not sufficient for copying the movie(s). Use a memory card recommended for your camcorder (p. 26).
-

Recovering data.

- Your camcorder tries to recover data automatically if the data writing was not performed properly.
-

Cannot recover data.

- Writing data onto the media of the camcorder has failed. Attempts were made to recover the data, but they were unsuccessful.
-

  **Reinsert the memory card.**

- Reinsert the memory card a few times. If even then the indicator flashes, the memory card could be damaged. Try with another memory card.
-

  **Cannot recognize this memory card. Format and use again.**

- Format the memory card using the camcorder (p. 70). Note that if you format the memory card, all the recorded movies are deleted.

This memory card may not be able to record or play movies.

- Use a memory card recommended for your camcorder (p. 26).
-

This memory card may not be able to record or play images correctly.

- Use a memory card recommended for your camcorder (p. 26).
 - Contact your Sony dealer.
-

Do not eject the memory card during writing. Data may be damaged.

- Reinsert the memory card, and follow the instructions on the LCD screen.

Other

Maximum number of images already selected.

- You can select only 100 images at one time for:
 - Deleting movies
 - Protecting movies, or releasing the protection
-

Protected file. Cannot delete.

- An attempt was made to delete protected data. Release the protection of the data.

Recording time of movies

Estimated time of recording and playback with each battery pack

Approximate time available when you use a fully charged battery pack.

Recording time

(Unit: minute)

Battery pack	Continuous recording time	Typical recording time
NP-F570	150	75
NP-F970	475	235

Notes

- Recording format AVCHD FX mode
- Using the internal microphone with [VF BRIGHT] set to [NORMAL]
- Using a memory card
- Typical recording time shows the time when you repeat recording start/stop, turning on/off, and so on.
- Both recording and playback time will be shorter when you use your camcorder in low temperatures. It is recommended that you use the camcorder from 10 °C to 30 °C (50 °F to 86 °F).
- The recording and playback time will be shorter depending on the conditions under which you use your camcorder.

Playing time

(Unit: minute)

Battery pack	
NP-F570	240

Estimated recording time of movies

XAVC S 4K

(Unit: minute)

4K (QFHD)	2160	
	60Mbps	100Mbps
64GB	125 (125)	75 (75)

XAVC S HD

	1080
64GB	155 (155)

AVCHD

■ When [AVCHD AUDIO FORMAT] is set to [LINEAR PCM]

(Unit: minute)

	PS	FX	FH	HQ	LP
16GB	70 (70)	80 (80)	110 (110)	185 (145)	295 (250)
32GB	145 (145)	170 (170)	225 (225)	375 (290)	590 (510)
64GB	290 (290)	340 (340)	450 (450)	750 (590)	1190 (1025)

■ When [AVCHD AUDIO FORMAT] is set to [DOLBY DIGITAL]

(Unit: minute)

	PS	FX	FH	HQ	LP
16GB	75 (75)	90 (90)	120 (120)	215 (165)	380 (310)
32GB	150 (150)	180 (180)	245 (245)	440 (330)	770 (630)
64GB	305 (305)	360 (360)	495 (495)	880 (665)	1545 (1260)

Recording time of movies (Continued)

DV

(Unit: minute)

HQ	
16GB	70 (70)
32GB	140 (140)
64GB	280 (280)

- When using Sony memory cards.

Notes

- The recording time may vary depending on the recording conditions, subjects, and [REC SET] (p. 80).
- The number in () is the minimum recordable time.

Tips

- The maximum number of movie scenes that can be recorded is 600 in XAVC S (HD/4K), 3,999 in AVCHD, and 9,999 in DV.
- The maximum continuous recording time is 6 hours for XAVC S 4K, and 13 hours for XAVC S HD. (Files are split after approximately 6 hours).

When recording in AVCHD and DV, the maximum continuous recording time is approximately 13 hours.

- Your camcorder uses the VBR (Variable Bit Rate) format to automatically adjust image quality to suit the recording scene. This technology causes fluctuations in the recording time of the media. Movies containing quickly moving and complex images are recorded at a higher bit-rate, and this reduces the overall recording time.
- Bit-rate (movie + audio, etc.), number of pixels, and aspect ratio of each recording mode of movies are as follows.
 - XAVC S 4K
100 Mbps 3,840×2,160/16:9
60 Mbps 3,840×2,160/16:9
 - XAVC S HD
50Mbps 1,920 × 1,080/16:9

– AVCHD

PS: max. 28 Mbps 1,920 × 1,080/16:9

FX: max. 24 Mbps 1,920 × 1,080/16:9, 1,280 × 720/16:9

FH: approx. 17 Mbps (ave.) 1,920 × 1,080/16:9, 1,280 × 720/16:9

HQ: approx. 9 Mbps (ave.) 1,440 × 1,080/16:9, 1,280 × 720/16:9

LP: approx. 5 Mbps (ave.) 1,440 × 1,080/16:9

– DV

720 × 576/16:9, 4:3

Using your camcorder abroad

Power supply

You can use your camcorder in any country/region using the AC Adaptor supplied with your camcorder within the AC 100V to 240V, 50Hz/60Hz range.

Viewing on TV

The following shows which countries and regions are supported for TV playback.

Argentina, Australia, Austria, Belgium, Brazil, Bulgaria, China, Croatia, Czech Republic, Denmark, Finland, France, French Guiana, Germany, Greece, Hong Kong, Hungary, Indonesia, Iran, Iraq, Italy, Kuwait, Malaysia, Monaco, the Netherlands, New Zealand, Norway, Paraguay, Poland, Portugal, Romania, Russia, Singapore, Slovak Republic, Spain, Sweden, Switzerland, Thailand, Turkey, Ukraine, United Kingdom, Uruguay, Vietnam, etc.

Simple setting of the clock by time difference

When you are abroad, you can easily adjust the clock to the local time by setting the time difference. Select [AREA SET], then set the time difference (p. 90).

File/folder structure on the recording media

The file/folder structure is shown below. You do not usually need to acknowledge the file/folder structure, when recording/playing back movies and still images on the camcorder.

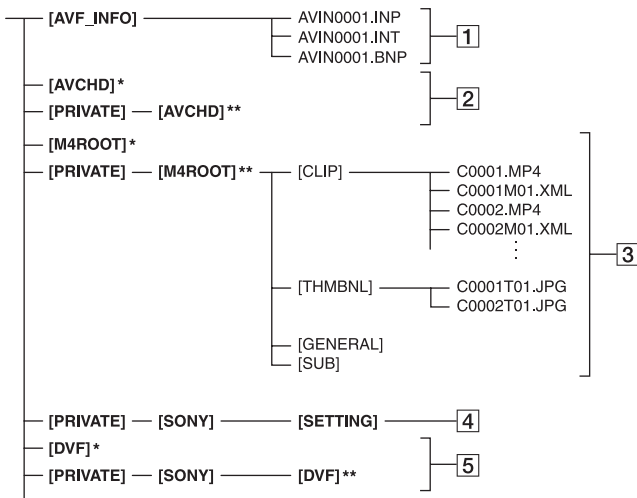

* "Memory Stick PRO Duo"

** SD memory card, SDHC memory card, SDXC memory card

1 Image management files

When you delete the files, you cannot record/play back the images correctly.

The files are defaulted as hidden files and not usually displayed.

2 AVCHD movie management information folder

This folder contains recording data of AVCHD movies. Do not try to open this folder or access the contents of this folder from a computer. Doing so might damage image files, or prevent image files from being played back.

3 XAVC S movie management information folder

This folder contains recording data of XAVC S movie files.

The file numbers go up automatically.

4 Camera profiles

Stores camera profile data.

5 DV movie management information folder

This folder contains recording data of DV movie. Do not try to open this folder or access the contents of this folder from a computer. Doing so might damage image files, or prevent image files from being played back.

- Do not modify the files or folders on the camcorder from the computer. Doing so might damage image files, or prevent image files from being played back.
- Sony accepts no responsibility for the results of operation using data copied from a PC to a memory card.
- When you delete image files, follow the steps on page 69. Do not delete the image files on the camcorder directly from the computer.
- Do not format the recording media in the camcorder using a computer. The camcorder may not operate correctly.
- Do not copy the files on the recording media from a computer. Operation is not guaranteed, if you perform this operation.
- Use "Catalyst Browse" application software to import data from the recording media to a computer.

Maintenance and precautions

About the XAVC S format

Recording and playback on the camcorder

Your camcorder can record 4K (QFHD) and HD (high definition) based on the XAVC S format.

This uses a Long-GOP video compression format for recording.

Video signal*: MPEG-4AVC/H.264
3840×2160/25p, 1920×1080/50p,
1920×1080/25p

Audio signal: LPCM 2 ch

Recording media: Memory card

* The camcorder is not able to play back data that is recorded in XAVC S format using settings other than those described above.

About the AVCHD format

Recording and playback on the camcorder

Based on the AVCHD format, your camcorder records with the HD (high definition) image quality.

Video signal*: MPEG-4AVC/H.264
1920×1080/50p, 1920×1080/50i,
1920×1080/25p, 1440×1080/50i,
1280×720/50p

Audio signal: Dolby Digital 2ch, LPCM 2 ch

Recording media: memory card (sold separately)

* Data recorded in AVCHD format other than the above mentioned cannot be played back on your camcorder.

- Because the AVCHD format uses a data compression system, images may be distorted in scenes where the image, angle, or brightness changes drastically. This is not a malfunction.

About memory cards

- A memory card formatted on a computer does not have guaranteed compatibility with your camcorder.
- Data read/write speed may vary depending on the combination of the memory card and memory card compliant product you use.
- Damaged or lost image data will not be compensated for, and may occur in the following cases:
 - If you eject the memory card, turn the power off on your camcorder, or remove the battery pack for replacement while your camcorder is reading or writing image files on the memory card (while the access lamp is lit or flashing).
 - If you use the memory card near electric fields, magnetic fields, or other sources of electromagnetic noise.
- It is recommended to make a back-up of important data on the hard disk of a computer.
- Do not attach a label or the like on memory card.
- Do not touch, or allow metallic objects to come into contact with the terminals.
- Do not bend, drop or apply strong force to the memory card.
- Do not disassemble or modify the memory card.
- Do not let the memory card get wet.
- Be careful to keep memory card out of the reach of small children. There is danger that a child might swallow it.
- Do not insert anything other than the compliant size of memory card into the memory card slot. Doing so may cause a malfunction.
- Do not use or keep the memory card in the following locations:
 - Places subject to extremely high temperature, such as a car parked outside in the summer
 - Places under direct sunlight
 - Places with extremely high humidity or subject to corrosive gases

On image data compatibility

- Image data files recorded on a memory card by your camcorder conform to the “Design rule for Camera File system” universal standard established by the JEITA (Japan Electronics and Information Technology Industries Association).
- If you cannot use the memory card that has been used with another device, format it with your camcorder (p. 70). Note that formatting erases all information on the memory card.
- You may not be able to play back images with your camcorder:
 - When playing back image data modified on your computer.
 - When playing back image data recorded with other devices.

About “Memory Stick” media

Types of “Memory Stick” media	Recording/ Playback
“Memory Stick Duo” (with MagicGate)	–
“Memory Stick PRO Duo” (Mark2)	Yes
“Memory Stick PRO-HG Duo”	Yes

- This product supports parallel data transfer. However, the transfer speed may differ, depending on the type of media you use.
- This product cannot record or play data that uses “MagicGate” technology. “MagicGate” is a copyright protection technology that records and transfers the contents in an encrypted format.

About the “InfoLITHIUM” battery pack

Your camcorder operates only with an “InfoLITHIUM” L series battery pack of a large capacity, such as NP-F570, NP-F770 (sold separately) or NP-F970 (sold separately). “InfoLITHIUM” L series battery packs have the  mark.

- For safety, use only the Sony battery packs and AC adaptors listed below. NP-F570/NP-F770/NP-F970
- The battery terminal of this unit (the connector for battery packs and AC adaptors) is a consumable part. Power may not be supplied to the unit properly if the pins of the battery terminal are bent or deformed by shock or vibrations, or if they become corroded due to prolonged outdoor use. Periodic inspections are recommended to keep the unit working properly and to prolong its usable lifetime. Contact a Sony service or sales representative for more information about inspections.

What is an “InfoLITHIUM” battery pack?

An “InfoLITHIUM” battery pack is a lithium-ion battery pack that has functions for communicating information related to operating conditions between your camcorder and a supplied AC Adaptor. The “InfoLITHIUM” battery pack displays the remaining battery time in % according to the operating situations of your camcorder.

To use the battery pack effectively





- Battery pack performance decreases when the ambient temperature is 10 °C (50 °F) or below, and the length of time you can use the battery pack becomes shorter. In that case, do one of the following to use the battery pack for a longer time.

– Put the battery pack in a pocket to warm it up, and install it in your camcorder right before you start taking shots.

- Make sure to turn off the camcorder when you are not recording or playing back. The battery pack is also consumed when your camcorder is in recording standby or playback pause.
- Have spare battery packs ready for 2 or 3 times the expected recording time, and make trial recordings before making the actual recording.
- Do not expose the battery pack to water. The battery pack is not water resistant.

About the remaining battery indicator

- Check the level with the following indicators and % displayed on the LCD screen.

Battery remaining indicator	%
	81% to 100%
	51% to 80%
	21% to 50%
	1% to 20%
	–

- The displayed level may not be correct under certain circumstances.
- When the power goes off even though the remaining battery percent indicator indicates that the battery pack has enough power to operate, charge the battery pack fully again. Remaining battery percent will be indicated correctly. Note, however, that the battery indication will not be restored if it is used in high temperatures for a long time, or if left in a fully charged state, or when the battery pack is frequently used. Use the remaining battery percent indication as a rough guide only.

About storage of the battery pack

- If the battery pack is not used for a long time, fully charge the battery pack and use it up on your camcorder once a year to maintain proper function. To store the battery pack, remove it from your camcorder and put it in a dry, cool place.
- To discharge the battery pack on your camcorder completely, leave your camcorder in recording standby until the power goes off.

About battery life

- The battery has a limited lifespan. Battery capacity decreases over time and through repeated use. If decreased usage time between charges becomes significant, it is probably time to replace it with a new one.
- Battery capacity decreases over time and through repeated use. If decreased usage time between charges becomes significant, it is probably time to replace it with a new one.
- Each battery's life is governed by storage, operating and environmental conditions.

About charging the battery pack

- Be sure to charge the battery pack before you start using your camcorder.
- Use the AC Adaptor (supplied) to charge the designated batteries only. If you charge other types of batteries, those batteries may leak, heat up, burst, or give an electric shock, resulting in burns or injury.
- Remove the charged battery from the AC Adaptor.
- The CHG lamp of the supplied AC Adaptor flashes in 2 patterns as follows:
Fast-flashing...Turns on and off rapidly at about 0.15-second intervals.
Slow-flashing...Turns on and off alternately for about 1.5 seconds, and turns off completely for about 1.5 seconds. The lamp repeats this sequence.
- If the CHG lamp is fast-flashing, remove the battery that is being charged, and then re-attach the same battery again firmly. If the CHG lamp continues fast-flashing, the cause could be that the battery is damaged, or the battery is not a designated type. Check the battery to confirm whether it is a designated type or not. If it is a designated type, remove the battery first, and then attach a brand-new battery or another known-to-be-good battery to see if the AC Adaptor is working correctly. If the AC Adaptor is working correctly, the cause could be that the battery is damaged.
- If the CHG lamp is slow-flashing, the AC Adaptor is in standby mode and charging is suspended. When the ambient temperature is out of the appropriate temperature range for charging, the AC Adaptor suspends charging automatically and enters standby mode. When the ambient temperature returns to an

Maintenance and precautions (Continued)

appropriate temperature, the AC Adaptor restarts charging and the CHG lamp lights up.

- We recommend charging the battery pack in an ambient temperature of from 10 °C to 30 °C (50 °F to 86 °F) until the charge lamp of the camcorder turns off. If you charge the battery pack outside of this temperature range, you may not be able to charge it efficiently.

About consumable parts

- The fan and battery are consumable parts that will need periodic replacement.
When operating at room temperature, a normal replacement cycle will be about 5 years. However, this replacement cycle represents only a general guideline and does not imply that the life expectancy of these parts is guaranteed. For details on parts replacement, contact your dealer.
- The life expectancy of the AC adaptor and the electrolytic capacitor is about 5 years under normal operating temperatures and normal usage (8 hours per day; 25 days per month). If usage exceeds the above normal usage frequency, the life expectancy may be reduced correspondingly.

About handling of your camcorder

On use and care

- Do not use or store the camcorder and accessories in the following locations.
 - Anywhere extremely hot or cold.
Never leave them exposed to temperatures above 60 °C (140 °F), such as under direct sunlight, near heaters or in a car parked in the sun. They may malfunction or become deformed.
 - Near strong magnetic fields or mechanical vibration.
The camcorder may malfunction.
 - Near strong radio waves or radiation.
The camcorder may not be able to record properly.
 - Near AM receivers and video equipment.
Noise may occur.
 - On a sandy beach or anywhere dusty.
If sand or dust gets in your camcorder, the camcorder may malfunction. Sometimes this malfunction cannot be repaired.
- Near windows or outdoors, where the LCD screen, the viewfinder, or the lens may be exposed to direct sunlight.
This damages the inside of the viewfinder or the LCD screen.
- Anywhere very humid.
- Operate your camcorder on 7.2 V (battery pack) or 8.4 V DC (AC Adaptor).
- For DC or AC operation, use the accessories recommended in these operating instructions.
- Do not let your camcorder get wet, for example, from rain or sea water. If your camcorder gets wet, it may malfunction. Sometimes this malfunction cannot be repaired.
- If any solid object or liquid gets inside the casing, unplug your camcorder and have it checked by a Sony dealer before operating it any further.
- Avoid rough handling, disassembling, modifying, physical shock, or impact such as hammering, dropping or stepping on the product. Be particularly careful of the lens.
- Do not use a deformed or damaged battery pack.
- Keep the  (On/Standby) switch set to the standby position when you are not using your camcorder.
- Do not wrap your camcorder with a towel, for example, and operate it. Doing so might cause heat to build up inside.
- When disconnecting the power cord (mains lead), pull it by the plug and not the lead.
- Do not damage the power cord (mains lead) such as by placing anything heavy on it.
- Keep metal contacts clean.
- Keep the Wireless Remote Commander and button-type battery out of children's reach. If the battery is accidentally swallowed, consult a doctor immediately.
- If the battery electrolytic liquid has leaked,
 - consult your local authorized Sony service facility.
 - wash off any liquid that may have contacted your skin.
 - if any liquid gets in your eyes, wash with plenty of water and consult a doctor.

■ When not using your camcorder for a long time

- Turn on the camcorder and record and play back images about once a month to keep it in an optimum state for a long time.
- Use up the battery pack completely before storing it.

Moisture condensation

If the unit is suddenly taken from a cold to a warm location, or if ambient temperature suddenly rises, moisture may form on the outer surface of the unit and/or inside of the unit. This is known as condensation. If condensation occurs, turn off the unit and wait until the condensation clears before operating the unit. Operating the unit while condensation is present may damage the unit.

LCD screen

- Do not exert excessive pressure on the LCD screen, as it may cause damage.
- If your camcorder is used in a cold place, a residual image may appear on the LCD screen. This is not a malfunction.
- While using your camcorder, the back of the LCD screen may heat up. This is not a malfunction.

■ To clean the LCD screen

The LCD screen is covered with a coating. The coating may be peeled off by scratching or rubbing. Maintain the LCD screen as follows.

- Wipe fingerprints or hand cream off the LCD screen as soon as possible, as they may cause the coating to peel off.
- If you rub the LCD screen hard, even with a tissue, the coating may be damaged.
- Before wiping the LCD screen, blow dust or sand off with a dust blower, etc.
- Wipe dirt off the LCD screen with a clean, soft cloth, such as an eye glass cleaning cloth, etc.

Casing

- If the casing is soiled, clean the camcorder body with a soft cloth lightly moistened with water, and then wipe the casing with a dry soft cloth.
- Avoid the following to prevent damage to the finish.
 - Using chemicals such as thinner, benzene, alcohol, chemical cloths, repellent, insecticide and sunscreen.

- Handling with above substances on your hands.
- Leaving the casing in contact with rubber or vinyl objects for a long period of time.

Care and storage of the lens

- Wipe the surface of the lens clean with a soft cloth in the following instances: when there are fingerprints on the lens surface, in hot or humid locations, and when the lens is exposed to salty air such as at the seaside.
- Store in a well-ventilated location subject to little dirt or dust.
- To prevent mold, periodically clean the lens as described above.

Charging the pre-installed rechargeable battery

Your camcorder has a pre-installed rechargeable battery to retain the date, time, and other settings even when the Keep the  (On/Standby) switch is set to STANDBY. The pre-installed rechargeable battery is always charged while your camcorder is connected to the wall outlet (wall socket) via the AC Adaptor or while the battery pack is attached. The rechargeable battery will be fully discharged in about **3 months** if you do not use your camcorder at all, with the AC Adaptor not connected or battery pack not attached. Use your camcorder after charging the pre-installed rechargeable battery.

However, even if the pre-installed rechargeable battery is not charged, the camcorder operation will not be affected as long as you are not recording the date.

■ Charging procedure

Connect your camcorder to a wall outlet (wall socket) using the supplied AC Adaptor, and leave it with the power turned off for more than 24 hours.

Note on disposal/transfer of memory cards

Even if you delete data in the memory card or format the memory card on your camcorder or a computer, you may not delete data from the memory card completely. When you give the memory card to somebody, it is recommended that you delete data completely using data deletion software on a computer. Also, when you dispose of the memory card, it is recommended that you destroy the actual body of the memory card.

Operation is not guaranteed when using a card adaptor.

Specifications

General

Power requirements

8.4 V DC (using AC Adaptor)

7.2 V DC (using battery pack)

Power consumption

While recording AVCHD using viewfinder:

Approx. 5.7 W

While recording AVCHD using LCD screen:

Approx. 5.9 W

Operating temperature

0 °C to 40 °C (32 °F to 104 °F)

Storage temperature

-20 °C to +60 °C (-4 °F to +140 °F)

Dimensions

171.3 mm × 187.8 mm × 371.3 mm

(6 3/4 in. × 7 1/2 in. × 14 5/8 in.)

(Including projecting parts, lens hood, large eyecup, and battery (NP-F570).

Excluding the grip belt.) (width / height / depth)

Mass

Approx. 1.8 kg (3 lb. 15 oz.) (body only)

Approx. 2.1 kg (4 lb. 10 oz.) (Including lens hood, eyecup, and battery (NP-F570))

System

Video signal

PAL color, CCIR standards

HDTV 1080/50i, 1080/50p, 720/50p

Video recording system

XAVC S: MPEG-4 AVC/H.264 4:2:0

Long profile

AVCHD: MPEG-4 AVC/H.264

AVCHD 2.0 format compatible

SD image quality: DV standard compatible

Audio recording system

XAVC S: Linear PCM 2ch, 16-bit, 48 kHz

AVCHD: Linear PCM 2ch, 16-bit, 48 kHz/Dolby Digital 2ch, 16-bit, 48 kHz

DV: Linear PCM 2ch, 16-bit, 48 kHz

Recording media

Memory Stick PRO Duo™ and SD card

Camera

Imaging device

1.0-inch type ExmorR CMOS sensor

Total picture elements: Approx.

20,900,000 pixels

Effective picture elements (16:9 mode):

Approx. 14,200,000 pixels

Effective picture elements (4:3 mode):

Approx. 10,600,000 pixels

Color temperature

Preset (Indoor: 3200K, Outdoor: 5600K

± 7 steps, Color temperature set range:

2300K to 15000K), One-push A, B,

Auto selectable

Minimum illumination

7.5 lux (1/50 shutter speed, auto iris/gain)

1.7 lux (LOW LUX mode: On)

Shutter speed

1/6 sec. to 1/10,000 sec.

Slow & Quick Motion

1080p, frame rate selectable

Gain

-3, 0, 3, 6, 9, 12, 15, 18, 21, 24, 27, 30,

33 dB, AGC

Gamma curve

Selectable

Built-in ND filter

CLEAR: Off

1: 1/4ND

2: 1/16ND

3: 1/64ND

Specifications (Continued)

Lens

Lens mount

Fixed

Zoom ratio

12× (optical), servo

Focal Length

f=9.3 mm to 111.6 mm

(equivalent to f=29.0 mm to 348.0 mm on 35 mm lens (16:9))

(equivalent to f=35.5 mm to 426.0 mm on 35 mm lens (4:3))

Iris

F2.8 to F11 (auto/manual selectable)

Focus

Auto/manual selectable

10 mm to ∞ (Wide)

1000 mm to ∞ (Tele)

Image stabilizer

On/Off selectable, shift lens

Filter diameter

M62 mm

Input/output connectors

VIDEO OUT jack

BNC type (1), Composite

1.0 V_{p-p}, 75 Ω

AUDIO OUT jacks

Pin jacks

HDMI OUT jack

Type A (1)

USB jack

Multi/Micro USB jack (1)

🔊 (headphones) jack

Stereo mini jack (ø3.5 mm) (1)

INPUT1/INPUT2 jacks

XLR-type 3-pin (female) (2), line/mic/
mic +48 V selectable

DC input

DC IN jack

Remote jack

Stereo mini jack (ø2.5 mm) (1)

Multi Interface Shoe (1)

7.2 V DC, 0.15 A

Screen

LCD screen

8.8 cm (3.5 type)

Approx. 1.56M dots.

Viewfinder

0.6 cm (0.24 type)

Approx. 1.56M dots.

Internal microphone

Omni-directional stereo electret
condenser microphone

AC Adaptor

Power requirements

100 V to 240 V AC, 50 Hz/60 Hz

Output voltage

8.4 V DC

* See the label for other specifications.

Rechargeable battery pack (NP-F570)

Maximum output voltage

8.4 V DC

Output voltage

7.2 V DC

Capacity

Typical: 15.8 Wh (2,200 mAh)

Minimum: 15.0 Wh (2,100 mAh)

Type

Li-ion

DC battery charger (BC-L1)

Input rating

8.4 V DC

Output rating

8.4 V DC, 1.7 A

Operating temperature

0 °C to 40 °C (32 °F to 104 °F)

Storage temperature

-20 °C to +60 °C (-4 °F to +140 °F)

Dimensions

Approx. 72 mm × 20.5 mm × 96.5 mm
(2 7/8 in. × 13/16 in. × 3 7/8 in.)
(width / height / depth)

Mass

Approx. 60 g (2.1 oz)

Optional accessories

Electret condenser microphone

ECM-VG1, ECM-MS2

Remote commander

RM-30BP

Battery video light compatible with the

Multi Interface Shoe

HVL-LBPC

Notes

- Always make a test recording, and verify that it was recorded successfully.
SONY WILL NOT BE LIABLE FOR DAMAGES OF ANY KIND INCLUDING, BUT NOT LIMITED TO, COMPENSATION OR REIMBURSEMENT ON ACCOUNT OF FAILURE OF THIS UNIT OR ITS RECORDING MEDIA, EXTERNAL STORAGE SYSTEMS OR ANY OTHER MEDIA OR STORAGE SYSTEMS TO RECORD CONTENT OF ANY TYPE.
- Always verify that the unit is operating properly before use. SONY WILL NOT BE LIABLE FOR DAMAGES OF ANY KIND INCLUDING, BUT NOT LIMITED TO, COMPENSATION OR REIMBURSEMENT ON ACCOUNT OF THE LOSS OF PRESENT OR PROSPECTIVE PROFITS DUE TO FAILURE OF THIS UNIT, EITHER DURING THE WARRANTY PERIOD OR AFTER EXPIRATION OF THE WARRANTY, OR FOR ANY OTHER REASON WHATSOEVER.
- SONY WILL NOT BE LIABLE FOR CLAIMS OF ANY KIND MADE BY USERS OF THIS UNIT OR MADE BY THIRD PARTIES.
- SONY WILL NOT BE LIABLE FOR THE LOSS, REPAIR, OR REPRODUCTION OF ANY DATA RECORDED ON THE INTERNAL STORAGE SYSTEM, RECORDING MEDIA, EXTERNAL STORAGE SYSTEMS OR ANY OTHER MEDIA OR STORAGE SYSTEMS.
- SONY WILL NOT BE LIABLE FOR THE TERMINATION OR DISCONTINUATION OF ANY SERVICES RELATED TO THIS UNIT THAT MAY RESULT DUE TO CIRCUMSTANCES OF ANY KIND.

Index

A

AC Adaptor18, 19
AE SHIFT.....78, 97
AGC LIMIT77
AREA SET90
ASPECT.....85
ASSIGN BUTTON58
AUDIO LEVEL
DISPLAY87
AUDIO LIMIT82
AUDIO SET menu82
AUTO BACK LIGHT79
AUTO MODE SET79
AVCHD AUDIO
FORMAT82

B

Battery19
Battery pack.....110
BEEP91
BLACK GAMMA.....49
BLACK LEVEL.....49

C

CAMERA DATA
DISPLAY86
CAMERA PROFILE.....90
CAMERA SET menu.....77
CENTER85
Charging time20
CHG lamp.....19
CLOCK SET22
COLOR BAR80, 97
COLOR DEPTH.....51
COLOR MODE.....50
COLOR PHASE.....51
Connect
TV65
CONVERSION LENS79

D

DATA CODE 63, 87
DATE REC 91
Date and time 14, 22, 23
DELETE 69
DETAIL 53
D. EXTENDER 78
DISPLAY OUTPUT..... 88
Display output..... 88
DISPLAY SET menu..... 84
DIVIDE..... 68
DOWN CONVERT TYPE.. 81
DV MODE..... 37
DV WIDE CONVERT 81
DV WIDE REC 80

F

FACE DETECTION..... 34
Focus..... 33
FOCUS DISPLAY..... 87
FOCUS MAG RATIO..... 86
Focus Magnifier..... 33
Focus ring 33
Format media 70
FREE RUN 89
FULL AUTO 45

G

Gain..... 39
GAMMA..... 49
Getting started..... 18
GUIDEFAME 86

H

Handle record button 31
Handle zoom 32
Handle zoom lever 32
HDMI 81
HDMI REC CONTROL 82

HDMI TC OUTPUT 81
HISTOGRAM 84

I

Image database file.....71
INDOOR41
INITIALIZE.....92
INPUT1 TRIM83
INPUT1 WIND83
INPUT2 TRIM84
INPUT2 WIND84
INT MIC SET.....83
Iris.....38
Iris ring38

K

KNEE50

L

LANGUAGE.....91
Large eyecup25
LAST SCENE REVIEW.....56
LCD BRIGHT88
Lens7, 113
LOW LUX.....46

M

MANU WB TEMP.....41
MARKER.....85, 97
MEDIA FORMAT70
Memory card109
inserting/ejecting.....26
“Memory Stick” media.....110
Menu.....72
AUDIO SET.....82
CAMERA SET77
DISPLAY SET.....84
items74
OTHERS90
REC/OUT SET80
TC/UB SET.....88

MIC+48V	42
Moisture condensation	113
Movie	28

N

ND filter	40
NIGHTSHOT LIGHT	79
Number of movies	105

O

OPERATION TIME	92
OTHERS menu	90
OUTDOOR	41
Output resolution	66

P

PEAKING	85, 97
PICTURE PROFILE	47, 80
Playback	60
Power cord	19
Power outlet	21
Power zoom lever	32
Pre-installed rechargeable battery	113
PROTECT	68

R

REC BUTTON SET	31
REC FORMAT	36
REC LAMP	91
REC/OUT SET menu	80
REC RUN	89
REC SET	80
Rechargeable battery pack	19
Record button	31
Recording	28
Recording format	36
Recording time	105
Relay recording	30
REMOTE CONTROL	12, 91

REPAIR IMAGE DB FILE	71
-------------------------------	----

S

SAFETY ZONE	86
SATURATION	51
SCENE SELECTION SET	45
Screen indicators	13, 63
Self-diagnosis display	102
Shooting	28
SHUTTER DISPLAY	87
Shutter speed	39
SIMUL/RELAY REC	31
Simultaneous recording	31
S&Q MOTION	55
Slow & Quick Motion	55
Specifications	115
STATUS CHECK	64, 90
STEADYSHOT	79
SUMMERTIME	91
Supplied accessories	18

T

TC MAKE	89
TC PRESET	54, 97
TC RUN	89
TC/UB DISPLAY	88
TC/UB SET menu	88
Telephoto	32
TONE	80
Trademark	120
Troubleshooting	93
TV	65

U

UB PRESET	54
UB TIME REC	89
USB CONNECT	91
USB LUN SET	91

Using your camcorder abroad	107
--------------------------------------	-----

V

VERSION DISPLAY	92
VF BRIGHT	88
VIDEO LIGHT	79
VIDEO OUT	81
Viewfinder	24
dioptr adjustment dial	24
VOLUME	62, 82

W

Warning indicators	102
WB OUTDOOR LEVEL	77
WB PRESET	77
WB SET	78
WB SHIFT	53
WB TEMP SET	77
White balance	41
Wide angle	32



X

XLR AGC LINK	83
XLR SET	83

Z

ZEBRA	85, 97
Zoom	32
ZOOM DISPLAY	87
Zoom ring	32
ZOOM SET	78

Trademarks

- “NXCAM” logo is a trademark of Sony Corporation.
- “XAVC S” and  are registered trademarks of Sony Corporation.
- “AVCHD Progressive” and “AVCHD Progressive” logotype are trademarks of Panasonic Corporation and Sony Corporation.
- “Memory Stick,”  “Memory Stick Duo,” “Memory Stick PRO Duo,” and “Catalyst Browse” are trademarks or registered trademarks of Sony Corporation.
- “InfoLITHIUM” is a trademark of Sony Corporation.
- “BRAVIA” is a trademark of Sony Corporation.
- Dolby and the double-D symbol are trademarks of Dolby Laboratories.
- The terms HDMI and HDMI High-Definition Multimedia Interface, and the HDMI Logo are trademarks or registered trademarks of HDMI Licensing LLC in the United States and other countries.
- SDXC logo is a trademark of SD-3C, LLC.

All other product names and brand names are registered trademarks or trademarks of their respective owners. Trademarked items are not indicated by ® or ™ symbols in this manual.

Notes on the License

THIS PRODUCT IS LICENSED UNDER THE AVC PATENT PORTFOLIO LICENSE FOR THE PERSONAL USE OF A CONSUMER OR OTHER USES IN WHICH IT DOES NOT RECEIVE REMUNERATION TO

(i) ENCODE VIDEO IN COMPLIANCE WITH THE AVC STANDARD (“AVC VIDEO”) AND /OR

(ii) DECODE AVC VIDEO THAT WAS ENCODED BY A CONSUMER ENGAGED IN A PERSONAL ACTIVITY AND/OR WAS OBTAINED FROM A VIDEO PROVIDER LICENSED TO PROVIDE AVC VIDEO.

NO LICENSE IS GRANTED OR SHALL BE IMPLIED FOR ANY OTHER USE.

ADDITIONAL INFORMATION MAY BE OBTAINED FROM MPEG LA, L.L.C.
SEE <[HTTP://WWW.MPEGLA.COM](http://www.mpegla.com)>

Software is installed in your camcorder. We provide this software based on the license agreements of the copyright owners. Based on requests by the owners of copyright of these software applications, we have an obligation to inform you of the following.

Licenses (in English) are recorded in the internal memory of your camera. Establish a Mass Storage connection between the camera and a computer to read licenses in the “PMHOME” - “LICENSE” folder.

On GNU GPL/LGPL applied software

The software that is eligible for the following GNU General Public License (hereinafter referred to as “GPL”) or GNU Lesser General Public License (hereinafter referred to as “LGPL”) are included in the product.

This informs you that you have a right to have access to, modify, and redistribute source code for these software programs under the conditions of the supplied GPL/LGPL.

Source code is provided on the web. Use the following URL to download it.

<http://oss.sony.net/Products/Linux/>

We would prefer you do not contact us about the contents of source code.

Licenses (in English) are recorded in the internal memory of your product. Establish a Mass Storage connection between the product and a computer to read licenses in the “PMHOME” - “LICENSE” folder.

