

44BDL8128L
44BDL8139L
44BDL8148L

V1.00



www.philips.com/welcome

User Manual (English)

PHILIPS

SignageSolutions

Table of contents



| | |
|---|----|
| 1. Read this first..... | 3 |
| 1.1 Warning & Symbols | 3 |
| 1.2 Safety guidelines..... | 3 |
| 1.3 Electrical requirements..... | 6 |
| 1.4 Cleaning | 8 |
| 1.5 Storage | 8 |
| 2. Preparations | 9 |
| 2.1 Unpacking | 9 |
| 2.2 Holding the cabinet..... | 10 |
| 3. Product overview | 11 |
| 3.1 Rear view..... | 11 |
| 3.2 Side View..... | 11 |
| 3.3 Top view | 12 |
| 3.4 Bottom view | 12 |
| 3.5 Testing the cabinet | 13 |
| 4. Installation and Connection..... | 14 |
| 4.1 Mounting the cabinets..... | 16 |
| 4.2 Connecting the signal and power cables..... | 20 |
| 5. Using the LED display controller | 22 |
| Appendices | 23 |
| Appendix A. Troubleshooting..... | 23 |
| Appendix B. Dew point VS. Relative Humidity | 24 |
| Appendix C. Optional Components/Accessories..... | 25 |
| Appendix D. Technical Specifications..... | 28 |

1. Read this first

The latest User's Manual, Quick Start Guide and FAQ are available for download from the Philips website.

1.1 Warning & Symbols

Refer to the following graphic symbols to alert you to important information:

-  Notes: useful information that help you get better use of the product.
-  Cautions: notices describing actions that may damage your product.
-  Warnings: instructions that must be followed. Failure to observe may damage your product.

1.2 Safety guidelines

-  Use of controls, adjustments or procedures other than those specified in this documentation may result in exposure to shock, electrical hazards and/or mechanical hazards.

Read and follow these instructions when connecting and using your LED display:

Operation

- Keep the LED display out of direct sunlight and away from stoves or any other heat sources.
- When positioning the LED display, make sure the power plug and outlet are easily accessible.
- Ensure the use of an approved power cable provided by Philips at all times. If your power cable is missing, please contact your local service center.
- Do not subject the display to severe vibration or high impact conditions during operation.
- Do not knock or drop the display during operation or transportation.

- In order to maintain the best performance of your display and ensure a longer lifetime, we strongly recommend using the display in a location that falls within the following temperature and humidity ranges.

- Temperature: -20°C to 45°C (-4°F -113°F)
- Humidity: 10% to 80% RH, non-condensing

⚠ Avoid rapid decrease in temperature when the relative humidity is high, as it increases the risk of condensation forming. (see Appendix B. Dew point VS. Relative Humidity on P. 24)

- 🔧 If your display does not operate normally, having followed the instructions set out in this document, please contact a technician or your local service center.

Maintenance

- To protect your display from possible damage, do not put excessive pressure on the LED panel.
- Unplug the LED display if you are not going to use it for an extensive period of time.
- If a foreign substance or water gets in your display, turn the power off immediately and disconnect the power cable. Then remove the foreign substance or water, and send the unit to the maintenance center.
- Do not store the LED display in locations exposed to water, excessively moist environment, heat, direct sunlight or extreme cold.

Grounding

- The combination of multiple cabinets in an installation results in increased levels of leakage current.
- In order to avoid risk of electric shock due to high leakage current, proper grounding of the installation is required.
- Defeating the purpose of the grounding type plug will expose you to the risk of electric shock.

Electricity and Safety

- Do not use a damaged cable as it may result an electrical shock.
- Do not touch the power plug with wet hands as it may result an electrical shock.

- Do not use a loose power plug, an unsecure connection may cause a fire.
- Do not cut, bend, modify, place heavy objects, or step on the power cable.
- Do not use this display near heat sources or in the presence of flammable substances.
- To avoid electrical shock, use only supplied power cables and connect only to properly grounded wall outlets.
- Do not disconnect the power cable while the display is being used.
- Do not block or otherwise obstruct access to the power plug at the wall.
- Be extremely cautious when installing or moving this product.
- The display has been calibrated prior to shipment from the factory. Improper modifications will void your warranty.
- Improper installation of peripherals/accessories may cause damage to the product.
- Do not lift the cabinet by the power cable or any cable. If any cable disconnects, a product failure may result.
- Any attempt to disassemble the product and the accessories by unauthorized personnel may cause damage to the product or result in personal injury.

Personal protection

- Do not use the product for any application until you have read, understood, and know all the safety information contained in this user's guide. Operating the display without a proper awareness of safe use could lead to serious personal injury.
- Mind yourself while working with heavy loads and high voltage.
- Contact with high voltage may cause death or serious injury. Always disconnect power to the display cabinet or cabinets prior to servicing.

- All personnel at the LED Video Board installation site are required to have personal protection equipment (PPE) such as hard hats, safety glasses, gloves, harnesses, and other appropriate safety equipment.

Equipment protection

- This installation must be performed by authorized and qualified technical personnel only.
- Accredited safety officers must ensure the safety of the site, construction, assembly, connection, use, dismantling, transport etc.
- Assembly parts are designed for use only with Philips displays.
- LEDs use specific materials and manufacturing processing in order to achieve unique advantages. Do not modify and/or replicate any components.
- Ground the LED display screen before connecting the power source. Contacting displays that are not earth-grounded may cause death or serious injury.
- Structural & mounting components should be kept dry, clean, lubricated (only if recommended), coated properly, and maintained in a manner consistent with part design.
- LED products must be installed and operated in a manner to reply on its design and inspection a routine basis for security, wear, deformation, corrosion and any other circumstances that may affect the load handling capability of the part.
- We recommend inspections at regular intervals for all installations and increasing in frequency for more critical installations. A part is damaged which may cause a decrease in load capability. The part must be removed for service or replaced immediately.
- Always follow LED display screen installation instruction.
- Contact the support technical person if user has any question regarding the safety of an application. The manufacturer assumes no liability for incorrect, inadequate, irresponsible or unsafe assembly of systems.

1.3 Electrical requirements

Power system

- Power voltage must be in the range of the specification value.
- It is recommended to use a power distribution system (a power distribution system with a separate neutral and grounding conductor in order to avoid large ground current loops due to voltage differences in the neutral conductor).

- The total electrical installation should be protected by an appropriately rated disconnect switch, circuit breakers.
- The electrical installation must only be performed by a qualified electrician. Electrical connections must comply with all applicable national and local codes.

Cabling & Connection

- All internal cabling must be properly connected and seated.
- All power wiring must be from circuit breaker protected lines. Do not connect to an unprotect circuit.
- Do not route power and communication wires in the same conduit. Separate conduits must be run for communication wires and power wires. However, fiber optic wire may be run in the same conduit with power wires.

Grounding

- The LED display screen must be properly grounded according the applicable national and local codes.
- Properly grounding every display cabinet is necessary as it is essential to prevent shock, shock hazards, and fire hazards.

Lighting Strike Protection

- A LED display screen cabinet bonder to an earth ground aims to dissipate the high voltage and current from a lighting strike. The resistance of the grounding electrode must be as low as possible. However, damage can still occur to a LED display screen cabinet's electronic equipment from lighting voltage transients.
- Though some surge protection is incorporated into a LED display screen in order to protect the display from high voltage lighting transients, surge protectors need to be installed.

1.4 Cleaning

If the LED display/cabinet becomes dusty, use an air blower which can produce air flow to blow away dust.

Cautions when cleaning the display:

- ⚠ Do not use a wet cloth to clean the LED display.
- ⚠ Do not allow water or other liquid to enter the LED display.
- ⚠ Do not use tool that generate large amount of static electricity, such as a bristle brush.
- ⚠ The front of the LED display has been specially treated. Do not touch the surface of the LED display with fingernails or any hard object, otherwise the LED elements may fall off.

1.5 Storage

If you are not going to use it for an extensive period of time, unplug the display and keep the product in a dry and well-ventilated location.

2. Preparations

2.1 Unpacking

 Warning:

To prevent damage to the LED panel, wear anti-static gloves before installing/touching the display.

1. Use a pair of scissors to cut sealing tape on the cardboard box.
2. Carefully take the cabinet and accessories out of the cardboard box.
3. After opening the cardboard box, ensure that the contents are complete and in good condition.

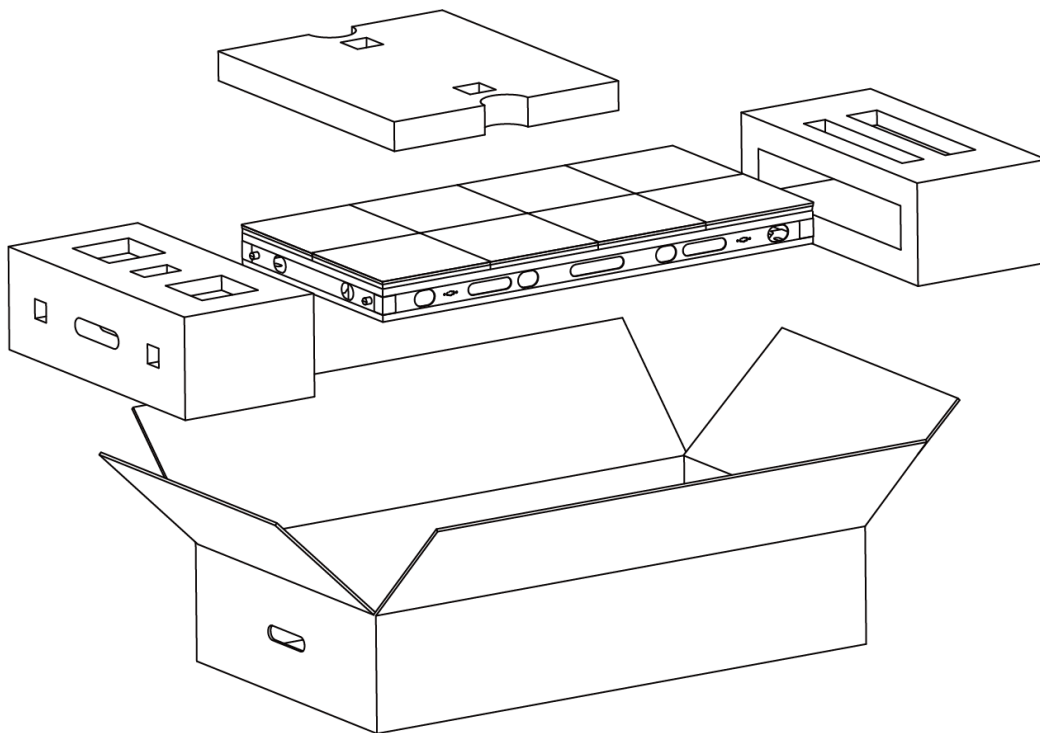

Please verify that you received the following items with your package content:

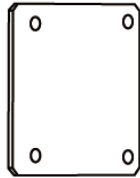

Connecting plate: 3 pcs



Screw bolt: 4 pcs
(M10*70)



Quick start guide

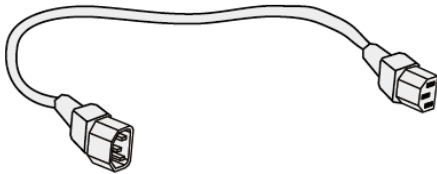

Power cable: 1 pcs

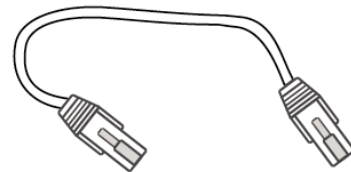

LAN cable (RJ45, CAT-5): 1 pcs

* Display design and accessories may differ from those illustrated above

2.2 Holding the cabinet

Warning:

To prevent damage to the LED, do NOT touch the edge of each LED module when holding the cabinet by hand.

Refer to the illustration below for the recommended manner of holding a cabinet.

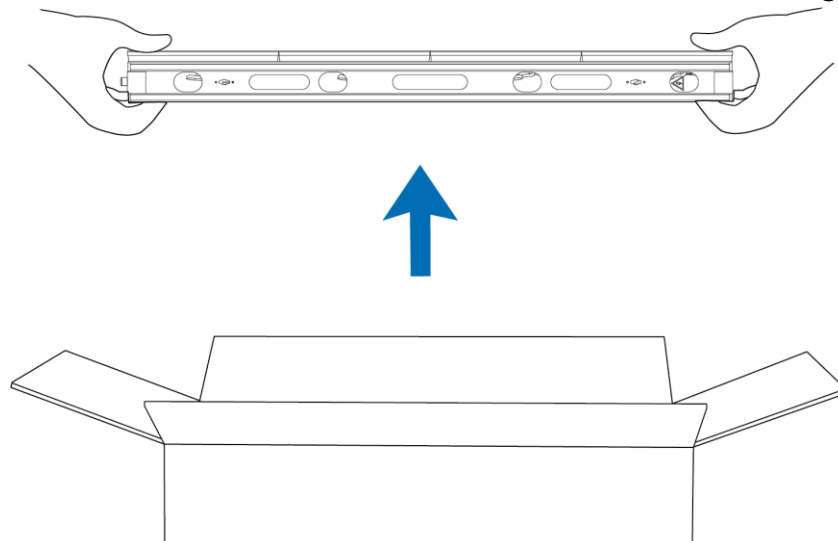

3. Product overview

3.1 Rear view

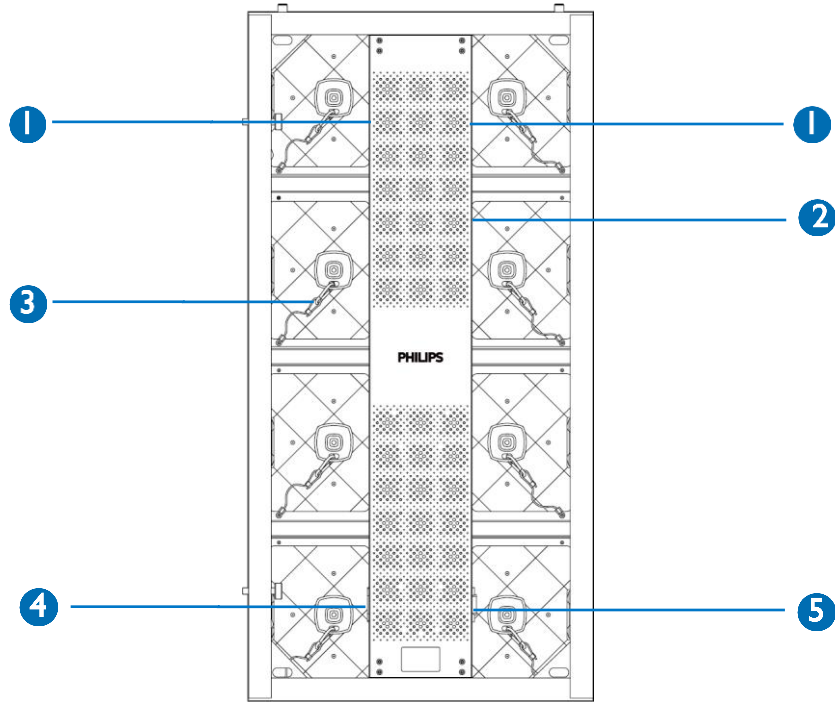

3.2 Side View

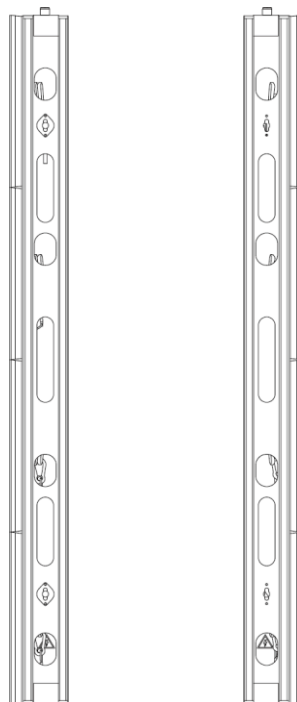

3.3 Top view



3.4 Bottom view



| No. | Component |
|-----|---|
| 1 | Signal connector (s) |
| 2 | CHK button (see 3.5 Testing the cabinet on P. 13) |
| 3 | Security cord |
| 4 | Power Out connector |
| 5 | Power In connector |
| 6 | Guide pin (s) |

⚠ The Signal connector is an RJ45 connector, but it cannot be connected with a network switch or common computer networking device as it is not compatible.

3.5 Testing the cabinet

1. Power on the product by connecting the power cable from the cabinet to the power outlet.
 2. Press the **CHK** button to check if the product can operate normally.
 3. Check whether each color is displayed normally on the screen from the front side of the display.
- To test the cabinet, a power cable that connects from the cabinet to the power outlet is required (but not provided).

4. Installation and Connection

⚠ Precautions when handling the cabinets:

- Do not drop or apply shock/vibration to the product. Strong impacts may damage the component inside.
- Only a qualified service technician should perform installation.
- Only use approved cabinets.
- Be careful not to damage the corners of the cabinet.
- Install the display in a well-ventilated area.
- After removing the protective brackets, do not place the display with the LED facing down, the LED display may become damaged.
- Always wear anti-static gloves before touching the display.
- Provide air conditioning around the LED display to allow heat dissipation away from the display.
- To maintain proper ventilation, keep clear space from the mounted displays to the wall. (Refer to the diagram below for the recommended distance between the LED display and wall). Installing the product in poorly ventilated spaces may damage the LED.

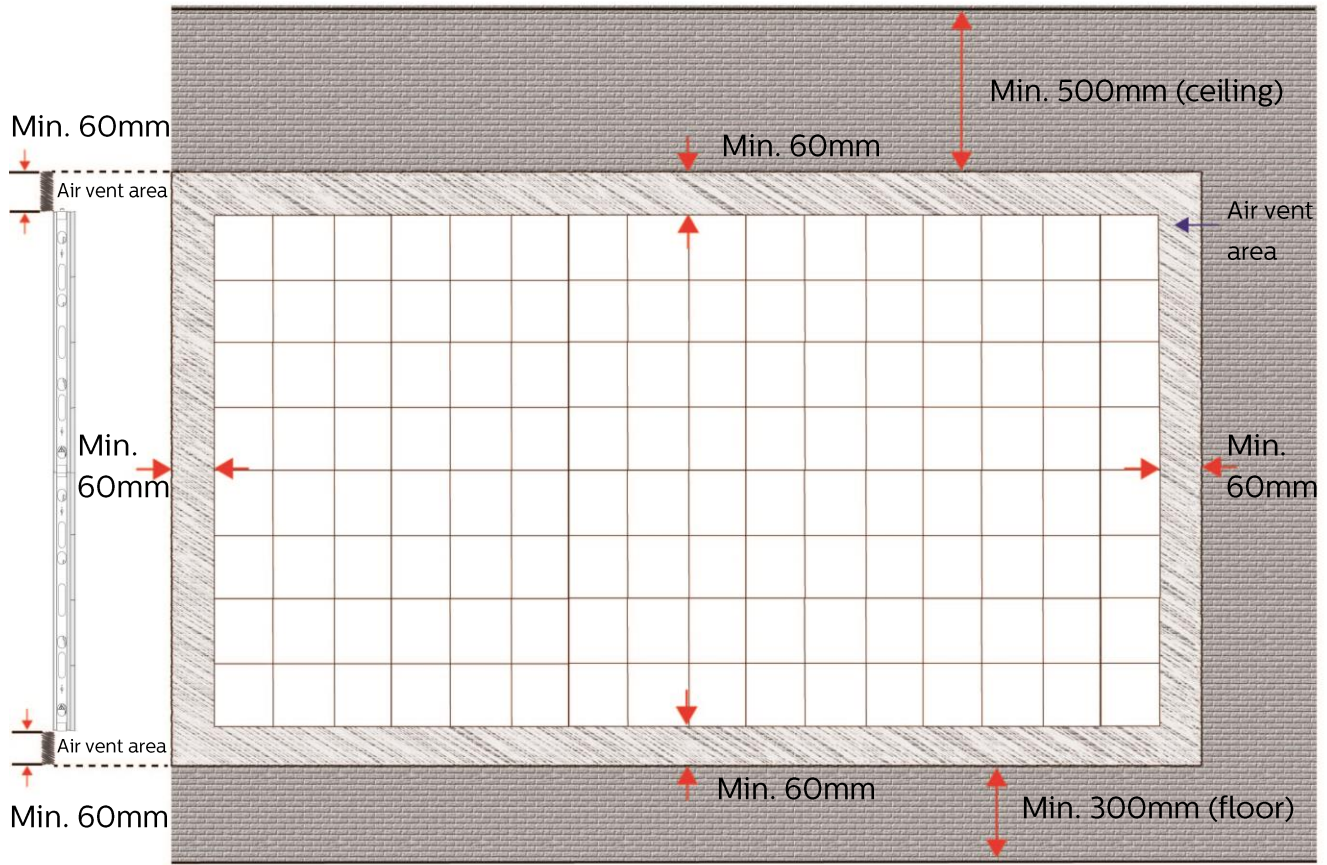

4.1 Mounting the cabinets

A wall mount kit (in some regions sold separately or available from third party vendors) allows you to mount the LED display on the wall. For detailed information on installing the wall mount, see the instructions provided with the wall mount.

The LED display can only be mounted to the mounting bracket from its front side, remove the module first using the dedicated magnetic tool (not provided).

1. Align the guide pins with the holes on the next cabinet, then connect 4 cabinets.

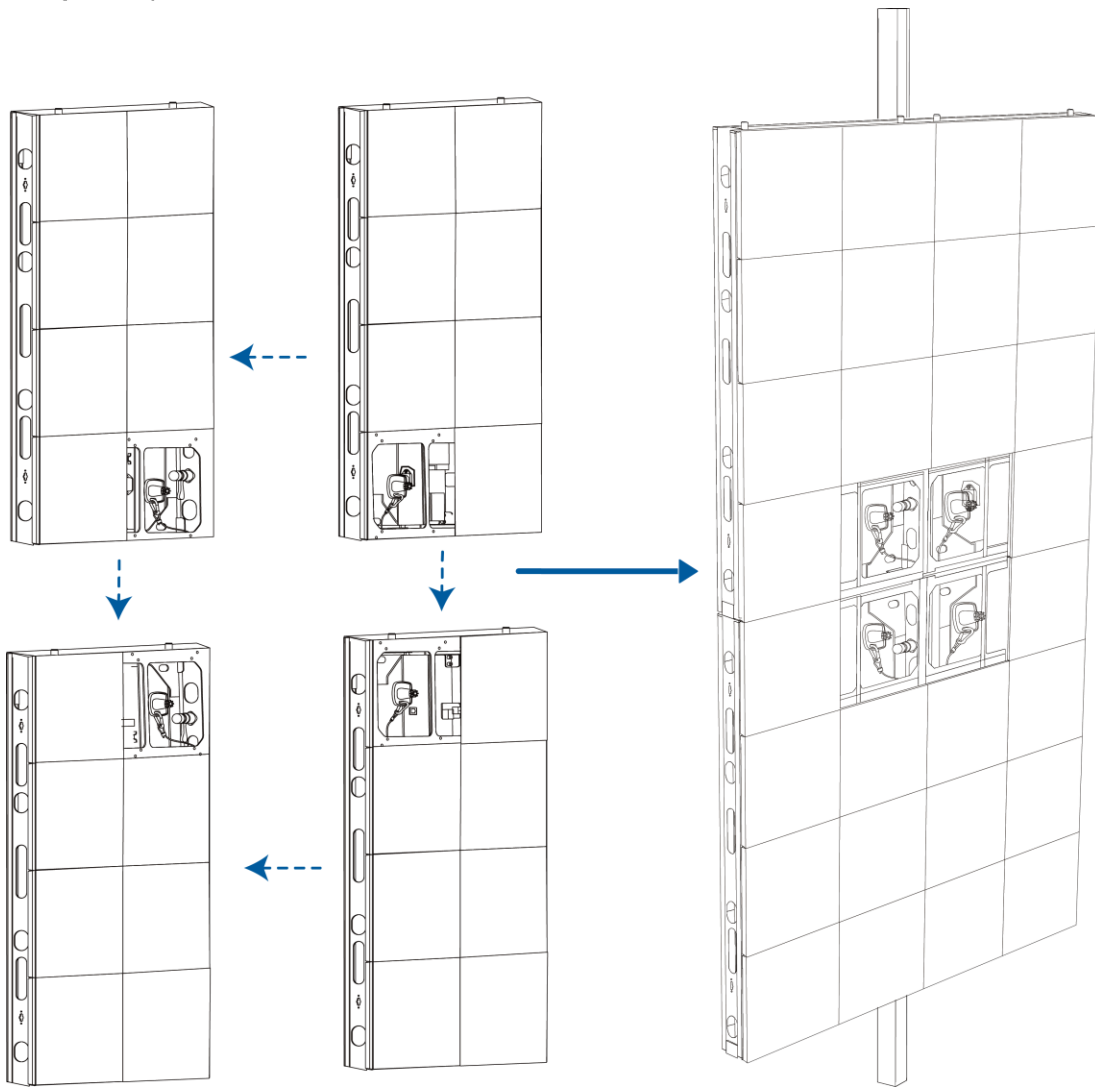

Example: 2 x 2 Array

2. Place the connecting plate behind the mounting bracket.

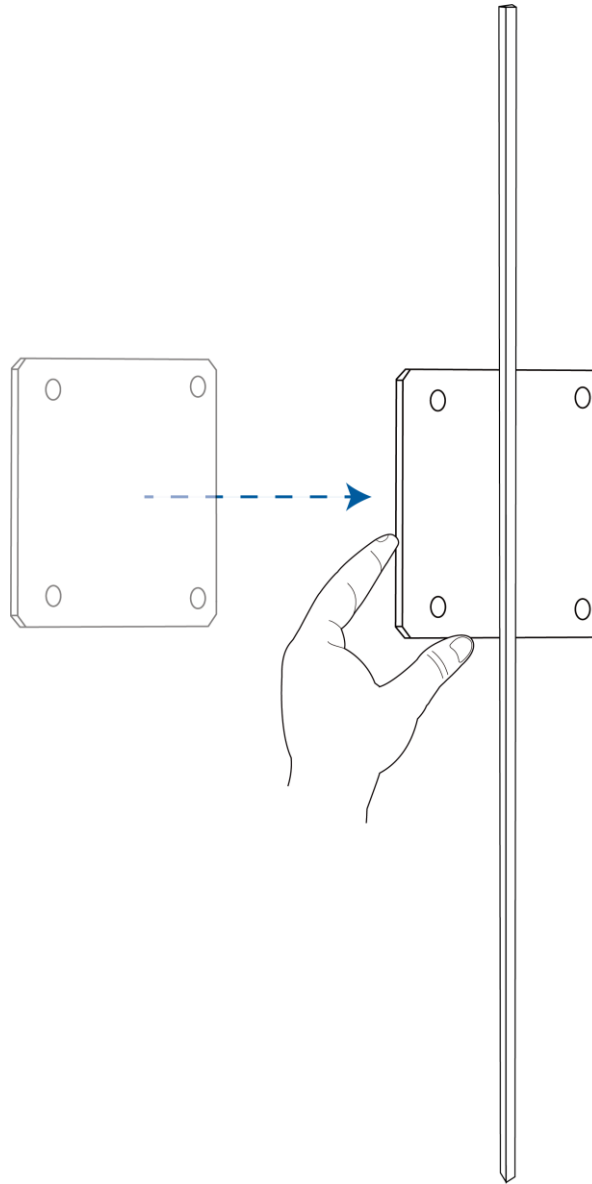

- The mounting interface should be strong enough to bear the weight of the display.
- Ensure that the flat side of the connecting plate is facing the cabinet.

3. Insert the socket screw through the corner hole as indicated in the diagram below.

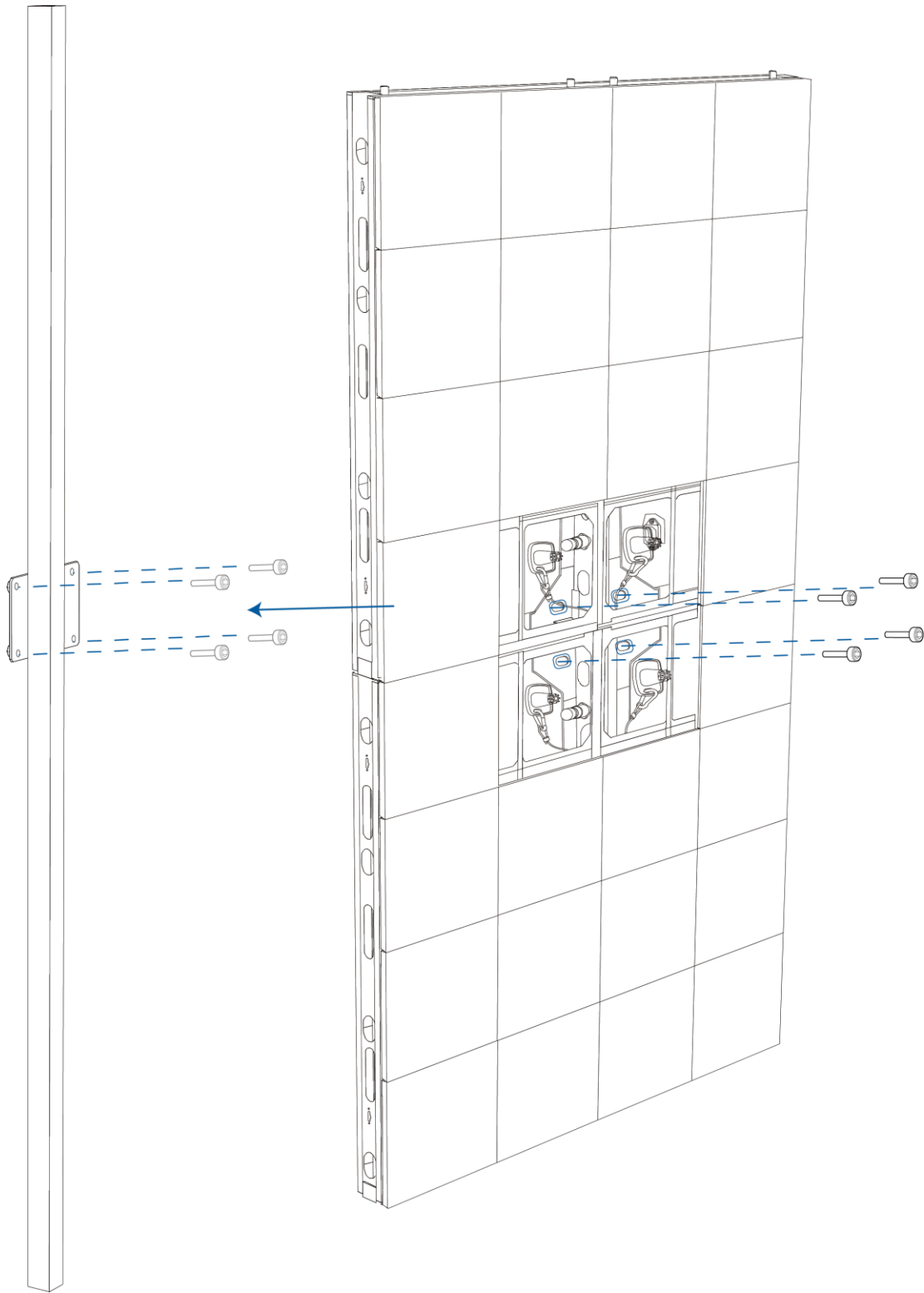

4. Tighten the socket screw using a T style inner hexagon wrench to attach the cabinets to the mounting bracket.

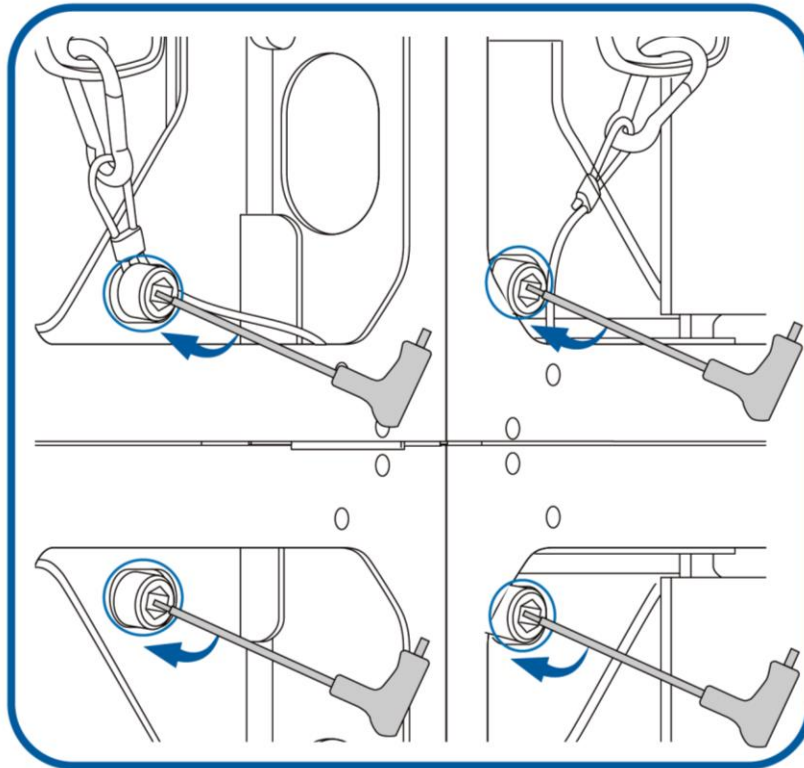

- The tool used in this step is “T style inner hexagon wrench, size 8” which is an optional accessory. Refer to Appendix C. Optional Components/Accessories on P.25 for detailed information.

5. Now, the installation of 2 x 2 display is complete. Repeat the above steps to mount additional cabinets if necessary.

4.2 Connecting the signal and power cables

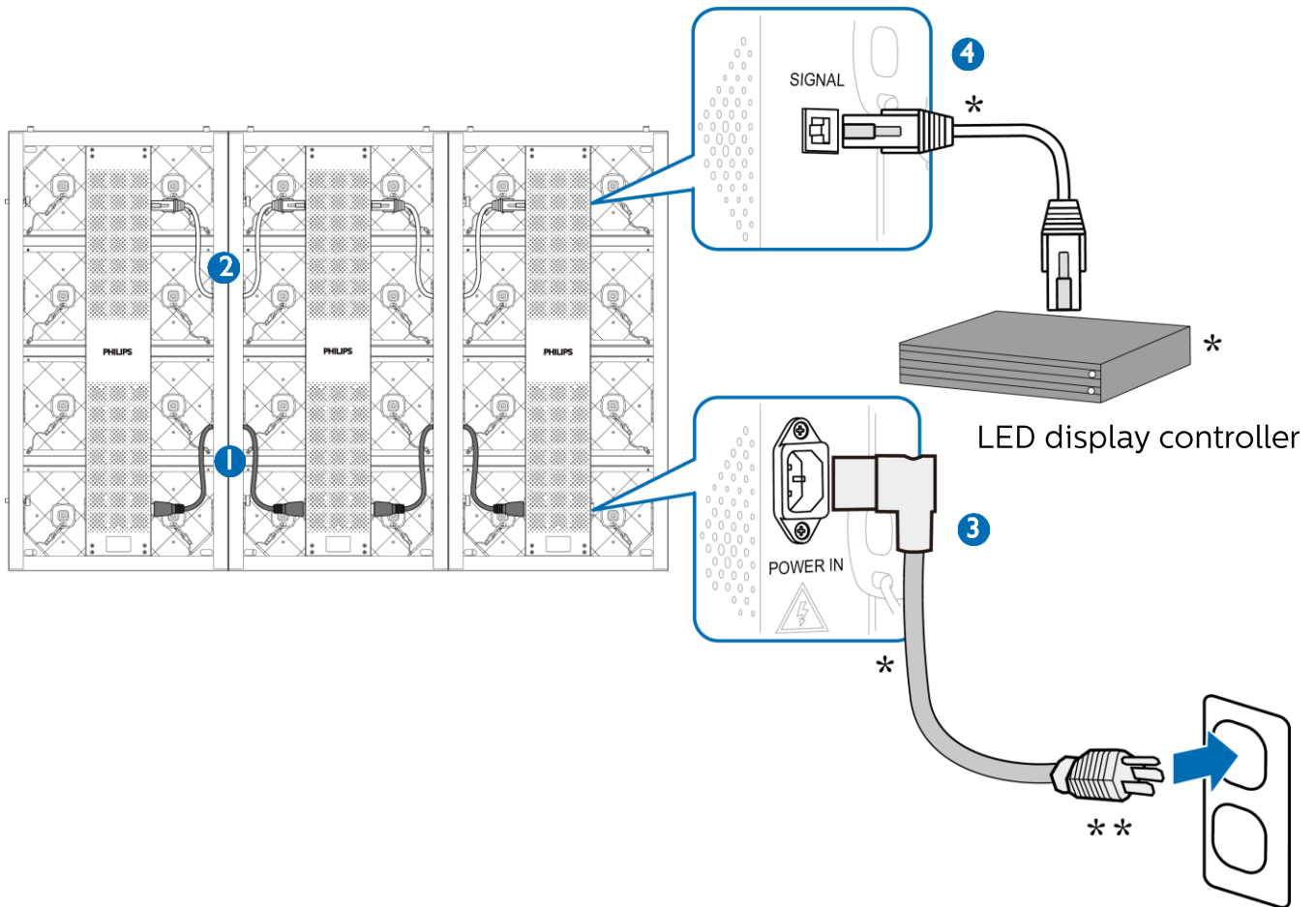

* optional accessories

** Power plug types vary by country/region

⚠ Cautions

Connection is allowed up to 3 cabinets when the 110 VAC power supply is used.
Connection is allowed up to 6 cabinets when the 230 VAC power supply is used.
Max. daisy chain cable current rating: 10 Amp

1. Turn off the power of all devices first before connecting cables.
2. Connect the power cable from the “Power Out” port of the first cabinet to the “Power In” port of the second cabinet. (see ❶)
3. Connect the signal cable from the Signal port of the first cabinet to Signal port of the second cabinet for video signal transmission. (see ❷)
4. Connect the power cable from the “Power In” port of the last cabinet to the power outlet. (see ❸)
5. Connect one end of the data cable of the last cabinet to the LED display controller. (see ❹)
6. Repeating steps 2~3 enables the daisy chain connection.

5. Using the LED display controller

The LED display controller is a device served for managing any type of video and data sources for any screen configuration. Visit Novastar website to learn more about Novastar's LED display controller and select the one that suit your needs according to the resolution and screen configuration of your display.

<https://www.novastar.tech/product/>

To download the Novastar software and user's guide, click on the following link:

<https://www.novastar.tech/download/download-controller/>

Appendices

Appendix A. Troubleshooting

Frequently asked questions and common problems that may occur while using the system are explained in this section. Observe the following table containing a list of symptoms and the actions to take to solve the problems.

If a problem persists after performing the following actions, contact technical support.

| Symptom | Possible cause and corrective action |
|----------------------------|--|
| No picture is displayed | <ul style="list-style-type: none"> ● The power cable is disconnected. > Re-connect the power cable. ● The signal cable is disconnected. > Re-connect the signal cable. ● The main switch on the power distribution box is off. > Make sure the power distribution box is switched on. ● The LED display controller is off. > Inspect whether the power connection is correct and the switch has been turned on. > Inspect whether the LED display controller output has signal and shows blank screen. > Check whether the mode and parameter of screen configuration are correct. > Check whether there is image input in input channel and whether it is correctly displayed. |
| The module is blinking | > Check the cable connection between the cabinet and power distribution box, and ensure the connection is secure. |
| The module cannot light up | > Check the cable connection between the cabinet and power distribution box, and ensure the connection is secure. |

Appendix B. Dew point VS. Relative Humidity

The table below explains the relationship between temperature/relative humidity and dew point.

| | | | | | | | | |
|-----------------------|--------|--------|--------|--------|--------|--------|--------|--------|
| Celsius (°C) | -20 | -20 | -20 | -20 | -20 | -20 | -20 | -20 |
| Relative Humidity (%) | 10 | 20 | 30 | 40 | 50 | 60 | 70 | 80 |
| Dew point (°C) | -43.87 | -37.24 | -33.15 | -30.15 | -27.76 | -25.77 | -24.06 | -22.56 |
| Celsius (°C) | -10 | -10 | -10 | -10 | -10 | -10 | -10 | -10 |
| Relative Humidity (%) | 10 | 20 | 30 | 40 | 50 | 60 | 70 | 80 |
| Dew point (°C) | -35.94 | -28.76 | -24.32 | -21.06 | -18.46 | -16.30 | -14.43 | -12.79 |
| Celsius (°C) | 0 | 0 | 0 | 0 | 0 | 0 | 0 | 0 |
| Relative Humidity (%) | 10 | 20 | 30 | 40 | 50 | 60 | 70 | 80 |
| Dew point (°C) | -28.08 | -20.33 | -15.54 | -12.01 | -9.19 | -6.84 | -4.82 | -3.03 |
| Celsius (°C) | 10 | 10 | 10 | 10 | 10 | 10 | 10 | 10 |
| Relative Humidity (%) | 10 | 20 | 30 | 40 | 50 | 60 | 70 | 80 |
| Dew point (°C) | -20.29 | -11.96 | -6.80 | -2.99 | 0.04 | 2.58 | 4.77 | 6.70 |
| Celsius (°C) | 25 | 25 | 25 | 25 | 25 | 25 | 25 | 25 |
| Relative Humidity (%) | 10 | 20 | 30 | 40 | 50 | 60 | 70 | 80 |
| Dew point (°C) | -8.75 | 0.47 | 6.22 | 10.46 | 13.85 | 16.69 | 19.14 | 21.30 |
| Celsius (°C) | 35 | 35 | 35 | 35 | 35 | 35 | 35 | 35 |
| Relative Humidity (%) | 10 | 20 | 30 | 40 | 50 | 60 | 70 | 80 |
| Dew point (°C) | -1.15 | 8.7 | 14.84 | 19.39 | 23.02 | 26.07 | 28.70 | 31.03 |
| Celsius (°C) | 45 | 45 | 45 | 45 | 45 | 45 | 45 | 45 |
| Relative Humidity (%) | 10 | 20 | 30 | 40 | 50 | 60 | 70 | 80 |
| Dew point (°C) | 6.38 | 16.87 | 23.42 | 28.28 | 32.17 | 35.43 | 38.25 | 40.74 |

Appendix C. Optional Components/Accessories

If you need to purchase the components or accessories listed below, please contact your local service center for support.

| CTN | Commercial description |
|-------------|--|
| CRD18128/00 | LED module, 8128-series, P2.84mm SMD2121 Gold |
| CRD18139/00 | LED module, 8139-series, P3.91mm SMD2121 Gold |
| CRD18148/00 | LED module, 8148-series, P4.81mm SMD2121 Gold |
| CRD18228/00 | LED module, 8228-series, P2.84mm SMD2020 Gold |
| CRD18239/00 | LED module, 8239-series, P3.91mm SMD2020 Gold |
| CRD18248/00 | LED module, 8248-series, P4.81mm SMD2020 Gold |
| CRD20001/00 | LED Display Controller Novastar MCTRL300 (EU) |
| CRD20001/17 | LED Display Controller Novastar MCTRL300 (US) |
| CRD20001/05 | LED Display Controller Novastar MCTRL300 (HK) |
| CRD20001/75 | LED Display Controller Novastar MCTRL300 (CN/AUS) |
| CRD20001/67 | LED Display Controller Novastar MCTRL600 (THAI) |
| CRD20002/00 | LED Display Controller Novastar MCTRL600 (EU) |
| CRD20002/17 | LED Display Controller Novastar MCTRL600 (US) |
| CRD20002/05 | LED Display Controller Novastar MCTRL600 (HK) |
| CRD20002/75 | LED Display Controller Novastar MCTRL600 (CN/AUS) |
| CRD20002/67 | LED Display Controller Novastar MCTRL600 (THAI) |
| CRD20003/00 | LED Display Controller Novastar MCTRL660 (EU) |
| CRD20003/17 | LED Display Controller Novastar MCTRL660 (US) |
| CRD20003/05 | LED Display Controller Novastar MCTRL660 (HK) |
| CRD20003/75 | LED Display Controller Novastar MCTRL660 (CN/AUS) |
| CRD20003/67 | LED Display Controller Novastar MCTRL660 (THAI) |
| CRD20004/00 | LED Display Controller Novastar MCTRL660PRO (EU) |
| CRD20004/17 | LED Display Controller Novastar MCTRL660PRO (US) |
| CRD20004/05 | LED Display Controller Novastar MCTRL660PRO (HK) |
| CRD20004/75 | LED Display Controller Novastar MCTRL660PRO (CN/AUS) |
| CRD20004/67 | LED Display Controller Novastar MCTRL660PRO (THAI) |
| CRD20005/00 | LED Display Controller Novastar VX4U (EU) |
| CRD20005/17 | LED Display Controller Novastar VX4U (US) |
| CRD20005/05 | LED Display Controller Novastar VX4U (HK) |
| CRD20005/75 | LED Display Controller Novastar VX4U (CN/AUS) |
| CRD20005/67 | LED Display Controller Novastar VX4U (THAI) |
| CRD20006/00 | LED Display Controller Novastar VX6S (EU) |
| CRD20006/17 | LED Display Controller Novastar VX6S (US) |

| | |
|-------------|---|
| CRD20006/05 | LED Display Controller Novastar VX6S (HK) |
| CRD20006/75 | LED Display Controller Novastar VX6S (CN/AUS) |
| CRD20006/67 | LED Display Controller Novastar VX6S (THAI) |
| CRD20007/00 | LED Display Controller Novastar MCTRLR5 (EU) |
| CRD20007/17 | LED Display Controller Novastar MCTRLR5 (US) |
| CRD20007/05 | LED Display Controller Novastar MCTRLR5 (HK) |
| CRD20007/75 | LED Display Controller Novastar MCTRLR5 (CN/AUS) |
| CRD20007/67 | LED Display Controller Novastar MCTRLR5 (THAI) |
| CRD20008/00 | LED Display Controller Novastar MCTRL4K (EU) |
| CRD20008/17 | LED Display Controller Novastar MCTRL4K (US) |
| CRD20008/05 | LED Display Controller Novastar MCTRL4K (HK) |
| CRD20008/75 | LED Display Controller Novastar MCTRL4K (CN/AUS) |
| CRD20008/67 | LED Display Controller Novastar MCTRL4K (THAI) |
| CRD20009/00 | LED Display Controller Novastar TB3 (EU) |
| CRD20009/17 | LED Display Controller Novastar TB3 (US) |
| CRD20009/05 | LED Display Controller Novastar TB3 (HK) |
| CRD20009/75 | LED Display Controller Novastar TB3 (CN/AUS) |
| CRD20009/67 | LED Display Controller Novastar TB3 (THAI) |
| CRD20010/00 | LED Display Controller Novastar TB6 (EU) |
| CRD20010/17 | LED Display Controller Novastar TB6 (US) |
| CRD20010/05 | LED Display Controller Novastar TB6 (HK) |
| CRD20010/75 | LED Display Controller Novastar TB6 (CN/AUS) |
| CRD20010/67 | LED Display Controller Novastar TB6 (THAI) |
| CRD20011/00 | LED Display Controller Novastar TB8 (EU) |
| CRD20011/17 | LED Display Controller Novastar TB8 (US) |
| CRD20011/05 | LED Display Controller Novastar TB8 (HK) |
| CRD20011/75 | LED Display Controller Novastar TB8 (CN/AUS) |
| CRD20011/67 | LED Display Controller Novastar TB8 (THAI) |
| BZ110099/00 | Power input cable, Schuko EU/IND to C13 (3*1.5mm wires, 10M, black) |
| BZ110099/05 | Power input cable, UK/HK to C13 (3*1.5mm wires, 10M, black) |
| BZ110099/17 | Power input cable, US/TWN to C13 (3*1.5mm wires, 10M, black) |
| BZ110099/75 | Power input cable, AUS to C13 (3*1.5mm wires, 10M, black) |
| BZ110099/67 | Power input cable, THAI to C13 (3*1.5mm wires, 10M, black) |
| BZ110094/05 | Power input cable, UK/HK to C13 (3*1.5mm wires, 1.8M, black) |
| BZ110098/00 | Signal input cable (RJ45, CAT5, 10m, black) |
| BZ110097/00 | Signal input cable (RJ45, CAT5, 90cm, black) |
| BZ110096/00 | Power loop through cable (C13-C14, 25cm, black) |
| BZ110094/00 | Power loop through cable (C13-C14, 130cm, black) |
| BZ110095/00 | Signal input cable (RJ45, CAT5, 25cm, black) |
| BM108000/00 | Front Service Tool 8x00-series |
| BM199001/00 | Antistatic gloves set |

| | |
|---------------|--|
| BM198001/00 | T style inner hexagon wrench, size 8 |
| BM199004/00 | USB Flashdrive incl. manual EDFU, QSG, CAD, calibration- and config data |
| BM198008/00 | Starterkit 8000-series (Front service tool, gloves set, T-Hex 8) |
| BZ208000/00 | Power supply, 8x00-series, HSP-300-5 |
| BZ308000/00 | HUB board - 8x00-series |
| CRD20085/00 | Novastar Receiving card, Armor Series, A5S |
| BM908000/00 | Common connecting plate, 8x00-series |
| 44BDL8128L/00 | LED panel, 8128-series, P2.84mm SMD2121 Gold |
| 44BDL8139L/00 | LED panel, 8139-series, P3.91mm SMD2121 Gold |
| 44BDL8148L/00 | LED panel, 8148-series, P4.81mm SMD2121 Gold |
| 44BDL8228L/00 | LED panel, 8228-series, P2.84mm SMD2121 Gold |
| 44BDL8239L/00 | LED panel, 8239-series, P3.91mm SMD2121 Gold |
| 44BDL8248L/00 | LED panel, 8248-series, P4.81mm SMD2121 Gold |

Appendix D. Technical Specifications

| Picture/Display | |
|---------------------------------|--|
| Brightness before calibration | 1000 nits |
| Brightness after calibration | 800 nits |
| Colour Temperature default | 6500±500 K |
| Viewing angle (H / V) | 140 / 140 degree |
| Brightness Uniformity | >=97% |
| Contrast ratio (typical) | >=3000:1 |
| Calibration (Brightness/Colour) | Supported |
| Refresh rate (Hz) | 1200~1920 |
| Frame Frequency (Hz) | 50 & 60 |
| Colour Temperature adjust range | 4000~9500 K (by software) |
| Aspect ratio | 1:2 |
| Picture enhancement | Dynamic contrast enhancement, Wide Colour Gamut display |
| Placement | Portrait |
| Usage | 24/7 hrs, Indoor |
| Convenience | |
| Ease of installation | Guide pins, Light weight, Locking mechanism for cabinet |
| Signal Control Loop Through | RJ45 |
| Power loop through | For 230V environments: 6 cabinets or less For 110V environments: 3 cabinets or less |
| Operating conditions | |
| Temperature range (operation) | -20~45 °C |
| Humidity range (operation) [RH] | 10~80% |
| Humidity range (storage) [RH] | 10~85% |
| Temperature range (storage) | -20~50 °C |
| Power | |
| Cabinet Max Power consumption | 260 W (44BDL8128L) 240 W (44BDL8139L) 220 W (44BDL8148L) |
| Consumption (Typical) | <=87W (44BDL8128L) <=80W (44BDL8139L) |

| | |
|---------------------------------|--|
| | <=73W (44BDL8148L) |
| Input Voltage | AC200~240V/AC100~120V (50-60Hz) |
| BTU Value m2 | 1773 BTU/m2 (44BDL8128L) 1637 BTU/m2 (44BDL8139L) 1500 BTU/m2 (44BDL8148L) |
| Miscellaneous | |
| Warranty | 3 year |
| Regulatory approvals | FCC SDOC, Part 15, EMC Class A, EN55032, EN55035, EN61000-3-2, EN61000-3-3, IEC/UL60950, IEC/UL62368, IEC62471, RoHS |
| Accessories | |
| Power loop through cable | 1 pcs |
| LAN cable (RJ45, CAT-5) | 1 pcs (130 cm) |
| Common connecting piece | 3 pcs |
| QSG | 1 pcs |
| Screw bolt | 4 pcs (M10*70) (Inner Hexagon Screw) |
| Cabinet | |
| Cabinet Size (mm) | 500 x 1000 x 86 |
| Cabinet Diagonal (inch) | 44 |
| Cabinet Resolution (W x H) | 104 x 208 |
| Weight (kg) | 15.6 kg |
| Cabinet pixels (Dot) | 21,632 |
| Cabinet Area (m2) | 0.5 |
| Power connector | In/Out (C14, C13) |
| Data connector | RJ45 |
| Cabinet Construction | Aluminum and Steel |
| Receiving card Quantity | 1 pcs |
| Receiving card Spec | A5S |
| Receiving card Brand | Novastar |
| Module | |
| LED type | SMD 2121 Gold wire |
| Pixel constitution | 1R1G1B |
| LED Lifetime (Hrs, half bright) | 100,000 |
| Pixel Pitch (mm) | 4.81 mm |
| Module Size (WxHxD in mm) | 250 x 250 x 19.1 |
| Module Resolution (WxH pixels) | 52 x 52 |



2019 © Koninklijke Philips N.V. All rights reserved.

Philips and the Philips Shield Emblem are registered trademarks of Koninklijke Philips N.V and are used under license from Koninklijke Philips N.V.

Specifications are subject to change without notice.