



RS500A-E9 Series

RS500A-E9-PS4

RS500A-E9-RS4

RS500A-E9-RS4-U

1U Rackmount Server User Guide



E15434
Revised Edition V2
April 2019

Copyright © 2019 ASUSTeK COMPUTER INC. All Rights Reserved.

No part of this manual, including the products and software described in it, may be reproduced, transmitted, transcribed, stored in a retrieval system, or translated into any language in any form or by any means, except documentation kept by the purchaser for backup purposes, without the express written permission of ASUSTeK COMPUTER INC. ("ASUS").

ASUS provides this manual "as is" without warranty of any kind, either express or implied, including but not limited to the implied warranties or conditions of merchantability or fitness for a particular purpose. In no event shall ASUS, its directors, officers, employees, or agents be liable for any indirect, special, incidental, or consequential damages (including damages for loss of profits, loss of business, loss of use or data, interruption of business and the like), even if ASUS has been advised of the possibility of such damages arising from any defect or error in this manual or product.

Specifications and information contained in this manual are furnished for informational use only, and are subject to change at any time without notice, and should not be construed as a commitment by ASUS. ASUS assumes no responsibility or liability for any errors or inaccuracies that may appear in this manual, including the products and software described in it.

Product warranty or service will not be extended if: (1) the product is repaired, modified or altered, unless such repair, modification or alteration is authorized in writing by ASUS; or (2) the serial number of the product is defaced or missing.

Products and corporate names appearing in this manual may or may not be registered trademarks or copyrights of their respective companies, and are used only for identification or explanation and to the owners' benefit, without intent to infringe.

Contents

Safety information.....	vi
About this guide.....	vii

Chapter 1: Product Introduction

1.1	System package contents.....	1-2
1.2	Serial number label.....	1-3
1.3	System specifications.....	1-4
1.4	Front panel features.....	1-7
1.5	Rear panel features.....	1-7
1.6	Internal features.....	1-8
1.7	LED information.....	1-9
1.7.1	Front panel LEDs.....	1-9
1.7.2	LAN (RJ-45) LEDs.....	1-10
1.7.3	HDD status LED.....	1-10

Chapter 2: Hardware Information

2.1	Chassis cover.....	2-2
2.2	Central Processing Unit (CPU).....	2-3
2.2.1	Installing the CPU and heatsink.....	2-3
2.3	System memory.....	2-7
2.3.1	Overview.....	2-7
2.3.2	Memory Configurations.....	2-7
2.3.3	Installing a DIMM on a single clip DIMM socket.....	2-8
2.4	Hard disk drives.....	2-9
2.5	Expansion slot.....	2-13
2.5.1	Installing an expansion card to the riser card bracket.....	2-13
2.5.2	Installing an ASUS PIKE II card.....	2-14
2.5.3	Installing M.2 (NGFF) cards.....	2-18
2.5.4	Installing Mezzanine cards.....	2-20
2.5.5	Configuring an expansion card.....	2-23
2.6	Cable connections.....	2-24
2.7	SATA/SAS backplane cabling.....	2-25
2.8	Removable/optional components.....	2-26
2.8.1	System fans.....	2-26

Contents

Chapter 3: Installation Options

3.1	Rail kit installation	3-2
3.1.1	Tool-less Friction Rail Kit	3-2
3.1.2	Installing the tool-less rack rail	3-2
3.2	Rail kit dimensions	3-5

Chapter 4: Motherboard Information

4.1	Motherboard layout.....	4-2
4.2	Jumpers	4-4
4.3	Onboard LEDs.....	4-8
4.4	Internal connectors.....	4-11

Chapter 5: BIOS Setup

5.1	Managing and updating your BIOS	5-2
5.1.1	ASUS CrashFree BIOS 3 utility.....	5-2
5.1.2	ASUS EZ Flash Utility	5-3
5.1.3	BUPDATER utility	5-4
5.2	BIOS setup program	5-6
5.2.1	BIOS menu screen.....	5-7
5.2.2	Menu bar.....	5-7
5.2.3	Menu items.....	5-8
5.2.4	Submenu items	5-8
5.2.5	Navigation keys.....	5-8
5.2.6	General help.....	5-8
5.2.7	Configuration fields	5-8
5.2.8	Pop-up window.....	5-8
5.2.9	Scroll bar	5-8
5.3	Main menu	5-9
5.3.1	System Date [Day xx/xx/xxxx].....	5-9
5.3.2	System Time [xx:xx:xx]	5-9
5.4	Advanced menu	5-10
5.4.1	Trusted Computing.....	5-11
5.4.2	PSP Firmware Versions.....	5-11
5.4.3	APM	5-12
5.4.4	Smart Settings.....	5-13
5.4.5	NCT6793D Super IO Configuration	5-13
5.4.6	Onboard LAN Configuration.....	5-14

Contents

5.4.7	Serial Port Console Redirection	5-15
5.4.8	CPU Configuration	5-17
5.4.9	PCI Subsystem Settings	5-18
5.4.10	Network Stack Configuration.....	5-19
5.4.11	CSM Configuration.....	5-20
5.4.12	NVMe Configuration.....	5-21
5.4.13	SATA Configuration	5-21
5.4.14	USB Configuration	5-22
5.4.15	iSCSI Configuration.....	5-23
5.5	Chipset menu	5-24
5.6	Security menu	5-25
5.7	Boot menu	5-28
5.8	Tool menu.....	5-29
5.9	Save & Exit menu.....	5-29
5.10	AMD CBS menu.....	5-31
5.10.1	Zen Common Options.....	5-31
5.10.2	DF Common Options	5-32
5.10.3	UMC Common Option.....	5-32
5.10.4	NBIO Common Options	5-34
5.11	Event Logs menu	5-36
5.11.1	Change Smbios Event Log Settings	5-36
5.11.2	View Smbios Event Log	5-36
5.12	Server Mgmt menu.....	5-37

Chapter 6: Driver Installation

6.1	Management applications and utilities installation	6-2
6.2	Running the Support DVD.....	6-2
6.3	AMD chipset device software installation	6-5
6.4	Installing the Intel® I350-AM2 Gigabit Adapters driver.....	6-6
6.5	VGA driver installation	6-8

Appendix

KNPA-U16 block diagram	A-2
Q-Code table.....	A-3
Notices	A-6
REACH	A-7
Australia statement notice.....	A-7
ASUS contact information.....	A-8

Safety information

Electrical Safety

- Before installing or removing signal cables, ensure that the power cables for the system unit and all attached devices are unplugged.
- To prevent electrical shock hazard, disconnect the power cable from the electrical outlet before relocating the system.
- When adding or removing any additional devices to or from the system, ensure that the power cables for the devices are unplugged before the signal cables are connected. If possible, disconnect all power cables from the existing system before you add a device.
- If the power supply is broken, do not try to fix it by yourself. Contact a qualified service technician or your dealer.

Operation Safety

- Any mechanical operation on this server must be conducted by certified or experienced engineers.
- Before operating the server, carefully read all the manuals included with the server package.
- Before using the server, ensure all cables are correctly connected and the power cables are not damaged. If any damage is detected, contact your dealer as soon as possible.
- To avoid short circuits, keep paper clips, screws, and staples away from connectors, slots, sockets and circuitry.
- Avoid dust, humidity, and temperature extremes. Place the server on a stable surface.



This product is equipped with a three-wire power cable and plug for the user's safety. Use the power cable with a properly grounded electrical outlet to avoid electrical shock.

Lithium-Ion Battery Warning

CAUTION! Danger of explosion if battery is incorrectly replaced. Replace only with the same or equivalent type recommended by the manufacturer. Dispose of used batteries according to the manufacturer's instructions.

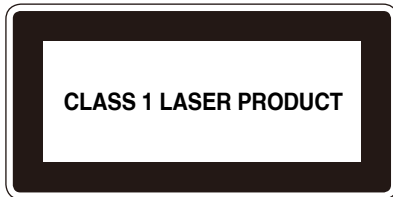

Heavy System

CAUTION! This server system is heavy. Ask for assistance when moving or carrying the system.

About this guide

Audience

This user guide is intended for system integrators, and experienced users with at least basic knowledge of configuring a server.

Contents

This guide contains the following parts:

1. Chapter 1: Product Introduction

This chapter describes the general features of the server, including sections on front panel and rear panel specifications.

2. Chapter 2: Hardware Information

This chapter lists the hardware setup procedures that you have to perform when installing or removing system components.

3. Chapter 3: Installation Options

This chapter describes how to install optional components into the barebone server.

4. Chapter 4: Motherboard Information

This chapter gives information about the motherboard that comes with the server. This chapter includes the motherboard layout, jumper settings, and connector locations.

5. Chapter 5: BIOS Setup

This chapter tells how to change system settings through the BIOS Setup menus and describes the BIOS parameters.

6. Chapter 6: Driver Installation

This chapter provides instructions for installing the necessary drivers for different system components.

Conventions

To ensure that you perform certain tasks properly, take note of the following symbols used throughout this manual.



DANGER/WARNING: Information to prevent injury to yourself when trying to complete a task.



CAUTION: Information to prevent damage to the components when trying to complete a task.



IMPORTANT: Instructions that you **MUST** follow to complete a task.



NOTE: Tips and additional information to help you complete a task.

Typography

Bold text

Indicates a menu or an item to select.

Italics

Used to emphasize a word or a phrase.

<Key>

Keys enclosed in the less-than and greater-than sign means that you must press the enclosed key.

Example: <Enter> means that you must press the Enter or Return key.

<Key1>+<Key2>+<Key3>

If you must press two or more keys simultaneously, the key names are linked with a plus sign (+).

Example: <Ctrl>+<Alt>+

Command

Means that you must type the command exactly as shown, then supply the required item or value enclosed in brackets.

Example: At the DOS prompt, type the command line: **format A:/S**

References

Refer to the following sources for additional information, and for product and software updates.

1. **ASUS Control Center (ACC) user guide**

This manual tells how to set up and use the proprietary ASUS server management utility.

2. **ASUS websites**

The ASUS websites worldwide provide updated information for all ASUS hardware and software products. Refer to the ASUS contact information.

Product Introduction

1

This chapter describes the general features of the chassis kit. It includes sections on front panel and rear panel specifications.

1.1 System package contents

Check your system package for the following items.

Model Name	RS500A-E9-PS4, RS500A-E9-RS4, RS500A-E9-RS4-U
Chassis	ASUS R10E 1U Rackmount Chassis
Motherboard	ASUS KNPA-U16 Server Board
Component	1 x 650W Single Power Supply (RS500A-E9-PS4)
	1 x 770W Redundant Power Supply (RS500A-E9-RS4, RS500A-E9-RS4-U)
	4 x Hot-swap 3.5-inch HDD Trays
	1 x SAS/SATA Backplane (RS500A-E9-PS4, RS500A-E9-RS4)
	1 x SAS/SATA/NVMe Backplane (RS500A-E9-RS4-U)
	1 x PCI-E Riser Card
	1 x Front I/O Board
Accessories	6 x System Fans (40 mm x 28 mm)
	1 x Redundant Power Supply Power Distribution Board (RS500A-E9-RS4, RS500A-E9-RS4-U)
	1 x Support DVD
	1 x Bag of Screws
Optional Items	1 x AC Power Cable (RS500A-E9-PS4)
	2 x AC Power Cable (RS500A-E9-RS4, RS500A-E9-RS4-U)
	1 x CPU Heatsink
	1 x Tool-less Friction Rail Kit
	DVD-ROM/DVD-RW



If any of the above items is damaged or missing, contact your retailer.

1.2 Serial number label

Before requesting support from the ASUS Technical Support team, you must take note of the product's serial number containing 12 characters such as xxS0xxxxxxx shown as the figure below. With the correct serial number of the product, ASUS Technical Support team members can then offer a quicker and satisfying solution to your problems.



1.3 System specifications

The ASUS RS500A-E9 Series is a 1U barebone server system featuring the ASUS KNPA-U16 Server Board. The server supports AMD EPYC™ 7000 Series processors plus other latest technologies through the chipsets onboard.

Model Name		RS500A-E9-PS4	RS500A-E9-RS4	RS500A-E9-RS4-U
Processor Support		1 x Socket SP3 (LGA 4094) AMD EPYC™ 7000 Series Processor (up to 180W)		
Memory	Total Slots	16 (8-channel, 2-DIMM per Channel)		
	Capacity	Maximum up to 2048GB		
	Memory Type	DDR4 2666/2400/2133 RDIMM/LR-DIMM/LR-DIMM 3DS		
	Memory Size	32GB, 16GB, 8GB, 4GB (RDIMM) 64GB, 32GB (LRDIMM) 128GB, 64GB (LRDIMM 3DS) * Refer to www.asus.com for the latest memory AVL update.		
Expansion Slots	Total PCI/PCI-X/PCI-E Slots	2+1		
	Slot Type	1 x PCIe 3.0 x16 (x16 link); FH,HL		
		1 x PCIe 3.0 x8 (x8 link); FH,HL 1 x OCP 2.0 Mezzanine (x8 link)		
Disk Controller	SATA Controller	CPU Integrated		
	SAS Controller	Optional kits: - ASUS PIKE II 3008 8-port SAS HBA Card - ASUS PIKE II 3108 8-port SAS HW RAID Card Support SAS 12Gbps		
	NVMe Controller	N/A	CPU Integrated	
Storage Bays	I = internal A or S = hot-swappable	4 x 3.5" or 2.5" Hot-swap Storage Bays (SATA/SAS Supported)		4 x 3.5" or 2.5" Hot-swap Storage Bays (SATA/SAS/NVMe Supported)
Networking	LAN	1 x Dual Port Intel I350-AM2 Gigabit LAN controller 1 x Management Port		
Infiniband		Optional Kit: Mellanox MCX453A-FCAT Card		
Graphic	VGA	Aspeed AST2500 64MB		

(continued on the next page)

Model Name		RS500A-E9-PS4	RS500A-E9-RS4	RS500A-E9-RS4-U
Auxiliary Storage Device Bay (Optical Drive)		1 x Slim-type Optical Drive		
Front I/O Ports		2 x USB 3.0 ports 1 x VGA port		
Rear I/O Ports		2 x USB 3.0 ports 1 x VGA port 2 x RJ-45 1GbE LAN ports 1 x RJ-45 Management port		
Switch/LED		Rear: - 1 x Power Switch/LED - 1 x Q-Code/Port 80 LED Front: - 1 x Power Switch/LED - 1 x Location Switch/LED - 1 x Reset Switch - 1 x Message LED - 4 x LAN LED (LED1~2 for on-board LAN, 3~4 for OCP LAN)		
OS Support		Windows® Server 2016 RedHat® Enterprise Linux SuSE® Linux Enterprise Server CentOS Ubuntu VMware Citrix XenServer * Please find the latest OS support from http://www.asus.com/		
Management Solution	Software	ASUS Control Center		
	Out of Band Remote Management	On-Board ASMB9-iKVM for KVM-over-IP		
Regulatory Compliance		BSMI, CE, FCC		
Dimension (HH x WW x DD)		615 x 444 x 44mm (1U) 24.21" x 17.48" x 1.73"		
Net Weight Kg (CPU, DRAM & HDD not included)		10 Kg	11 Kg	11.5 Kg
Gross Weight Kg (CPU, DRAM & HDD not included, Packing included)		16 Kg	17 Kg	17.5 Kg

(continued on the next page)

Model Name	RS500A-E9-PS4	RS500A-E9-RS4	RS500A-E9-RS4-U
Power Supply (following different configuration by region)	Single 650W 80 PLUS Platinum Power Supply Rating: 100-127/200~240Vac, 9A/5A, 50~60Hz, Class I	1+1 Redundant 770W 80 PLUS Platinum Power Supply Rating: 100-127/200~240 Vac, 10A/5A, 50~60Hz, Class I	
Environment	Operating temperature: 10°C – 35°C Non operating temperature: -40°C – 70°C Non operating humidity: 20% – 90% (Non condensing)		

*Specifications are subject to change without notice.

1.4 Front panel features

The barebone server displays a simple yet stylish front panel with easily accessible features. The power and reset buttons, LED indicators, slim type optical drive, and two USB ports are located on the front panel.



Refer to the **Front panel LEDs** section for the LED descriptions.

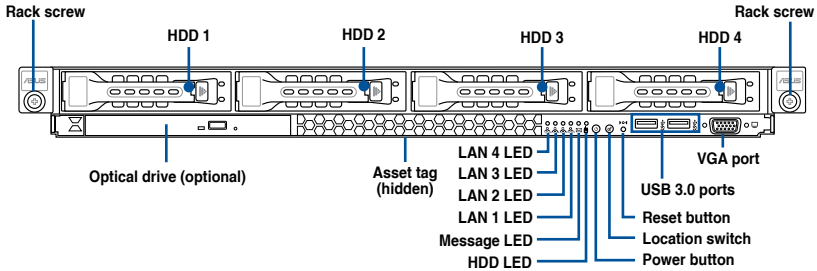

1.5 Rear panel features

The rear panel includes the expansion slots, system power socket, and rear fans. The middle part includes the I/O shield with openings for the rear panel connectors on the motherboard.

RS500A-E9-RS4 / RS500A-E9-RS4-U

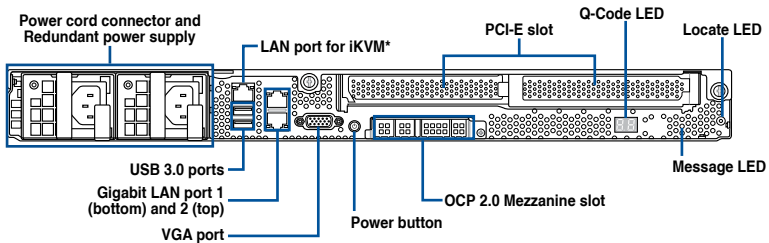

RS500A-E9-PS4

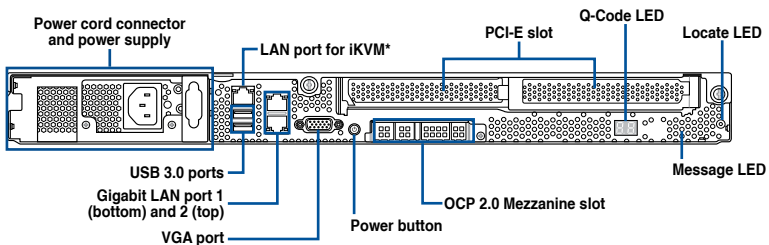

*This port is for ASUS ASMB9-iKVM controller card only.

1.6 Internal features

The barebone server includes the basic components as shown.

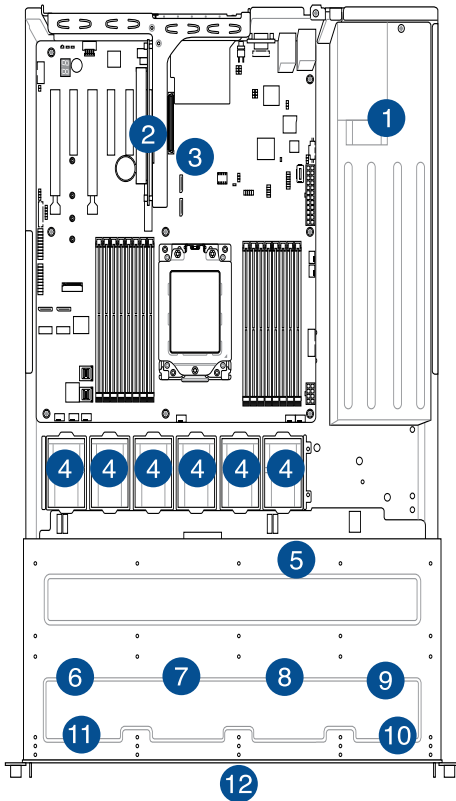

1. Power supply and power fan
2. PCI Express slot Riser Card
3. ASUS KNPA-U16 Server Board
4. System fans
5. SAS / SATA backplane (hidden)
6. HDD tray 1 - Connects to backplane
7. HDD tray 2 - Connects to backplane
8. HDD tray 3 - Connects to backplane
9. HDD tray 4 - Connects to backplane
10. Front I/O boards (hidden)
11. Slim-type optical drive
12. Asset Tag



Turn off the system power and detach the power supply before removing or replacing any system component.



The barebone server does not include a floppy disk drive. Connect a USB floppy disk drive to any of the USB ports on the front or rear panel if you need to use a floppy disk.

WARNING
HAZARDOUS MOVING PARTS
KEEP FINGERS AND OTHER BODY PARTS AWAY

1.7 LED information

1.7.1 Front panel LEDs

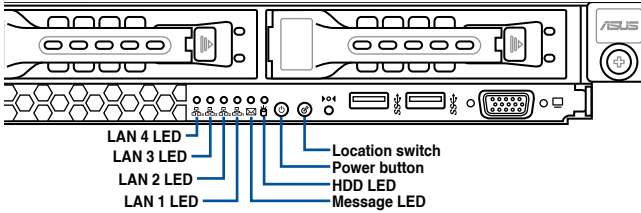

LED	Icon	Display status	Description
Power LED		ON	System power ON
HDD Access LED		OFF Blinking	No activity Read/write data into the HDD
Message LED		OFF ON	System is normal; no incoming event A hardware monitor event is indicated
Location LED		OFF ON	Normal status Location switch is pressed (Press the location switch again to turn off)
LAN LEDs		OFF Blinking ON	No LAN connection LAN is transmitting or receiving data LAN connection is present

1.7.2 LAN (RJ-45) LEDs

LAN port LED indications

Activity/Link LED		Speed LED	
Status	Description	Status	Description
OFF	No link	GREEN	1 Gbps connection
GREEN	Linked		
BLINKING	Data activity		

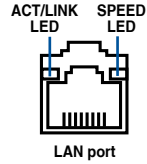

Dedicated Management LAN port (DM_LAN1) LED indications

Activity/Link LED		Speed LED	
Status	Description	Status	Description
OFF	No link	OFF	10 Mbps connection
YELLOW	Linked	ORANGE	100 Mbps connection
BLINKING	Data activity	GREEN	1 Gbps connection

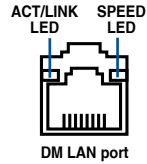

1.7.3 HDD status LED

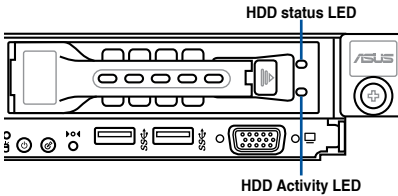

SATA/SAS HDD LED Description			
HDD Status LED	GREEN	ON	SATA/SAS HDD power ON
	RED	ON	HDD has failed and should be swapped immediately
	GREEN/RED	Blinking	RAID rebuilding
	GREEN/RED	OFF	HDD not found
HDD Activity LED	GREEN	Blinking	Read/write data from/into the SATA/SAS HDD

Hardware Information

2

This chapter lists the hardware setup procedures that you have to perform when installing or removing system components.

2.1 Chassis cover

Removing the rear cover

1. Locate and remove the front side screws.

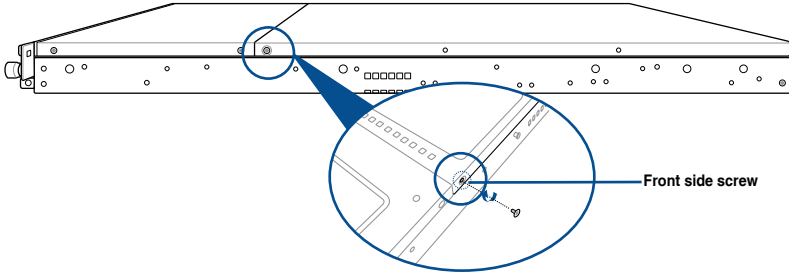

2. Loosen the two thumbscrews on the rear panel to release the rear cover from the chassis.

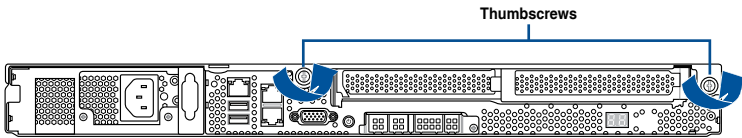

3. Firmly hold the cover and slide it toward the rear panel for about half an inch until it is disengaged from the chassis.
4. Lift the cover from the chassis.
5. To reattach the rear cover, reverse step 1 to 4.

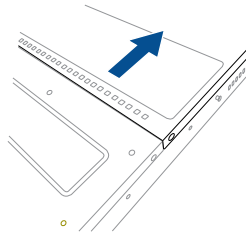

A protection film is pre-attached to the system cover before shipping. Please remove the protection film before turning on the system for proper heat dissipation.

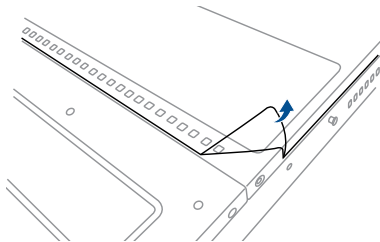

2.2 Central Processing Unit (CPU)

The motherboard comes with a surface mount Socket SP3 designed for the AMD EPYC™ 7000 Series.



- Upon purchase of the motherboard, ensure that the PnP cap is on the socket and the socket contacts are not bent. Contact your retailer immediately if the PnP cap is missing, or if you see any damage to the PnP cap/socket contacts/motherboard components. ASUS will shoulder the cost of repair only if the damage is shipment/transit-related.
- Keep the cap after installing the motherboard. ASUS will process Return Merchandise Authorization (RMA) requests only if the motherboard comes with the cap on the Socket SP3.
- The product warranty does not cover damage to the socket contacts resulting from incorrect CPU installation/removal, or misplacement/loss/incorrect removal of the PnP cap.

2.2.1 Installing the CPU and heatsink

To install the CPU and heatsink:

1. Remove the rear cover. For more information, see the section **Chassis cover**.
2. Locate the CPU socket on your motherboard..

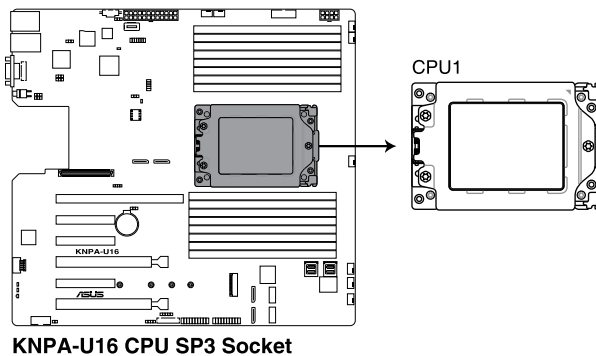

- Loosen each screw one by one in the sequence shown on the socket to open the load plate.

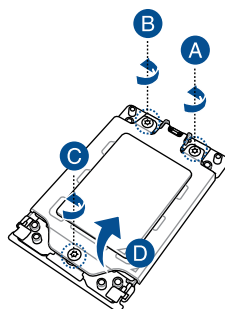

- Slightly lift open the rail frame.

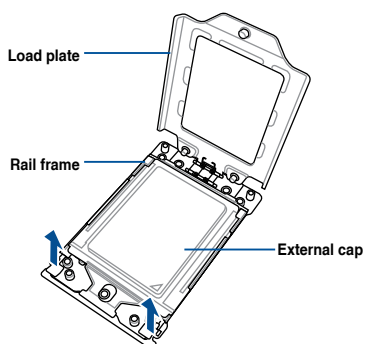

- Slide the external cap out of the rail frame.

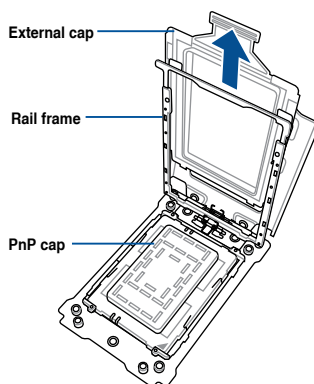

- Slide the carrier frame with CPU into the rail frame, then remove the PnP cap.



The carrier frame with CPU fits in only one correct orientation. DO NOT force the carrier frame with CPU into the rail frame.

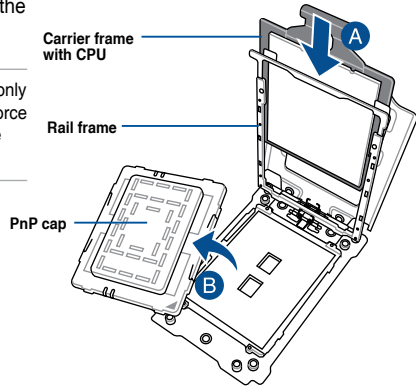

- Gently push the rail frame just enough to let it sit on top of the CPU socket.

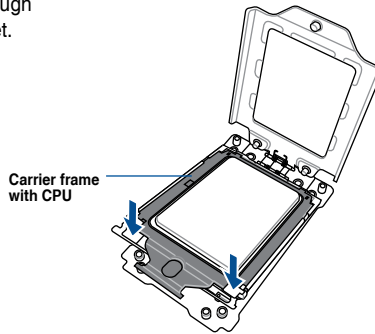

- Close the load plate just enough to let it sit on top of the CPU, then secure each screw one by one in the sequence shown on the socket to completely secure the load plate.



The load plate screws are T20 models. A torque value of 12 inch-lbf is recommended.

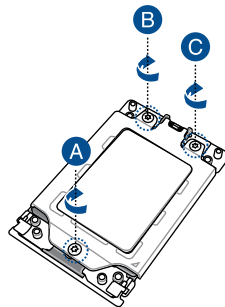

9. Twist each of the four screws with a screwdriver just enough to attach the heatsink to the motherboard. When the four screws are attached, tighten them one by one in a diagonal sequence to complete the installation.



The heatsink screws are T20 models. A torque value of 12 inch-lbf is recommended.

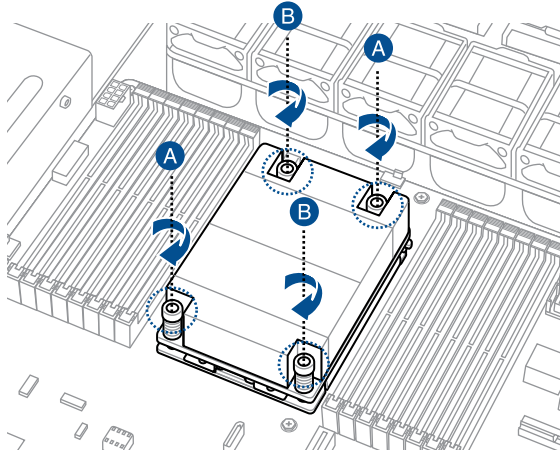

2.3 System memory

2.3.1 Overview

The motherboard comes with sixteen (16) Double Data Rate 4 (DDR4) Dual Inline Memory Modules (DIMM) sockets.

The figure illustrates the location of the DDR4 DIMM sockets:

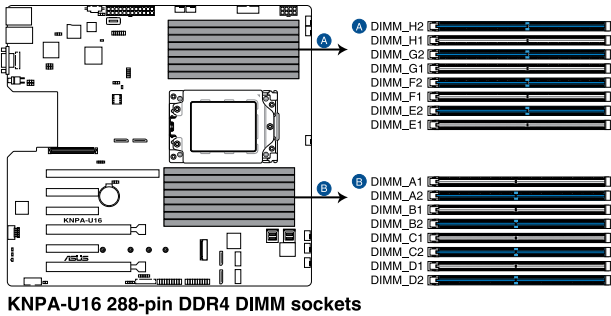

2.3.2 Memory Configurations

You may install 32GB, 16GB, 8GB, 4GB RDIMM, 64GB, 32GB LRDIMM, or 128GB, 64GB LRDIMM 3DS into the DIMM sockets using the memory configurations in this section.

	Memory configurations															
	A1	A2	B1	B2	C1	C2	D1	D2	E1	E2	F1	F2	G1	G2	H1	H2
1 DIMM		✓														
2 DIMMs		✓								✓						
4 DIMMs		✓		✓						✓		✓				
6 DIMMs		✓		✓		✓				✓		✓		✓		
8 DIMMs		✓		✓		✓		✓		✓		✓		✓		✓
10 DIMMs	✓	✓		✓		✓		✓	✓	✓		✓		✓		✓
12 DIMMs	✓	✓	✓	✓		✓		✓	✓	✓	✓	✓		✓		✓
14 DIMMs	✓	✓	✓	✓	✓	✓		✓	✓	✓	✓	✓	✓	✓	✓	✓
16 DIMMs	✓	✓	✓	✓	✓	✓	✓	✓	✓	✓	✓	✓	✓	✓	✓	✓



- Always install DIMMs with the same CAS latency. For optimum compatibility, it is recommended that you obtain memory modules from the same vendor.
- Start installing the DIMMs in slots A2.

2.3.3 Installing a DIMM on a single clip DIMM socket



Ensure to unplug the power supply before adding or removing DIMMs or other system components. Failure to do so may cause severe damage to both the motherboard and the components.

1. Unlock a DIMM socket by pressing the retaining clip outward.
2. Align a DIMM on the socket such that the notch on the DIMM matches the DIMM slot key on the socket.

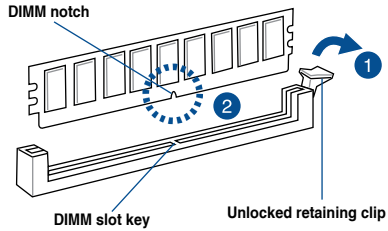

A DIMM is keyed with a notch so that it fits in only one direction. DO NOT force a DIMM into a socket in the wrong direction to avoid damaging the DIMM.

3. Hold the DIMM by both of its ends then insert the DIMM vertically into the socket. Apply force to both ends of the DIMM simultaneously until the retaining clip snaps back into place and the DIMM cannot be pushed in any further to ensure proper sitting of the DIMM.

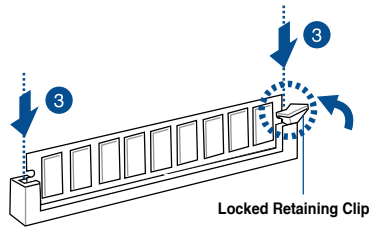

Always insert the DIMM into the socket vertically to prevent DIMM notch damage.

Removing a DIMM from a single clip DIMM socket

1. Press the retaining clip outward to unlock the DIMM.
2. Remove the DIMM from the socket.

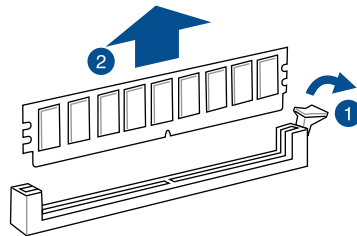

Support the DIMM lightly with your fingers when pressing the retaining clips. The DIMM might get damaged when it flips out with extra force.

2.4 Hard disk drives

The system supports four hot-swap SATA/SAS hard disk drives. The hard disk drive installed on the drive tray connects to the motherboard SATA/SAS ports via the SATA/SAS backplane.

To install a 3.5" hot-swap SATA/SAS HDD:

1. Push the spring lock to the right (A) then pull the tray lever outward (B) to release the drive tray. The drive tray ejects slightly after you pull out the lever.

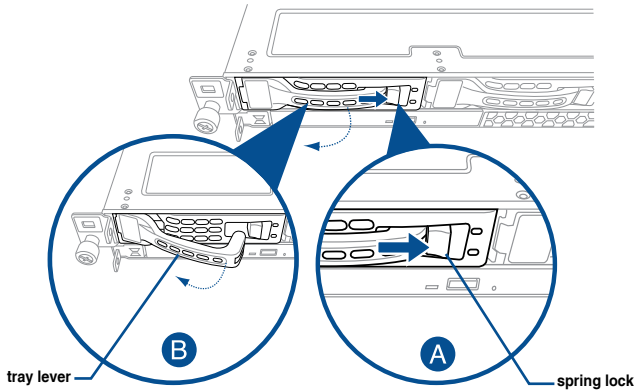

2. Firmly hold the tray lever and pull the drive tray out of the bay.

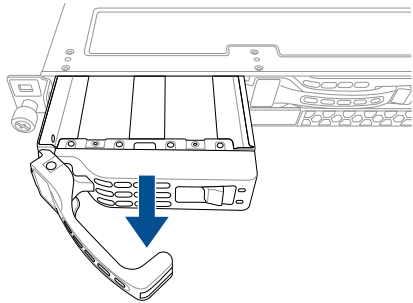

3. Place the drive tray on a flat and stable surface.
4. Prepare the SATA/SAS HDD and the bundled set of screws.

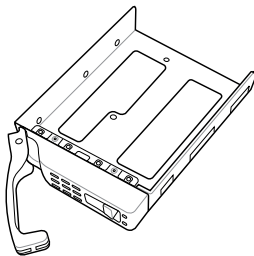

- 5. Place the 3.5" SATA/SAS HDD into the tray then secure it with four screws.

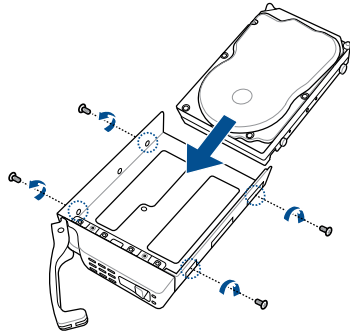

- 6. Insert the drive tray and HDD assembly all the way into the depth of the bay until just a small fraction of the tray edge protrudes.

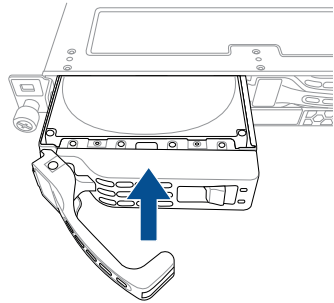

When installed, the SATA/SAS connector on the drive connects to the SATA/SAS interface on the backplane.

- 7. Push the tray lever until it clicks and secures the drive tray in place.



The drive tray is correctly placed when its front edge aligns with the bay edge.

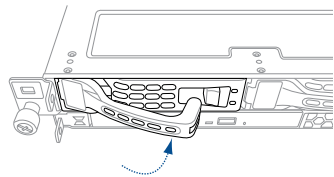

- 8. Repeat steps 1 to 7 to install the other SATA/SAS HDDs.

To install a 2.5" storage device to the front panel:

1. Push the spring lock to the right (A) then pull the tray lever outward (B) to release the drive tray. The drive tray ejects slightly after you pull out the lever.

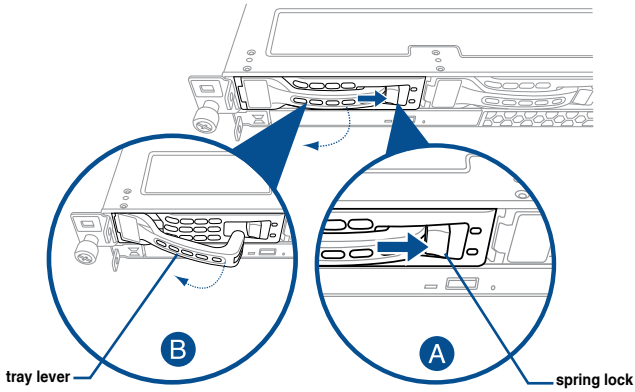

2. Firmly hold the tray lever and pull the tray out of the bay.

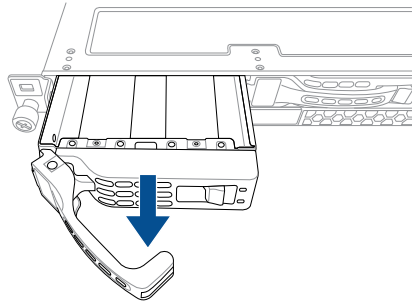

3. Place the tray on a flat and stable surface.
4. Prepare the 2.5" storage device and the bundled set of screws.

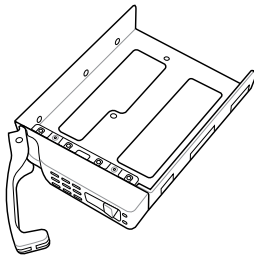

- 5. Place the 2.5" storage device into the tray then secure it with four screws.

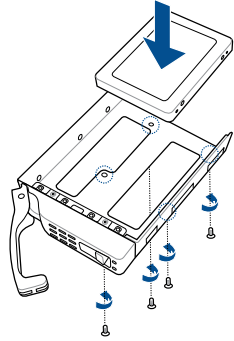

- 6. Insert the tray and storage device assembly all the way into the depth of the bay until just a small fraction of the tray edge protrudes.

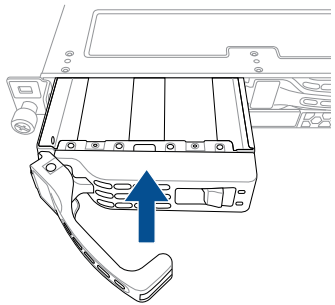

When installed, the SATA/NVMe connector on the storage device connects to the SATA/NVMe interface on the backplane.

- 7. Push the tray lever until it clicks and secures the tray in place.



The tray is correctly placed when its front edge aligns with the bay edge.

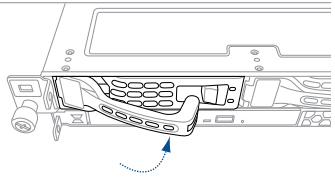

- 8. Repeat steps 1 to 7 to install the other storage devices.

2.5 Expansion slot

2.5.1 Installing an expansion card to the riser card bracket

The barebone server comes with a riser card bracket. You need to remove the bracket if you want to install PCI Express x8 or x16 expansion cards.

To install a PCI Express x8 or x16 card:

1. Firmly hold the riser card bracket, then pull it up to detach it from the PCI Express x24 slot on the motherboard.
2. Place the riser card bracket on a flat and stable surface, then remove the screw from the slot bay.
3. Install a PCI Express x8 or x16 card to the bracket as shown.
4. Secure the card with a screw.

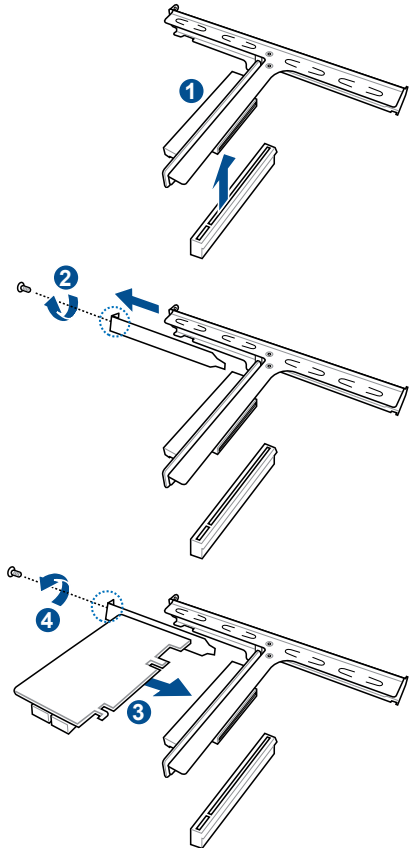

5. Install the riser card bracket and PCI Express card assembly back into the PCI Express x24 slot on the motherboard. Ensure that the golden connectors of the riser card bracket is firmly seated in place.

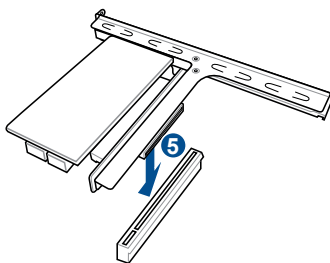

2.5.2 Installing an ASUS PIKE II card

You can install an ASUS PIKE II card on the provided PCI-E slot onboard.

To install an ASUS PIKE II card:

1. Firmly hold the riser card bracket, then pull it up to detach it from the PCI Express x24 slot on the motherboard.

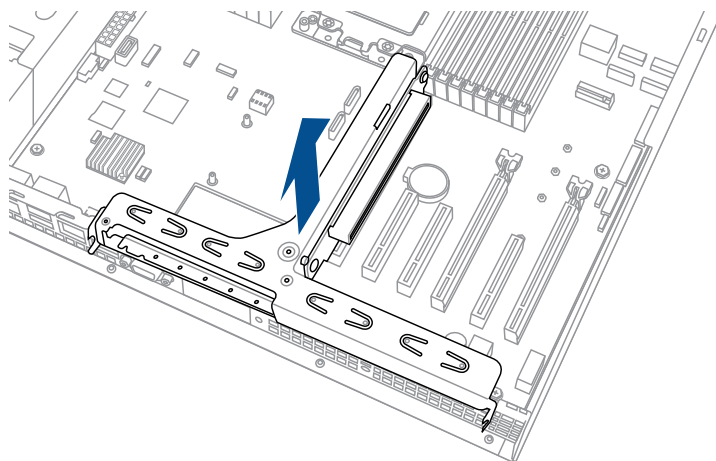

2. Remove the screw that secures the metal cover to the riser card bracket, then remove the metal cover.

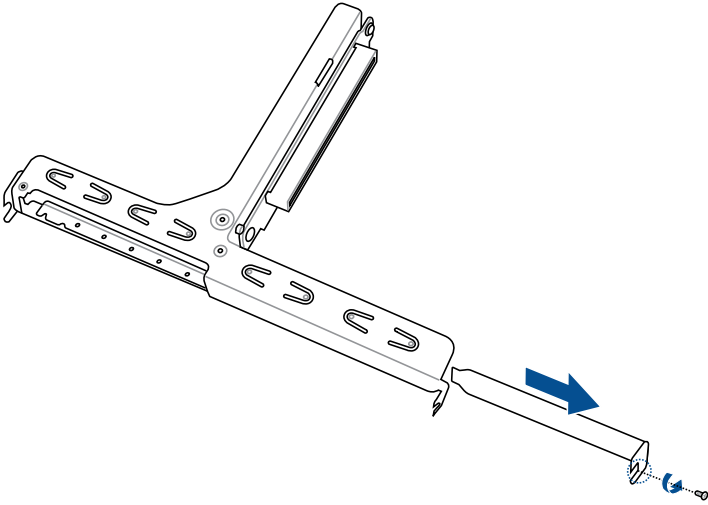

3. Prepare your ASUS PIKE II card.
4. Insert the expansion card into the PCI-E slot. Ensure that the golden fingers are totally inserted into the slot, then secure the ASUS PIKE II card with the screw removed before.

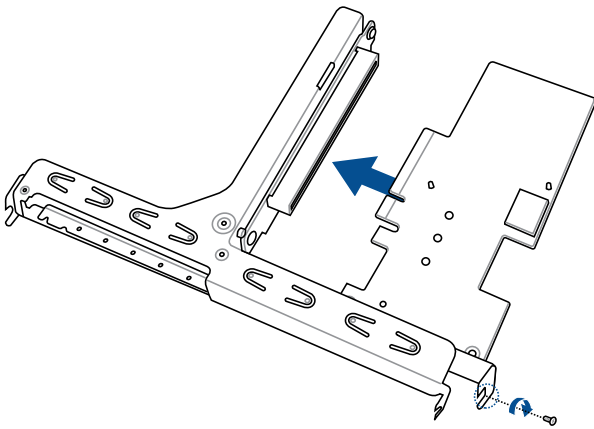

5. Remove the default mini-SAS HD cable from the motherboard.

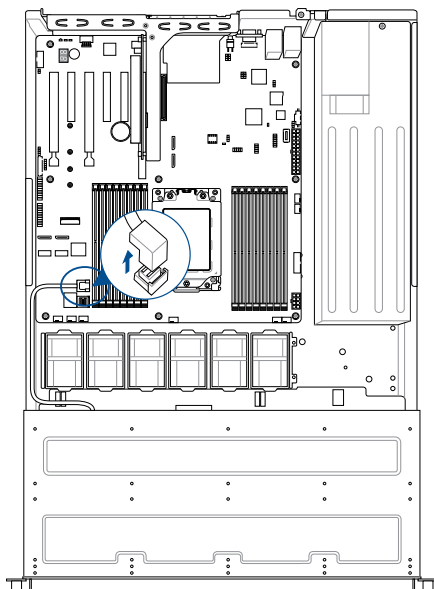

6. Connect the mini-SAS HD cable to connector 1 of the ASUS PIKE II card.

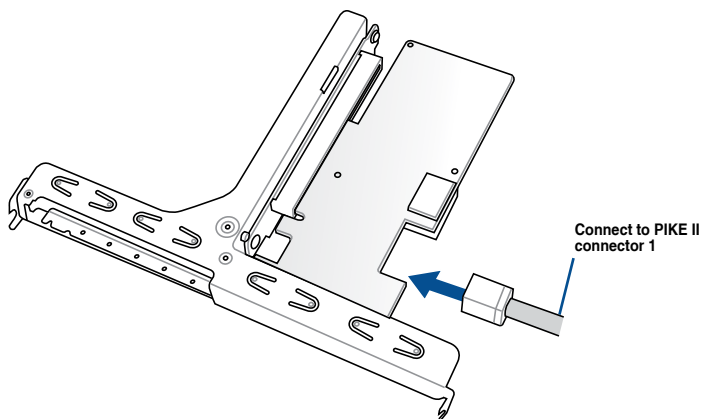

7. Reinstall the riser card bracket into the PCI Express x24 slot on the motherboard. Ensure that the golden connectors of the riser card bracket is firmly seated in place.

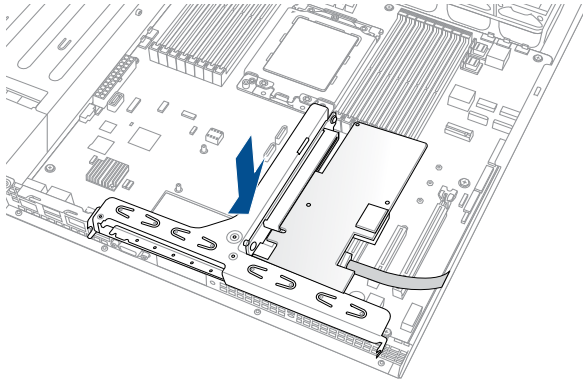

2.5.3 Installing M.2 (NGFF) cards

To install an M.2 (NGFF) card:

1. Locate the M.2 (NGFF) connector on your motherboard.

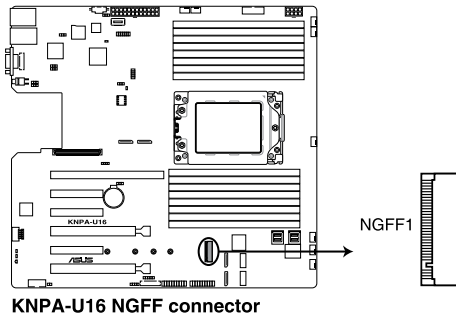

2. Remove the top screw and the stand from the motherboard.

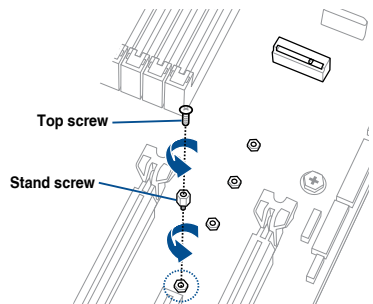

3. Select an appropriate screw hole on the motherboard for your M.2 card, then secure the stand to the motherboard.

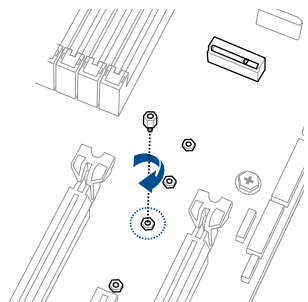

4. Prepare the M.2 card.
5. Align and insert the M.2 card into the M.2 connector on the motherboard.

Ensure that the golden connector of the M.2 card is inserted firmly in place and that the screw hole on the M.2 card matches the stand screw on the motherboard.

6. Secure the M.2 card with the top screw.

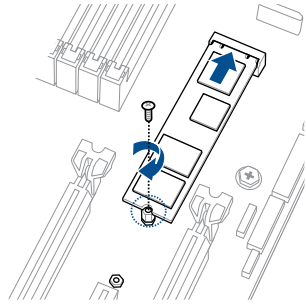

Ensure that the M.2 card is positioned between the top screw and the stand screw before securing it.

2.5.4 Installing Mezzanine cards

To install a Mezzanine card:

1. Locate the Mezzanine card connector on your motherboard.

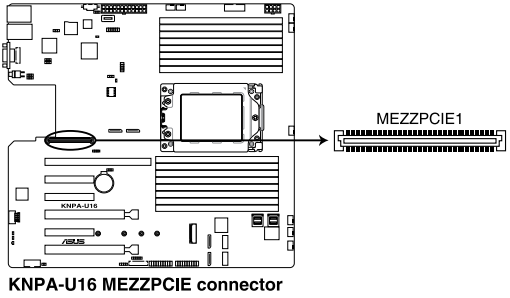

2. Firmly hold the riser card bracket, then pull it up to detach it from the PCI Express x24 slot on the motherboard.

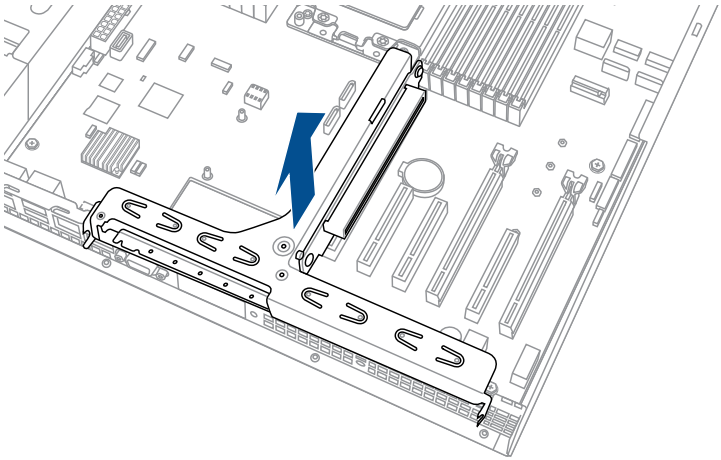

3. Select the slots that are going to be used for your Mezzanine card, then use a screwdriver and pry the corresponding slots until it pops off.

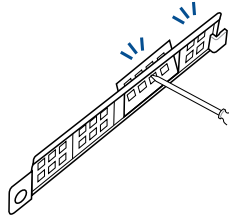

4. Prepare your Mezzanine card and the signal cable. Connect the signal transmission end (white) to the AUXLED_CON header on the card.

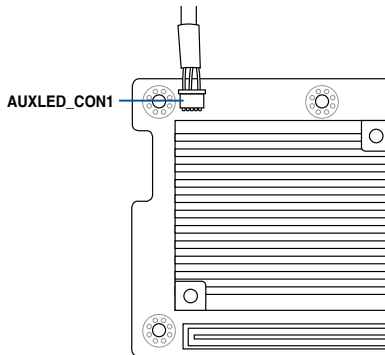

5. Insert the ports of the Mezzanine card into the mounting hole on the chassis, then insert the golden connector of the Mezzanine card into the **MEZZPCIE1** (OCP) connector on the motherboard.

Ensure that the stand screws on the motherboard is aligned and matched to the screw holes of the Mezzanine card.

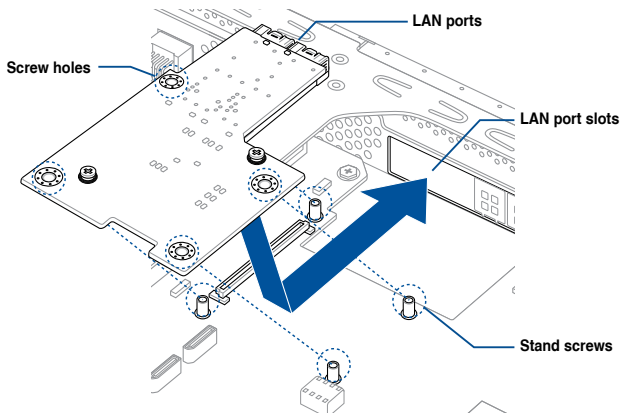

6. Secure the Mezzanine card with the four (4) bundled screws.

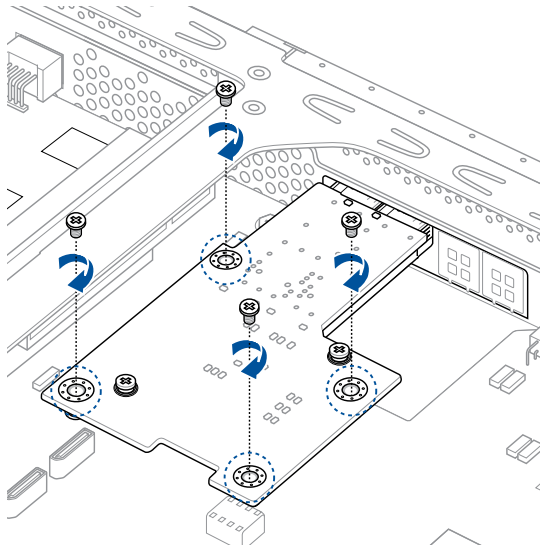

7. Connect the signal end (black) to the OCP_LED1 header on the motherboard.

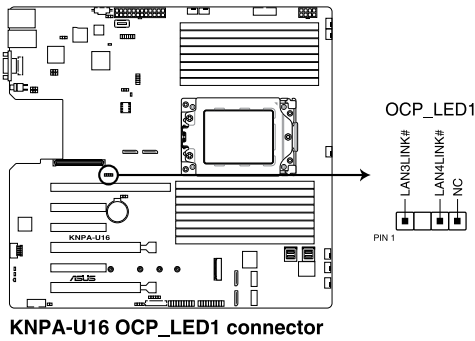

The two ends of the signal cable are different in size and color for easy recognition. Please refer to your exact cable.

8. Reinstall the riser card bracket into the PCI Express x24 slot on the motherboard. Ensure that the golden connectors of the riser card bracket is firmly seated in place.

2.5.5 Configuring an expansion card

After installing the expansion card, configure the it by adjusting the software settings.

1. Turn on the system and change the necessary BIOS settings, if any. See Chapter 5 for information on BIOS setup.
2. Assign an IRQ to the card. Refer to the following tables.
3. Install the software drivers for the expansion card.

Standard Interrupt assignments

IRQ	Priority	Standard function
0	1	System Timer
1	2	Keyboard Controller
2	-	Programmable Interrupt
3*	11	Communications Port (COM2)
4*	12	Communications Port (COM1)
5*	13	--
6	14	Floppy Disk Controller
7*	15	--
8	3	System CMOS/Real Time Clock
9*	4	ACPI Mode when used
10*	5	IRQ Holder for PCI Steering
11*	6	IRQ Holder for PCI Steering
12*	7	PS/2 Compatible Mouse Port
13	8	Numeric Data Processor
14*	9	Primary IDE Channel
15*	10	Secondary IDE Channel

* These IRQs are usually available for ISA or PCI devices.

2.6 Cable connections



- The bundled system cables are pre-connected before shipment. You do not need to disconnect these cables unless you will remove pre-installed components to install additional devices.
- Refer to Chapter 4 for detailed information on the connectors.

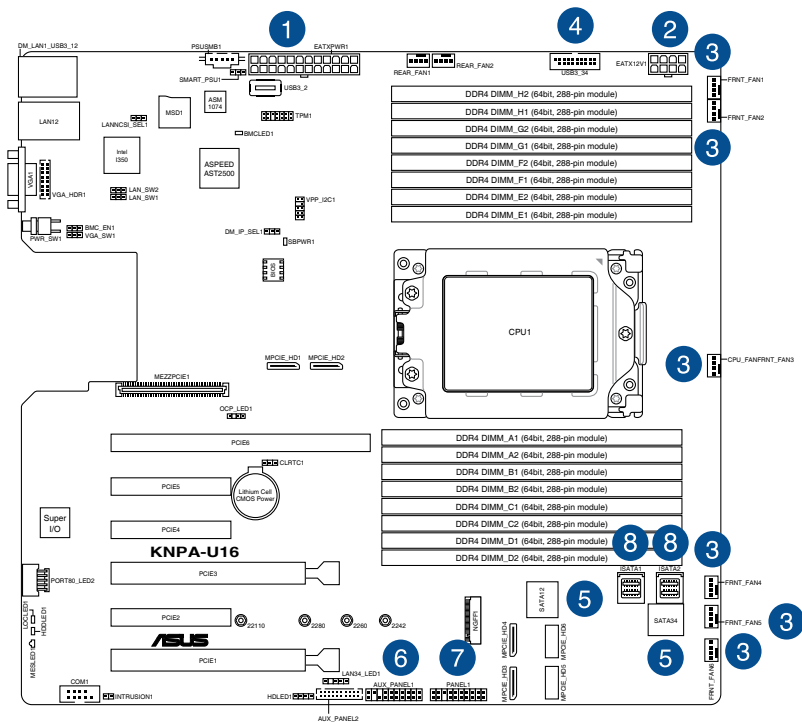

Standard cables connected to the motherboard

1. 24-pin ATX power connector (from power supply to motherboard)
2. 8-pin 12V power connector (from power supply to motherboard)
3. System fan connector (from system fan to motherboard)
4. USB connector (from motherboard to front I/O board)
5. SATA connector (system default; from motherboard to backplane)
6. System auxiliary panel connector (from motherboard to front I/O board)
7. System panel connector (from motherboard to front I/O board)
8. Mini-SAS HD connector (from motherboard to backplane)

2.7 SATA/SAS backplane cabling

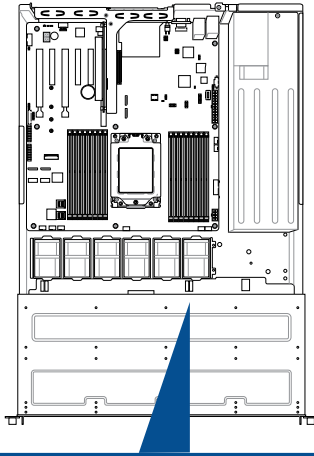

RS500A-E9-RS4 / RS500A-E9-PS4

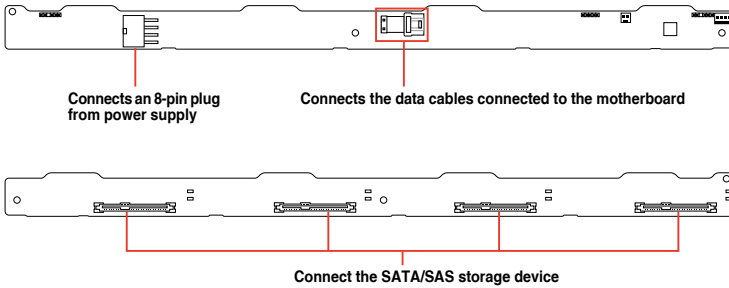

RS500A-E9-RS4-U

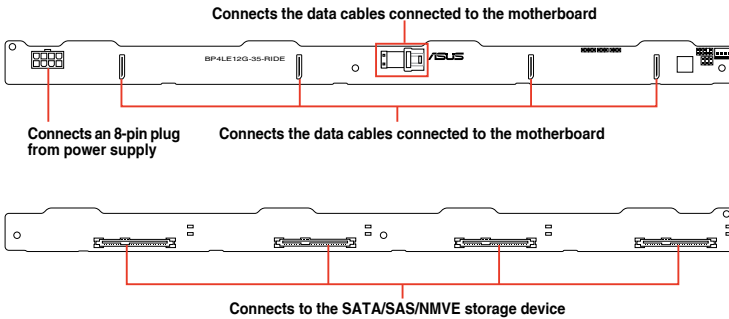

2.8 Removable/optional components

You may need to remove previously installed system components when installing or removing system devices. Or you may need to install the optional components into the system. This section tells how to remove/install the system fans:



Ensure that the system is turned off before removing any components from your system.

2.8.1 System fans

To uninstall the system fans:

1. Disconnect the system fan cable from the fan connector on the motherboard.
2. Lift the fan, then set aside.
3. Repeat steps 1 to 2 to uninstall the other system fans.

To reinstall the system fans

1. Insert the fan to the fan cage. The airflow directional arrow on the fan side should point towards the system rear panel.
2. Connect the system fan cable to the fan connector on the motherboard.

Installation Options

3

This chapter describes how to install the optional components and devices into the barebone server.

3.1 Rail kit installation

3.1.1 Tool-less Friction Rail Kit

The tool less design of the rail kit allows you to easily install the rack rails into the server rack without the need for additional tools. The kit also comes with a metal stopping bracket that can be installed to provide additional support and stability to the server.

The tool-less rail kit package includes:

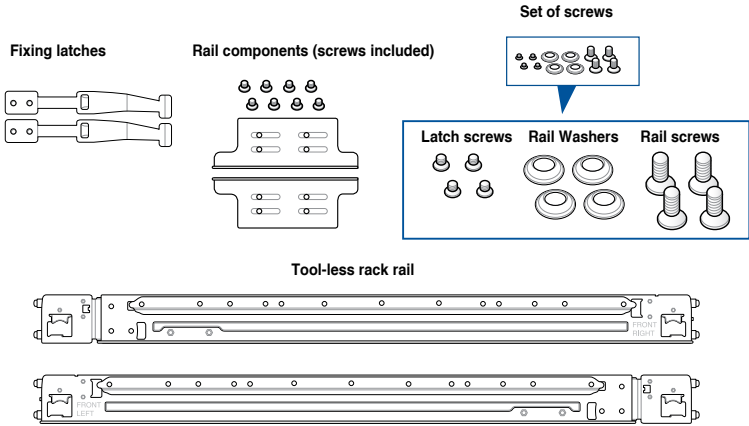

3.1.2 Installing the tool-less rack rail

To install the tool-less rack rails into the rack:

1. Secure the two fixing latches to the two sides of the server using the set of latch screws.



The locations of the screw holes vary with different server models. Refer to your server user manual for details.

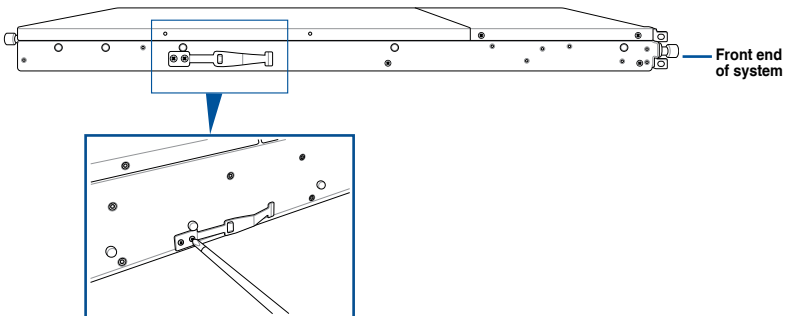



Follow steps 2 to 4 if the depth of your server rack exceeds 850mm, if the depth of your server rack is less than 850mm, please skip steps 2 to 4 and proceed with step 5.

2. Slightly slide out and extend the right rack rail, then prepare one of the bundled rail components.

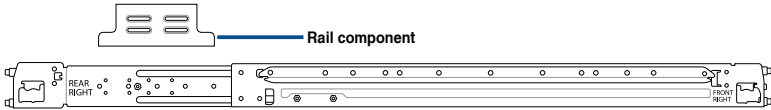

3. Align the rail component with the right rack rail and secure it using four (4) bundled screws.

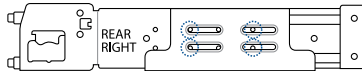

4. Follow steps 2 and 3 to secure the rail component to the left rail rack.
5. Select a desired space and place the appropriate rack rail (left and right) on opposite positions on the rack.



A 1U space consists of three square mounting holes with two thin lips on the top and the bottom.

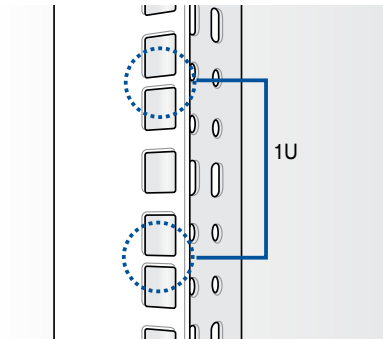

6. Secure the rail components to the rail using the bundled screws.
7. Press the spring lock (A) then insert the studs into the selected square mounting holes on the rack post.
8. Press the spring lock on the other end of rail then insert the stud into the mounting hole on the rack post. Extend the rack rail, if necessary.
9. (Optional) Use the rail screw and rail washer (B) that comes with the kit to secure the rack rail to the rack post.
10. Perform steps 3 to 5 for the other rack rail.



Ensure that the installed rack rails (left and right) are aligned, secured, and stable in place.

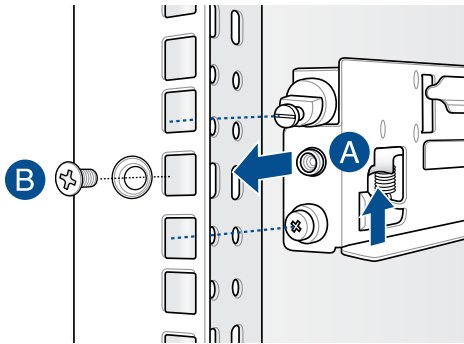

11. Lift the server chassis and insert into the rack rail.



Ensure that the rack rail cabinet and the rack posts are stable and standing firmly on a level surface.

3.2 Rail kit dimensions

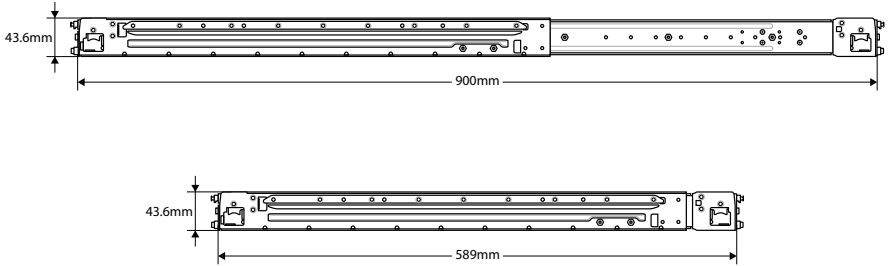

Motherboard Information

4

This chapter includes the motherboard layout and brief descriptions of the jumpers and internal connectors.

4.1 Motherboard layout

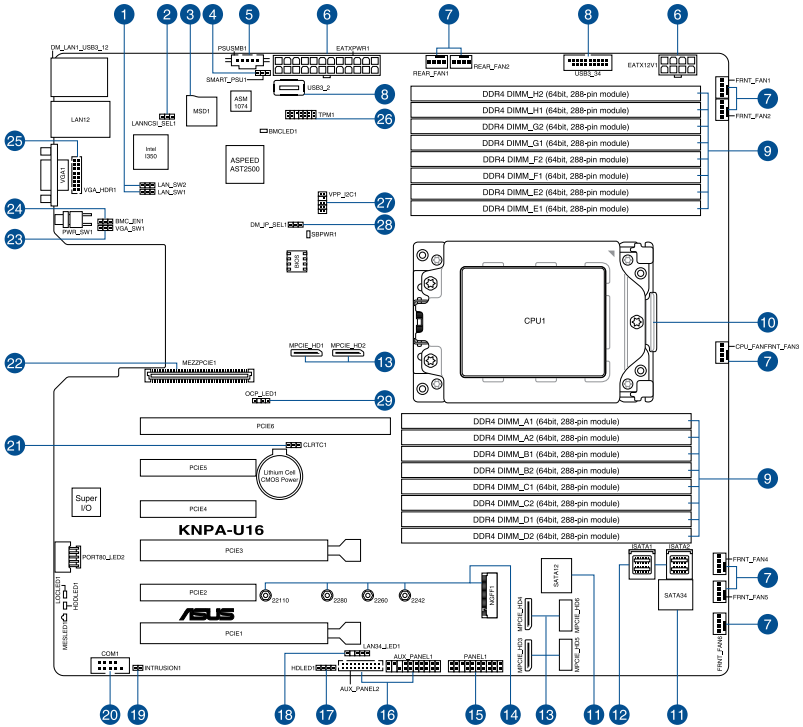

Layout contents

Internal connectors / Sockets / Jumpers / LEDs	Page
1. LAN controller settings (3-pin LAN_SW1-2)	4-5
2. LANNCSI setting (3-pin LANNCSI_SEL1)	4-7
3. Micro SD card slot (MSD1)	4-20
4. Smart Ride Through (SmaRT) setting (3-pin SMART_PSU1)	4-7
5. Power Supply SMBus connector (5-pin PSUSMB1)	4-11
6. ATX power connectors (24-pin EATXPWR1, 8-pin EATX12V1)	4-14
7. CPU, front, and rear fan connectors (4-pin FRNT_FAN1-7, REAR_FAN1-2)	4-13
8. USB 3.0 connector (20-1 pin USB3_34; 4-pin Type-A USB3_4)	4-12
9. DDR4 DIMM sockets	2-7
10. CPU socket	2-3
11. Serial ATA connectors (7-pin SATA1-4)	4-11
12. Mini-SAS HD connectors (ISATA1-2)	4-21
13. OCUPCIE connectors (MPCIE_HD1-6)	4-18
14. M.2 (NGFF) connectors (NGFF1)	4-19
15. System panel connector (20-1 pin PANEL1)	4-15
16. Auxiliary panel connector (20-2 pin AUX_PANEL1, 20-pin AUX_PANEL2)	4-16
17. Hard disk activity LED connector (4-pin HDLED1)	4-17
18. LAN Activity LED connector (5-1 pin LAN34_LED1)	4-13
19. Chassis Intrusion connectors (2-pin INTRUSION)	4-18
20. Serial port connector (10-1 pin COM1)	4-12
21. Clear RTC RAM (3-pin CLRTC1)	4-4
22. Mezzanine PCIE card connectors (MEZZPCIE1)	4-19
23. VGA controller setting (3-pin VGA_SW1)	4-5
24. BMC Setting (3-pin BMC_EN1)	4-6
25. VGA connector (10-1 pin VGA_HDR1)	4-17
26. Trusted Platform Module connector (14-1 pin TPM1)	4-14
27. VPP_I2C1 connector (10-1 pin VPP_I2C1)	4-21
28. DMLAN setting (3-pin DM_IP_EN1)	4-6
29. OCP LAN Activity LED connector (4-1 pin OCP_LED1)	4-20

4.2 Jumpers

1. Clear RTC RAM (3-pin CLRTC1)

This jumper allows you to clear the Real Time Clock (RTC) RAM in CMOS. You can clear the CMOS memory of date, time, and system setup parameters by erasing the CMOS RTC RAM data. The onboard button cell battery powers the RAM data in CMOS which include system setup information such as system passwords.

To erase the RTC RAM:

1. Turn OFF the computer and unplug the power cord.
2. Move the jumper cap from the default pins 1–2 to pins 2–3. Keep the cap on pins 2–3 for about 5 to 10 seconds, then move the cap back to pins 1–2.
3. Plug the power cord and turn ON the computer.
4. Hold down the key during the boot process and enter BIOS setup to re-enter data.



DO NOT remove the cap on CLRTC jumper default position except when clearing the RTC RAM. Removing the cap will cause system boot failure!



If the steps above do not help, remove the onboard battery and move the jumper again to clear the CMOS RTC RAM data. After the CMOS clearance, reinstall the battery.

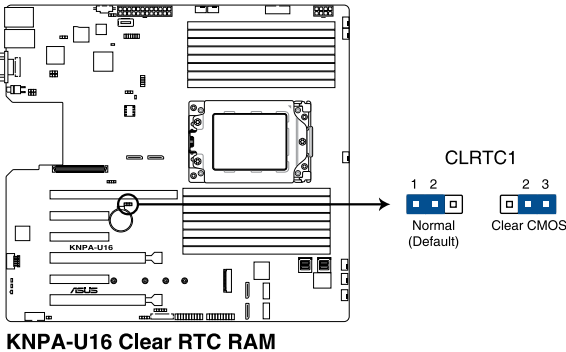

2. VGA controller setting (3-pin VGA_SW1)

This jumper allows you to enable or disable the onboard VGA controller. Set to pins 1–2 to activate the VGA feature.

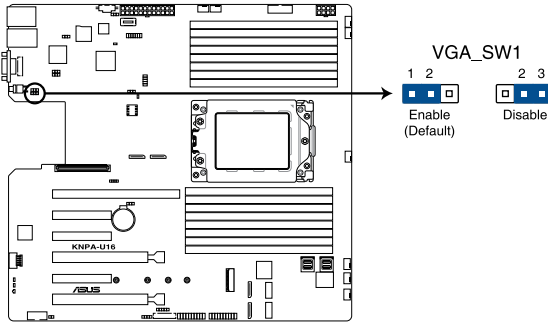

KNPA-U16 VGA setting

3. LAN controller settings (3-pin LAN_SW1-2)

These jumpers allow you to enable or disable the onboard LAN_SW1 or LAN_SW2. Set to pins 1-2 to activate the Gigabit LAN feature.

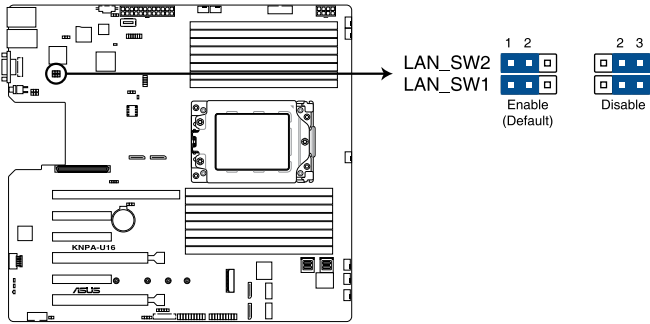

KNPA-U16 LAN setting

4. BMC Setting (3-pin BMC_EN1)

This jumper allows you to enable or disable the Baseboard Management Controller (ASMB9).

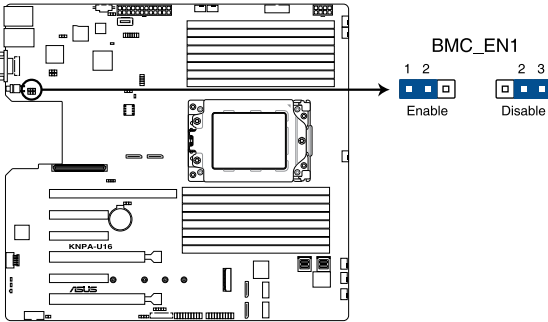

KNPA-U16 BMC_EN1 setting

5. DMLAN setting (3-pin DM_IP_EN1)

This jumper allows you to select the DMLAN setting. Set to pins 2-3 to force the DMLAN IP to static mode (IP=10.10.10.10, submask=255.255.255.0).

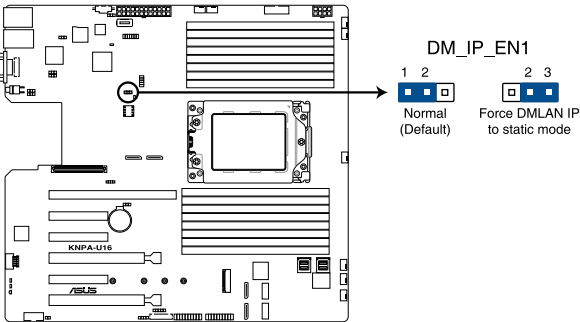

KNPA-U16 DM_IP_EN1 setting

6. LANNCSE setting (3-pin LANNCSE_SEL1)

This jumper allows you to select which LAN NCSE to function.

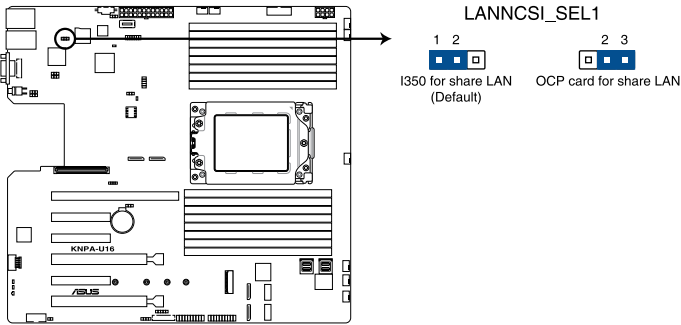

KNPA-U16 LANNCSE setting

7. Smart Ride Through (SmaRT) setting (3-pin SMART_PSU1)

This jumper allows you to enable or disable the Smart Ride Through (SmaRT) function. This feature is enabled by default. Set to pins 2-3 to disable it. When enabled, SmaRT allows uninterrupted operation of the system during an AC loss event.

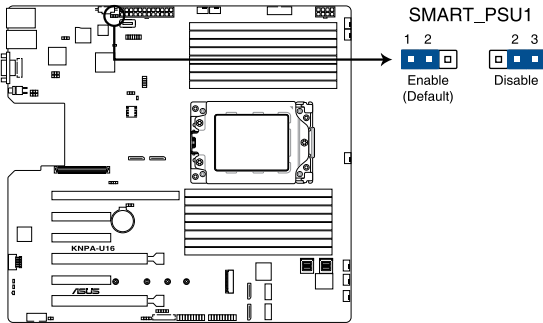

KNPA-U16 Smart Ride Through setting

4.3 Onboard LEDs

1. Standby Power LED (SBPWR1)

The motherboard comes with a standby power LED. The green LED lights up to indicate that the system is ON, in sleep mode, or in soft-off mode. This is a reminder that you should shut down the system and unplug the power cable before removing or plugging in any motherboard component. The illustration below shows the location of the onboard LED.

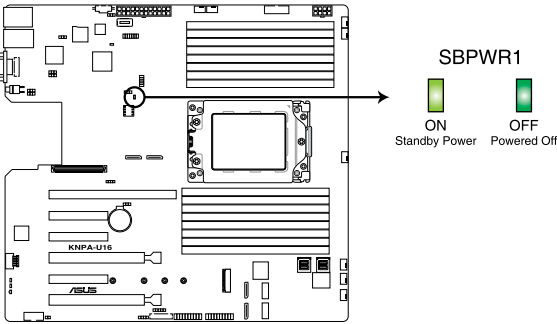

KNPA-U16 Standby Power LED

2. BMC LED (BMCLED1)

The BMC LED lights up to indicate that the on-board BMC is functional.

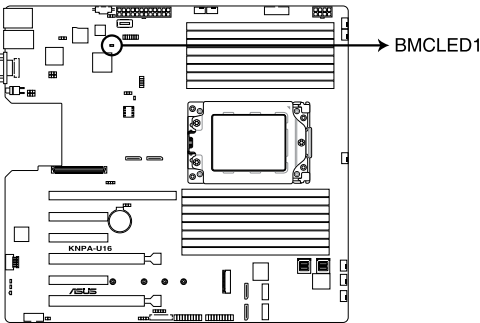

KNPA-U16 BMC LED



This LED functions only when you enable ASUS ASMB9.

3. Location LED (LOCLE1)

This onboard LED lights up when the Location button on the server is pressed or when triggered by a system management software. The Location LED helps visually locate and quickly identify the server in error on a server rack.

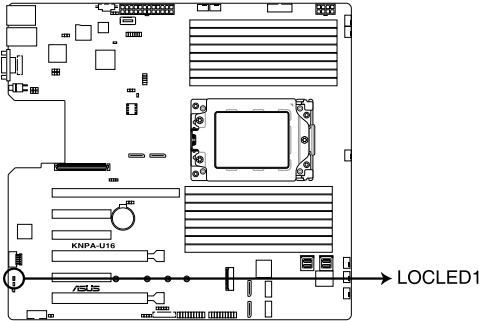

KNPA-U16 Location LED

4. Message LED (MESLED1)

This onboard LED lights up to red when there is a BMC event log is generated.

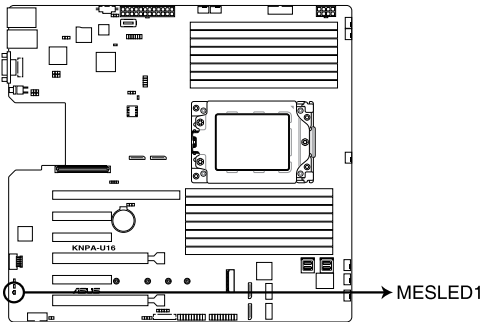

KNPA-U16 MESLED

5. Hard disk activity LED (HDDLED1)

This LED is for the storage devices connected to the onboard SATA, or SATA/SAS add-on card. The read or write activities of any device connected to the onboard SATA, or SATA/SAS add-on card causes the rear panel LED to light up.

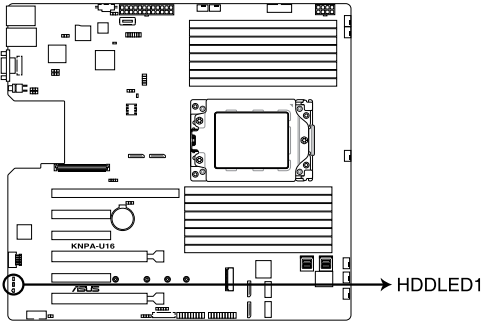

KNPA-U16 Storage device activity LED

4.4 Internal connectors

1. Serial ATA connectors (7-pin SATA1-4)

These connectors, controlled by AMD integrated SATA controller, are for the Serial ATA signal cables for Serial ATA drives (SATA 1 connector is used for the optical drive by default).

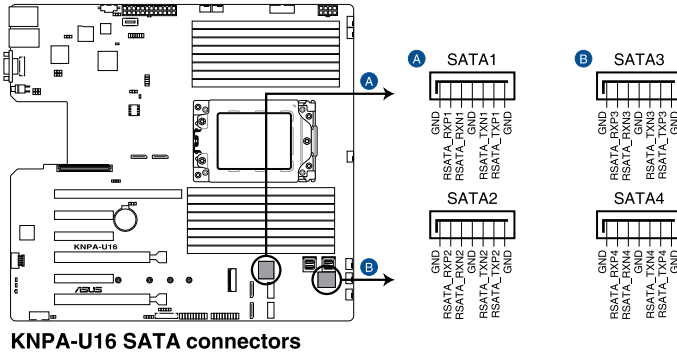

The actual data transfer rate depends on the speed of Serial ATA hard disks installed.

2. Power Supply SMBus connector (5-pin PSUSMB1)

This connector allows you to connect SMBus (System Management Bus) to the PSU (power supply unit) to read PSU information. Devices communicate with an SMBus host and/or other SMBus devices using the SMBus interface.

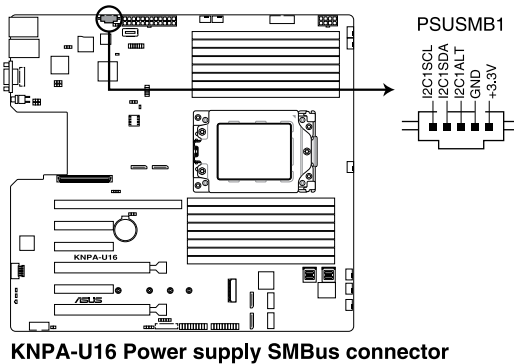

This connector functions only when you enable ASUS ASMB9.

3. USB 3.0 connector (20-1 pin USB3_34; 4-pin Type-A USB3_4)

The 20-1 pin connector allows you to connect a USB 3.0 module for additional USB 3.0 front or rear panel ports. The 4-pin USB (Universal Serial Bus) Type-A port is available for connecting USB 3.0 devices.

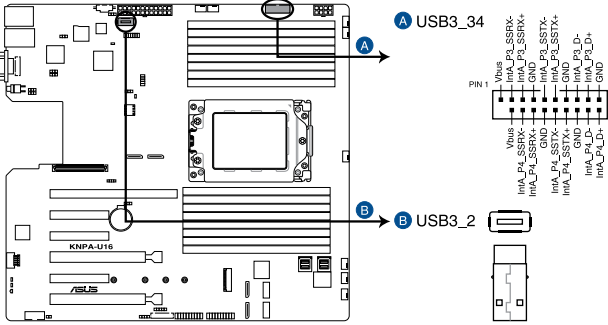

KNPA-U16 USB 3.0 connectors

4. Serial port connector (10-1 pin COM1)

This connector is for the serial COM port. Connect the serial port module cable to one of these connectors, then install the module to a slot opening at the back of the system chassis.

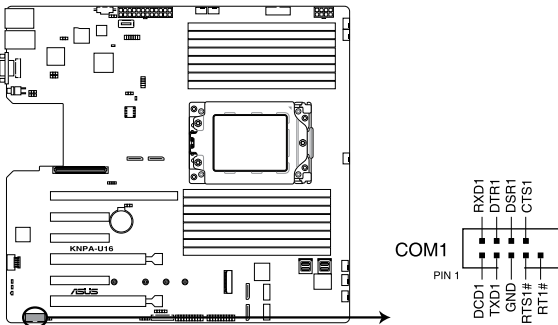

KNPA-U16 Serial port connector



The COM module is purchased separately.

5. CPU, front, and rear fan connectors (4-pin FRNT_FAN1-7, REAR_FAN1-2)

The fan connectors support cooling fans. Connect the fan cables to the fan connectors on the motherboard, ensuring that the black wire of each cable matches the ground pin of the connector.



- DO NOT forget to connect the fan cables to the fan connectors. Insufficient air flow inside the system may damage the motherboard components.
- These are not jumpers! DO NOT place jumper caps on the fan connectors!
- All fans feature the ASUS Smart Fan technology.

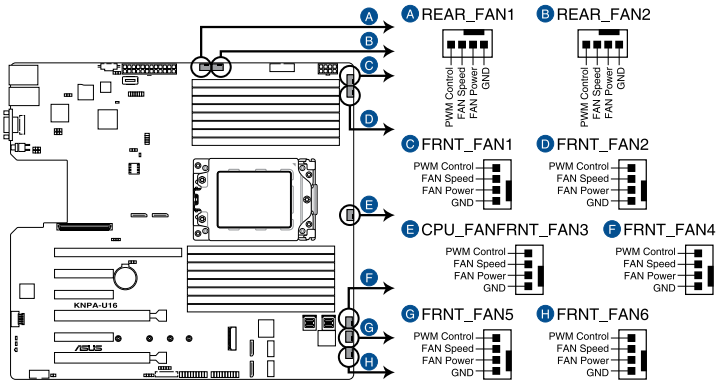

KNPA-U16 FAN connectors

6. LAN Activity LED connector (5-1 pin LAN34_LED1)

These leads are for 10G LAN activity LEDs on the front panel. Connect the LAN LED cable to the backplane for LAN activity indication.

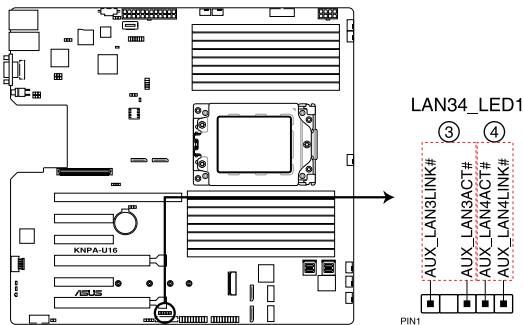

KNPA-U16 LAN3 & LAN4 LED

7. Trusted Platform Module connector (14-1 pin TPM1)

This connector supports a Trusted Platform Module (TPM) system, which can securely store keys, digital certificates, passwords, and data. A TPM system also helps enhance network security, protects digital identities, and ensures platform integrity.

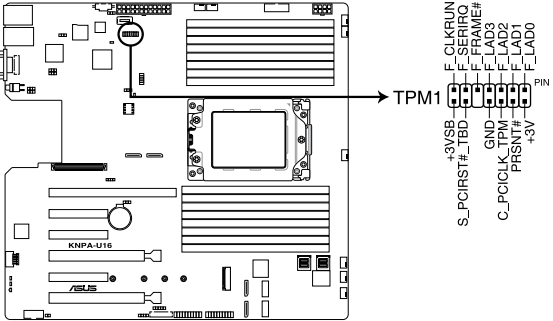

KNPA-U16 TPM connector

8. ATX power connectors (24-pin EATXPWR1, 8-pin EATX12V1)

These connectors are for the ATX power supply plugs. The power supply plugs are designed to fit these connectors in only one orientation. Find the proper orientation and push down firmly until the connectors completely fit.



- DO NOT forget to connect the 24-pin and the 8-pin power plugs; otherwise, the system will not boot up.
- Use of a power supply unit (PSU) with a higher power output is recommended when configuring a system with more power-consuming devices. The system may become unstable or may not boot up if the power is inadequate.
- This motherboard supports ATX2.0 PSU or later version.
- Ensure that your PSU can provide at least the minimum power required by your system.

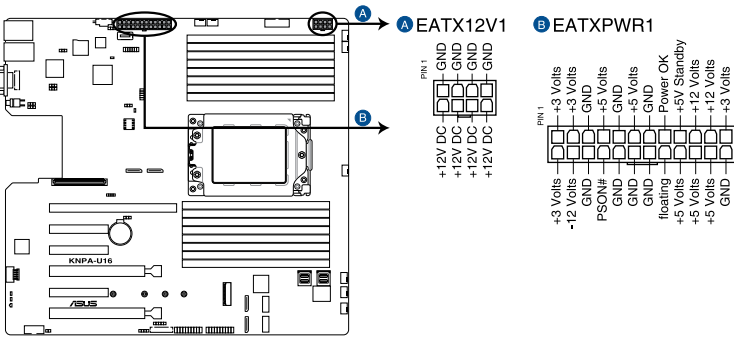

9. System panel connector (20-1 pin PANEL1)

This connector supports several chassis-mounted functions.

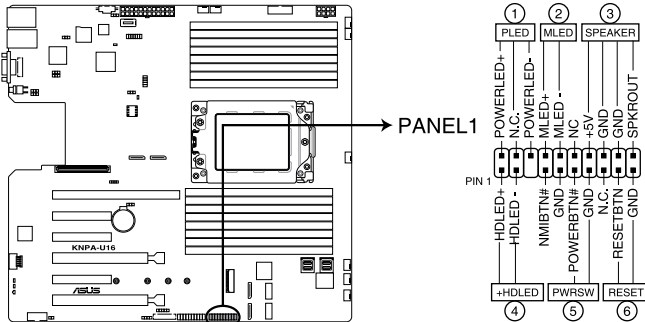

KNPA-U16 System panel connector

1. System power LED (3-pin PLED)

This 3-pin connector is for the system power LED. Connect the chassis power LED cable to this connector. The system power LED lights up when you turn on the system power, and blinks when the system is in sleep mode.

2. Message LED (2-pin MLED)

This 2-pin connector is for the message LED cable that connects to the front message LED. The message LED is controlled by the BMC to indicate an abnormal event occurrence.

3. System warning speaker (4-pin SPEAKER)

This 4-pin connector is for the chassis-mounted system warning speaker. The speaker allows you to hear system beeps and warnings.

4. Hard disk drive activity LED (2-pin HDLED)

This 2-pin connector is for the HDD Activity LED. Connect the HDD Activity LED cable to this connector. The LED lights up or flashes when data is read from or written to the HDD.

5. ATX power button/soft-off button (2-pin PWRSW)

This connector is for the system power button. Pressing the power button turns the system on or puts the system in sleep or soft-off mode depending on the BIOS settings. Pressing the power switch for more than four seconds while the system is ON turns the system OFF.

6. Reset button (2-pin RESET)

This 2-pin connector is for the chassis-mounted reset button for system reboot without turning off the system power.

10. Auxiliary panel connector (20-2 pin AUX_PANEL1, 20-pin AUX_PANEL2)

This connector is for additional front panel features including front panel SMB, locator LED and switch, chassis intrusion, and LAN LEDs.

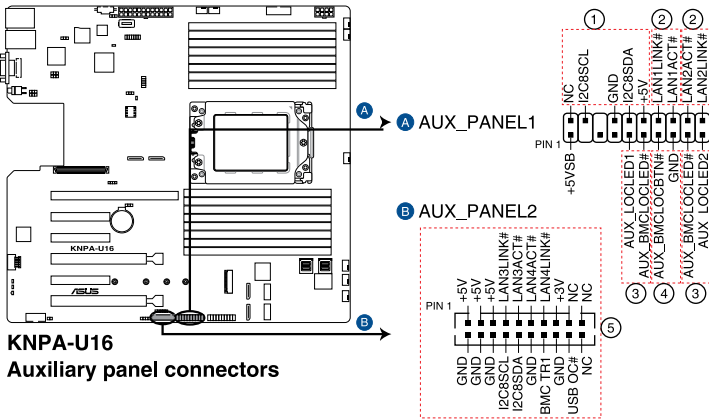

1. Front panel SMB (6-1 pin FPSMB)

These leads connect the front panel SMBus cable.

2. LAN activity LED (2-pin LAN1_LED, LAN2_LED)

These leads are for the Gigabit LAN activity LEDs on the front panel.

3. Locator LED (2-pin LOCATORLED1, LOCATORLED2)

These leads are for the locator LED1 and LED2 on the front panel. Connect the Locator LED cables to these 2-pin connector. The LEDs will light up when the Locator button is pressed.

4. Locator Button/Switch (2-pin LOCATORBTN)

These leads are for the locator button on the front panel. This button queries the state of the system locator.

5. LAN activity LED and USB port (2-pin LAN3_LED, LAN4_LED, USB ports)

These leads are for the Gigabit LAN activity LEDs and USB ports on the front panel.

11. VGA connector (10-1 pin VGA_HDR1)

This connector supports the VGA High Dynamic-Range interface.

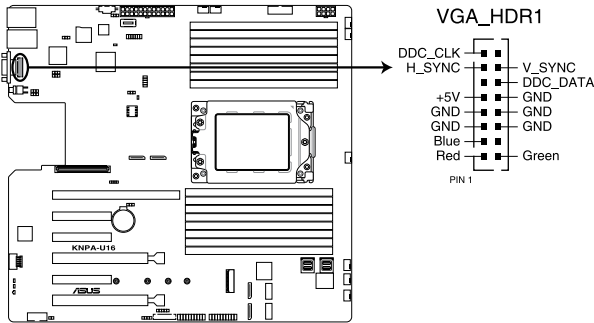

KNPA-U16 Internal VGA connector

12. Hard disk activity LED connector (4-pin HDLED1)

This LED connector is for the storage add-on card cable connected to the SATA or SAS add-on card. The read or write activities of any device connected to the SATA or SAS add-on card causes the front panel LED to light up.

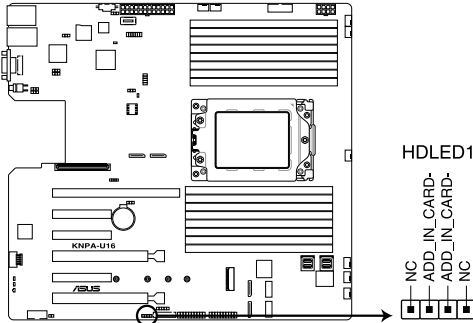

KNPA-U16 Storage device activity LED connector

13. Chassis Intrusion connectors (2-pin INTRUSION)

This lead is for the intrusion detection feature for chassis with intrusion sensor or microswitch. When you remove any chassis component, the sensor triggers and sends a high level signal to these leads to record a chassis intrusion event. The default setting is short CASEOPEN and GND pin by jumper cap to disable the function.

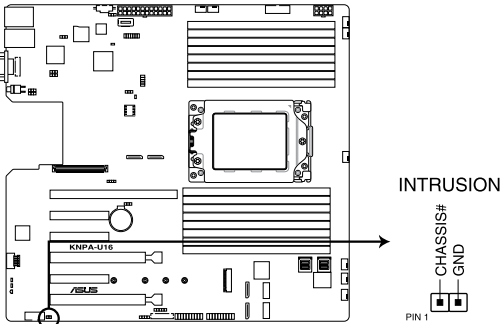

KNPA-U16 Chassis Intrusion connector

14. OCUPCIE connectors (MPCIE_HD1-6)

Connects the PCIE signal to the NVME port on the backplane.

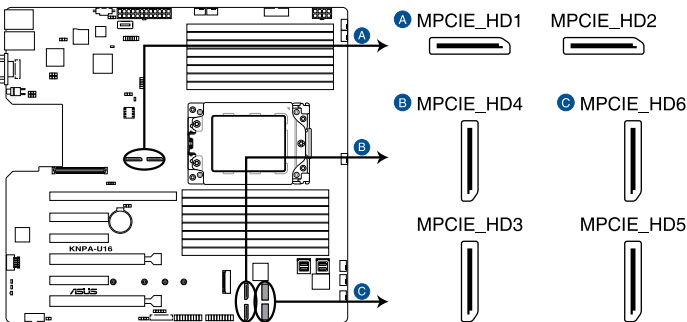

KNPA-U16 MPCIE_HD connectors

15. M.2 (NGFF) connectors (NGFF1)

This connector allows you to install M.2 devices.

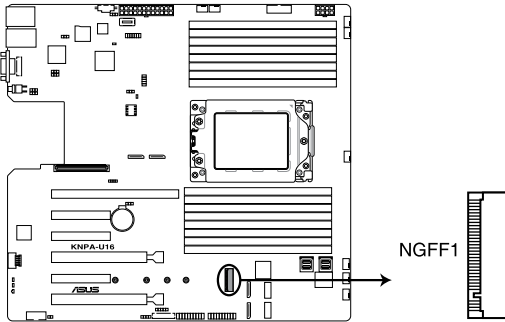

KNPA-U16 NGFF connector



This connector supports type 2242/2260/2280/22110 devices on both PCI-E and SATA interface.



The M.2 (NGFF) device is purchased separately.

16. Mezzanine PCIe card connectors (MEZZPCIE1)

The MEZZPCIE1 connector supports Open Compute Project (OCP) cards.

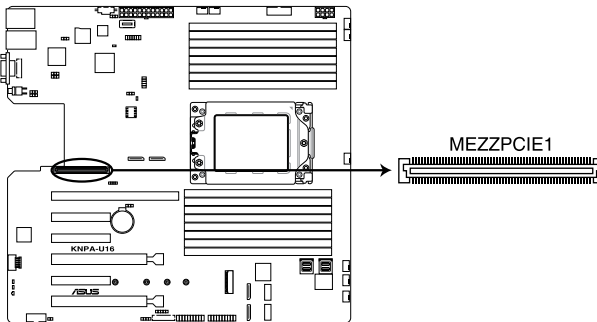

KNPA-U16 MEZZPCIE connector

17. OCP LAN Activity LED connector (4-1 pin OCP_LED1)

OCP LAN LED connector supports OCP LAN card Active LED.

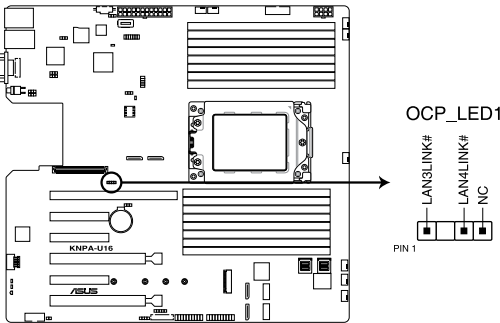

KNPA-U16 OCP_LED1 connector

18. Micro SD card slot (MSD1)

Your motherboard supports SD Memory Card v2.00 (SDHC) / v3.00 (SDXC).

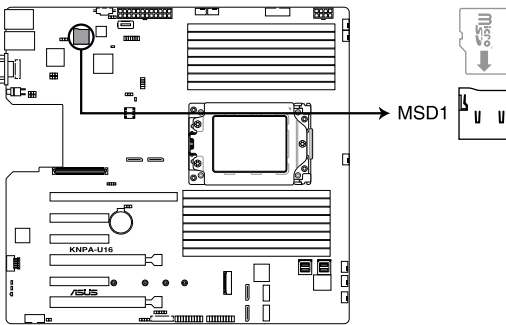

KNPA-U16 MSD1



Disconnect all power (including redundant PSUs) from the existing system before you add or remove a Memory Card, then reboot the system to access the Memory Card.



- This Micro SD card slot functions only when you enable ASUS ASMB9.
- Some memory cards may not be compatible with your motherboard. Ensure that you use only compatible memory cards to prevent loss of data, damage to your device, or memory card, or both.

19. Mini-SAS HD connectors (ISATA1-2)

This motherboard comes with mini Serial Attached SCSI (SAS) HD connectors, the storage technology that supports Serial ATA. Each connector supports up to four devices.

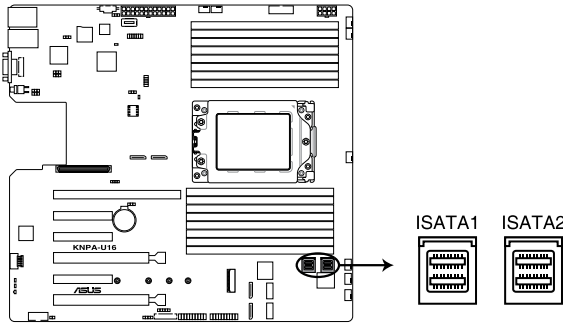

KNPA-U16 ISATA connectors

20. VPP_I2C1 connector (10-1 pin VPP_I2C1)

This connector is used for the Intel VMD function and sensor readings.

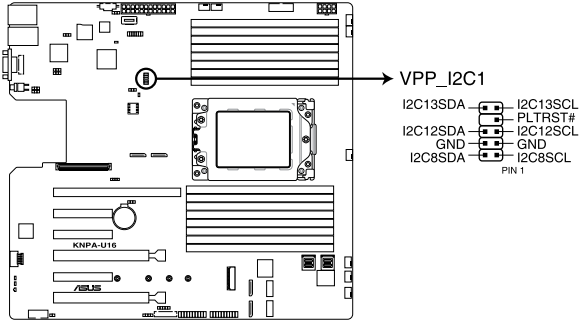

KNPA-U16 VPP_I2C1 connector

BIOS Setup

5

This chapter tells how to change the system settings through the BIOS Setup menus. Detailed descriptions of the BIOS parameters are also provided.

5.1 Managing and updating your BIOS

The following utilities allow you to manage and update the motherboard Basic Input/Output System (BIOS) setup:

1. **ASUS CrashFree BIOS 3**

To recover the BIOS using a bootable USB flash disk drive when the BIOS file fails or gets corrupted.

2. **ASUS EzFlash**

Updates the BIOS using a USB flash disk.

3. **BUPDATER**

Updates the BIOS in DOS mode using a bootable USB flash disk drive.

Refer to the corresponding sections for details on these utilities.



Save a copy of the original motherboard BIOS file to a bootable USB flash disk drive in case you need to restore the BIOS in the future. Copy the original motherboard BIOS using the BUPDATER utility.

5.1.1 **ASUS CrashFree BIOS 3 utility**

The ASUS CrashFree BIOS 3 is an auto recovery tool that allows you to restore the BIOS file when it fails or gets corrupted during the updating process. You can update a corrupted BIOS file using a USB flash drive that contains the updated BIOS file.



Prepare a USB flash drive containing the updated motherboard BIOS before using this utility.

Recovering the BIOS from a USB flash drive

To recover the BIOS from a USB flash drive:

1. Insert the USB flash drive with the original or updated BIOS file to one USB port on the system.
2. The utility will automatically recover the BIOS. It resets the system when the BIOS recovery finished.



DO NOT shut down or reset the system while recovering the BIOS! Doing so would cause system boot failure!



The recovered BIOS may not be the latest BIOS version for this motherboard. Visit the ASUS website at www.asus.com to download the latest BIOS file.

5.1.2 ASUS EZ Flash Utility

The ASUS EZ Flash Utility feature allows you to update the BIOS without having to use a DOS-based utility.



Before you start using this utility, download the latest BIOS from the ASUS website at www.asus.com.

To update the BIOS using EZ Flash Utility:

1. Insert the USB flash disk that contains the latest BIOS file into the USB port.
2. Enter the BIOS setup program. Go to the **Tool** menu then select **ASUS EZ Flash Utility**. Press <Enter>.

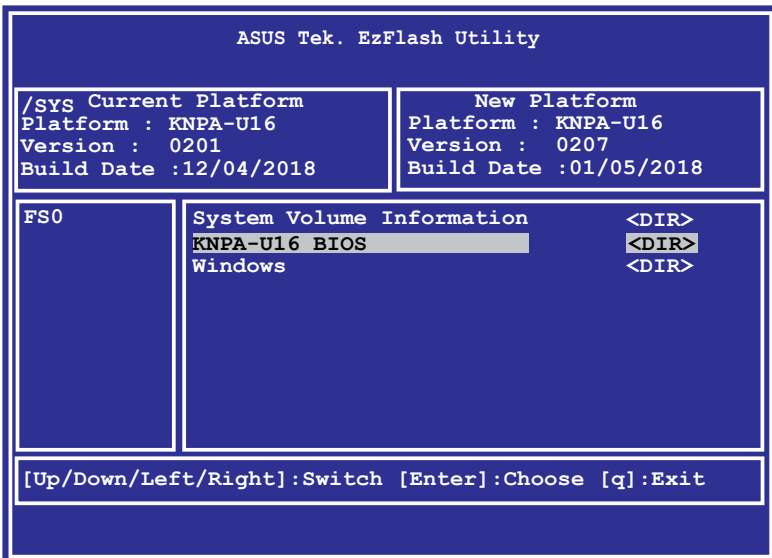

3. Press <Tab> to switch to the **Drive** field.
4. Press the Up/Down arrow keys to find the USB flash disk that contains the latest BIOS, then press <Enter>.
5. Press <Tab> to switch to the **Folder Info** field.

6. Press the Up/Down arrow keys to find the BIOS file, and then press <Enter> to perform the BIOS update process. Reboot the system when the update process is done.



- This function can support devices such as a USB flash disk with FAT 32/16 format and single partition only.
- DO NOT shut down or reset the system while updating the BIOS to prevent system boot failure!



Ensure to load the BIOS default settings to ensure system compatibility and stability. Press <F5> and select **Yes** to load the BIOS default settings.

5.1.3 BUPDATER utility



The succeeding BIOS screens are for reference only. The actual BIOS screen displays may not be the same as shown.

The BUPDATER utility allows you to update the BIOS file in the DOS environment using a bootable USB flash disk drive with the updated BIOS file.

Updating the BIOS file

To update the BIOS file using the BUPDATER utility:

1. Visit the ASUS website at www.asus.com and download the latest BIOS file for the motherboard. Save the BIOS file to a bootable USB flash disk drive.
2. Copy the BUPDATER utility (BUPDATER.exe) from the ASUS support website at <https://www.asus.com/support> to the bootable USB flash disk drive you created earlier.
3. Boot the system in DOS mode, then at the prompt, type:

```
BUPDATER /i [filename] .CAP
```

where [filename] is the latest or the original BIOS file on the bootable USB flash disk drive, then press <Enter>.

```
A:\>BUPDATER /i[file name].CAP
```

- The utility verifies the file, then starts updating the BIOS file.

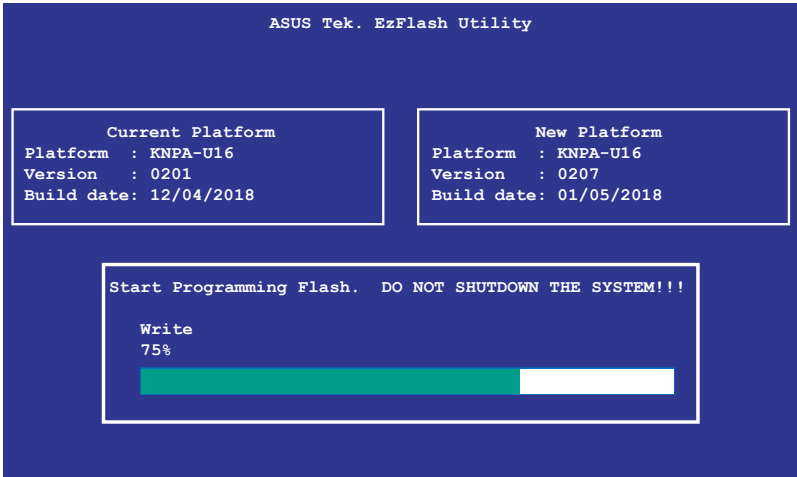

DO NOT shut down or reset the system while updating the BIOS to prevent system boot failure!

- The utility returns to the DOS prompt after the BIOS update process is completed. Reboot the system from the hard disk drive.

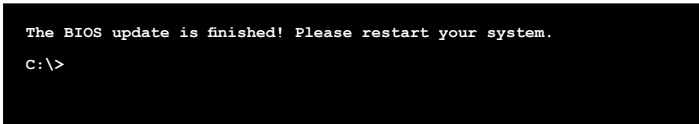

5.2 BIOS setup program

This motherboard supports a programmable firmware chip that you can update using the provided utility described in section **5.1 Managing and updating your BIOS**.

Use the BIOS Setup program when you are installing a motherboard, reconfiguring your system, or prompted to “Run Setup.” This section explains how to configure your system using this utility.

Even if you are not prompted to use the Setup program, you can change the configuration of your computer in the future. For example, you can enable the security password feature or change the power management settings. This requires you to reconfigure your system using the BIOS Setup program so that the computer can recognize these changes and record them in the CMOS RAM of the firmware chip.

The firmware chip on the motherboard stores the Setup utility. When you start up the computer, the system provides you with the opportunity to run this program. Press during the Power-On Self-Test (POST) to enter the Setup utility; otherwise, POST continues with its test routines.

If you wish to enter Setup after POST, restart the system by pressing <Ctrl>+<Alt>+<Delete>, or by pressing the reset button on the system chassis. You can also restart by turning the system off and then back on. Do this last option only if the first two failed.

The Setup program is designed to make it as easy to use as possible. Being a menu-driven program, it lets you scroll through the various sub-menus and make your selections from the available options using the navigation keys.



-
- The default BIOS settings for this motherboard apply for most conditions to ensure optimum performance. If the system becomes unstable after changing any BIOS settings, load the default settings to ensure system compatibility and stability. Press <F5> and select **Yes** to load the BIOS default settings.
 - The BIOS setup screens shown in this section are for reference purposes only, and may not exactly match what you see on your screen.
 - Visit the ASUS website (www.asus.com) to download the latest BIOS file for this motherboard.
-

5.2.1 BIOS menu screen

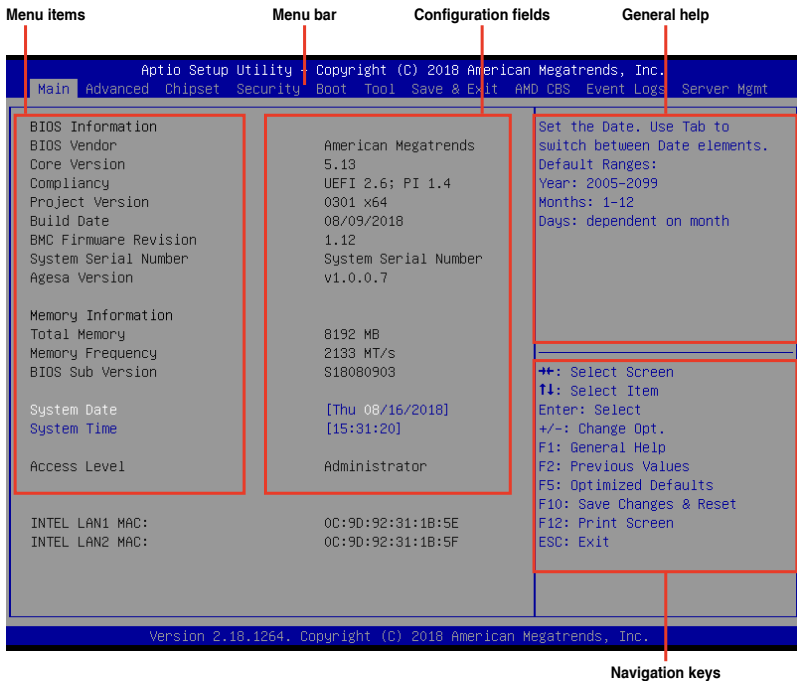

5.2.2 Menu bar

The menu bar on top of the screen has the following main items:

Main	For changing the basic system configuration
Advanced	For changing the advanced system settings
Chipset	For changing the chipset settings
Security	For changing the security settings
Boot	For changing the system boot configuration
Tool	For configuring options for special functions
Save & Exit	For selecting the exit options
AMD CBS	For configuring AMD CBS settings
Event Logs	For changing the event log settings
Server Mgmt	For changing the Server Mgmt settings

To select an item on the menu bar, press the right or left arrow key on the keyboard until the desired item is highlighted.

5.2.3 Menu items

The highlighted item on the menu bar displays the specific items for that menu. For example, selecting **Main** shows the Main menu items.

The other items (such as **Advanced**) on the menu bar have their respective menu items.

5.2.4 Submenu items

A solid triangle before each item on any menu screen means that the item has a submenu. To display the submenu, select the item then press <Enter>.

5.2.5 Navigation keys

At the bottom right corner of a menu screen are the navigation keys for the BIOS setup program. Use the navigation keys to select items in the menu and change the settings.

5.2.6 General help

At the top right corner of the menu screen is a brief description of the selected item.

5.2.7 Configuration fields

These fields show the values for the menu items. If an item is user-configurable, you can change the value of the field opposite the item. You cannot select an item that is not user-configurable.

A configurable field is enclosed in brackets, and is highlighted when selected. To change the value of a field, select it and press <Enter> to display a list of options.

5.2.8 Pop-up window

Select a menu item and press <Enter> to display a pop-up window with the configuration options for that item.

5.2.9 Scroll bar

A scroll bar appears on the right side of a menu screen when there are items that do not fit on the screen. Press the Up / Down arrow keys or <Page Up> / <Page Down> keys to display the other items on the screen.

5.3 Main menu

When you enter the BIOS Setup program, the Main menu screen appears. The Main menu provides you an overview of the basic system information, and allows you to set the system date, time, language, and security settings.

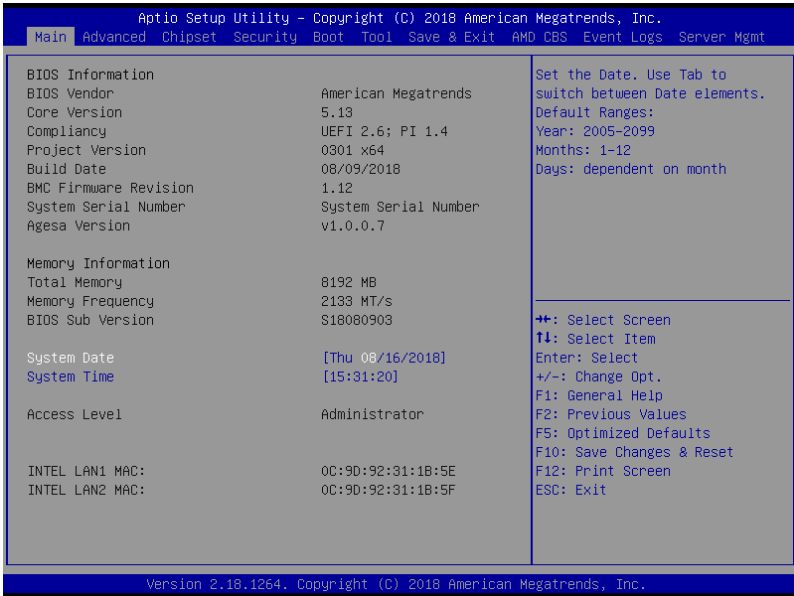

5.3.1 System Date [Day xx/xx/xxxx]

Allows you to set the system date.

5.3.2 System Time [xx:xx:xx]

Allows you to set the system time.

5.4 Advanced menu

The Advanced menu items allow you to change the settings for the CPU and other system devices.



Take caution when changing the settings of the Advanced menu items. Incorrect field values can cause the system to malfunction.

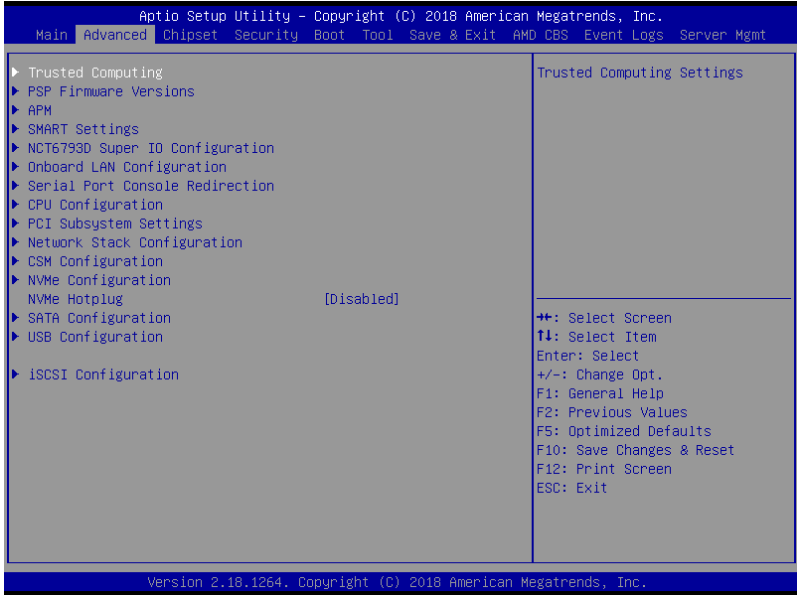

NVMe Hotplug [Disabled]

[Disabled] Disables NVMe Hotplug.

[Enabled] Enables NVMe Hotplug.

5.4.1 Trusted Computing

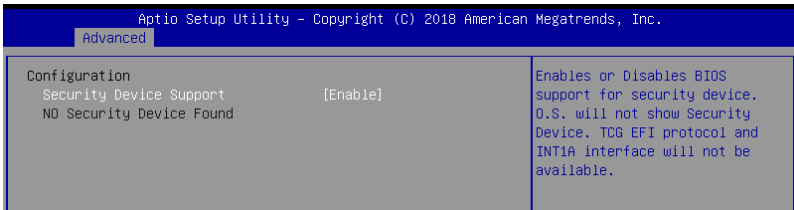

Configuration

Security Device Support [Enabled]

Allows you to enable or disable the BIOS support for security device.

Configuration options: [Disabled] [Enabled]

5.4.2 PSP Firmware Versions

This page displays the PSP firmware versions.

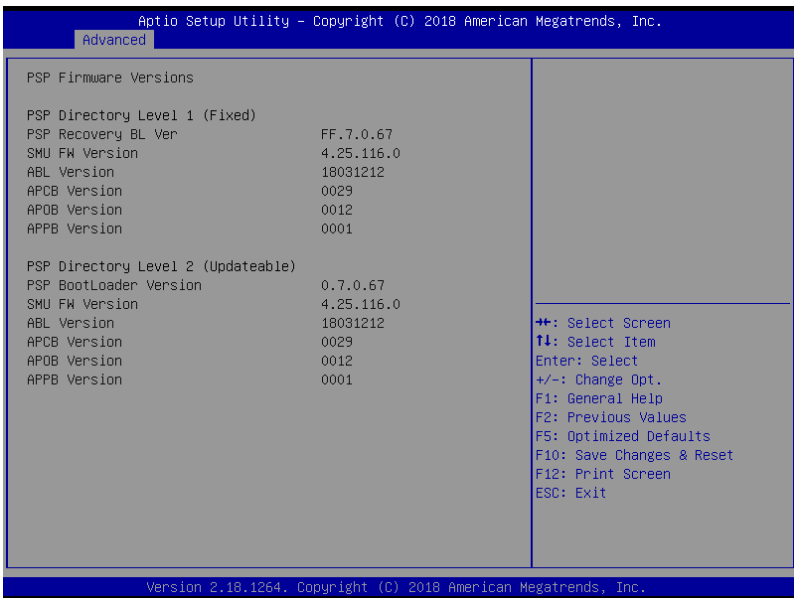

5.4.3 APM

Allows you to configure the Advance Power Management (APM) settings.

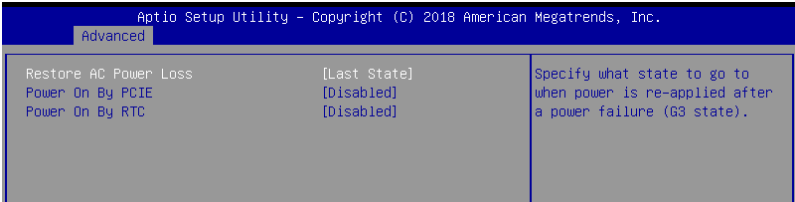

Restore AC Power Loss [Last State]

When set to [Power Off], the system goes into off state after an AC power loss. When set to [Power On], the system will reboot after an AC power loss. When set to [Last State], the system goes into either off or on state, whatever the system state was before the AC power loss.

Configuration options: [Power Off] [Power On] [Last State]

Power On By PCIE [Disabled]

[Disabled] Disables the PCIE devices to generate a wake event.

[Enabled] Enables the PCIE devices to generate a wake event.

Power On By RTC [Disabled]

[Disabled] Disables RTC to generate a wake event.

[Enabled] When set to [Enabled], the items **RTC Alarm Date (Days)** and **Hour/Minute/Second** will become user-configurable with set values.

5.4.4 Smart Settings

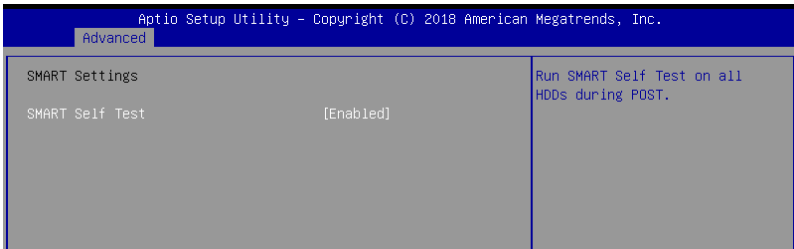

SMART Self Test [Enabled]

Allows you to run SMART Self Test on all HDDs during POST.

Configuration options: [Disabled] [Enabled]

5.4.5 NCT6793D Super IO Configuration

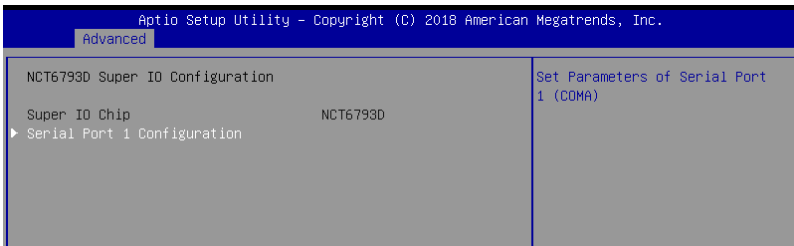

Serial Port 1 Configuration

Allows you to set the parameters of Serial Port 1.

Serial Port [Enabled]

Allows you to enable or disable Serial Port.

Configuration options: [Disabled] [Enabled]

5.4.6 Onboard LAN Configuration

Aprio Setup Utility - Copyright (C) 2018 American Megatrends, Inc.	
Advanced	
Onboard LAN Configuration	Intel LAN Enable/Disable
INTEL LAN1 MAC:	0C:9D:92:31:1B:5E
INTEL LAN2 MAC:	0C:9D:92:31:1B:5F
Intel LAN1 Enable	[Enabled]
Intel LAN1 ROM Type	[PXE]
Intel LAN2 Enable	[Enabled]
Intel LAN2 ROM Type	[Disabled]

Intel LAN1 Enable [Enabled]

Allows you to enable or disable the Intel LAN.

Configuration options: [Disabled] [Enabled]



The following items appear only when **Intel LAN1 Enable** is set to **[Enabled]**.

Intel LAN 1 ROM Type [PXE]

Allows you to select the Intel LAN ROM type.

Configuration options: [PXE] [iSCSI] [Disabled]

Intel LAN2 Enable [Enabled]

Allows you to enable or disable the Intel LAN.

Configuration options: [Disabled] [Enabled]



The following items appear only when **Intel LAN2 Enable** is set to **[Enabled]**.

Intel LAN 2 ROM Type [Disabled]

Allows you to select the Intel LAN ROM type.

Configuration options: [PXE] [iSCSI] [Disabled]

5.4.7 Serial Port Console Redirection

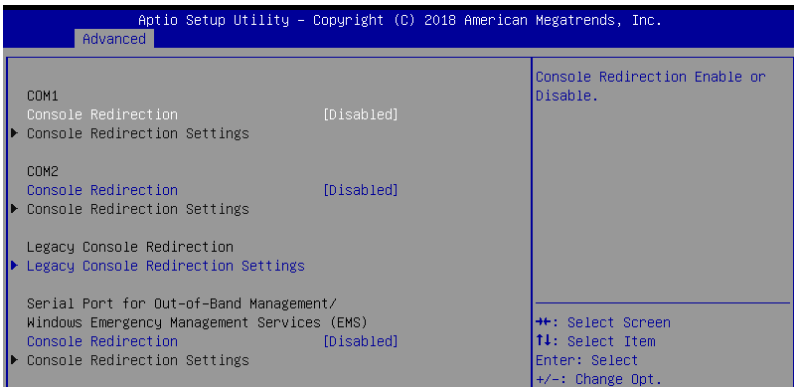

COM1/COM2

Console Redirection [Disabled]

Allows you to enable or disable the console redirection feature.

Configuration options: [Disabled] [Enabled]



The following item appears only when you set **Console Redirection** to [Enabled].

Console Redirection Settings

These items become configurable only when you enable the **Console Redirection** item. The settings specify how the host computer and the remote computer (which the user is using) will exchange data. Both computers should have the same or compatible settings.

Terminal Type [VT-UTF8]

Allows you to set the terminal type.

[VT100] ASCII char set.

[VT100+] Extends VT100 to support color, function keys, etc.

[VT-UTF8] Uses UTF8 encoding to map Unicode chars onto 1 or more bytes.

[ANSI] Extended ASCII char set.

Bits per second [57600]

Selects serial port transmission speed. The speed must be matched on the other side. Long or noisy lines may require lower speeds.

Configuration options: [9600] [19200] [38400] [57600] [115200]

Data Bits [8]

Configuration options: [7] [8]

Parity [None]

A parity bit can be sent with the data bits to detect some transmission errors. [Mark] and [Space] parity do not allow for error detection.

[None]	None
[Even]	parity bit is 0 if the num of 1's in the data bits is even
[Odd]	parity bit is 0 if num of 1's in the data bits is odd
[Mark]	parity bit is always 1
[Space]	parity bit is always 0

Stop Bits [1]

Stop bits indicate the end of a serial data packet. (A start bit indicates the beginning.) The standard setting is 1 stop bit. Communication with slow devices may require more than 1 stop bit.

Configuration options: [1] [2]

Flow Control [Hardware RTS/CTS]

Flow control can prevent data loss from buffer overflow. When sending data, if the receiving buffers are full, a "stop" signal can be sent to stop the data flow. Once the buffers are empty, a "start" signal can be sent to re-start the flow. Hardware flow control uses two wires to send start/stop signals.

Configuration options: [None] [Hardware RTS/CTS]

VT -UTF8 Combo Key Support [Enabled]

This allows you to enable the VT -UTF8 Combination Key Support for ANSI/VT100 terminals.

Configuration options: [Disabled] [Enabled]

Recorder Mode [Disabled]

With this mode enabled only text will be sent. This is to capture Terminal data.

Configuration options: [Disabled] [Enabled]

Putty Keypad [VT100]

This allows you to select the FunctionKey and Keypad on Putty.

Configuration options: [VT100] [LINUX] [XTERMR6] [SCO] [ESCN] [VT400]

Legacy Console Redirection Settings**Legacy Console Redirection Port [COM1]**

Allows you to select a COM port to display redirection of Legacy OS and Legacy OPROM Messages.

Configuration options: [COM1] [COM2]

Serial Port for Out-of-Band Management/ Windows Emergency Management Services (EMS)

Console Redirection [Disabled]

Allows you to enable or disable the console redirection feature.

Configuration options: [Disabled] [Enabled]



The following item appears only when you set **Console Redirection** to [Enabled].

Console Redirection Settings

Out-of-Band Mgmt Port [COM1]

Microsoft Windows Emergency Management Services (EMS) allow for remote management of a Windows Server OS through a serial port.

Configuration options: [COM1] [COM2]

Terminal Type [VT-UTF8]

Microsoft Windows Emergency Management Services (EMS) allow for remote management of a Windows Server OS through a serial port.

Configuration options: [VT100] [VT100+] [VT-UTF8] [ANSI]

Bits per second [115200]

Microsoft Windows Emergency Management Services (EMS) allow for remote management of a Windows Server OS through a serial port.

Configuration options: [9600] [19200] [57600] [115200]

Flow Control [None]

Microsoft Windows Emergency Management Services (EMS) allow for remote management of a Windows Server OS through a serial port.

Configuration options: [None] [Hardware RTS/CTS] [Software Xon/Xoff]

5.4.8 CPU Configuration

This page displays the CPU node information.

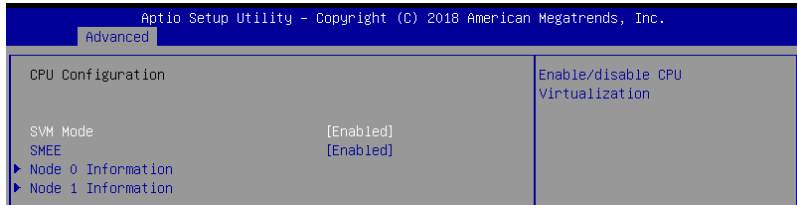

SVM Mode [Enabled]

Allows you to enable or disable SVM Mode.

Configuration options: [Disabled] [Enabled]

SMEE [Enabled]

Allows you to enable or disable SMEE.

Configuration options: [Disabled] [Enabled]

5.4.9 PCI Subsystem Settings

Allows you to configure PCI, PCI-X, and PCI Express Settings.

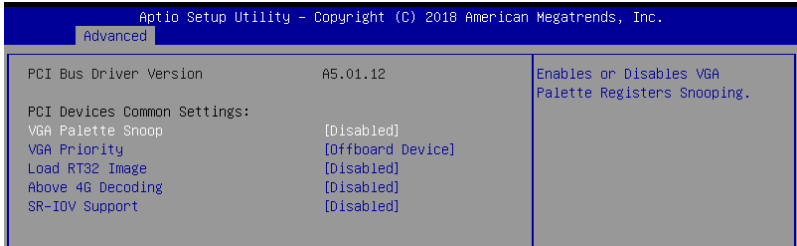

The screenshot shows the 'Advanced' tab of the Aptio Setup Utility. The title bar reads 'Aptio Setup Utility - Copyright (C) 2018 American Megatrends, Inc.'. The 'Advanced' tab is selected. The main content area is divided into three columns. The first column lists settings, the second shows their current values, and the third provides descriptions. The settings listed are: PCI Bus Driver Version (A5.01.12), PCI Devices Common Settings (header), VGA Palette Snoop ([Disabled]), VGA Priority ([Offboard Device]), Load RT32 Image ([Disabled]), Above 4G Decoding ([Disabled]), and SR-IOV Support ([Disabled]).

Aptio Setup Utility - Copyright (C) 2018 American Megatrends, Inc.		
Advanced		
PCI Bus Driver Version	A5.01.12	Enables or Disables VGA Palette Registers Snooping.
PCI Devices Common Settings:		
VGA Palette Snoop	[Disabled]	
VGA Priority	[Offboard Device]	
Load RT32 Image	[Disabled]	
Above 4G Decoding	[Disabled]	
SR-IOV Support	[Disabled]	

VGA Palette Snoop [Disabled]

This option enables or disables VGA Palette Registers Snooping.

Configuration options: [Disabled] [Enabled]

VGA Priority [Offboard Device]

This option allows you to select the priority of the VGA.

Configuration options: [Offboard Device] [Onboard Device]

Load RT32 Image [Disabled]

This option enables or disables RT32 Image Loading.

Configuration options: [Disabled] [Enabled]

Above 4G Decoding [Disabled]

Allows you to enable or disable 64-bit capable devices to be decoded in above 4G address space. It only works if the system supports 64-bit PCI decoding.

Configuration options: [Disabled] [Enabled]

SR-IOV Support [Disabled]

This option enables or disables Single Root IO Virtualization Support if the system has SR-IOV capable PCIe devices.

Configuration options: [Disabled] [Enabled]

5.4.10 Network Stack Configuration

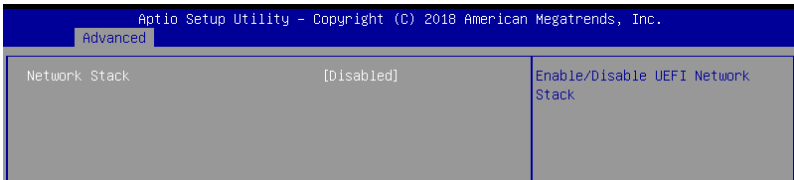

Network stack [Disabled]

Enables or disables the network stack feature.

Configuration options: [Disable] [Enable]



The following item appears only when **Network stack** is set to **[Enabled]**.

Ipv4 PXE Support [Disabled]

Enables or disables the Ipv4 PXE Boot Support. If disabled, Ipv4 PXE boot option will not be created.

Configuration options: [Disabled] [Enabled]

Ipv4 HTTP Support [Disabled]

Enables or disables the Ipv4 HTTP Boot Support. If disabled, Ipv4 HTTP boot option will not be created.

Configuration options: [Disabled] [Enabled]

Ipv6 PXE Support [Disabled]

Enables or disables the Ipv6 PXE Boot Support. If disabled, Ipv6 PXE boot option will not be created.

Configuration options: [Disabled] [Enabled]

Ipv6 HTTP Support [Disabled]

Enables or disables the Ipv6 HTTP Boot Support. If disabled, Ipv6 HTTP boot option will not be created.

Configuration options: [Disabled] [Enabled]

IP6 Configuration Policy [Automatic]

This item allows you to set the IP6 Configuration policy.

Configuration options: [Automatic] [Manual]

PXE boot wait time [0]

Wait time to press ESC key to abort the PXE boot.

Media detect time [1]

Wait time (in seconds) to detect media.

5.4.11 CSM Configuration

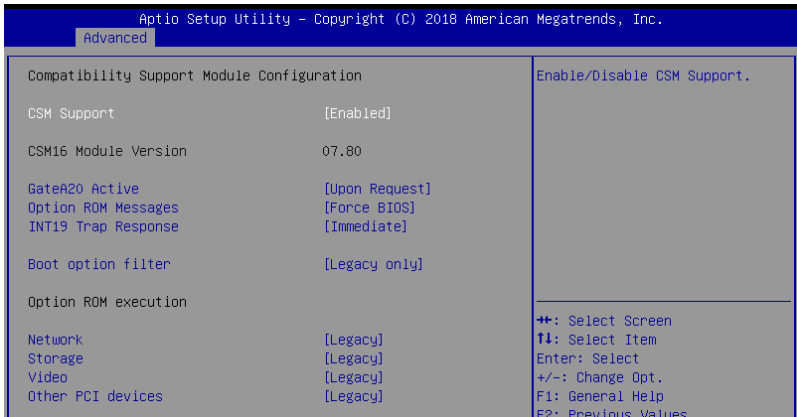

CSM Support [Enabled]

This option allows you to enable or disable CSM Support.
Configuration options: [Disabled] [Enabled]



The following item appears only when **CSM Support** is set to **[Enabled]**.

GateA20 Active [Upon Request]

This allows you to set the GA20 option.
Configuration options: [Upon Request] [Always]

Option ROM Messages [Force BIOS]

This allows you to set the display mode for option ROM.
Configuration options: [Force BIOS] [Keep Current]

INT19 Trap Response [Immediate]

[Immediate] Execute the trap right away.
[Postponed] Execute the trap during legacy boot.

Boot Option filter [Legacy only]

This option allows you to control the Legacy/UEFI ROMs priority.
Configuration options: [UEFI and Legacy] [Legacy only] [UEFI only]

Network / Storage / Video [Legacy]

This option allows you to control the execution of UEFI and Legacy PXE / Storage / Video OpROM.
Configuration options: [UEFI] [Legacy]

Other PCI devices [Legacy]

This item determines the OpROM execution policy for devices other than Network, Storage, or Video.
Configuration options: [UEFI] [Legacy]

5.4.12 NVMe Configuration

This page will display the NVMe controller and drive information.

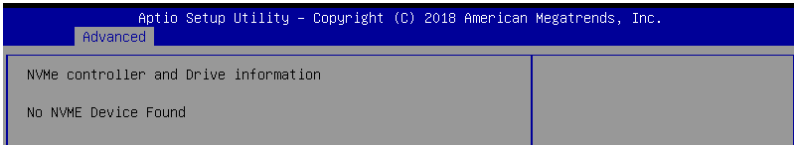

5.4.13 SATA Configuration

This page will display the SATA controller and drive information.

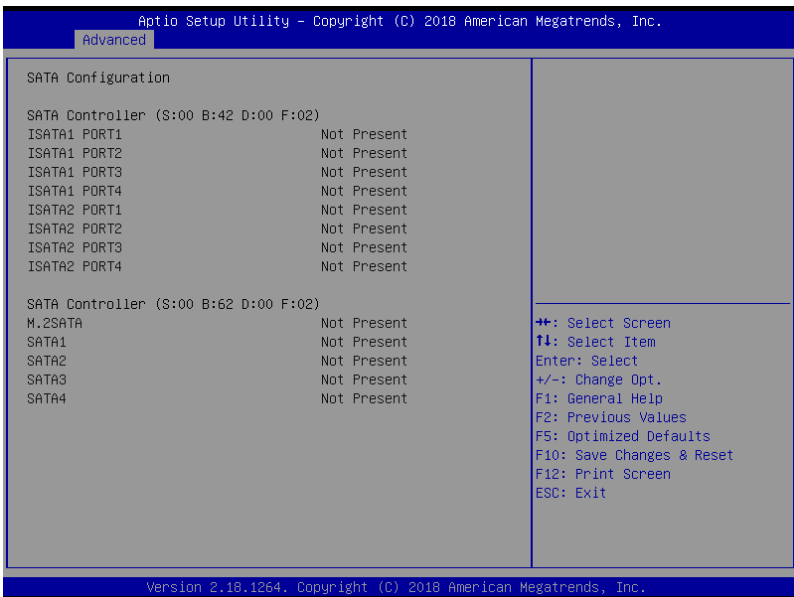

5.4.14 USB Configuration

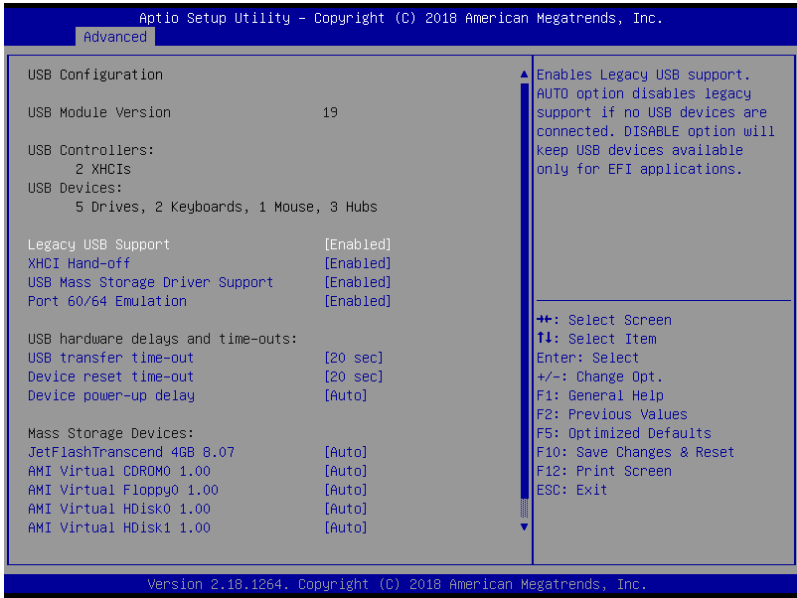

Legacy USB Support [Enabled]

Allows you to enable or disable Legacy USB device support.
Configuration options: [Enabled] [Disabled] [Auto]

XHCI Hand-off [Enabled]

Allows you to enable or disable workaround for OSes without XHCI hand-off support. The XHCI ownership change should be claimed by XHCI driver.
Configuration options: [Enabled] [Disabled]

USB Mass Storage Driver Support [Enabled]

Allows you to enable or disable the USB Mass Storage driver support.
Configuration options: [Disabled] [Enabled]

Port 60/64 Emulation [Enabled]

Allows you to enable or disable I/O port 60h/64h emulation support. This should be enabled for the complete keyboard legacy support for non-USB aware OSes.
Configuration options: [Disabled] [Enabled]

USB hardware delays and time-outs

USB transfer time-out [20 sec]

Allows you to select time-out value for Control, Bulk, and Interrupt transfers.

Configuration options: [1 sec] [5 sec] [10 sec] [20 sec]

Device reset time-out [20 sec]

Allows you to select time-out value for USB mass storage device Start Unit command.

Configuration options: [10 sec] [20 sec] [30 sec] [40 sec]

Device power-up delay [Auto]

Allows you to select maximum time the device will take before it properly reports itself to the Host Controller.

Configuration options: [Auto] [Manual]

Mass Storage Devices

AMI Virtual CDROM0-2 / Floppy / HDisk0 1.00 [Auto]

Allows you to select the mass storage device emulation type.

Configuration options: [Auto] [Floppy] [Forced FDD] [Hard Disk] [CD-ROM]

5.4.15 iSCSI Configuration

Allows you to configure the iSCSi parameters.

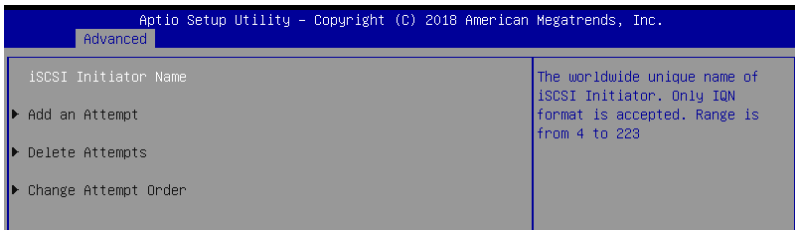

5.5 Chipset menu

The Chipset menu items allow you to change the Chipset settings.

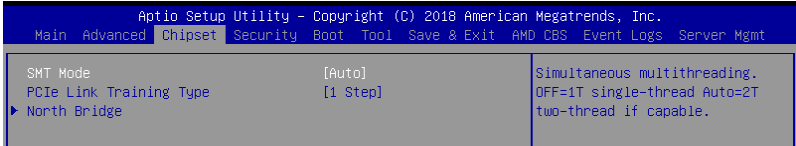

SMT Mode [Auto]

Allows you to select the simultaneous multithreading mode.

Configuration options: [Auto] [Off]

PCIe Link Training Type [1 Step]

Allows you to select the PCIe training in 1 or 2 steps.

Configuration options: [1 Step] [2 Step]

North Bridge

Memory Configuration

Memory Clock [Auto]

This option allows you to select different memory clock values.

Configuration options: [Auto] [1333MHz] [1600MHz] [1866MHz] [2133MHz] [2400MHz]

Socket 0 Information

This item displays the memory information on Socket 0.

Socket 1 Information

This item displays the memory information on Socket 1.

5.6 Security menu

This menu allows a new password to be created or a current password to be changed. The menu also enables or disables the Secure Boot state and lets the user configure the System Mode state.

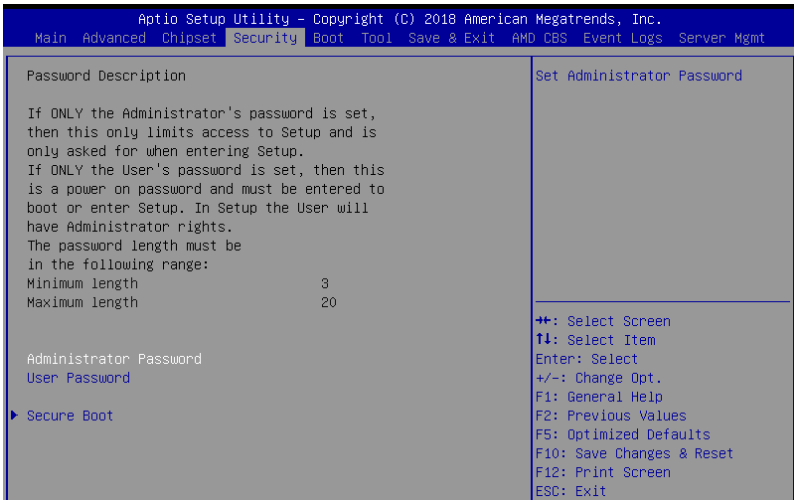

Administrator Password

To set an administrator password:

1. Select the Administrator Password item and press <Enter>.
2. From the Create New Password box, key in a password, then press <Enter>.
3. Confirm the password when prompted.

To change an administrator password:

1. Select the Administrator Password item and press <Enter>.
2. From the Enter Current Password box, key in the current password, then press <Enter>.
3. From the Create New Password box, key in a new password, then press <Enter>.
4. Confirm the password when prompted.



To clear the administrator password, follow the same steps as in changing an administrator password, but press <Enter> when prompted to create/confirm the password.

User Password

To set a user password:

1. Select the User Password item and press <Enter>.
2. From the Create New Password box, key in a password, then press <Enter>.
3. Confirm the password when prompted.

To change a user password:

1. Select the User Password item and press <Enter>.
2. From the Enter Current Password box, key in the current password, then press <Enter>.
3. From the Create New Password box, key in a new password, then press <Enter>.
4. Confirm the password when prompted.

To clear a user password:

1. Select the Clear User Password item and press <Enter>.
2. Select **Yes** from the Warning message window then press <Enter>.

Secure Boot

This item allows you to customize the Secure Boot settings.

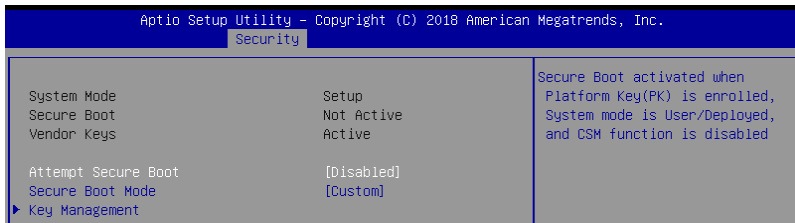

Attempt Secure Boot [Disabled]

Secure Boot can be enabled if the system is running in User mode with enrolled platform Key (EPK) or if the CSM function is disabled.

Configuration options: [Disabled] [Enabled]

Secure Boot Mode [Custom]

Allows you to set the Secure Boot selector.

Configuration options: [Custom] [Standard]

Key Management

This item only appears when the item Secure Boot Mode is set to [Custom]. The Key Management item allows you to modify Secure Boot variables and set Key Management page.

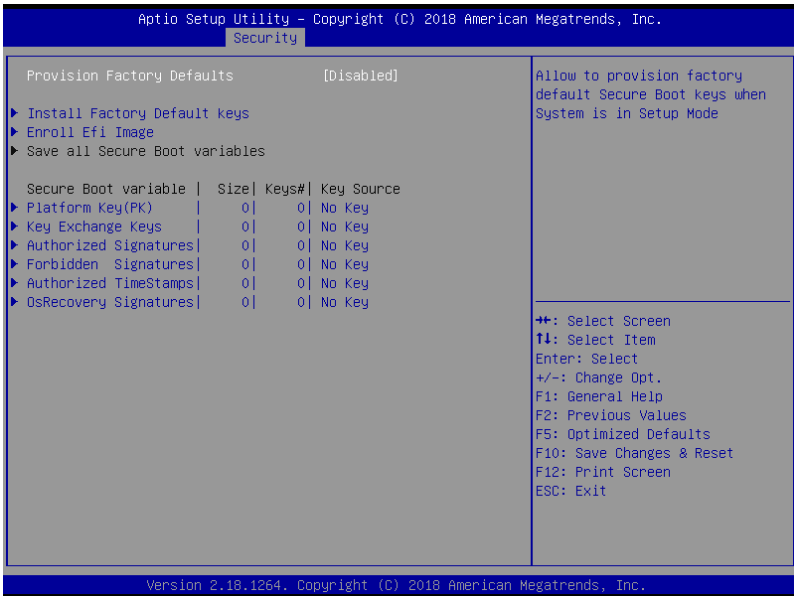

Provision Factory Defaults [Disabled]

Allows you to provision factory default Secure Boot keys when the system is in Setup Mode.

Configuration options: [Disabled] [Enabled]

Install Factory Default keys

This item will install all Factory Default keys.

Enroll Efi Image

This item will allow the image to run in Secure Boot mode.

Save All Secure Boot Variables

This item will ask you if you want to save all secure boot variables. Select Yes if you want to save all secure boot variables, otherwise select No.

Platform Key (PK) / Key Exchange Key (KEK) / Authorized Signatures (DB) / Forbidden Signatures (DBX) / Authorized TimeStamps (DBT) / OsRecovery Signatures

Configuration options: [Erase] [Set New] [Save to File]

5.7 Boot menu

The Boot menu items allow you to change the system boot options.

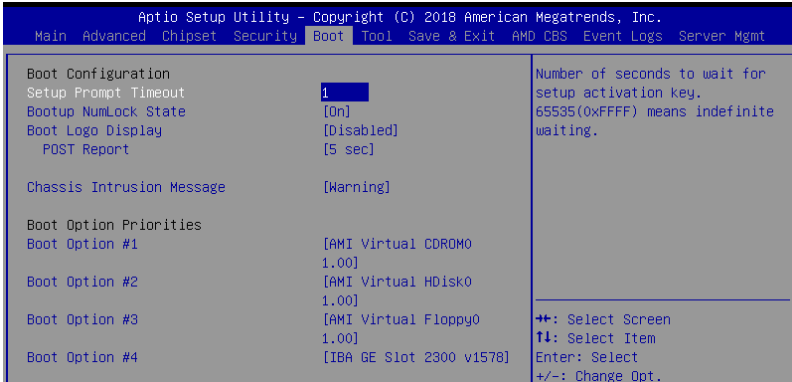

Setup Prompt Timeout [1]

Allows you to set the number of seconds to wait for setup activation key.

Bootup NumLock State [On]

Allows you to select the power-on state for the NumLock.

Configuration options: [Off] [On]

Boot Logo Display [Disabled]

Allows you to enable or disable the full screen logo display feature.

Configuration options: [Auto] [Full Screen] [Disabled]

POST Report [5 sec]

Allows you to set the desired POST Report waiting time from 1 to 10 seconds.

Configuration options: [1 sec] ~ [10 sec] [Until Press ESC]

Chassis Intrusion Message [Warning]

Allows you to select the action to perform when chassis intrusion has occurred.

Configuration options: [Warning] [Halt]

Boot Option Priorities

These items specify the boot device priority sequence from the available devices. The number of device items that appears on the screen depends on the number of devices installed in the system.



- To select the boot device during system startup, press <F8> when ASUS Logo appears.
- To access Windows OS in Safe Mode, please press <F8> after POST.

Floppy Drive BBS Priorities / Hard Drive BBS Priorities / CD/DVD ROM Drive BBS Priorities

These items appear only when you connect Floppy / SATA ODD or HDD to the SATA ports and allow you to set the booting order of the SATA devices.

5.8 Tool menu

The Tool menu items allow you to configure options for special functions. Select an item then press <Enter> to display the submenu.

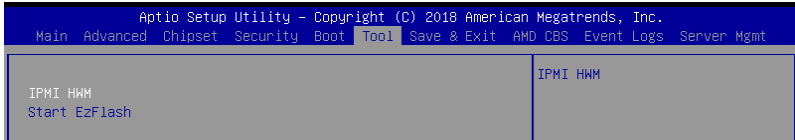

IPMI HWM

Allows you to run the IPMI hardware monitor.

Start EZ Flash

Allows you to run ASUS EZ Flash BIOS ROM Utility when you press <Enter>. Refer to the ASUS EZ Flash Utility section for details.

5.9 Save & Exit menu

The Exit menu items allow you to save or discard your changes to the BIOS items.

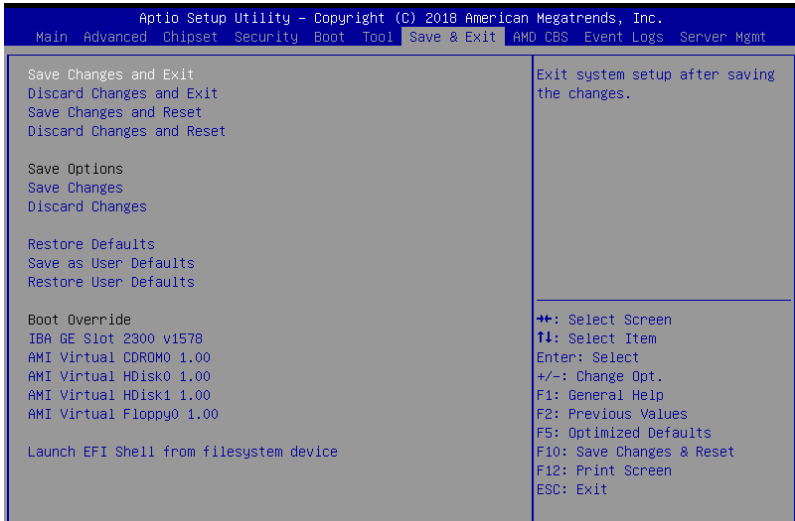



Pressing <Esc> does not immediately exit this menu. Select one of the options from this menu or <F10> from the legend bar to exit.

Save Changes and Exit

Exit system setup after saving the changes.

Discard Changes and Exit

Exit system setup without saving any changes.

Save Changes and Reset

Rest system setup after saving the changes.

Discard Changes and Rest

Rest system setup without saving any changes.

Save Changes

Save changes done so far to any of the setup options.

Discard Changes

Discard changes done so far to any of the setup options.

Restore Defaults

Restore/load default values for all the setup options.

Save as User Defaults

Save all the current setup options as user default values.

Restore as User Defaults

Restore/load user default values for all the setup options.

Boot Override

These items displays the available devices. The device items that appears on the screen depends on the number of devices installed in the system. Click an item to start booting from the selected device.

5.10 AMD CBS menu

The Exit menu items allow you to save or discard your changes to the BIOS items.

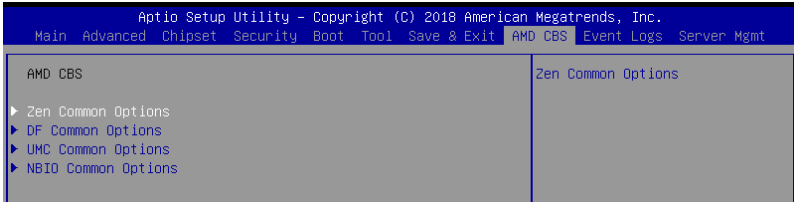

5.10.1 Zen Common Options

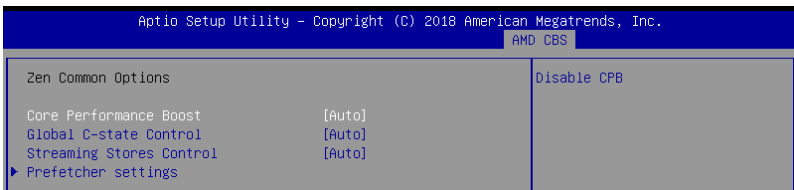

Core Performance Boost [Auto]

This option allows you to enable or disable CPB.

Configuration options: [Disabled] [Auto]

Global C-state Control [Auto]

This option allows you to control IO based C-state generation and DF c-states.

Configuration options: [Disabled] [Enabled] [Auto]

Streaming Stores Control [Auto]

This option allows you to enable or disable the streaming stores functionality.

Configuration options: [Disabled] [Enabled] [Auto]

Prefetcher settings

L1 Stream HW Prefetcher [Auto]

This option allows you to enable or disable L1 Stream HW Prefetcher.

Configuration options: [Disabled] [Enabled] [Auto]

L2 Stream HW Prefetcher [Auto]

This option allows you to enable or disable L2 Stream HW Prefetcher.

Configuration options: [Disabled] [Enabled] [Auto]

5.10.2 DF Common Options

Aptio Setup Utility - Copyright (C) 2018 American Megatrends, Inc.	
AMD CBS	
DF Common Options	Controls fabric level memory interleaving (AUTO, none, channel, die, socket). Note that channel, die, and socket has requirements on memory populations and it will be
Memory interleaving [Auto]	
Memory interleaving size [Auto]	

Memory interleaving [Auto]

This option allows you to control fabric level memory interleaving.

Configuration options: [None] [Channel] [Die] [Socket] [Auto]

Memory interleaving size [Auto]

This option allows you to control the memory interleaving size.

Configuration options: [256 Bytes] [512 Bytes] [1 KB] [2 KB] [Auto]

5.10.3 UMC Common Option

Aptio Setup Utility - Copyright (C) 2018 American Megatrends, Inc.	
AMD CBS	
UMC Common Options	DDR4 Common Options
▶ DDR4 Common Options	
▶ DRAM Memory Mapping	

DDR4 Common Options

DRAM Timing Configuration

This option allows you to set memory overclock settings. Read the disclaimer and select **I Accept** to continue.

DRAM Controller Configuration

Power Down Options

Power Down Enable [Auto]

This option allows you to enable or disable DDR power down mode.

Configuration options: [Disabled] [Enabled] [Auto]

Cmd2T [Auto]

This option allows you to select between 1T and 2T mode on ADDR/CMD.

Configuration options: [1T] [2T] [Auto]

Gear Down Mode [Auto]

This option allows you to select the Gear Down Mode.

Configuration options: [Disabled] [Enabled] [Auto]

Data Bus Configuration

Data Bus Configuration User Controls [Auto]

This option allows you to interleave memory blocks across DRAM chip selects for node 0.

Configuration options: [Auto] [Manual]



The following item appears only when **Data Bus Configuration User Controls** is set to **[Manual]**.

RttNom [Auto]

Configuration options: [Rtt_Nom Disable] [RZQ/4] [RZQ/2] [RZQ/6] [RZQ/1] [RZQ/5] [RZQ/3] [RZQ/7] [Auto]

RttWr [Auto]

Configuration options: [Dynamic ODT Off] [RZQ/2] [RZQ/1] [Hi-Z] [RZQ/3] [Auto]

RttPark [Auto]

Configuration options: [Rtt_PARK Disable] [RZQ/4] [RZQ/2] [RZQ/6] [RZQ/1] [RZQ/5] [RZQ/3] [RZQ/7] [Auto]

Common RAS

Data Poisoning [Auto]

This option allows you to enable or disable Data Poisoning.

Configuration options: [Disabled] [Enabled] [Auto]

ECC Configuration

DRAM ECC Symbol Size [Auto]

This option allows you to set the DRAM ECC Symbol Size.

Configuration options: [Auto] [x4] [x8]

DRAM ECC Enable [Auto]

This option allows you to enable or disable DRAM ECC.

Configuration options: [Disabled] [Enabled] [Auto]

DRAM Memory Mapping

Chipselect Interleaving [Auto]

This option allows you to interleave memory blocks across DRAM chip selects for node 0.

Configuration options: [Disabled] [Auto]

BankGroupSwap [Auto]

This option allows you to enable or disable BankGroupSwap.

Configuration options: [Disabled] [Enabled] [Auto]

5.10.4 NBIO Common Options

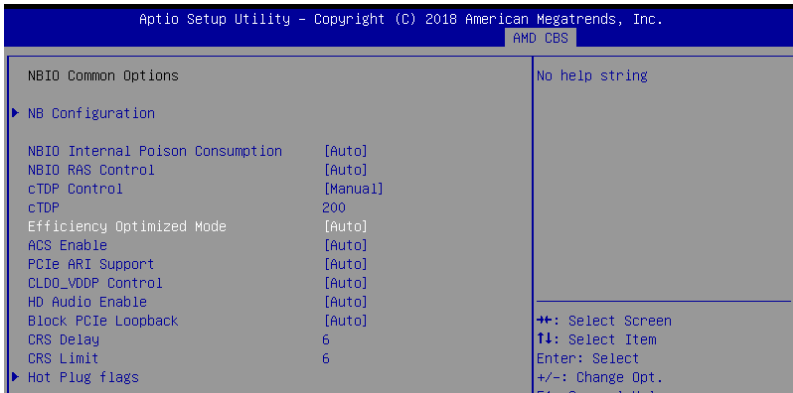

NB Configuration

IOMMU [Enabled]

This option allows you to enable or disable IOMMU.

Configuration options: [Disabled] [Enabled] [Auto]

Concurrent Training [Auto]

This option allows you to enable or disable Concurrent Training.

Configuration options: [False] [True] [Auto]

NBIO Internal Poison Consumption [Auto]

This option allows you to enable or disable NBIO Internal Poison Consumption.

Configuration options: [Disabled] [Enabled] [Auto]

NBIO RAS Control [Auto]

This option allows you to enable or disable NBIO RAS Control.

Configuration options: [Disabled] [Enabled] [Auto]

cTDP Control [Manual]

This option allows you to set the cTDP.

Configuration options: [Manual] [Auto]



The following item appears only when **cTDP Control** is set to **[Manual]**.

cTDP [200]

This option allows you to set the cTDP value.

Efficiency Optimized Mode [Auto]

This option allows you to enable or disable Efficiency Optimized Mode.

Configuration options: [Disabled] [Enabled] [Auto]

ACS Enable [Auto]

This option allows you to enable or disable ACS.

Configuration options: [Disabled] [Enabled] [Auto]

PCIe ARI Support [Auto]

This option allows you to enable or disable PCIe ARI Support.
Configuration options: [Disabled] [Enabled] [Auto]

CLDO_VDDP Control [Auto]

This option allows you to set the CLDO_VDDP.
Configuration options: [Manual] [Auto]



The following item appears only when **CLDO_VDDP Control** is set to **[Manual]**.

CLDO_VDDP voltage [0]

This option allows you to set the CLDO_VDDP voltage.

HD Audio Enable [Auto]

This option allows you to enable or disable HD Audio.
Configuration options: [Disabled] [Enabled] [Auto]

Block PCIe Loopback [Auto]

This option allows you to enable or disable Block PCIe Loopback mode for hot plug slots.
Configuration options: [Disabled] [Enabled] [Auto]

CRS Delay [6]

This option allows you to set the CRS Delay.

CRS Limit [6]

This option allows you to set the CRS Limit.

Hot Plug flags

Ignore sideband [Disabled]

This option allows you to enable or disable sideband.
Configuration options: [Disabled] [Enabled] [Auto]

Disable L1 w/a [Disabled]

This option allows you to enable or disable L1 w/a.
Configuration options: [Disabled] [Enabled] [Auto]

Disable BridgeDis [Disabled]

This option allows you to enable or disable BridgeDis update based on sideband.
Configuration options: [Disabled] [Enabled] [Auto]

Disable irq polling [Disabled]

This option allows you to enable or disable irq polling.
Configuration options: [Disabled] [Enabled] [Auto]

IRQ sets BridgeDis [Disabled]

This option allows you to enable or disable IRQ sets BridgeDis.
Configuration options: [Disabled] [Enabled] [Auto]

5.11 Event Logs menu

The Event Logs menu items allow you to change the event log settings and view the system event logs.

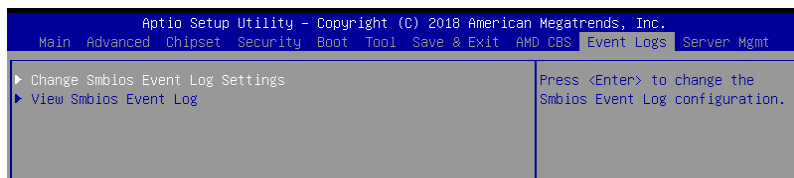

5.11.1 Change Smbios Event Log Settings

Press <Enter> to change the Smbios Event Log configuration.



All values changed here do not take effect until computer is restarted.

Enabling/Disabling Options

Smbios Event Log [Enabled]

Change this to enable or disable all features of Smbios Event Logging during boot.
Configuration options: [Disabled] [Enabled]

Erasing Settings

Erase Event Log [No]

Choose options for erasing Smbios Event Log. Erasing is done prior to any logging activation during reset.
Configuration options: [No] [Yes, Next reset] [Yes, Every reset]

When Log is Full [Do Nothing]

Choose options for reacting to a full Smbios Event Log.
Configuration options: [Do Nothing] [Erase Immediately]

Smbios Event Log Standard Settings

Log System Boot Event [Disabled]

This option allows you to enable or disable logging System boot event.
Configuration options: [Disabled] [Enabled]

5.11.2 View Smbios Event Log

Press <Enter> to view all smbios event logs.

5.12 Server Mgmt menu

The Server Management menu displays the server management status and allows you to change the settings.

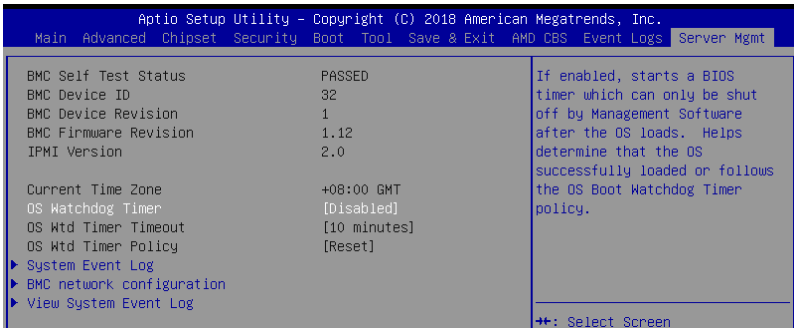

OS Watchdog Timer [Disabled]

This item allows you to start a BIOS timer which can only be shut off by Intel Management Software after the OS loads.

Configuration options: [Disabled] [Enabled]



The following items is configurable only when the **OS Watchdog Timer** is set to **[Enabled]**.

OS Wtd Timer Timeout [10 minutes]

Allows you to configure the length for the OS Boot Watchdog Timer.

Configuration options: [5 minutes] [10 minutes] [15 minutes] [20 minutes]

OS Wtd Timer Policy [Reset]

This item allows you to configure the how the system should respond if the OS Boot Watch Timer expires.

Configuration options: [Do Nothing] [Reset] [Power Down]

System Event Log

Allows you to change the SEL event log configuration.

SEL Components [Enabled]

This option allows you to enable or disable SEL Components.

Configuration options: [Disabled] [Enabled]



The following items is configurable only when the **SEL Components** is set to **[Enabled]**.

Erase SEL [No]

Allows you to choose options for erasing SEL.

Configuration options: [No] [Yes, On next reset] [Yes, On every reset]

When SEL is Full [Do Nothing]

Allows you to choose options for reactions to a full SEL.

Configuration options: [Do Nothing] [Erase Immediately]

BMC network configuration

The sub-items in this configuration allow you to configure the BMC network parameters.

View System Event Log

This item allows you to view the system event log records.

Driver Installation

6

This chapter provides the instructions for installing the necessary drivers for different system components in the Windows® Operating System.

6.1 Management applications and utilities installation

The support DVD that is bundled with your motherboard contains drivers, management applications, and utilities that you can install to maximize the features of your motherboard.



-
1. The contents of the support DVD are subject to change at any time without notice. Visit the ASUS website (www.asus.com) for the latest updates on software and utilities.
 2. The support DVD is supported on Windows® Server 2012 R2 and Windows® Server 2016.
-

6.2 Running the Support DVD

When you place the support DVD into the optical drive, the DVD automatically displays the main screen if Autorun is enabled in your computer. By default, the Drivers tab is displayed.



If Autorun is NOT enabled in your computer, browse the contents of the support DVD to locate the file **ASSETUP.EXE** from the **BIN** folder. Double-click the **ASSETUP.EXE** to run the support DVD.

The main screen of the Support DVD contains the following tabs:

1. Drivers
2. Utilities
3. Manual
4. Contact



The main screen of the Support DVD looks exactly the same on the Windows® Server 2012 R2 and on the Windows® Server 2016 Operating System (OS).

6.2.1 Drivers menu tab

The Drivers Menu shows the available device drivers if the system detects installed devices. Install the necessary drivers to activate the devices.



6.2.2 Utilities menu tab

The Utilities menu displays the software applications and utilities that the motherboard supports.



6.2.3 Manual menu

The Manual menu provides the link to the Broadcom NetXtreme II Network Adapter user guide



You need an internet browser installed in your OS to view the User Guide.



6.2.4 Contact information menu

The Contact menu displays the ASUS contact information, e-mail addresses, and useful links if you need more information or technical support for your motherboard.

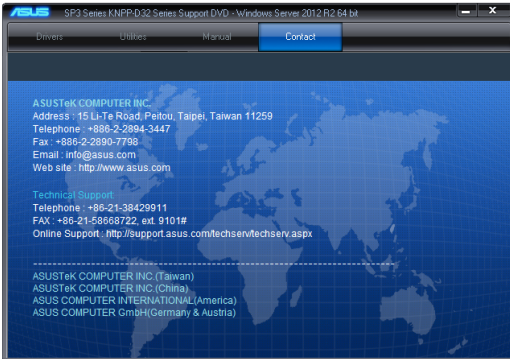

6.3 AMD chipset device software installation

This section provides the instructions on how to install the AMD chipset device software on the system.

You need to manually install the AMD chipset device software on a Windows operating system.

To install the AMD chipset device software:

1. Restart the computer, and then log on with **Administrator** privileges.
2. Insert the motherboard/system support DVD into the optical drive. The support DVD automatically displays the **Drivers** menu if Autorun is enabled in your computer.



If Autorun is NOT enabled in your computer, browse the contents of the support DVD to locate the file **ASSETUP.EXE** from the **BIN** folder. Double-click the **ASSETUP.EXE** to run the support DVD.

3. Click the item **AMD Software** from the menu.

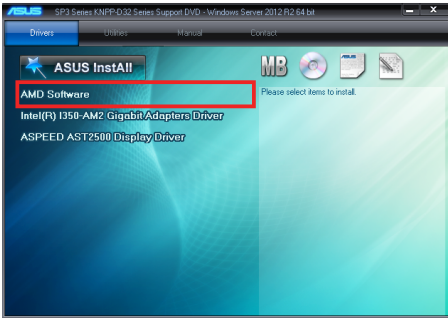

4. The **AMD Software** window appears. Click **Accept and Install** to start the installation, and follow the onscreen instructions to complete the setup process.

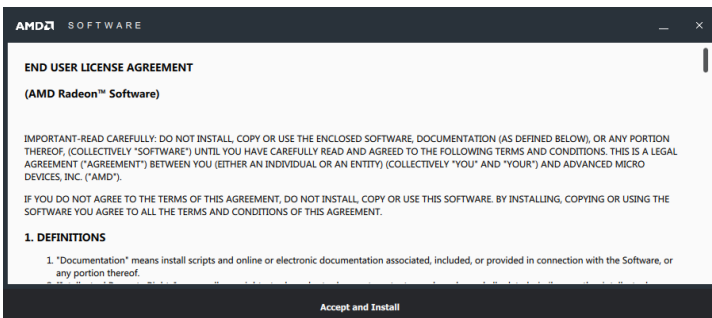

6.4 Installing the Intel® I350-AM2 Gigabit Adapters driver

This section provides the instructions on how to install the **Intel® I350-AM2 Gigabits Adapter Driver** on the system.

To install the **Intel® I350-AM2 Gigabit Adapters Driver** on the Windows® operating system:

1. Restart the computer.
2. Log on with **Administrator** privileges.
3. Insert the motherboard/system support DVD to the optical drive.



If Autorun is NOT enabled in your computer, browse the contents of the support DVD to locate the file **ASSETUP.EXE** from the **BIN** folder. Double-click the **ASSETUP.EXE** to run the support DVD.

4. Click **Intel® I350-AM2 Gigabit Adapters Drivers** in the **Drivers** menu of the main screen to start the installation.



5. Click **Install Drivers and Software** option to begin installation.

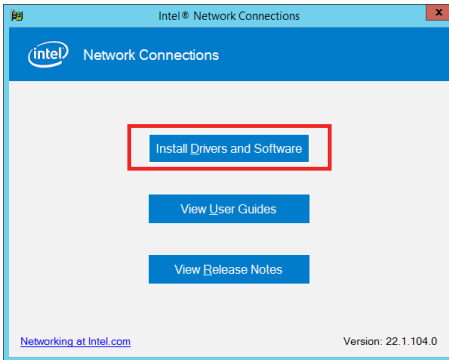

6. Click **Install** to start the installation.

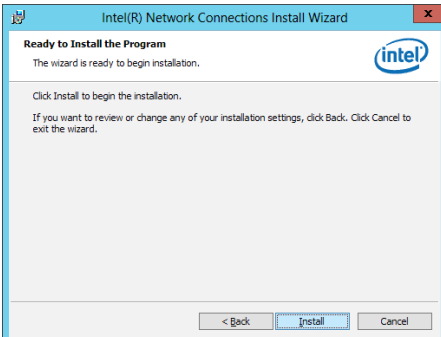

7. When the installation is done, press **Finish** to complete the installation.

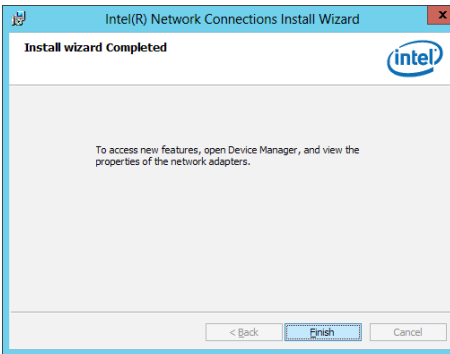

6.5 VGA driver installation

This section provides the instructions on how to install the ASPEED Video Graphics Adapter (VGA) driver.

You need to manually install the ASPEED VGA driver on a Windows® operating system.

To install the ASPEED VGA driver:

1. Restart the computer, and then log on with **Administrator** privileges.
2. Insert the motherboard/system support DVD into the optical drive. The support DVD automatically displays the **Drivers** menu if Autorun is enabled in your computer.



If Autorun is NOT enabled in your computer, browse the contents of the support DVD to locate the file **ASSETUP.EXE** from the **BIN** folder. Double-click the **ASSETUP.EXE** to run the support DVD.

3. Click the **ASPEED AST2500 Display Driver** to begin installation.

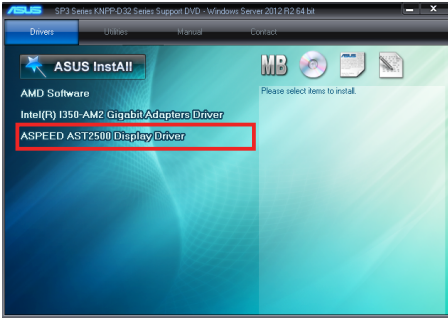

4. From the installation window, click **Next** to start the installation.



5. Click **Install** to start the installation process.

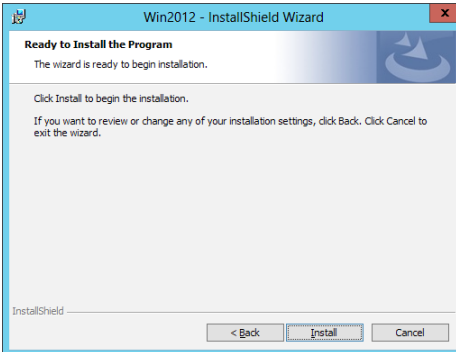

6. Click **Finish** to complete the installation.

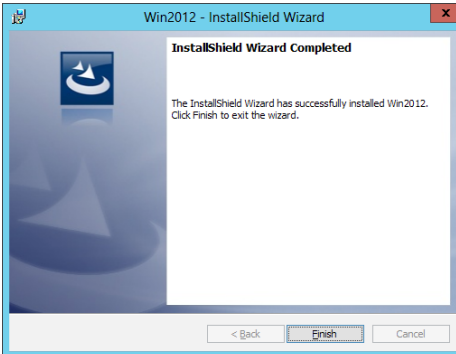

Appendix

Q-Code table

Code	Description
00	Not used
02	microcode
03	CACHE_ENABLED
04	PCH initialization
06	CPU_EARLY_INIT
10	PEI Core is started
11 – 14	Pre-memory CPU initialization is started
15 – 18	Pre-memory System Agent initialization is started
19 – 1C	Pre-memory PCH initialization is started
2B – 2F	Memory initialization
30	Reserved for ASL (see ASL Status Codes section below)
31	Memory Installed
32 – 36	CPU post-memory initialization
37 – 3A	Post-Memory System Agent initialization is started
3B – 3E	Post-Memory PCH initialization is started
4F	DXE IPL is started
50 – 53	Memory initialization error. Invalid memory type or incompatible memory speed
4F	DXE IPL is started
54	Unspecified memory initialization error
55	Memory not installed
56	Invalid CPU type or Speed
57	CPU mismatch
58	CPU self test failed or possible CPU cache error
59	CPU micro-code is not found or micro-code update is failed
5A	Internal CPU error
5B	Reset PPI is not available
5C – 5F	Reserved for future AMI error codes
E0	S3 Resume is started (S3 Resume PPI is called by the DXE IPL)
E1	S3 Boot Script execution
E2	Video repost
E3	OS S3 wake vector call
E4 – E7	Reserved for future AMI progress codes
E8	S3 Resume Failed
E9	S3 Resume PPI not Found
EA	S3 Resume Boot Script Error
EB	S3 OS Wake Error
EC – EF	Reserved for future AMI error codes
F0	Recovery condition triggered by firmware (Auto recovery)
F1	Recovery condition triggered by user (Forced recovery)
F2	Recovery process started
F3	Recovery firmware image is found
F4	Recovery firmware image is loaded
F5 – F7	Reserved for future AMI progress codes
F8	Recovery PPI is not available
F9	Recovery capsule is not found

(continued on the next page)

Code	Description
FA	Invalid recovery capsule
FB – FF	Reserved for future AMI error codes
60	DXE Core is started
61	NVRAM initialization
62	Installation of the PCH Runtime Services
63 – 67	CPU DXE initialization is started
68	PCI host bridge initialization
69	System Agent DXE initialization is started
6A	System Agent DXE SMM initialization is started
6B – 6F	System Agent DXE initialization (System Agent module specific)
70	PCH DXE initialization is started
71	PCH DXE SMM initialization is started
72	PCH devices initialization
73 – 77	PCH DXE Initialization (PCH module specific)
78	ACPI module initialization
79	CSM initialization
7A – 7F	Reserved for future AMI DXE codes
90	Boot Device Selection (BDS) phase is started
91	Driver connecting is started
92	PCI Bus initialization is started
93	PCI Bus Hot Plug Controller Initialization
94	PCI Bus Enumeration
95	PCI Bus Request Resources
96	PCI Bus Assign Resources
97	Console Output devices connect
98	Console input devices connect
99	Super IO Initialization
9A	USB initialization is started
9B	USB Reset
9C	USB Detect
9D	USB Enable
9E – 9F	Reserved for future AMI codes
A0	IDE initialization is started
A1	IDE Reset
A2	IDE Detect
A3	IDE Enable
A4	SCSI initialization is started
A5	SCSI Reset
A6	SCSI Detect
A7	SCSI Enable
A8	Setup Verifying Password
A9	Start of Setup
AA	Reserved for ASL (see ASL Status Codes section below)
AB	Setup Input Wait

(continued on the next page)

Code	Description
AC	Reserved for ASL (see ASL Status Codes section below)
AD	Ready To Boot event
AE	Legacy Boot event
AF	Exit Boot Services event
B0	Runtime Set Virtual Address MAP Begin
B1	Runtime Set Virtual Address MAP End
B2	Legacy Option ROM Initialization
B3	System Reset
B4	USB hot plug
B5	PCI bus hot plug
B6	Clean-up of NVRAM
B7	Configuration Reset (reset of NVRAM settings)
B8– BF	Reserved for future AMI codes
D0	CPU initialization error
D1	System Agent initialization error
D2	PCH initialization error
D3	Some of the Architectural Protocols are not available
D4	PCI resource allocation error. Out of Resources
D5	No Space for Legacy Option ROM
D6	No Console Output Devices are found
D7	No Console Input Devices are found
D8	Invalid password
D9	Error loading Boot Option (LoadImage returned error)
DA	Boot Option is failed (StartImage returned error)
DB	Flash update is failed
DC	Reset protocol is not available

ACPI/ASL Checkpoints (under OS)

Code	Description
03	System is entering S3 sleep state
04	System is entering S4 sleep state
05	System is entering S5 sleep state
30	System is waking up from the S3 sleep state
40	System is waking up from the S4 sleep state
AC	System has transitioned into ACPI mode. Interrupt controller is in PIC mode.
AA	System has transitioned into ACPI mode. Interrupt controller is in APIC mode.

Notices

Federal Communications Commission Statement

This device complies with Part 15 of the FCC Rules. Operation is subject to the following two conditions:

- This device may not cause harmful interference, and
- This device must accept any interference received including interference that may cause undesired operation.

This equipment has been tested and found to comply with the limits for a Class A digital device, pursuant to part 15 of the FCC Rules. These limits are designed to provide reasonable protection against harmful interference when the equipment is operated in a commercial environment. This equipment generates, uses, and can radiate radio frequency energy and, if not installed and used in accordance with the instruction manual, may cause harmful interference to radio communications. Operation of this equipment in a residential area is likely to cause harmful interference in which case the user will be required to correct the interference at his own expense.



The use of shielded cables for connection of the monitor to the graphics card is required to assure compliance with FCC regulations. Changes or modifications to this unit not expressly approved by the party responsible for compliance could void the user's authority to operate this equipment.

Compliance Statement of Innovation, Science and Economic Development Canada (ISED)

This device complies with Innovation, Science and Economic Development Canada licence exempt RSS standard(s). Operation is subject to the following two conditions: (1) this device may not cause interference, and (2) this device must accept any interference, including interference that may cause undesired operation of the device.

CAN ICES-3(A)/NMB-3(A)

Déclaration de conformité de Innovation, Sciences et Développement économique Canada (ISED)

Le présent appareil est conforme aux CNR d'Innovation, Sciences et Développement économique Canada applicables aux appareils radio exempts de licence. L'exploitation est autorisée aux deux conditions suivantes : (1) l'appareil ne doit pas produire de brouillage, et (2) l'utilisateur de l'appareil doit accepter tout brouillage radioélectrique subi, même si le brouillage est susceptible d'en compromettre le fonctionnement.

CAN ICES-3(A)/NMB-3(A)

REACH

Complying with the REACH (Registration, Evaluation, Authorization, and Restriction of Chemicals) regulatory framework, we published the chemical substances in our products at ASUS website at <http://csr.asus.com/english/REACH.htm>.

ASUS Recycling/Takeback Services

ASUS recycling and takeback programs come from our commitment to the highest standards for protecting our environment. We believe in providing solutions for you to be able to responsibly recycle our products, batteries, other components as well as the packaging materials. Please go to <http://csr.asus.com/english/Takeback.htm> for detailed recycling information in different regions.



DO NOT throw the motherboard in municipal waste. This product has been designed to enable proper reuse of parts and recycling. This symbol of the crossed out wheeled bin indicates that the product (electrical and electronic equipment) should not be placed in municipal waste. Check local regulations for disposal of electronic products.



DO NOT throw the mercury-containing button cell battery in municipal waste. This symbol of the crossed out wheeled bin indicates that the battery should not be placed in municipal waste.

Australia statement notice

From 1 January 2012 updated warranties apply to all ASUS products, consistent with the Australian Consumer Law. For the latest product warranty details please visit <https://www.asus.com/support/>. Our goods come with guarantees that cannot be excluded under the Australian Consumer Law. You are entitled to a replacement or refund for a major failure and compensation for any other reasonably foreseeable loss or damage. You are also entitled to have the goods repaired or replaced if the goods fail to be of acceptable quality and the failure does not amount to a major failure.

If you require assistance please call ASUS Customer Service 1300 2787 88 or visit us at <https://www.asus.com/support/>.

ASUS contact information

ASUSTeK COMPUTER INC.

Address 4F, No. 150, Li-Te Rd., Peitou, Taipei 112, Taiwan
Telephone +886-2-2894-3447
Fax +886-2-2890-7798
Web site <https://www.asus.com>

Technical Support

Telephone +86-21-38429911
Fax +86-21-58668722 ext: 9101
Online Support <https://www.asus.com/support/Product/ContactUs/Services/questionform/?lang=en>

ASUSTeK COMPUTER INC. (Taiwan)

Address 4F, No. 150, Li-Te Rd., Peitou, Taipei 112, Taiwan
Telephone +886-2-2894-3447
Fax +886-2-2890-7798
Web site <https://www.asus.com/tw/>

Technical Support

Telephone +886-2-2894-3447 (0800-093-456)
Online Support <https://www.asus.com/support/Product/ContactUs/Services/questionform/?lang=zh-tw>

ASUSTeK COMPUTER INC. (China)

Address No. 5077, Jindu Road, Minhang District, Shanghai, China
Telephone +86-21-5442-1616
Fax +86-21-5442-0099
Web site <https://www.asus.com.cn>

Technical Support

Telephone +86-20-2804-7506 (400-620-6655)
Online Support <https://www.asus.com/support/Product/ContactUs/Services/questionform/?lang=zh-cn>

ASUS contact information

ASUS COMPUTER INTERNATIONAL (America)

Address 48720 Kato Rd., Fremont, CA 94538, USA
Fax +1-510-608-4555
Web site <https://www.asus.com/us/>

Technical Support

Support fax +1-812-284-0883
General support +1-812-282-2787
Online support <https://www.asus.com/support/Product/ContactUs/Services/questionform/?lang=en-us>

ASUS COMPUTER GmbH (Germany and Austria)

Address Harkort Str. 21-23, 40880 Ratingen, Germany
Fax +49-2102-959911
Web site <https://www.asus.com/de/>

Technical Support

Telephone +49-1805-010923
Support Fax +49-2102-959911
Online support <https://www.asus.com/support/Product/ContactUs/Services/questionform/?lang=de-de>

ASUS Czech Service s.r.o. (Europe)

Address Na Rovince 887, 720 00 Ostrava – Hrabová,
Czech Republic
Telephone +420-596766888
Web site <https://www.asus.com/cz/>

Technical Support

Telephone +420-596-766-891
Fax +420-596-766-329
E-mail advance.rma.eu@asus.com
Online Support <https://www.asus.com/support/Product/ContactUs/Services/questionform/?lang=cs-cz>

ASUS contact information

ASUS Holland BV (The Netherlands)

Address Marconistraat 2, 7825GD EMMEN, The Netherlands
Web site <https://www.asus.com/nl/>

Technical Support

Telephone +31-(0)591-5-70292
Fax +31-(0)591-666853
E-mail advance.rma.eu@asus.com
Online Support <https://www.asus.com/support/Product/ContactUs/Services/questionform/?lang=nl-nl>

ASUS Polska Sp. z o.o. (Poland)

Address Ul. Postępu 6, 02-676 Warszawa, Poland
Web site <https://www.asus.com/pl/>

Technical Support

Telephone +48-225718033
Online Support <https://www.asus.com/support/Product/ContactUs/Services/questionform/?lang=pl-pl>

ASK-Service (Russia and CIS)

Address г.Москва, ул. Орджоникидзе, д.10, Россия
Telephone (495) 640-32-75
Web site <https://www.asus.com/ru/>

Technical Support

Telephone 008-800-100-ASUS (008-800-100-2787)
Online Support <https://www.asus.com/support/Product/ContactUs/Services/questionform/?lang=ru-ru>