

Dolphin™ 7800

with Android 2.3.4 Mobile Device Platform

User's Guide

Disclaimer

Honeywell International Inc. (“HII”) reserves the right to make changes in specifications and other information contained in this document without prior notice, and the reader should in all cases consult HII to determine whether any such changes have been made. The information in this publication does not represent a commitment on the part of HII.

HII shall not be liable for technical or editorial errors or omissions contained herein; nor for incidental or consequential damages resulting from the furnishing, performance, or use of this material.

This document contains proprietary information that is protected by copyright. All rights are reserved. No part of this document may be photocopied, reproduced, or translated into another language without the prior written consent of HII.

Web Address: www.honeywellaidc.com

Trademarks

Dolphin is a trademark or registered trademark of Hand Held Products, Inc. in the United States and/or other countries.

Other Trademarks

The Bluetooth trademarks are owned by Bluetooth SIG, Inc., U.S.A. and licensed to Honeywell.

Android and Google are trademarks or registered trademarks of Google Inc. in the United States and/or other countries.

MicroSD and microSDHC are trademarks or registered trademarks of SD-3C, LLC in the United States and/or other countries.

Other product names mentioned in this manual may be trademarks or registered trademarks of their respective companies and are the property of their respective owners.

Patents

For patent information, please refer to www.honeywellaidc.com/patents.

©2012 Honeywell International Inc. All rights reserved.



Table of Contents

Chapter 1 - Dolphin 7800 Terminal Agency Information

Label Locations	1-1
Model Number, Serial Number and IMEI Labels.....	1-1
Laser Safety	1-1
Laser Safety Label	1-1
Laser Safety Statement.....	1-1
LED Safety	1-2
LED Safety Statement.....	1-2
UL and C-UL Statement.....	1-2
R&TTE Compliance Statement—802.11a/b/g/n, Bluetooth, and/or GSM.....	1-2
Dolphin RF Terminal—802.11a/b/g/n, Bluetooth, and/or GSM.....	1-3
Canadian Compliance.....	1-3
RF Exposure Information (SAR)	1-4
For European Community Users	1-4
Waste Electrical and Electronic Equipment Information	1-4
China RoHS	1-5
Pacemakers, Hearing Aids and Other Electrically Powered Devices	1-5
Hearing Aid Compatibility (HAC).....	1-5
Microwaves	1-6

Chapter 2 - Getting Started

Out of the Box	2-1
Initial Setup for Dolphin 7800 Terminal	2-1
The Home Screen	2-4
Personalize the Home Screen	2-4
Status and Notification Indicators.....	2-5
Status and Notification Icons.....	2-5
Google Search Widget.....	2-8
Launch Applications	2-8
Menu Button.....	2-9
Suspend Mode	2-9
Silent Mode and Airplane Mode.....	2-9
Replacing the Main Battery Pack.....	2-9
Resetting the Terminal.....	2-10
Hard Reset (Cold Boot).....	2-10
Connecting the terminal to a workstation via USB.....	2-11
Information Resources.....	2-11

Chapter 3 - Hardware Overview

Standard Configurations for the 7800 Android.....	3-1
Peripherals for the 7800 Android	3-2
Accessories for the 7800 Android	3-3
Front Panel: 7800 Android.....	3-4
Front Panel Features for the 7800 Android.....	3-5

Back Panel: 7800 Android	3-7
Back Panel Features for the 7800 Android.....	3-8
Bottom Panel: 7800 Android.....	3-10
I/O Connector	3-10
Using the Touch Panel	3-10
Installing a Screen Protector.....	3-11
Healthcare Housing	3-11
Batteries	3-11
Main Battery Pack.....	3-11
Internal Backup Battery	3-14
Managing Battery Power	3-14
System Resets	3-14
Installing a SIM Card and/or Replacing the Memory Card	3-15
Installation and/or Replacement	3-15

Chapter 4 - Using the Scan Image Engine

Overview.....	4-1
Laser Safety	4-1
N5603 Beam Divergence Angle	4-1
LED Safety	4-1
Image Engine Specifications	4-1
Depth of Field	4-1
Supported Bar Code Symbologies	4-3
Decoding	4-3
Using the Scan Demo.....	4-4
Configuring the Scan Demo Application	4-6
Using the PowerTools ScanTool	4-7
Aiming Beam Options.....	4-9
Capturing Images	4-10
Taking an Image with the Imaging Demo	4-10
Using the IQImage Demo to decode intelligent bar codes and capture images.....	4-11
Configuring the IQImage Demo Application	4-12
Using the Signature Demo.....	4-12
Uploading Images.....	4-13

Chapter 5 - Using the Color Camera

Overview.....	5-1
Changing the Camera Picture Settings	5-2
Recording Video.....	5-3
Changing the Camera Video Settings	5-3
Uploading Pictures and Videos.....	5-3

Chapter 6 - Using the Keyboards

Available Keyboards.....	6-1
Keyboard Combinations	6-1
Common Buttons.....	6-1
Using the Function Keys.....	6-2

Using the Modifier Keys	6-2
Using the Navigation Keys	6-3
30-Key Numeric Keyboard	6-4
30-Key Numeric Keyboard Combinations.....	6-4
46-Key QWERTY Keyboard	6-6
46-Key QWERTY Keyboard Combinations	6-6
The Phone Options Menu.....	6-8

Chapter 7 - Settings

Overview.....	7-1
Wireless & Network Settings	7-2
Call Settings	7-2
Sound Settings	7-2
Display Settings.....	7-3
Brightness.....	7-3
Auto-rotate screen	7-3
Animation.....	7-3
Screen Timeout	7-3
Touchscreen Calibration.....	7-3
Honeywell Smart Sensors Settings	7-4
Keep awake on motion	7-4
Wake on motion.....	7-4
Accelerometer Calibration	7-4
Location & Security Settings.....	7-4
My Location	7-4
Screen Unlock	7-5
SIM Card Lock.....	7-5
Password Security	7-5
Device Administration	7-5
Credential Storage.....	7-6
Application Settings	7-7
Unknown sources	7-7
Manage applications Screen	7-7
Battery use.....	7-9
Development.....	7-10
Accounts & Sync	7-10
Privacy.....	7-11
Storage	7-11
Unmount/Mount the micorSD card	7-11
Erase the microSD card.....	7-12
Language & Keyboard.....	7-12
Voice Input & Output	7-12
Accessibility	7-13
Date & Time.....	7-13
About Phone.....	7-13

Chapter 8 - Communication

Wireless & Network Settings Menu	8-1
Airplane Mode	8-2
Connecting the Terminal to a Wireless Network	8-2
Wi-Fi Network Connections	8-2
Virtual Private Networks (VPN)	8-3
Adding a VPN	8-3
Connecting to a VPN	8-4
Disconnecting from a VPN.....	8-4
Mobile Networks	8-4

Chapter 9 - Working with Wireless Wide Area Networking (WWAN)

Overview.....	9-1
Antenna Band.....	9-1
Using the Dolphin as a Phone	9-2
Opening and Using the Dialer Window for Phone Calls	9-2
Entering a Phone Number	9-3
Sending Calls.....	9-3
Ending Calls.....	9-4
Answering Calls	9-4
Sending Calls to Voicemail	9-4
Audio Modes.....	9-4
Volume Control.....	9-5
Accessing Voicemail.....	9-5
Call Settings.....	9-5
Using the Dolphin terminal for Data Communication via a Mobile Network	9-8
Adding or Editing an Access Point Name (APN)	9-8

Chapter 10 - Working with the Bluetooth Radio

Enabling the Bluetooth Radio	10-1
Pairing and Trusted Devices	10-1
Connecting to Other Bluetooth Devices.....	10-1
Making the Terminal Discoverable	10-3
Sharing Pictures and Video	10-4
.....	10-5

Chapter 11 - Dolphin 7800 HomeBase Device (Model 7800-HB)

Overview.....	11-1
Parts and Functions.....	11-2
Back Panel	11-3
Bottom Panel	11-4
Power	11-4
Connecting Power to the HomeBase.....	11-4
Charging the Main Battery.....	11-5
To Power a Terminal and Charge its Main Battery.....	11-5
Charging a Spare Battery in the Auxiliary Battery Well	11-5

Communication.....	11-6
Connecting the Communication Cables	11-6
Establishing Communication	11-6
Communicating with the Dolphin Terminal	11-6
Mounting the HomeBase	11-7

Chapter 12 - Dolphin 7800 Mobile Base Device (Model 7800-MB)

Overview.....	12-1
Mobile Base Components	12-2
Back Panel and Mounting Brackets.....	12-3
Mounting.....	12-4
Safety Precautions.....	12-4
Installation.....	12-4
Charging the Main Battery.....	12-5
To Power a Terminal and Charge its Main Battery.....	12-5

Chapter 13 - Dolphin 7800 ChargeBase Device (Model 7800-CB)

Overview.....	13-1
Unpacking the ChargeBase.....	13-1
Parts and Functions.....	13-2
Front Panel	13-2
Back Panel.....	13-3
Power	13-3
Connecting Power to the ChargeBase	13-3
Charging the Main Battery.....	13-4
To Power a Terminal and Charge its Main Battery.....	13-4
Mounting the ChargeBase.....	13-4

Chapter 14 - Dolphin 7800 QuadCharger Device (Model 7800-QC)

Overview.....	14-1
Parts and Functions.....	14-2
Power	14-3
Inserting and Charging Batteries	14-3
Mounting the QuadCharger	14-4
Troubleshooting.....	14-5

Chapter 15 - Customer Support

Product Service and Repair.....	15-1
Technical Assistance	15-1
Limited Warranty	15-1
How to Extend Your Warranty	15-2



Dolphin 7800 Terminal Agency Information

Dolphin 7800 mobile computers meet or exceed the requirements of all applicable standards organizations for safe operation. However, as with any electrical equipment, the best way to ensure safe operation is to operate them according to the agency guidelines that follow. Read these guidelines carefully before using your Dolphin terminal.

This documentation is relevant for the following Dolphin models: 7800L0, 7800LW.



CAUTION - Read the [Guidelines for Battery Pack Use and Disposal](#) on page 3-13 and all cautionary markings on the battery, charging peripheral, or device using the battery before attempting to install, use, or charge the battery. **Risk of fire and burns if improperly handled. Do not open, crush, heat above 60°C (140°F), or incinerate.**

Label Locations

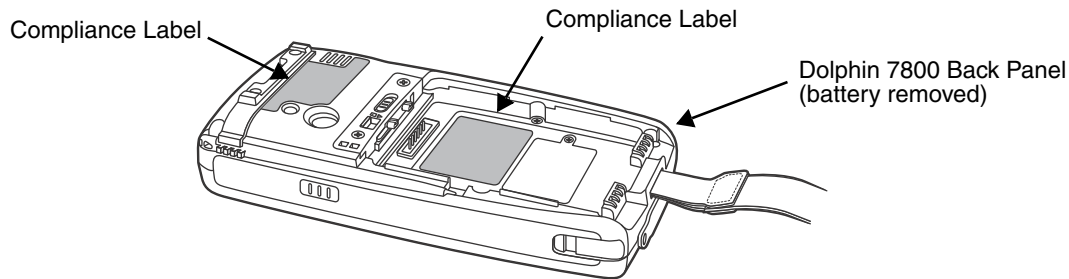

Model Number, Serial Number and IMEI Labels

The model (item) number, serial number, and international mobile equipment identity (IMEI) number for the terminal are located on labels affixed to the walls of the battery well.

Laser Safety

Laser Safety Label

If the following label is attached to your product, it indicates the product contains an engine with a laser aimer:

Image Engines with Integrated Laser Aimers



Laser Safety Statement

This device has been tested in accordance with and complies with IEC60825-1(Ed. 2.0), EN60825-1:2007. Complies with 21 CFR 1040.10 and 1040.11, except for deviations pursuant to Laser Notice No. 50, dated June 24, 2007. LASER LIGHT, DO NOT STARE INTO BEAM. CLASS 2 LASER PRODUCT, 1.0 mW MAX OUTPUT: 650nm.



WARNING - Use of controls or adjustments or performance of procedures other than those specified herein may result in hazardous radiation exposure.

LED Safety

LED Safety Statement

LEDs have been tested and classified as “EXEMPT RISK GROUP” to the Standard: IEC 62471:2006.



CAUTION! Do not view directly with optical instruments.

UL and C-UL Statement

UL and C-UL listed: UL60950-1 2nd Edition, and CSA C22.2 No. 60950-1-07 2nd Edition.

Underwriters Laboratories Inc. (UL) has not tested the performance or reliability of the global positioning system (GPS) hardware, GPS operating software or other GPS-related aspects of this product. UL has only tested for the explosion, fire, shock, and casualty hazards required by the applicable hazardous locations standards. UL certification does not cover the performance or reliability of the GPS hardware, GPS operating software, or other GPS-related aspects of this product. UL makes no representations, warranties, or certifications whatsoever regarding the performance or reliability of any GPS-related functions of this product.

R&TTE Compliance Statement—802.11a/b/g/n, Bluetooth, and/or GSM

Dolphin RF terminals are in conformity with all essential requirements of the R&TTE Directive (1999/5/EC).

This product is marked with **CE 0678** ⓘ according to article 12 of the R&TTE Directive. In addition, this product complies to 2006/95/EC Low Voltage Directive when supplied with the recommended power supply. Honeywell shall not be liable for use of our product with equipment (i.e., power supplies, personal computers, etc.) that is not CE marked and does not comply with the Low Voltage Directive.

The equipment is intended for use throughout the European Community; PAN European Frequency Range: 2.402–2.480 GHz. Restrictions for use in France are as follows:

- Indoor use: Maximum power (EIRP*) of 100 mW for the entire 2.400–2.4835 GHz
- Outdoor use: Maximum power (EIRP*) of 100 mW for the 2.400–2.454 GHz band & maximum power (EIRP*) of 10 mW for the 2.454–2.483 MHz band.
- 5Ghz band: UNII (Unlicensed National Information Infrastructure) or band1 (5.150 to 5.250 GHz) is restricted to indoor use only. Any other use will make the operation of the device illegal.

European Contact:

Hand Held Products Europe B.V.
Nijverheidsweg 9-13
5627 BT Eindhoven
The Netherlands

FCC Requirements

Dolphin RF Terminal—802.11a/b/g/n, Bluetooth, and/or GSM

This device complies with Part 15 of the FCC Rules. Operation is subject to the following two conditions: (1) this device may not cause harmful interference, and (2) this device must accept any interference received, including interference that may cause undesired operation.

This equipment has been tested and found to comply with the limits for a Class B digital device pursuant to Part 15 of the FCC Rules. These limits are designed to provide reasonable protection against harmful interference in a residential installation. This equipment generates, uses, and can radiate radio frequency energy and, if not installed and used in accordance with the instructions, may cause harmful interference to radio communications. However, there is no guarantee that interference will not occur in a particular installation. If this equipment does cause harmful interference to radio or television reception, which can be determined by turning the equipment off and on, the user is encouraged to try to correct the interference by one or more of the following measures:

- Reorient or relocate the receiving antenna.
- Increase the separation between the equipment and receiver.
- Connect the equipment into an outlet on a circuit different from that to which the receiver is connected.
- Consult the dealer or an experienced radio/TV technician for help.

If necessary, the user should consult the dealer or an experienced radio/television technician for additional suggestions. The user may find the following booklet helpful: "Something About Interference." This is available at FCC local regional offices. Our company is not responsible for any radio or television interference caused by unauthorized modifications of this equipment or the substitution or attachment of connecting cables and equipment other than those specified by our company. The correction is the responsibility of the user. Use only shielded data cables with this system.

In accordance with FCC 15.21, changes or modifications not expressly approved by the party responsible for compliance could void the user's authority to operate the equipment.

The antenna(s) used for this transmitter must not be co-located or operating in conjunction with any other antenna or transmitter.

CAUTION! - Any changes or modifications not expressly approved by the grantee of this device could void the user's authority to operate the equipment.

Canadian Compliance

This device complies with Industry Canada license-exempt RSS standard(s). Operation is subject to the following two conditions:

1. this device may not cause interference, and
2. this device must accept any interference, including interference that may cause undesired operation of the device.

Le présent appareil est conforme aux CNR d'Industrie Canada applicables aux appareils radio exempts de licence. L'exploitation est autorisée aux deux conditions suivantes:

1. l'appareil ne doit pas produire de brouillage, et
2. l'utilisateur de l'appareil doit accepter tout brouillage radioélectrique subi, même si le brouillage est susceptible d'en compromettre le fonctionnement.

This Class B digital apparatus complies with Canadian ICES-003.

Cet appareil numérique de la classe B est conforme à la norme NMB-003 du Canada.

This Category II radiocommunication device complies with Industry Canada Standard RSS-310.

Ce dispositif de radiocommunication de catégorie II respecte la norme CNR-310 d'Industrie Canada.

RF Exposure Information (SAR)

This mobile phone meets the government's requirements for exposure to radio waves. This phone is designed and manufactured not to exceed the emission limits for exposure to radio frequency (RF) energy set by the Federal Communications Commission of the U.S. Government.

The exposure standard for wireless mobile phones employs a unit of measurement known as the Specific Absorption Rate, or SAR. The SAR limit set by the FCC is 1.6W/kg and for Europe is 2W/Kg. Tests for SAR are conducted using standard operating positions accepted by the FCC with the phone transmitting at its highest certified power level in all tested frequency bands. Although the SAR is determined at the highest certified power level, the actual SAR level of the phone while operating can be well below the maximum value. This is because the phone is designed to operate at multiple power levels so as to use only the power required to reach the network. In general, the closer you are to a wireless base station antenna, the lower the power output.

The highest reported SAR values for this FCC ID are: GSM 850: 0.475 W/Kg, GSM 1900: 0.364 W/Kg; WCDMA band II: 0.568 W/Kg, WLAN 0.092: W/Kg.

The highest reported CE SAR values for this product are: 900 MHz band: 0.762 W/Kg, 1800 MHz band: 0.626 W/Kg, and WLAN: 0.074 W/kg.

While there may be differences between the SAR levels of various phones and at various positions, they all meet the government requirement.

The FCC has granted an Equipment Authorization for this model phone with all reported SAR levels evaluated as in compliance with the FCC RF exposure guidelines. SAR information on this model phone is on file with the FCC and can be found under the Display Grant section of www.fcc.gov/oet/ea/fccid after searching on FCC ID: HD57800LG and HD57800LW.

For body worn operation, this phone has been tested and meets the FCC RF exposure guidelines for use with an accessory that contains no metal and positions the handset a minimum of 1.5 cm from the body. Use of other accessories may not ensure compliance with FCC RF exposure guidelines. If you do not use a body-worn accessory and are not holding the phone at the ear, position the handset a minimum of 1.5 cm from your body when the phone is switched on.

For European Community Users

Honeywell complies with Directive 2002/96/EC OF THE EUROPEAN PARLIAMENT AND OF THE COUNCIL of 27 January 2003 on waste electrical and electronic equipment (WEEE).

Waste Electrical and Electronic Equipment Information

This product has required the extraction and use of natural resources for its production. It may contain hazardous substances that could impact health and the environment, if not properly disposed.

In order to avoid the dissemination of those substances in our environment and to diminish the pressure on the natural resources, we encourage you to use the appropriate take-back systems for product disposal. Those systems will reuse or recycle most of the materials of the product you are disposing in a sound way.



The crossed out wheeled bin symbol informs you that the product should not be disposed of along with municipal waste and invites you to use the appropriate separate take-back systems for product disposal. If you need more information on the collection, reuse, and recycling systems, please contact your local or regional waste administration. You may also contact your supplier for more information on the environmental performances of this product.

China RoHS

 有毒有害物质名称及含量 (Names and Content of Hazardous Substances or Elements)						
部件名称 (Parts Name)	有毒有害物质或元素 (Toxic and Hazardous Substances or Elements)					
	铅 (Pb)	汞 (Hg)	镉 (Cd)	六价铬 (Cr ⁶⁺)	多溴联苯 (PBB)	多溴二苯醚 (PBDE)
成像式条码阅读器 (Imager)	x	o	o	o	o	o
印刷电路板 (PCBA)	x	o	o	o	o	o
主机及基座外壳 (Housing)	x	o	o	o	o	o
连线 (Cables)	o	o	o	o	o	o
液晶显示器 (LCD)	o	o	o	o	o	o
液晶显示器框架 (LCD Frame)	o	o	o	o	o	o
相机模组 (Camera)	x	o	o	o	o	o
键盘 (Keypad)	o					
电池 (Battery)	o	o	o	o	o	o
电源供应器 (Power Adapter)	x	o	o	o	o	o

o: 表示该有毒有害物质在该部件所有均质材料中的含量均在SJ/T11363-2006标准规定的限量要求以下 (Indicates that this toxic or hazardous substance contained in all of the homogeneous materials for this part is below the limit requirement in China's SJ/T11363-2006.)
x: 表示该有毒有害物质至少在该部件的某一均质材料中的含量超出 SJ/T11363-2006 标准规定的限量要求 (Indicates that this toxic or hazardous substance contained in at least one of the homogeneous materials for this part is above the limit requirement in China's SJ/T11363-2006.)

Pacemakers, Hearing Aids and Other Electrically Powered Devices

Most manufacturers of medical devices adhere to the IEC 601-1-2 standard. This standard requires devices to operate properly in an EM Field with a strength of 3V/m over a frequency range of 26 to 1000MHz. The maximum allowable field strength emitted by the Dolphin terminal is 0.3V/m according to Subpart B of Part 1 of the FCC rules. Therefore, the RF from the Dolphin terminal has no effect on medical devices that meet the IEC specification.

Hearing Aid Compatibility (HAC)

The Dolphin 7800 has been tested for hearing aid compatibility. This device has an M3 and T3 rating. For additional HAC information, including the HAC rating for this product, please refer to www.honeywellaidc.com.

When some wireless devices are used near some hearing devices such as hearing aids and implants, users may detect a buzzing or humming noise. Some hearing devices are more immune than others to this interference noise. Wireless devices may also vary in the amount of interference they generate.

The ratings for compatibility of digital wireless devices with hearing aids are described in the American National Standards Institute (ANSI) C63.19 standard:

M-Rating: Phones rated M3 or M4 meet FCC requirements and are likely to generate less interference with hearing devices than phones that are not labeled. M4 is the superior/higher of the two ratings.

T-Rating: Phones rated T3 or T4 meet FCC requirements and are likely to be more usable with hearing devices' telecoil than unrated phones. T4 is the superior/higher of the two ratings.

The more immune the hearing aid device is, the less likely one is to experience interference noise from the wireless phone. Hearing aid devices may also be rated. Adding the ratings of the hearing aid and the phone would determine probable usability:

- Any combined rating equal to or greater than six offers the best use.
- Any combined rating equal to five is considered normal use.

The ratings are not guarantees. Results will vary depending on the user's hearing device and hearing loss. If your hearing device happens to be vulnerable to interference, you may not be able to use this device successfully. Trying out this device with your hearing device is the best way to evaluate it for your personal needs.

This device has been tested and rated for use with hearing aids for some of the wireless technologies that it utilizes. However, there may be some newer wireless technologies used in this phone that have not been tested yet for use with hearing aids. It is important to try the different features of this phone thoroughly and in different locations, using your hearing aid or cochlear implant, to determine if you hear any interfering noise. Consult your service provider or the manufacturer of this phone for information on hearing aid compatibility.

Microwaves

The radio in the Dolphin RF terminal operates on the same frequency band as a microwave oven. Therefore, if you use a microwave within range of the Dolphin RF terminal you may notice performance degradation in your wireless network. However, both your microwave and your wireless network will continue to function.

Getting Started

Out of the Box

Verify that the carton contains the following items:

- Dolphin Mobile Computer (the terminal)
- 1 GB, 2 GB or 4 GB microSD Memory Card (pre-installed)
- Main Battery Pack
- Quick Start Guide

If you ordered accessories for your terminals, verify that they are also included with the order. Be sure to keep the original packaging in the event that the Dolphin terminal should need to be returned for service. For details, see [Product Service and Repair](#) on page 15-1.

Memory Card

The Dolphin 7800 supports either a microSD™ or a microSDH™ memory card. A microSD memory card is included and pre-installed with the device. Expansion memory cards are available for purchase. Contact a Honeywell customer service representative or go to www.honeywellaidc.com for more information.

Note: Operating the device without a memory card may cause application errors due to external memory dependency.

Initial Setup for Dolphin 7800 Terminal

Step 1. Install the Main Battery Pack

Note: Before installing the main battery pack, read the [Guidelines for Battery Pack Use and Disposal](#) on page 3-13.

The terminal is shipped with the battery packaged separate from the unit. Perform the steps illustrated below to install the main battery pack. For information on how to remove the battery, see [Replacing the Main Battery Pack](#) on page 2-9.



Ensure all components are dry prior to placing the battery in the terminal. Mating wet components may cause damage not covered by the warranty.

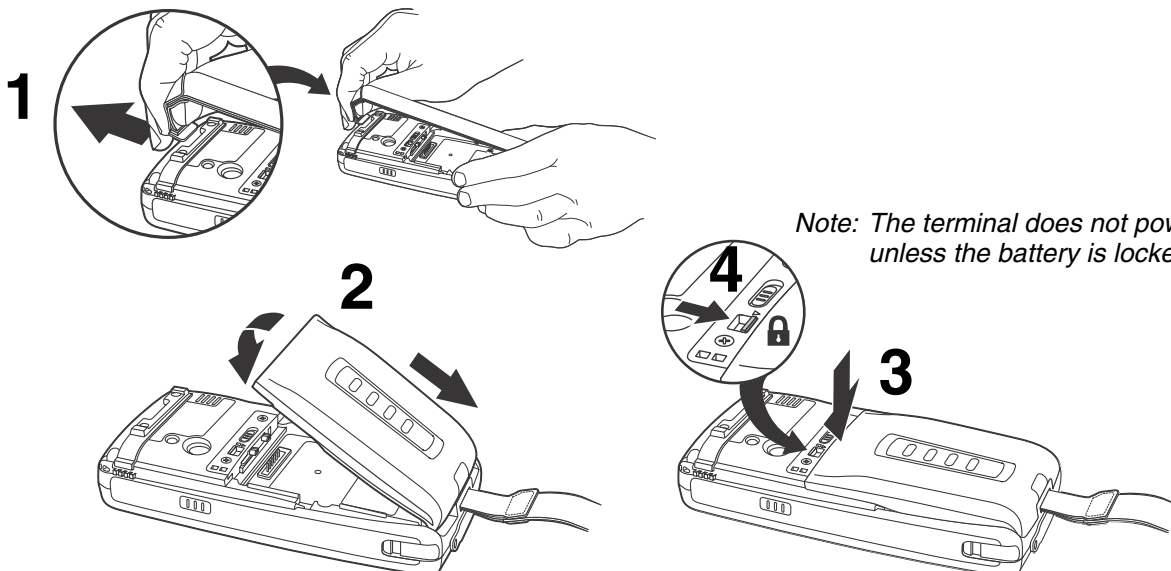

Dolphin 7800 model terminals are designed for use with standard battery pack model 7800-BTSC (Li-ion 3.7 V, 8.9 watt hour) and extended battery pack models 7800-BTXC and 7800-BTXCW (Li-ion 3.7 V, 14.8 watt hour) manufactured for Honeywell International Inc.

Step 2. Charge the Main Battery Pack and Backup Battery

The power supply for Dolphin terminals consists of two types of battery power: the main battery pack that is accessible from the back panel, and the backup battery that resides inside the terminal. The main battery pack powers the terminal. The internal backup battery charges off the main battery and maintains the application data stored in RAM memory for up to 5 minutes when the terminal's main battery pack is completely discharged or removed.

Before Initial Use

Note: Terminals are shipped with both batteries discharged of all power. Honeywell recommends charging the Dolphin terminal for at least 24 hours prior to initial use to ensure the internal backup battery is fully charged.

Connect the terminal to one of the 7800 series charging peripherals to charge the batteries. Dolphin 7800 terminals with Android 2.3 are designed for use with the following 7800 charging devices and cables: 7800-HB, 7800-NB, 7800-CB, 7800-MC, 7800-MB, and 7800-USB. See [Peripherals for the 7800 Android](#) on page 3-2 for additional information.

Charge time for the main battery pack is:

- 4 hours for the standard battery pack (7800-BTSC) or
- 6 hours for the extended battery pack (7800-BTXC or 7800-BTXW).

 *We recommend use of Honeywell peripherals, power cables, and power adapters. Use of any non-Honeywell peripherals, cables, or power adapters may cause damage not covered by the warranty.*

Charging Using the Communication Cable (Model 7800-USB)

Use only a UL Listed power supply, which has been qualified by Honeywell with an output rated at 5VDC and 3A with the device.

 *Ensure all components are dry prior to mating terminals/batteries with peripheral devices. Mating wet components may cause damage not covered by the warranty.*

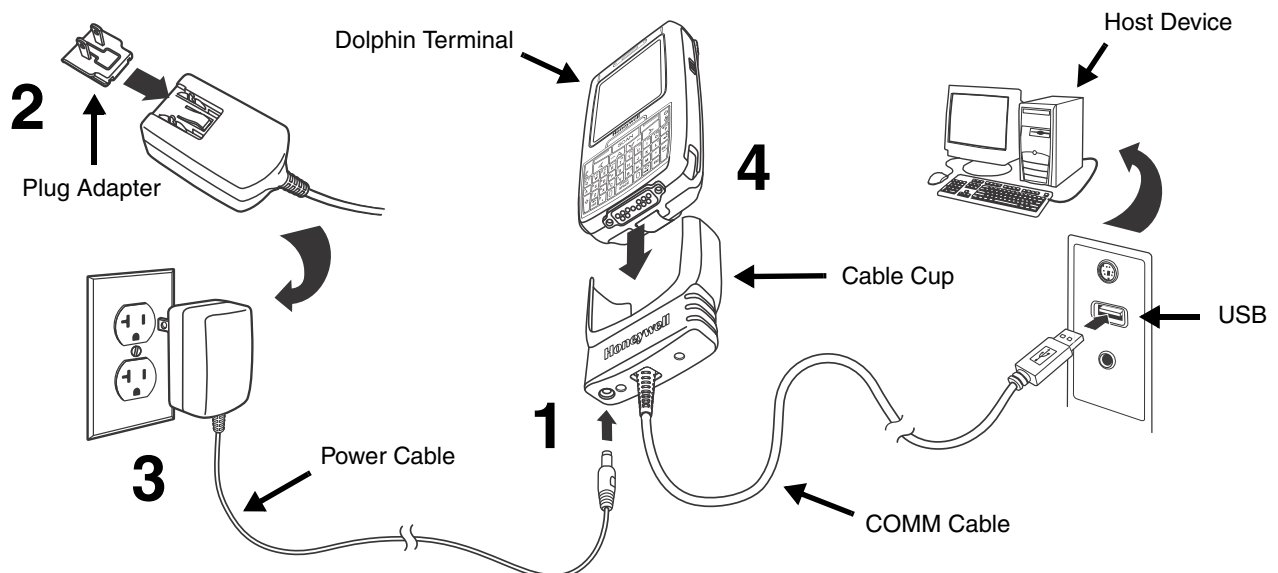

Step 3. Calibrate the Touch Screen and Access the Home Screen

The terminal begins booting as soon as power is applied. Do NOT press any keys or interrupt the boot process.

Touch Screen Calibration



You need to calibrate the touch screen the first time the terminal completes the boot process to ensure the touch screen receives the correct input when tapped. Once calibration is complete, you do not need to repeat the process unless the touch screen is not reacting accurately when tapped.

To calibrate the touch screen, tap and hold the center of the target  for approximately 3 seconds each time the target appears on the screen.



Note: During calibration, the target appears five times, once in each of the four corners of the screen and once in the center of the screen.

Access the Home Screen

After initial screen calibration, access the **Home** Screen by unlocking the screen. See [Location & Security Settings](#) on page 7-4 for information on customizing the [Screen Unlock](#) feature for added terminal security.

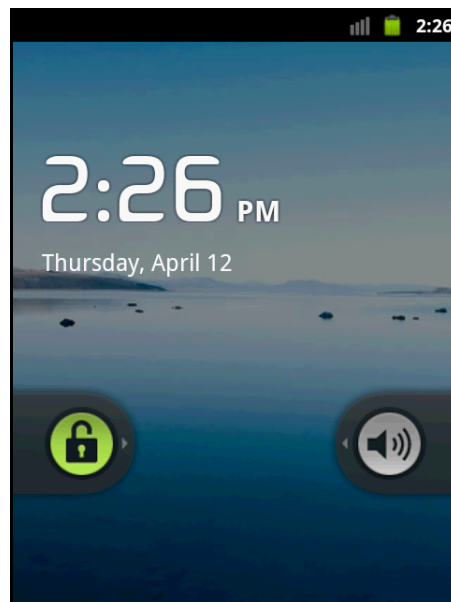
Drag the **Unlock** icon  to the right  or press the **Menu** key to access the **Home** Screen.





Drag the **Sound** icon  to the left  to toggle between turning the Sound off.

Note: To conserve battery power the touch screen dims then darkens automatically after a period of no activity. Press the Power button, then drag the unlock icon to the right or press the Menu key to wake the terminal and access the Home screen. See [Display Settings](#) on page 7-3 for information on how to adjust [Screen Timeout](#) settings.

The Home Screen

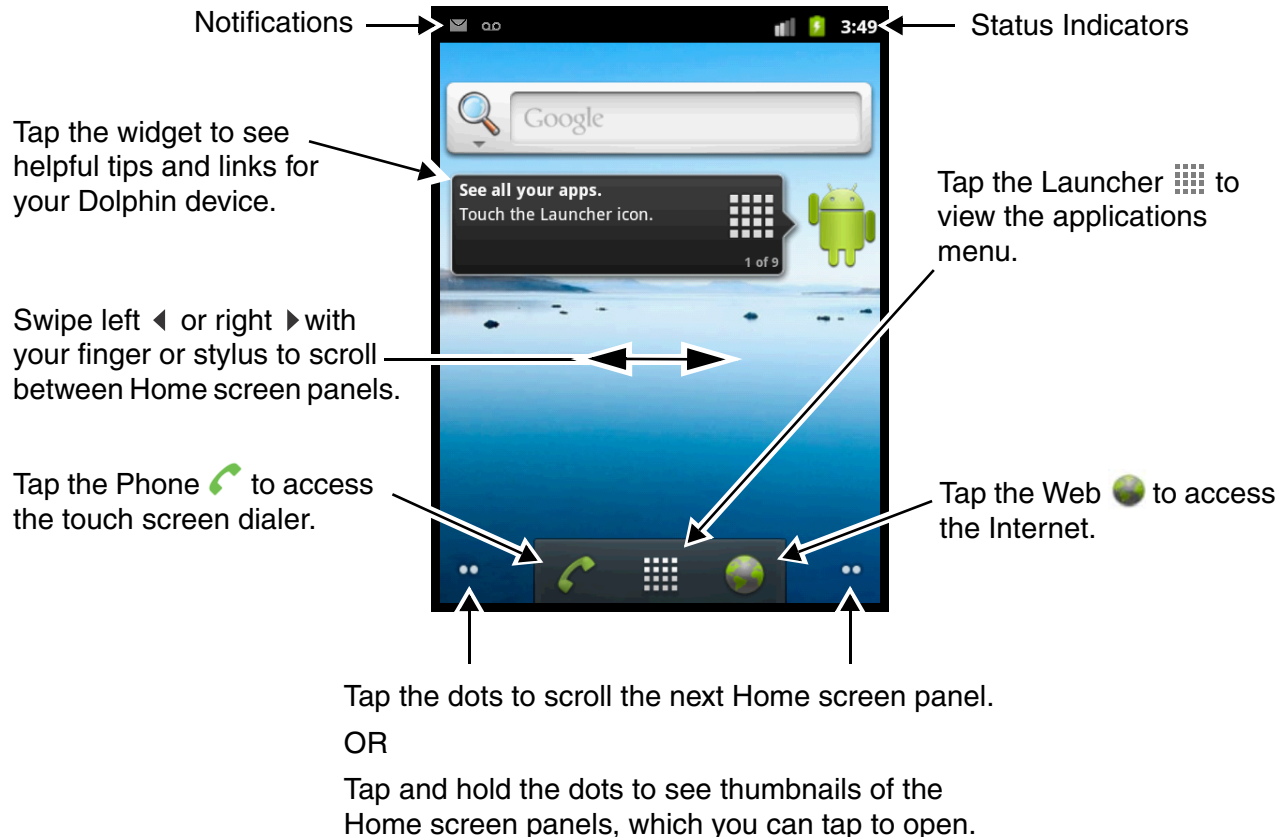
Android™ mobile technology provides space for user customization and control with five Home Screen panels.



Note: You can return to the Home screen at any time, in any application by pressing the  key.

Personalize the Home Screen

Personalize the Home screen panels for quick access to the apps, notifications, and menus.

To **add** an item:

1. Tap and hold an empty spot on the Home screen.
2. Select the type of item (e.g., shortcut, widget, folder, or wallpaper).
3. Choose the item from the list or browse to the item you want to add.

To **remove/delete** an item:

1. Tap and hold the item.
2. When the unit vibrates, drag the item to the Trash  at the bottom of the screen.

To **move** an item:

1. Tap and hold the item.
2. When the unit vibrates, drag the item to the new location, then release.

Note: The next panel automatically opens if you drag the item to the edge of the touchscreen.

Status and Notification Indicators

The status bar located at the top of the touch screen displays notifications (on the left), the status of various system functions (on the right), and the current time (on the far right).



The Notification Panel

A plus sign icon  appears on the status bar when the quantity of notification exceeds the available space on the bar. To view all the notifications, tap and hold the status bar, then drag down open the notification panel.



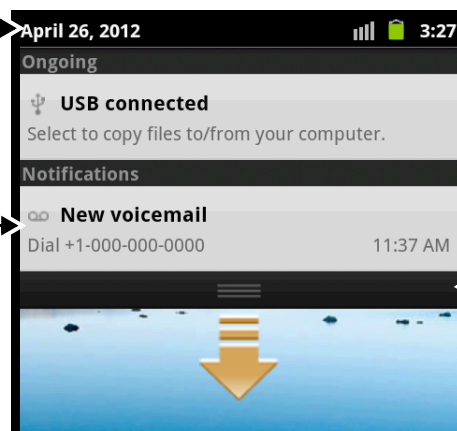

Tap and hold the status bar, then drag down.























Tap a notification to open the related application.





















Tap on the bottom bar to close the details screen.

Status and Notification Icons

Icon	Meaning
	Open notification panel to see additional notifications
	Pending calendar event
	Pending alarm
	Call in progress
	Call in progress using a headset with Bluetooth technology

Icon	Meaning
	Call forwarding turned on
	Call on hold
	Missed call
	New Voicemail message
	New Google Talk message
	New E-mail
	New Gmail
	New text message or multimedia message
	Error with text or multimedia message delivery
	SD card or USB storage is full
	Synchronizing data
	Error with sync or sign-in
	The terminal could not synchronize data with the workstation
	Wi-Fi network connected and signal strength
	Terminal is connected to a workstation using a USB cable
	Uploading data
	Downloading data
	Download finished
	Music player active
	ABD active
	Call is muted
	Sound is turned off

Icon	Meaning
	Vibrate mode is turned on
	Battery has a very low charge and requires charging.
	Battery charge is at 50%.
	Battery charge is at 100%.
	Terminal is connected to external power and the battery is charging.
	A battery is installed, but the charge level cannot be measured. Replace the battery.
	Bluetooth technology is turned on
	Terminal connected to a device with Bluetooth technology
	Bluetooth incoming file notification
	GPS is turned on
	Receiving location data from GPS
	Network signal strength
	No network signal
	Network connection data transfer
	Speaker phone is on
	The carrier data use threshold has been reached or exceeded
	No SIM card is installed
	Alarm is set

Google Search Widget

To Search for an item, use the Google Search widget on the Home screen.





Launch Applications

To see the applications loaded on your terminal, tap the application **Launcher**  located at the bottom of the Home screen. To open an app, tap once on the app icon.

To add the app to the Home screen for quick access, tap and hold the stylus on the icon. When the unit vibrates and switches to the Home screen, drag the item to the new location on one of the five Home screen panels.

Note: The next panel automatically opens if you drag the item to the edge of the touchscreen.

To return to the Home screen from any open application screen tap  on the touch screen or press  on the keyboard.

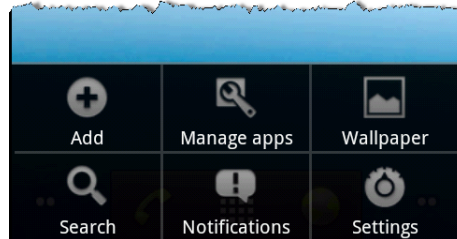

Menu Button

Press the MENU button on your keyboard to access options relevant to the open application.



Suspend Mode

Suspend Mode turns the touchscreen off and locks the terminal. To save battery power, the terminal enters Suspend Mode when the device is inactive for a programmed period of time. To adjust the timeout limit, tap the **Launcher > Settings > Display > Screen Timeout**.

1. Press and release the **Power** key  to toggle the terminal in or out of Suspend Mode.
2. Drag  to the right on the touchscreen to unlock the terminal.

Note: You should always place the terminal in suspend mode when replacing the battery pack.

Silent Mode and Airplane Mode

1. Press and hold the **Power** key  for approximately 5 seconds.
2. Tap **Silent Mode** or **Airplane Mode** on the **Phone Options** menu to toggle the mode on or off.

Note: When Airplane Mode is turned on,  shows on the status bar.

Replacing the Main Battery Pack

Note: Before replacing the main battery pack, read the [Guidelines for Battery Pack Use and Disposal](#) on page 3-13.

 *Ensure all components are dry prior to mating terminals/batteries with peripheral devices. Mating wet components may cause damage not covered by the warranty.*

1. Press the **Power** key  to put the terminal in **Suspend Mode**.
2. Release the hand strap near the speaker on the back panel of the terminal.
3. Unlock the battery by sliding the latch away from the battery.
4. **Wait at least 3 seconds**, then slide the battery release button away from the stylus slot.

-
- Remove the battery.

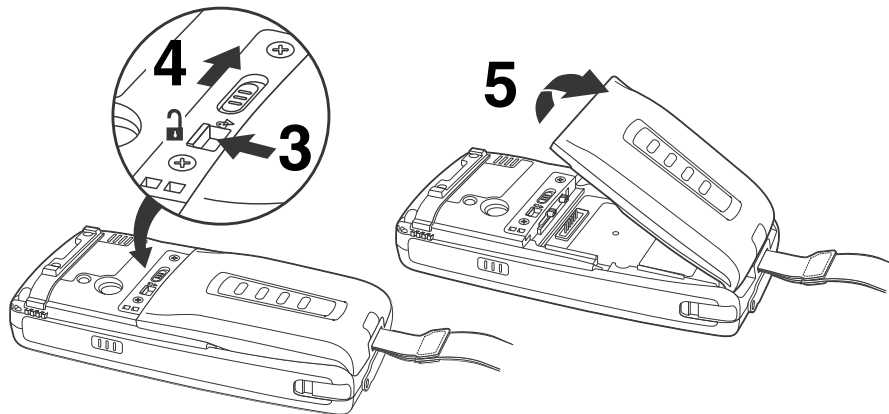

- Insert the new battery and apply gentle pressure to engage the latch.

Note: Make sure the stylus tether is not caught under the battery during installation.

- Lock the battery by sliding the latch toward the battery pack.

Note: The terminal does not power ON unless the battery is locked.

- Reattach the hand strap.

- Press the Power key  or the SCAN key to wake the terminal from [Suspend Mode](#) (see page 2-9).



We recommend use of Honeywell Li-ion battery packs. Use of any non-Honeywell battery may result in damage not covered by the warranty.

Resetting the Terminal

There are two types of system resets: a hard reset or a factory reset. The hard reset preserves all data stored in the file system. Contact a Honeywell technical support representative for information on how to perform a factory reset. For contact information, see [Customer Support](#) on page 15-1.

Hard Reset (Cold Boot)

A hard reset re-boots the device and closes any open applications running in RAM at the time of the reset.

- Press and hold the **BLUE**  + **SEND**  keys for approximately 10 seconds.

Or

- Press and hold the **Power** key  for approximately 5 seconds.
- Tap **Reboot** on the **Phone Options** menu.

Connecting the terminal to a workstation via USB

You can copy files (e.g., pictures, music, videos or backup files) between your workstation (PC) and the terminal's microSD card using either the Dolphin 7800 HomeBase and a standard USB cable or the Dolphin 7800 USB Charging/Communication Cable. The 7800 terminal supports Hi-Speed USB communication (USB 2.0) with a maximum data transfer rate of 480 Mbps.

Hardware Requirements

- Dolphin communication peripheral (e.g., HomeBase or USB Communication/Charge Cable) and power supply.
- A USB cable if one is not supplied with your Dolphin communication peripheral.

1. Tap **Launcher**  > **Settings** > **Applications** > **Development**
2. Check the **USB debugging** box, then press the **Home** key.

Note: The adb bridge notification  appears on the status bar when USB debugging is enabled.

3. Connect the Dolphin terminal to the workstation USB port using a Dolphin communication peripheral.

Note: A USB connection notification  appears on the status bar to indicate the hardware connection has been established.

4. Tap and hold the status bar at the top of the screen, then drag down to open the notification panel.
5. Tap on **USB connected**. The USB Mass Storage screen opens.
6. Tap **Turn on USB storage**.
7. The workstation views the terminal as an external USB storage drive. You can copy, delete and/or move files or folders between the workstation and terminal's microSD as you would with any other storage drive (e.g., cut and paste or drag and drop via Windows Explorer).
8. When you are finished transferring files, follow the proper procedure for your workstation's operating system to **safely remove the hardware** (e.g., unmount or eject) before attempting to disconnect the terminal from the workstation or turning off the USB storage setting. **Data corruption may occur if the proper removal processes are not followed.**
9. Tap **Turn off USB storage** on the terminal touch screen.

Information Resources

You can find detailed information on application development for Android devices on the Android developer web site at <http://developer.android.com> and additional information on how to use the Android 2.3.4 mobile technology platform in the *Android 2.3.4 User's Guide* available for download at <http://support.google.com/mobile/bin/answer.py?hl=en&answer=182077>.



Hardware Overview

Standard Configurations for the 7800 Android

WLAN & WPAN

- Android 2.3.4 Mobile Device Platform
- 800MHz TI OMAP Processor
- 256MB RAM X 512MB Flash
- 1 GB, 2 GB or 4 GB microSD (pre-installed)
- QWERTY or Numeric keyboard option
- 3.7V Li-ion standard battery pack or extended rechargeable battery pack
- Adaptus Imaging Technology: N5603ER/SR/HD or N5600ER/SR/HD image engines
- 802.11a/b/g/n and Bluetooth

WLAN, WPAN & Camera

- Android 2.3.4 Mobile Device Platform
- 800MHz TI OMAP Processor
- 256MB RAM X 512MB Flash
- 1 GB, 2 GB or 4 GB microSD (pre-installed)
- QWERTY or Numeric keyboard option
- 3.7V Li-ion standard battery pack or extended rechargeable battery pack
- Adaptus Imaging Technology: N5603ER/SR/HD or N5600ER/SR/HD image engines
- 802.11a/b/g/n and Bluetooth
- 3.0 megapixel auto control color camera

WLAN, WPAN, with GPS

- Android 2.3.4 Mobile Device Platform
- 800MHz TI OMAP Processor
- 256MB RAM X 512MB Flash
- 1 GB, 2 GB or 4 GB microSD (pre-installed)
- QWERTY or Numeric keyboard option
- 3.7V Li-ion standard battery pack or extended rechargeable battery pack
- Adaptus Imaging Technology: N5603ER/SR/HD or N5600ER/SR/HD image engines
- 802.11a/b/g/n and Bluetooth
- GPS

WLAN, WPAN, with GPS & Camera

- Android 2.3.4 Mobile Device Platform
- 800MHz TI OMAP Processor
- 256MB RAM X 512MB Flash
- 1 GB, 2 GB or 4 GB microSD (pre-installed)
- QWERTY or Numeric keyboard option
- 3.7V Li-ion standard battery pack or extended rechargeable battery pack
- Adaptus Imaging Technology: N5603ER/SR/HD or N5600ER/SR/HD image engines
- 802.11a/b/g/n and Bluetooth
- GPS
- 3.0 megapixel auto control color camera

WLAN, WPAN, & WWAN

- Android 2.3.4 Mobile Device Platform
- 800MHz TI OMAP Processor
- 256MB RAM X 512MB Flash
- 1 GB, 2 GB or 4 GB microSD (pre-installed)
- QWERTY or Numeric keyboard option
- 3.7V Li-ion extended rechargeable battery pack
- Adaptus Imaging Technology: N5603ER/SR/HD or N5600ER/SR/HD image engines
- 802.11a/b/g/n, Bluetooth, and GSM/HSPA+

WLAN, WPAN, & WWAN with GPS

- Android 2.3.4 Mobile Device Platform
- 800MHz TI OMAP Processor
- 256MB RAM X 512MB Flash
- 1 GB, 2 GB or 4 GB microSD (pre-installed)
- QWERTY or Numeric keyboard option
- 3.7V Li-ion extended rechargeable battery pack
- Adaptus Imaging Technology: N5603ER/SR/HD or N5600ER/SR/HD image engines
- 802.11a/b/g/n, Bluetooth, and GSM/HSPA+
- GPS

Some configurations of the 7800 terminal are available with an external housing made of plastic that is specifically designed for the healthcare industry. For more information, see [Healthcare Housing](#) on page 3-11.

Peripherals for the 7800 Android

Each of the following items is sold separately to enhance the capabilities of your Dolphin terminal.

Note: The Dolphin 7800 terminal with Android mobile device platform does not support ethernet communication.

Dolphin 7800 HomeBase Device

The Dolphin 7800 HomeBase device is a charging and communication cradle equipped with a USB host port that is Hi-Speed 2.0v compliant, which enables the terminal to interface with the majority of PC-based enterprise systems. This device also contains an auxiliary battery well that charges a spare Honeywell standard or extended battery pack.

For more information, see [Dolphin 7800 HomeBase Device \(Model 7800-HB\)](#) on page 11-1.

Dolphin 7800 Mobile Base Device

The Dolphin 7800 Mobile Base device is a charging and communication cradle designed specifically for in-premise and in-transit data collection applications. It features a flexible mounting bracket and a cigarette lighter adapter to adapt it to your environment.

For more information, see [Dolphin 7800 Mobile Base Device \(Model 7800-MB\)](#) on page 12-1.

Dolphin 7800 ChargeBase Device

The Dolphin 7800 ChargeBase is a 4-slot charging cradle that holds, powers, and charges terminals.

For more information, see [Dolphin 7800 ChargeBase Device \(Model 7800-CB\)](#) on page 13-1.

Dolphin 7800 QuadCharger Device

The Dolphin 7800 QuadCharger device is a 4-slot charging station for Dolphin 7800 standard or extended battery packs.

For more information, see [Dolphin 7800 QuadCharger Device \(Model 7800-QC\)](#) on page 14-1.

Accessories for the 7800 Android

Each of the following items is sold separately to enhance your terminal's capabilities.

Note: When using accessories where the terminal is worn on the body, the terminal's touch panel must face away from the body.

Dolphin 7800 Mobile Charger

The Dolphin 7800 Mobile Charger (Model 7800-MC) is a charging cable that connects the terminal directly to a 12 Volt DC power source, such as a cigarette lighter port inside a vehicle, eliminating the need for a cradle. Intelligent battery technology on-board the terminal ensures proper charging. The Dolphin 7800 Mobile Charger is an ideal low-cost charging solution for in-transit mobile applications.

Communication/Charging Cable

The Dolphin communication/charging cable kit (Model 7800-USB) is an all-in-one solution for mobile applications. The cable kit powers the terminal, charges its main battery, and communicates with host device without the need for a cradle. The communication cable supports USB host communication.

Storage Holster

The storage holster provides convenient storage for the Dolphin terminal in mobile environments. The holsters feature a belt loop to secure the holster to a belt.

Stylus Kits

Each Dolphin is shipped with a stylus and a stylus tether used to secure the stylus to the terminal to prevent loss. Kits containing three styli and three tethers are available for purchase.

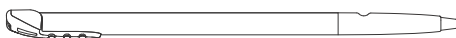

Battery Pack

The rechargeable battery pack provides the main power for the terminal. For more information, see [Batteries](#) on page 3-11.

Front Panel: 7800 Android

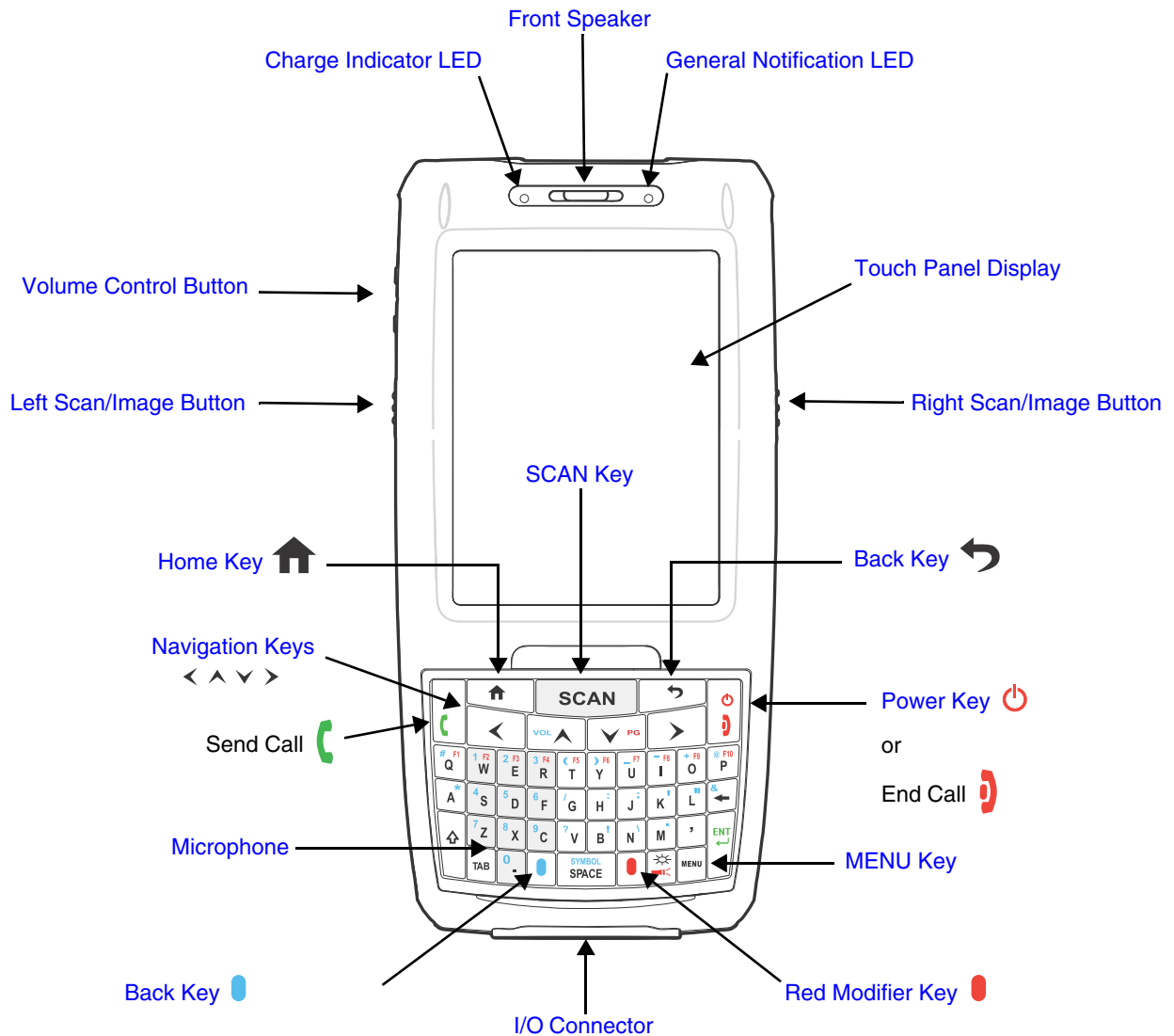

Note: Your Dolphin model may differ from the model illustrated; however, the features noted are standard for all 7800 Android models unless otherwise indicated. For a complete overview of the optional keyboards available for the 7800 Android, see [Using the Keyboards](#) on page 6-1.

For a description of each callout, see [Front Panel Features for the 7800 Android](#) on page 3-5.

Front Panel Features for the 7800 Android

Back Key

Press the Back key ↶ return to the previous screen.

Blue Modifier Key

See [Using the Modifier Keys](#) on page 6-2.

Charge Indicator LED

The light emitting diode (LED), located to the left of the speaker above the LCD display, flashes red when the device is connected to AC power and the battery is charging.

Front Speaker

The front speaker, located above the LCD display, is the receiver for handset voice calls. See [Using the Dolphin as a Phone](#) on page 9-2.

General Notification LED

The light emitting diode (LED) located to the right of the speaker above the LCD display, flashes and illuminates during resets, scanning/imaging, and taking a picture.

Home Key

To return to the Home screen from any open application screen, press the Home key ⬆ on the keyboard or tap ⬆ on the touch screen.

Left Scan/Image Button

By default, the Left Button triggers the scanner/imager when running the Scan Demo application or Scan Wedge application. You can customize the button in your own applications.

MENU Key

Press the MENU button to access options relevant to the open application.

Microphone

The integrated microphone that provides audio input for handset and speakerphone voice calls. See [Using the Dolphin as a Phone](#) on page 9-2.

Navigation Keys

The centrally located navigation keys enable you to move and position the cursor through software programs. The up and down arrows are programmed to perform specific functions when pressed in combination with the Blue modifier key. For more details, see [Using the Navigation Keys](#) on page 6-3.

Power Key

The Power key, located in the upper right corner of the keypad, places the terminal in Suspend Mode or wakes the terminal from Suspend Mode. See [Suspend Mode](#) on page 2-9. The key is also used to end/disconnect a phone calls.

There are multiple keyboard options available for the 7800. For a complete overview of each keyboard, see [Using the Keyboards](#) on page 6-1.

Red Modifier Key

See [Using the Modifier Keys](#) on page 6-2.

Right Scan/Image Button

By default, the Right Button triggers the scanner/imager when running the Scan Demo application or Scan Wedge application. You can customize the button in your own applications.

SCAN Key

The SCAN key is centrally located for easy access with the right or left hand. When pressed, the SCAN key activates the scanner/imager. The SCAN key also functions as a system wake-up control for the terminal.

Touch Panel Display

The color 3.7 inch 64k color liquid crystal display (LCD) touch panel is covered with an industrial, protective lens for greater durability. The video graphic array (VGA) display resolution is 480 X 640.

To conserve battery power the touch screen dims then darkens automatically after a period of no activity. Press the **Power** button, then drag the unlock icon to the right or press the **Menu** key to wake the terminal and access the last screen viewed. See [Display Settings](#) on page 7-3 for information on how to adjust [Screen Timeout](#) settings.

The touch panel can be activated by the stylus (included with the terminal). For more information, see [Using the Touch Panel](#) on page 3-10.

Volume Control Button

Press the top (up arrow) or the bottom (down arrow) of the volume button on the left side of the terminal to raise or lower the volume of the active speaker.

Back Panel: 7800 Android

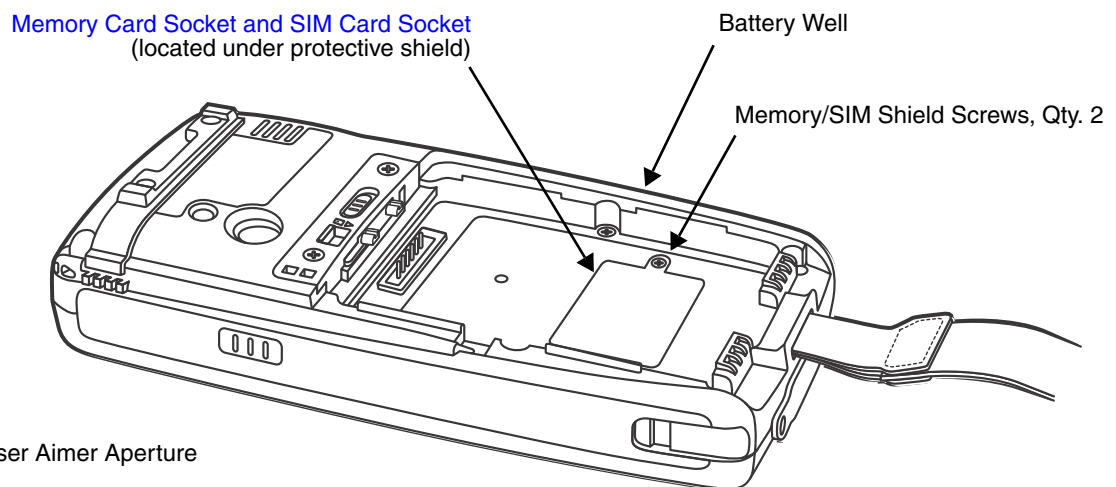
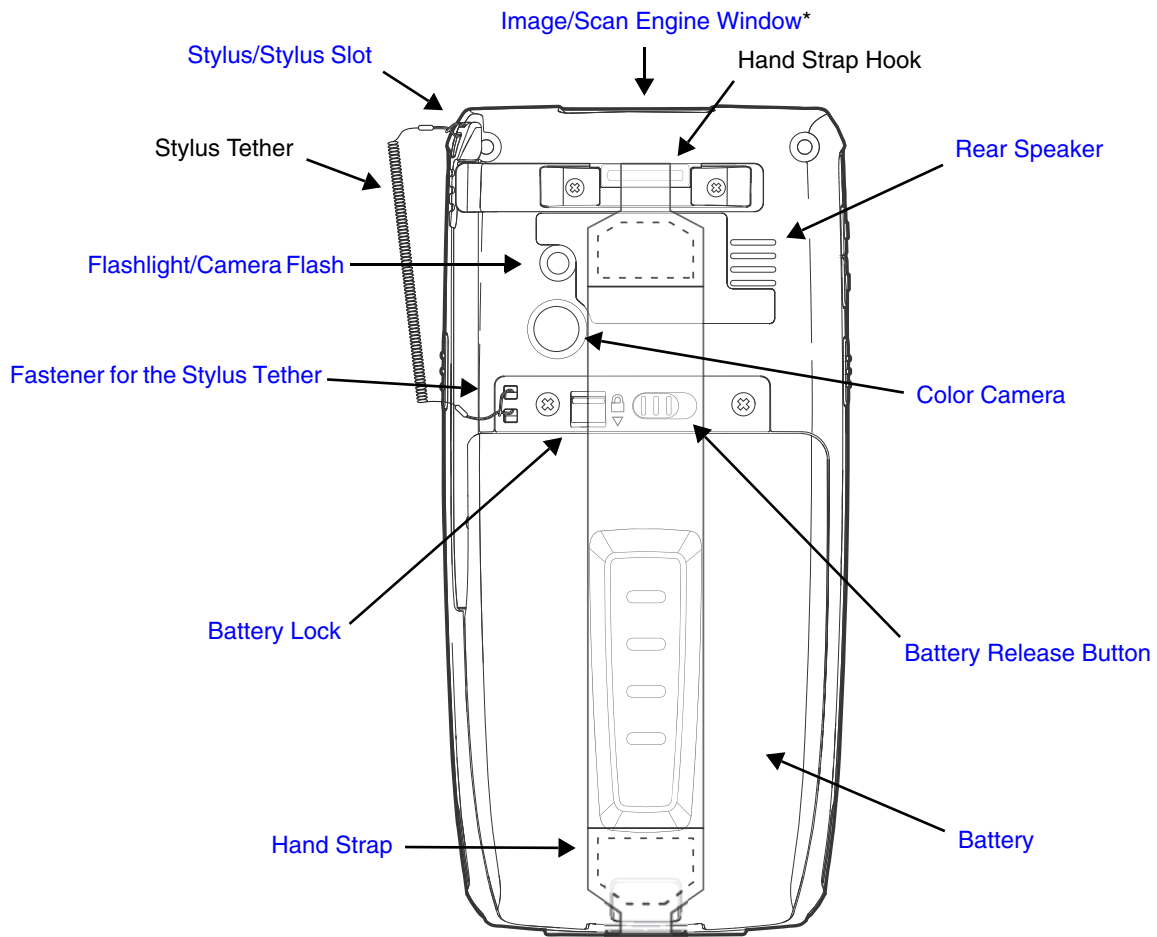

* LED and Laser Aimer Aperture

Note: Your Dolphin model may differ from the model illustrated; however, the features noted are standard for all 7800 Android models unless otherwise indicated.

For a description of each callout, see [Back Panel Features for the 7800 Android](#) on page 3-8.

Back Panel Features for the 7800 Android

Battery

Dolphin 7800 model terminals are designed for use with standard battery pack model 7800-BTSC (Li-ion 3.7 V, 8.9 watt hour) and extended battery pack models 7800-BTXC and 7800-BTXCW (Li-ion 3.7 V, 14.8 watt hour) manufactured for Honeywell International Inc. For information on how to remove the battery, see [Replacing the Main Battery Pack](#) on page 2-9.

Battery Lock

The Battery Lock allows the user to lock the battery pack in place preventing battery loss due to accidental activation of the battery release. The battery release button has no effect if the Battery lock is engaged. The terminal does not power ON unless the Battery Lock is engaged.

Battery Release Button

The Battery Release Button ejects one end the battery from the terminal for easy battery removal. The battery release button has no effect if the Battery lock is engaged. For information on how to remove the battery, see [Replacing the Main Battery Pack](#) on page 2-9.

Color Camera

The 3.0-Megapixels Resolution color camera provides easy picture capture with Automated Camera Control (ACC). Additional features include automated picture profiles and an Application Programming Interface (API).

Fastener for the Stylus Tether

The Stylus Tether helps prevent accidental loss when the stylus is not stored in the stylus slot. A stylus tether is a coiled, elastic cord that tethers the stylus to the terminal. Secure one end of the cord to the back panel of the terminal and the other end to the stylus.

Flashlight/Camera Flash

The flashlight/camera flash is located on the back panel of the terminal. When used as a Flashlight, press the Red key +  key to turn the flashlight ON or OFF. When used as a Camera Flash with the terminal's color camera, the flash is controlled by the camera application.

Hand Strap

The 7800 comes with an elastic hand strap. One end of the hand strap can be released to provide easy access to the battery pack. The hand strap release hook is located near the speaker on the back panel of the terminal.

Image/Scan Engine Window

The available image engines read and decode linear, stacked linear (e.g., PDF417), and 2D matrix bar code symbologies. Some of the available engine models contain a laser aimer for greater accuracy. The laser apertures for the imaging engines' laser aimers are contained behind this window. For more details, see [Using the Scan Image Engine](#) on page 4-1.

Memory Card Socket and SIM Card Socket

The memory card socket and Subscriber Identity Module (SIM) socket are located under the main battery in the battery well. The memory card socket provides the user with the option to expand the terminal's memory capacity using microSD™ or microSDHC™ memory interfaces.

An industrial grade microSD memory card is included and pre-installed in your Dolphin 7800 Android device. Honeywell recommends the use of industrial grade microSD or microSDHC memory cards with Dolphin terminals for maximum performance and durability. Contact a Honeywell sales representative for additional information on qualified memory card options.

Note: Applications on your 7800 Android terminal utilize the microSD card to store files and application data. To avoid errors or possible data loss, do not operate the device without a memory card installed.

The memory card socket and Subscriber Identity Module (SIM) socket are located under the main battery in the battery well. When the protective SIM/memory card cover and battery pack are properly installed, the cards are sealed against moisture and particle intrusion, read/write data is stored securely, and the terminal's environmental rating is preserved; see [Installing a SIM Card and/or Replacing the Memory Card](#) on page 3-15.

Rear Speaker

The integrated rear speaker sounds audio signals as you scan bar code labels and enter data. The integrated speaker also supports playback of wave and MP3 files, software mixer, and Speakerphone for WWAN/GSM audio. The operating frequency range is 600-3000Hz at >90dB.

Stylus/Stylus Slot

The stylus is used to operate the touch panel. The back panel of the terminal features a storage slot to hold the stylus when not in use. The stylus features a special tip for added accuracy and ease of use.

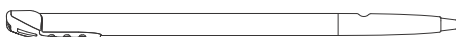

Bottom Panel: 7800 Android

Pin	Description
1	PWR
2	PWR
3	USB1 HOST D-
4	USB1 HOST 5V OUT
5	USB1 HOST D+
6	A_GND
7	USB Client D+
8	USB Client VBUS
9	USB Client D-
10	GND
11	GND

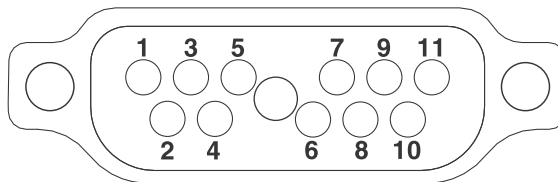

Note: Signals referenced are for a DTE device.

I/O Connector

The I/O connector powers the terminal, charges the main battery, and facilitates communication. All Dolphin peripherals are designed to work exclusively with this connector. The I/O connector supports high speed USB v2.0 communication with a maximum rate of 480 Mbps.

Using the Touch Panel

Honeywell defines proper use of the terminal touch panel as using a screen protector and proper stylus. Screen protectors maintain the ongoing integrity (i.e., prevent scratching) of the touch panel, which is why their use is recommended for applications that require a high to medium level of interface with the touch panel, such as signature capture for proof of delivery.

Honeywell advocates the use of screen protectors on all Dolphin devices. We recommend implementing a screen protector replacement program to ensure that screen protectors are replaced periodically when signs of damage/wear are noticeable.

Replacement screen protectors can be purchased directly from Honeywell. Please contact a Honeywell sales associate for details.

Honeywell also mandates use of a proper stylus, which is one that has a stylus tip radius of no less than 0.8 mm. Use of the Honeywell stylus included with the terminal is recommended at all times.

Honeywell warranty policy covers wear on the touch panel for the first twelve (12) months if a screen protector is applied and an approved stylus is used for the 12 month duration covered by the warranty.

Installing a Screen Protector

Dolphin terminals ship with a screen protector already installed. You will need to replace the screen protector at regular intervals.

1. After the current screen protector has been removed from the touch panel, clean the touch panel thoroughly with a clean, non-abrasive, lint-free cloth. Make sure there is no debris on the touch panel.
2. Align the exposed section of the protector with the edge of the touch panel. Make sure that the screen protector is flush with edges of the touch panel. To reposition, lift up gently and reapply.
3. Press the screen protector firmly and carefully across the surface of the touch panel as you peel away the backing.
4. If necessary, smooth out any air pockets or bumps.

Healthcare Housing

Some configurations of the 7800 terminal are available with an external plastic housing that is designed to resist the effects of harsh chemicals in a healthcare environment. The plastic is crystalline in nature, which helps prevent chemicals from seeping through the housing.

Important! The following cleaning solutions have been tested to assure safe cleaning of your terminal's disinfectant-ready housing. They are the only solutions approved for use with these terminals. Damage caused by the use of cleaners other than those listed below may not be covered by the warranty.

- Sani-Cloth® Plus wipes
- Gentle dish soap and water

Batteries

There are two types of battery power: the main battery pack installed in the back panel and the backup battery located inside the terminal. They are designed to work together to prevent data loss when the terminal is in use over long periods.

Both batteries must be completely charged before using a Dolphin terminal for the first time!

Main Battery Pack

 *We recommend use of Honeywell Li-ion battery packs. Use of any non-Honeywell battery may result in damage not covered by the warranty.*

Dolphin 7800 model terminals are designed for use with standard battery pack model 7800-BTSC (Li-ion 3.7 V, 8.9 watt hour) and extended battery pack models 7800-BTXC and 7800-BTXCW (Li-ion 3.7 V, 14.8 watt hour) manufactured for Honeywell International Inc.

 **CAUTION** - Read the [Guidelines for Battery Pack Use and Disposal](#) on page 3-13 and all cautionary markings on the battery, charging peripheral, or device using the battery before attempting to install, use, or charge the battery. **Risk of fire and burns if improperly handled. Do not open, crush, heat above 60°C (140°F), or incinerate.**

Charging Options

When the main battery pack is installed in the terminal, use one of the following peripherals:

- [Dolphin 7800 HomeBase Device \(Model 7800-HB\)](#), see page 11-1
- [Dolphin 7800 Mobile Base Device \(Model 7800-MB\)](#), see page 12-1
- [Dolphin 7800 ChargeBase Device \(Model 7800-CB\)](#), see page 13-1
- [Dolphin 7800 Charging/Communication Cable \(Model 7800-USB\)](#), see page 2-2

When the main battery pack is not installed in the terminal:

- Place the battery pack in the [Dolphin 7800 QuadCharger Device \(Model 7800-QC\)](#), see page 14-1
- Place the battery pack in the [Auxiliary Battery Well](#) of the [Dolphin 7800 HomeBase Device \(Model 7800-HB\)](#), see page 11-1.

For information on how to remove the main battery pack from the terminal, see [Replacing the Main Battery Pack](#) on page 2-9.

Charging Time

The standard battery pack requires 4 hours to charge completely before initial and the extended battery pack requires 6 hours to charge completely before initial use.

Honeywell recommends charging the Dolphin terminal for at least 24 hours prior to initial use to ensure the internal backup battery is fully charged.

Checking Battery Power

Tap  > **Settings** > **About phone** > **Status** to display the battery charge level.

Monitoring Battery Power Use

Tap  > **Settings** > **Applications** > **Battery Use** to monitor and adjust battery usage.

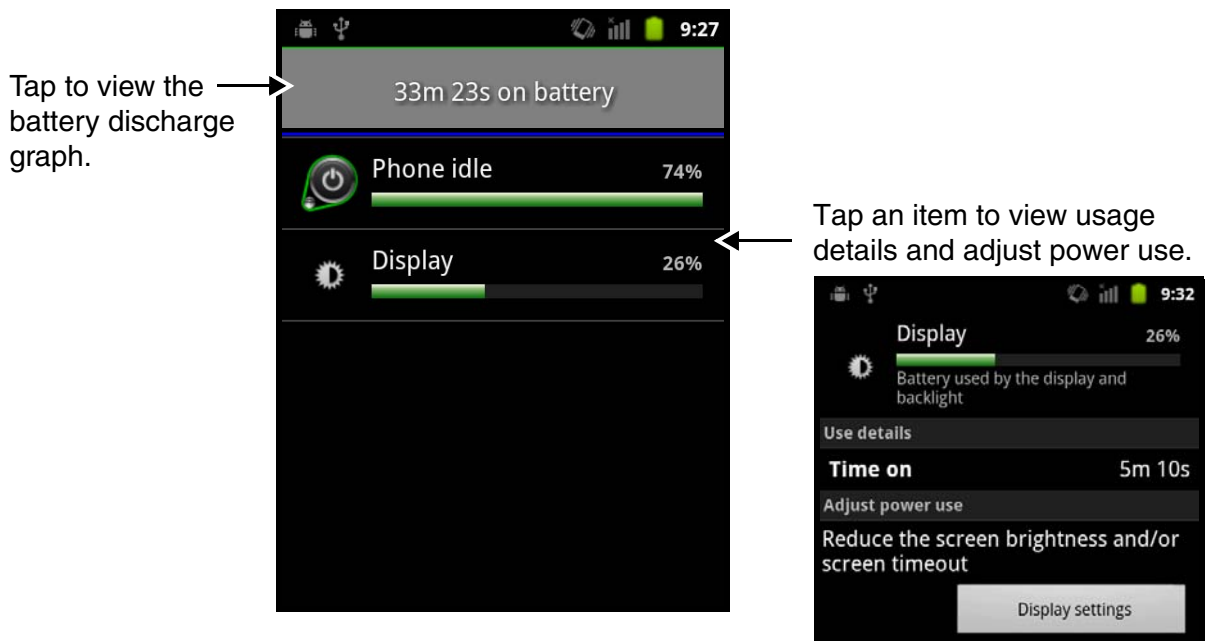

Storing Batteries

To maintain top performance from batteries, avoid storing batteries outside of the following temperature ranges:

- 14°F to 113°F (-10°C to +45°C) for short term storage of less than one month
- 32°F to 86°F (-0°C to +30°C) for long term storage

Do not store batteries in extremely high humidity. For prolonged storage, do not keep batteries stored in a charger that is connected to a power source.

Guidelines for Battery Pack Use and Disposal

The following are general guidelines for the safe use and disposal of batteries:

- Do not disassemble or open crush, bend or deform, puncture or shred.
- Do not modify or remanufacture, attempt to insert foreign objects into the battery, immerse or expose to water or other liquids, expose to fire, explosion or other hazard.
- Improper battery use may result in a fire, explosion or other hazard.
- We recommend use of Honeywell Li-ion battery packs. Use of any non-Honeywell battery may pose a personal hazard to the user.
- Only use the battery for the system for which it is specified. Do not use a battery in any other manner outside its intended use in Dolphin terminals and peripherals.
- Only use the battery with a charging system that has been qualified with the system per standard IEEE-Std-1725-2006. Use of an unqualified battery or charger may present a risk of fire, explosion, leakage, or other hazard.
- Replace the battery only with another battery that has been qualified with the system per this standard, IEEE-Std-1725-2006. Use of an unqualified battery may present a risk of fire, explosion, leakage or other hazard.
- Replace defective batteries immediately; using a defective battery could damage the Dolphin terminal.
- Never throw a used battery in the trash. Promptly dispose of used batteries in accordance with local regulations.
- Do not short-circuit a battery or throw it into a fire; it can explode and cause severe personal injury. Do not allow metallic conductive objects to contact battery terminals.
- If you observe that the Honeywell battery supplied is physically damaged, please send it to Honeywell International Inc. or an authorized service center for inspection, see [Product Service and Repair](#) on page 15-1.
- Avoid dropping the terminal or battery. If the terminal or battery is dropped, especially on a hard surface, and the user suspects damage, send it to a Honeywell International Inc. or an authorized service center for inspection.
- If you are not sure the battery or charger is working properly, send it to Honeywell International Inc. or an authorized service center for inspection, see [Product Service and Repair](#) on page 15-1.
- Excessive discharge can degrade battery performance. Recharge the battery when your terminal indicates low battery power.
- Although your battery can be recharged many times, the battery life is limited. Replace it after the battery is unable to hold an adequate charge.

Internal Backup Battery

Located inside the terminal is a 3.6 Volt nickel metal hydride (NiMH) backup battery. The backup battery prevents the terminal from being reset if you need to replace the main battery pack. It retains RAM data during the battery pack exchange. A fully charged backup battery provides 5 minutes of data backup time.

Note: A fully charged backup battery preserves RTC content for approximately 168 hours when the terminal is in suspend mode and the main battery is not installed or completely depleted of charge.

If at any time the backup battery becomes fully discharged of power (e.g., the terminal is left without the main battery pack for more than 5 minutes), the terminal resets when power is supplied. All files are retained, but you may need to restart any running applications. In addition, a fully discharged backup battery requires a minimum of 24 hours of charging time to reach a full charge.

Note: Data and programs stored in Flash memory are not lost even if the internal backup battery fails.

Charging

The internal backup battery is powered by the main battery pack. Therefore, charging the internal battery requires a charged main battery pack be installed in the terminal and the terminal be connected to a charging device.

The internal backup battery must be fully charged before using the terminal for the first time. Honeywell recommends charging the Dolphin terminal for at least 24 hours prior to initial use to ensure the internal backup battery is fully charged. After that, if the internal backup battery becomes fully discharged of power, it requires a minimum of 24 hours of charging time to function normally.

Guidelines for Use

Follow these guidelines to maximize the life of the internal backup battery:

- Keep a charged battery pack in the terminal; the backup battery prematurely discharges if there is not at least a partially charged battery in the terminal.
- Keep the terminal connected to power when the terminal is not in use.

Managing Battery Power

Letting the backup battery become fully discharged causes the terminal to lose all data in RAM. Honeywell recommends, you keep a charged battery pack in the terminal at all times to help prevent data loss. The internal battery discharges prematurely if there is not at least a partially charged battery in the terminal. When you remove a battery pack, insert another charged battery pack in the terminal immediately.

Critical and Low Battery Points

When the terminal is running on battery power (as opposed to external power), warnings are displayed when the battery reaches critical and low battery points.

System Resets

See [Resetting the Terminal](#) on page 2-10.

Hardware Maintenance

When needed, clean the image engine window and the LCD display with a clean, non-abrasive, lint-free cloth. The terminal can be cleaned with a damp cloth. For additional information on hardware maintenance specific to the Dolphin Healthcare Housings, [see page 3-11](#).

Installing a SIM Card and/or Replacing the Memory Card

SIM Card

Short for Subscriber Information Module, a SIM card stores the subscriber's personal information, GSM/GPRS radio settings, security keys, contacts, etc. SIM cards can be installed in compatible mobile devices, enabling you to switch devices without losing personal and setup information.

Before installing the SIM card:

- The service provider **must** activate the SIM card.
- The terminal **must** be powered down.

Note: If no SIM card is installed, you can still make emergency phone calls (e.g., 9-1-1).

Memory Card

A microSD memory card is included and pre-installed in your Dolphin 7800 Android device.

Note: Do not operate the 7800 Android without a memory card installed. Some applications running on your device utilize the additional capacity of the memory card. A missing card could cause application errors or a loss of data.

The memory card socket provides the user with the option to expand the terminal's memory capacity using industrial grade microSD or microSDHC memory interfaces. Contact a Honeywell sales representative or go to www.honeywellaidc.com for details on purchasing optional memory cards for your Dolphin terminal.

Note: Format all microSD/SDHC cards before initial use.

Installation and/or Replacement

Note: Honeywell recommends unmounting the microSD card to prevent possible data corruption or damage to the card during replacement. Never attempt to replace the microSD card unless you have placed the terminal in Suspend mode. See [Unmount/Mount the micorSD card](#) on page 7-11.

1. Press the Power key  to put the terminal in [Suspend Mode](#) (see page 2-9).
2. Release the hand strap and slide battery latch away from the battery into the unlock position.
3. **Wait at least 3 seconds.** Slide the battery release button away from the stylus slot, then remove the battery.
4. Remove the screws and the protective shield covering the SIM/memory card socket.
5. Unlock the SIM card latch by sliding the latch toward the stylus slot.

-
- Lift the latch to reveal the SIM socket and the memory card latch.

Note: If a SIM card is installed, remove the card to reveal the memory card latch.

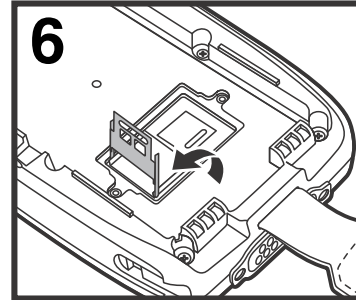
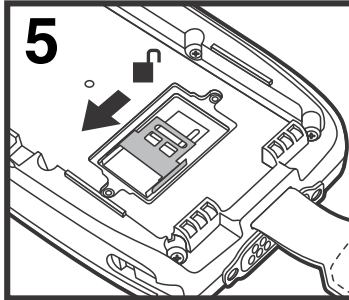
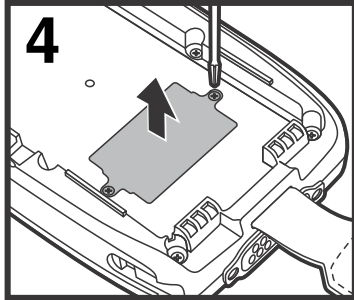

If you are not replacing the memory card (i.e., microSD or MicroSDHC card), skip to step 11.

- Unlock the memory card latch by sliding the latch toward the top of the terminal.
- Lift the latch and remove the memory card.
- Insert the new microSD or microSDHC card.

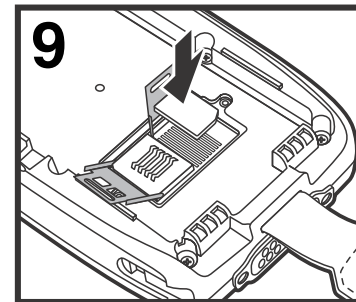
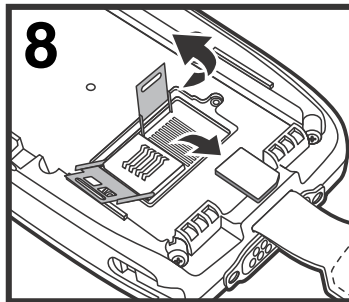
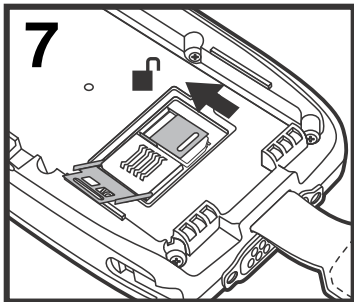

Note: Do not operate the 7800 Android without a memory card installed. Some applications running on your device utilize the additional capacity of the memory card. A missing card could cause application errors or a loss of data.

- Close and lock the memory card latch.

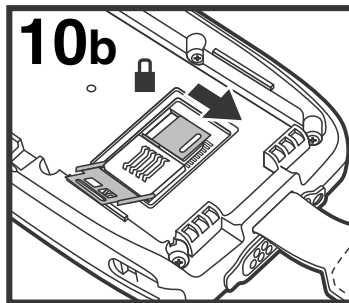
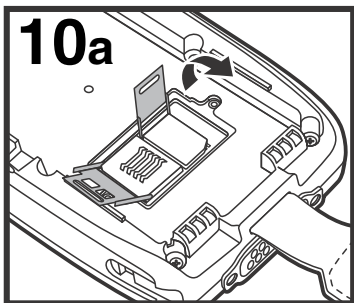

- Insert the SIM card. Align the chamfered corner of the card with the chamfered corner of the socket.

12. Close and lock the SIM card latch.

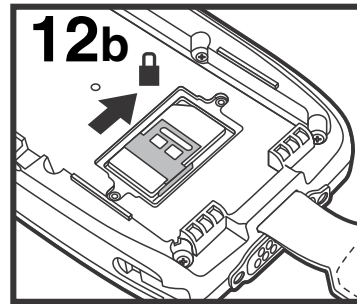
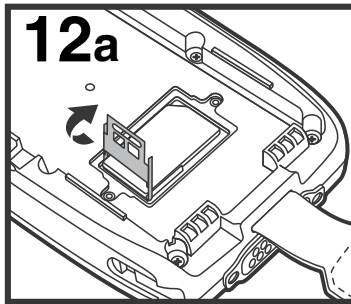
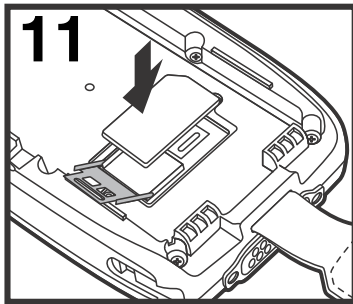

13. Reinstall the shield and screws to protect the sockets.

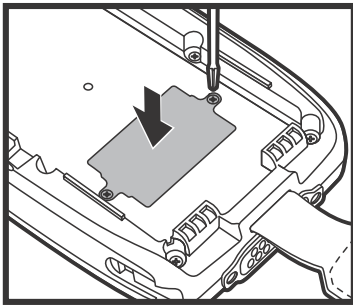

14. Install and lock the battery. The terminal automatically starts the power up sequence.

Note: The terminal does not power ON unless the battery lock is engaged.



Using the Scan Image Engine

Overview

The Dolphin terminal houses a compact image engine that instantly reads popular 1D and 2D bar codes and supports omni-directional aiming and decoding for greater flexibility in real-world settings. The image engine can also capture black and white digital images, such as signatures and pictures of damaged inventory.

With the latest CMOS-based technology, the engine works like a digital camera and enables black and white digital image capture, signature capture, and reading of OCR characters.

Laser Safety

See [Laser Safety](#) on page 1-1.

N5603 Beam Divergence Angle

Engines	Horizontal Beam Divergence Angle (degrees)	Vertical Beam Divergence Angle (degrees)
N5603SR/HD	18.1	14.3
N5603ER	13.1	9.9

LED Safety

See [LED Safety](#) on page 1-2.

Image Engine Specifications

Engines	1D	2D	Image Capture	Aiming Pattern	Omni-Directional Aiming
N5603SR/ER/HD	Y	Y	Y	N5603 Red High-Vis Aiming Pattern (page 4-9)	Y
N5600SR/ER/HD	Y	Y	Y	N5600 Green Aiming Beam (page 4-9)	Y

Depth of Field

The depth of field measurements used the following parameters:

- Distances are measured from the front of the engine.
- +23°C (+73°F), 0 lux
- Photographic quality codes

Focus	N5603/N5600 High Density (HD)			N5603/N5600 Standard Range (SR)			N5603/N5600 Extended Range (ER)		
	Distance (in/cm)		Delta (in/cm)	Distance (in/cm)		Delta (in/cm)	Distance (in/cm)		Delta (in/cm)
	Near	Far		Near	Far		Near	Far	
3 mil C39/128	2.0 (5.1)	3.4 (8.6)	1.4 (3.6)	-	-	-	-	-	-
5 mil C39/128	1.4 (3.6)	4.8 (12.2)	3.4 (8.6)	2.7 (6.9)	6.3 (16.0)	3.6 (9.1)	5.4 (13.7)	9.0 (22.9)	3.6 (9.1)
7.5 mil C39/128	1.4 (3.6)	5.6 (14.2)	4.2 (10.7)	2.5 (6.4)	9.2 (23.4)	6.7 (17)	4.2 (10.7)	12.6 (32.0)	8.4 (21.3)
10 mil C39/128	1.4 (3.6)	5.5 (14.0)	4.1 (10.4)	1.6 (4.1)	13.2 (33.5)	11.6 (29.5)	3.1 (7.9)	17.2 (43.7)	14.1 (35.8)
15 mil C39/128	2.6 (6.5)	7.8 (19.8)	6.5 (16.5)	3.2 (8.0)	19.0 (48.3)	17.2 (43.7)	4.2 (10.7)	20.9 (53.1)	18.5 (47.0)
20 mil C39/128	2.3 (5.8)	9.2 (23.4)	6.9 (17.5)	2.2 (5.6)	20.1 (51.1)	17.9 (45.5)	4.3 (10.8)	24.0 (61.0)	21.1 (53.6)
100% UPC	1.9 (4.8)	7.1 (18)	5.2 (13.2)	1.8 (4.6)	16.5 (41.9)	14.7 (37.3)	2.7 (6.9)	19 (43.3)	16.3 (41.4)
6.7 mil PDF417	1.4 (3.6)	4.8 (12.2)	3.4 (8.6)	2.0 (5.1)	6.5 (16.5)	4.5 (11.4)	4.7 (11.9)	9.8 (24.9)	5.1 (13.0)
10 mil PDF417	1.7 (4.3)	6.2 (15.7)	4.5 (11.4)	1.5 (3.8)	11.0 (27.9)	9.5 (24.1)	2.4 (6.1)	15.0 (38.1)	12.6 (32.0)
5 mil Data Matrix	1.9 (4.8)	3.1 (7.9)	1.2 (3.0)	-	-	-	-	-	-
10 mil Data Matrix/Aztec	1.7 (4.3)	5.3 (13.5)	3.6 (9.1)	2.2 (5.6)	7.9 (20.1)	5.7 (14.5)	5.1 (13.0)	10.5 (26.7)	5.4 (13.7)
20 mil Data Matrix	2.1 (5.3)	7.8 (19.8)	5.7 (14.5)	2.0 (5.1)	15.3 (38.9)	13.3 (33.8)	3.6 (9.1)	18 (45.7)	14.4 (36.6)
10 mil QR	3.3 (8.4)	5.0 (12.7)	1.7 (4.3)	2.2 (5.6)	7.1 (18.0)	4.9 (12.4)	4.3 (10.9)	10.6 (26.9)	6.5 (16.5)
20 mil QR	2.2 (5.6)	7.9 (20.1)	5.7 (14.5)	2.2 (5.6)	15.5 (39.4)	13.3 (33.8)	2.4 (6.1)	19.6 (49.8)	17.6 (44.7)
32 mil Maxicode	2.4 (6.1)	8.6 (21.8)	6.2 (15.7)	2.5 (6.4)	17.0 (43.2)	14.5 (36.8)	3.9 (9.9)	23.2 (58.9)	19.5 (49.5)

Supported Bar Code Symbologies

Symbology Type	Symbology Name
1D Symbologies	Codabar Codablock F Code 3 of 9 Code 11 Code 32 Pharmaceutical (PARAF) Code 93 Code 128 EAN-8 EAN-13 GS1-128 GS1 Databar Interleaved 2 of 5 ISBT 128 Matrix 2 of 5 MSI Plessey Straight 2 of 5 IATA Straight 2 of 5 Industrial Telepen Trioptic Code UPC with Add On UPC-A UPC-E
2D Symbologies	Aztec Codablock F GS1 Databar MaxiCode Micro PDF Data Matrix PDF417 QR Code
Composite Codes	UPC/EAN UCC/EAN GS1 Databar
OCR	OCR-A OCR-B
Postal Codes	Postnet and most international 4-state codes Australian Post British Post Canadian Post China Post Japanese Post KIX (Netherlands) Post Korea Post Planet Code

Decoding

The terminal supports two types of image decoding for use in various bar code reading and imaging applications: full-area imaging and Advanced Linear Decoding (ALD).

Full-Area Imaging

Full-area imaging provides omni-directional reading of linear and non-linear 1D and 2D bar codes, OCR, signature capture, and picture taking. When reading all bar code types using full-area imaging, a positive read can be obtained from many positions; see [Aiming Beam Options](#) on page 4-9. To achieve the best read, the aiming beam should be centered horizontally across the bar code.

ALD

ALD provides fast reading of linear and stacked linear bar codes. To achieve a positive read when reading linear 1D and PDF417 bar codes, the aiming beam should be centered horizontally across the bar code. When ALD is enabled, the reader does not read matrix or postal codes.

Using the Scan Demo

1. Tap **Launcher**  > **Demos**  > **ScanDemo**  to open the Scan Demo application.



2. Point the Dolphin terminal at the bar code.

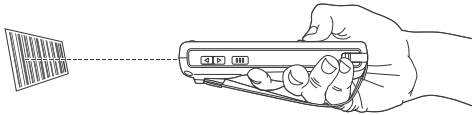

3. Tap and hold **Scan** or press and hold the terminal's SCAN key. Center the aiming beam over the bar code; see [Aiming Beam Options](#) on page 4-9.

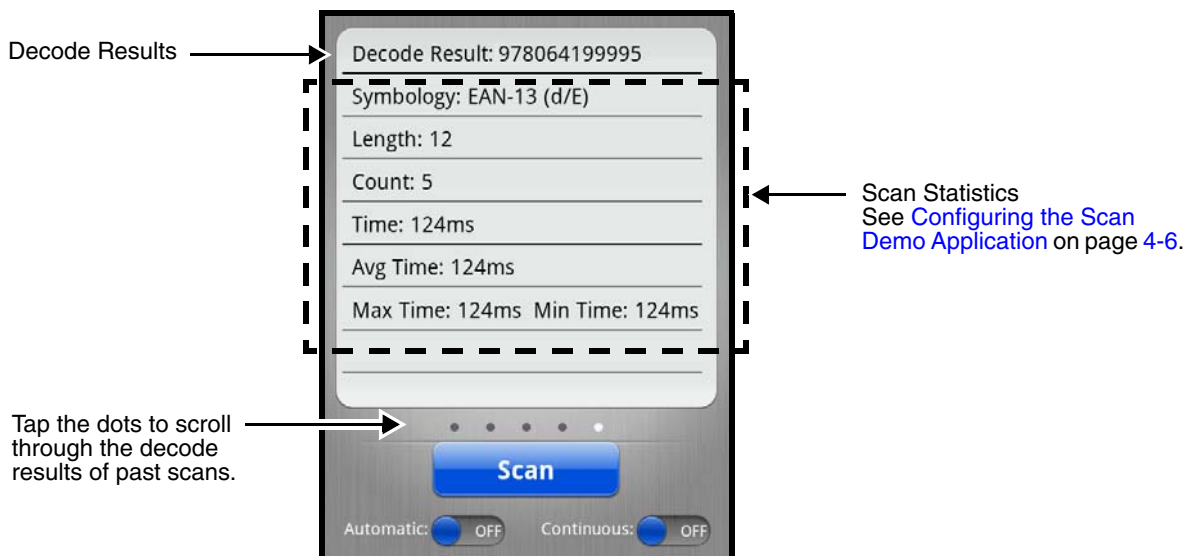

Note: For optimum performance, avoid reflections by scanning the bar code at a slight angle.

4. The bar code is decoded and the results appear on the screen.





Automatic Scanning

Enable **Automatic** scanning mode to activate the imager for continuous scanning without requiring the operator to press the Scan button or SCAN key for each bar code presented in the imager's field of view. To configure the time interval between scan attempts, see **Auto Scan Delay** under [Configuring the Scan Demo Application \(page 4-6\)](#).

1. Slide the Automatic blue button to the ON position to enable the feature.
2. Tap the  button or press the SCAN key to activate the imaging engine and start scanning.
3. The imager automatically scans and decodes bar codes presented in the terminal's field of view.
4. Tap the  button or press the SCAN key to stop scanning and deactivate the imager.
5. Slide the Automatic blue button to the OFF position to disable the feature.



Continuous Scanning

Enable **Continuous** scanning mode to activate the imager for continuous scanning only when the operator taps and holds the Scan button or presses and holds the SCAN Key. The time interval between scan attempts is minimal and not configurable.

1. Slide the Continuous blue button to the ON position to enable the feature.
2. Tap and hold the  button or press and hold the SCAN key to activate the imaging engine and start scanning.
3. The imager scans and decodes bar codes presented in the terminal's field of view.
4. Release the  button or SCAN key to stop scanning and deactivate the imager.
5. Slide the Continuous blue button to the OFF position to disable the feature.

Configuring the Scan Demo Application

1. Open the **Scan Demo** application, then press the **Menu** key.

2. Tap **Setting**  or **Symbology Setting** .

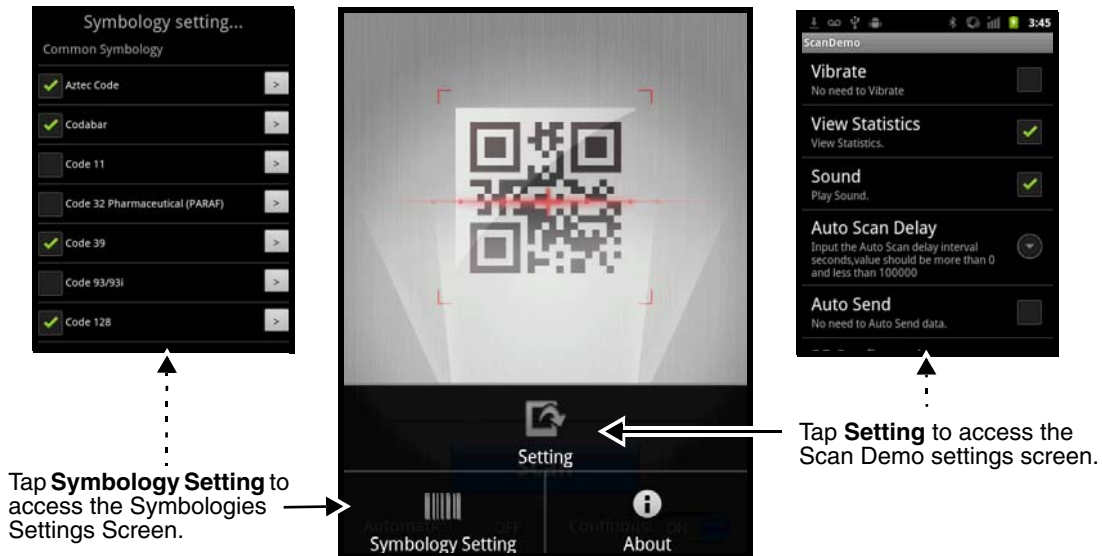

3. Modify the settings to meet your application needs, then press the **Back** key  to return to the Scan Demo screen.

Settings

Tap the checkbox to enable or disable a feature. A green check mark indicates the feature is enabled.

- **Vibrate** - When checked, the terminal vibrates to indicate a successful bar code scan and decode.
- **View Statistics** - When checked, scan results displayed include the length of bar code, the number of scans completed, the number of milliseconds (ms) to decode the bar code, the average decode time of all the bar codes decoded, the shortest decode time of all bar codes decoded, and the longest decode time of all bar codes decoded.
- **Sound** - When checked, the terminal emits sound to indicate a successful or failed scan attempt.
- **Auto Scan Delay** - Program the number of seconds between scan attempts by tapping the menu arrow, then entering the delay interval in second. The value should be greater than 0 and less than 100000. Tap OK to save.
- **Auto Send** - When checked, decoded data is sent to a designated server.
- **RF Configuration** - Tap to view and/or edit the Server IP address and the Port used for RF communication. When the Back key is pressed, the terminal attempts to establish communication.

Symbology Settings

Tap the box next to the symbology name to toggle the symbology on (enable) or off (disable). A green check mark indicates the symbology is enabled.

Note: Swipe up or down with your finger or stylus on the screen to scroll up or down the list of available symbologies.

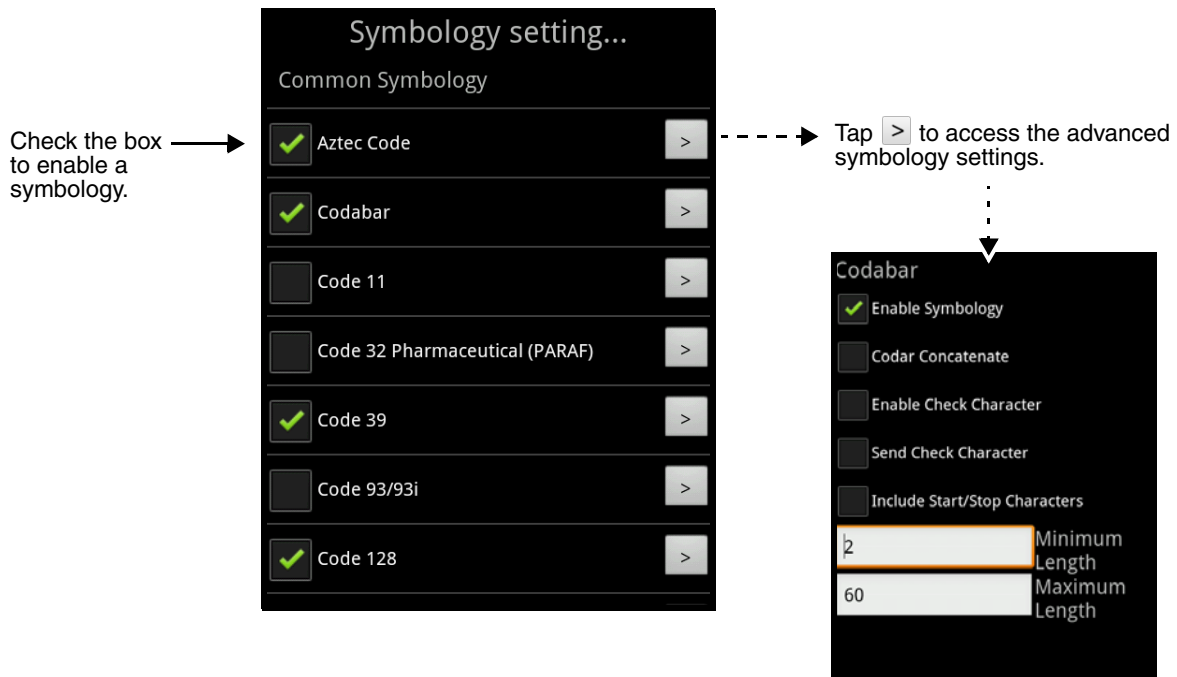

Using the PowerTools ScanTool

1. Tap the **Launcher**  > **PowerTools**  > **ScanTool**  to access the ScanTool menu screen.
2. Tap one of the Quick Start applications.

Quick Start Application	Description
Activity Result	Scan and decode bar codes
Show Result	Scan, decode, and view the results (i.e., bar code type and value)
Share by SMS	Scan, decode, and send the results via SMS
Share by MMS	Scan, decode, and send the results via MMS
Share by Email	Scan, decode, and email the results
Share by Result	Scan, decode, and send the results via Result
Settings	Modifies the imager symbology settings
About	Displays ScanTool version and copyright information

3. The device automatically scans and decodes the bar code when the application is selected.

Symbology Settings Menu

1. Tap the **Launcher**  > **PowerTools**  > **ScanTool** 
2. Tap the **Settings** box.

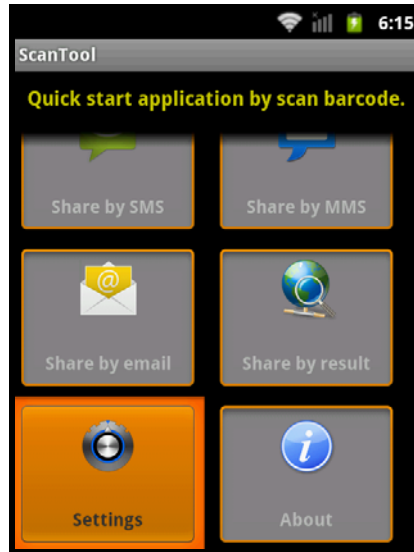

3. Tap the box next to the symbology name to toggle the symbology on (enable) or off (disable). A green check mark indicates the symbology is enabled.

Note: Swipe up or down with your finger or stylus on the screen to scroll up or down the list of available symbologies.

Check the box to enable a symbology. →

Tap > to access the advanced symbology settings.

4. Tap the arrow box to view and modify the advanced settings (e.g. suffix, prefix, minimum and maximum length) for the symbology.

Aiming Beam Options

The aiming beams are smaller when the terminal is held closer to the code and larger when it is farther from the code. Symbologies with smaller bars or elements (mil size) should be read closer to the unit whereas symbologies with larger bars or elements (mil size) should be read farther from the unit. The aiming beam should be oriented in line with the bar code to achieve optimal decoding. A range of 4-10 inches (10-25 cm) from the bar code is recommended.

N5603 Red High-Vis Aiming Pattern

If your Dolphin terminal is configured with a N5603 imager, high-vis aimers frame the bar code for more intuitive aiming. See [Laser Safety](#) on page 1-1.

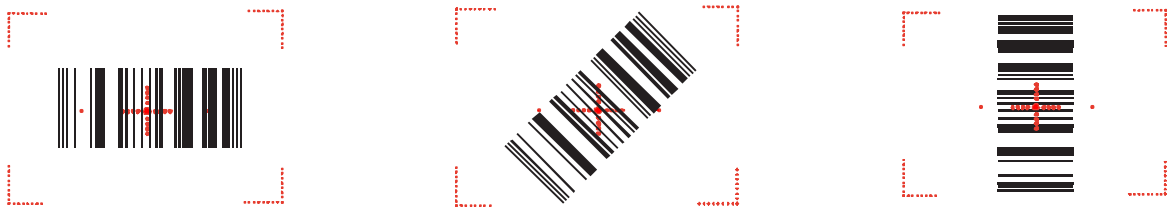

N5600 Green Aiming Beam

Linear Bar Code



2D Matrix Symbol



Capturing Images

The image-capture process is an intuitive, split-second operation for experienced users. By following the basic guidelines, new users can easily develop their own technique and, with practice, quickly learn to adapt it to different application environments.

Image Preview

When the imaging process is initiated, the touch screen displays a preview of the object. This is a live video image of what the imager is currently viewing. The live video image has a slightly degraded appearance compared to the captured image. This is normal.

Scan Key

On all 7800 terminals, the SCAN key captures images.

File Formats

File formats supported for image storage include JPEG (JPG) and Portable Network Graphics (PNG). The default file format for images is a grayscale JPG.

Compression

Digital images have a maximum image size of 832 x 640 pixels and may have up to a 256 grayscale image definition.

The image quality and related file size are determined by the data compression method used by the software application used to take images. The average size of the image file is approximately 400–800K. However, the size of the image depends on the content of the image - the more complex the content, the larger the file size.

Taking an Image with the Imaging Demo

The following steps are basic guidelines for taking images with the ImagingDemo application:

1. Tap **Launcher**  > **Demos**  . > **Imaging Demo** .

Swipe right ►
with your finger or
stylus to scroll to
the **Imaging
Demo** icon.



Tap to open the
application.

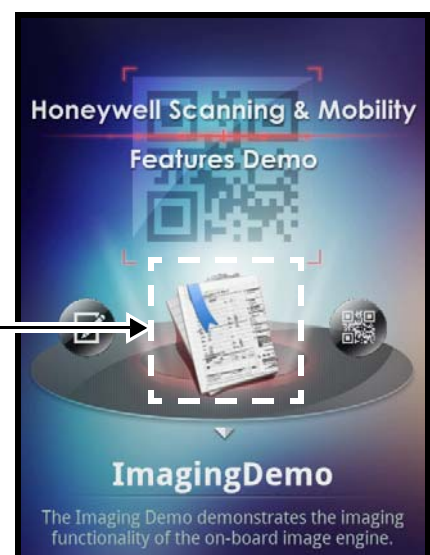

- Point the Dolphin terminal at the object.

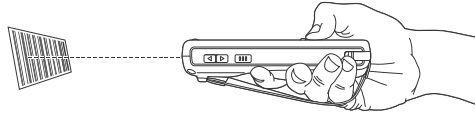

- Adjust the terminal's position until the object appears on the touch screen the way you want it to appear in the image.

Note: Tap the  to toggle the targeting cross hair on the touchscreen on or off.

- Tap  or press the SCAN key to capture the image.
- The captured image appears on the screen.
- To save the captured image, press the **Menu** key.
- Tap **File**, then select:
 - Save** to save the image to the default location: /sdcard/honeywell/imagedemo, or
 - Save As** to select a different location to save the image.

Using the IQImage Demo to decode intelligent bar codes and capture images

The IQ Image Demo decodes intelligent bar codes, inserting the data from the bar code into the appropriate fields on the IQ Image Demo window. In addition, the IQ Image Demo captures an image of the bar code simultaneously. The IQ Image Demo provides four format options: **Delivery**, **Postal**, **Embed**, and **No format**. Each format is designed to decode data from bar codes specifically coded to match the format of the option screen.

- Tap **Launcher**  > **Demos**  > **IQImageDemo** .

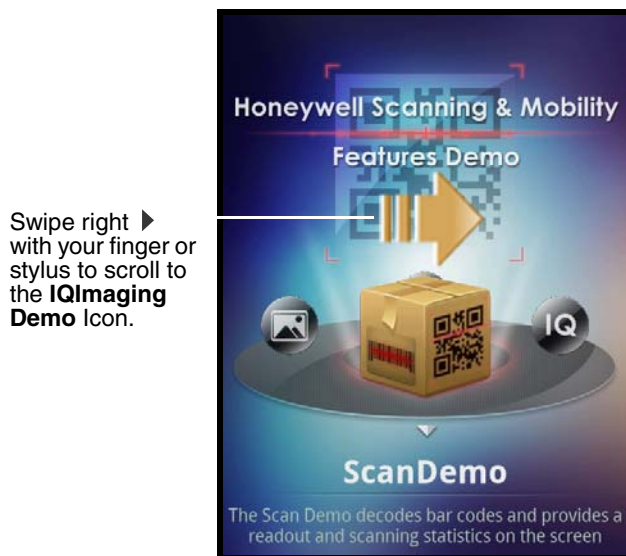

- Tap one of the four format options: **Delivery**, **Postal**, **Embed**, or **No format**.

3. Point the Dolphin terminal at the intelligent bar code.
4. Tap **Scan** or press the **Scan** key.
5. The decode results (e.g., Tracking Number and Address embedded in the bar code) automatically populate the fields on the screen.

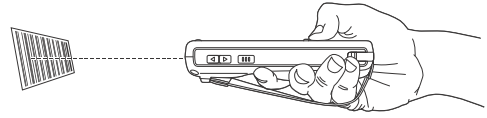

Note: You don't need to clear the field to take another scan, just activate the image engine again.

6. Press the **Menu** key, then tap **File**  to save an image of the scan or bar code. The file is saved in the /sdcard/honeywell/iqdemo folder on the microSD card.

Configuring the IQImage Demo Application

1. Open the **IQImage Demo** application, then tap one of the four configuration options (i.e., Delivery, Postal, Embed or No format).
2. Press the **Menu** key.
3. Tap **Setting**  to access and modify the following options:
 - Select **Symbology** to configure the type of symbologies you want the IQ Imaging Demo to decode. Tap the symbology's checkbox to enable or disable the symbology. Press the back key to return to the IQImaging screen.
 - Select **Image Type** to choose Binary or Grayscale.
 - Select **Sounds** to toggle audible feedback on successful scans on or off.

Using the Signature Demo

The Signature Demo captures a signature on the touch screen.

1. Tap **Launcher**  > **Demos**  > **SignatureDemo**  to open the signature demo screen.

Swipe right ► with your finger or stylus to scroll to the **Signature Demo** icon.

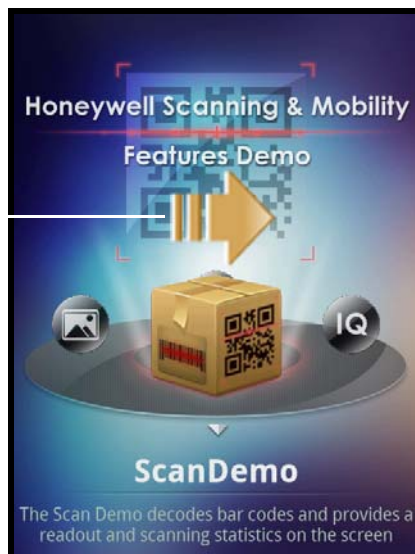

Tap to open the application.



-
- Using the stylus that came with the terminal, sign the touch screen.

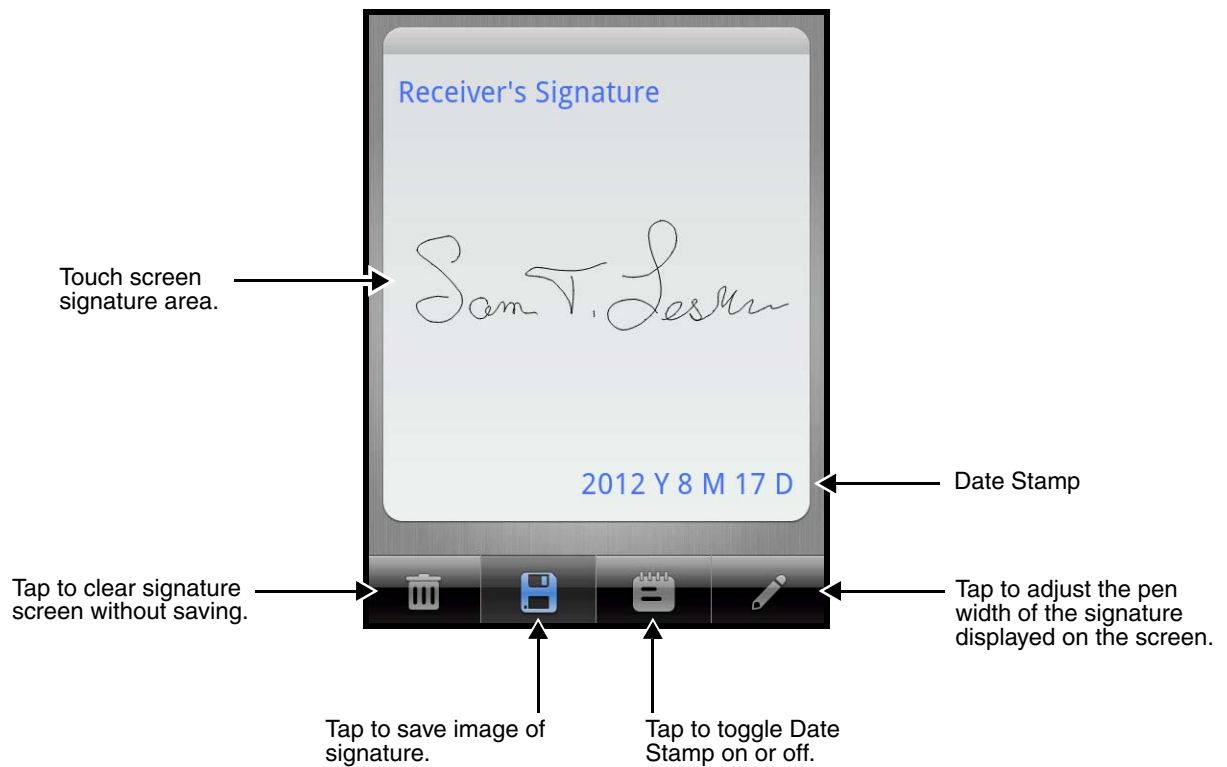

- Tap .
- Enter a **name** for the of the image file you want to save, then select the file type: **JPG** or **PNG**.
- Tap **Save**. The signature image file is saved in the /sdcard/honeywell/signaturedemo folder on the microSD card.

Uploading Images

Image files can be uploaded to a host workstation using a USB connection. See [Connecting the terminal to a workstation via USB](#) on page 2-11.



Using the Color Camera



Overview

Dolphin 7800 terminals equipped with a 3.0-Megapixels Resolution color camera with Automated Camera Control (ACC), and an Application Programming Interface (API) provide easy integration of color picture and video capture into business applications. The camera lens and camera flash are located on the back panel of the terminal.

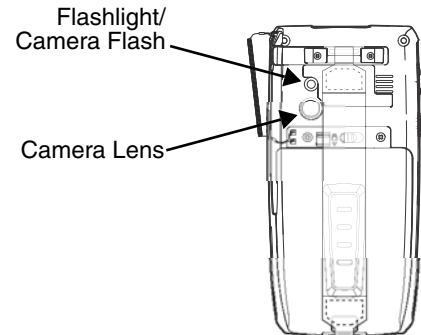
Pictures and videos are stored on the micorSD card in the DCIM folder. You can copy your pictures and videos to a computer, as described in [Connecting the terminal to a workstation via USB](#) on page 2-11 or view, edit and share your pictures and videos using the Gallery application.



Taking a Picture

1. Tap **Launcher**  > **Camera** .
2. Slide the button to the Camera  position.
3. Adjust the camera settings (e.g., exposure, flash, and white balance) or let the camera automatically adjust the settings. The icons change depending on adjusted settings.

Note: The live preview on the screen changes as you adjust the camera settings and the icons change to reflect your selections. See [Changing the Camera Picture Settings](#), for additional information.

4. Point the terminal's camera lens at the object you want to capture. The camera lens is located on the back panel of the terminal.
5. Center the object you want to take a picture of on the live preview screen.

Note: You can zoom in or out by tapping the Zoom icon **1x**, and selecting the zoom level or by double tapping on the live preview screen to Zoom all the way in or out.

6. To take the picture, do one of the following:
 - Tap the Shutter icon  to let the camera automatically focus and take the picture.

OR

 - Tap and hold the Shutter icon  to focus but not take the picture. When the focus indicators in the corners of the screen turn green and the unit beeps, release the shutter to take the picture. To cancel the picture during focusing, slide the stylus off the Shutter icon.
7. A quick preview of the picture appears on the screen; then, moves to the preview thumbnail at the lower left corner of the screen.

Note: Tap on the thumbnail preview to edit, share or delete the picture.

To return to the camera application tap the camera icon  in the upper right corner of the screen.

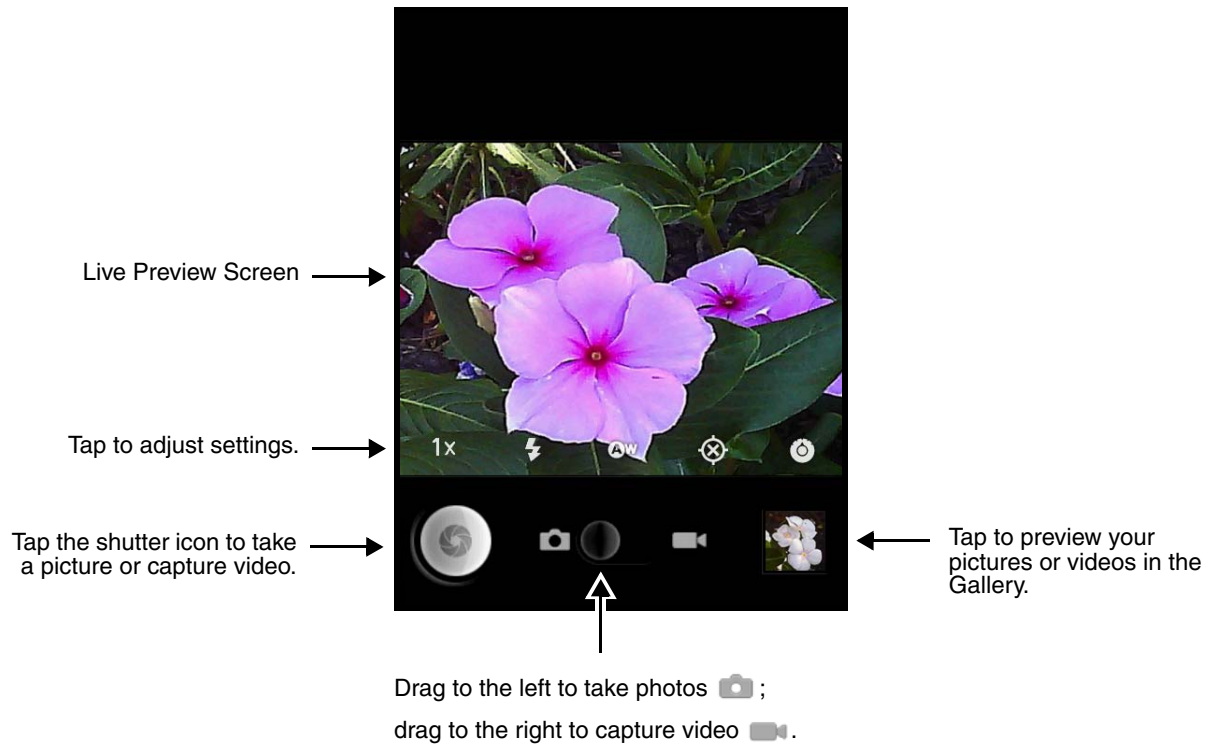



Changing the Camera Picture Settings



Tap the icons at the bottom of the live preview screen to adjust the camera settings.

Icon	Descriptions
1x	Set the zoom (i.e., 1x, 2x, 3x, or 4x)
	Set the camera flash On or Off
	Set the White Balance (i.e., Auto, Incandescent, Daylight, Fluorescent, or Cloudy)
	Set to save or not save GPS location information with picture
	Set: <ul style="list-style-type: none"> • Focus (i.e., Auto, Infinity or Macro), • Exposure Value (i.e., +5 EV to -5 EV in 1 EV increments), • Picture Size (i.e., 3M Pixels, 2M Pixels, 1M Pixels, or VGA), • Picture Quality (Superfine, Fine, or Normal), or • Restore Defaults

Recording Video

1. Tap **Launcher**  > **Camera** .
2. Slide the button to the Video  position.
3. Adjust the video settings (e.g., quality, flash, and white balance) or let the camera automatically adjust the settings.

Note: The icons change to reflect your selections. See [Changing the Camera Picture Settings](#), for additional information.



4. Point the terminal's camera lens at the scene or object you want to capture in video. The camera lens is located on the back panel of the terminal.
5. To start capturing video, tap the Start Video icon .
6. To stop capturing video, tap the Stop Video icon .
7. A thumbnail image from your captured video displays in the lower right corner of the screen.

Note: Tap on the thumbnail to edit, share or delete the video.

To return to the camera application tap the camera icon  in the upper right corner of the screen.

Changing the Camera Video Settings

Tap the icons at the bottom of the live preview screen to adjust the camera settings.

Icon	Descriptions
High	Set the video quality i.e., High (30m), Low (30m), MMS (Low 30s), or YouTube (High, 10m)
	Set the camera flash On or Off for additional light during video capture
	Set the White Balance (i.e., Auto, Incandescent, Daylight, Fluorescent, or Cloudy)
	Restore Defaults

Uploading Pictures and Videos

Picture and Video files can be uploaded to a host workstation via a USB connection. See [Connecting the terminal to a workstation via USB](#) on page 2-11.



Using the Keyboards

Available Keyboards

Note: Contact a sales representative for information on additional keyboard options.

30-Key Numeric Keyboard

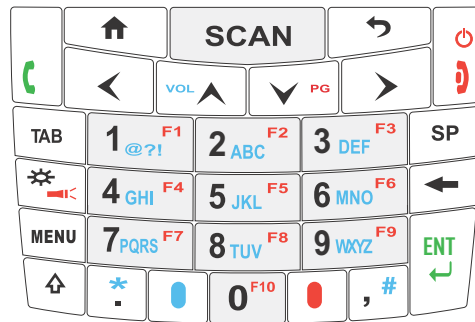

46-Key QWERTY Keyboard

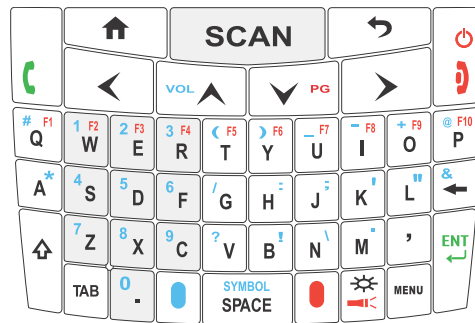

All Keyboards Contain the Following:

- Backlit for easy viewing in various lighting conditions.
- Centrally located Scan key for both right- and left-hand operation.
- Color-coding so you can clearly see the most common keyboard combinations.
- Function, navigation, and modifier keys.

Keyboard Combinations

See [30-Key Numeric Keyboard](#) on page 6-4.

See [46-Key QWERTY Keyboard](#) on page 6-6.







Common Buttons

See [Using the Function Keys](#) on page 6-2.

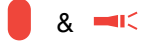

See [Using the Modifier Keys](#) on page 6-2.

See [Using the Navigation Keys](#) on page 6-3.

Using the Function Keys

Name	Key Symbol	Function
Flashlight	 &  Red	Turns the flashlight on or off. The flashlight is located on the back panel of the terminal.
Backspace		Moves the cursor back one space each time the key is pressed. If you are typing text, it deletes the previous character each time it is pressed.
Enter		Confirms data entry.
Power/End Call Key	 	The Power key, located in the upper right corner of the keypad, functions differently depending on the length of time the key is held down. Press and release the key to toggle the terminal in or out of Suspend Mode (see page 2-9). Press and hold the key for approximately 5 seconds to access the Phone Options Menu (see page 2-9). The key also ends and disconnects a phone call.
SCAN Key	SCAN	Activates the scan and wakes the terminal from Suspend Mode. The key location allows convenient one-handed image-taking and/or bar code decoding.
Space	SYMBOL SPACE or SP	Moves the cursor one space.
Tab	TAB	Moves the cursor to the next tab stop or the next control (on a form).









Using the Modifier Keys

Name	Key	Function
Blue & Red	 Blue  Red	<p>The blue and red keys are used in combination with other keys to type special characters and perform system functions. Each keyboard is color-coded to indicate the character typed or function performed when specific keys are pressed immediately after the blue or red modifier key.</p> <p><i>Normal</i> Press the blue or red key once to modify only the next key pressed.</p> <p><i>Locked</i> Press the blue or red key twice to toggle the modifier lock on or off. If a modifier key is locked on, the next keys pressed are modified until the lock is turned off. This prevents having to press the modifier key each time a key is pressed.</p> <p><i>Note: Press the locked modifier key once to temporarily unlock the modifier key for a single key stroke.</i></p>

Name	Key	Function
Shift		The shift key modifies only the next key pressed; it must be pressed before each key you wish to modify. Shift toggles the keyboard between uppercase alphabet mode and lowercase alphabet mode. Press the shift key twice to toggle Caps Lock ON or OFF.

Using the Navigation Keys

Located in the center of each keyboard for easy access with either hand, the navigation keys navigate the cursor through application screens.

Key	Function
	Return to the Home screen at any time, in any application. Return to the central Home screen from one of the other Home screen panels. <i>Note: Press and hold to view and select recently used applications.</i>
	Back to previous screen and/or exit application. Closes the on screen keyboard.
MENU	Opens additional menu options relevant to the open application or current screen.
	Moves the cursor up one row or line.
	Moves the cursor down one row or line.
 Blue	Raises the volume.
 Blue	Lowers the volume.
	Moves the cursor one character to the right.
	Moves the cursor one character to the left.

Note: Additional functionality varies according to the application in use.

30-Key Numeric Keyboard

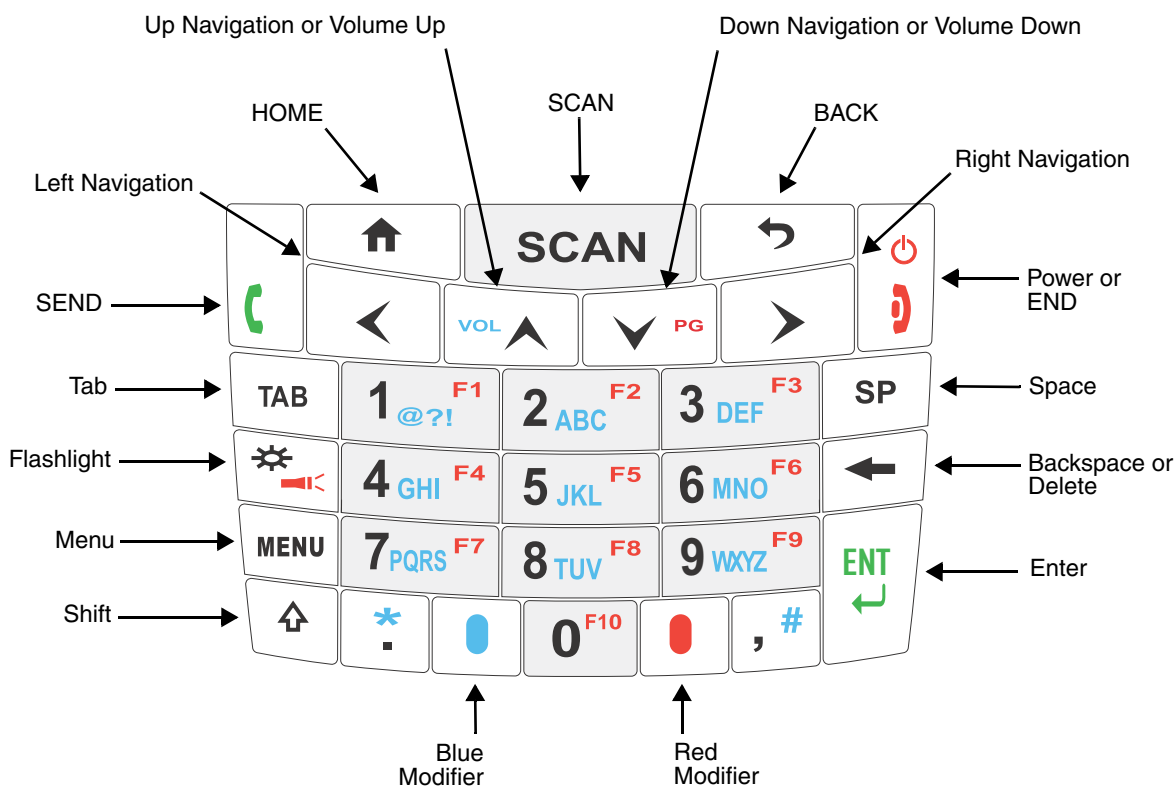

30-Key Numeric Keyboard Combinations

Key	Normal	Blue + Normal	Blue + Normal + Shift	Red + Normal
HOME	Return to the HOME screen.			
SCAN	Activates the scan.			
BACK	Back to previous screen and/or exit application. Closes the on screen keyboard.			
SEND	SEND	Hard Reset	Hard Reset	SEND
Left Navigation	Left			
Up Navigation	Volume Up	Volume Up	Volume Up	
Down Navigation	Volume Down	Volume Down	Volume Down	
Right Navigation	Right			

Key	Normal	Blue + Normal	Blue + Normal + Shift	Red + Normal
Power/END	Standby Mode On/Off, END Call or access Phone Options			
TAB	TAB			
1	1	@ ? !	@ or ? or !	F1
2	2	abc	ABC	F2
3	3	def	DEF	F3
Space	Space			
Flashlight				Flashlight
4	4	ghi	GHI	F4
5	5	jkl	JKL	F5
6	6	mno	MNO	F6
Backspace	Backspace or Delete			
MENU	Opens additional menu options.			
7	7	pqrs	PQRS	F7
8	8	tuv	TUV	F8
9	9	wxyz	WXYZ	F9
ENTER	Enter			
Shift	Shift			
Period	period	asterisk	asterisk	period
Blue	Blue			
0	0	0	0	F10
Red	Red			

46-Key QWERTY Keyboard

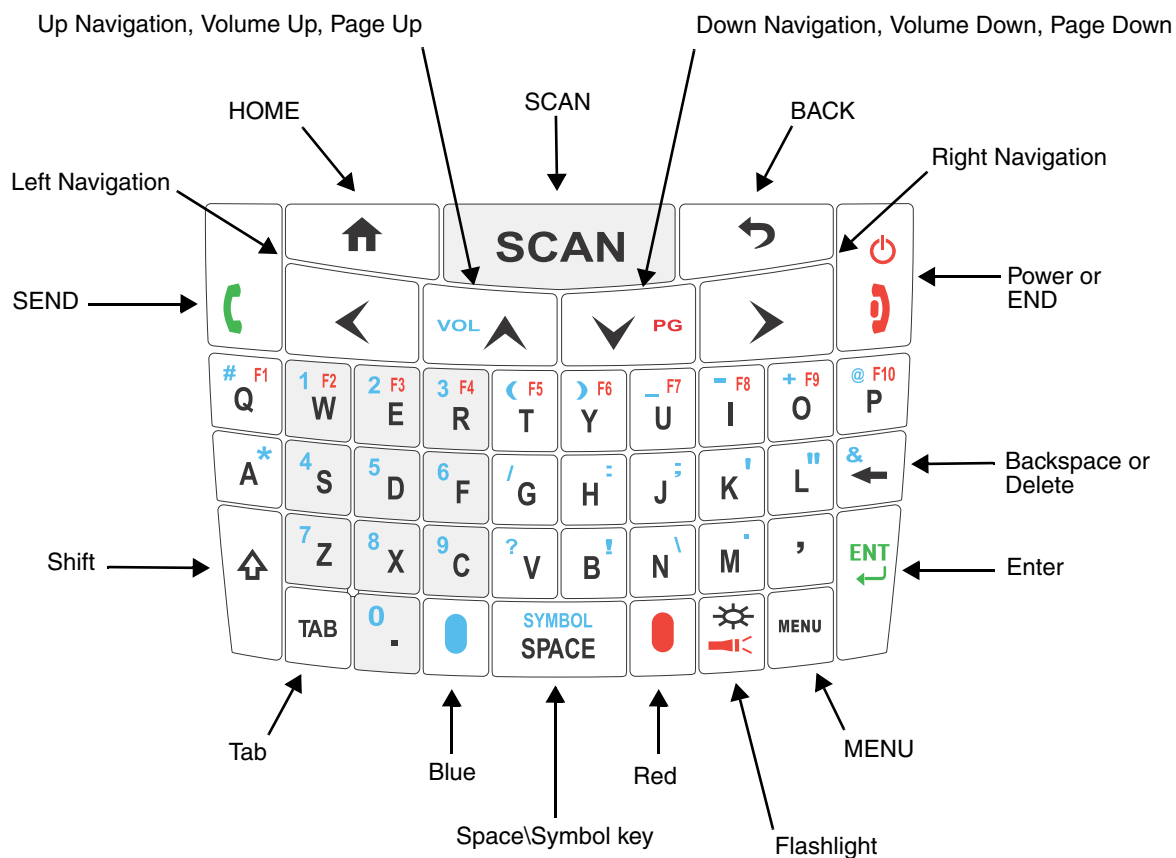

46-Key QWERTY Keyboard Combinations

Key	Normal	Shift + Normal	Blue + Normal	Red + Normal
SEND	Send	Send	Hard Reset	Send
HOME	Return to the HOME screen.			
SCAN	Activates the scan.			
BACK	Back to previous screen and/or exit application. Closes the on screen keyboard.			
Power/End	Standby Mode On/Off, END Call or access Phone Options			
Left Navigation	Left			
Up Navigation	Up	Up	Volume Up	Page Up

Key	Normal	Shift + Normal	Blue + Normal	Red + Normal
Down Navigation	Down	Down	Volume Down	Page Down
Right Navigation	Right			
Q	q	Q	# (pound/group)	F1
W	w	W	1	F2
E	e	E	2	F3
R	r	R	3	F4
T	t	T	(F5
Y	y	Y)	F6
U	u	U	_ (underscore)	F7
I	i	I	- (minus)	F8
O	o	O	+ (plus)	F9
P	p	P	@	F10
A	a	A	* (asterisk)	F11
S	s	S	4	F12
D	d	D	5	F13
F	f	F	6	F14
G	g	G	/	F15
H	h	H	: (colon)	F16
J	j	J	; (semi-colon)	F17
K	k	K	' (single quote)	F18
L	l	L	" (double quote)	F19
Backspace	Backspace	Backspace	& (ampersand)	
Shift	Shift			
Z	z	Z	7	F20

Key	Normal	Shift + Normal	Blue + Normal	Red + Normal
X	x	X	8	F21
C	c	C	9	F22
V	v	V	? (question mark)	F23
B	b	B	! (exclamation point)	F24
N	n	N	\ (back slash)	F25
M	m	M	. (period)	F26
Comma	, (comma)	<	, (comma)	, (comma)
ENT	Enter			
TAB	Tab			
Period	. (period)	>	0	. (period)
Blue	Blue			
SYMBOL/ SPACE	Space	Space	SYMBOL	Space
Red	Red			
Flashlight				Flashlight
MENU	Opens additional menu options.			



The Phone Options Menu

Press and hold the **Power** key  for approximately 5 seconds to access the **Phone Options** menu.

Tap one of the following options on the menu:

- Tap **Silent Mode** to toggle sound ON and OFF.
- Tap **Airplane Mode** to toggle airplane mode ON or OFF
- Tap **Reboot** to perform a hard reset of the terminal. Any open applications running in RAM at the time of the reset are closed during the reboot process.

Overview

The Settings application allows you to verify and/or alter system parameters to customized your terminal to meet you specific needs. Tap **Launcher**  > **Settings**  to access the Settings menu screen.

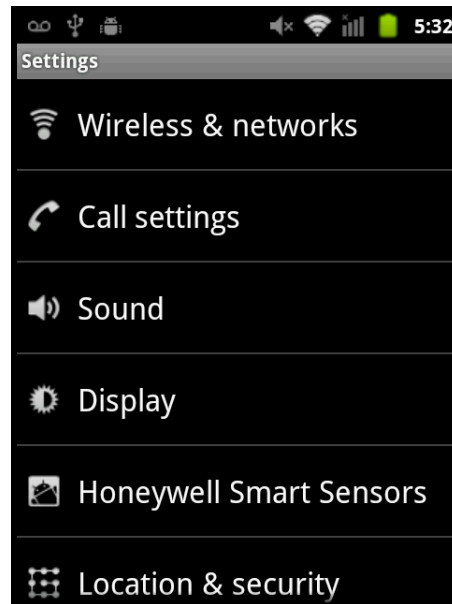

Menu Item	Tap the menu item to
Wireless & Networks	Setup and manage the wireless radios installed in the terminal including: Wi-Fi, Bluetooth, and Virtual Private Network (VPN) settings. In addition, enable or disable Airplane mode. See Wireless & Network Settings Menu on page 8-1.
Call Settings	Setup fixed dialing numbers, voicemail service and settings, enable or disable call forwarding, caller ID, or call waiting, and manage internet call settings. See Call Settings on page 9-5.
Sound	Set the sound volume, enable or disable sounds for specific actions, set sound parameters for system notifications and enable or disable vibrator notification. See Sound Settings on page 7-2.
Display	Set the screen brightness level, enable or disable screen auto-rotation, set animation effects, adjust the screen timeout settings, and calibrate the touch screen. See Display Settings on page 7-3.
Honeywell Smart Sensors	Enable or disable motion detection sensors or calibrate the accelerometer. See Honeywell Smart Sensors Settings on page 7-4.
Location & Security	Enable or disable application use of wireless networks for location identification, and/or the use of GPS satellites. Set up screen lock security features, enable or disable visible passwords, add or remove device administrators, and manage certificates/credential storage. See Location & Security Settings on page 7-4.

Menu Item	Tap the menu item to
Applications	Enable or disable the installation of non-Market applications, manage applications and software loaded on the terminal, view and control running services, view application storage use, view application battery use, and set options for application development. See Application Settings on page 7-7.
Accounts & sync	Add and manage exchange accounts for synchronization, enable or disable background application syncing, and enable or disable automatic application data syncing. See Accounts & Sync on page 7-10.
Privacy	Perform a factory data reset to erase all personal data on the device. See Privacy on page 7-11.
Storage	View and manage SD card and internal storage space or prepare the SD card for save removal. See Storage on page 7-11.
Language & Keyboard	Set the screen language, add, edit or delete words in the user dictionary, and modify the on screen keyboard settings. See Language & Keyboard on page 7-12.
Voice Input & Output	Configure text-to-speech options and select a default speech synthesis engine for application use. See Voice Input & Output on page 7-12.
Accessibility	Requires an installed accessibility pug-in. See Accessibility on page 7-13.
Date & Time	Manually set the time zone, date, and time or set the terminal to update automatically based on network-provided values. Set date and hour format. See Date & Time on page 7-13.
About Phone	View information about the terminal including status (e.g., battery status, phone number, Wi-Fi MAC address, Bluetooth address, and IMEI number), battery use, legal information for software on the device, model number, Android version, baseband version, kernel version, and build number. See About Phone on page 7-13.

Wireless & Network Settings

See [Wireless & Network Settings Menu](#) on page 8-1.

Call Settings

See [Call Settings](#) on page 9-5.

Sound Settings

Tap **Launcher**  > **Settings** > **Sound** to configure:

- **Silent Mode** - Enable or disable all sounds except media & alarms
- **Vibrate** - Specify when the terminal vibrates (i.e., Always, Never, Only in Silent mode, or Only when not in silent mode)

-
- **Volume** - Adjust the volume of the ringtone, media, or alarm and enable or disable the use of incoming call volume for notifications.
 - **Phone ringtone** - Select a ringtone for incoming calls.
 - **Notification ringtone** - Select a ringtone for notifications.
 - **Audible touch tones** - Enable or disable sound feedback when using the dial pad.
 - **Audible selection** - Enable or disable sound feedback when making screen selections.
 - **Screen lock sounds** - Enable or Disable sound feedback when locking or unlocking the screen.
 - **Haptic feedback** - Enable or disable vibration feedback when pressing soft keys and on certain UI interactions.

Display Settings

Tap **Launcher**  > **Settings** > **Display** to set the touch screen's power settings and interactive features or to perform a touch screen calibration.

Brightness

Tap **Brightness** from the Display settings screen to open a dialog box with a slider for adjusting the back-light intensity brighter or dimmer. Drag the slider left or right to adjust the intensity of the screen, then tap **OK**.

Note: Set the brightness level low conserve battery life between charges.

Auto-rotate screen

By default, the display automatically adjusts the orientation of the screen between landscape and portrait when the terminal is rotated. Tap the **Auto-rotate screen** checkbox to turn the automatic rotation feature On or Off.

Animation

Tap **Animation** from the Display settings screen to select either **No animations**, **Some animations** or **All animations** from the Animation menu. By default, **All animation** effects are activated.

Screen Timeout

The Screen timeout setting enables you to customize backlight functionality for the display. Select how many minutes you want to elapse (i.e., 1 minute, 2 minutes, 10 minutes, 30 minutes or Never Timeout) before the backlight automatically turns off and the terminal enters Suspend mode. By default, the screen timeout is set to 1 minute.

Touchscreen Calibration

See [Touch Screen Calibration](#) on page 2-3.

Honeywell Smart Sensors Settings

The Smart Sensor settings enable you to configure the Dolphin's integrated accelerometer and motion settings for advanced power management.

Tap **Launcher**  > **Settings** > **Honeywell Smart Sensor**.

Keep awake on motion

If enable, the terminal is prevented from entering suspend mode when motion is detected. By default, this option is disabled. Tap the **Keep awake on motion** checkbox to enable or disable the option.

Wake on motion

If enabled, the terminal wakes from suspend mode when motion is detected. By default, this option is disabled. Tap the **Wake on motion** checkbox to enable or diable the option.

Accelerometer Calibration

The terminal includes an integrated accelerometer sensor used for motion detection.

To calibrate the accelerometer sensor:

1. Tap **Launcher**  > **Settings** > **Honeywell Smart Sensor** > **Accelerometer Calibration**.
2. Place the terminal on a flat surface.
3. Tap **Calibrate** at the bottom of the screen. **Do not move the terminal during the calibration process.**
4. When calibration is complete, a "Calibration Completed" message window appears.
5. Tap **Ok** to exit the calibration application.

Location & Security Settings

The Location & security settings menu provides access to configure GPS functionality and manage terminal security parameters (e.g., authorization for device administration, setup a screen lock, setup a SIM card PIN, enable/disable visible passwords, load security certificates, and setup a password to protect the terminal's credential storage).

Tap **Launcher**  > **Settings** > **Location & security** to access the Location & Security Settings menu.

My Location

The Dolphin 7800 terminal contains an integrated GPS module that allows location tracking of workers and vehicles, providing better utilization of field assets. Optional mapping and navigation software provides turn-by-turn driving directions and location information. The GPS module powers On automatically when accessed by a software application and powers Off automatically when the software application closes. You cannot manually power On and Off the GPS module.

There are two settings used to configure how location information is gathered by the terminal:

- **Use wireless networks** - When enabled (checked), the terminal's location is determined by Wi-Fi and/or mobile networks.
- **Use GPS satellites** - When enabled (checked), the integrated global positioning system (GPS) satellite receiver is used to pinpoint the terminal's location. This option requires a clear view of the sky and additional battery power, which reduces battery life between charge cycles.

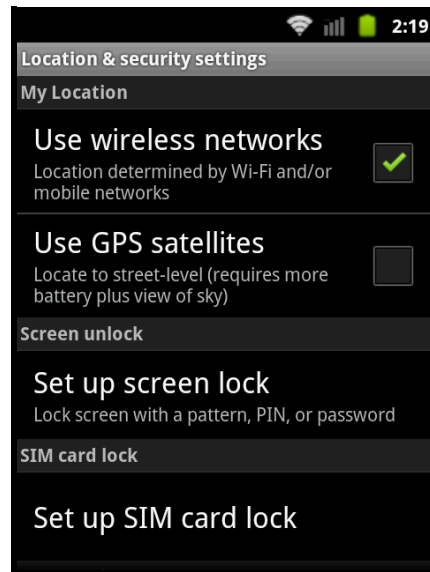

Screen Unlock

The Screen Unlock settings screen provides access to additional security features that enable you to prevent an unauthorized person from unlocking the touch screen and accessing the terminal. Select from four security options: **None, Pattern, PIN or Password**.

- Tap on **Pattern, PIN or Password** to access additional dialogue screens that step you through setting up or updating the security feature.
- To disable the screen unlock security setting, tap **None**. Then, enter your existing Pattern, PIN, or Password.

SIM Card Lock

Tap **Set up SIM card lock** to establish or modify a SIM card PIN so unauthorized individuals cannot use the terminal as a phone or modify data on the SIM card.

Password Security

Tap the **Visible passwords** checkbox to toggle between hiding or showing passwords as you type.

Device Administration

The Device administrators screen lists all applications that have been given authorization to act as a device administrator, which is often required when you set up accounts that synchronize data between the terminal and an enterprise service. An enterprise service implements security policies on the terminal before allowing a connection (e.g. passwords and certificates).

Tap **Select device administrators** from the **Location & security settings** screen, then tap the application name to remove authorization to act as a device administrator for the terminal.

Credential Storage

Access options that help you manage your Wi-Fi network and/or Virtual Private Network (VPN) security certificates under the “Credential storage heading” at the bottom of the Location & security settings menu. Android supports DER-encoded X.509 certificates saved with a .crt file extension and X.509 certificates saved in PKCS#12 key store files with a .p12 file extension.

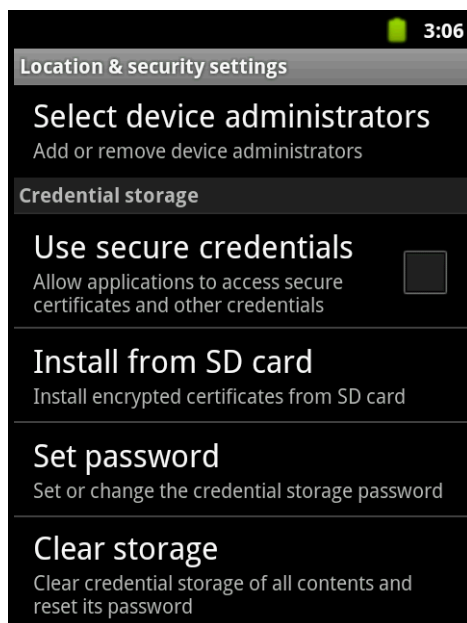

Setting application access to secure certificates

Tap the **Use secure credential** checkbox to toggle between allowing (checked) or disallowing applications to access secure certificates and other credentials saved in the terminal’s secure credential storage.

Note: This option is only available if a credential storage password has been established.

Installing a certificate from the SD card

To install encrypted certificate from the terminal’s SD card:

1. Copy the certificate from the host device (computer) to the root directory of the SD card.

Note: Ensure your certificates are saved with the correct file extension. Android supports DER-encoded X.509 certificates saved with a .crt file extension and X.509 certificates saved in PKCS#12 key store files with a .p12 file extension. Certificate or key store files saved with file extensions other than .crt or .p12 are not recognized by the Android OS.

2. Tap **Launcher**  > **Settings** > **Location & Security** > **Credential Storage**.
3. Tap **Install from SD card**.
4. Tap the file name of the certificate to install and enter a password if required.

5. Tap **OK**.

6. Enter the name of the certificate, then tap **OK**.

Note: Once an encrypted certificate is installed on the terminal, it is automatically deleted from the SD card.

Setting or changing the secure credential storage password

Tap **Set Password** to create or change the password protection for the terminal's credential storage.

Note: The password must be at least 8 characters in length.

Clearing the content of the credential storage and resetting the storage password.

Tap **Clear storage** to clear credential storage of all contents and reset the storage password.

Application Settings

The Application settings menu enables you to set security parameters for installing non-Market applications or access options for application development. In addition, you can evaluate storage and battery usage for running services and installed applications to determine if the running service should be stopped or an application should be removed from the terminal.

Tap **Launcher**  > **Settings** > **Applications** to access the Application setting menu.

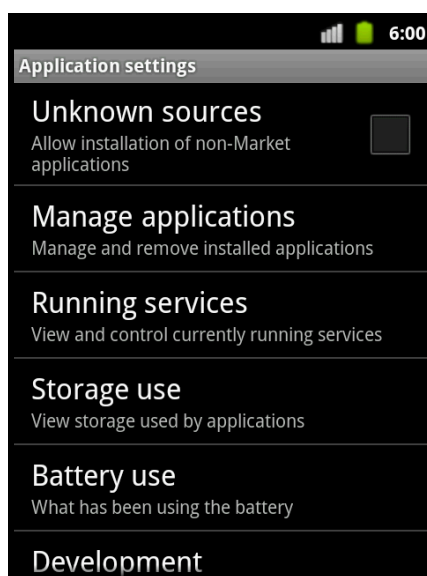

Unknown sources

Check the Unknown sources box to allow the installation of non-market applications.

Manage applications Screen

The **Manage application** screen allows you to view, evaluate, and modify how applications installed on the terminal and/or microSD card utilize memory and storage resources. Check the Manage applications screen when you are receiving out of memory errors or when the mobile computer is running slowly.

To access the Manage applications screen:

Tap **Launcher**  > **Settings** > **Applications** > **Manage applications**.

Or

Press the **Menu** key from the Home screen, then tap **Manage apps**.

Tabs at the top of the Manage application screen provide access to detailed application lists organized into four main categories: **Downloaded**, **All**, on **SD card**, and **Running**. In addition, the type of memory or storage (e.g., internal storage, SD card storage, or RAM), the amount of space used by the applications listed, and the amount of free space remaining is displayed at the bottom of each screen.

To sort an application list, press the **Menu** key. Then, tap **Sort by size** or **Sort by name**.

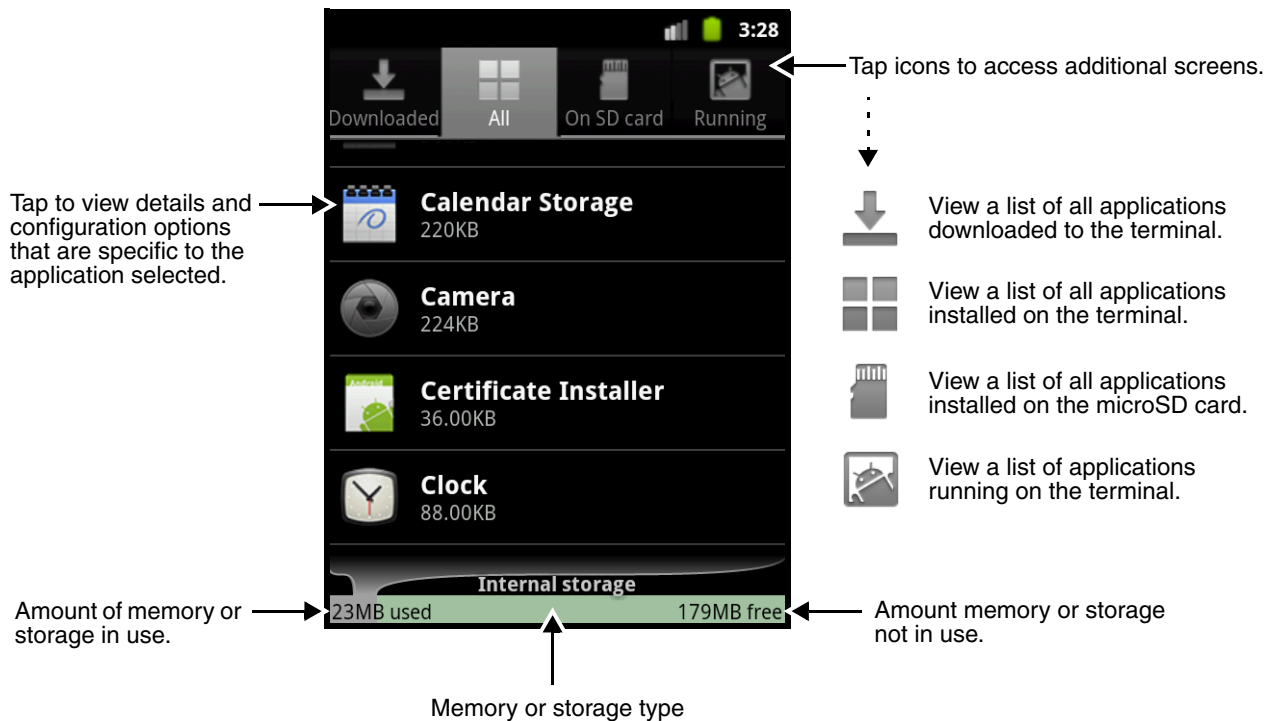

To **uninstall** an application.

1. Press the **Menu** key from the Home screen, then tap **Manage apps**.
2. Tap the one **Downloads**  tab.
3. Tap the application you want to uninstall.
4. Tap the **Uninstall** button.
5. Tap **OK** to confirm the uninstall.

To **move** an application.

1. Press the **Menu** key from the Home screen, then tap **Manage apps**.

2. Tap the **on SD card**  tab. The displayed list only includes applications designed to allow storage on either the SD card or on the terminal's internal storage. Applications that cannot be moved do not appear on the SD card screen.

Note: A green checkmark indicates an application is stored on the SD card.

3. Tap on the application you want to move.
4. Tap **Move to SD card** or **Move to phone** to move the application.

Note: Applications moved to the SD card still require the use of a minimal amount of internal storage on the terminal.

To **stop** an application.

1. Press the **Menu** key from the Home screen, then tap **Manage apps**.
2. Tap the **Running**  tab.
3. Press the Menu key and tap **Show cached processes** or **Show running services**.
4. Tap on the cached background process or running service you want to stop.
5. Tap the **Stop** button.

Battery use

Tap **Launcher**  > **Settings** > **Applications** > **Battery Use** to monitor and adjust battery usage. The application list is organized by the battery consumption percentage rate with the higher rates at the top of the list. The time displayed at the top of the screen indicates the length of time the battery has been in use between charging cycles. The time does not reflect how long the terminal has been in Suspend mode.

Tap to view the battery discharge graph.



Tap an item to view usage details and adjust power use.

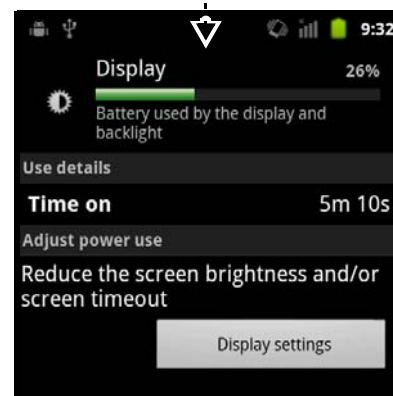

See [Batteries](#) on page 3-11 to view detailed specifications on the terminal's internal backup battery and the main battery pack.

Development

The Development screen provides access to settings used by Android application developers. For information on these settings, Android APIs, and development tools, refer to the Android developer web site at <http://developer.android.com> and the *Android 2.3.4 User's Guide* at <http://support.google.com/mobile/bin/answer.py?hl=en&answer=182077>.

Accounts & Sync

Use the Accounts & Sync settings to add, remove, and manage exchange Accounts (e.g., e-mail), enable or disable background synchronization of data so applications can sync, send, and receive data at any time not only when the application is open, and enable or disable if applications can automatically schedule and sync data.

To add an account:

1. Tap **Launcher**  > **Settings** > **Accounts & Sync**.
2. Tap **Add account**.

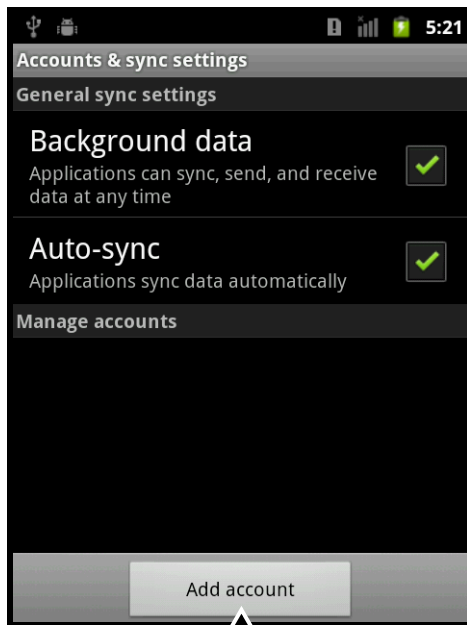

Tap Add Account to configure a new exchange account.

Enter Email address and Password for the new exchange account. →

Check box to set the new account as the default email account. →

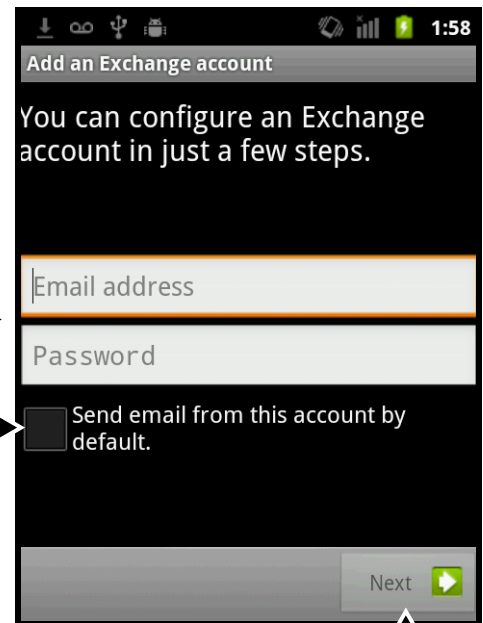

3. Enter the email address and password for the exchange account, then tap **Next**.

Note: A "Retrieving account information. . ." message appears on the screen.

-
4. If necessary, edit the Server settings (i.e., **Domain\Username, Password, Server**) shown on the screen.
 5. Check the appropriate security settings for the account type (i.e., **Use secure connection (SSL)** and/or **Accept all SSL certificates**).
 6. Tap **Next**.
Note: A "Checking incoming server settings. . ." message appears on the screen as communication is established with the server.
 7. Modify your account preferences, then tap **Next**.
 8. Enter a name (optional) for the account, then tap **Done**.
 9. The new account appears under the Manage accounts heading on the **Accounts & sync settings screen**.

Privacy

The Privacy screen provide access to perform a **Factory data reset** to remove personal data from the terminal. A **Factory data reset** erases all data from the terminal's internal storage, including: Google account information, system data and settings, application data and settings, and downloaded applications.

To also clear music, pictures and other user data, the SD card needs to be erased. See [Storage](#) below.



Storage

The storage settings screen provides storage statistics for the microSD card and the internal storage of the terminal. The screen also allows the user to unmount the microSD card in preparation for safe removal from the terminal or the ability to erase all data from the microSD card.

Note: Honeywell recommends unmounting the microSD card to prevent possible data corruption or damage to the card during replacement. Never attempt to replace the microSD card unless you have placed the terminal in Suspend mode.

Unmount/Mount the micorSD card

To unmount the microSD card for safe removal:

1. Tap **Launcher**  > **Settings** > **Storage**.
2. Tap **Unmount SD card**. A pop-window notifies you the SD card will be unmounted.
3. Press the **Power** key  to put the terminal in Suspend mode.
4. Replace the microSD card. See [Installing a SIM Card and/or Replacing the Memory Card](#) on page 3-15.
5. After you replace the microSD card and reboot the terminal, pull down the notification panel and tap the "SD card safe to remove" notification to mount the microSD.

Erase the microSD card

To erase all data (e.g., photos, music, and applications) from the microSD card:

1. Tap **Launcher**  > **Settings** > **Storage**.
2. Tap **Erase SD card** on the Storage settings screen.
3. Tap **Erase SD card (IPSM)** to confirm data removal.

Language & Keyboard

The Language & keyboard settings menu is organized into two categories: **Language settings** and **Keyboard settings**.

Under the **Language settings** heading, tap **Select Language** to change the language displayed on the touch screen or tap **User dictionary** to edit or delete words added to the terminal's User Dictionary.

Under the **Keyboard settings** heading, tap **Android keyboard** to access menu options that customize the on screen keyboard. The additional menu options allow you to:

- Set audible, visual, and/or haptic responses to tapping the keys on the touch screen keyboard.
- Enable or disable word suggestions, automatic capitalization, quick fixes (auto-correction), and auto-completion features for text input.
- Set when the settings key shows on the touch screen keyboard (i.e., Automatic, Always show, or Always hide).
- Set the Input languages available when you use the onscreen keyboard.

Voice Input & Output

The **Voice Input & Output settings** screen provides access to the **Text-to-speech settings** menu, which allows you to select and configure the default engine used for speech synthesis. When the Text-to-speech settings screen is open, tap **Listen to example** to play a short demonstration of speech synthesis based on the current Default settings displayed on the screen. Check the **Always use my settings** box to override application specific settings with the Default settings configured on the text-to-speech screen.

Under the **Default settings** heading, you can set the default speech synthesis engine used for spoken text, the rate of speed the text is spoken (i.e., Slow, Normal, Fast, or Very fast), and the language in which the text is spoken (e.g., French, German, Spanish).

*Note: The **Install voice data** option is grayed out if voice data for the default engine is already installed on the terminal.*

A list of all the speech synthesis engines installed on the terminal is located under the **Engines** heading on the Text-to-speech settings screen. Tap on the engine name to view additional information specific to engine application.

Accessibility

The Accessibility settings menu allows you to enable or disable and configure accessibility plug-ins installed on terminal.

Note: The Accessibility enable/disable checkbox shows but is grayed out if no accessibility plug-ins are installed on the terminal.

Date & Time

The **Date & time settings** menu provides options for configuring the date, time, time zone, time format, and date format displayed on the terminal. You can set the terminal to synchronize the date, time, and time zone using a network connection by checking the **Automatic** box or you can manually enter the values by tapping **Set date**, **Select Time zone**, and/or **Set time**.

*Note: If the Automatic option is checked, the **Set date**, **Select Time zone**, and **Set time** menu options are grayed out.*

To modify how the time is displayed on the screen, check the **Use 24-hour format** box to switch from a 12-hour cycle to a 24-hour cycle. In a 24-hour time cycle, 1:00 pm displays as 13:00 pm. To change the date format displayed on the screen, tap the **Select date format** arrow, and then select a format from the list (e.g. 12/13/2012, 31/12/2012, 2012/12/31).

About Phone

The **About Phone** screen displays specific information about the terminal including: Model number, Android version, Baseband version, Kernel version, and Build number. Tap **Status**, **Battery use** or **Legal information** from the About Phone screen to view additional information pertaining to each category.

The **Status** screen displays information on the battery status (charging or discharging), the remaining charge level of the battery, the phone number, the carrier network, the signal strength, the mobile network type and state, the service state, the roaming status, the IMEI and IME SV numbers, the Wi-Fi MAC address, and the Bluetooth address of the terminal.

Note: The content of the Status screen is base on the Model type.

The **Battery use** screen displays information the applications and services utilizing battery power. See [Battery use](#) on page 7-9.

The **Legal information** screen displays important information on Open source software licenses.



Wireless & Network Settings Menu

The Wireless & Network Settings menu provides a central access point to enable/disable and configure all the terminal's onboard wireless radios and Virtual Private Networks (VPN) connections.

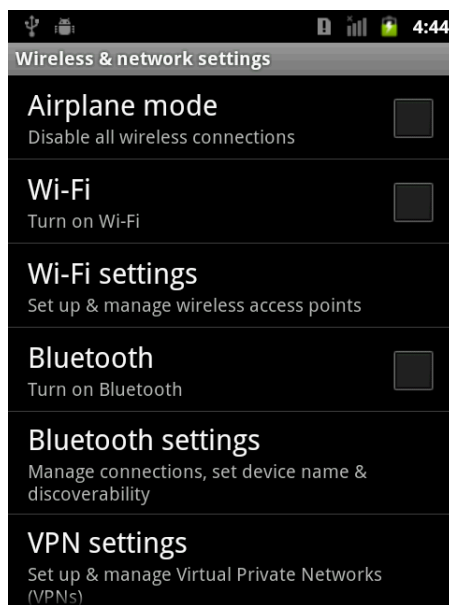

Menu Item	Tap the menu item to . . .
Airplane mode	Toggle Airplane mode ON or OFF. See Airplane Mode on page 8-2.
Wi-Fi	Toggle Wi-Fi networking ON or OFF. See Connecting to a Wi-Fi Network on page 8-2.
Wi-Fi settings	Access the Wi-Fi settings menu to configure and manage Wi-Fi devices and networks. See Wi-Fi Network Connections on page 8-2.
Bluetooth	Toggle the Bluetooth radio ON or OFF. See Working with the Bluetooth Radio on page 10-1.
Bluetooth settings	Setup and manage communication with devices equipped with Bluetooth technology. See Working with the Bluetooth Radio on page 10-1.
VPN settings	Setup and manage Virtual Private Networks (VPN). See Virtual Private Networks (VPN) on page 8-3. <i>Note: VPN setup and management requires network parameters from your system administrator.</i>
Mobile networks	Setup and manage Mobile Networks.

Note: All server-assigned IP addresses use Dynamic Host Configuration Protocol (DHCP).

Airplane Mode

Turn On Airplane mode to disable all the terminal radios that transmit voice or data.

To turn Airplane mode On or Off do one of the following:

1. Tap **Launcher**  > **Settings** > **Wireless & network settings**
2. Tap the check box to toggle between **Airplane Mode** On (checked) or Off (unchecked).

OR

1. Press and hold the **Power** key  for approximately 5 seconds.
2. Tap **Airplane Mode** on the **Phone Options** menu to toggle the mode On or Off.

Note: When Airplane Mode is turned on,  shows on the status bar.

Connecting the Terminal to a Wireless Network

You connect the terminal to a wireless network through the on-board radio (802.11a/b/g/n, Bluetooth, and/or GSM). Each radio has its own configuration utility and requires specific information about the wireless network to connect. Successful connection depends on your network infrastructure about which you will need specific information from your network administrator.

WLAN (802.11a/b/g/n)

The 7800 has a 2.4 GHz 802.11b/g/n - 5.0 GHz 802.11a/n WLAN (Wireless Local Area Network) radio. The radio is interoperable with other 802.11a/b/g/n, Wi-Fi compliant products including access points (APs), workstations via PC card adapters, and other wireless portable devices. By default, the 802.11a/b/g/n radio is disabled after each factory reset.

Bluetooth

See [Working with the Bluetooth Radio](#) on page 10-1.

Wi-Fi Network Connections

Turning Wi-Fi Networking On or Off

1. Tap **Launcher**  > **Settings** > **Wireless & network settings** > **Wi-Fi**
2. Tap the check box to toggle between Wi-Fi On (checked) and Off (unchecked).

Connecting to a Wi-Fi Network

1. Tap **Launcher**  > **Settings** > **Wireless & network settings** > **Wi-Fi settings**
2. Tap the Wi-Fi check box to turn On Wi-Fi networking if the box is not checked.

-
3. The terminal searches for available Wi-Fi access points within range of the device. If the terminal previously connected to a Wi-Fi network, it automatically reconnects to the same network.

Note: To remove a Wi-Fi network the terminal previously connected to, tap and hold the network name, then tap on Forget Network to delete the stored network information.

4. Tap the network name you want to connect to from the available network list.

Note: A locked icon  indicates the network is a secured network requiring an access password.

5. If the network is secured, a dialog box appears requesting information relevant to the network security protocol (e.g., password, key, or certificate). Enter the required information.
6. Tap **Connect**.

Receiving Network Notifications

If Wi-Fi networking is turned On, you can set the terminal to notify you when an open network is available.

1. Tap **Launcher**  > **Settings** > **Wireless & network settings** > **Wi-Fi settings**
2. Tap the check box to toggle between **Network notification** On (checked) and Off (unchecked).

Adding a Wi-Fi Network

1. Tap **Launcher**  > **Settings** > **Wireless & network settings** > **Wi-Fi settings**
2. Tap the Wi-Fi check box to turn On Wi-Fi networking.
3. Tap on **Add Wi-Fi network** located at the bottom of the available Wi-Fi network list.
4. Enter the **Network SSID**.
 - a. For secure Wi-Fi network connections, tap **Open** to view the advanced security network settings.
 - b. Select the type of security protocol required (e.g., WEP, WPA/WPA2 PSK, or 802.1x EAP).
 - c. Enter additional security information required by the type of security protocol.
5. Tap **Save**.

Virtual Private Networks (VPN)

Note: To complete the VPN setup screens, you may need to ask your ISP or network administrator for the proxy server name, server type, port, type of Socks protocol used, and your user name and password if you do not already have the information.

Adding a VPN

1. Tap **Launcher**  > **Settings** > **Wireless & network settings** > **VPN settings**.
2. Tap **Add VPN**.
3. Tap the VPN type you want to add from the menu, then complete the setup screens that follow with the appropriate information for your network. The terminal supports the following protocol types:
 - PPTP VPN: Point-to-Point Tunneling Protocol

-
- L2TP VPN: Layer 2 Tunneling Protocol
 - L2TP/IPSec PSK VPN: Pre-shared key based L2TP/IPSec VPN
 - L2TP/IPSec CRT VPN: Certificate based L2TP/IPSec VPN

4. Press the **Menu** key, then tap **Save**.

*Note: To delete a VPN, tap and hold the network name on the VPN settings screen, then tap **Delete network**. Tap **OK** to confirm the deletion.*

*To edit a VPN configuration, tap and hold the network name on the VPN settings screen, then tap **Edit network**. Tap **Save** to retain your changes.*

Connecting to a VPN

1. Tap **Launcher**  > **Settings** > **Wireless & network settings** > **VPN settings**.
2. Tap on the name of the VPN.
3. Enter any security credentials (e.g., password, user name, certificate information or server name) required by the VPN.
4. Tap **Connect**.

Note: When a VPN connection is established, a  shows in the status bar.

Disconnecting from a VPN

1. Drag the status bar down from the top of the touch screen to view the Notification panel.
2. Tap the VPN connection notification to disconnect.

Mobile Networks

The Mobile Network settings screen provides options for you to setup and configure the terminal for data communication over your service provider's (carrier's) mobile network. See [Using the Dolphin terminal for Data Communication via a Mobile Network](#) on page 9-8.

Working with Wireless Wide Area Networking (WWAN)

Overview

Dolphin 7800 models equipped for WWAN connectivity have an integrated voice + data radio, which supports GSM/HSPA+/UMTS/GPRS/EDGE network communications.

- GSM** Short for Global System for Mobile communications, GSM is an open, non-proprietary wireless WAN system that is constantly evolving and growing.
- HSPA+** Short for High-Speed Download Packet Access, HSPA+ is a non-voice value added service that allows packet-switched data to be instantly sent and received across mobile telephone networks.
- UMTS** Short for Universal Mobile Telecommunications System, UMTS is a non-voice value added service that allows packet-switched data to be instantly sent and received across mobile telephone networks.
- GPRS** Short for General Packet Radio Service, GPRS is a non-voice value added service that allows packet-switched data to be instantly sent and received across mobile telephone networks.
- EDGE** E-GPRS is a non-voice value added service that allows packet-switched data to be instantly sent and received across mobile telephone networks at a higher data rate than standard GPRS.

Requirements

Using GSM/HSPA+/UMTS/GPRS/EDGE requires:

- a network subscription to a GSM/HSPA+/UMTS/GPRS/EDGE network (you need to know what service providers are in your geographic area), and
- an installed SIM card that has been activated by the network service provider (see [Installing a SIM Card and/or Replacing the Memory Card](#) on page 3-15).

Antenna Band

The WWAN radio features an internal antenna that is optimized for power output and receiver sensitivity. This is an omni-directional antenna. For terminals equipped with the voice + data (Phone) WWAN radio, there is a penta band antenna that supports 3G 800/850/AWS/1900/2100MHz (HSPA+/UMTS), and a quad-band 2G 850/900/1800/1900MHz (GSM/GPRS/EDGE).

Signal Strength

On terminals equipped with a WWAN (voice + data) radio, the signal strength of the WWAN connection is indicated by the number of bars that appear in the signal strength icon in the Status bar at the top of the window. The stronger the signal strength the



Icon	Indicates...
	Signal strength of the radio connection is strong.
	Signal strength of the radio connection is low.
	No signal.

Voice and Data Communication

Dolphin terminals with an integrated GSM/HSPA+/UMTS/GPRS/EDGE (voice + data) radio are optimized for the following two-way communications:

Voice: GSM voice data (dial-up)

Data: Available speed depends on the wireless network carrier and their supported packet-data technology in addition to network conditions.

GPRS Class 10: data transmission max. 85.6 kbps (DL), max. 42.8 kbps (UL)

HSPA+: data transmission max. 14.4 Mbps (DL), max. 5.76Mbps (UL)

UMTS: data transmission max. 384 kbps (DL), max 384 kbps (UL)

EDGE (E-GPRS) Class 10: data transmission max. 237 kbps (DL), max. 118 kbps (UL)

Note: You can use the GSM radio for simultaneous voice and data communication on a UMTS (3G) network only. On a GSM network, if you want to communicate over the phone (voice), you cannot send data. If you want to send data, you cannot use the phone.

Using the Dolphin as a Phone



If your Dolphin model is equipped for voice + data WWAN connectivity, you can use the terminal as a phone over the GSM radio.

Opening and Using the Dialer Window for Phone Calls

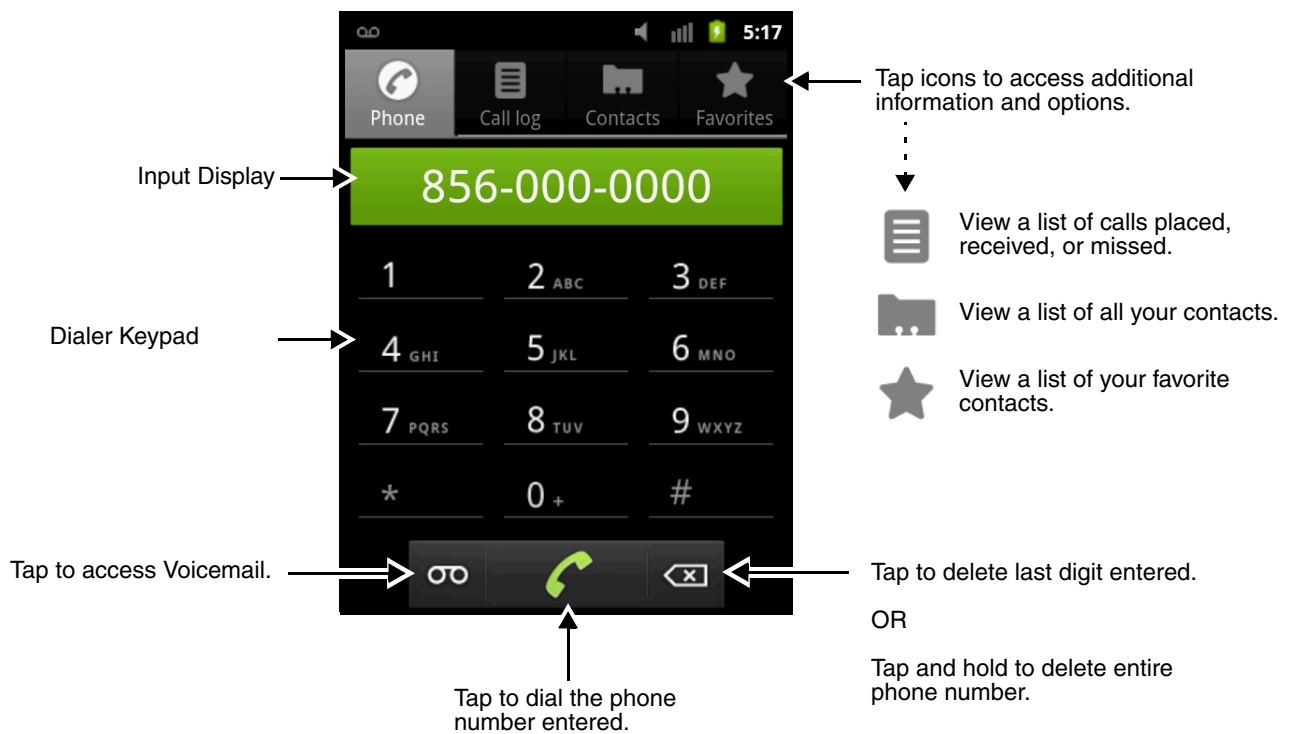
Tap  at the bottom of the Home screen or tap **Launcher**  > **Phone**  to open the Dialer window.



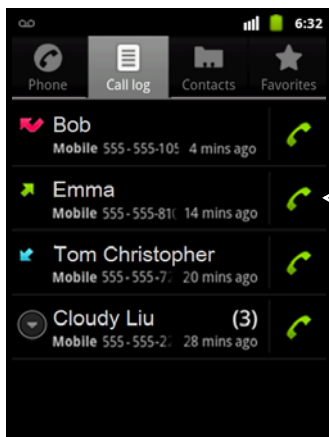

Entering a Phone Number

Once the dialer window is open, you can enter a phone number using the on screen keypad or the physical keyboard. You can also dial phone numbers stored in the **Call Log** , **Contacts list** , or **Favorites list** .

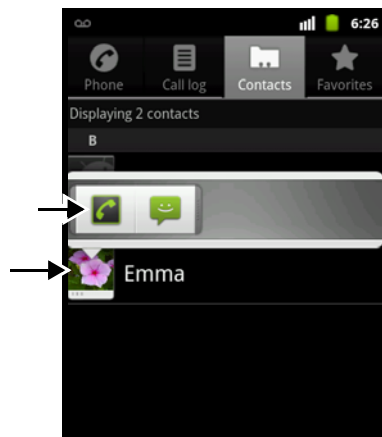

Tap  to dial the call listed.



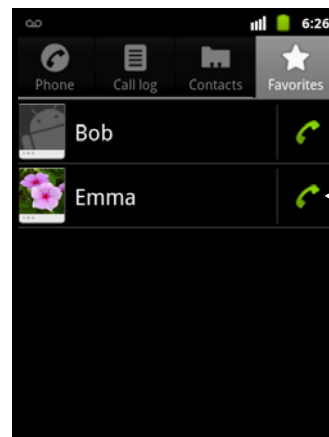

Tap the contact's photo, then tap  to dial the contact.



Tap  to dial a contact.

Sending Calls

After manually entering a phone number using the dialer keypad or the terminal keyboard, tap  or press the **Send** key  to initiate the call.

Note: A call is automatically initiated when the Call Log, Contacts list, or Favorites list is used for phone number input.



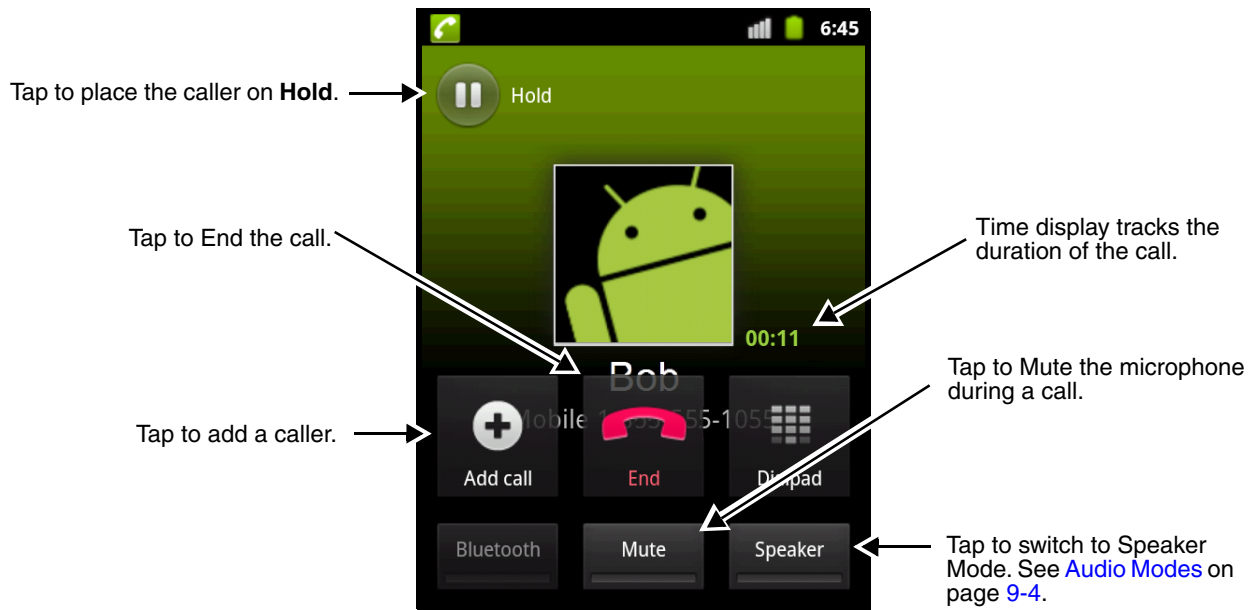



Ending Calls

While the phone call is live, tap  or press the **End Key** .

Answering Calls

Drag the **Answer** icon  to the right or press the **Send** key .

Note: The  icon on the status bar indicates that the phone is in use.

Sending Calls to Voicemail

Drag the **Decline** icon  to the left to send the call the voicemail without answering.

Audio Modes



The front panel of the 7800 contains both a speaker and a microphone that you can use to send and receive audio signals over the GSM network, see [Front Panel: 7800 Android](#) on page 3-4.



There are two audio modes:

- **Handset Mode**
The front speaker is used for receiving handset voice calls and the front panel microphone provides audio input to the terminal.
- **Hands-Free Mode**
Hands-free mode is when you use the rear speaker as a speakerphone. To switch to speakerphone, tap on the **Speaker** button during a call.

Volume Control

Use the terminal keyboard or the Volume Control button to adjust the volume of the active speaker.

To raise the volume of the active speaker, press the **Blue** modifier key  + **Up** arrow  **VOL**.

To lower the volume of the active speaker, press the **Blue** modifier key  + **Down** arrow  **PG**.

OR

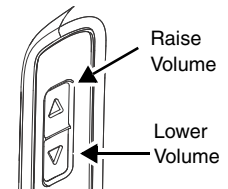

Press the top (up arrow) or the bottom (down arrow) of the Volume Control Button on the left side of the terminal to raise or lower the volume of the active speaker.



Accessing Voicemail

The Voicemail icon  appears on the status bar when you have a new voicemail message.

To dial voicemail:

1. Tap  on the Home screen, then  on the Dialer window.

OR

1. Tap and hold the status bar, then drag down to access the Notification panel (see page 2-5).
2. Tap on the **New Voicemail**.

Call Settings

Access the **Call Settings** menu to setup and manage phone options including: fixed dialing numbers, voicemail, call forwarding, caller ID, call waiting, and internet call settings.

Tap **Launcher**  > **Settings** > **Call Settings**.

Fixed Dialing Numbers (FDN)

When you Enable FDN, outgoing calls are restricted to fixed dialing numbers saved on the terminal's active SIM card. The Fixed Dialing Numbers menu provides access to enable or disable FDN restriction, change the FDN access PIN (PIN2), and add or delete phone numbers from the FDN list saved on the active SIM card.

Voicemail Service

Select a voicemail service. The default setting is to use the carrier's voicemail service.

Voicemail Settings

Set the phone number used to access and manage your voicemail. If your carrier requires a password after the phone number, insert a comma (,) between the phone number and password to add a pause.

Note: If you modify the voicemail retrieval number, reboot the terminal to complete the update.

Call Forwarding

Configure when a call should be forwarded (i.e., always, when busy, when unanswered, and/or when unreachable).

Additional Settings

The phone reads settings from the network stored on the SIM card and then displays the available options from the carrier on the screen (e.g., Caller ID or Call Waiting). To customize the settings, tap the checkbox to enable or disable the feature or tap the menu arrow to see more options.

Internet Call Settings

Configure and manage Session Initiation Protocol (SIP) calls on Internet Protocol (IP) networks.

Note: An active Wi-Fi connection is required for SIP calls.

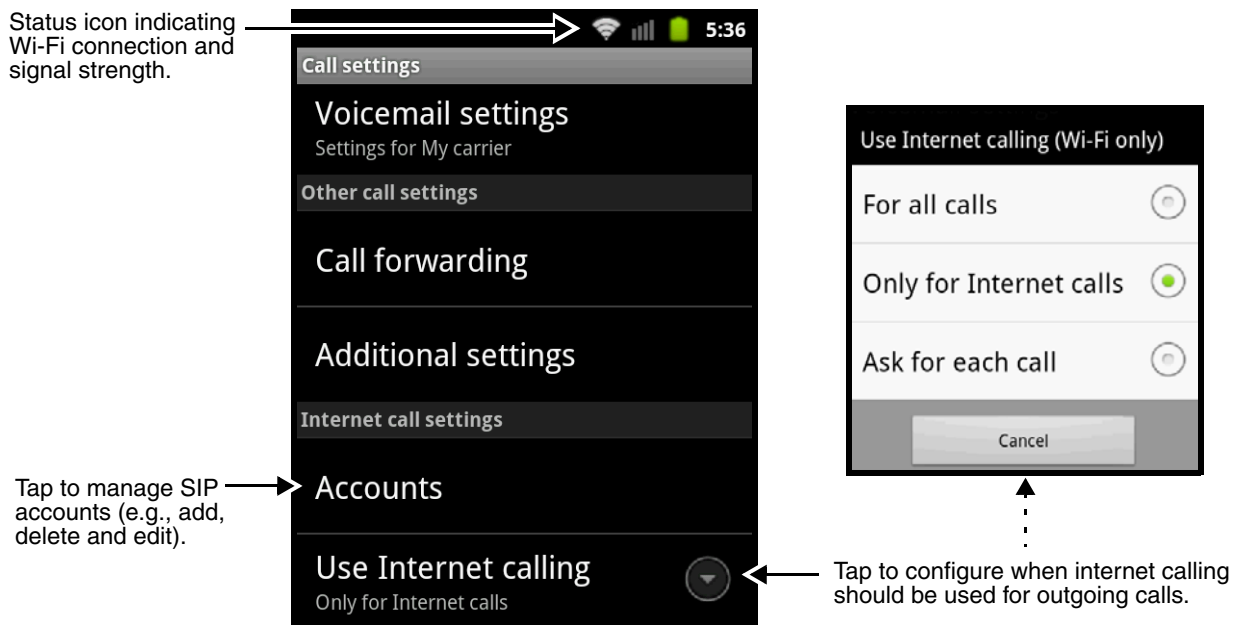

The **Accounts** menu under the “Internet Call Settings” heading enables you to add, delete or edit accounts and manage how Session Initiation Protocol (SIP) calls on Internet Protocol (IP) networks are handled.

Note: To complete the setup screens, you need to obtain information from your internet service provider (e.g.,.

To **add** an Internet calling account:

1. Tap **Launcher**  > **Settings** > **Call Settings**
2. Tap **Accounts** under the “Internet call settings” heading on the Call settings menu.

3. Tap the **Add account** button.

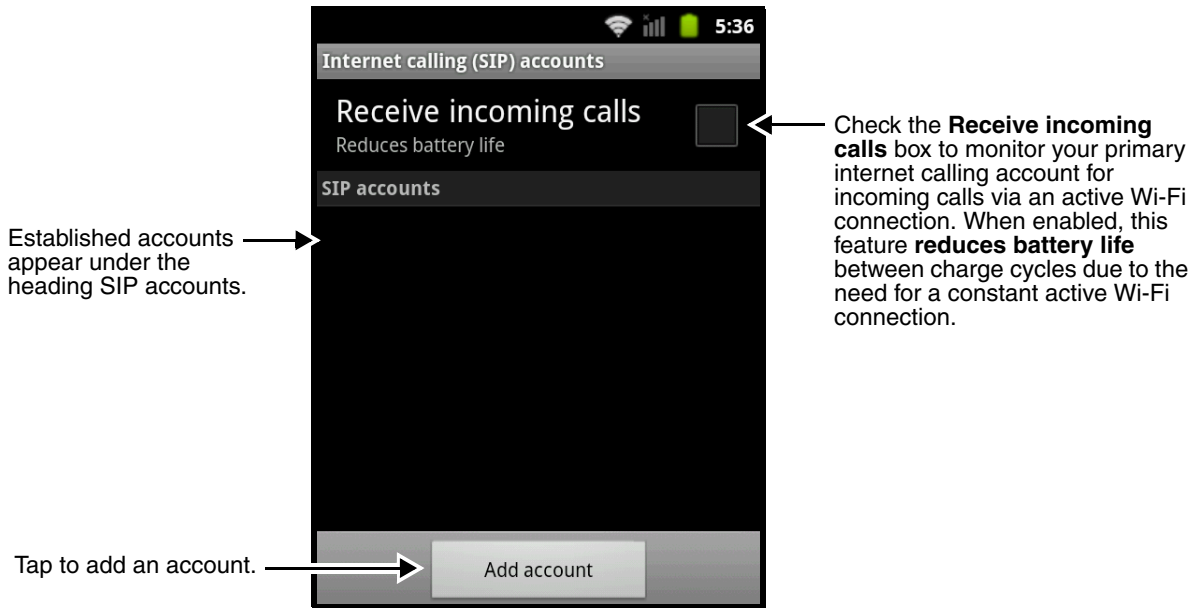

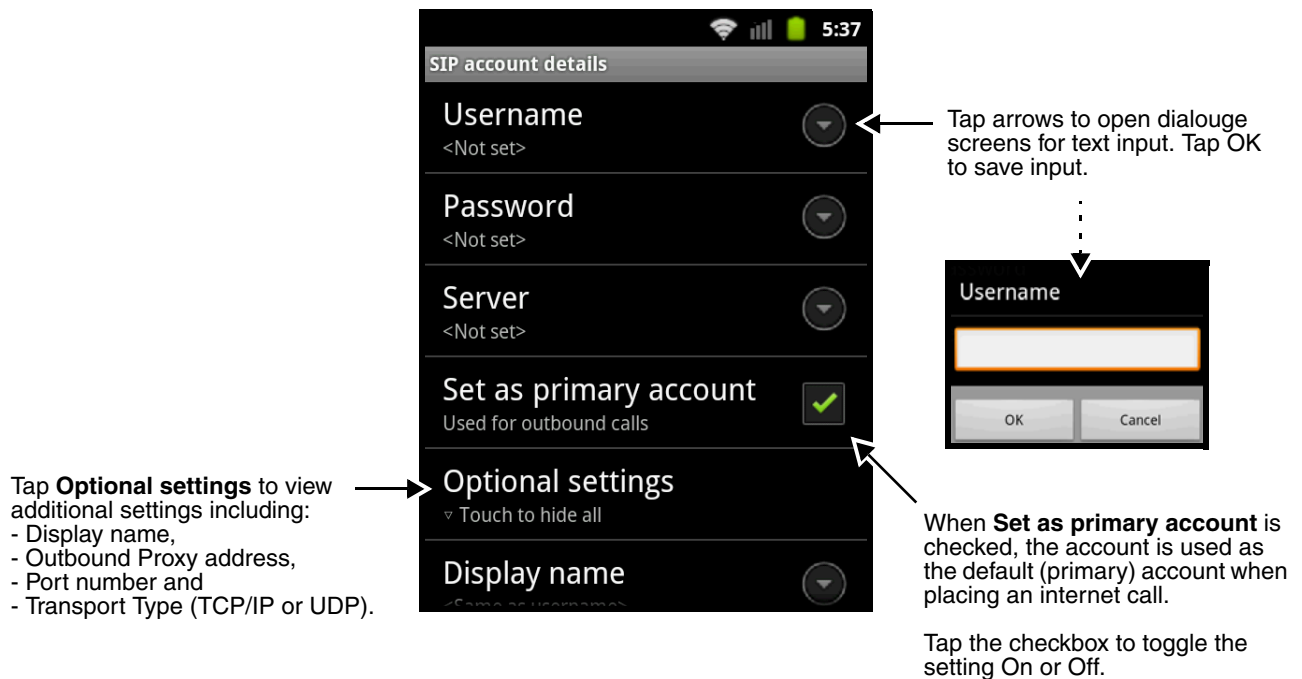

4. Enter the appropriate configuration settings according to your Internet calling service provider.



5. Press the **Menu** key, then tap **Save** .
6. Once added, the new account is listed under the “SIP accounts” heading on the **Internet calling (SIP) accounts** screen.

To **delete** or **edit** an Internet calling account:

1. Tap **Launcher**  > **Settings** > **Call Settings** > **Accounts**
2. Tap the account you want to edit or delete from **SIP accounts** list.
3. Edit the account information on the **SIP account details** screen.
4. Press the **Menu** button on the terminal's keypad.
5. Tap **Save**  to keep your edits or **Discard** to delete the SIP account.

Using the Dolphin terminal for Data Communication via a Mobile Network

The Mobile Network settings screen provides options for you to setup and configure the terminal for data communication over your service provider's mobile network.

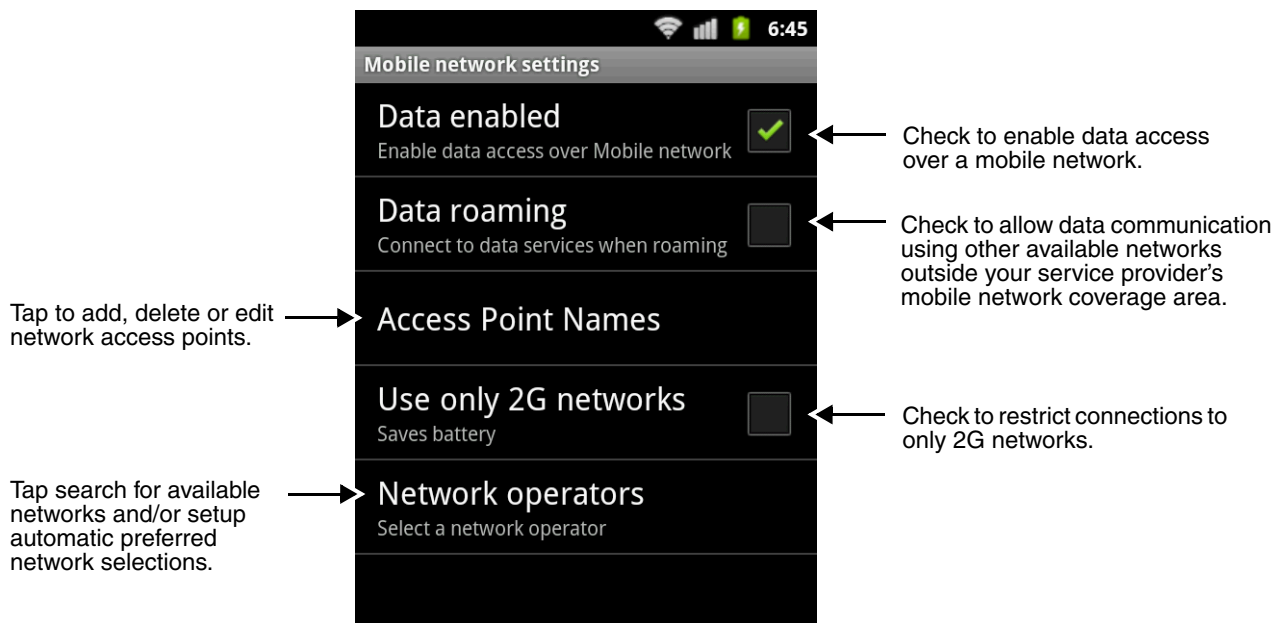

Requirements

Using a mobile network for data communication requires:

- an active network subscription to a GSM/HSPA+/UMTS/GPRS/EDGE network and
- an installed SIM card that has been activated by a network service provider.

Adding or Editing an Access Point Name (APN)

Note: To complete the APN setup screens, you may need to ask your wireless network provider for the correct settings to use (e.g., APN name, proxy name, server type, port, type of Socks protocol used, and your user name and password) if you do not already have the information.

1. Tap **Launcher**  > **Settings** > **Wireless & networks** > **Mobile networks**.

-
2. Tap **Access Point Names** to view a list of any APNs already setup on the terminal.

Note: Your current wireless service provider is selected by default on the APN list.

3. On the list displayed, tap the APN you want to edit. Or, if you are adding an APN, press the **Menu** key, then tap **New APN**.
4. Enter new or modify the existing APN settings on the **Edit access point** screen.

Note: Ask your wireless service provider for the correct settings if you are unsure of the information required.

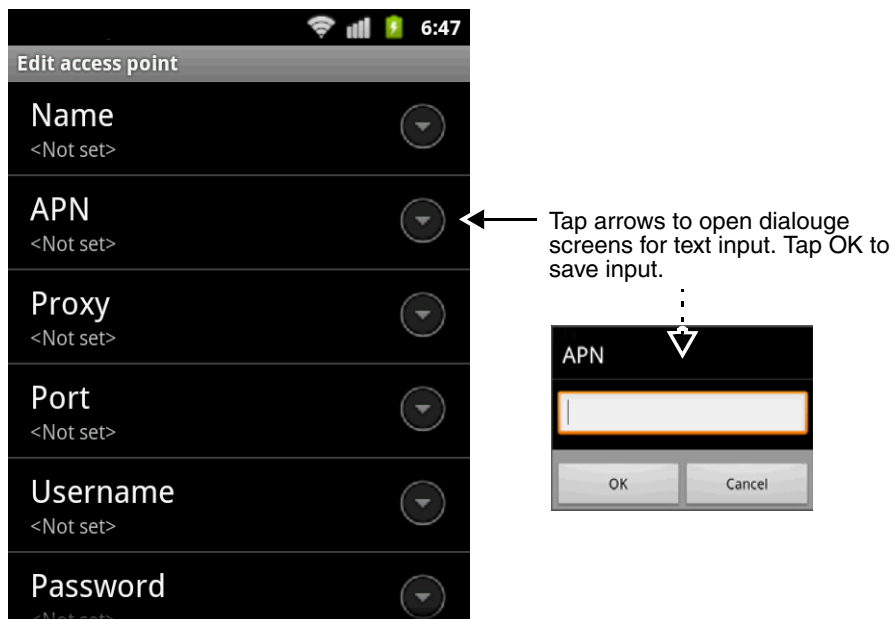

5. Press the **Menu** button on the terminal's keypad.
6. Tap **Save**  to keep your edits.
7. If you created a new APN connection, the name now appears on the APNs list. To establish a data connection using the new APN, tap on the name.

*Note: The **Data enabled** box must be checked on the Mobile networks screen for data communication using the new APN.*

8. The network icon  in the status bar indicates the GSM radio is attempting to connect.

Note: When the device is on a 2G (EDGE/GPRS) network, a data connection failure occurs if the phone is in use for a voice call while attempting a data connection. Simultaneous voice and data use is only supported if the device is on a 3G network. In 2G mode, a voice call takes precedence over data connections. Active data connections are placed in "park" mode automatically and the data is "retrieved" when the voice call ends.





Working with the Bluetooth Radio

Enabling the Bluetooth Radio

You enable the Bluetooth radio from the Wireless & network settings menu under the Settings app.

To activate the Bluetooth radio:

1. Tap **Launcher**  > **Settings**  > **Wireless & network settings**.
2. Tap the **Bluetooth** check box to activate the Bluetooth radio. Once the Bluetooth radio is activated, the terminal automatically starts searching for discoverable devices.

Note: When the radio is activated (i.e., transmitting a signal), a  shows in the status bar.

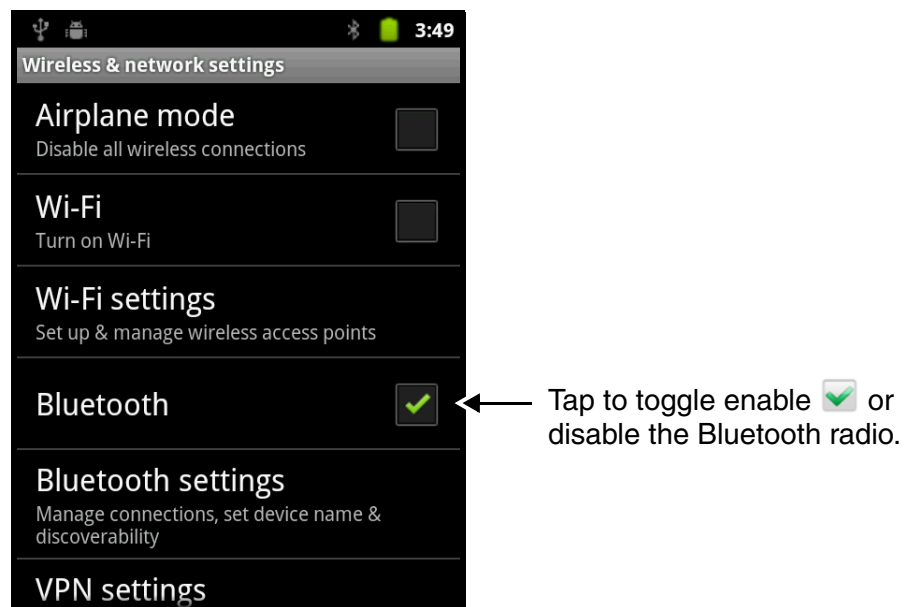

Pairing and Trusted Devices



The terminal supports pairing with other devices using Bluetooth technology. Pairing happens during general connection setup. Paired devices are “trusted” devices. This means that there is unrestricted access to all services (including services that require authorization and authentication).

A connection can exclude pairing. A device that is connected to the terminal but not paired with it is considered an untrusted device. Content can still be passed to untrusted devices by requiring authorization with each attempt (for example, with the initialization of a file exchange).

Connecting to Other Bluetooth Devices



To connect to other bluetooth devices, you need to perform a device search, select a discovered device, and then connect to the selected device. Pairing happens as part of the connection process.

1. Make sure the bluetooth device you are attempting to connect to is in range and set to be discoverable by other bluetooth devices.

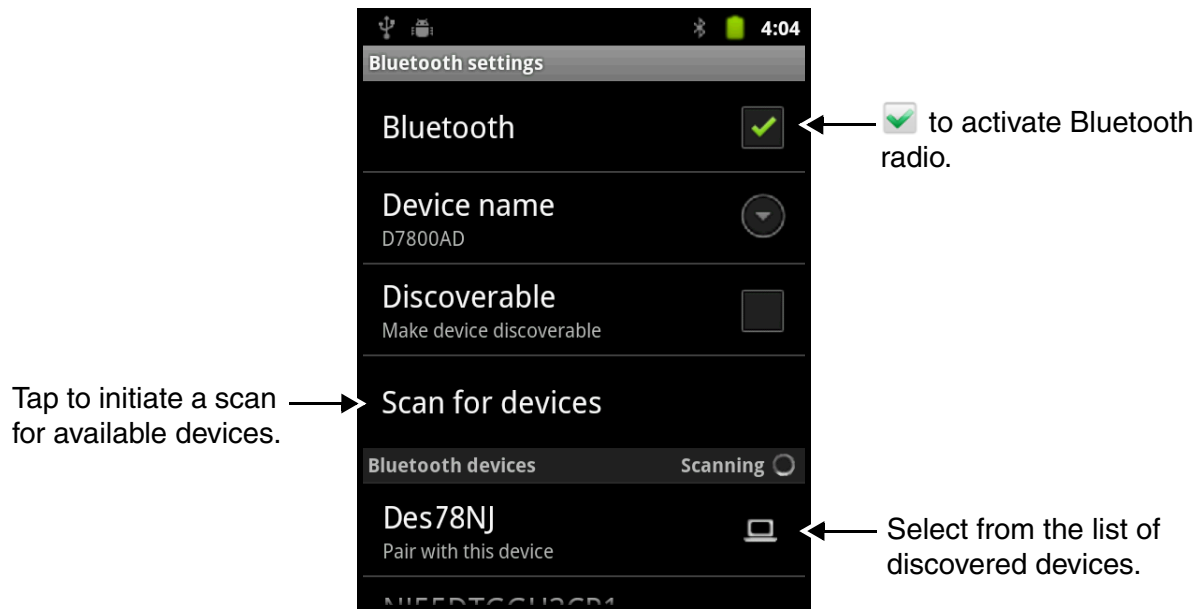
-
2. Tap **Launcher**  > **Settings**  > **Wireless & network settings** > **Bluetooth settings**.
 3. Verify the Bluetooth radio is activated. The Bluetooth box should be checked.
 4. Tap **Scan for devices** to refresh the scan started when the Bluetooth radio was first activated.
 5. Tap on the name of the device you want to connect to on discovered device list.



6. The Bluetooth radio attempts to connect with the device.
 - a. If the device has a specific passcode, enter it when prompted.

Note: When attempting to connect to a printer or headset with Bluetooth capabilities, the passcode may default to either 1111 or 0000. If there is no default, consult the device literature for the number.
 - b. If the device does not have a specific passcode you are prompted to confirm the pairing with a random passkey. Tap **Pair** on both devices to verify the pairing.
7. When the devices are paired successfully, "Paired" appears under the device name on the Bluetooth device list and the status bar icon changes from  to .

Disconnect a Bluetooth Device

1. Tap and hold the device name on the **Bluetooth settings** screen, then tap **Unpair**.



Making the Terminal Discoverable

By default, the Dolphin terminal is not discoverable, which means that the terminal will not be found by other Bluetooth devices.

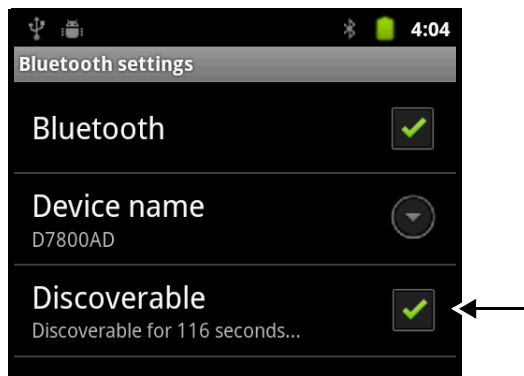

1. To make the terminal discoverable, tap **Launcher > Settings**  **> Wireless & network settings > Bluetooth settings**
2. Tap the **Discoverable** check box. The terminal starts a 120 second count down during which time the terminal is temporarily discoverable by other devices using Bluetooth technology.

Note: The Bluetooth radio must be enabled to make the device discoverable.



Sharing Pictures and Video

Before attempting to transfer files, make sure the receiving Bluetooth device is in range of the terminal, set to be discoverable by other devices, and set to receive incoming beams if another Dolphin terminal with Windows Mobile or Windows Embedded Handheld.

1. Verify the Dolphin terminal's Bluetooth radio is enabled. See [Enabling the Bluetooth Radio](#) on page 10-1.
2. Tap **Launcher**  > **Gallery** .
3. Tap on the album that contains the picture or video you want to share.
4. Press the UP or Down navigation key to select the picture or video, then press the MENU key.

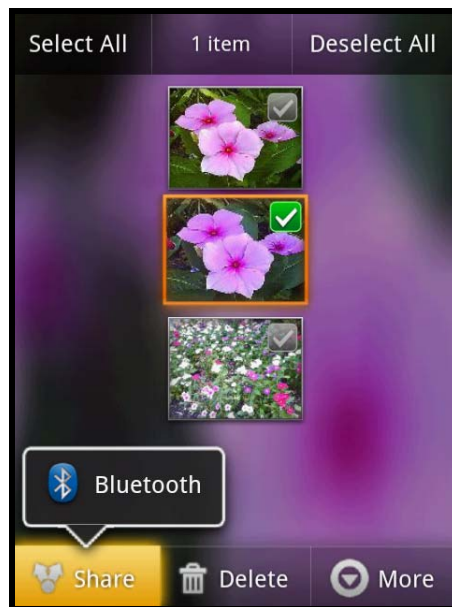

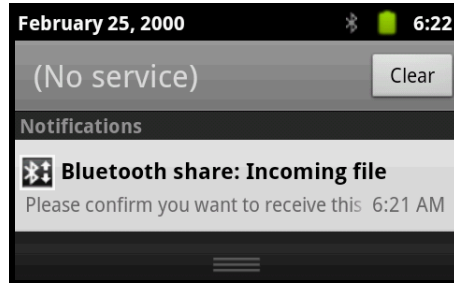

5. Tap **Share**, then **Bluetooth**.
6. The Bluetooth Settings screen opens. Do one of the following:
 - a. Tap **Search for devices**, then tap the name of the receiving device from the discovered device list.OR
 - b. Tap on the name of an already paired device from the Bluetooth device list.
7. A pop-up message notifies you the file is **Sending** and the upload notification icon  appears on the status bar.
8. Accept the file transfer on the receiving device. The acceptance procedure depends on the device's OS and security protocols.

-
- a. If the device is another Android device, a Bluetooth incoming file notification icon  appears on the status bar. Drag down the **Notification panel**, then tap on the **Bluetooth Incoming file notification**.

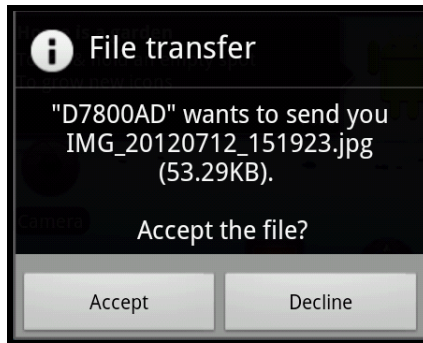

- b. Tap **Accept** to allow the file transfer.



- c. A pop-up message notifies you the device is downloading the file and the file location. The download notification icon  appears on the status bar.
- d. Drag down the **Notification panel** on either device, to verify if the file transfer was complete.

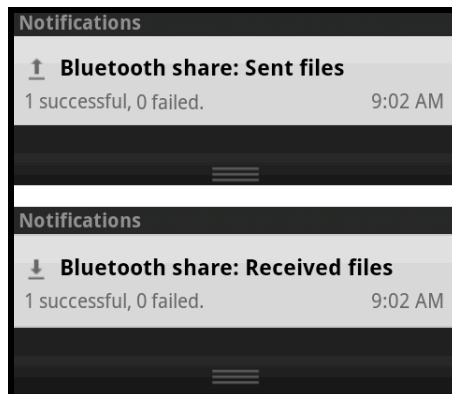



Dolphin 7800 HomeBase Device (Model 7800-HB)

Overview

The Dolphin 7800 HomeBase (Model 7800-HB) is a charging and communication cradle that supports USB Hi-Speed 2.0v communication, which enables the terminal to interface with the majority of PC-based enterprise systems. The HomeBase also contains an auxiliary battery well that charges a spare Honeywell standard or extended battery pack.

The 7800-HB charger is designed for use with battery standard pack models 7800-BTSC or 7800-BTSCW (Li-ion 3.7 V, 8.9 watt hour) and extended battery pack 7800-BTXC or 7800-BTXCW (Li-ion 3.7 V, 14.8 watt hour) manufactured for Honeywell International Inc., and with Dolphin 7800 model terminals.



Warning! *The HomeBase is not designed for use in hazardous locations.*



We recommend use of Honeywell peripherals, power cables, and power adapters. Use of any non-Honeywell peripherals, cables, or power adapters may cause damage not covered by the warranty.

Unpacking the HomeBase

Open the shipping box and inspect the package to see that the following standard items are included:

- One Dolphin HomeBase, model 7800-HB
- One power supply (see [Power](#) on page 11-4)
- One power cord

If any items are missing or anything appears to be damaged, contact your Customer Account Representative. Keep the original packaging in case you need to return the HomeBase for service or to store the HomeBase while not in use.

Optional Equipment

A standard USB (Type A to B) cable is required when using the HomeBase for communication between the terminal and a host device.

Charging Overview

The base provides power to the intelligent battery charging system in all Dolphin terminals that senses when a full charge has been achieved and switches to a trickle charge to maintain the full charge. The base completes a full charge of the main battery pack installed in the terminal seated in the terminal well in 4 hours for the standard battery or 6 hours for the extended battery. The base completes a full charge of the battery pack in the [Auxiliary Battery Well](#) (see page 11-2) in 4 hours for the standard battery or 6 hours for the extended battery.

Note: Before attempting to use, charge, or replace the battery in the terminal, you should read the [Guidelines for Battery Pack Use and Disposal](#) on page 3-13.

Communications

Reliable data communications at speeds of up to 480 Mbps can be transmitted by the base through the Hi-Speed USB port.

Note: These bases cannot be physically connected to each other - sometimes referred to as “daisy-chained”.

Convenient Storage

The intelligent battery charging system makes this base a safe and convenient storage receptacle for your Dolphin terminal.

Capacity

The base holds one terminal and features an auxiliary battery well behind the terminal well that can charge a battery pack independently of the terminal well. This means that one base can charge two battery packs: the one installed in the terminal and a spare.



We recommend use of Honeywell Li-ion battery packs. Use of any non-Honeywell battery may result in damage not covered by the warranty.



We recommend use of Honeywell peripherals, power cables, and power adapters. Use of any non-Honeywell peripherals, cables, or power adapters may cause damage not covered by the warranty.

Parts and Functions

Front Panel

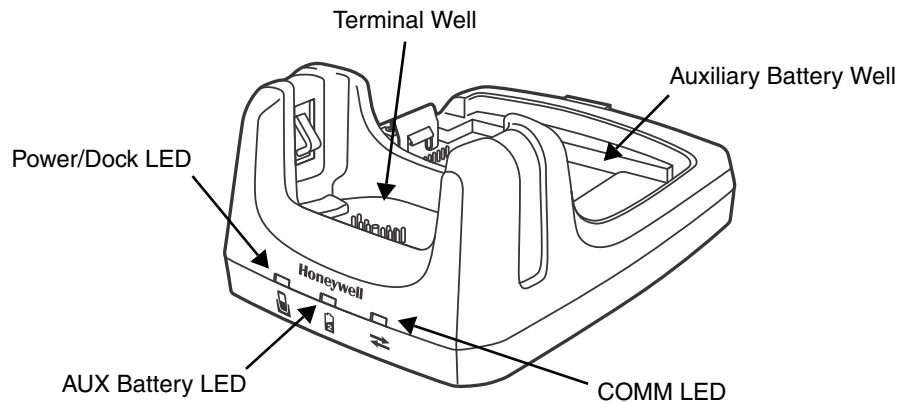

Terminal Well

Place the terminal in this well to communicate with a host device, power the terminal, and charge the installed battery pack. The base completely charges the main battery in a Dolphin terminal in 4 hours for the standard battery or 6 hours for the extended battery. If the host device is a workstation that uses ActiveSync or Windows Device Mobile, synchronization begins immediately.

Auxiliary Battery Well

See [Auxiliary Battery Well](#) on page 11-3.

Power/Dock LED

Indicates if power is supplied to the HomeBase and if a terminal is docked properly in the base.

This color	means...
Red	The HomeBase has power but no terminal is docked.
Green	The HomeBase has power and the terminal is properly seated in the base.

AUX Battery LED

Indicates status of the battery charging in the auxiliary battery well; see [Back Panel](#) on page 11-3.

This color **means...**

Orange The auxiliary battery is charging.

Green The auxiliary battery has completed charging and is ready for use.

Red, Flashing The internal temperature of the auxiliary battery is too hot or there is a battery error. Charge the auxiliary battery in a cooler environment or replace the battery with a new Honeywell battery.

For information about charging a battery in the auxiliary battery well, see page 11-5.

COMM LED

This is the communication LED. It indicates the status of data transfer between the Dolphin terminal and the host device.

This color **means...**

Green A USB Connection is established with the host workstation.

Back Panel

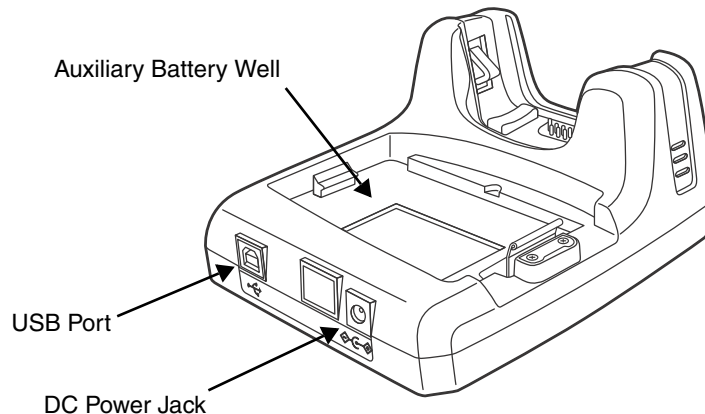

Auxiliary Battery Well

The base enables you to charge an additional battery pack independently of the terminal well in 4 hours for the standard battery or 6 hours for the extended battery. This feature ensures that you can always have a fully-charged battery for your terminal. See [Charging a Spare Battery in the Auxiliary Battery Well](#) on page 11-5.

USB Port

This USB port is USB v2.0 Hi-Speed compliant. Using a USB cable, you can connect the base to a host device, such as a workstation. USB communication occurs through Microsoft ActiveSync (v4.5 or higher) or Microsoft Windows Mobile Device Center (WMDC) depending on the host workstation's operating system. When the terminal is seated in the terminal well, it is connected to the host device via the base.

Note: ActiveSync on your Dolphin terminal works with Windows Mobile Device Center on host workstations running Windows Vista or Windows 7 and with ActiveSync on host workstations running Windows XP. For detailed information on ActiveSync and WMDC visit Microsoft's Windows Mobile Web site.

DC Power Jack

See [Power](#) on page 11-4.

Bottom Panel

For details on how to mount the HomeBase, see [Mounting the HomeBase](#) on page 11-7.

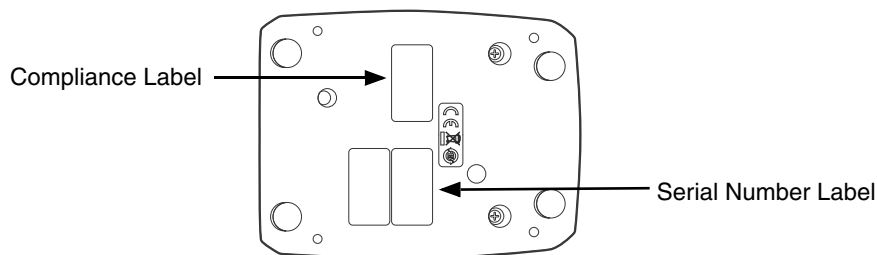

Power

The base requires 12 Volts DC input for communications, battery charging, and power output to the terminal; the power adapter included with the base converts the voltage from the AC power source to 12 Volts DC. Use only a UL listed power supply, which has been qualified by Honeywell with output rated at 12VDC and 3 amps with the device. The operating temperature range is -10° to 50°C (14° to 122°F) Honeywell recommends that you leave the base connected to its power source at all times, so that it is always ready to use.

 *We recommend use of Honeywell peripherals, power cables, and power adapters. Use of any non-Honeywell peripherals, cables, or power adapters may cause damage not covered by the warranty.*

Connecting Power to the HomeBase

1. Plug the A/C power cord into the power adapter.
2. Plug the power cable into the power connector on the back of the HomeBase.
3. Plug the A/C power cord into a grounded power source. The base is now powered. The Power/Dock LED on the HomeBase illuminates solid red to indicate the HomeBase has power and no terminal is docked.

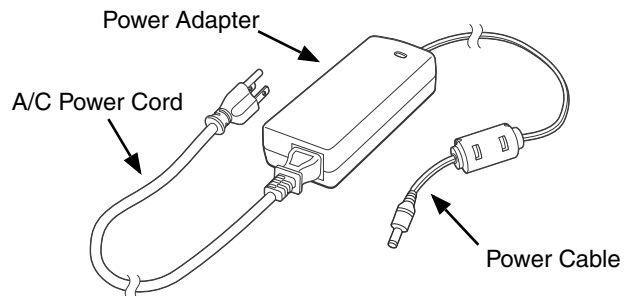

Charging the Main Battery

The base provides power to the Dolphin terminal and allows the charging of the terminal's main battery. The intelligent battery charging system incorporated into all Dolphin terminals prevents overcharging, which means that Dolphin terminals may be stored in the base indefinitely without damage to the terminals, battery packs, or the base. The base completes a full charge of the main battery pack installed in the terminal seated in the terminal well in 4 hours for the standard battery or 6 hours for the extended battery.

For more information about Honeywell battery packs and how to check battery power levels in your terminal, refer to [Checking Battery Power](#) (page 3-12) and [Batteries](#) (page 3-11).

To Power a Terminal and Charge its Main Battery

1. Install the battery pack in the terminal; see [Install the Main Battery Pack](#) on page 2-1.
2. Verify the base has power. If the Power/Dock LED is not illuminated, see [Connecting Power to the HomeBase](#) on page 11-4.
3. Slide the terminal into the terminal well. The Power/Dock LED changes to green. The charging begins immediately if required by the Dolphin terminal.

 *Ensure all components are dry prior to mating terminals/batteries with peripheral devices. Mating wet components may cause damage not covered by the warranty.*

 *We recommend use of Honeywell Li-Ion battery packs. Use of any non-Honeywell battery may result in damage not covered by the warranty.*

Charging a Spare Battery in the Auxiliary Battery Well

The auxiliary battery well located on the back of the base charges a spare battery independently of the terminal well. The Aux Battery LED on the front panel indicates the status of the battery in this well. Charge time is 4 hours for the standard battery pack or 6 hours for the extended battery pack; see [Auxiliary Battery Well](#) on page 11-3.

1. Insert the battery at an angle.
Note: Align the battery contacts with the contacts inside the auxiliary battery well.
2. Snap the battery into place with a hinging motion. The Aux Battery LED lights orange.
3. Use the AUX Battery LED to monitor the charging progress. The LED lights green when the auxiliary battery has completed charging and is ready for use.

Note: If the AUX Battery LED flashes red, the internal temperature of the battery is too hot or there is a battery error. Charge the auxiliary battery in a cooler environment or replace the battery with a new Honeywell Li-ion battery.

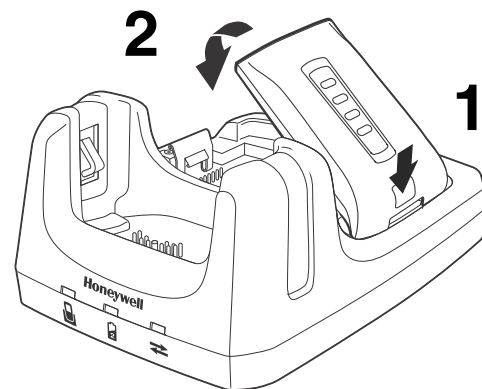
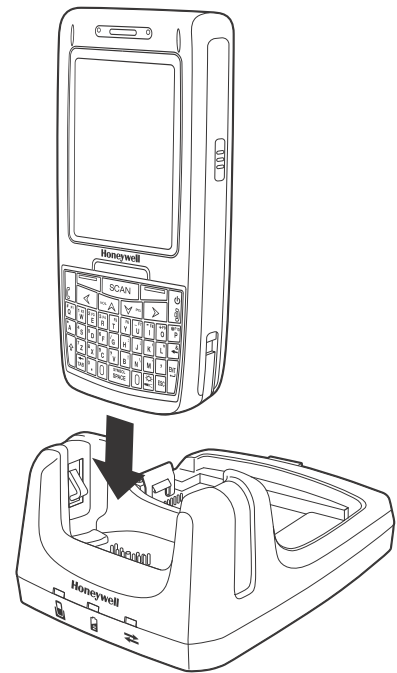

Communication

Dolphin terminals support USB communications out of the box. The base also supports USB communications via the USB port located on the back. The base acts as a USB device by interfacing the USB signals of the Dolphin terminal to the USB of the host workstation. Using a standard USB cable, the base's USB interface allows the Dolphin terminal to communicate with a workstation.

Requirements

- A base powered by a power cable and power adapter cable
- A standard USB communication cable
- A work station running Windows 98 Second Edition, Windows Me, Windows 2000, Windows NT (4.0 SP6 or higher), Windows XP, Windows Vista, or Windows 7.
- ActiveSync (v4.5 or above) or Windows Mobile Device Center on the workstation

Connecting the Communication Cables

1. Connect power to the HomeBase (see [Power](#) on page 11-4).
2. Plug the USB communication cable into the back of the base.
3. Connect the communication cable into the back of the workstation.
4. At this point, the hardware is installed and operating. You may need to reboot your workstation to complete the installation process.

Establishing Communication

USB communication with the terminal is usually auto-detected and configured by ActiveSync or Windows Mobile Device Center based on the communication cable connected.

Communicating with the Dolphin Terminal

To initiate communications between the Dolphin terminal and peripheral, complete these steps:

1. Insert the Dolphin terminal into the terminal well of the base.
 - The DOCK LED illuminates green. If the DOCK LED does not illuminate, make sure that the terminal is properly seated. You may need to remove and re-insert the terminal.
 - The Dolphin terminal activates; if the power is off, the terminal automatically powers on. If the terminal does not power on, verify that the Honeywell power supply is properly connected to the cradle and plugged into a functioning outlet.
 - If the base is connected to the workstation, the Dolphin terminal automatically opens ActiveSync or the Windows Mobile Device Center to establish a connection.
2. The base can now transfer data between the terminal and the host device. If communication does not occur, check the port connections to ensure that the cradle is correctly configured.

Verifying Communication

You can verify that the USB driver is functioning by watching the COMM LED on the USB base. When the COMM LED illuminates solid green, the base is communicating with the host device.

Note: This base cannot be daisy-chained.

Mounting the HomeBase

Set the base on a dry, stable surface, such as a desktop or workbench near an electrical outlet. Be sure to provide enough workspace with good lighting for the user to view and operate the Dolphin terminal while it is in the base. When choosing a mounting location, bear in mind that the location must allow users' easy access to the Auxiliary Battery Well and the back panel of the HomeBase where the USB port and the power jack are located.

Optional Hardware Mount

On the bottom of the HomeBase there are four mounting holes with a maximum depth of 7 mm that can be used to secure the base to a horizontal surface such as a desktop or workbench using M3 self tapping screws.

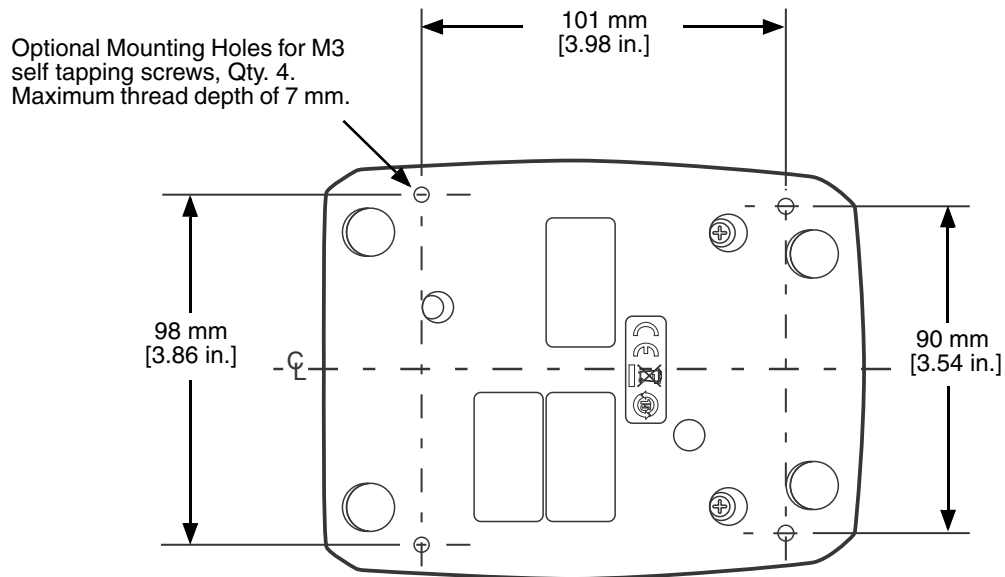



Dolphin 7800 Mobile Base Device (Model 7800-MB)

Overview

The Dolphin Mobile Base charging cradle is designed specifically for in-premise and in-transit data collection applications. The base features a mounting bracket and a cigarette lighter adapter to adapt it to your environment.

The 7800-MB charger is designed for use with Dolphin 7800 model terminals using standard battery pack model 7800-BTSC or 7800-BTCW (Li-ion 3.7 V, 8.9 watt hour) or extended battery pack model 7800-BTXC or 7800-BTXCW (Li-ion 3.7 V, 14.8 watt hour) manufactured for Honeywell International Inc.



Warning! The Mobile Base is not designed for use in hazardous locations.



We recommend use of Honeywell peripherals, power cables, and power adapters. Use of any non-Honeywell peripherals, cables, or power adapters may cause damage not covered by the warranty.

Charging Overview

The base provides power to the intelligent battery charging system in all terminals that senses when a full charge has been achieved and switches to a trickle charge to maintain the full charge. The base completes a full charge of the main battery pack in 4 hours for the standard battery pack or 6 hours for the extended battery pack.

Note: Before attempting to use, charge, or replace the battery in the terminal, you should read the [Guidelines for Battery Pack Use and Disposal](#) on page 3-13.



We recommend use of Honeywell Li-Ion battery packs. Use of any non-Honeywell battery may result in damage not covered by the warranty.

Convenient Storage

Intelligent battery charging makes the base a safe and convenient storage receptacle for your Dolphin terminal.

Mobile Base Components

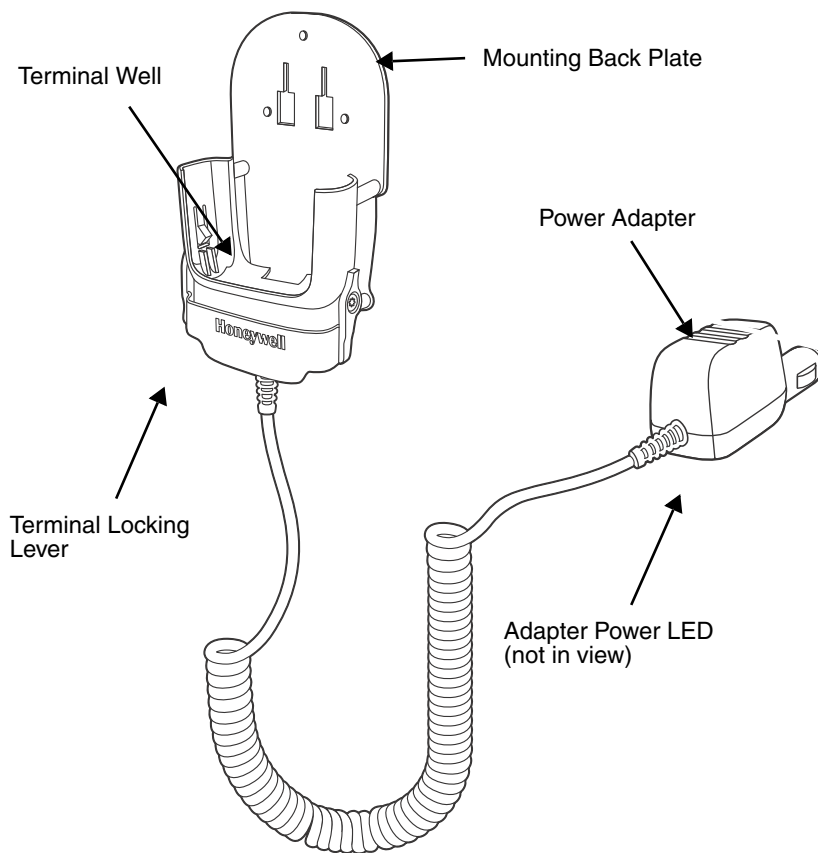

Mounting Back Plate

Used to mount the base to a fixed location.

Terminal Locking Lever

The mobile base has a locking lever on the front. When the lever is in the down position the terminal is locked in the base. To unlock the terminal push the lever up.

Terminal Well

Place the terminal in this well to charge the main battery pack.

Power Adapter

The mobile charger is equipped with a car adapter cable that can be connected to a vehicle cigarette lighter outlet.

UL listed power supply
Input: 9V-24VDC, 3.2A
Output: 5VDC 3000mA

 *Verify that the power source is always within the specified range and observe correct input voltage polarity. An improper input voltage range or reverse polarity could damage the power conversion circuitry.*

Back Panel and Mounting Brackets

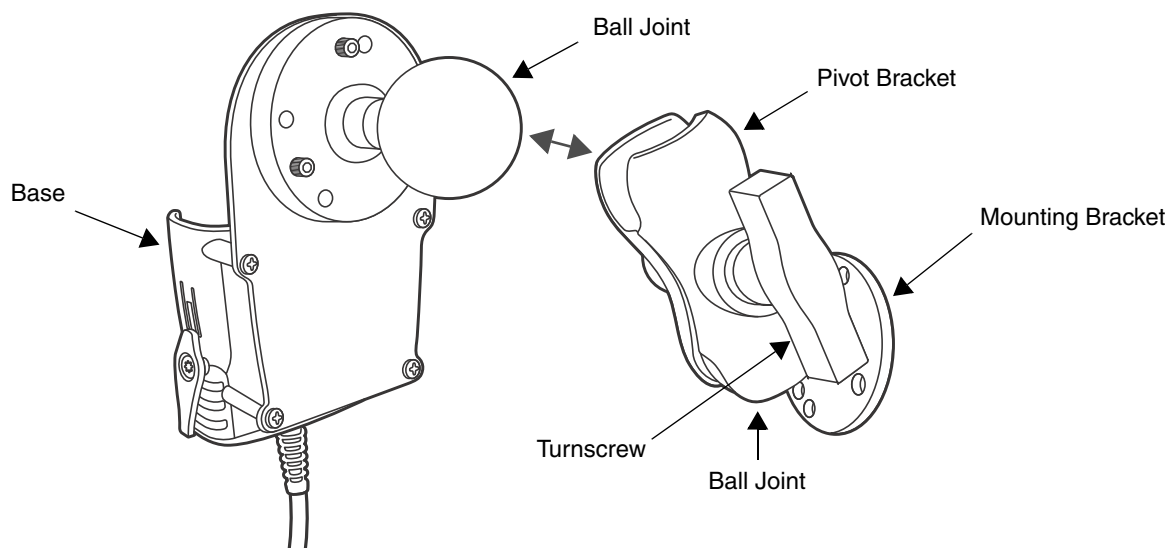

Ball Joints

There are two ball joints: one that is attached to back of the base and one on the mounting bracket. Both ball joints are inserted into the bracket and secured to mount the base.

Pivot Bracket

The bracket contains the turnscrew and two slots. Ball joints are inserted into each slot and secured with the turnscrew.

Turnscrew

The turnscrew is located on the side of the pivot bracket. Rotate the turnscrew to secure or loosen the ball joint slots.

Mounting Bracket

The mounting bracket is what you attach to the mounting surface. It is comprised of a ball joint and flat disk. The disk contains drill holes you use to secure the base to the mounting surface.







Mounting

The adjustable mounting bracket holds the terminal securely in place and gives the user a variety of options for mounting the base.

Safety Precautions

Honeywell is not responsible for any damages caused to you, your vehicle, or other individuals due to the installation of the Dolphin Mobile mount.

Follow these safety precautions when mounting the mobile base:

-  Never drill into a surface in your vehicle without first consulting a mobile installation professional experienced with your vehicle type to avoid damaging the vehicle's safety features, gas tank, electrical system or other sensitive vehicle components.
-  Do not install the Mobile base in an air bag deployment zone. Honeywell assumes no responsibility of liability for injury or death because of car crashes and/or air bag deployment.
-  Do not mount the base in a location where it prevents safe operation of the vehicle and/or impedes the vehicle operator's field of view.
-  Do not mount the base in a location where the connectors on the bottom panel of the base are not easily accessible. Be sure to leave enough room for unrestricted cable connections.
-  The Mobile base is intended for use in an enclosed space protected from the elements. Do not mount the Mobile base on external vehicle surfaces.
-  Select a mounting surface that is flat and smooth like the console area in the vehicle located between the seats.

Installation

Mounting hardware is not included. You must provide the appropriate hardware for your particular application and vehicle type. **To ensure a safe installation, consult a mobile installation professional experienced with your vehicle type.**

1. Using the bracket as a template, mark the locations for the mounting screws.
2. Drill the appropriate size pilot holes in the mounting surface.
3. Secure the mounting bracket to the mounting surface using the appropriate screw type for your application and vehicle type.
4. Loosen the turnscrew.
5. Insert the ball joint of the mounting bracket to the back of the bracket.
6. Insert the ball joint on the back of the base into the other side of the bracket.
7. Tighten the turnscrew to secure both ball joints.

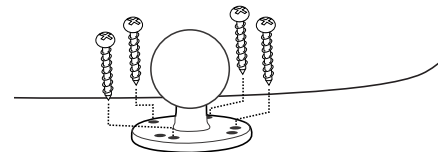



Charging the Main Battery

The mobile base provides power to the Dolphin and allows charging of the main batteries in the terminal. The main battery charges in 4 hours for the standard battery or 6 hours for the extended battery. The intelligent battery charging system incorporated into all Dolphin terminals prevents overcharging, which means that terminal may be seated in the base indefinitely without damage to the terminal, battery pack, or the base.

For more information about Honeywell battery packs and how to check battery power levels in your terminal, refer to [Checking Battery Power](#) (page 3-12) and [Batteries](#) (page 3-11).

To Power a Terminal and Charge its Main Battery

 *Ensure all components are dry prior to mating terminals/batteries with peripheral devices. Mating wet components may cause damage not covered by the warranty.*

 *We recommend use of Honeywell Li-Ion battery packs. Use of any non-Honeywell battery may result in damage not covered by the warranty.*

1. Install the main battery pack in the terminal; see [Install the Main Battery Pack](#) on page 2-1.
2. Plug the power adapter into the vehicle power outlet (e.g., cigarette lighter outlet).
3. Lift the base locking latch up.
4. Slide the Dolphin into the terminal well and lower the locking latch. Charging begins immediately if required by the Dolphin terminal.

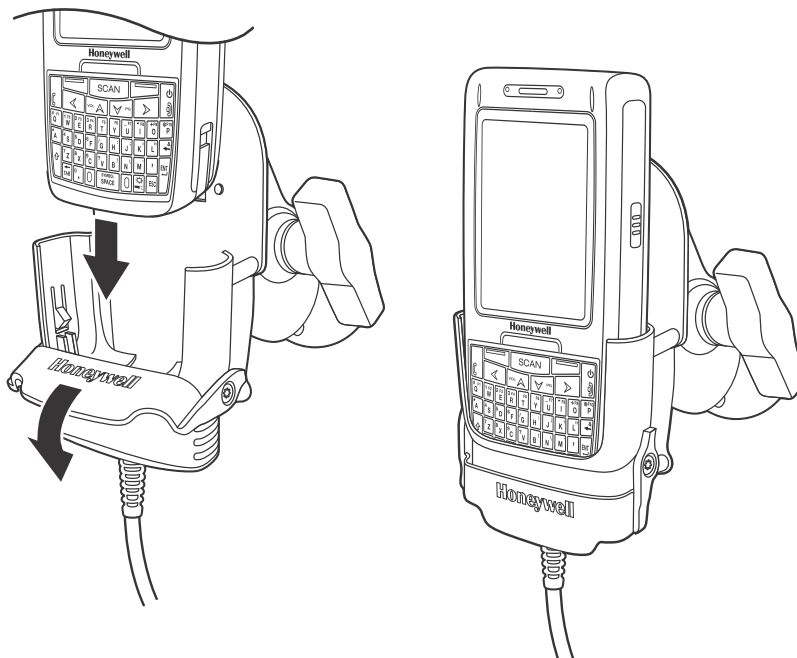



Dolphin 7800 ChargeBase Device (Model 7800-CB)

Overview

The 7800 ChargeBase is a 4-slot charging cradle that can power 4 Dolphin terminals, and charge their main batteries in 4 hours for the standard battery or 6 hours for the extended battery.

The 7800-CB charger is designed for use with Dolphin 7800 model terminals using one of the following battery pack models: standard battery pack model 7800-BTSC (Li-ion 3.7 V, 8.9 watt hour), extended battery pack model 7800-BTXC, or extended pack model 7800BTXCW (Li-ion 3.7 V, 14.8 watt hour) manufactured for Honeywell International Inc.



Warning! The ChargeBase is not designed for use in hazardous locations.



We recommend use of Honeywell peripherals, power cables, and power adapters. Use of any non-Honeywell peripherals, cables, or power adapters may cause damage not covered by the warranty.

Unpacking the ChargeBase

Open the shipping box and inspect the package to see that the following standard items are included:

- One Dolphin ChargeBase, model 7800-CB
- One power supply (see [Power](#) on page 13-3)
- One power cord

These items are needed to operate the ChargeBase. If any items are missing or anything appears to be damaged, contact your Customer Account Representative. Keep the original packaging in case you need to return the ChargeBase for service or to store the ChargeBase while not in use.

Charging Overview

The base supplies power to the intelligent battery charging system in all Dolphin terminals, which senses when a full charge has been achieved and switches to a trickle charge to maintain the full charge.

As battery packs charge, the charging circuitry follows the two-step charging process (CC-CV) that is recommended for the battery type. The process monitors changes in temperature, current, and voltage. The main battery of each terminal charges in 4 hours for the standard battery or 6 hours for the extended battery.

Note: Before attempting to use, charge, or replace the battery in the terminal, you should read the [Guidelines for Battery Pack Use and Disposal](#) on page 3-13.

Convenient Storage

Intelligent battery charging makes this base a safe and convenient storage receptacle for your Dolphin terminal.

Capacity

The base can hold up to 4 Dolphin terminals. Each charging well charges each terminal independently of the other wells.



We recommend use of Honeywell Li-Ion battery pack. Use of any non-Honeywell battery may result in damage not covered by the warranty.

Parts and Functions

Front Panel

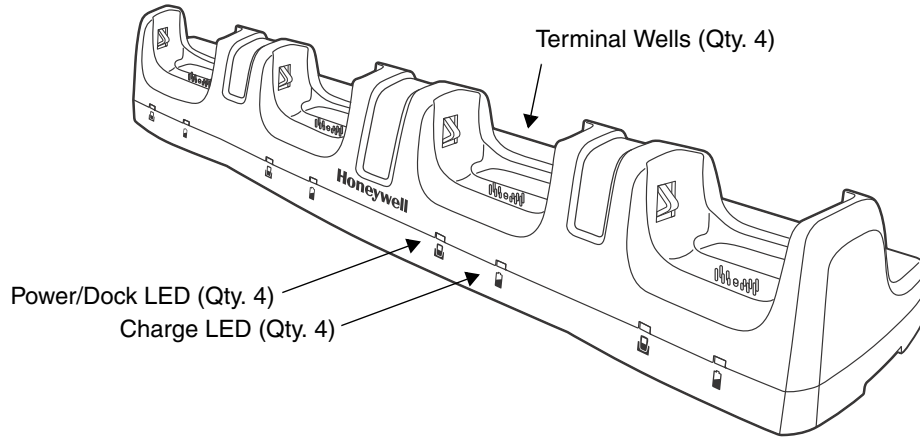

Terminal Wells

The base contains four terminal wells. Each well has its own dedicated Power/Docking LED and Charging LED indicator.

Power/Dock LEDs

The Power/Dock LED indicates if the ChargeBase has power and if the terminal is properly seated in the terminal well. Each terminal well has its own dedicated Power/Dock LED.

This color	means...
------------	----------

Red	The ChargeBase has power but no terminal is docked.
------------	---

Green	The ChargeBase has power and the terminal is properly seated in the well facilitating communication between the base and terminal
--------------	---

Charge LEDs

Each terminal well has a dedicated Charge LED located on the front of the base. When a Dolphin is docked in a terminal well, the Charge LED illuminates green to indicate power is being applied to the Dolphin. The Battery Icon in the Dolphin window  indicates the terminal is running on external power. If a battery pack is installed, the battery is charging in the background.

When the Dolphin is removed from the base, the battery icon indicates the charge level of the main battery pack, see [Status and Notification Icons](#) on page 2-5.

For details on how to charge the terminal using the ChargeBase, see [Charging the Main Battery](#) on page 13-4.

Back Panel

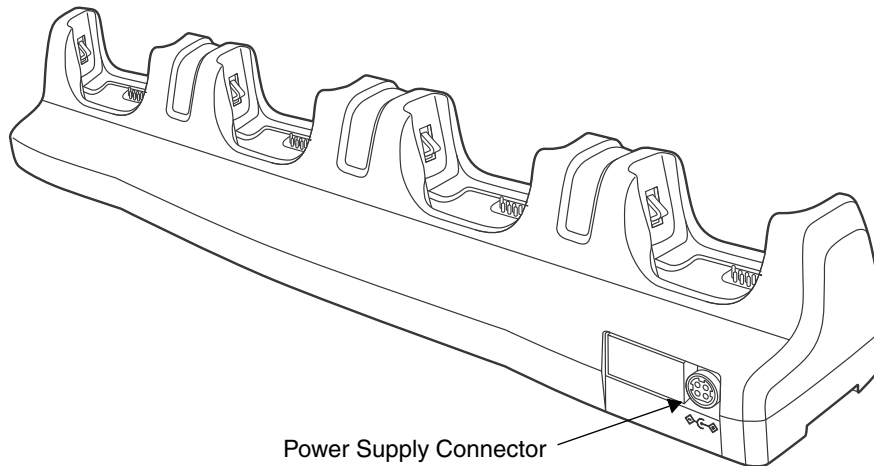

Power Supply Connector

This connector receives input from the power adapter. Plug the power connector cable from the power adapter into this connector.

Power

The terminal requires 12 Volts DC input for battery charging; the power adapter on the power cable converts the voltage from the power source to 12 volts DC. Use only a UL Listed power supply, which has been qualified by Honeywell with output rated at 12VDC and 8.5 amps with the device. The operating temperature range is -10° to 45°C (14° to 113°F).

Honeywell recommends that you leave the ChargeBase connected to its power source at all times, so that it is always ready to use.



We recommend use of Honeywell peripherals, power cables, and power adapters. Use of any non-Honeywell peripherals, cables, or power adapters may cause damage not covered by the warranty.

Connecting Power to the ChargeBase

1. Plug the A/C power cord into the power adapter.
2. Plug the power connector cable into the power connector on the back panel of the ChargeBase.
3. Plug the A/C power cord into a standard wall outlet. The LED on the Power Adapter illuminates to indicate power.
4. All of the Power/Dock LEDs illuminate red to indicate the base has power. Terminal wells with properly docked Dolphins indicate power with a green LED.
5. The base is ready to begin charging terminals.

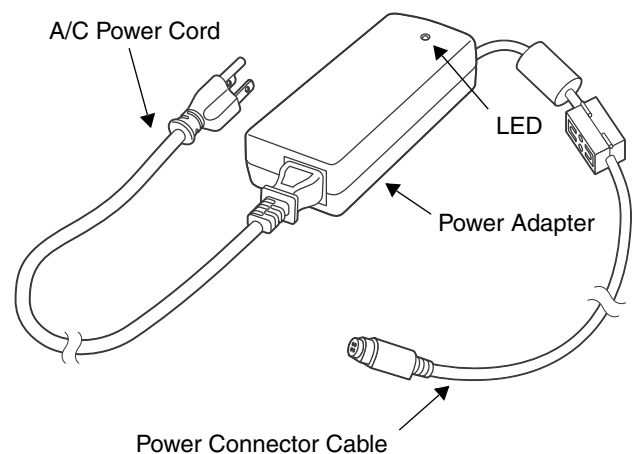

Charging the Main Battery

The base provides power to the Dolphin terminal(s) and allows charging of the main batteries in the terminals. The main battery of each terminal charges in 4 hours for the standard battery or 6 hours for the extended battery. The intelligent battery charging system incorporated into all Dolphin terminals prevents overcharging, which means that Dolphin terminals may be seated in the base indefinitely without damage to the terminals, battery packs, or the base.

For more information about Honeywell battery packs and how to check battery power levels in your terminal, refer to [Checking Battery Power](#) (page 3-12) and [Batteries](#) (page 3-11).

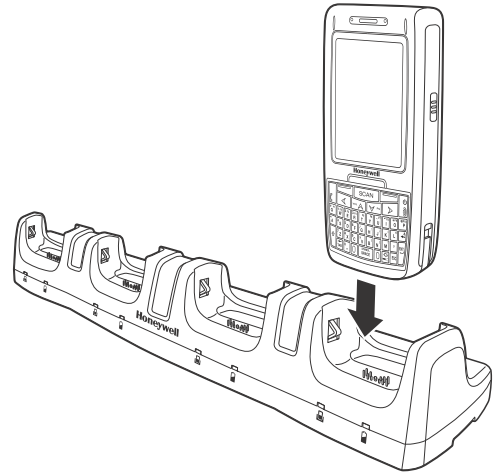

To Power a Terminal and Charge its Main Battery

1. Install the main battery pack in the terminal; see [Install the Main Battery Pack](#) on page 2-1.
2. Verify the base has power. If the Power/Dock LEDs are not illuminated, see [Connecting Power to the ChargeBase](#) on page 13-3.
3. Slide the Dolphin terminal into one of the four terminal wells. The Power/Dock LED for the well changes to green. Charging begins immediately if required by the Dolphin terminal.



Ensure all components are dry prior to mating terminals/batteries with peripheral devices. Mating wet components may cause damage not covered by the warranty.



We recommend use of Honeywell Li-Ion battery packs. Use of any non-Honeywell battery may result in damage not covered by the warranty.

Mounting the ChargeBase

This base should be mounted to a dry, stable surface. When choosing a location, always bear in mind that:

- The mounting location must allow users easy access to the power connector.
- The base should be oriented so that users can easily see the LEDs.

Bottom Panel

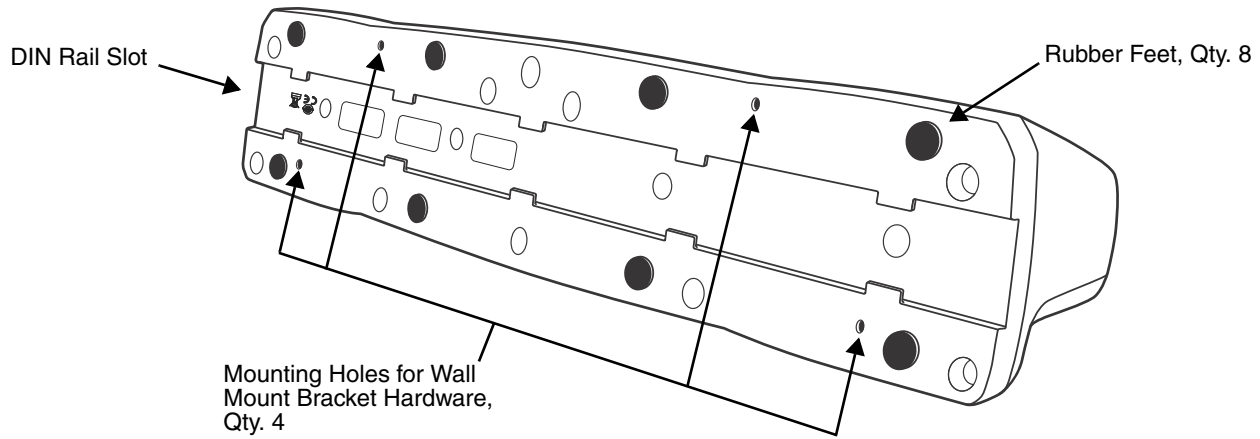

Desk Mounting

The DIN Rail (7.5 X 35 mm) slot on the bottom panel enables secure mounting on a horizontal surface.

Hardware Required

- 3/16 in. dia x 5/8 in. long pan head screw
- 1/2 in. OD x 7/32 in. ID x 3/64 in. thick
- 3/16 in. dia nut

Installing the DIN Rail

1. Slide the DIN Rail into the DIN Rail slot on the bottom panel of the base.

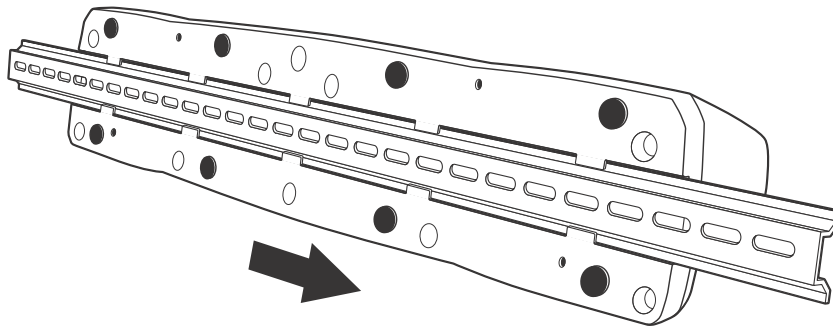

2. Turn the base and DIN Rail right side up.

- Then, using the appropriate nuts and bolts, secure the DIN Rail to a stable, flat horizontal surface.

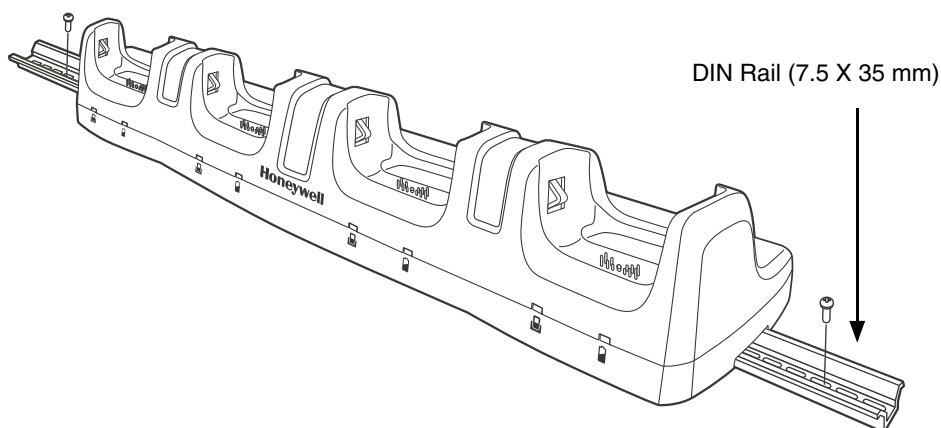

Wall Mounting

The optional wall mount bracket enables secure mounting of the base on a vertical surface. The wall mount bracket can be used in conjunction with the DIN rail but does not require the DIN Rail for use.

Hardware (Provided)

- M3 x 9 mm self-tapping screws, #2 Phillips, Qty. 4
- 3/8 in. x 4 in. round head toggle bolt, 2-5/8 in. usable length, Qty. 4
- 3/8 in. x 2 1/2 in. length Hex Head Lag Screw, Qty. 4

Tools Required

- Drill
- 7/8 in. Drill Bit (for hollow wall installations) or 1/4 in. Drill Bit (for wood stud installation)
- Phillips Screw Driver

Hollow Wall Installation

- Drill four pilot holes in the wall using a 7/8 in. drill bit.

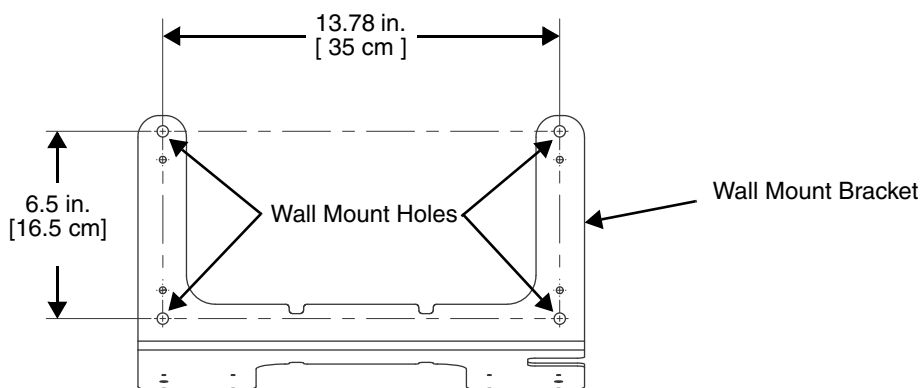

2. Slide the bolt through the wall bracket, and thread the toggle nut onto the bolt.
3. Press the ends of the toggle nut together, and insert the bolt/nut into the pilot hole until the nut clears inside wall surface. The toggle nut should spring open preventing the screw from being removed.
4. Repeat steps 2 and 3 for each of the remaining mounting holes.
5. Tighten all four bolts to secure the bracket to the wall.
6. Once the bracket is installed, secure the base to the wall bracket, see [Securing the Base to the Wall Bracket](#) for detailed instructions.

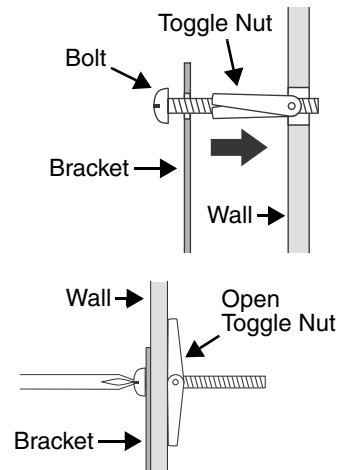

Wood Stud Installation

1. Drill four pilot holes in the wall/wood stud using the 1/4 in. drill bit.
2. Secure the bracket to the wall using the four Hex Head Lag Screws provided.
3. Once the bracket is installed, secure the base to the wall bracket, see [Securing the Base to the Wall Bracket](#) for detailed instructions.

Securing the Base to the Wall Bracket

You can secure the base to the wall bracket by using the self tapping screws provided or you can use the optional DIN Rail.

To secure the base using the self tapping screws:

1. Position the base on the wall bracket, as shown.
2. Secure the base to the bracket using the four M3 x 9 mm self-tapping screws.

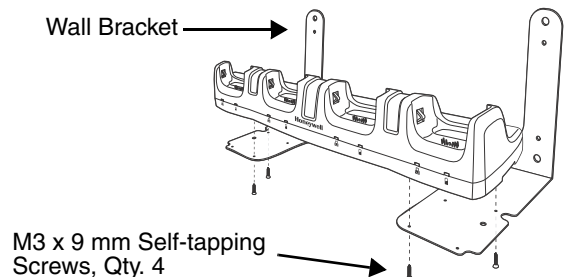

To secure the base using the optional DIN Rail:

Hardware Required

- DIN Rail, Qty. 1
- 3/16 in. dia x 5/8 in. long pan head screw, Qty. 2
- 1/2 in. OD x 7/32 in. ID x 3/64 in. thick washer, Qty. 2
- 3/16 in. dia nut, Qty. 2

1. Position the DIN Rail on the wall bracket, as shown below.
2. Slide the screw through the slot on the DIN Rail and the mounting hole in the bracket.
3. Slide the washer onto the screw and tighten the nut to secure the assembly.

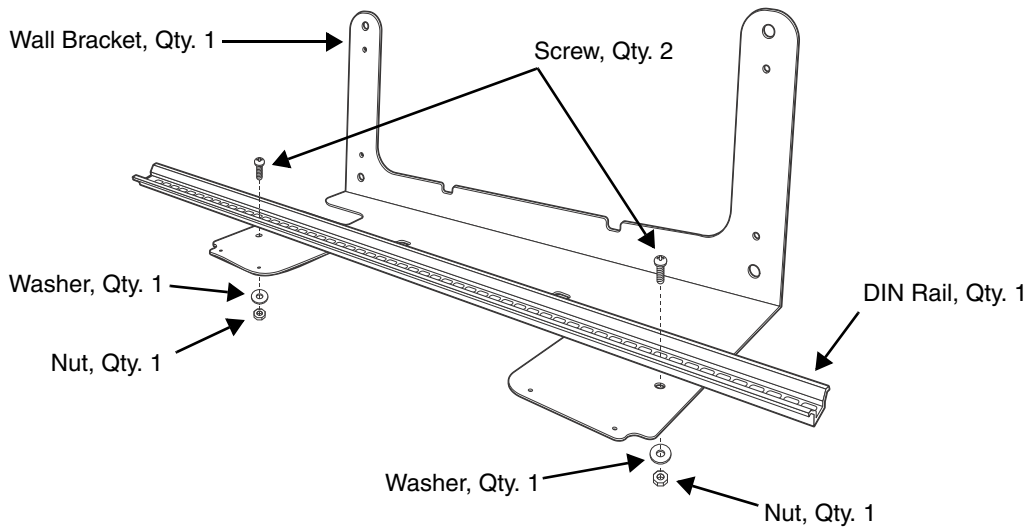

4. Remove the rubber feet on the bottom of the ChargeBase.
5. Slide the base onto the DIN Rail using the slot on the bottom of the base.

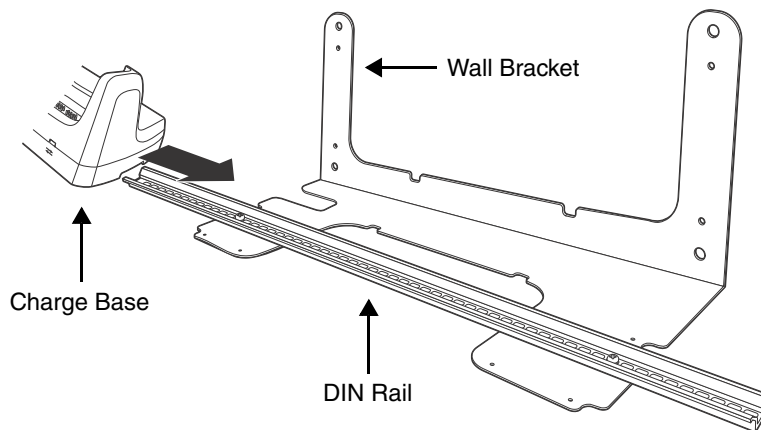

Dolphin 7800 QuadCharger Device (Model 7800-QC)

Overview

This 4-slot charging station provides intelligent battery management for the rechargeable battery packs used in Dolphin terminals.

The 7800-QC charger is designed for use with standard battery pack model 7800-BTSC or 7800-BTSCW (Li-ion 3.7 V, 8.9 watt hour) and extended battery pack model 7800-BTXC or 7800-BTXCW (Li-ion 3.7 V, 14.8 watt hour) manufactured for Honeywell International Inc.



Warning! The QuadCharger is not designed for use in hazardous locations.



We recommend use of Honeywell peripherals, power cables, and power adapters. Use of any non-Honeywell peripherals, cables, or power adapters may cause damage not covered by the warranty.

Unpacking the QuadCharger

Open the shipping box and inspect the package to see that the following standard items are included:

- One QuadCharger, model 7800-QC
- One power supply (see [Power](#) on page 14-3)
- One power cord

These items are needed to operate the QuadCharger. If any items are missing or anything appears to be damaged, contact your Customer Account Representative. Keep the original packaging in case you need to return the HomeBase for service or to store the HomeBase while not in use.

Charging Overview

Each charging slot works independently of the other three. As battery packs charge, the charging circuitry follows the two-step charging process (CC-CV) that is recommended for the battery type. The process monitors changes in temperature, current, and voltage and resets the battery pack. Charge time is 4 hours for the standard battery or 6 hours for the extended battery.

Note: Before attempting to use, charge, or replace the battery in the terminal, you should read the [Guidelines for Battery Pack Use and Disposal](#) on page 3-13.

Capacity

The charger holds 4 Honeywell standard or extended batteries.



We recommend use of Honeywell Li-Ion battery packs. Use of any non-Honeywell battery may result in damage not covered by the warranty.

Parts and Functions

Top Panel

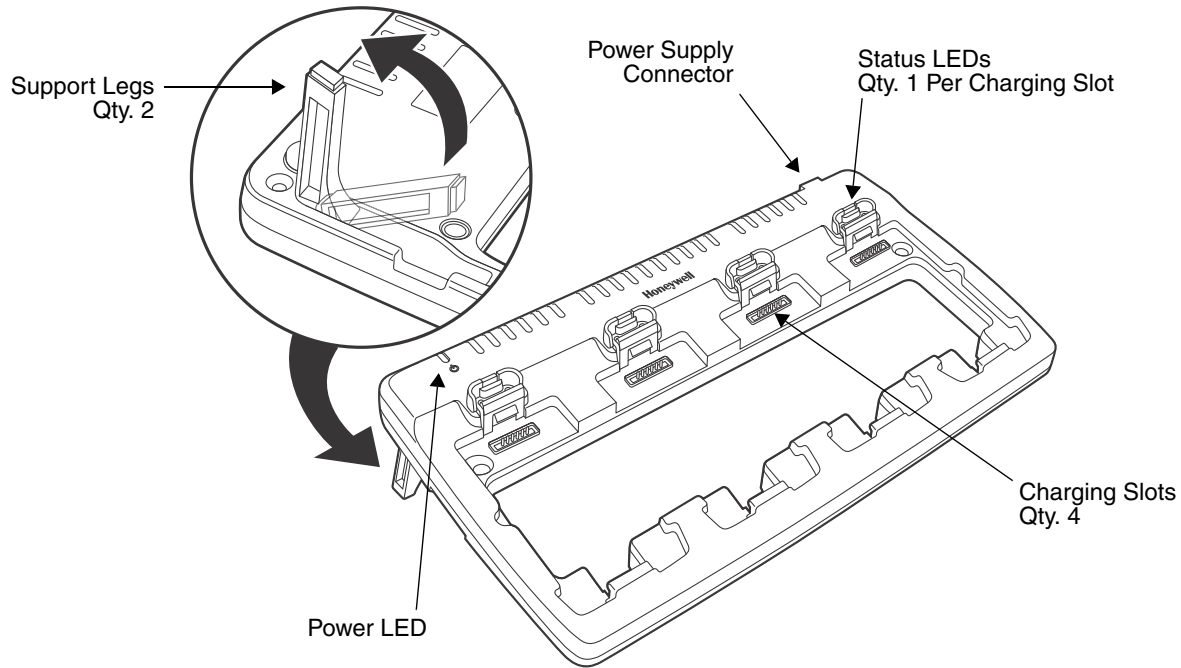

Charging Slots

There are four charging slots. Each slot holds one battery and charges it independently of the other slots. Charging immediately begins when a battery is placed in a slot.

Power LED

The power LED indicates if the QuadCharger is powered. When the QuadCharger is receiving power, the LED illuminates green.

Power Supply Connector

You attach the power supply to this connector. See [Power](#) on page 14-3.

Status LEDs

Each of the four battery slots has a dedicated status LED. The color of the LED indicates the charge status of the battery in the slot.

Color	This color indicates that the battery in the slot...
Green (Solid)	Has completed its charge cycle and is ready for use.
Orange (Solid)	Is being charged at a maximum charge rate.
Red (Flashing)	The internal temperature of the auxiliary battery is too hot or there is a battery error. Charge the auxiliary battery in a cooler environment or replace the battery with a new Honeywell battery.

For more information, see [Troubleshooting](#) on page 14-5.

Power

The charger must be connected to a power source via the Honeywell power adapter cable so that voltage is adjusted appropriately. Use only a UL listed power supply, which has been qualified by Honeywell with output rated at 12VDC and 3 amps with the device.

1. Plug the AC power cord into the power adapter.
2. Plug the power cable into the power connector on the back of the charger.
3. Plug the AC power cord into a grounded power source.
4. The power LED illuminates green, and the charger performs a self-diagnostic test that lasts approximately five seconds.

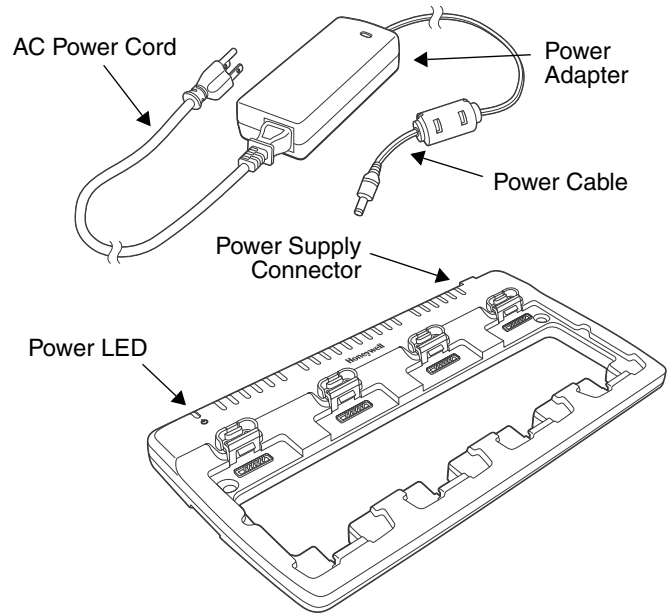

Recommendations for Storing Batteries

To maintain top performance from batteries, avoid storing batteries outside of the following temperature ranges:

- 14°F to 113°F (-10°C to +45°C) for short term storage of less than one month
- 32°F to 86°F (-0°C to +30°C) for long term storage

Do not store batteries in extremely high humidity. For prolonged storage, do not keep batteries stored in a charger that is connected to a power source.

Inserting and Charging Batteries

For best results, battery packs should be at room temperature before recharging them; temperature has a marked effect on charging. The recommended temperature range is 50°F to 95° F (10°C to 35° C).

 *Ensure all components are dry prior to mating terminals/batteries with peripheral devices. Mating wet components may cause damage not covered by the warranty.*

 *We recommend use of Honeywell Li-ion battery packs. Use of any non-Honeywell battery may result in damage not covered by the warranty.*

1. Connect power to the charger, see [Power](#) above.
2. Insert the battery at an angle.

Note: Align the battery contacts with the contacts inside the QuadCharger battery well.

3. Snap the battery into place with a hinging motion.
4. The Status LED for that particular slot illuminates orange to indicate the battery is seated properly and the charging cycle has begun.
5. When the Status LED turns green, the battery in the slot has completed charging.

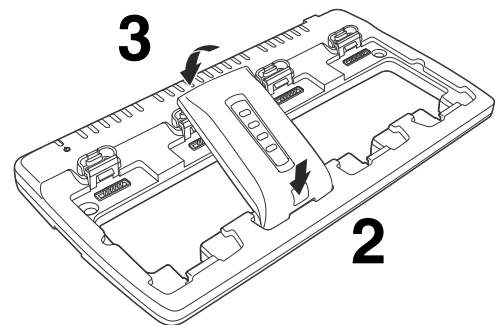

Mounting the QuadCharger

The charger should be located on a dry, stable surface and can be mounted on a flat, horizontal surface such as a desktop or workbench. When choosing a location, always bear in mind that:

- the mounting location must allow users easy access to the power connector.
- the charger should be oriented so that users can easily insert and remove battery packs and see the status LEDs.

Optional Hardware Mount

Bottom Panel

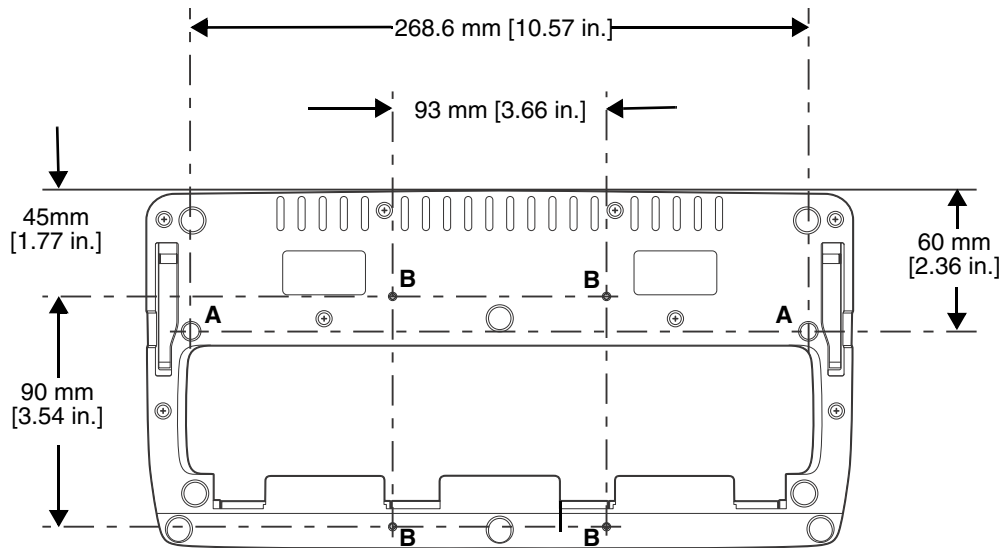

Optional Mounting Holes		
Option	Size	Qty.
A	6 mm [0.24 in.] Dia. thru hole for #6 Flat Head Phillips Dry-wall-to-Wood Screws	2
B	Mounting holes for M3 self tapping screws, maximum thread depth of 7 mm	4

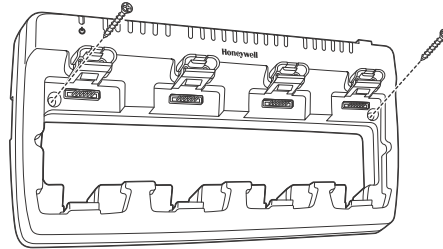

Troubleshooting

If you encounter problems with your QuadCharger device, refer to chart below for possible solutions. If problems persist, please contact Honeywell Technical Support.

Problem	Issue
The Status LED does not come on when I insert a battery pack.	Check the power connections; make sure the Power cable is inserted into the Power supply connector and the battery pack is properly seated.
The Status LED lights red during charging.	Try to charge the battery in one of the other charging slots. If the red Status LED comes on again, then the problem is associated with the battery pack. If the red status stays with the charging slot, the problem is associated with the charging circuitry.
The Status LED flashes red without a battery in the charging slot.	If a battery is in failure mode (flashing red LED), and that battery is removed from the charging slot, the slot does not reset and will continue to flash red. To reset the slot and stop the flashing red LED, insert a known good battery into the slot or recycle the power to the QuadCharger.



Product Service and Repair

Honeywell International Inc. provides service for all of its products through service centers throughout the world. To obtain warranty or non-warranty service, please visit www.honeywellaidc.com. and select **Support > Contact Service and Repair** to see your region's instructions on how to obtain a Return Material Authorization number (RMA #). You should do this prior to returning the product.

For ongoing and future product quality improvement initiatives, the 7800 comes equipped with an embedded device lifetime counter function. Honeywell may use the lifetime counter data for future statistical reliability analysis as well as ongoing quality, repair and service purposes.

Technical Assistance

If you need assistance installing or troubleshooting your device, please contact us by using one of the methods below:

Knowledge Base: www.hsmknowledgebase.com

Our Knowledge Base provides thousands of immediate solutions. If the Knowledge Base cannot help, our Technical Support Portal (see below) provides an easy way to report your problem or ask your question.

Technical Support Portal: www.hsmsupportportal.com

The Technical Support Portal not only allows you to report your problem, but it also provides immediate solutions to your technical issues by searching our Knowledge Base. With the Portal, you can submit and track your questions online and send and receive attachments.

Web form: www.hsmcontactsupport.com

You can contact our technical support team directly by filling out our online support form. Enter your contact details and the description of the question/problem.

Telephone: www.honeywellaidc.com/locations

For our latest contact information, please check our website at the link above.

Limited Warranty

Honeywell International Inc. ("HII") warrants its products and optional accessories to be free from defects in materials and workmanship and to conform to HII's published specifications applicable to the products purchased at the time of shipment. This warranty does not cover any HII product which is (i) improperly installed or used; (ii) damaged by accident or negligence, including failure to follow the proper maintenance, service, and cleaning schedule; or (iii) damaged as a result of (A) modification or alteration by the purchaser or other party, (B) excessive voltage or current supplied to or drawn from the interface connections, (C) static electricity or electro-static discharge, (D) operation under conditions beyond the specified operating parameters, or (E) repair or service of the product by anyone other than HII or its authorized representatives.

This warranty shall extend from the time of shipment for the duration published by HII for the product at the time of purchase ("Warranty Period"). Any defective product must be returned (at purchaser's expense) during the Warranty Period to HII factory or authorized service center for inspection. No product will be accepted by HII without a Return Materials Authorization, which may be obtained by contacting

HII. In the event that the product is returned to HII or its authorized service center within the Warranty Period and HII determines to its satisfaction that the product is defective due to defects in materials or workmanship, HII, at its sole option, will either repair or replace the product without charge, except for return shipping to HII.

EXCEPT AS MAY BE OTHERWISE PROVIDED BY APPLICABLE LAW, THE FOREGOING WARRANTY IS IN LIEU OF ALL OTHER COVENANTS OR WARRANTIES, EITHER EXPRESSED OR IMPLIED, ORAL OR WRITTEN, INCLUDING, WITHOUT LIMITATION, ANY IMPLIED WARRANTIES OF MERCHANTABILITY OR FITNESS FOR A PARTICULAR PURPOSE, OR NON-INFRINGEMENT.

HII'S RESPONSIBILITY AND PURCHASER'S EXCLUSIVE REMEDY UNDER THIS WARRANTY IS LIMITED TO THE REPAIR OR REPLACEMENT OF THE DEFECTIVE PRODUCT WITH NEW OR REFURBISHED PARTS. IN NO EVENT SHALL HII BE LIABLE FOR INDIRECT, INCIDENTAL, OR CONSEQUENTIAL DAMAGES, AND, IN NO EVENT, SHALL ANY LIABILITY OF HII ARISING IN CONNECTION WITH ANY PRODUCT SOLD HEREUNDER (WHETHER SUCH LIABILITY ARISES FROM A CLAIM BASED ON CONTRACT, WARRANTY, TORT, OR OTHERWISE) EXCEED THE ACTUAL AMOUNT PAID TO HII FOR THE PRODUCT. THESE LIMITATIONS ON LIABILITY SHALL REMAIN IN FULL FORCE AND EFFECT EVEN WHEN HII MAY HAVE BEEN ADVISED OF THE POSSIBILITY OF SUCH INJURIES, LOSSES, OR DAMAGES. SOME STATES, PROVINCES, OR COUNTRIES DO NOT ALLOW THE EXCLUSION OR LIMITATIONS OF INCIDENTAL OR CONSEQUENTIAL DAMAGES, SO THE ABOVE LIMITATION OR EXCLUSION MAY NOT APPLY TO YOU.

All provisions of this Limited Warranty are separate and severable, which means that if any provision is held invalid and unenforceable, such determination shall not affect the validity of enforceability of the other provisions hereof. Use of any peripherals not provided by the manufacturer may result in damage not covered by this warranty. This includes but is not limited to: cables, power supplies, cradles, and docking stations. HII extends these warranties only to the first end-users of the products. These warranties are non-transferable.

The limited duration of the warranty for the Dolphin 7800 is as follows:

- The duration of the limited warranty for terminals with an integrated imager is one year.
- The duration of the limited warranty for touch screens is one year.
- The duration of the limited warranty for the Dolphin 7800 HomeBase device, Dolphin 7800 eBase device, Dolphin 7800 Net Base device, Dolphin 7800 QuadCharger device, Dolphin 7800 Mobile Base, and Dolphin 7800 ChargeBase device, is one year.
- The duration of the limited warranty for batteries is one year.
Use of any battery from a source other than Honeywell may result in damage not covered by the warranty. Batteries returned to Honeywell International Inc. in a reduced state may or not be replaced under this warranty. Battery life will be greatly increased when following the battery instructions in this user's guide.

How to Extend Your Warranty

Honeywell International Inc. offers a variety of service plans on our hardware products. These agreements offer continued coverage for your equipment after the initial warranty expires. For more information, contact your Sales Representative, Customer Account Representative, or Product Service Marketing Manager from Honeywell International Inc., or your Authorized Reseller.



Honeywell Scanning & Mobility

9680 Old Bailes Road

Fort Mill, SC 29707

www.honeywellaidc.com