

## Matrox® M-Series™

M9120 PCIe x16 • M9120 Plus LP PCIe x1 or x16 •  
M9125 PCIe x16 • M9128 LP PCIe x16 • M9138 LP PCIe x16 •  
M9140 LP PCIe x16 • M9148 LP PCIe x16 • M9188 PCIe x16

### User Guide

20070-301-0160  
2016.05.19

---

# Contents

<b>Matrox safety information</b> .....	<b>4</b>
Installation and operation.....	4
If a power supply (internal or external) was included with your product.....	4
If your product includes laser-based technology .....	5
Repair.....	5
<b>About this user guide</b> .....	<b>6</b>
Using this guide.....	6
More information .....	6
<b>Overview</b> .....	<b>7</b>
Hardware supplied.....	7
Software available.....	7
Installation overview.....	8
<b>Installing your graphics hardware</b> .....	<b>9</b>
Before you begin .....	9
Step-by-step installation .....	10
Securing the bracket of your Matrox card .....	11
Replacing brackets on your graphics card .....	12
<b>Connecting your monitors</b> .....	<b>14</b>
Before you begin .....	14
Step-by-step connection setup .....	15
<b>Installing your Matrox software</b> .....	<b>22</b>
Before you begin .....	22
Hardware detection .....	23
<b>Matrox PowerDesk software</b> .....	<b>24</b>
Accessing PowerDesk.....	24
Accessing Matrox PowerDesk help.....	24
<b>Troubleshooting</b> .....	<b>25</b>
What to do if you have a problem.....	25
Common problems and solutions .....	25

**Product information..... 28**  
    Specifications ..... 28  
    Environmental ..... 29  
    Notes..... 30  
    Digital flat panel information ..... 30

**Customer support ..... 31**  
    Matrox Web..... 31  
    Technical support ..... 31  
    Driver and software download..... 32  
    View your warranty information..... 32  
    Register your Matrox product..... 32

---

# Matrox safety information

To ensure safe and reliable operation of your Matrox product, to avoid personal injury, and to prevent damage to your computer or Matrox hardware, read the following guidelines.

---

## Installation and operation

- Read and retain all instructions. Only use your Matrox product according to the instructions, operating ranges, and guidelines provided in the Matrox user guide and other related Matrox documentation. Failure to follow these instructions could result in damage to your product or injury to the user or installer.
- Don't expose your Matrox product to rain, water, condensation, or moisture.
- Always turn off your computer, unplug it, then wait for it to cool before touching any of the internal parts of your computer or installing your Matrox product.
- Static electricity can severely damage electronic parts. Before touching any electronic parts, drain static electricity from your body (for example, by touching the metal frame of your computer).
- When handling a card, carefully hold it by its edges and avoid touching its circuitry.
- Don't stack devices or place devices so close together that they're subject to recirculated or preheated air.
- Don't operate your system or Matrox product near a heat source or restrict airflow to your system, and make sure the ambient temperature doesn't exceed the maximum recommended temperatures. Don't block ventilation holes on your unit or system.

---

## If a power supply (internal or external) was included with your product

- Don't place the external power supply directly on top of the device.
- Only use power supplies originally supplied with the product or use a replacement that's approved by Matrox. Don't use the power supply if it appears to be defective or has a damaged chassis.
- Don't defeat the safety purpose of the polarized or grounding-type plug. A polarized plug has two blades with one wider than the other. A grounding-type plug has two blades and a third grounding prong. The wide blade or the third prong are provided for your safety. If the provided plug doesn't fit into your outlet, consult an electrician to replace the obsolete outlet.

- Make sure that nothing rests on the power cables and that the cables aren't located where they can be stepped on, pinched, or tripped over.
- Don't use damaged power cables.
- Unplug your system or device during lightning storms or if unused for long periods of time.

---

## **If your product includes laser-based technology**

- The device contains a Class 1 laser product for use only under the recommended operating conditions and guidelines. For more information, see your Matrox user guide.
- Invisible laser radiation may be emitted from disconnected fibers or connectors. Don't stare into beams or view directly with optical instruments.
- Only use optical transceivers originally supplied with the product or use a replacement that's approved by Matrox.
- For more information on laser support and compliance, see your Matrox user guide.

---

## **Repair**

- Don't attempt to open or repair a power supply unit (if one was supplied).
- Don't attempt to open or repair your Matrox product.
- If there's a fault with your Matrox product, review your Matrox warranty for more information.

---

# About this user guide

Your Matrox user guide provides information on installing and using your Matrox hardware. For information on Matrox PowerDesk software features and options, see the help file included with your PowerDesk software.

---

## Using this guide

This guide assumes you're familiar with basic functions like click, right-click and double-click, and that you're familiar with the basics of the operating system you're using. Also, we use the following conventions:

- **Bold** for headings and for references to text that appears on-screen.
- *Italics* for emphasis, file names, paths, publication titles, and new terms.
- ***Bold Italics*** for emphasis.
- Keyboard keys in square brackets, with a plus sign separating keys that you press simultaneously. For example: press [Ctrl]+[Alt]+[Del] to start Windows Task Manager.
- Arrows (“→”) to separate ordered directions. For example, “click **OK** → **Close** → **OK**” is the same as “click **OK**, then click **Close**, then click **OK**”.
- [Green](#) for cross-references. If you're viewing online, click green text to jump to what's being referenced.

---

## More information

We provide additional information in help and *Readme* files. Be sure to check for any last-minute release notes included with your product. Also, check the Matrox Web site ([www.matrox.com/graphics](http://www.matrox.com/graphics)) for the latest Matrox software, technical support, and product information.

---

# Overview

Thank you for purchasing a Matrox M-Series graphics card. This is a high-performance graphics card that supports PCIe® (PCI Express®) ×1 or ×16 compliant systems and multi-monitor setups.

---

## Hardware supplied\*

- M9120 PCIe ×16 – Matrox graphics card, 2 DVI to HD-15 adapters.
- M9120 Plus LP PCIe ×1 or ×16 – Matrox graphics card, 1 dual-monitor cable (LFH-60 to DVI), 2 DVI to HD-15 adapters.
- M9125 PCIe ×16 – Matrox graphics card, 2 DVI to HD-15 adapters.
- M9128 LP PCIe ×16 – Matrox graphics card.
- M9138 LP PCIe ×16 – Matrox graphics card, 3 mini DisplayPort to DisplayPort adapters.
- M9140 LP PCIe ×16 – Matrox graphics card, 1 quad-monitor cable (KX20 to DVI), 4 DVI to HD-15 adapters.
- M9148 LP PCIe ×16 – Matrox graphics card, 4 mini DisplayPort to DisplayPort adapters, 4 DisplayPort to DVI-D adapters.
- M9188 PCIe ×16 – Matrox graphics card, 8 mini DisplayPort to DisplayPort adapters, 8 DisplayPort to DVI-D adapters.

---

## Software available

- **Matrox PowerDesk** – to use your Matrox graphics hardware. Matrox provides 32-bit and 64-bit versions of the display driver. Matrox PowerDesk software supports Windows® 10, Windows® 8.1†, Windows® Server® 2012, Windows® Server® 2012 R2, Windows® 7, Windows® Vista®, Windows® Server® 2008, Windows® Server® 2008 R2, Windows® XP, and Windows® Server® 2003.

---

\* The hardware supplied with your Matrox product may vary depending on the SKU or part number of your product. For more information, contact your Matrox representative.

† The display driver package for Windows 8.1 also supports Windows 8.

---

## Minimum system requirements

	XDDM	WDDM
<b>Up to 8 monitors</b>	Windows XP (x32 Edition), Service Pack 3, 2 GB RAM*	Windows Vista (x32 Edition), Service Pack 2, 2 GB RAM*
<b>More than 8 monitors</b>	Windows XP (x32 Edition), Service Pack 3, 3 GB RAM*	Windows 7 (x64 Edition), 8 GB RAM

\* For display resolutions above 1920 × 1200, we recommend 4 GB of RAM or higher.

---

## Installation overview



**Note:** If your Matrox product is already partially or fully installed on your computer, some or all the installation information in this guide may not apply to you. However, this information may be useful if you need to reinstall your Matrox product.

To install your Matrox product:

- 1** Install your Matrox graphics hardware – [see page 9](#).
- 2** Connect your monitors – [see page 14](#).
- 3** Install your Matrox software – [see page 22](#).



---

# Installing your graphics hardware

This section describes how to install your Matrox card. For information specific to your computer, like how to remove its cover, see your system manual.



**Note:** Most Matrox low-profile graphics cards ship with ATX brackets compatible with most systems. If you have a low-profile system, you may need to change the ATX bracket on your graphics card to a low-profile bracket. For more information, [“Replacing brackets on your graphics card”, page 12.](#)

---

## Before you begin

To avoid personal injury and to prevent damage to your computer or Matrox hardware, read the following guidelines before installing your Matrox graphics hardware.

---

## Preventing damage to your graphics hardware

- Always turn off your computer, unplug it, then wait for it to cool before touching any of the internal parts of your computer or installing your Matrox product.
- While your computer is turned off but still plugged in, some electrical current is supplied to the motherboard. This current may prevent newly installed hardware from working properly.
- Static electricity can severely damage electronic parts. Before touching any electronic parts, drain static electricity from your body (for example, by touching the metal frame of your computer).
- When handling a card, carefully hold it by its edges and avoid touching its circuitry.
- Always try to insert or remove your card as straight as possible.

## Step-by-step installation

### 1 Open your computer and remove your existing graphics card\*

If a graphics card *isn't* already installed in your computer, skip to [step 2](#).

If a graphics card *is* already installed in your computer:

- a Using **Apps & features** (Windows 10), **Programs and Features** (Windows 8.1/7/Vista), or **Add/Remove Programs** (Windows XP) in the Windows **Control Panel**, remove any currently installed display drivers. Restart your computer for the changes to take effect.

After your computer restarts, you're prompted to install drivers for the new graphics hardware detected. Click **Cancel**.

- b Turn off your computer and all peripherals such as your monitor or printer.
- c Open the computer and remove your existing graphics card (if any). (If graphics hardware is built into the motherboard of your computer, you may need to disable it manually. For more information, see your system manual.)

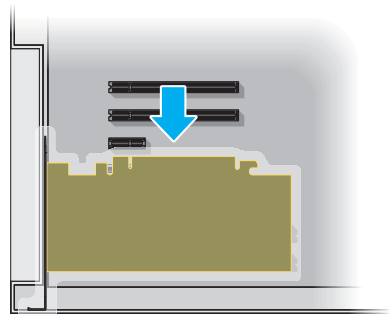

### 2 Choose an expansion slot

Most computers have different types of expansion slots. Choose a PCI Express (PCIe)  $\times 16$  or  $\times 1$  slot depending on the type of card you have. Your system manual should identify the location of each type of expansion slot in your computer.

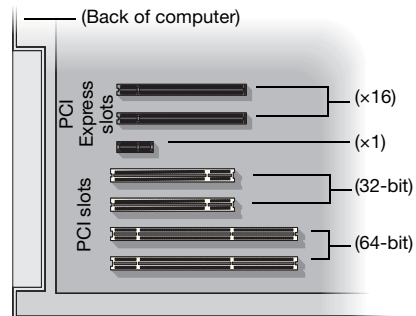

**Note:** We recommend using a PCIe  $\times 16$  slot with 16 lane support. If your system has multiple PCIe  $\times 16$  slots, your choice of PCIe slot may affect your card or system performance. For more information, see your computer manual.

\* With multi-display mode, you may be able to use your existing graphics card. For Windows XP, see Windows XP online help under "Install additional monitors". For Windows Vista, see Windows Vista online help under "Add a second monitor".



**WARNING:** Inserting your Matrox card into the wrong type of slot could damage your card, your computer, or both.

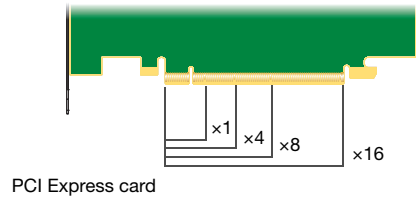

### 3 Insert your Matrox card

- a Position your Matrox card over the expansion slot you've chosen.
- b Push the card in firmly and evenly until it's fully seated in the slot.
- c Secure the bracket of your Matrox card to the computer frame.

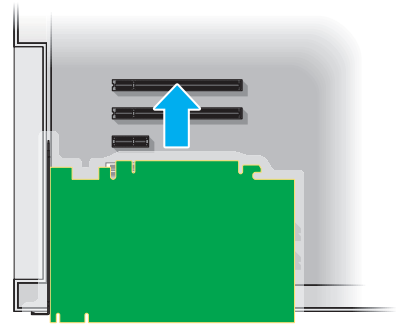

Your Matrox card is now installed. *Before restarting your computer*, connect your monitor or monitors (see “[Connecting your monitors](#)”, page 14). *After connecting*, restart your computer and install your Matrox software (see “[Installing your Matrox software](#)”, page 22).

---

## Securing the bracket of your Matrox card

**Matrox M9140 only** – To support the weight of your quad-monitor cable and avoid damaging your graphics card, you also need to secure a washer to the bracket of your graphics card.

- 1 To secure the washer, slip it over the monitor connector, then screw the washer onto the bracket of your graphics card.
- 2 Make sure the washer lies flat against the frame of your computer.

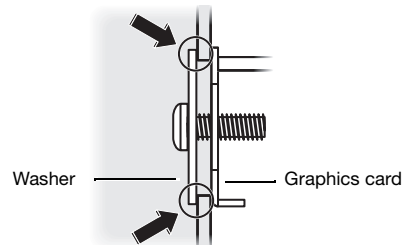
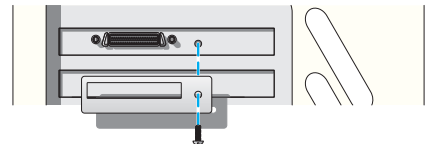

---

## Replacing brackets on your graphics card

Most Matrox low-profile graphics cards ship with ATX brackets compatible with most systems.

---

### Low-profile graphics cards

The following explains how to change brackets on your Matrox low-profile product.

- 1 Remove the current bracket from your Matrox graphics card by removing the screw on top of the graphics card, then the nuts on either side of the monitor connector.
- 2 Attach and fasten the new bracket with the two nuts you just removed.

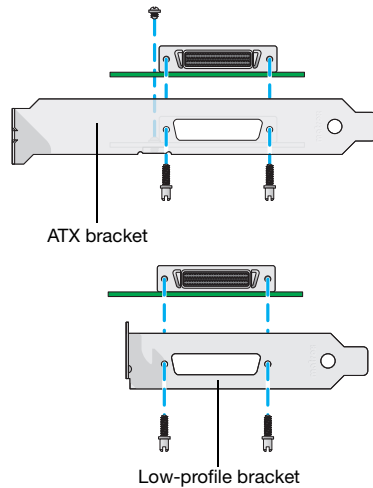

---

### DisplayPort™ low-profile graphics cards

The following explains how to change brackets on your DisplayPort low-profile product.

- 1 Remove the current bracket from your Matrox graphics card by removing the two screws on top of the graphics card.

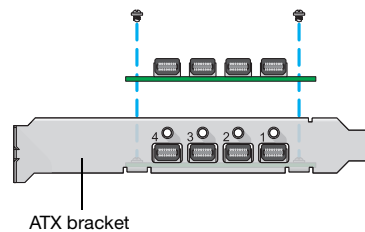

- 2 Attach and fasten the new bracket with the two screws you just removed.

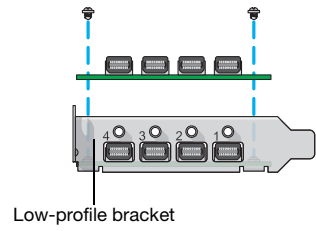

---

# Connecting your monitors

This section describes how to connect your monitors to your Matrox graphics hardware. Depending on your Matrox product, your connection setup changes (see “[Step-by-step connection setup](#)”, page 15).



**Note:** To purchase any cables or adapters not included with your Matrox product, see the Matrox online store ([shopmatrox.com](http://shopmatrox.com)).

---

## Before you begin

To avoid possible problems that could damage your monitors or prevent you from using your Matrox product, read the following guidelines before connecting your Matrox graphics hardware.

- Whenever you change your connection setup, make sure you're using the correct connectors and that all connectors are properly fastened.
- Don't change monitor connections while your computer is turned on. While your computer is turned on, it may be using monitor settings that are specific to the current monitor connections. *Some* devices may be permanently damaged if incorrect settings are used.
- Whenever you restart your computer, make sure your monitors are already turned on. Otherwise, the software may not be able to properly detect your monitors.

---

## Step-by-step connection setup

This section guides you through the step-by-step connection setup of your graphics hardware.

---

### M9120 PCIe or M9125 PCIe

#### 1 Connect the first monitor

Connect your preferred monitor to the main connector (A) on your Matrox graphics card.

If your monitor has a DVI connector, connect it directly to the main connector of your graphics card.

If your monitor has an HD-15 connector, use the DVI to HD-15 adapter included with your Matrox product to connect your monitor to the main connector.

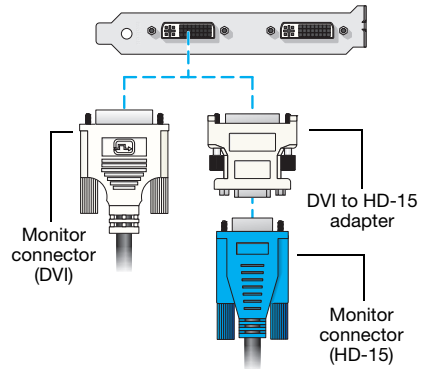

#### 2 Connect the second monitor

If your second monitor uses a DVI connector, connect it directly to the secondary connector (B) of your graphics card.

If your second monitor uses an HD-15 connector, use a DVI to HD-15 adapter included with your product to connect your monitor to the secondary connector.

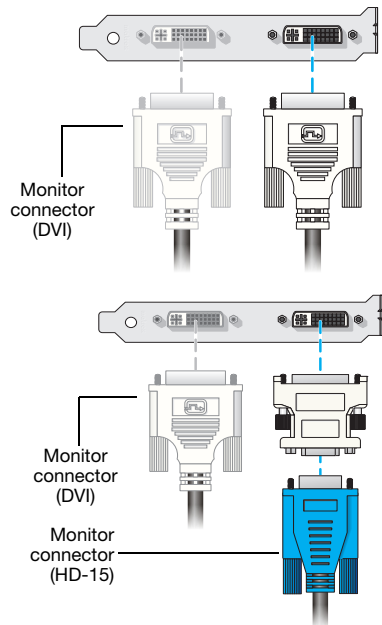

Your Matrox card is now installed. Restart your computer and install your Matrox software (see [“Installing your Matrox software”](#), page 22).

## M9120 Plus LP PCIe

### 1 Attach the dual-monitor cable

Attach your dual-monitor cable to the connector on the bracket of your Matrox card.

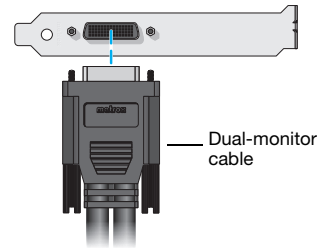

**WARNING:** To avoid damaging the LFH-60 connector on your dual-monitor cable or on your graphics card, carefully insert the connector on your dual-monitor cable as straight as possible into the connector on your graphics card. Specifically, inserting the connectors into each other at an angle is likely to bend and damage the pins on the connector of the dual-monitor cable.

### 2 Connect your monitors

If your monitor has a DVI connector, connect your monitor cable directly to the dual-monitor cable.

If your monitor has an HD-15 connector, use a DVI to HD-15 adapter included with your product to connect your monitor cable to your dual-monitor cable.

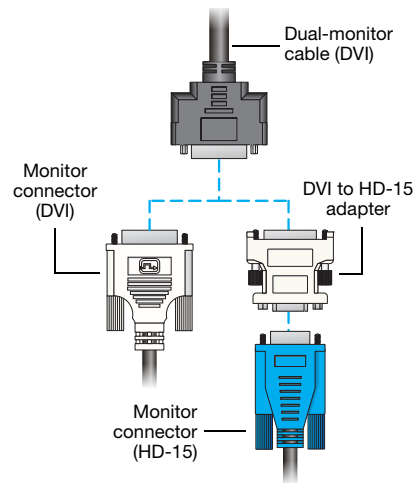

Your Matrox card is now installed. Restart your computer and install your Matrox software (see “Installing your Matrox software”, page 22).



## M9128 LP PCIe



**WARNING:** To avoid damaging the DisplayPort connector on your DisplayPort monitor cable or on your graphics hardware, carefully remove the DisplayPort cable by pressing the latch on the top of the DisplayPort connector while removing the connector.

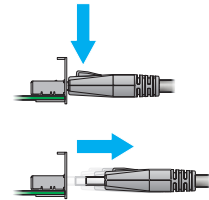

### 1 Connect the first monitor

If your monitor has a DisplayPort connector, connect your monitor directly to the DisplayPort connector labeled **1** on the bracket of your Matrox card.

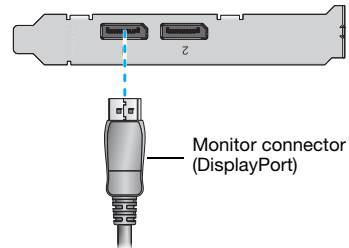

If your monitor has a DVI connector, use a DisplayPort to DVI-D adapter (sold separately) to connect your monitor cable to the DisplayPort connector.

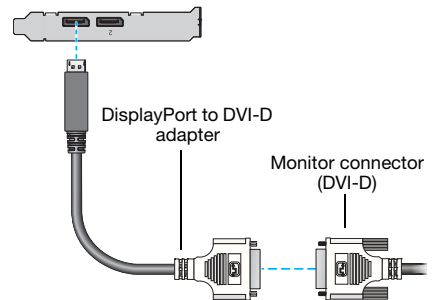

### 2 Connect the second monitor

If your monitor has a DisplayPort connector, connect your monitor directly to the DisplayPort connector labeled **2** on the bracket of your Matrox card.

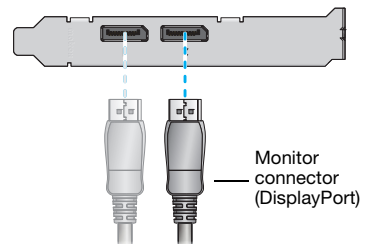

If your monitor has a DVI connector, use a DisplayPort to DVI-D adapter (sold separately) to connect your monitor cable to the DisplayPort connector.

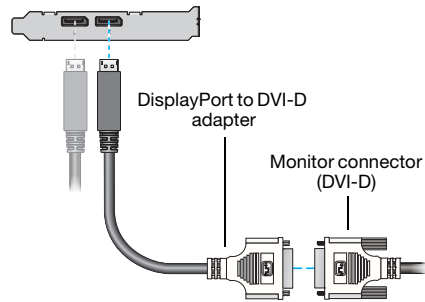

Your Matrox card is now installed. Restart your computer and install your Matrox software (see “Installing your Matrox software”, page 22).

## M9138 LP PCIe or M9148 LP PCIe



**WARNING:** To avoid damaging the DisplayPort connector on your DisplayPort monitor cable or on your graphics hardware, carefully remove the DisplayPort cable by pressing the latch on the top of the DisplayPort connector while removing the connector.

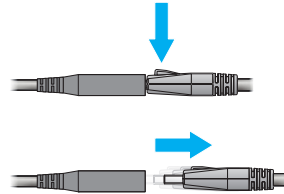

### 1 Connect the first monitor

If your monitor has a DisplayPort connector, use a mini DisplayPort to DisplayPort adapter included with your product to connect your monitor cable to the mini DisplayPort connector labeled **1** on the bracket of your Matrox card.

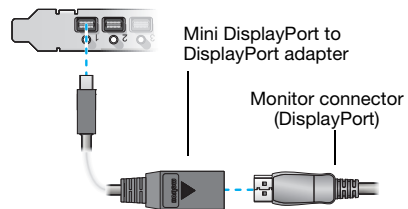

If your monitor has a DVI connector, use a DisplayPort to DVI-D adapter (sold separately for M9138 products) to connect your monitor cable to the mini DisplayPort to DisplayPort adapter.

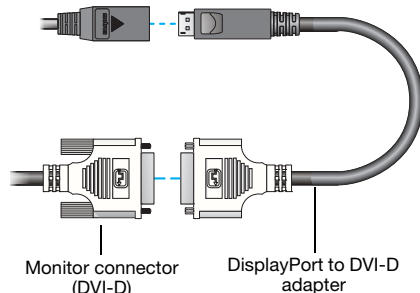

## 2 Connect the other monitors

Repeat step 1 for each monitor you want to connect.

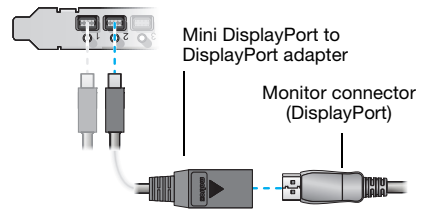

Your Matrox card is now installed. Restart your computer and install your Matrox software (see “Installing your Matrox software”, page 22).

---

## M9140 LP PCIe

### 1 Connect your quad-monitor cable

Attach your quad-monitor cable to the connector on the bracket of your Matrox card.

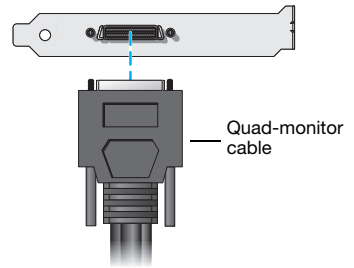

### 2 Connect your monitors

If your monitor has a DVI connector, connect your monitor cable directly to the quad-monitor cable.

If your monitor has an HD-15 connector, use a DVI to HD-15 adapter included with your product to connect your monitor cable to your quad-monitor cable.

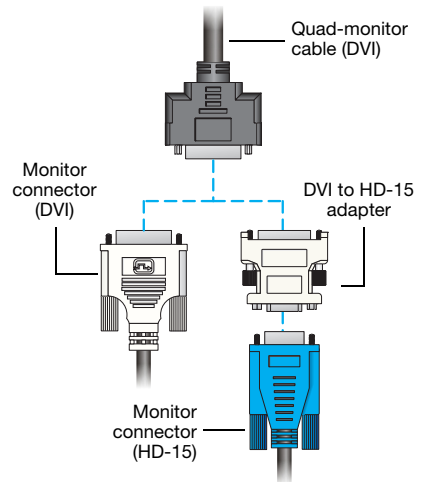



**Note:** Monitors are numbered consecutively based on which connector each is attached to. Numbering starts with the *primary display* – the one that first displays information when you restart your computer. If another graphics card is installed in your computer, display numbering may be different.

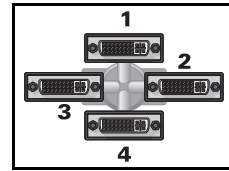

Your Matrox card is now installed. Restart your computer and install your Matrox software (see “Installing your Matrox software”, page 22).

## M9188 PCIe



**WARNING:** To avoid damaging the DisplayPort connector on your DisplayPort monitor cable or on your graphics hardware, carefully remove the DisplayPort cable by pressing the latch on the top of the DisplayPort connector while removing the connector.

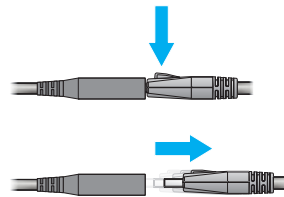

### 1 Connect the first monitor

If your monitor has a DisplayPort connector, use a mini DisplayPort to DisplayPort adapter included with your product to connect your monitor cable to the mini DisplayPort connector labeled **1** on the bracket of your Matrox card.

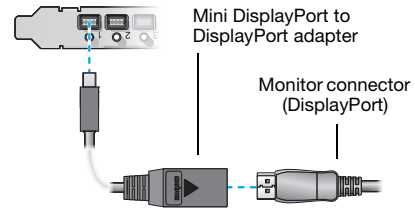

If your monitor has a DVI connector, use a DisplayPort to DVI-D adapter included with your product to connect your monitor cable to the mini DisplayPort to DisplayPort adapter.

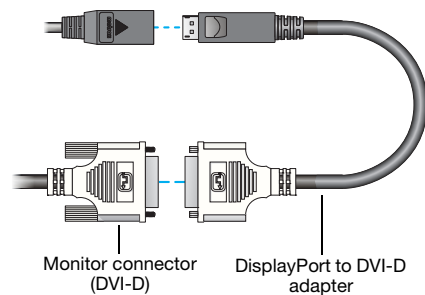

## 2 Connect the other monitors

Repeat step 1 for each monitor you want to connect.

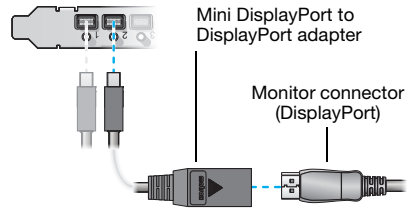

Your Matrox card is now installed. Restart your computer and install your Matrox software (see [“Installing your Matrox software”, page 22](#)).

---

# Installing your Matrox software

This section describes how to install Matrox software for *Windows 10*, *Windows 8.1\**, *Windows Server 2012*, *Windows Server 2012 R2*, *Windows 7*, *Windows Vista*, *Windows Server 2008*, *Windows Server 2008 R2*, *Windows XP*, and *Windows Server 2003*. The installation of the display driver is the same for the 32-bit and 64-bit versions.

You may need administrator rights to install certain software. For more information, see Windows documentation or contact your system administrator.

---

## Before you begin

- If your Matrox product was provided by the manufacturer of your computer, check the Web site of that manufacturer for the latest display driver. A display driver provided by the manufacturer of your computer is more likely to be tested with your computer model.
- You may need administrator rights to install or uninstall certain software. For more information, see Windows documentation.

---

## Obtaining a display driver

- Matrox makes the latest display drivers available on the Matrox Technical Support Web site ([www.matrox.com/graphics/en/support/drivers](http://www.matrox.com/graphics/en/support/drivers)).

---

## Selecting the proper display driver

Matrox makes available two types of display drivers. The display driver you install depends on the operating system you're using and the graphics hardware installed in your system:

- **Windows 10/8.1/7/Vista – WDDM** (Windows Display Driver Model) display drivers are designed and optimized for Windows versions beginning with Windows Vista. Select this display driver if you're using either Windows 10, Windows 8.1, Windows 7, or Windows Vista. Also, select this display driver if you have *only* M-Series graphics hardware installed in your system.
- **Windows 7/Vista/XP – XDDM** (Windows XP Display Driver Model) display drivers are designed for Windows XP. This is a unified display driver. Select this display driver if you have different models of graphics hardware (for example, a P-Series and an M-Series graphics card) installed in your system.

---

\* The display driver package for Windows 8.1 also supports Windows 8.

---

## Hardware detection

- **Windows 10/8.1** – Windows detects new hardware when you restart and installs a Microsoft Basic Display Driver.
- **Windows 7/Vista** – Windows detects new hardware when you restart and installs a standard VGA driver.
- **Windows XP** – Windows detects new hardware when you restart. If Matrox display drivers haven't been previously installed, Windows prompts you to install a display driver. When prompted by the **Found New Hardware** wizard to install a display driver for your graphics hardware, click **Cancel**.

---

# Matrox PowerDesk software



Your Matrox display driver includes Matrox PowerDesk software. This software helps you get the most out of your Matrox product. Use Matrox PowerDesk software to change certain display settings or access Matrox features.



**Note:** To avoid possible problems, unless otherwise specified, we recommend you use *only* PowerDesk software to change your display settings.

---

## Accessing PowerDesk

Windows 10/8.1/7 – To access Matrox PowerDesk, right-click your Windows desktop and select **Launch Matrox PowerDesk**.

---

## Accessing Matrox PowerDesk help

For information on Matrox PowerDesk software features and options, see the help file included with your PowerDesk software.

While using Matrox PowerDesk software, you can access the help file in several ways:

- From the main PowerDesk interface, click **Help and Troubleshooting** → **PowerDesk help**.
- For information on a specific feature or control on a page, click the **Help** button ( ? ) on that page.
- To find all topics that contain specific words, use the **Search** tab in the navigation window of the help file.



---

# Troubleshooting

---

## What to do if you have a problem

If you experience problems with your Matrox product:

- Make sure your Matrox card is properly installed, you're using the correct connectors, and that all connectors are properly fastened. For more information, see [“Installing your graphics hardware”](#), page 9 and [“Connecting your monitors”](#), page 14.
- Review the documentation provided with your Matrox product, including the information in this section, to see if your problem is already addressed.
- If graphics hardware is built into your computer motherboard, make sure you disable your computer's built-in graphics hardware. Also, remove any currently installed display drivers for that graphics hardware.

If your problem persists, contact Matrox. For more information, see [“Customer support”](#), page 31.

---

## Common problems and solutions

This section addresses common problems that could prevent you from using your computer or graphics hardware.

**Problem**    **Computer doesn't display information or boot after Matrox card is installed**

**Cause**    If you have more than one PCIe ×16 slot, your graphics card may be using a slot that doesn't have 16 lane support.

**Solution**    Try moving the PCIe card to another PCIe slot in your computer. For more information on the PCIe support of your system, see your system manual.

**Cause**    There may be unsupported graphics hardware in your computer.

**Solution**    If graphics hardware is built into your computer motherboard, your system may not have automatically disabled it when you inserted your Matrox card. Check your system manual for instructions on how to disable your computer's built-in graphics hardware.

## **Problem PowerDesk software isn't installed**

**Cause** Windows 10/8.1 – If the Matrox display driver was installed or updated through Windows Update automatic driver installations, Matrox PowerDesk software may not be installed.

**Solution** Run the setup program included with the Matrox display driver. The setup program automatically installs PowerDesk software for your Matrox product. For more information, see [“Installing your Matrox software”](#), page 22.

## **Problem Wrong color balance, screen image off-center, or no picture at all**

**Cause** Your monitor video controls may be improperly set.

**Solution** Adjust your monitor controls (brightness, contrast, and so on). For more information, see your monitor manual.

**Cause** Your monitor may not be properly connected (the connectors aren't properly fastened or the monitor power cable isn't firmly in place) or may have been disconnected.

**Solution** Make sure you're using the correct connectors, that all connectors are properly fastened, and that all power cables are firmly in place. For more information, see [“Connecting your monitors”](#), page 14.

**Cause** If your monitor supports multiple input sources (analog/digital), it may be configured to use the wrong source.

**Solution** Make sure your monitor is using the correct input source. For more information on selecting the input source for your monitor, see your monitor documentation.

**Solution** Change your connection setup to use a different input source. For more information, see [“Connecting your monitors”](#), page 14.

## **Problem Not all graphics cards in the computer are fully supported** (Software doesn't work with a certain graphics card, or another graphics card doesn't work at all)

**Cause** If you have different models of graphics cards in your computer, your Matrox display driver may not support all the graphics cards in your computer.

**Solution** Under Windows 7/Vista/XP, you can use different XDDM display drivers for different products. Software that depends on a specific display driver feature may not work if your graphics hardware is using different display drivers. For more information, see [“Selecting the proper display driver”](#), page 22.

**Solution** Disable or remove any graphics hardware not supported by the display driver you want to use. If there's graphics hardware built into the motherboard of your computer that's not supported by your software, see your system manual for information on how to disable this graphics hardware.

**Cause** **Windows 10/8.1/7/Vista/XP** – If the Windows method for display driver installation was used (instead of running the setup program included with your Matrox display driver), the driver may not be installed for all the graphics cards it supports.

**Solution** Run the setup program included with the Matrox display driver. The setup program automatically installs the display driver for each Matrox graphics card it supports.

# Product information

## Specifications

	M9120 PCIe	M9120 Plus LP PCIe	M9125 PCIe	M9140 LP PCIe
<b>Operating systems supported</b>	Windows 10, Windows 8.1*, Windows Server 2012, Windows Server 2012 R2, Windows 7, Windows Server 2008 R2, Windows Vista, Windows Server 2008, Windows XP, and Windows Server 2003			
<b>Digital monitor support</b>	DVI	DVI	Dual-link DVI	DVI
<b>Memory</b>	512 MB	512 MB	512 MB	512 MB
<b>Card type</b>	PCIe x16	PCIe x1 or x16	PCIe x16	PCIe x16
<b>Form factor</b>	ATX	Low-profile	ATX	Low-profile
<b>Monitors supported</b>	2	2†	2	4
<b>Connectors</b>	2x DVI	1x LFH-60	2x DVI	1x KX20
<b>Maximum analog resolution</b>	2048 x 1536	2048 x 1536	2048 x 1536	1920 x 1200
<b>Maximum digital resolution</b>	1920 x 1200	1920 x 1200	Up to 1920 x 1200, and 2560 x 1600	1920 x 1200
<b>Maximum card dimensions</b>	L: 6.600" / 16.80 cm H: 4.376" / 11.10 cm W: 0.750" / 1.91 cm	L: 6.600" / 16.80 cm H: 2.712" / 6.90 cm W: 0.750" / 1.91 cm	L: 6.600" / 16.80 cm H: 4.376" / 11.10 cm W: 0.750" / 1.91 cm	L: 6.600" / 16.80 cm H: 2.712" / 6.90 cm W: 0.750" / 1.91 cm

\* The display driver package for Windows 8.1 also supports Windows 8.

† Quad analog display upgrade kit available (see [shopmatrox.com](http://shopmatrox.com)).

	<b>M9128 LP PCIe</b>	<b>M9138 LP PCIe</b>	<b>M9148 LP PCIe</b>	<b>M9188 PCIe</b>
<b>Operating systems supported</b>	Windows 10, Windows 8.1*, Windows Server 2012, Windows Server 2012 R2, Windows 7, Windows Server 2008 R2, Windows Vista, Windows Server 2008, Windows XP, and Windows Server 2003			
<b>Digital monitor support</b>	DVI, DisplayPort	DVI, DisplayPort	DVI, DisplayPort	DVI, DisplayPort
<b>Memory</b>	1 GB	1 GB	1 GB	2 GB
<b>Card type</b>	PCIe x16	PCIe x16	PCIe x16	PCIe x16
<b>Form factor</b>	Low-profile	Low-profile	Low-profile	ATX
<b>Monitors supported</b>	2	3	4	8
<b>Connectors</b>	2x DisplayPort	3x Mini DisplayPort	4x Mini DisplayPort	8x Mini DisplayPort
<b>Maximum digital (DVI) resolution</b>	1920 × 1200	1920 × 1200	1920 × 1200	1920 × 1200
<b>Maximum DisplayPort resolution</b>	2560 × 1600	2560 × 1600	2560 × 1600	2560 × 1600
<b>Maximum card dimensions</b>	L: 6.600" / 16.80 cm H: 2.712" / 6.90 cm W: 0.750" / 1.91 cm	L: 6.600" / 16.80 cm H: 2.712" / 6.90 cm W: 0.750" / 1.91 cm	L: 6.600" / 16.80 cm H: 2.712" / 6.90 cm W: 0.750" / 1.91 cm	L: 9.000" / 22.86 cm H: 4.407" / 11.19 cm W: 0.750" / 1.91 cm

\* The display driver package for Windows 8.1 also supports Windows 8.

## Environmental

<b>Temperature, operational</b>	5 to 55 °C (41 to 131 °F) (near board ambient)
<b>Temperature, non-operational storage and transportation</b>	-40 to 70 °C (-40 to 158 °F)
<b>Humidity, operational (indoor)</b>	20 to 80% (non-condensing)
<b>Humidity, non-operational storage and transportation</b>	10% to 95% (non-condensing)
<b>Atmospheric pressure, operational</b>	650hPa (3,580 meters / 11,745 feet) to 1013hPa (0 meters / 0 feet)
<b>Atmospheric pressure, non-operational and transportation</b>	192hPa (12,000 meters / 39,370 feet) to 1020hPa (-50 meters / -164 feet)

---

## Notes

- Your Matrox graphics card is 100% VGA compatible. It's also compatible with the following VESA® standards: VBE 3.0 (Super VGA modes), DPMS (energy saving), and DDC-2B (Plug-and-Play monitor), DDC-CI, and DisplayPort 1.1a.
- To get the most of your Matrox product, we recommend using the highest color palette setting (a 32-bit color palette) for all your displays.
- The display resolutions and refresh rates available depend on your Matrox graphics card, display driver, software monitor settings, and monitor. For information on the capabilities of your monitor, see your monitor documentation.
- If your digital monitor doesn't support reduced blanking, your screen image may not display properly.
- While using four monitors or more in *stretched* mode, using a resolution higher than 1600 × 1200 may cause tearing or reduced performance during video playback.
- M9188 PCIe – Windows 10/8.1/7/Vista – While using Matrox M9188 graphics hardware certain limitations may apply. For more information, see Matrox PowerDesk help.

---

## Digital flat panel information

- TMDS® (Transition Minimized Differential Signaling) encoding for DVI connectors
- DDWG (Digital Display Working Group) compliant DVI connector
- EDID (Extended Display Identification Data) 1.2 and 1.3 support
- VESA Display Data Channel (DDC) support
- Compatible with VESA DisplayPort 1.1a

---

# Customer support

---

## Matrox Web

Our Web site has product literature, press releases, technical material, a sales office list, trade show information, and other relevant material. Visit the Matrox Graphics Web site at [www.matrox.com/graphics](http://www.matrox.com/graphics).

---

## Technical support

Matrox values your business and offers professional support for your Matrox product.

*If your product was purchased through a Matrox dealer*, contact your dealer for product support. This is the quickest and most effective method of technical assistance. Your dealer is familiar with your complete system.

*If your product was purchased through Matrox*, contact your Matrox representative or visit our technical support Web site at [www.matrox.com/graphics/support](http://www.matrox.com/graphics/support).

---

## Information we need

Please give a complete description of the problem, and include:

- Matrox card serial number, model number, revision number, BIOS number, driver type and version, and memory address at which the Matrox card is installed.
- Computer brand and model name.
- Monitor brand and model name.
- Operating system, version, and service pack.
- Brand and model of any other cards and devices installed on your system.

---

## Program specific problems

If a problem appears with a specific program, please give us the following information:

- Display settings (color palette, display resolution, and so on) applied when the problem occurs.
- If possible, take note of the file and segment address that caused the problem.
- Detailed steps known to cause the bug, so we can reproduce it.

---

## Driver and software download

A more recent display driver may support more features and may offer increased capabilities (such as higher display resolutions). Matrox makes the latest display drivers, software, and system utilities available on the Matrox Technical Support Web site ([www.matrox.com/graphics/en/support/drivers](http://www.matrox.com/graphics/en/support/drivers)).

---

## View your warranty information

Matrox makes warranty information available on the Matrox site ([www.matrox.com/warranty](http://www.matrox.com/warranty)).

---

## Register your Matrox product

Please register online ([www.matrox.com/graphics/en/registration](http://www.matrox.com/graphics/en/registration)) to be eligible for customer support, new product announcements, and information on special offers and upcoming events.



---

**USA**

---

**FCC Compliance Statement**

**Remark for the Matrox hardware products supported by this guide** This equipment has been tested and found to comply with the limits for a Class B digital device, pursuant to Part 15 of the FCC Rules. These limits are designed to provide reasonable protection against harmful interference in a residential installation. This equipment generates, uses and can radiate radio frequency energy and, if not installed and used in accordance with the instructions, may cause harmful interference to radio communications. However, there is no guarantee that interference will not occur in a particular installation. If this equipment causes harmful interference to radio or television reception, which can be determined by turning the equipment off and on, the user is encouraged to try to correct the interference by one or more of the following measures: • Reorient or relocate the receiving antenna • Increase the separation between the equipment and receiver • Connect the equipment into an outlet on a circuit different from that to which the receiver is connected • Consult the dealer or an experienced radio/TV technician for help.

**WARNING** Changes or modifications to this unit not expressly approved by the party responsible for the compliance could void the user's authority to operate this equipment.

**Declaration of conformity of a Class B digital device according to the FCC rules**

**We, the Responsible Party** Matrox, 2002 Ridge Road, Champlain, NY 12919 • Telephone: (514) 822-6000 (extension 2026) • Attention: Conformity Group Matrox

**Declaration** The Matrox hardware products supported by this guide comply with Part 15 of the FCC Rules. Operation is subject to the following two conditions: (1) these devices may not cause harmful interference, and (2) these devices must accept any interference received, including interference that may cause undesired operation. Any question regarding this declaration should be forwarded to the above coordinates.

---

**CANADA**

---

**(English) Industry Canada Compliance Statement**

**Remark for the Matrox hardware products supported by this guide** These digital devices do not exceed the Class B limits for radio noise emission from digital devices set out in the Radio Interference Regulation of Industry Canada.

**(Français) Conformité avec les exigences du ministère de l'Industrie Canada**

**Remarque sur les produits matériels Matrox couverts par ce guide** Ces appareils numériques n'émettent aucun bruit radioélectrique dépassant les limites applicables aux appareils numériques de Classe B prescrites dans le Règlement sur le brouillage radioélectrique édicté par Industrie Canada.

---

**JAPAN**

---

**VCCI Compliance Statement**

**Remark for the Matrox hardware products supported by this guide** This is a Class B product based on the standard of the Voluntary Control Council for Interference from Information Technology Equipment (VCCI). If this is used near a radio or television receiver in a domestic environment, it may cause radio interference. Install and use the equipment according to the instruction manual.

この装置は、クラスB情報技術装置です。この装置は、家庭環境で使用することを目的としていますが、この装置がラジオやテレビジョン受信機に近接して使用されると、受信障害を引き起こすことがあります。

取扱説明書に従って正しい取り扱いをして下さい。

VCCI-B

---

**KOREA**

---

**B 급 기기 (가정용 방송통신기자재)**

이 기기는 가정용 (B 급) 전자파적합기기로서 주로 가정에서 사용하는 것을 목적으로 하며, 모든 지역에서 사용할 수 있습니다.

---

**EUROPE**

---

**(English) European user's information – Information on Conformity**

**Remark for the Matrox hardware products supported by this guide** These devices comply with EC Directive 2014/30/EU for a Class B digital device. They have been tested and found to comply with EN55022/CISPR22 and EN55024/CISPR24. In a domestic environment these products may cause radio interference in which case the user may be required to take adequate measures. These products have been tested in a typical class B compliant host system. It is assumed that these products will also achieve compliance in any class B compliant system.

**(Français) Informations aux utilisateurs Européens – Informations sur la conformité**

**Remarque sur les produits matériels Matrox couverts par ce guide** Ces unités sont conformes à la directive communautaire 2014/30/EU pour les unités numériques de classe B. Les tests effectués ont prouvé qu'elles sont conformes aux normes EN55022/CISPR22 et EN55024/CISPR24. Le fonctionnement de ces produits dans un environnement résidentiel peut causer des interférences radio, dans ce cas l'utilisateur peut être amené à prendre les mesures appropriées. Ces produits ont été testés dans un système hôte typique compatible classe B. On suppose qu'ils présenteront la même compatibilité dans tout système compatible classe B.

**(Deutsch) Information für europäische Anwender – Konformitäts-Informationen**

**Anmerkung für die Matrox Hardware-Produktunterstützung durch dieses Handbuch** Diese Geräte entsprechen EC Direktive 2014/30/EU für ein digitales Gerät Klasse B. Sie wurden getestet und entsprechen demnach EN55022/CISPR22 und EN55024/CISPR24. In einer Wohnumgebung können diese Produkte Funkinterferenzen erzeugen, und der Benutzer kann genötigt sein, entsprechende Maßnahmen zu ergreifen. Diese Produkt wurden in einem typischen, der Klasse B entsprechenden, Host-System getestet. Es wird davon ausgegangen, daß diese Produkte auch in jedem Klasse B entsprechenden System entsprechend funktionieren.

**(Italiano) Informazioni per gli utenti europei – Informazioni sulla conformità**

**Nota per i prodotti hardware Matrox supportati da questa guida** Questi dispositivi sono conformi alla direttiva CEE 2014/30/EU relativamente ai dispositivi digitali di Classe B. Sono stati provati e sono risultati conformi alle norme EN55022/CISPR22 e EN55024/CISPR24. In un ambiente domestico, questi prodotti possono causare radiointerferenze, nel qual caso all'utente potrebbe venire richiesto di prendere le misure adeguate. Questi prodotti sono stati provati in un tipico sistema host conforme alla classe B. Inoltre, si dà per scontato che questi prodotti acquisiranno la conformità in qualsiasi sistema conforme alla classe B.

**(Español) Información para usuarios europeos – Información sobre la conformidad**

**Observación referente a los productos de hardware de Matrox apoyados por este manual** Estos dispositivos cumplen con la directiva de la CE 2014/30/EU para dispositivos digitales de Clase B. Dichos dispositivos han sido sometidos a prueba y se ha comprobado que cumplen con las normas EN55022/CISPR22 y EN55024/CISPR24. En entornos residenciales, estos productos pueden causar interferencias en las comunicaciones por radio; en tal caso el usuario deberá adoptar las medidas adecuadas. Se supone que estos productos cumplirán también con las normas en cualquier sistema que responda a los requisitos de la clase B.

---

**ROVI CORPORATION**

---

**(English)** This item incorporates copy protection technology that is protected by U.S. patent(s) and other intellectual property rights of Rovi Corporation. Reverse engineering and disassembly are prohibited.

**(Français)** Ce produit intègre une technologie de protection des droits d'auteur qui est protégée par un ou plusieurs brevets américains et par d'autres droits de propriété intellectuelle de Rovi Corporation. L'ingénierie inverse et le désassemblage sont interdits.

**(Deutsch)** Dieses Produkt enthält Kopierschutztechnologien, die durch US-Patent(e) und andere Rechte am geistigen Eigentum der Rovi Corporation geschützt ist. Reverse Engineering und Demontage sind verboten.

**(Italiano)** Questo prodotto incorpora la tecnologia di protezione di copia protetta da uno o più brevetti USA e da altri diritti di proprietà intellettuale di Rovi Corporation. È vietato decodificare o disassemblare il prodotto.

**(Español)** Este producto incorpora tecnología de protección de copia que está protegida por patente(s) de EE. UU. y por otros derechos de propiedad intelectual de Rovi Corporation. La ingeniería inversa y el desmontaje están prohibidos.

---

#### EUROPE

---

### **(English) European user's information – Directive on Waste Electrical and Electronic Equipment (WEEE)**

Please refer to the Matrox Web site ([www.matrox.com/environment/en/weee](http://www.matrox.com/environment/en/weee)) for recycling information.



### **(Français) Informations aux utilisateurs Européens – Règlementation des déchets d'équipements électriques et électroniques (DEEE)**

Se référer au site Web de Matrox ([www.matrox.com/environment/en/weee](http://www.matrox.com/environment/en/weee)) pour l'information concernant le recyclage.

### **(Deutsch) Information für europäische Anwender – Europäische Regelungen zu Elektro- und Elektronikgeräten (WEEE)**

Bitte wenden Sie sich an der Matrox-Website ([www.matrox.com/environment/en/weee](http://www.matrox.com/environment/en/weee)) für Recycling-Informationen.

### **(Italiano) Informazioni per gli utenti europei – Direttiva sui rifiuti di apparecchiature elettriche ed elettroniche (RAEE)**

Si prega di riferirsi al sito Web Matrox ([www.matrox.com/environment/en/weee](http://www.matrox.com/environment/en/weee)) per le informazioni di riciclaggio.

---

#### FRANCE

---

### **Avertissement sur l'épilepsie**

**À lire avant toute utilisation d'un jeu vidéo par vous-même ou votre enfant** Certaines personnes sont susceptibles de faire des crises d'épilepsie ou d'avoir des pertes de conscience à la vue de certains types de lumières clignotantes ou d'éléments fréquents dans notre environnement quotidien. Ces personnes s'exposent à des crises lorsqu'elles regardent certaines images télévisées ou qu'elles jouent à certains jeux vidéo. Ces phénomènes peuvent apparaître alors même que le sujet n'a pas d'antécédent médical ou n'a jamais été confronté à une crise d'épilepsie.

Si vous-même ou un membre de votre famille avez déjà présenté des symptômes liés à l'épilepsie (crise ou perte de conscience) en présence de stimulations lumineuses, veuillez consulter votre médecin avant toute utilisation.

Nous conseillons aux parents d'être attentifs à leurs enfants lorsqu'ils jouent avec des jeux vidéo. Si vous-même ou votre enfant présentez un des symptômes suivants: vertige, trouble de la vision, contraction des yeux ou des muscles, perte de conscience, trouble de l'orientation, mouvement involontaire ou convulsion, veuillez immédiatement cesser de jouer et consultez un médecin.

**Précautions à prendre dans tous les cas pour l'utilisation d'un jeu vidéo** Ne vous tenez pas trop près de l'écran.

- Jouez à bonne distance de l'écran de TV et aussi loin que le permet le cordon de raccordement.
- Utilisez de préférence les jeux de vidéo sur un écran de petite taille.
- Évitez de jouer si vous êtes fatigué ou si vous manquez de sommeil.
- Assurez-vous que vous jouez dans une pièce bien éclairée.
- En cours d'utilisation, faites des pauses de dix à quinze minutes toutes les heures.

## Trademarks • Marques déposées • Warenzeichen • Marchi registrati • Marcas registradas

Matrox Electronic Systems Ltd. /

Matrox Graphics Inc.....	Matrox®, DualHead®, ASM™, ATC™, AuroraVX3mp™, AuroraVX™, Avio™, C-Series™, DualHead2Go™, Epica™, Equinox™, Extio™, G400™, G450™, G550™, GXM™, Maevox™, Marvel™, MED2mp™, MED2mp-DVI™, MED3mp-DVI™, MED4mp™, MED5mp-DVI™, MED5mp™, Millennium™, MMS™, Multi-Monitor Series™, MultiDesk™, Mura™, MuraControl™, Mystique™, P650™, P690™, P750™, Parhelia™, Parhelia™ APVe, Parhelia-512™, Parhelia-LX™, Parhelia HR256™, PJ4OLP™, QID™, Quad Information Display™, RAD™, Quick Connect™, MaxVIEW™, Onyx™, PixelTOUCH™, PrecisionCAD™, Precision SGT™, QuickDesk™, RAD2mp™, RAD3mp™, RAD9mp™, RADQ2mp™, Rainbow Runner®, TheatreVUE™, TripleHead™, TripleHead2Go™, VDA™, Veos™, Xenia™
Adobe Systems Inc. ....	Acrobat®, Reader®
Advanced Micro Devices, Inc. ....	AMD®
Apple Computer, Inc. ....	App Store®, Apple®, iPad®, Mac®, Mac OS®
Belden Inc. ....	Belden®
Cisco Systems Inc. ....	iOS®
Dolby Laboratories, Inc. ....	Dolby®, Dolby Digital®
Intel Corporation .....	Intel®, Pentium®, Thunderbolt™
Linus Torvalds .....	Linux®
Microsoft Corporation .....	Aero®, Direct3D®, DirectShow®, DirectX®, Microsoft®, MS-DOS®, PowerPoint®, Windows®, Windows NT®, Windows Server®, Windows Vista®
PCI-SIG .....	PCI™, PCI-X®, PCIe®, PCI Express®
Radio Corporation of America .....	RCA®
RealVNC Ltd.....	VNC®
Rovi Corporation .....	Macrovision®
SD-3C, LLC.....	SD™, SDHC™, SDXC™
Silicon Graphics, Inc. ....	OpenGL®
Silicon Image, Inc.....	PanelLink®, TMDS®
U.S. Environmental Protection Agency .....	ENERGY STAR®
Video Electronics Standards Association .....	DisplayPort™
VideoLAN .....	VideoLAN®, VLC®, VLC® media player
Wibu-Systems.....	WIBU®

Copyright © 1996-2016 VideoLAN. This logo or a modified version may be used or modified by anyone to refer to the VideoLAN project or any product developed by the VideoLAN team, but does not indicate endorsement by the project.

HTML5 Logo by World Wide Web Consortium ([W3C](http://www.w3.org/)). This HTML5 logo is licensed under this Public License (<http://www.creativecommons.org/licenses/by/3.0/legalcode>). The logo has been modified to meet the resolution and size required by this application.

HDMI, the HDMI logo, and High-Definition Multimedia Interface are trademarks or registered trademarks of HDMI Licensing LLC.

SD, SDHC and SDXC Logos are trademarks of SD-3C, LLC.

• (English) Registered trademarks are registered in the United States, Canada, and/or other countries. All other nationally and internationally recognized trademarks and tradenames are hereby acknowledged. • (Français) Les marques déposées sont déposées aux États-Unis, au Canada et/ou dans d'autres pays. Toutes les autres marques et tous les autres noms déposés reconnus nationalement ou internationalement sont également reconnus par les présentes. • (Deutsch) Die eingetragenen Warenzeichen sind in den USA, Kanada und/oder anderen Ländern registriert. Alle sonstigen national und international bekannten Warenzeichen und Produktnamen werden hiermit anerkannt. • (Italiano) I marchi registrati sono registrati negli Stati Uniti, in Canada e/o in altri paesi. Tutti gli altri marchi registrati e nomi commerciali riconosciuti a livello nazionale e internazionale sono ugualmente riconosciuti qui. • (Español) Las marcas registradas están registradas en los EE.UU., Canadá u otros países. Por medio del presente se reconocen todas las demás marcas y nombres comerciales reconocidos a nivel nacional e internacional.

---

## **(English) Disclaimer**

THE INFORMATION IN THIS GUIDE IS SUBJECT TO CHANGE AT ANY TIME AND WITHOUT NOTICE.

Matrox Graphics Inc. reserves the right to make changes in specifications at any time and without notice. The information provided by this document is believed to be accurate and reliable at the time it is written. However, no responsibility is assumed by Matrox Graphics Inc. for its use, for its reproduction and/or distribution, in whole or in part; nor for any infringements of patents or other rights of third parties resulting from its use.

---

## **(Français) Responsabilité**

LES INFORMATIONS CONTENUES DANS CE MANUEL PEUVENT ÊTRE MODIFIÉES EN TOUT TEMPS ET CE SANS PRÉAVIS.

Les Graphiques Matrox Inc. se réserve le droit de modifier les spécifications en tout temps et ce sans préavis quelconque. Les informations contenues dans ce manuel sont reconnues comme étant précises et fiables à la date de rédaction. Cependant, Matrox Graphics Inc. n'assume aucune responsabilité concernant leur utilisation, leur reproduction et/ou distribution, en tout ou en partie, ni leur contrefaçon de brevets ou de tout autre droit appartenant à des tiers résultant de leur utilisation. Aucune licence n'est accordée sur aucun brevet ou droit d'exploiter un brevet de Matrox Graphics Inc.

---

## **(Deutsch) Haftungsablehnungserklärung**

DIE IN DIESEM HANDBUCH ENTHALTENEN ANGABEN UND DATEN KÖNNEN OHNE VORHERIGE ANKÜNDIGUNG GEÄNDERT WERDEN.

Die Matrox Graphics Inc. behält sich das Recht vor, jederzeit und ohne Ankündigung technische Daten zu ändern. Zum Zeitpunkt der Erstellung dieses Handbuchs sind die Inhalte korrekt und verlässlich. Weiterhin übernimmt Matrox Graphics Inc. keinerlei Verantwortung für die Benutzung dieses Handbuchs, die Vervielfältigung und/oder Verteilung im Ganzen oder zum Teil; weder für Verstöße gegen Patentrechte noch für andere Rechte Dritter, die aus seinem Gebrauch resultieren mögen. Es werden keinerlei Lizenzrechte gewährt für sämtliche Patente oder Patentrechte der Matrox Graphics Inc.

---

## **(Italiano) Discrezionalità**

LE INFORMAZIONI CONTENUTE NEL PRESENTE DOCUMENTO SONO SOGGETTE A MODIFICHE IN QUALUNQUE MOMENTO E SENZA PREAVVISO.

Matrox Graphics Inc. si riserva il diritto di apportare variazioni di qualunque tipo alle specifiche tecniche in qualunque momento e senza alcun preavviso. Le informazioni contenute in questa documentazione sono ritenute corrette e attendibili al momento della pubblicazione. In ogni caso, non è imputabile a Matrox Graphics Inc. nessuna responsabilità per il loro utilizzo, per la loro distribuzione e/o riproduzione completa o in parte, come nessuna violazione a brevetti o diritti di altri produttori derivante dal loro utilizzo.

---

## **(Español) Renuncia**

LA INFORMACION QUE CONTIENE EL PRESENTE MANUAL ESTA SUJETA A CAMBIOS SIN PREVIO AVISO EN CUALQUIER MOMENTO.

Matrox Graphics Inc. se reserva el derecho de realizar modificaciones en cualquier momento y sin previo aviso. La información facilitada en este documento se considera que es exacta y fiable hasta la fecha de publicación. Sin embargo, Matrox Graphics Inc. no asume ninguna responsabilidad por su uso, por su reproducción y/o distribución parcial o total; ni por cualquier infracción de patentes u otros derechos de terceras partes derivados de su uso. No se concede ninguna licencia bajo cualesquiera patentes o derechos de patentes de Matrox Graphics Inc.

**Matrox Graphics Inc.**

1055 Saint Regis Boulevard  
Dorval, Quebec, Canada H9P 2T4  
(514) 822-6000

[graphics@matrox.com](mailto:graphics@matrox.com)  
[www.matrox.com/graphics](http://www.matrox.com/graphics)

**matrox**<sup>®</sup>  
Graphics for Professionals