

lenovo

T2054pC Flat Panel Monitor
User's Guide



ThinkVision

Product numbers

60D9-MAR2-WW



First Edition (June 2015)

© Copyright Lenovo 2015.

All rights reserved.

LENOVO products, data, computer software, and services have been developed exclusively at private expense and are sold to governmental entities as commercial items as defined by 48 C.F.R. 2.101 with limited and restricted rights to use, reproduction and disclosure.

LIMITED AND RESTRICTED RIGHTS NOTICE: If products, data, computer software, or services are delivered pursuant a General Services Administration "GSA" contract, use, reproduction, or disclosure is subject to restrictions set forth in Contract No. GS-35F-05925.

Contents

Safety information	iii
Chapter 1. Getting started	1-1
Shipping contents	1-1
Notice for use.....	1-2
Product overview	1-3
Types of adjustments	1-3
Tilt	1-3
Swivel	1-3
Height Adjustment	1-4
User controls	1-4
Cable lock slot	1-5
Setting up your monitor	1-5
Connecting and turning on your monitor	1-5
Registering your option	1-10
Chapter 2. Adjusting and using your monitor	2-1
Comfort and accessibility	2-1
Arranging your work area	2-1
Positioning and viewing your monitor	2-1
Quick tips for healthy work habits	2-2
Accessibility information	2-3
Adjusting your monitor image	2-3
Using the direct access controls	2-3
Using the On-Screen Display (OSD) controls	2-4
Selecting a supported display mode	2-7
Image rotation	2-8
Understanding power management	2-8
Caring for your monitor	2-9
Detaching the monitor base and stand.....	2-10
Wall Mounting (Optional)	2-10
Chapter 3. Reference information	3-1
Monitor specifications	3-1
Troubleshooting	3-3
Manual image setup	3-4
Manually installing the monitor driver	3-5
Getting further help	3-9
Service information	3-9
Product numbers	3-9
Customer responsibilities	3-9
Service parts	3-10
Appendix A. Service and Support	A-1
Appendix B. Notices	B-1

Safety information

General Safety guidelines

For tips to help you use your computer safely, go to:

<http://www.lenovo.com/safety>

Before installing this product, read the Safety Information.

مج، يجب قراءة دات السلامة

Antes de instalar este produto, leia as Informações de Segurança.

在安装本产品之前，请仔细阅读 Safety Information (安全信息)。

Prije instalacije ovog produkta obavezno pročitajte Sigurnosne Upute.

Před instalací tohoto produktu si přečtěte příručku bezpečnostních instrukcí.

Læs sikkerhedsforskrifterne, før du installerer dette produkt.

Ennen kuin asennat tämän tuotteen, lue turvaohjeet kohdasta Safety Information

Avant d'installer ce produit, lisez les consignes de sécurité.

Vor der Installation dieses Produkts die Sicherheitshinweise lesen.

Πριν εγκαταστήσετε το προϊόν αυτό, διαβάστε τις πληροφορίες ασφάλειας (safety information).

לפני תתקין מוצר זה, קראו את הוראות הבטיחות.

A termék telepítése előtt olvassa el a Biztonsági előírásokat!

Prima di installare questo prodotto, leggere le Informazioni sulla Sicurezza

製品の設置の前に、安全情報をお読みください。

본 제품을 설치하기 전에 안전 정보를 읽으십시오.

Пред да се инсталира овој продукт, прочитајте информацијата за безбедност.

Lees voordat u dit product installeert eerst de veiligheidsvoorschriften.

Les sikkerhetsinformasjonen (Safety Information) før du installerer dette produktet.

Przed zainstalowaniem tego produktu, należy zapoznać się

z książką "Informacje dotyczące bezpieczeństwa" (Safety Information).

Antes de instalar este produto, leia as Informações de Segurança.

Перед установкой продукта прочтите инструкции по технике безопасности.

Pred inštaláciou tohto produktu si prečítajte bezpečnostné informácie.

Pred namestitvijo tega proizvoda preberite Varnostne informacije.

Antes de instalar este producto lea la información de seguridad.

Läs säkerhetsinformationen innan du installerar den här produkten.

សូមអានព័ត៌មានស្តីពីសុវត្ថិភាព មុនពេលចាប់ផ្តើមបញ្ចូលកម្មវិធី

安裝本產品之前，請先閱讀「安全諮詢」。

Chapter 1. Getting started

This User's Guide contains detailed information on the ThinkVision® T2054pC Flat Panel Monitor. For a quick overview, please see the Setup Poster that was shipped with your monitor.

Shipping contents

The product package should include the following items:

- Information flyer
- ThinkVision T2054pC Flat Panel Monitor
- Power Cord
- Analog Signal Cable
- Base
- Stand

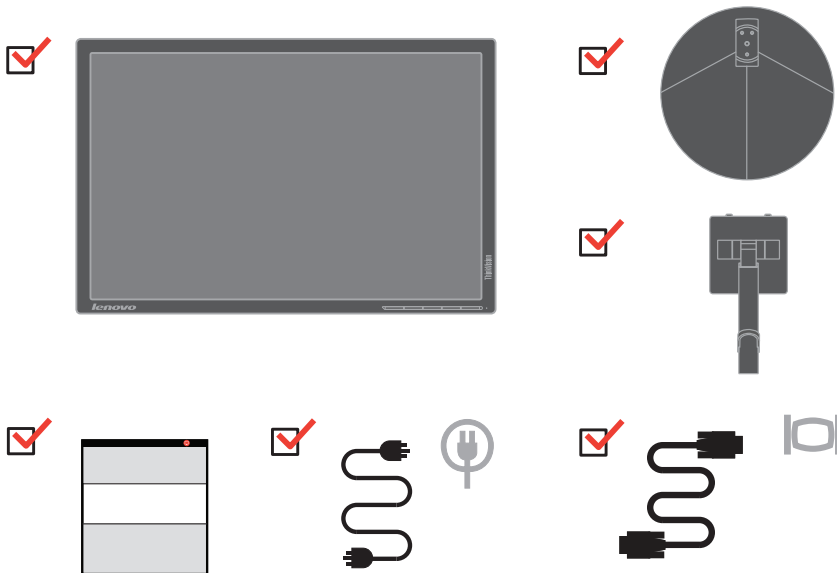

Note: To attach a VESA mount, please see “Wall Mounting (Optional)” on page 2-10.

Notice for use

To set up your monitor, please see the illustrations below.

Note: Do not touch the monitor within the screen area. The screen area is glass and can be damaged by rough handling or excessive pressure.

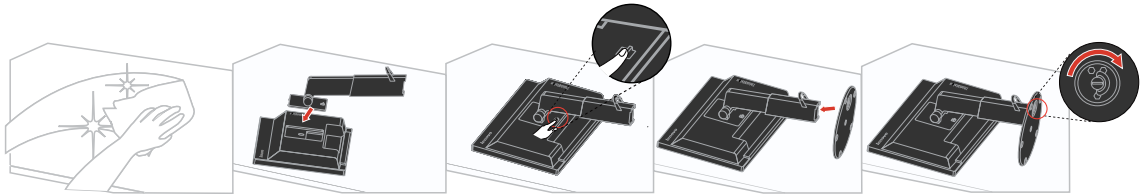

1. Place your monitor with the screen face down on a soft flat surface.
2. Align the stand assembly bracket to the monitor.
3. Insert the bracket towards monitor until it locks in place.

Note: To install a VESA mount, please see "Wall Mounting (Optional)" on page 2-10.

Product overview

This section will provide information on adjusting monitor positions, setting user controls, and using the cable lock slot.

Types of adjustments

Tilt

Please see the illustration below for an example of the tilt range.

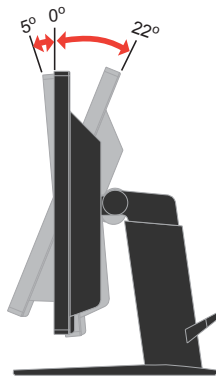

Swivel

With the built-in pedestal, you can tilt and swivel the monitor for the most comfortable viewing angle.

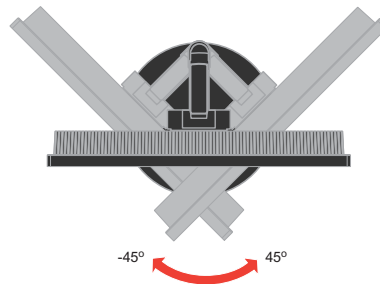

Height Adjustment

Hold the monitor pull up on both sides, adjust the reasonable height of the monitor.

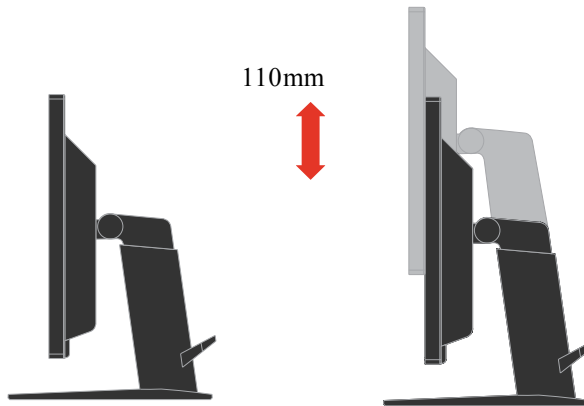

User controls

Your monitor has controls on the front which are used to adjust the display.



For information on how to use these controls, please see “Adjusting your monitor image” on page 2-3.

Cable lock slot

Your monitor is equipped with a cable lock slot located on the rear of your monitor (in the lower left corner). Please follow the instructions that came with the cable lock to attach it.

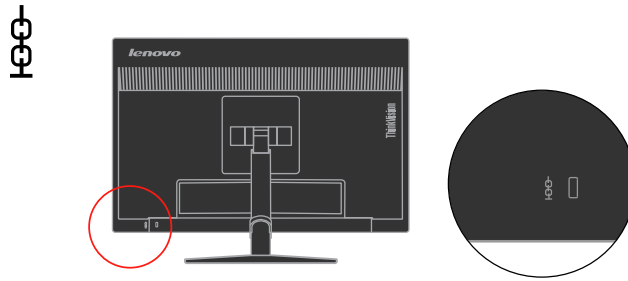

Setting up your monitor

This section provides information to help you set up your monitor.

Connecting and turning on your monitor

Note: Be sure to read the Safety Information located in the information flyer before carrying out this procedure.

1. Power off your computer and all attached devices, and unplug the computer power cord.

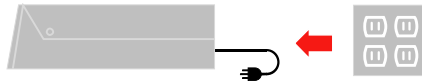

2. Connect the analog signal cable to the D-SUB connector of the monitor and the other end on the back of the computer.

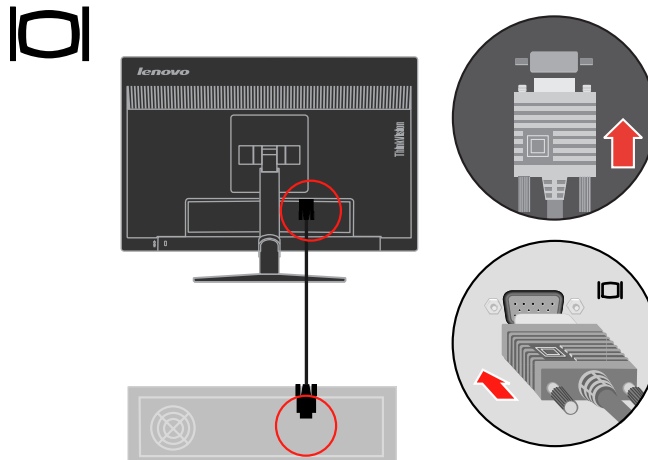

3. Connect one end of the DP cable to the DP connector on the back of the computer, and the other end to the DP connector on the monitor. Lenovo recommends that customers who require to use the Display Port input on their monitor purchase the "Lenovo Display Port to Display Port cable 0A36537".
www.lenovo.com/support/monitoraccessories

D

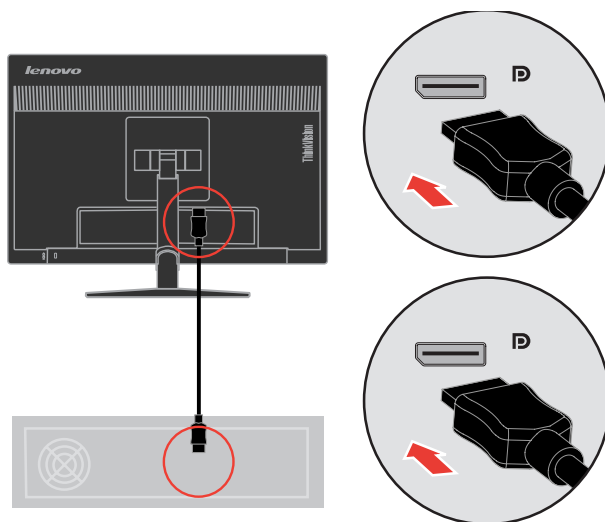

4. Connect one end of the HDMI cable to the HDMI connector on the back of the computer, and the other end to the HDMI connector on the monitor. Lenovo recommends that customers who require to use the HDMI input on their monitor purchase the "Lenovo HDMI to HDMI cable OB47070".
www.lenovo.com/support/monitoraccessories

HDMI

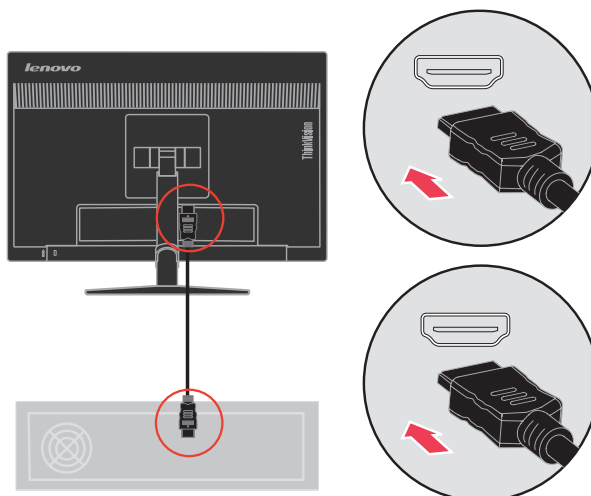

5. Plug the monitor power cord and the computer cord into grounded electrical outlets.
- Note: A certified power supply cord has to be used with this equipment. The relevant national installation and/or equipment regulations shall be considered. A certified power supply cord not lighter than ordinary polyvinyl chloride flexible cord according to IEC 60227 (designation H05VV-F 3G 0.75mm² or H05VVH2-F2 3G 0.75mm²) shall be used. Alternative a flexible cord be of synthetic rubber according to IEC 60245 (designation H05RR-F 3G 0.75mm²) shall be used.

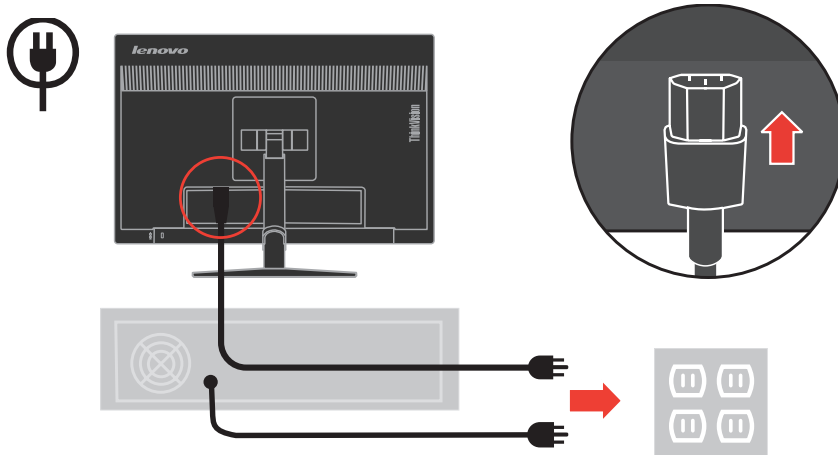

6. Push the main clip, and take it down.

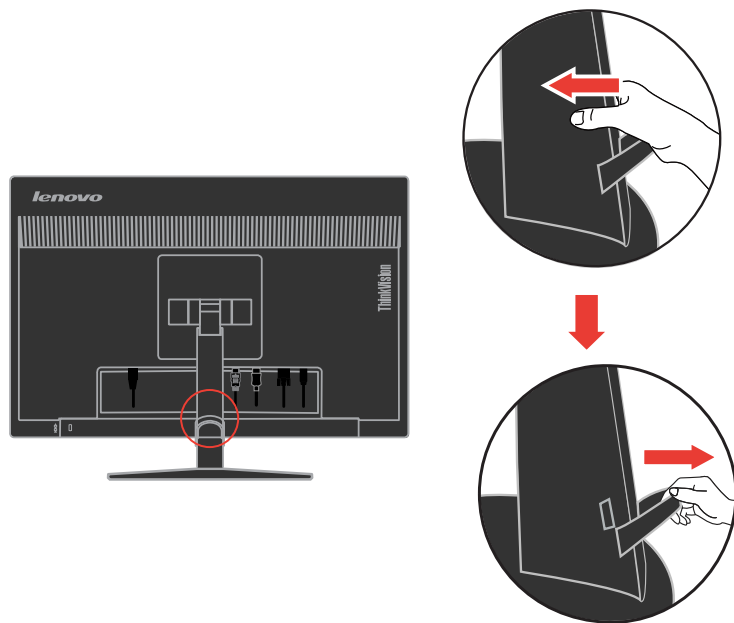

7. Open the main clip and place the cables through the main clip, fasten it from right-left.

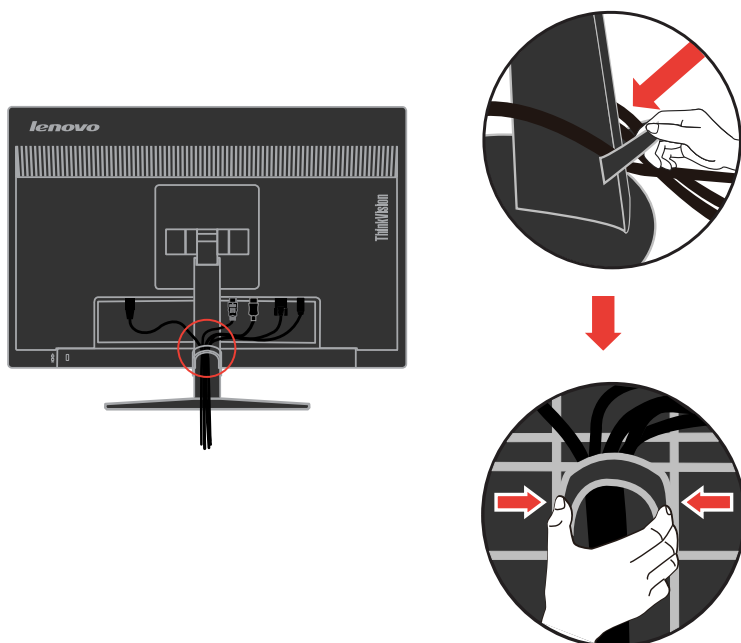

8. Power on the monitor and the computer.

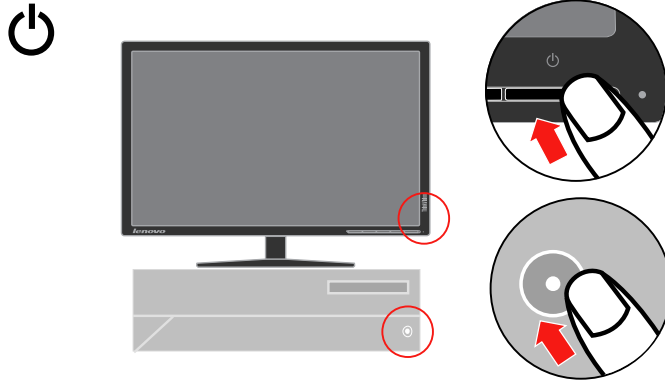

9. Install the monitor driver, download the driver of the corresponding monitor model from the Lenovo Website: <http://support.lenovo.com/us/en/documents/T2054pC>, and then click on the driver and install it following the on-screen instructions.

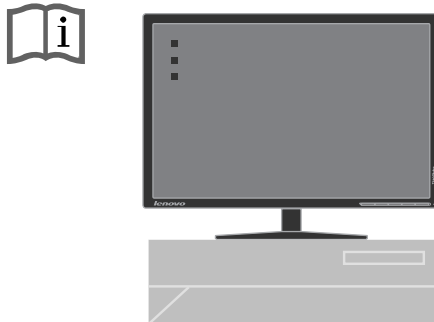

10. To optimize your monitor image, if using the analog cable, press the Automatic Image Setup key. Automatic image setup requires that the monitor is warmed up for at least 15 minutes. This is not required if you are using the HDMI or DP cable.

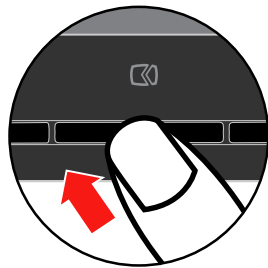

Note: If automatic image setup does not establish the image that you prefer, perform manual image setup. See “Manual image setup” on page 3-4.

Registering your option

Thank you for purchasing this Lenovo® product. Please take a few moments to register your product and provide us with information that will help Lenovo to better serve you in the future. Your feedback is valuable to us in developing products and services that are important to you, as well as in developing better ways to communicate with you. Register your option on the following Web site:

<http://www.lenovo.com/register>

Lenovo will send you information and updates on your registered product unless you indicate on the Web site questionnaire that you do not want to receive further information.

Chapter 2. Adjusting and using your monitor

This section will give you information on adjusting and using your monitor.

Comfort and accessibility

Good ergonomic practice is important to get the most from your personal computer and to avoid discomfort. Arrange your workplace and the equipment you use to suit your individual needs and the kind of work that you perform. In addition, use health work habits to maximize your performance and comfort while using your computer.

Arranging your work area

Use a work surface of appropriate height and available working area to allow you to work in comfort.

Organize your work area to match the way you use materials and equipment. Keep your work area clean and clear for the materials that you typically use and place the items that you use most frequently, such as the computer mouse or telephone, within the easiest reach.

Equipment layout and setup play a large role in your working posture. The following topics describe how to optimize equipment setup to achieve and maintain good working posture.

Positioning and viewing your monitor

Position and adjust your computer monitor for comfortable viewing by considering the following items:

- **Viewing distance:** Optimal viewing distances for monitors range from approximately 510mm to 760mm (20 in to 30 in) and can vary depending on ambient light and time of day. You can achieve different viewing distances by repositioning your monitor or by modifying your posture or chair position. Use a viewing distance that is most comfortable for you.
- **Monitor height:** Position the monitor so your head and neck are in a comfortable and neutral (vertical, or upright) position. If your monitor does not have height adjustments, you might have to place books or other sturdy objects under the base of the monitor to achieve the desired height. A general guideline is to position the monitor such that the top of the screen is at or slightly below your eye-height when you are comfortably seated. However, be sure to optimize your monitor height so the line of site between your eyes and the center the monitor suits your preferences for visual distance and comfortable viewing when your eye muscles are in a relaxed state.

- **Tilt:** Adjust the tilt of your monitor to optimize the appearance of the screen content and to accommodate your preferred head and neck posture.
- **General location:** Position your monitor to avoid glare or reflections on the screen from overhead lighting or nearby windows.

The following are some other tips for comfortable viewing of your monitor:

- Use adequate lighting for the type of work you are performing.
- Use the monitor brightness, contrast, and image adjustment controls, if equipped, to optimize the image on your screen to meet your visual preferences.
- Keep your monitor screen clean so you can focus on the screen's contents.

Any concentrated and sustained visual activity can be tiring for your eyes. Be sure to periodically look away from your monitor screen and focus on a far object to allow your eye muscles to relax. If you have questions on eye fatigue or visual discomfort, consult a vision care specialist for advice.

Quick tips for healthy work habits

The following information is a summary of some important factors to consider to help you remain comfortable and productive while you use your computer.

- **Good posture starts with equipment setup:** The layout of your work area and the setup of your computer equipment have a large effect on your posture while using your computer. Be sure to optimize the position and orientation of your equipment by following the tips outlined in “Arranging your work area” on page 2-1 so you can maintain a comfortable and productive posture. Also, be sure to use the adjustment capabilities of your computer components and office furniture to best suit your preferences now and as your preferences change over time.
- **Minor changes in posture can help avoid discomfort:** The longer you sit and work with your computer, the more important it is to observe your working posture. Avoid assuming any one posture for an extended period of time. Periodically make minor modifications in your posture to help deter any discomforts that might arise. Make use of any adjustments that your office furniture or equipment provide to accommodate changes in posture
- **Short, periodic breaks help ensure healthy computing:** Because computing is primarily a static activity, it is particularly important to take short breaks from your work. Periodically, stand up from your work area, stretch, walk for a drink of water, or otherwise take a short break from using your computer. A short break from work gives your body a welcome change in posture and helps to ensure you remain comfortable and productive while you do work.

Accessibility information

Lenovo is committed to providing greater access to information and technology to people with disabilities. With assistive technologies, users can access information in the way most appropriate to their disability. Some of these technologies are already provided in your operating system; others can be purchased through vendors or accessed at: https://lenovo.ssbartgroup.com/lenovo/request_vpat.php









Adjusting your monitor image

This section describes the user control features used to adjust your monitor image.

Using the direct access controls

The direct access controls can be used when the On Screen Display (OSD) is not displayed.

Table 2-1. Direct access controls

Icon	Control	Description
	Input Source	Switches the video input source Shift back to previous level when in OSD mode
	DDC-CI	Press and hold for 10 seconds to enable or disable the DDC-CI function
	Exit	Exit and return to previous level
	Auto Adjustment	Optimizes image (size, position, phase and clock) (For analog [VGA] source only)
	Decrease/Down	Left browsing key For decreasing the value on adjustment bar/tune in Press to move to previous item
	Brightness	Direct access to Brightness adjustment
	Increase/Up	Right browsing key For increasing the value on adjustment bar/tune in Press to move to next item
	Menu	To access OSD menu Press to confirm selection Press and hold for 10 seconds will lock menu/un-lock menu
	Enter	Press to enter next level on main menu/sub menu status or enter previous level on adjustment bar

Using the On-Screen Display (OSD) controls

The settings adjustable with the user controls are viewed through the On-Screen Display (OSD), as shown below.



To use the controls:





















1. Press  to open the main OSD menu.
2. Use  or  to move among the icons. Select an icon and press  to access the selected function. If there is a sub-menu, you can move between options using  or , then press  to select that function. Use  or  to make adjustments then press  to save.
3. Press  to move backwards through the sub-menus and exit from the OSD.
4. Press and hold  for 10 seconds to lock the OSD. This will prevent accidental adjustments to the OSD. Press and hold  for 10 seconds to unlock the OSD and allow adjustments to the OSD.
5. Enables DDC/CI by default. Use OSD Exit Key, Press and hold  for 10 seconds to disable / enable DDC/CI function. A message "DDC/CI disable" is shown on the screen.

Table 2-2. OSD functions

OSD Icon on Main Menu	Sub menu	Description	Controls and Adjustments
	Brightness	Adjusts overall screen brightness.	All input ports
	Contrast	Adjusts difference between light and dark areas.	
	DCR	Enable dynamic contrast ratio.	
	Horizontal Position	Moves image left or right.	Analog (VGA) only
	Vertical Position	Moves image up or down.	
	Automatic	Optimizes image (size, position, phase and clock).	
	Manual	Manually optimizes the image. See "Manual image setup" on page 3-4. • Clock • Phase	
	Color	Adjusts intensity of red, green, and blue. 1. Preset Mode • Neutral • sRGB • Reddish • Bluish 2. Custom • Red: Increases or decreases the saturation of Red in the image. • Green: Increases or decreases the saturation of Green in the image. • Blue: Increases or decreases the saturation of Blue in the image.	All input ports
	Input Signal	This monitor can accept video signals through three different connectors. Most desktop computers use an analog connector. Select digital among OSD Controls when you use DP / HDMI connector. 1. VGA (Analog) 2. HDMI (digital) 3. DP (digital)	All input ports
	Scaling	Expands image size to full screen. 1. Original AR: same Aspect Ratio with input signal. 2. Full Screen: Expands image size to full screen.	
	Over Drive	• On • Off	
	Information	Shows resolution, refresh rate, and product details. Note: This screen offers information only, and (does) not allow for setting changes.	All input ports
	Menu Language	Changes languages of menu. Note: The language chosen only affects the language of the OSD. It has no effect on any software running on the computer.	

* Note: Brightness and Contrast can not be adjusted in sRGB mode.

Table 2-2. OSD functions

OSD Icon on Main Menu	Sub menu	Description	Controls and Adjustments
	Menu Position	Adjusts menu location on the screen. Default The menu position to the default settings. Custom <ul style="list-style-type: none"> • Horizontal: Changes the horizontal position of the OSD. • Vertical: Changes the vertical position of the OSD. 	All input ports
	Factory Default	Resets monitor to the original factory settings. <ul style="list-style-type: none"> • Cancel • Reset 	
	Accessibility	Change button repeat rate and menu timeout settings. Button repeat rate <ul style="list-style-type: none"> • Off • Default • Slow Menu time out Set the duration of time that the OSD will remain active when no operation is performed ().	
	DP Select	Select DP 1.1 or 1.2. <ul style="list-style-type: none"> • DP 1.1. • DP 1.2. 	

* Note: Brightness and Contrast can not be adjusted in sRGB mode.

Selecting a supported display mode

The display mode the monitor uses is controlled by the computer. Therefore, refer to your computer documentation for details on how to change display modes.

The image size, position and shape might change when the display mode changes. This is normal and the image can be readjusted using automatic image setup and the image controls.

Unlike CRT monitors, which require a high refresh rate to minimize flicker, LCD or Flat Panel technology is inherently flicker-free.

Note: If your system has previously been used with a CRT monitor and is currently configured to a display mode outside the range of this monitor, you may need to re-attach the CRT monitor temporarily until you have re-configured the system; preferably to 1440 x 900 at 60 Hz, which is the Native Resolution Display mode.

The display modes shown below have been optimized at the factory.

Table 2-3. Factory set display modes

Addressability	Refresh rate
640 x 480	60 Hz, 66 Hz, 72 Hz, 75 Hz
720 x 400	70 Hz
800 x 600	60 Hz, 72 Hz, 75 Hz
1024 x 768	60 Hz, 70 Hz, 75 Hz
1152 x 864	75 Hz
1280 x 1024	60 Hz, 72 Hz, 75 Hz
1280 x 768	60 Hz
1280 x 800	60 Hz
1440 x 900	60 Hz, 75 Hz
1366 x 768	60 Hz

Image rotation

Before rotating the monitor, you should set-up your computer to rotate the image. Rotating the image may require special rotation software or you may find that your computer is preloaded with video graphic drivers that allows image rotation. Check the Graphic Properties setting on your computer to see if this feature is available.

Try these steps to check if image rotation is available on your computer.

1. Right-click on the desktop and click **Properties**.
2. Select the **Settings** tab and click **Advanced**.
3. If you have ATI, select the **Rotation** tab and set the preferred rotation. If you have nVidia, click the **nVidia** tab, in the left-hand column select **NVRotate**, and then select the preferred rotation. If you have **Intel**, select the Intel graphics tab, click **Graphic Properties**, select the **Rotation** tab, and then set the preferred rotation.

Check with the manufacturer of your computer to see if graphic drivers with image rotation can be downloaded from their support website.

Understanding power management

Power management is invoked when the computer recognizes that you have not used your mouse or keyboard for a user-definable period. There are several states as described in the table below.

For optimal performance, switch off your monitor at the end of each working day, or whenever you expect to leave it unused for long periods during the day.

Table 2-4. Power indicator

State	Power Indicator	Screen	Restoring Operation	Compliance
On	Steady green	Normal		
Standby/Suspend	Steady amber	Blank	Press a key or move the mouse There may be a slight delay before the image reappears. Note: Standby also occurs if there is no image output to the monitor.	ENERGY STAR
Off	Off	Blank	Press the power button There may be a slight delay before the image reappears.	ENERGY STAR

Caring for your monitor

Be sure to turn off the power before you perform any maintenance on the monitor.

Do not:

- Apply water or liquid directly to your monitor.
- Use solvents or abrasives.
- Use flammable cleaning materials to clean your monitor or any other electrical equipment.
- Touch the screen area of your monitor with sharp or abrasive items. This type of contact may cause permanent damage to your screen.
- Use any cleaner which contains an anti-static solution or similar additives. This may harm the coating of the screen area.

Do:

- Lightly dampen a soft cloth with water and use this to gently wipe the covers and the screen.
- Remove grease or finger marks with a damp cloth and a little mild detergent.

Detaching the monitor base and stand

- step 1: Place the monitor on a soft and flat surface.
- step 2: Remove the base and stand from the monitor.

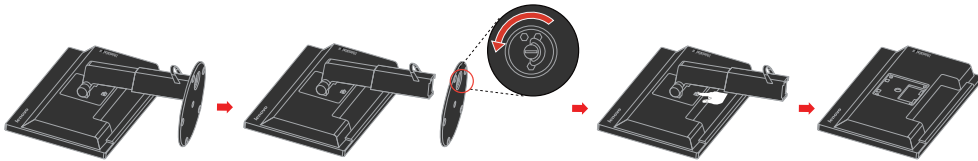

Wall Mounting (Optional)

Refer to the instructions that come with the VESA compatible base mounting kit.

1. Place the monitor face down on a non-abrasive surface on stable flat table.
2. Remove the stand.
3. Attach the mounting bracket from the wall mounting kit to the monitor.
4. Mount the monitor on the wall by following the instructions that come with the base mounting kit.

NOTE: For use only with UL(expand UL) Listed Wall Mount Bracket with minimum weight/load bearing capacity of 4.00 kg.

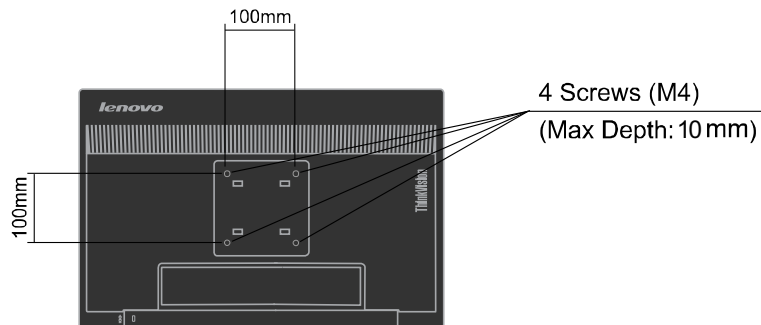

Chapter 3. Reference information

This section contains monitor specifications, instructions to manually install the monitor driver, troubleshooting information, and service information.

Monitor specifications

Table 3-1. Monitor specifications for type-model 60D9-MAR2-WW

Dimensions	Height	345.95 mm (13.62 in.)
	Depth	242.6 mm (9.55 in.)
	Width	454.2 mm (17.88 in.)
Panel	Size	19.5 in.
	Backlight	LED
	Aspect Ratio	16:10
Stand	Tilt range	Range: -5°, +22°
	Swivel	Range: -45°, +45°
	Lift	Range: 110.0 mm
VESA mount	Supported	100 mm (3.94 in.)
Image	Viewable image size	494.03 mm (19.45 in.)
	Maximum height	262.35 mm (10.32 in.)
	Maximum width	418.608 mm (16.48 in.)
	Pixel pitch	0.2915 mm (0.011 in.) (V)
Power input	Supply voltage	100 - 240 V~, 50/60 Hz
	Max supply current	1.5 A
Power consumption Note: Power consumption figures are for the monitor and the power supply combined.	Max Consumption (Without USB hub) Typical Consumption Standby/Suspend Off	< 20 W < 18 W < 0.3 W (Analog and Digital) < 0.3 W
Video input (Analog)	Input signal Horizontal addressability Vertical addressability Clock frequency	Analog Direct Drive, 75 ohm 0.7 V 1440 pixels (max) 900 lines (max) 150 MHz
Video input (HDMI)	Interface Input Signal Horizontal addressability Vertical addressability Clock frequency	HDMI VESA TMDS (Panel Link.) 1440 pixels (max) 900 lines (max) 150 MHz

Table 3-1. Monitor specifications for type-model 60D9-MAR2-WW (continued)

Video input (DP)	Interface	DP
	Horizontal addressability	1440 pixels (max)
	Vertical addressability	900 lines (max)
	Clock frequency	150 MHz
Communications	VESA DDC	CI
Supported Display Modes (VESA Standard modes between noted ranges)	Horizontal frequency	VGA: 30 kHz - 81 kHz HDMI: 30 kHz - 81 kHz DP: 30 kHz - 81 kHz
	Vertical frequency	50 Hz - 75 Hz
	Native Resolution	1440 x 900 at 60 Hz
Temperature	Operating	0° to 45° C (32° to 113° F)
	Storage	-20° to 60° C (-4° to 140° F)
	Shipping	-20° to 60° C (-4° to 140° F)
Humidity	Operating	10% to 80%
	Storage	5% to 95%
	Shipping	5% to 95%

Troubleshooting

If you have a problem setting up or using your monitor, you might be able to solve it yourself. Before calling your dealer or Lenovo, try the suggested actions that are appropriate to your problem.

Table 3-2. Troubleshootingg

Problem	Possible cause	Suggested action	Reference
The words "Out of Range" are shown on the screen, and the power indicator is flashing green.	The system is set to a display mode which is not supported by the monitor.	<ul style="list-style-type: none"> • If you are replacing an old monitor, reconnect it and adjust the display mode to within the specified range for your new monitor. • If using a Windows system, restart the system in safe mode, then select a supported display mode for your computer. • If these options do not work, contact the Support Center. 	"Selecting a supported display mode" on page 2-7
The image quality is unacceptable.	The video signal cable is not connected with the monitor or system completely.	Be sure the signal cable is firmly plugged into the system and monitor.	"Connecting and turning on your monitor" on Page 1-5
	The color settings may be incorrect.	Select another color setting from the OSD menu.	"Adjusting your monitor image" on page 2-3
	The automatic image setup function was not performed.	Perform automatic image setup.	"Adjusting your monitor image"" on page 2-3
The power indicator is not lit and there is no image.	<ul style="list-style-type: none"> • The monitors power switch is not switched on. • The power cord is loose or disconnected. • There is no power at the outlet. 	<ul style="list-style-type: none"> • Be sure the power cord is connected properly. • Be sure the outlet has power. • Power on the monitor. • Try using another power cord. • Try using another electrical outlet. 	"Connecting and turning on your monitor" on Page 1-5









Table 3-2. Troubleshootingg(continued)

Problem	Possible cause	Suggested action	Reference
Screen is blank and power indicator is steady amber or flashing green	The monitor is in Standby/Suspend mode	<ul style="list-style-type: none"> Press any key on the keyboard or move the mouse to restore operation. Check the Power Options settings on your computer. 	"Understanding power management" on Page 2-8
The power indicator is green, but there is no image.	The video signal cable is loose or disconnected from the system or monitor.	Be sure the video cable is connected with the system properly.	"Connecting and turning on your monitor" on Page 1-5
	The monitor brightness and contrast are at the lowest setting.	Adjust the brightness and contrast setting on the OSD menu.	"Adjusting your monitor image" on page 2-3
One or more of the pixels appear discolored	This is a characteristic of the LCD technology and is not an LCD defect.	If there are more than five pixels missing, contact the Lenovo Support Center.	Appendix A, "Service and Support," on page A-1
<ul style="list-style-type: none"> Fuzzy lines in text or a blurry image. Horizontal or vertical lines through the image. 	<ul style="list-style-type: none"> Image setup has not been optimized Your system Display Properties setting have not been optimized. 	Adjust the resolution settings on your system to match the native resolution for this monitor: 1440 x 900 at 60 Hz.	"Adjusting your monitor image" on page 2-3
		Perform automatic image setup. If automatic image setup does not help, perform manual image setup.	"Selecting a supported display mode" on page 2-7
		When working in the native resolution, you may find additional improvements by adjusting the Dots Per Inch (DPI) setting on your system.	See the Advanced section of your systems display properties.

Manual image setup

If automatic image setup does not establish the image that you prefer, perform manual image setup.

Note: Have your monitor powered on for about 15 minutes, until the monitor warms up.

1. Press  at the bottom of the monitor to open the OSD menu.
2. Use  or  to select  and press  to access.
3. Use  or  to select Manual and press  to access.

4. Use ← or → to select **Clock** and **Phase** adjustment.
 - **Clock** (pixel frequency) adjusts the number of pixels scanned by one horizontal sweep. If the frequency is not correct, the screen shows vertical stripes and the picture does not have the correct width.
 - **Phase** adjusts the phase of the pixel clock signal. With a wrong phase adjustment, the picture has horizontal disturbances in light picture.
5. When the image no longer looks distorted, press Enter to save the adjustments of Clock and Phase.
6. Press ⇧ to leave the OSD menu.

Manually installing the monitor driver

Below are steps for manually installing the monitor driver in Microsoft® Windows Vista, Microsoft Windows 7®, Microsoft Windows 8/Windows 8.1 Professional, and Microsoft Windows 10 .

Installing the monitor driver in Windows Vista

To install the monitor driver in Microsoft® Windows Vista, do the following:

1. Turn off the computer and all attached devices.
2. Ensure that the monitor is connected correctly.
3. Turn on the monitor and then the system unit. Allow the system to boot into Windows Vista operating system.
4. Find the driver of the corresponding monitor model from Lenovo's website: <http://support.lenovo.com/us/en/documents/T2054pC>, and download it to the host connected to this monitor for temporary storage (as shown in the figure on the desktop).
5. Click Start → **Control Panel**, and then click the **Hardware and Sound** icon.
6. Click the **Personalization** icon.
7. Click the **Display Settings** icon.
8. Click the **Advanced Settings** button.
9. Click the **Monitor** tab.
10. Click the **Properties** button.
11. If the "Windows needs your permission to continue" window appears, click on Continue button. Then click the **Driver** tab.
12. Open the "Update Driver Software-Generic PnP Monitor" window by clicking on **Update Driver**. and then click the "Browse my computer for driver software" button.
13. Select "Let me pick from a list of device drivers on my computer".
14. Click the "Install from the disk" button, click on the "Browse" button, and then navigate to the following directory: **X \ Monitor Drivers \ Windows Vista**
(Here, **X** stands for "the folder in which the downloaded driver locates" (such as desktop))
15. Select the "T2054pC.inf" file and click the **Open** button. Click the **OK** button.
16. Select "**Lenovo T2054pC**" in the new window and then click "Next".
17. After the installation is complete, delete the downloaded program files, and close all the windows.
18. Restart the system.

Note: On LCD monitors, unlike CRTs, a faster refresh rate does not improve display quality. Lenovo recommends using either 1440 x 900 at a refresh rate of 60 Hz, or 640 x 480 at a refresh rate of 60 Hz.

Installing the monitor driver in Windows 7

Note: This section must be completed before continuing with the Windows 7 automatic image setup.

1. Turn off the computer and all attached devices.
2. Ensure that the monitor is connected correctly.
3. Turn on the monitor and then the system unit. Allow the system to boot into Windows 7 operating system.
4. Find the driver of the corresponding monitor model from Lenovo's website: <http://support.lenovo.com/us/en/documents/T2054pC>, and download it to the host connected to this monitor for temporary storage (as shown in the figure on the desktop).
5. Click **Start** → **Control Panel**, and then click the **Hardware and Sound** icon.
6. Click the **Personalization** icon.
7. Click the **Display Settings** icon.
8. Click the **Advanced Settings** button.
9. Click the **Monitor** tab.
10. Click the **Properties** button.
11. If the "Windows needs your permission to continue" window appears, click on Continue button. Then click the **Driver** tab.
12. Open the "Update Driver Software-Generic PnP Monitor" window by clicking on **Update Driver**. and then click the "Browse my computer for driver software" button.
13. Select "Let me pick from a list of device drivers on my computer".
14. Click the "Install from the disk" button, click on the "Browse" button, and then navigate to the following directory: **X \ Monitor Drivers \ Windows**
(Here, **X** stands for "the folder in which the downloaded driver locates" (such as desktop))
15. Select the "T2054pC.inf" file and click the **Open** button. Click the **OK** button.
16. Select "Lenovo T2054pC" in the new window and then click "Next".
17. After the installation is complete, delete the downloaded program files, and close all the windows.
18. Restart the system. The system will automatically select the maximum refresh rate and corresponding color Matching profiles.

Note: On LCD monitors, unlike CRTs, a faster refresh rate does not improve display quality. Lenovo recommends using either 1440 x 900 at a refresh rate of 60 Hz, or 640 x 480 at a refresh rate of 60 Hz.

Installing the monitor driver in Windows 8/Windows 8.1

To use the Plug and Play feature in Microsoft Windows 8/Windows 8.1, do the following:

1. Turn off the computer, all attached devices.
2. Ensure that the monitor is connected correctly.
3. Turn on the monitor and then the system unit. Allow your computer to start the Windows 8/Windows 8.1 operating system.
4. Find the driver of the corresponding monitor model from Lenovo's website: <http://support.lenovo.com/us/en/documents/T2054pC>, and download it to the host connected to this monitor for temporary storage (as shown in the figure on the desktop).
5. Open the Display Properties window by clicking Start, right-click, choose All Application, enter Control Panel and Hardware and Sound icon. and then clicking the Display icon.
6. Click the **Change the display settings** tab
7. Click the **Advanced** Settings icon.
8. Click the **Monitor** tab.
9. Click the **Properties** button.
10. Click the **Driver** tab.
11. Click **Update Driver**, then click **Browse the computer to find the driver program**.
12. Select **Pick from the list of device driver program on the computer**.
13. Click the "**Install from the disk**" button, click on the "Browse" button, and then navigate to the following directory: **X \ Monitor Drivers \ Windows 8** (Note: The **win 8.1** system here should be **Windows 8.1**)
(Here, **X** stands for "the folder in which the downloaded driver locates" (such as desktop))
14. Select the "**T2054pC.inf**" file and click the **Open** button. Click the **OK** button.
15. Select '**Lenovo T2054pC**' in the new window and then click "Next".
16. After the installation is complete, delete the downloaded program files, and close all the windows.
17. Restart the system. The system will automatically select the maximum refresh rate and corresponding Color Matching Profiles.

Note: On LCD monitors, unlike CRTs, a faster refresh rate does not improve display quality. Lenovo recommends using either 1440 x 900 at a refresh rate of 60 Hz, or 640 x 480 at a refresh rate of 60 Hz.

Installing the monitor driver in Windows 10

To use the Plug and Play feature in Microsoft Windows 10, do the following:

1. Turn off the computer, all attached devices.
2. Ensure that the monitor is connected correctly.
3. Turn on the monitor and then the system unit. Allow your computer to start the Windows 10 operating system.
4. Find the driver of the corresponding monitor model from Lenovo's website: <http://support.lenovo.com/us/en/documents/T2054pC>, and download it to the host connected to this monitor for temporary storage (as shown in the figure on the desktop).
5. Right click on the Windows desktop, then select the Display settings in the pull-down menu.
6. Click the **Advanced display settings**.
7. Click the **Display adapter properties**.
8. Click the **Monitor** tab.
9. Click the **Properties** button.
10. Click the **Driver** tab.
11. Click the **Update driver** button, click **Browse the computer for driver software**.
12. Click the **Let me pick from the list of device drivers on my computer**.
13. Click the **"Install from the disk"** button, click on the **"Browse"** button, and then navigate to the following directory: **X \ Monitor Drivers \ Windows 10**
(Here, X stands for "the folder in which the downloaded driver locates" (such as desktop))
14. Select the **" T2054pC.inf"** file and click the Open button. Click the OK button.
15. Select **"Lenovo T2054pC"** and then click "Next".
16. After the installation is complete, delete the downloaded program files, and close all the windows.
17. Restart the system. The system will automatically select the maximum refresh rate and corresponding Color Matching Profiles.

Note: On LCD monitors, unlike CRTs, a faster refresh rate does not improve display quality. Lenovo recommends using either 1440 x 900 at a refresh rate of 60 Hz, or 640 x 480 at a refresh rate of 60 Hz.

Getting further help

If you still can't solve your problem, please contact the Lenovo Support Center. For more information on contacting the Customer Support Center, please see Appendix A, "Service and Support," on page A-1.

Service information

Product numbers

The product number for your monitor is located on the back of the display bezel as shown below.



Customer responsibilities

The warranty does not apply to a product which has been damaged due to accident, misuse, abuse, improper installation, usage not in accordance with product specifications and instructions, natural or personal disaster, or unauthorized alterations, repairs or modifications.

The following are examples of misuse or abuse and not covered by warranty:

- Images burned onto the screen of a CRT monitor. Burned image is preventable by utilizing a moving screen saver or power management.
- Physical damage to covers, bezel, base and cables.
- Scratches or punctures on monitor screens.

Service parts

The following parts are for use by Lenovo service, or Lenovo authorized dealers, to support the customer warranty. Parts are for service use only. The table below shows information for model 60D9-MAR2-WW.

Table 3-3. List of service parts

FRU (Field Replaceable Unit) Part number	Description	Color	Machine Type Model (MTM)
00PC046	Monitor_T2054pC	Raven Black	60D9-MAR2-WW
00PC047	Signal cable (Analog)	Raven Black	60D9-MAR2-WW
00PC048	Stand & Base	Raven Black	60D9-MAR2-WW

Appendix A. Service and Support

The following information describes the technical support that is available for your product, during the warranty period or throughout the life of your product. Refer to the Lenovo Limited Warranty for a full explanation of Lenovo warranty terms.

Registering your option

Register to receive product service and support updates, as well as free and discounted computer accessories and content. Go to:

<http://www.lenovo.com/register>

Online technical support

Online technical support is available during the lifetime of a product at:

<http://www.lenovo.com/support>

Product replacement assistance or exchange of defective components also is available during the warranty period. In addition, if your option is installed in a Lenovo computer, you might be entitled to service at your location. A Lenovo technical support representative can help you determine the best alternative.

Telephone technical support

Installation and configuration support through the Customer Support Center will be available until 90 days after the option has been withdrawn from marketing. After that time, the support is cancelled, or made available for a fee, at Lenovo's discretion. Additional support is also available for a nominal fee.

Before contacting a Lenovo technical support representative, please have the following information available: option name and number, proof of purchase, computer manufacturer, model, serial number and manual, the exact wording of any error message, description of the problem, and the hardware and software configuration information for your system.

Your technical support representative might want to walk you through the problem while you are at your computer during the call.

Telephone numbers are subject to change without notice. The most up-to-date telephone list for Lenovo Support is always available at:

<http://www.lenovo.com/support/phone>

Country or Region	Telephone Number
Argentina	0800-666-0011 (Spanish,English)
Australia	1-800-041-267 (English)
Austria	0810-100-654 (For local rate) (German)
Belgium	Warranty service and support: 02-339-36-11 (Dutch,French)
Bolivia	0800-10-0189 (Spanish)
Brazil	Calls made from within the Sao Paulo region : 11-3889-8986, Calls made from outside the Sao Paulo region : 0800-701-4815 (Portuguese)
Brunei Darussalam	Dial 800-1111 (English)
Canada	1-800-565-3344 (English, French)
Chile	800-361-213 (Spanish)
China	Technical Support Line: 400-100-6000 (Mandarin)
China (Hong Kong S.A.R.)	(852) 3516-8977 (Cantonese, English, Mandarin)
China (Macau S.A.R.)	0800-807 / (852) 3071-3559 (Cantonese, English, Mandarin)
Colombia	1-800-912-3021 (Spanish)
Costa Rica	0-800-011-1029 (Spanish)
Croatia	385-1-3033-120 (Croatian)
Cyprus	800-92537 (Greek)
Czech Republic	800-353-637 (Czech)
Denmark	Warranty service and support: 7010-5150 (Danish)
Dominican Republic	1-866-434-2080 (Spanish)
Ecuador	1-800-426911-OPCION 4 (Spanish)

Country or Region	Telephone Number
Egypt	Primary: 0800-0000-850 Secondary: 0800-0000-744 (Arabic,English)
El Salvador	800-6264 (Spanish)
Estonia	372-66-0-800 (Estonian, Russian, English)
Finland	Warranty service and support: +358-800-1-4260 (Finnish)
France	Warranty service and support: 0810-631-213 (hardware) (French)
Germany	Warranty service and support : 0800-500-4618 (toll-free) (German)
Greece	Lenovo Business Partner (Greek)
Guatemala	Dial 999-9190, wait for operator, and request to reach 877-404-9661 (Spanish)
Honduras	Dial 800-0123 (Spanish)
Hungary	+ 36-13-825-716 (English, Hungarian)
India	Primary: 1800-419-4666 (Tata) Secondary: 1800-3000-8465 (Reliance) Email: commercialts@lenovo.com (English and Hindi)
Indonesia	1-803-442-425 62 213-002-1090 (Standard Charges Apply) (English, Bahasa Indonesia)
Ireland	Warranty service and support: 01-881-1444 (English)
Israel	Givat Shmuel Service Center: +972-3-531-3900 (Hebrew, English)
Italy	Warranty service and support: +39-800-820094 (Italian)
Japan	0120-000-817 (Japanese, English)
Kazakhstan	77-273-231-427 (Standard Charges Apply) (Russian, English)

Country or Region	Telephone Number
Korea	080-513-0880 (Collect call) 02-3483-2829 (Toll Call) (Korean)
Latvia	371-6707-360 (Latvian, Russian, English)
Lithuania	370 5278 6602 (Italian, Russian, English)
Luxembourg	ThinkServer and ThinkStation: 352-360-385-343 ThinkCentre and ThinkPad: 352-360-385-222 (French)
Malaysia	1-800-88-0013 03-7724-8023 (Standard Charges Apply) (English)
Malta	356-21-445-566 (English Italian , Maltese Arabic)
Mexico	001-866-434-2080 (Spanish)
Netherlands	020-513-3939 (Dutch)
New Zealand	0508-770-506 (English)
Nicaragua	001-800-220-2282 (Spanish)
Norway	8152-1550 (Norwegian)
Panama	Lenovo Customer Support Center : 001-866-434 (toll-free) (Spanish)
Peru	0-800-50-866 OPCION 2 (Spanish)
Philippines	1-800-8908-6454 (GLOBE subscribers), 1-800-1441-0719 (PLDT subscribers) (Tagalog, English)
Poland	Laptops and tablets with brand logosThink : 48-22-273-9777 ThinkStation and ThinkServer : 48-22-878-6999 (Polish, English)
Portugal	808-225-115 (Standard Charges Apply) (Portuguese)

Country or Region	Telephone Number
Romania	4-021-224-4015 (Romanian)
Russia	+7-499-705-6204 +7-495-240-8558 (Standard Charges Apply) (Russian)
Singapore	1-800-415-5529 6818-5315 (Standard Charges Apply) (English, Mandarin, Bahasa Malaysia)
Slovakia	ThinkStation and ThinkServer : 421-2-4954-5555
Slovenia	386-1-2005-60 (Slovenian)
Spain	34-917-147-833 (Spanish)
Sri Lanka	9477-7357-123 (Sumathi Information systems) (English)
Sweden	Warranty service and support: 077-117-1040 (Swedish)
Switzerland	Warranty service and support: 0800-55-54-54 (German, French, Italian)
Taiwan	0800-000-702 (Mandarin)
Thailand	001-800-4415-734 (+662) 787-3067 (Standard Charges Apply) (Thai, English)
Turkey	444-04-26 (Turkish)
United Kingdom	Standard warranty support: 03705-500-900 (local rate) Standard warranty support: 08705-500-900 (English)
United States	1-800-426-7378 (English)
Uruguay	000-411-005-6649 (Spanish)
Venezuela	0-800-100-2011 (Spanish)
Vietnam	120-11072 (Toll Free) 84-8-4458-1042 (Standard Charges Apply) (Vietnamese, English)

Appendix B. Notices

Lenovo may not offer the products, services, or features discussed in this document in all countries. Consult your local Lenovo representative for information on the products and services currently available in your area. Any reference to a Lenovo product, program, or service is not intended to state or imply that only that Lenovo product, program, or service may be used. Any functionally equivalent product, program, or service that does not infringe any Lenovo intellectual property right may be used instead. However, it is the user's responsibility to evaluate and verify the operation of any other product, program, or service.

Lenovo may have patents or pending patent applications covering subject matter described in this document. The furnishing of this document does not give you any license to these patents. You can send license inquiries, in writing, to:

*Lenovo (United States), Inc.L
1009 Think Place - Building One
Morrisville, NC 27560
U.S.A.
Attention: Lenovo Director of Licensing*

LENOVO PROVIDES THIS PUBLICATION "AS IS" WITHOUT WARRANTY OF ANY KIND, EITHER EXPRESS OR IMPLIED, INCLUDING, BUT NOT LIMITED TO, THE IMPLIED WARRANTIES OF NON-INFRINGEMENT, MERCHANTABILITY OR FITNESS FOR A PARTICULAR PURPOSE. Some jurisdictions do not allow disclaimer of express or implied warranties in certain transactions, therefore, this statement may not apply to you.

This information could include technical inaccuracies or typographical errors. Changes are periodically made to the information herein; these changes will be incorporated in new editions of the publication. Lenovo may make improvements and/or changes in the product(s) and/or the program(s) described in this publication at any time without notice.

The products described in this document are not intended for use in implantation or other life support applications where malfunction may result in injury or death to persons. The information contained in this document does not affect or change Lenovo product specifications or warranties. Nothing in this document shall operate as an express or implied license or indemnity under the intellectual property rights of Lenovo or third parties. All information contained in this document was obtained in specific environments and is presented as an illustration. The result obtained in other operating environments may vary.

Lenovo may use or distribute any of the information you supply in any way it believes appropriate without incurring any obligation to you.

Any references in this publication to non-Lenovo Web sites are provided for convenience only and do not in any manner serve as an endorsement of those Web sites. The materials at those Web sites are not part of the materials for this Lenovo product, and use of those Web sites is at your own risk.

Any performance data contained herein was determined in a controlled environment. Therefore, the result obtained in other operating environments may vary significantly. Some measurements may have been made on development-level systems and there is no guarantee that these measurements will be the same on generally available systems. Furthermore, some measurements may have been estimated through extrapolation. Actual results may vary. Users of this document should verify the applicable data for their specific environment.

Recycling information

Lenovo encourages owners of information technology (IT) equipment to responsibly recycle their equipment when it is no longer needed. Lenovo offers a variety of programs and services to assist equipment owners in recycling their IT products. For information on recycling Lenovo products, go to:
<http://www.lenovo.com/recycling/japan>

環境配慮に関して

本機器またはモニターの回収リサイクルについて

企業のお客様が、本機器が使用済みとなり廃棄される場合は、資源有効利用促進法の規定により、産業廃棄物として、地域を管轄する県知事あるいは、政令市長の許可を持った産業廃棄物処理業者に適正処理を委託する必要があります。また、弊社では資源有効利用促進法に基づき使用済みパソコンの回収および再利用・再資源化を行う「PC回収リサイクル・サービス」を提供しています。詳細は、
<http://www.ibm.com/jp/pc/service/recycle/pcrecycle/> をご参照ください。

また、同法により、家庭で使用済みとなったパソコンのメーカー等による回収再資源化が2003年10月1日よりスタートしました。詳細は、
<http://www.ibm.com/jp/pc/service/recycle/pcrecycle/> をご参照ください。

重金属を含む内部部品の廃棄処理について

本機器のプリント基板等には微量の重金属（鉛など）が使用されています。使用後は適切な処理を行うため、上記「本機器またはモニターの回収リサイクルについて」に従って廃棄してください。

Collecting and recycling a disused Lenovo computer or monitor

If you are a company employee and need to dispose of a Lenovo computer or monitor that is the property of the company, you must do so in accordance with the Law for Promotion of Effective Utilization of Resources. Computers and monitors are categorized as industrial waste and should be properly disposed of by an industrial

waste disposal contractor certified by a local government. In accordance with the Law for Promotion of Effective Utilization of Resources, Lenovo Japan provides, through its PC Collecting and Recycling Services, for the collecting, reuse, and recycling of disused computers and monitors. For details, visit the Lenovo Web site at www.ibm.com/jp/pc/service/recycle/pcrecycle/. Pursuant to the Law for Promotion of Effective Utilization of Resources, the collecting and recycling of home-used computers and monitors by the manufacturer was begun on October 1, 2003. This service is provided free of charge for home-used computers sold after October 1, 2003. For details, visit the Lenovo Web site at www.ibm.com/jp/pc/service/recycle/personal/.

Disposing of Lenovo computer components

Some Lenovo computer products sold in Japan may have components that contain heavy metals or other environmental sensitive substances. To properly dispose of disused components, such as a printed circuit board or drive, use the methods described above for collecting and recycling a disused computer or monitor.

Trademarks

The following terms are trademarks of Lenovo in the United States, other countries, or both:

- Lenovo
- The Lenovo logo
- ThinkCentre
- ThinkPad
- ThinkVision

Microsoft, Windows, and Windows NT are trademarks of the Microsoft group of companies.

Other company, product, or service names may be trademarks or service marks of others.

Turkish statement of compliance

The Lenovo product meets the requirements of the Republic of Turkey Directive on the Restriction of the Use of Certain Hazardous Substances in Electrical and Electronic Equipment (EEE).

Türkiye EEE Yönetmeliğine Uygunluk Beyanı

Bu Lenovo ürünü, T.C. Çevre ve Orman Bakanlığı'nın "Elektrik ve Elektronik Eşyalarda Bazı Zararlı Maddelerin Kullanımının Sınırlandırılmasına Dair Yönetmelik (EEE)" direktiflerine uygundur.

EEE Yönetmeliğine Uygundur.

Lenovo and the Lenovo logo are trademarks of Lenovo in the United States, other countries, or both.

Ukraine RoHS

Цим підтверджуємо, що продукція Леново відповідає вимогам нормативних актів України, які обмежують вміст небезпечних речовин