

PHILIPS

Headphones

8000 Series

TAT8505



User manual

Register your product and get support at
www.philips.com/support

Contents

1	Important safety instructions	2
	Hearing Safety	2
	General information	2

2	Your Bluetooth True wireless earphones	3
	What's in the box	3
	Other devices	3
	Overview of your True wireless earphones	4

3	Get started	5
	Charge the battery	5
	Pair the headphones with your mobile phone	5

4	Use your headphones	7
	Connect the headphones to a Bluetooth device	7
	Control ANC (active noise cancelation)	7
	Manage your calls and music	8
	LED indicator status	9
	Voice Assistant	9

5	Factory reset the headset	10
---	---------------------------	----

6	Technical data	10
---	----------------	----

7	Notice	11
	Declaration of conformity	11
	Disposal of your old product and battery	11
	Remove the integrated battery	11
	Compliance with EMF	12
	Environmental information	12
	Notice of compliance	12

8	Trademarks	14
---	------------	----

9	Frequently asked questions	15
---	----------------------------	----

1 Important safety instructions

Hearing Safety



Danger

- To avoid hearing damage, limit the time you use headphones at high volume and set the volume to a safe level. The louder the volume, the shorter the safe listening time is.

Be sure to observe the following guidelines when using your headset.

- Listen at reasonable volumes for reasonable periods of time.
- Be careful not to adjust the volume continuously upwards as your hearing adapts.
- Do not turn up the volume so high that you can't hear what's around you.
- You should use caution or temporarily discontinue use in potentially hazardous situations.
- Excessive sound pressure from earphones and headphones can cause hearing loss.
- Using headphones with both ears covered while driving is not recommended and may be illegal in some areas while driving.
- For your safety, avoid distractions from music or phone calls while in traffic or other potentially dangerous environments.

General information

To avoid damage or malfunction:



Caution

- Do not expose headphones and charging case to excessive heat.
- Do not drop your headphones and charging case.
- Headphones and charging case shall not be exposed to dripping, splashing water.
- Do not allow your headphones and charging case to be submerged in water.
- Do not use any cleaning agents containing alcohol, ammonia, benzene, or abrasives.
- If cleaning is required use a soft cloth, if necessary dampened with a minimum amount of water or diluted mild soap, to clean the product.
- The integrated battery shall not be exposed to excessive heat such as sunshine, fire or the like.
- Danger of explosion if battery is incorrectly replaced. Replace only with the same or equivalent type.

About operating and storage temperatures and humidity

- Store in a place where temperature is between -20°C (-4°F) and 50°C (122°F) (up to 90% relative humidity).
- Operate in a place where temperature is between 0°C (32°F) and 45°C (113°F) (up to 90% relative humidity).
- Battery life may be shorter in high or low temperature conditions.
- Replacement of a battery with an incorrect type that can defeat a safeguard (for example, in the case of some lithium battery types);
- Disposal of a battery into fire or a hot oven, or mechanically crushing or cutting of a battery, can result in an explosion;
- Leaving a battery in an extremely high temperature surrounding environment can result in an explosion or the leakage of flammable liquid or gas;
- A battery subjected to extremely low air pressure that may result in an explosion or the leakage of flammable liquid or gas.

2 Your True wireless earphones



Quick start guide

Congratulations on your purchase, and welcome to Philips! To fully benefit from the support that Philips offers, register your product at www.philips.com/welcome. With this Philips True wireless earphones, you can:

- enjoy convenient wireless handsfree calls;
- enjoy and control wireless music;
- switch between calls and music.

Other devices

A mobile phone or device (e.g. note-book, PDA, Bluetooth adapters, MP3 players etc) which supports Bluetooth and is compatible to the headset (see 'Technical data' on page 8).

What's in the box

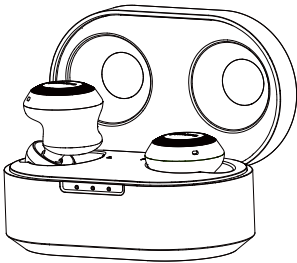

Philips True wireless earphones
Philips TAT8505



Replaceable rubber ear caps x 3 pairs

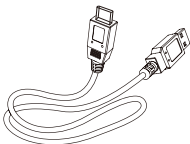

USB-C charging cable (for charging only)

Overview of your True wireless earphones

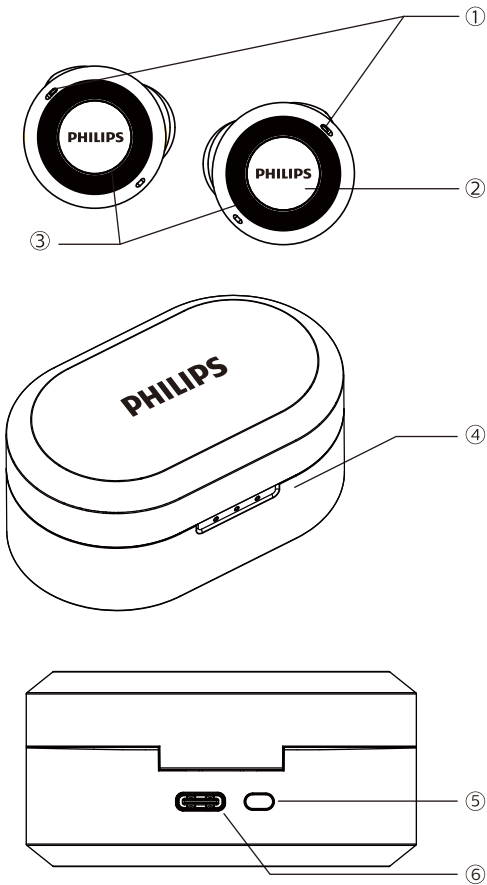

- ① Microphone
- ② Multi-function touch
- ③ LED indicator (Earpieces)
- ④ LED indicator (charging box)
- ⑤ Bluetooth pair button
- ⑥ USB-C charging slot

3 Get started

Charge the battery

Note

- Before you use your earpieces for the first time, place the earpieces in the charging box and charge the battery for 3 hours for optimum battery capacity and lifetime.
- Use only the original USB-C charging cable to avoid any damage.
- Finish your call before charging the earpieces, as connecting the earpieces for charging will power the earpieces off.

Charging Box

Connect one end of the USB cable into the charging box, and another end into the power source.

↳ The charging box starts charging.

- Charging process is verified by the blue LED light on the front panel.
- When the charging box is fully charged, the blue light goes on.

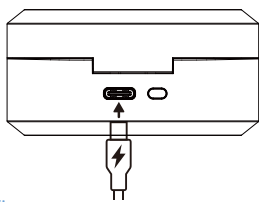

Tip

- The charging box serves as a portable backup battery for charging the earpieces. When the charging box is fully charged, it supports 3 times full recharge cycle for the earpieces.

Earpieces

Place the earpieces in the charging box.

↳ The earpieces start charging.

- Charging process is verified by blue LED light on the earpieces.
- When the earpieces are fully charged, the blue light goes off.

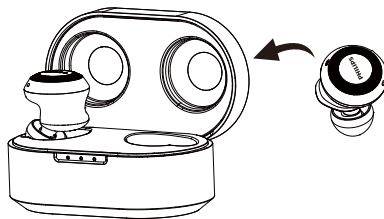

Tip

- Normally, a full charge takes 1.5 hours (for the earpieces or charging box) by USB cable.

Wireless charging

The charging box has a built-in wireless charging coil. You can charge the battery by using a wireless charger or another device that functions as a wireless charger.

Caution

Precautions for wireless charging

- Do not place the charging case on the wireless charger when conductive materials, such as metal objects and magnets, are placed between the charging case and the wireless charger.
- The charging case may not charge properly or may overheat, or the charging case and the cards may be damaged.

Charging the battery with a wireless charger.

- Place the earpiece to charging box.
- Close the charging box cover.
- Place the center of the charging case on the center of the wireless charger.
- After fully charging, disconnect the charging case from the wireless charger.

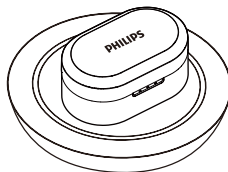

Tip

- A full charge takes 4 hours by wireless charging.
- Wireless charger is not included.

Pair the earpieces with your Bluetooth device at the first time

- 1 Make sure that the headset is fully charged and powered off.
- 2 Open the top cover from charging box, press and hold the pairing button from charging box back for approximately 3 seconds

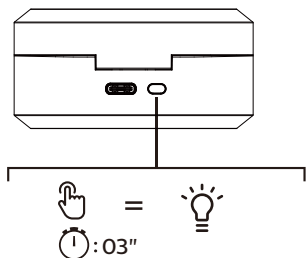

- ↳ The LED on both earpieces flash in white & blue alternately.
 - ↳ The earpieces are now in pairing mode and is ready to pair with a Bluetooth device (e.g. a mobile phone)
- 3 Turn on the Bluetooth function of your Bluetooth device.
 - 4 Pair the earpieces with your Bluetooth device. Refer to the user manual of your Bluetooth device.

Note

- After powering on, if the earpieces cannot find any previously connected Bluetooth device, it will automatically switch to pairing mode.

The following example shows you how to pair the earpieces with your Bluetooth device.

- 1 Turn on the Bluetooth function of your Bluetooth device, select Philips TAT8505.

- 2 Enter the earpieces password "0000" (4 zeros) if prompted. For those Bluetooth devices featuring Bluetooth 3.0 or higher, no need to enter a password.



Philips TAT8505

Single earpiece (Mono mode)

Take either right or Left earpiece out from charging box for Mono use. The earpiece will power on automatically. There will be a voice "Power on" from earpiece.

Note

- Take the second Earpiece from the charging box and they will pair each other automatically.

Pair the earpieces with another Bluetooth device

If you have another Bluetooth device that you want to pair with the earpieces, make sure the Bluetooth function in any other previously paired or connected devices are turned off. Then follow the steps in 'Pair the earpieces with your Bluetooth device at the first time'.

Note

- The earpieces stores 4 device in the memory. If you try to pair more than 4 devices, the earliest paired device is replaced by the new one.

4 Use your earpieces

Connect the earpieces to your Bluetooth device

- 1 Turn on the Bluetooth function of your Bluetooth device.
- 2 Open the top cover from charging box.
 - ↳ The blue LED flashes.
 - ↳ The earpieces will search the last connected Bluetooth device and reconnect to it automatically. If the last connected one is not available, the earpieces will search and reconnect to the second last connected device.

Tip

- The earpieces cannot connect to more than 1 device at the same time. If you have two paired Bluetooth devices, only turn on the Bluetooth function of the device that you want to connect.
- If you turn on the Bluetooth function of your Bluetooth device after turning on the earpieces, you have to go to the Bluetooth menu of the device and connect the earpieces to the device manually.

Note

- If the earpieces fails to connect to any Bluetooth device within 5 minutes, it will turn off automatically to save the battery life.
- In some Bluetooth devices, connection may not be automatic. In this case, you have to go to the Bluetooth menu of your device and connect the earpieces to the Bluetooth device manually.

Control ANC (active noise cancelation)

Enable ANC

Different ANC mode can be toggled via double tap on the right earpiece.

- ANC function is auto active when put into the ear.
- Touch the MFB button twice, it will change to Awareness mode.
- Touch the MFB button twice again, it will turn the ANC function off.

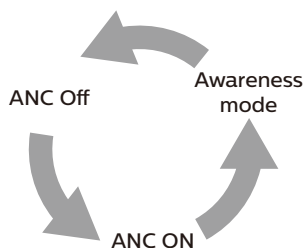

Tip

- By removing the earpiece, it will automatically change to sleep mode. When put earpiece back, it will return to active mode.

Task	Multi-function button	Operation
ANC ON	Right earpiece	Double tap
Awareness mode	Right earpiece	Double tap
ANC OFF	Right earpiece	Double tap
Attention mode	Right earpiece	Tap and hold

ANC LED indicator status

Headphones status	Indicator
ANC mode is toggled	The blue LED will turn on.

Power on/off

Task	Multi-function button	Operation
Turn the earpieces on.		Earpiece take out from charging box to power on
Turn the earpieces off.		Earpiece put back to charging box to power off

Manage your calls and music







Music control

Task	Multi-function button	Operation
Play or pause music	Right earpiece	Single tap
Skip forward	Right earpiece	Triple taps
Adjust volume +/-		Via mobile phone control

Call control





Task	Multi-function button	Operation
Pick up/ Switch caller during a call	Right earpiece	Double taps
Hang up call /Reject call	Right earpiece	Tap and hold

Charging Box (3 blue LED)

Charging Box LED (USB on)	Indicator
	 ○ ○
	●  ○
	● ● 
	● ● ● Continue to lit as long as USB is on

Charging Box LED (USB off)

Indicator

	● ○ ○
	● ● ○
	● ● ●
	● ● ●

Tip

- When USB is off, the LED is lit for 30s after case open or closed

LED indicator status

Headphones status

Indicator status

The earpieces are connected to a Bluetooth device. White LED blink every 5s

The earpieces are ready for pairing

The earpieces are on but not connected to a Bluetooth device. The blue & white LED flash alternately

Low battery level (earpieces) Blue LED blink 2x every 5s

Battery is fully charged (earpieces). blue & white LED is off

Battery is fully charged (charging box). Refer to Case LED slide

Battery LED indicator on Bluetooth device

It will show a battery indicator on Bluetooth device after connected to earpieces.

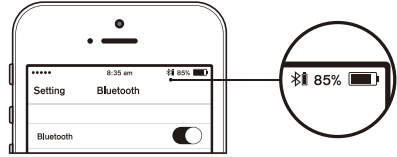

Voice Assistant

Task	Button	Operation
Trigger voice assistant (Siri/Google)	Left earpiece	Tap and hold 2 seconds
Stop voice assistant	Left earpiece	Single Tap
Google Fetch/Confirm	Left earpiece	Double Tap

How to wear

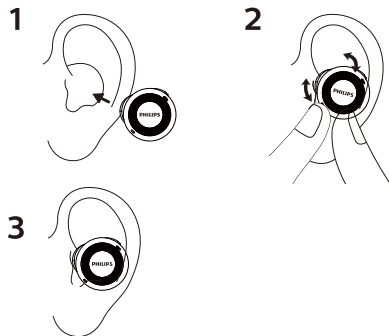

5 Reset the earpieces

If you encounter any pairing or connection issue, you can follow the following procedure to reset your headset.

- 1 On your Bluetooth device, go to the Bluetooth menu and remove **Philips TAT8505** from the device list.
- 2 Turn off the Bluetooth function of your Bluetooth device.
- 3 Tap & hold multi-function touch for >25s on each earpiece individually.
- 4 To pair the headset with a Bluetooth device, Earpiece put back to charging box to power off. Open the top cover from charging box, press and hold the pairing button from charging box back for approximately 3 seconds. Then, turn on the Bluetooth function of your Bluetooth device, select **Philips TAT8505**.

6 Technical data

- Music time — ANC enabled: 5 hours | ANC disabled with Bluetooth: 6 hours
- Talk time — ANC enabled: 5 hours | ANC disabled: 6 hours
- Standby time — 200 hours
- Charging time: 1.5 hours
- Lithium-ion battery 55 mAh on each earpiece, Lithium-ion battery 560 mAh on charging box
- Bluetooth version: 5.0
- Compatible Bluetooth profiles:
 - HSP (Hands-Free Profile-HFP)
 - A2DP (Advanced Audio Distribution Profile)
 - AVRCP (Audio Video Remote Control Profile)
- Supported audio codec: SBC, AAC
- Frequency range: 2.402-2.480 GHz
- Transmitter power: < 10 dBm
- Operating range: Up to 10 meters (33 feet)
- Auto power off
- USB-C port for charging
- Wireless charging
- Low battery warning: available



Note

- Specifications are subject to change without notice.

7 Notice

Declaration of conformity

Hereby, MMD Hong Kong Holding Limited declares that this product is in compliance with the essential requirements and other relevant provisions of Directive 2014/53/EU. You can find the Declaration of Conformity on www.p4c.philips.com.

Disposal of your old product and battery



Your product is designed and manufactured with high quality materials and components, which can be recycled and reused.



This symbol on a product means that the product is covered by European Directive 2012/19/EU.



This symbol means that the product contains a built-in rechargeable battery covered by European Directive 2013/56/EU which cannot be disposed of with normal household waste. We strongly advise you to take your product to an official collection point or a Philips service centre to have a professional remove the rechargeable battery. Inform yourself about the local separate collection system for electrical and electronic products and rechargeable batteries. Follow local rules and never dispose of the product and rechargeable batteries with normal household waste. Correct disposal of old products and rechargeable batteries helps prevent negative consequences for the environment and human health.

Remove the integrated battery

If there is no collection/recycling system for electronic products in your country, you can protect the environment by removing and recycling the battery before disposing the headphones.

- Make sure the earpieces is disconnected from the charging box before removing the battery.

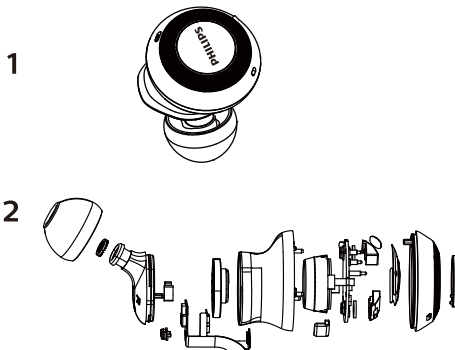

- Make sure the charging box is disconnected from the USB charging cable before removing the battery.

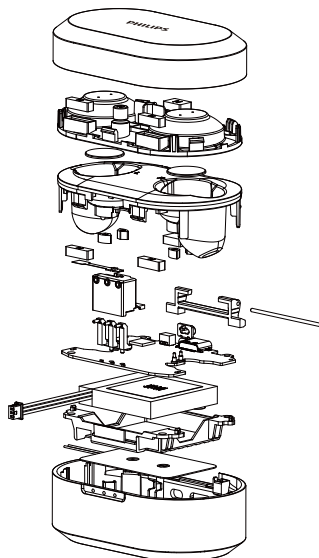

Compliance with EMF

This product complies with all applicable standards and regulations regarding exposure to electromagnetic fields.

Environmental information

All unnecessary packaging has been omitted. We have tried to make the packaging easy to separate into three materials: cardboard (box), polystyrene foam (buffer) and polyethylene (bags, protective foam sheet.)

Your system consists of materials which can be recycled and reused if disassembled by a specialized company. Please observe the local regulations regarding the disposal of packaging materials, exhausted batteries and old equipment.

Notice of compliance

The device complies with the FCC rules, Part 15. Operation is subject to the following two conditions:

1. **This device may not cause harmful interference, and**
2. **This device must accept any interference received, including interference that may cause undesired operation.**

FCC rules

This equipment has been tested and found to comply with the limits for a Class B digital device, pursuant to part 15 of the FCC Rules. These limits are designed to provide reasonable protection against harmful interference in a residential installation. This equipment generates, uses and can radiate radio

frequency energy and, if not installed and used in accordance with the instruction manual, may cause harmful interference to radio communications. However, there is no guarantee that interference will not occur in a particular installation. If this equipment does cause harmful interference to radio or television reception, which can be determined by turning the equipment off and on, the user is encouraged to try to correct the interference by one or more of the following measures:

- Reorient or relocate the receiving antenna.
- Increase the separation between equipment and receiver
- Connect the equipment into an outlet on a circuit different from that to which the receiver is connected.
- Consult the dealer or an experienced radio/TV technician for help.

FCC Radiation Exposure Statement:

This equipment complies with FCC radiation exposure limits set forth for an uncontrolled environment.

This transmitter must not be co-located or operating in conjunction with any other antenna or transmitter.

Caution: The user is cautioned that changes or modifications not expressly approved by the party responsible for compliance could void the user's authority to operate the equipment.

Canada:

This device contains licence-exempt transmitter(s)/receiver(s) that comply with Innovation, Science and Economic Development Canada's licence-exempt RSS(s). Operation is subject to the following two conditions: (1) This device may not cause interference. (2) This device must accept any interference, including interference that may cause undesired operation of the device.

L'émetteur/récepteur exempt de licence contenu dans le présent appareil est conforme aux CNR d'Innovation, Sciences et Développement économique Canada applicables aux appareils radio exempts de licence.

L'exploitation est autorisée aux deux conditions suivantes : (1) L'appareil ne doit pas produire de brouillage; (2) L'appareil doit accepter tout brouillage radioélectrique subi, même si le brouillage est susceptible d'en compromettre le fonctionnement.

CAN ICES-3(B)/NMB-3(B)

IC Radiation Exposure Statement:

This equipment complies with Canada radiation exposure limits set forth for uncontrolled environments.

This transmitter must not be co-located or operating in conjunction with any other antenna or transmitter.

7 Trademarks

Bluetooth

The Bluetooth® word mark and logos are registered trademarks owned by Bluetooth SIG, Inc. and any use of such marks by MMD Hong Kong Holding Limited is under license. Other trademarks and trade names are those of their respective owners.

Siri

Siri is a trademark of Apple Inc., registered in the U.S. and other countries.

Google

Google and Google Play are trademarks of Google LLC.

8 Frequently asked questions

My Bluetooth headset does not turn on.

The battery level is low. Charge the headset.

I cannot pair my Bluetooth headset with my Bluetooth device.

The Bluetooth is disabled. Enable the Bluetooth feature on your Bluetooth device and turn on the Bluetooth device before you turn on the headset.

Pairing does not work.

- Put both earpieces into charging box.
- Make sure you have disabled the Bluetooth function of any previously connected Bluetooth devices.
- On your Bluetooth device, delete “Philips TAT8505” from the Bluetooth list.
- Pair your headset (see ‘Pair the headset with your Bluetooth device at the first time’ on page 6).

The Bluetooth device cannot find the headset.

- The headset may be connected to a previously paired device. Turn off the connected device or move it out of range.
- Pairing may have been reset or the headset has been previously paired with another device. Pair the headset with the Bluetooth device again as described in the user manual. (see ‘Pair the headset with your Bluetooth device at the first time’ on page 6).

My Bluetooth headset is connected to a Bluetooth stereo enabled mobile phone, but music only plays on the mobile phone speaker.

Refer to the user manual of your mobile phone. Select to listen to music through the headset.

The audio quality is poor and crackling noise can be heard.

- The Bluetooth device is out of range. Reduce the distance between your headset and Bluetooth device, or remove obstacles between them.
- Charge your headset.

The audio quality is poor when streaming from the mobile phone is very slow, or audio streaming does not work at all.

Make sure your mobile phone not only supports (mono) HSP/HFP but also supports A2DP and is BT4.0x (or higher) compatible (see ‘Technical data’ on page 10).



APP DOWNLOAD

Scan the QR code/press 'Download' button or search 'Philips Headphones' in Apple App Store or Google Play to download App.



Philips and the Philips Shield Emblem are registered trademarks of Koninklijke Philips N.V. and are used under license. This product has been manufactured by and is sold under the responsibility of MMD Hong Kong Holding Limited or one of its affiliates, and MMD Hong Kong Holding Limited is the warrantor in relation to this product.

