

# PRO X SUPERLIGHT 2 DEX

SETUP GUIDE | 设置指南

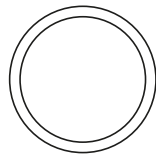

logitech

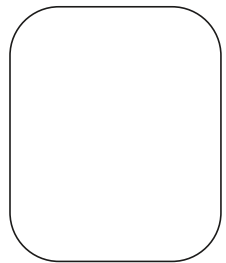
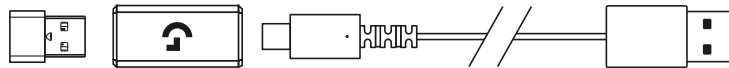
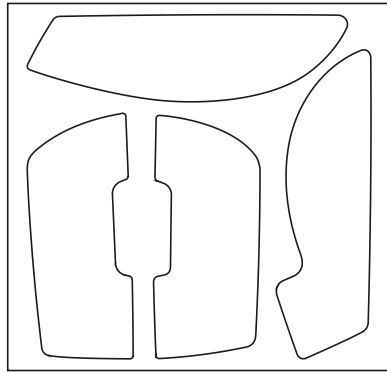
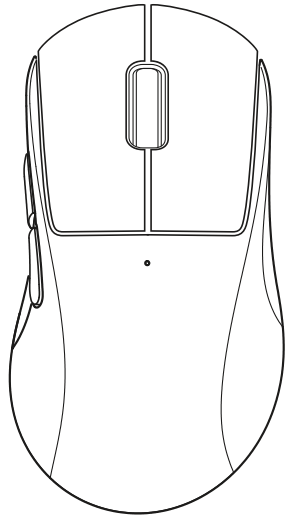

ENGLISH . . . . .	3
简体中文 . . . . .	10
繁體中文 . . . . .	17
한국어 . . . . .	24

# PACKAGE CONTENTS

- 1 Mouse
- 2 Optional grip tape
- 3 Receiver (installed in extension adapter)
- 4 USB charging and data cable
- 5 Surface preparation cloth
- 6 Optional POWERPLAY aperture door with PTFE foot

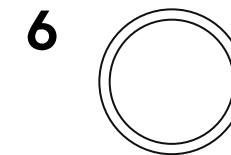
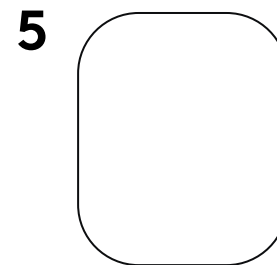
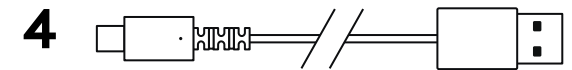
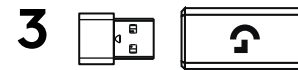
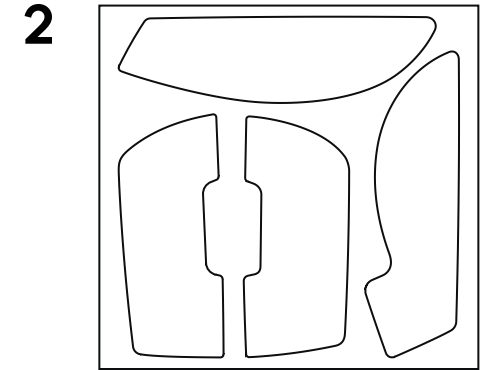
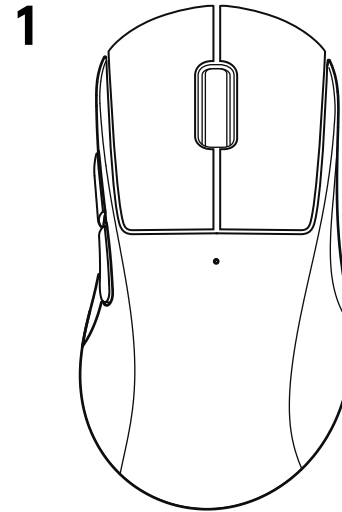

# MOUSE FEATURES

- 1 Left Click
- 2 Right Click
- 3 Middle Click/Scroll
- 4 Browser Back
- 5 Browser Forward
- 6 Power LED
- 7 USB charging/data part
- 8 Power on/off
- 9 POWERPLAY Aperture door

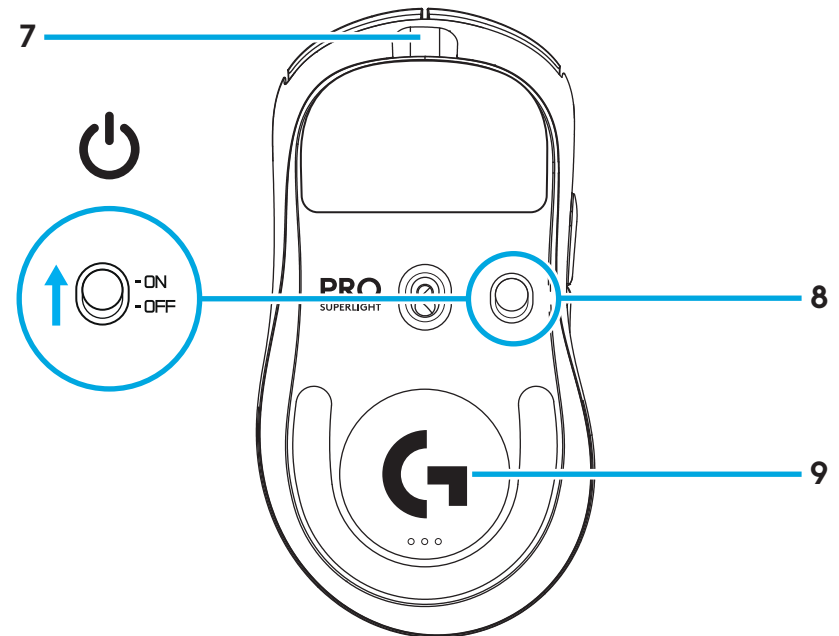
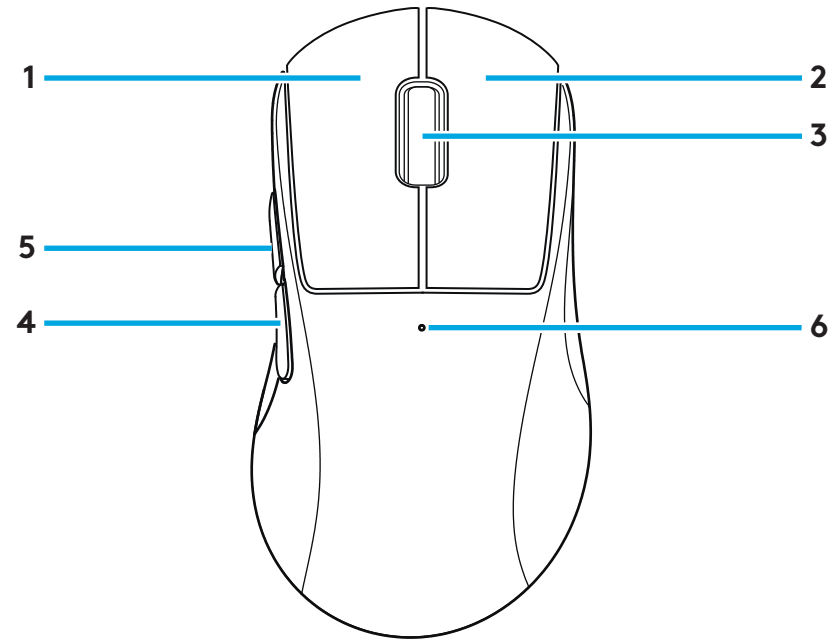

# SETUP

- 1 Plug charging/data cable into PC, then plug extension adapter and receiver into charging/data cable

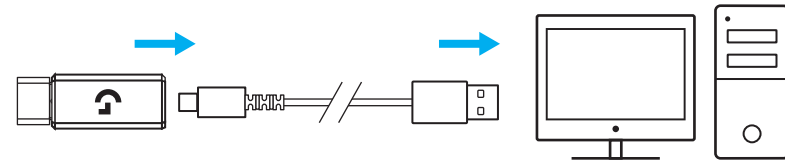

- 2 Turn on mouse

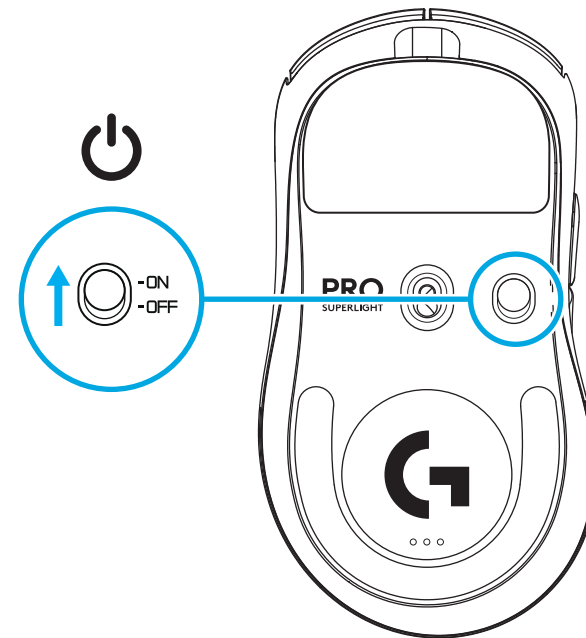

- 3** To configure mouse settings like DPI or report rate, download G HUB software from [logitechG.com/GHUB](http://logitechG.com/GHUB)

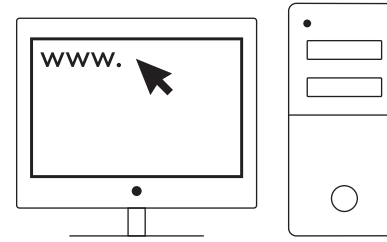

[logitechG.com/ghub](http://logitechG.com/ghub)

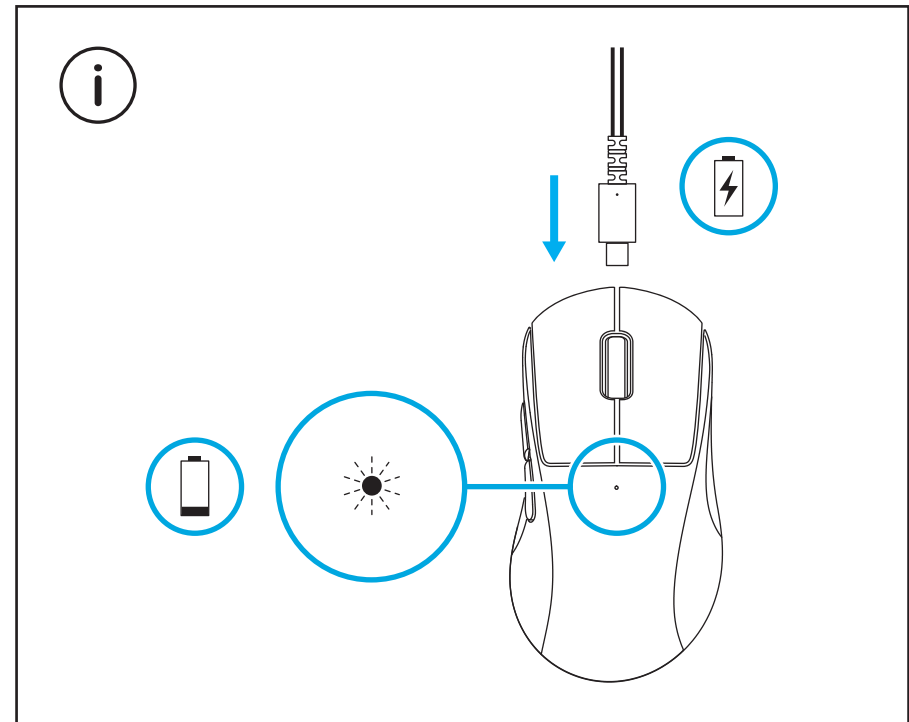

For optimal wireless performance, use mouse within 20cm of receiver and greater than 2m from sources of 2.4GHz interference (such as wifi routers).

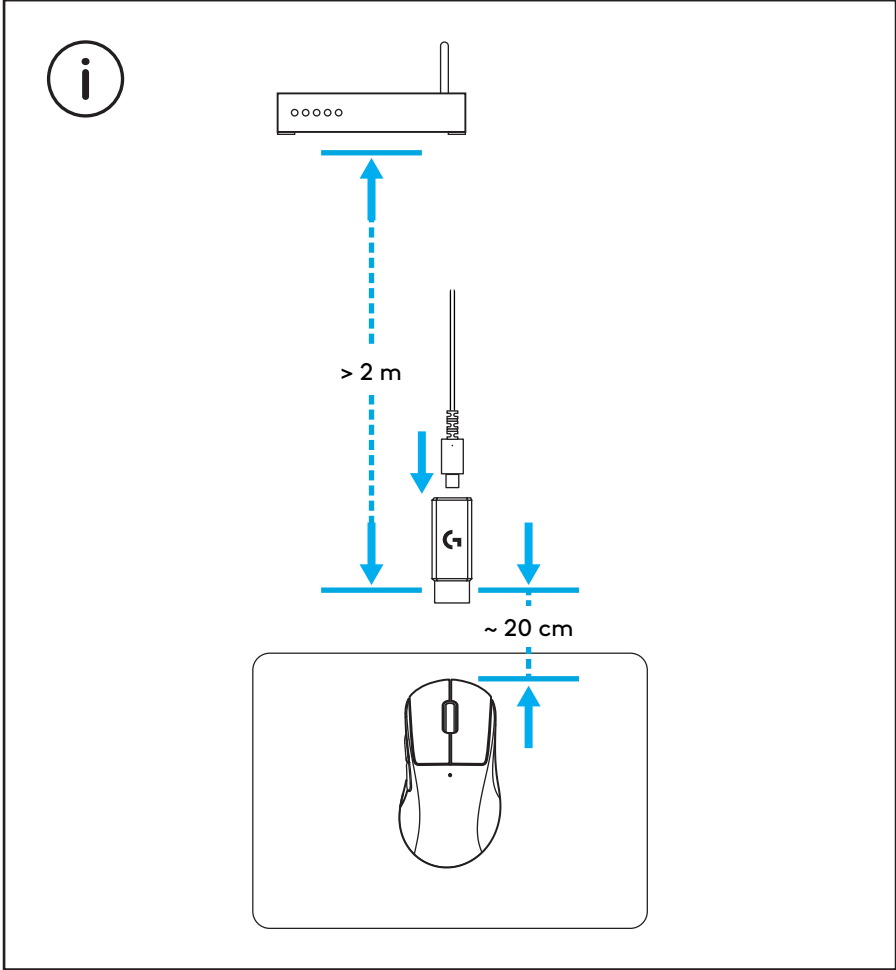

To install optional grip tape, first clean surface of mouse with provided surface preparation cloth to remove any oil or dust. Then, carefully align grip tape to mouse surfaces.

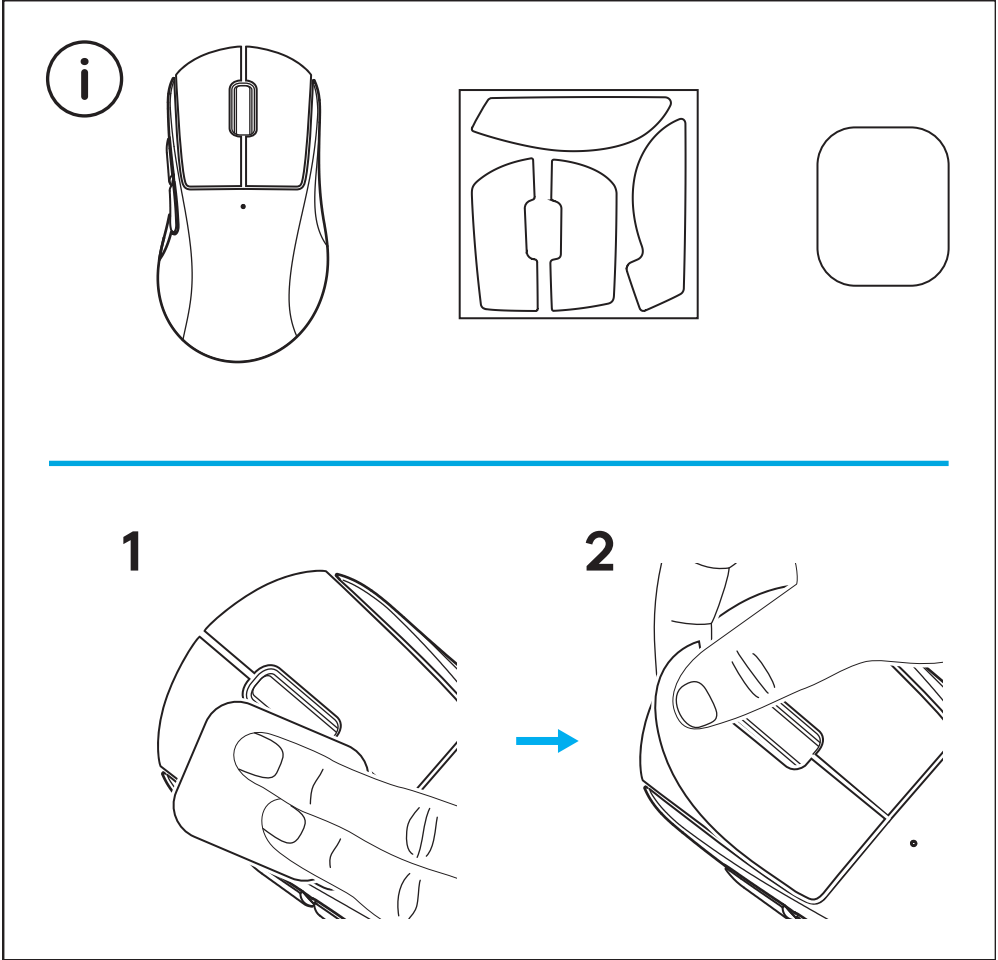



The USB receiver can be stored inside the mouse by removing the POWERPLAY aperture door. This can prevent the receiver from being lost when using the mouse with the Logitech G POWERPLAY wireless charging system.

Removing this door also allows the included, optional aperture door with PTFE foot to be installed instead of the default aperture door.

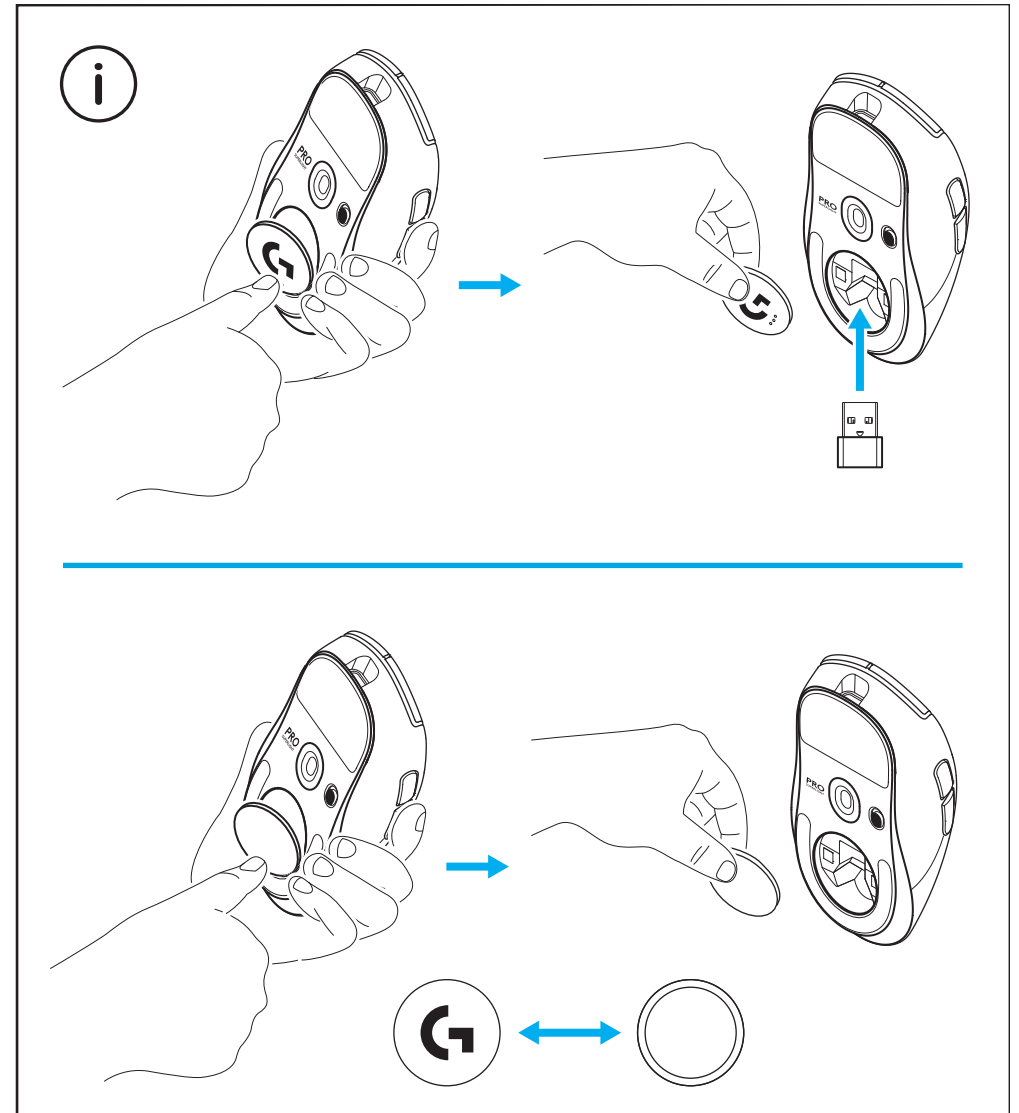

# 包装内容

- 1 鼠标
- 2 可选握胶
- 3 接收器 (预装于扩展适配器中)
- 4 USB 充电/数据线
- 5 表面清洁布
- 6 带 PTFE 脚垫的可选 POWERPLAY 底盖

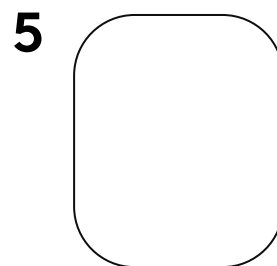
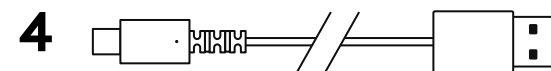
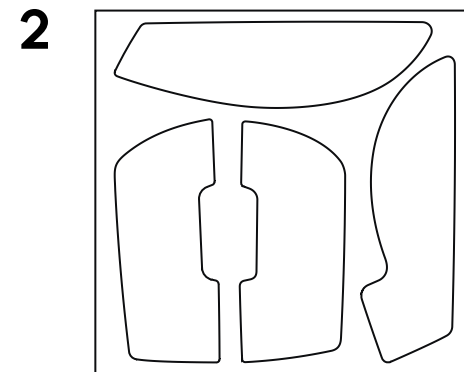
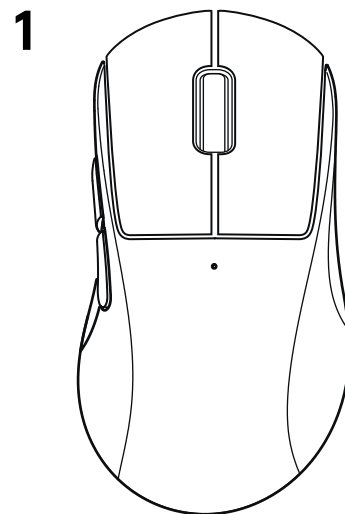

# 鼠标特性

- 1 左键单击
- 2 右键单击
- 3 中键单击/滚轮
- 4 浏览器后退
- 5 浏览器前进
- 6 LED 电量指示灯
- 7 USB 充电/数据连接埠
- 8 电源开关
- 9 POWERPLAY 底盖

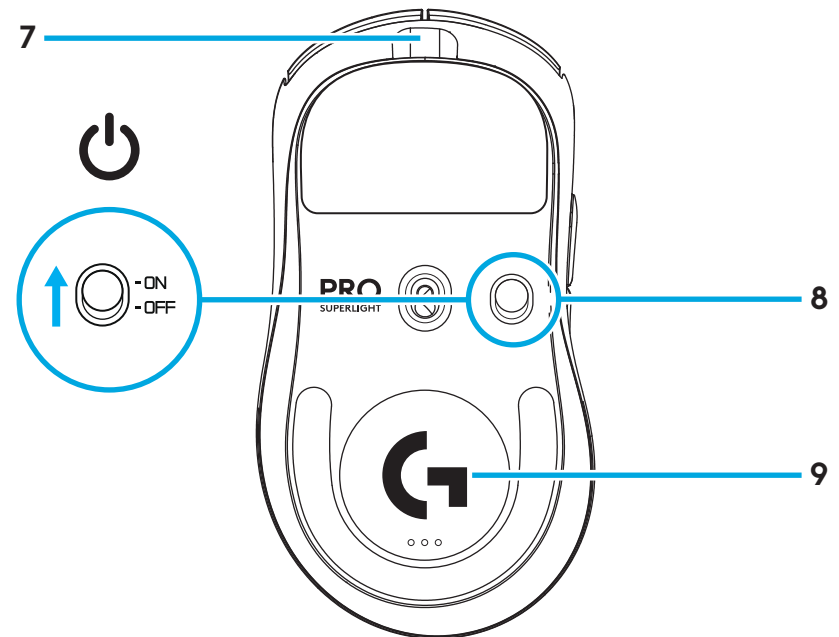
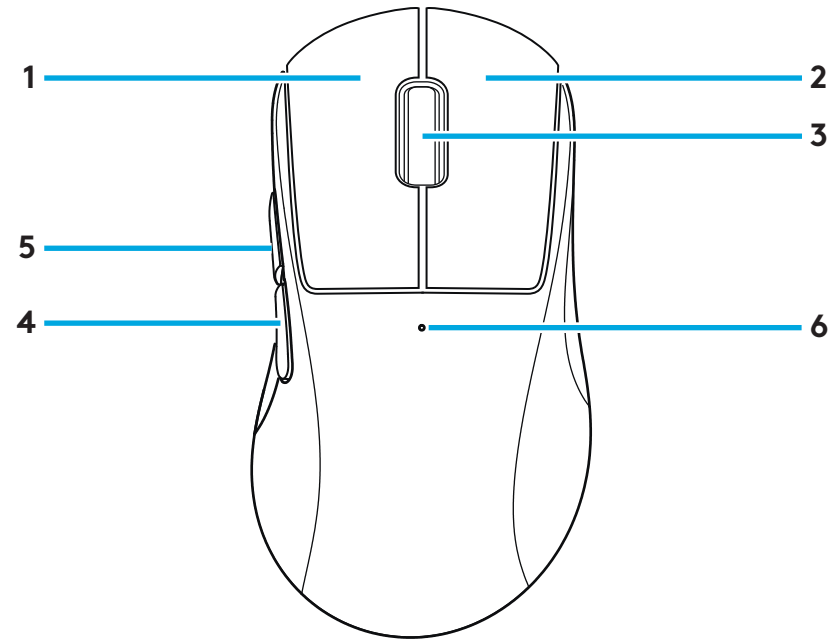

# 设置

- 1 将充电/数据线插入 PC, 然后将扩展适配器和接收器插入充电/数据线

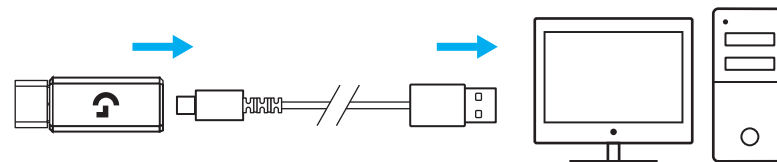

- 2 开启鼠标

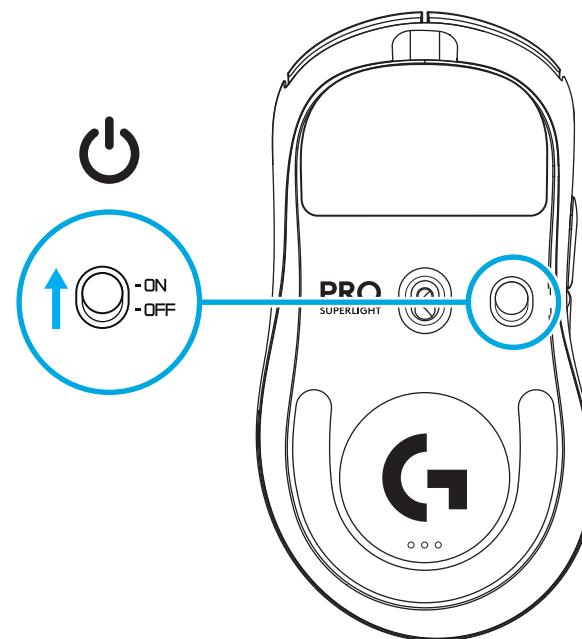

- 3 若要配置 DPI 或报告速率等鼠标设置, 请访问 [logitechG.com/GHUB](http://logitechG.com/GHUB) 下载 G HUB 软件

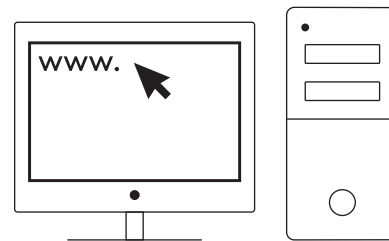

[logitechG.com/ghub](http://logitechG.com/ghub)

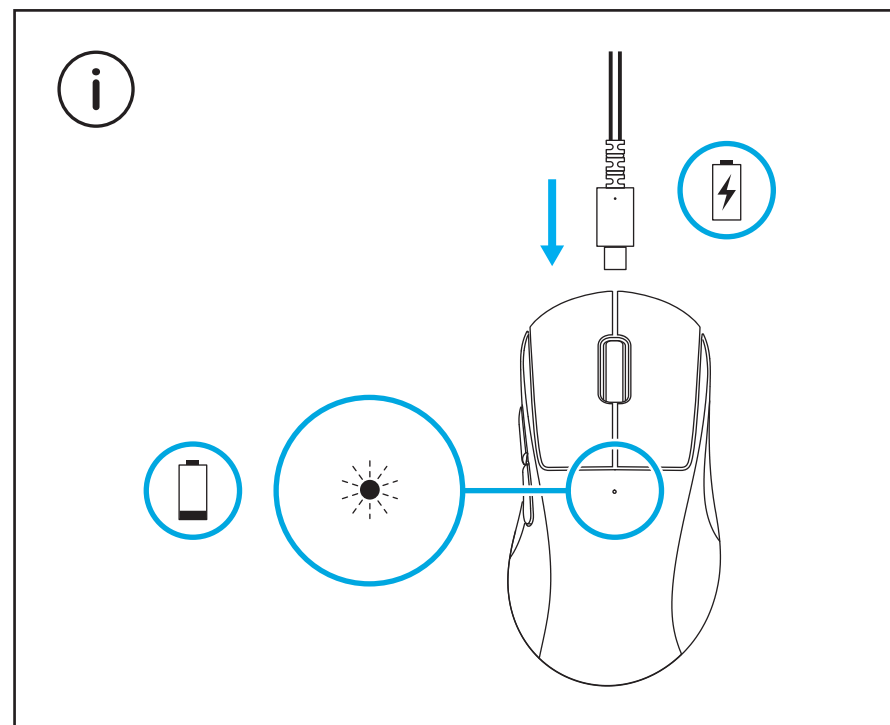

为获得更佳无线性能, 请在距接收器不超过 20 厘米处且距 2.4GHz 干扰源 (如 wifi 路由器) 超过 2 米的位置使用鼠标。

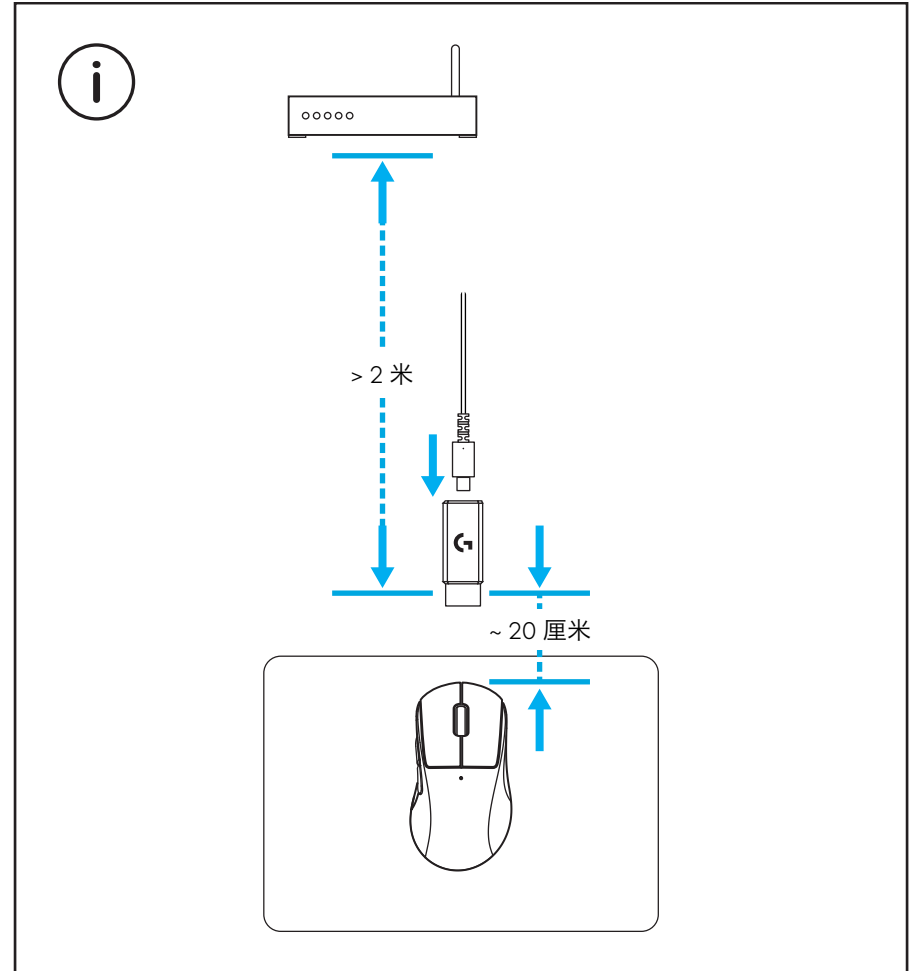

要安装选配的握胶，请先使用随附的表面清洁布清洁鼠标的表面，去除油脂和灰尘。随后，将握胶仔细地对齐鼠标表面。

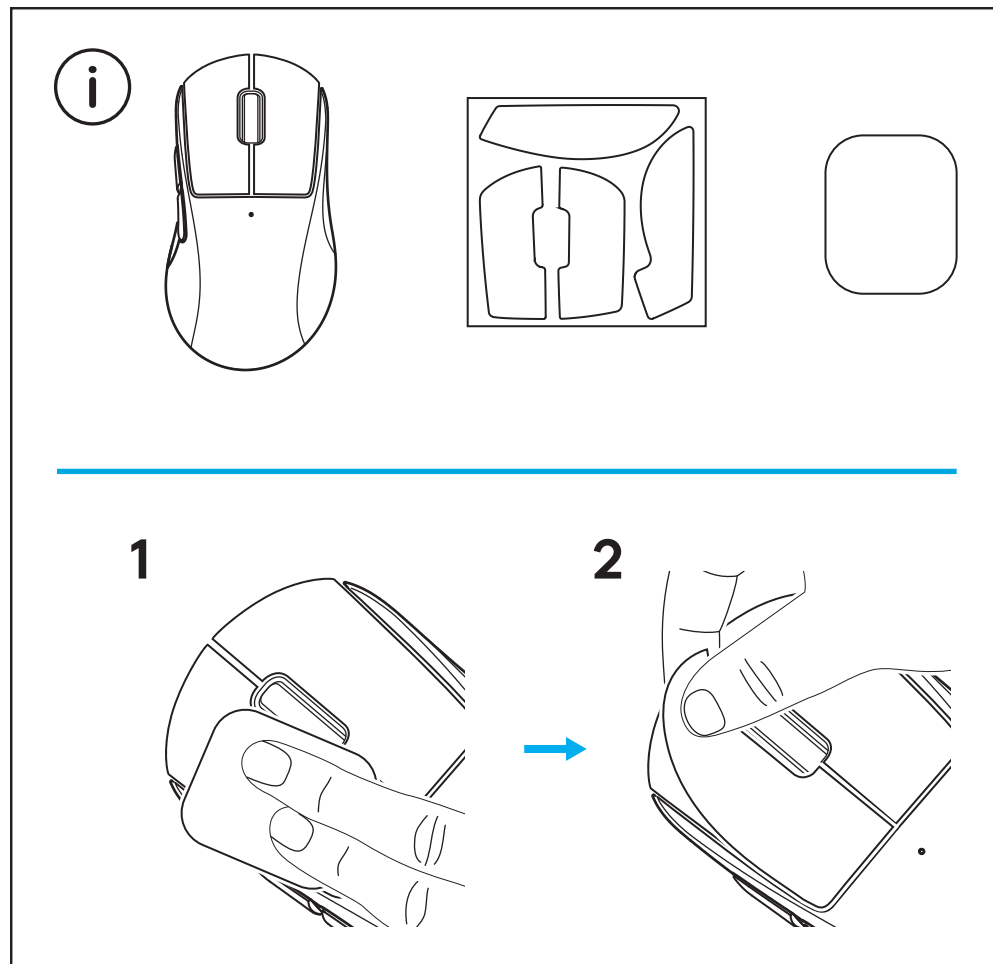

可以卸下 POWERPLAY 底盖将 USB 接收器收纳于鼠标内部。这样, 搭配罗技 G POWERPLAY 无线充电系统使用鼠标时, 可以避免遗失接收器。

卸下底盖还可以安装随附的带 PTFE 脚垫的可选底盖以替换默认底盖。

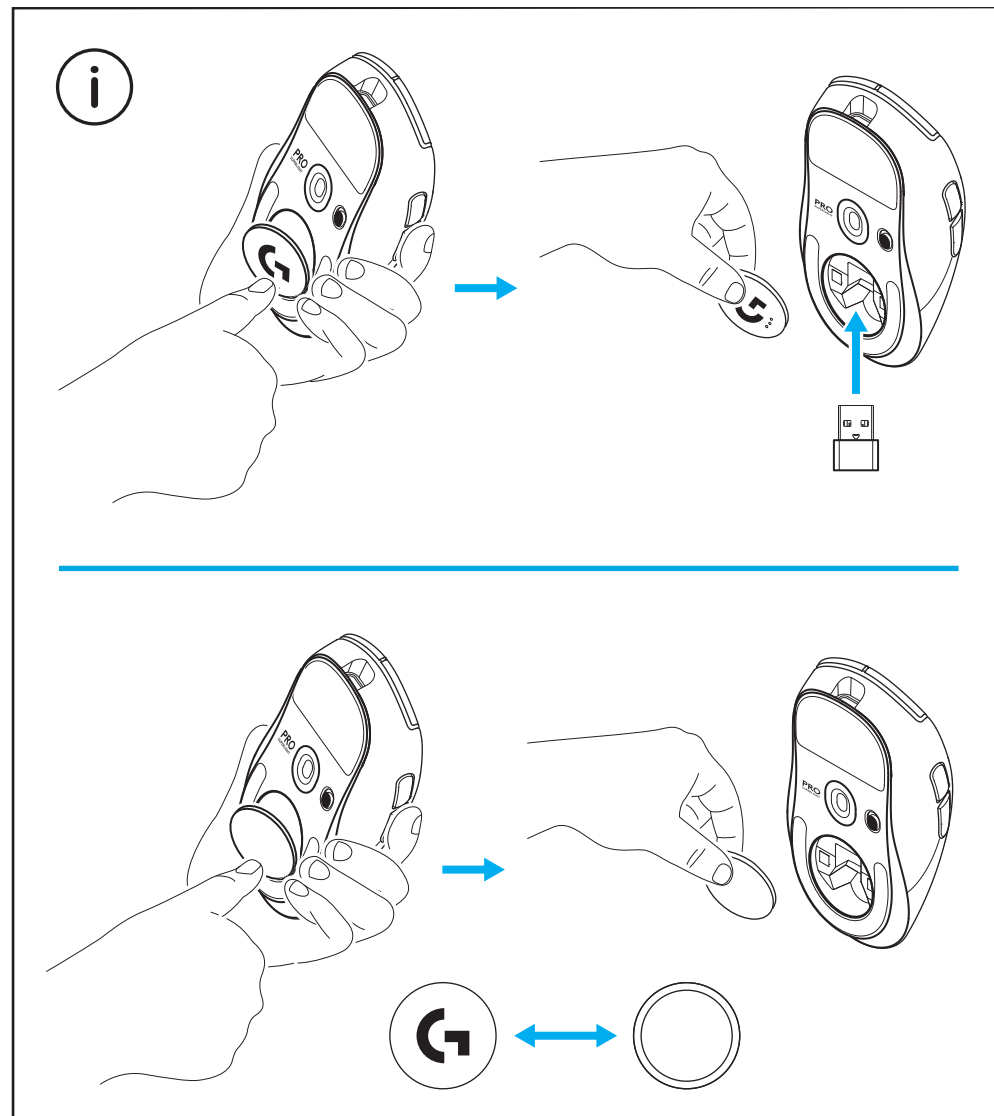



# 包裝內容

- 1 滑鼠
- 2 選用握把貼布
- 3 接收器 (已安裝在延長轉接器中)
- 4 USB 充電與資料連接線
- 5 表面處理布
- 6 具有 PTFE 腳墊的選用 POWERPLAY 底蓋

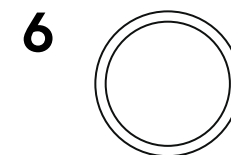
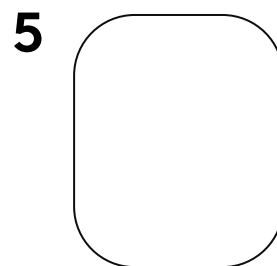
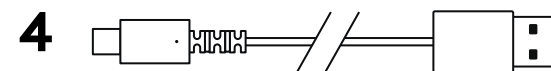
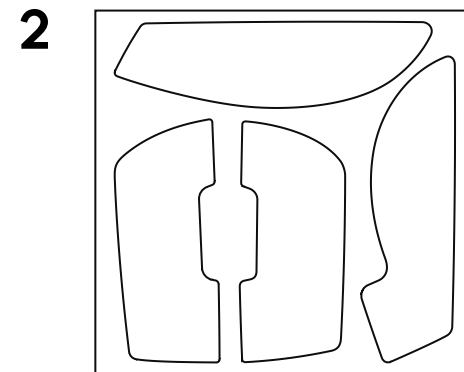
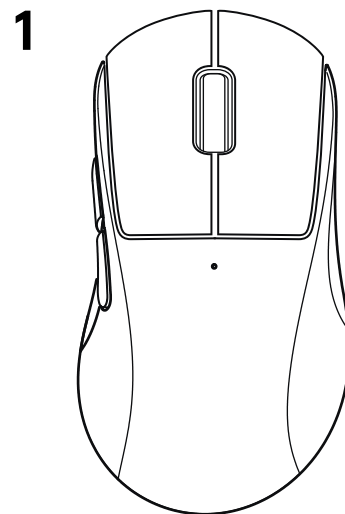

# 滑鼠功能

- 1 按下左鍵
- 2 按下右鍵
- 3 按下中鍵 / 捲動
- 4 瀏覽器前一頁
- 5 瀏覽器下一頁
- 6 電源 LED 指示燈
- 7 USB 充電/資料連接埠
- 8 電源開啓/關閉
- 9 POWERPLAY 底蓋

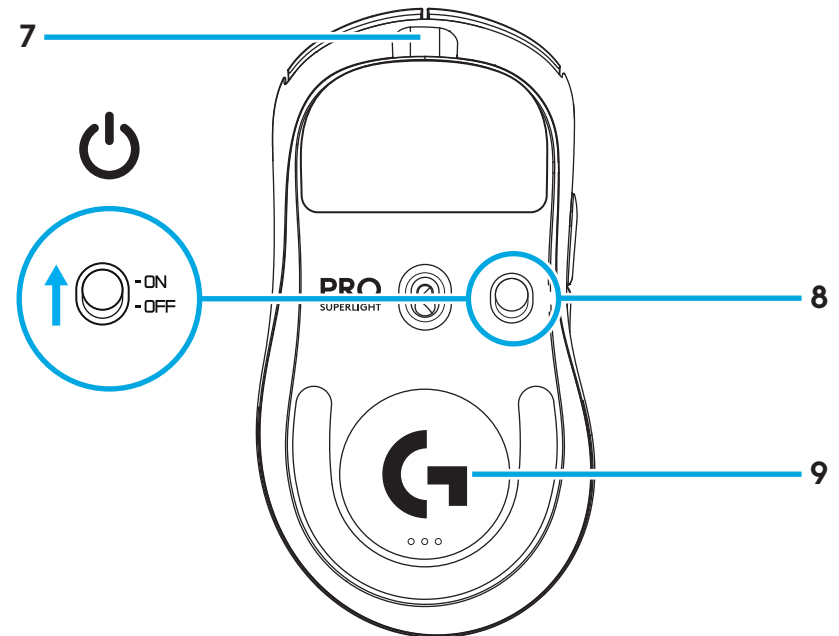
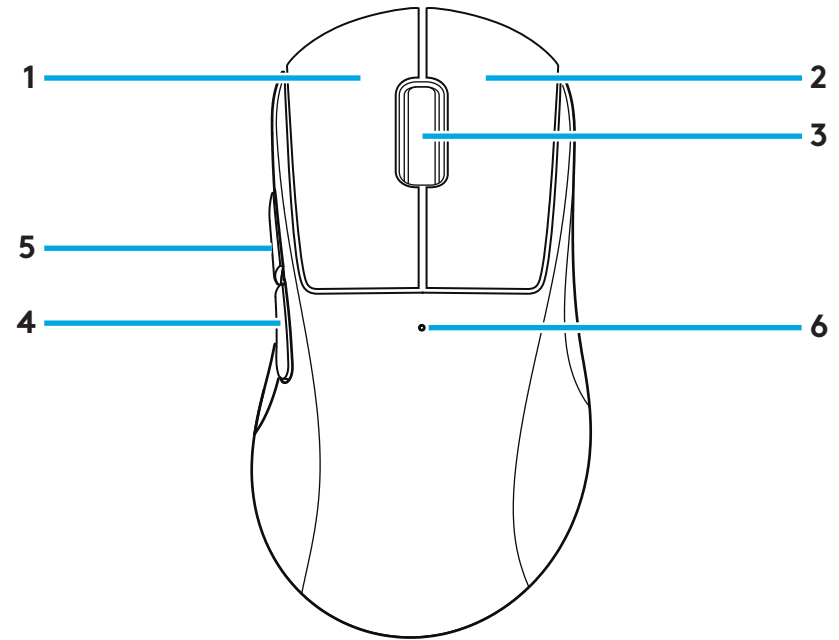

# 設定

- 1 將充電/資料連接線插入到 PC，然後將延長轉接器和接收器插入到充電/資料連接線

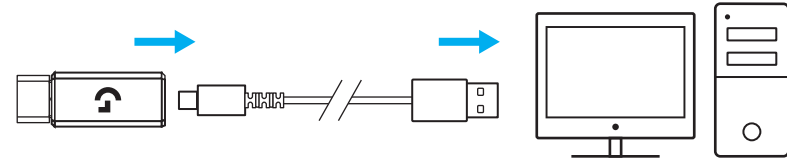

- 2 開啓滑鼠電源

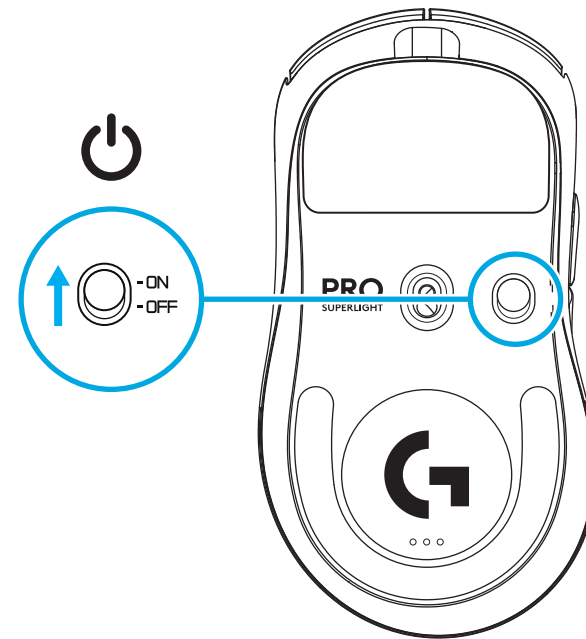

- 3 若要指定滑鼠的 DPI 或回報速率等設定，請到 [logitechG.com/GHUB](http://logitechG.com/GHUB) 下載 G HUB 軟體

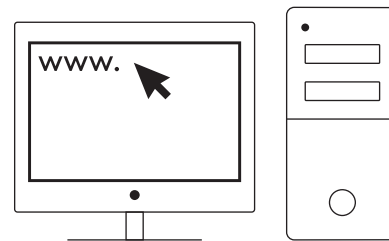

[logitechG.com/ghub](http://logitechG.com/ghub)

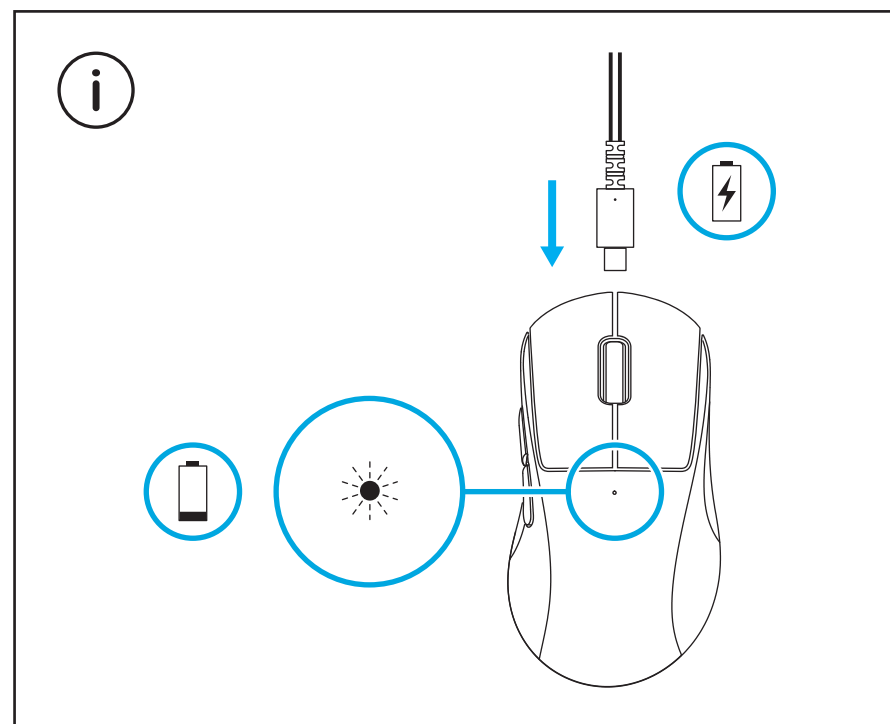

為獲得最佳無線效能，請在接收器 20 公分範圍內與距離 2.4GHz 干擾來源 (例如 wifi 路由器) 2 公尺以上的地方使用滑鼠。

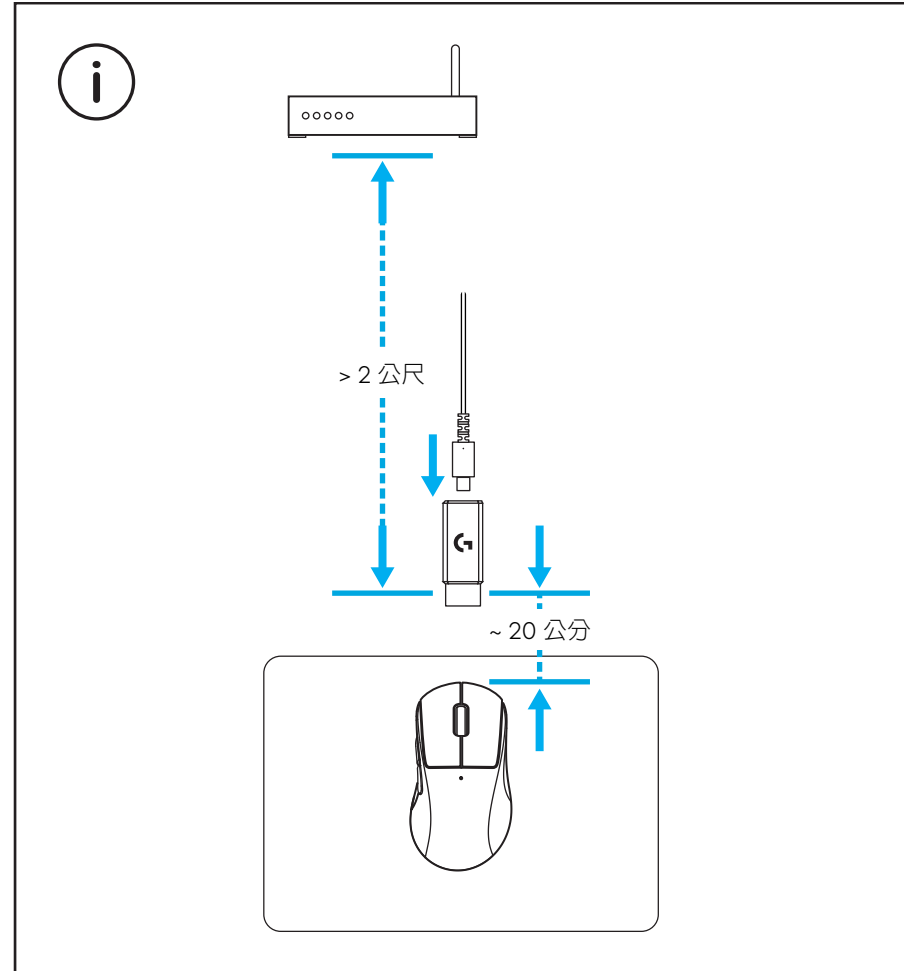

若要安裝選用的握把貼布，請先使用隨附的表面整理布清潔表面，以清除任何油垢或灰塵。然後，小心地將貼布對齊滑鼠表面貼上。

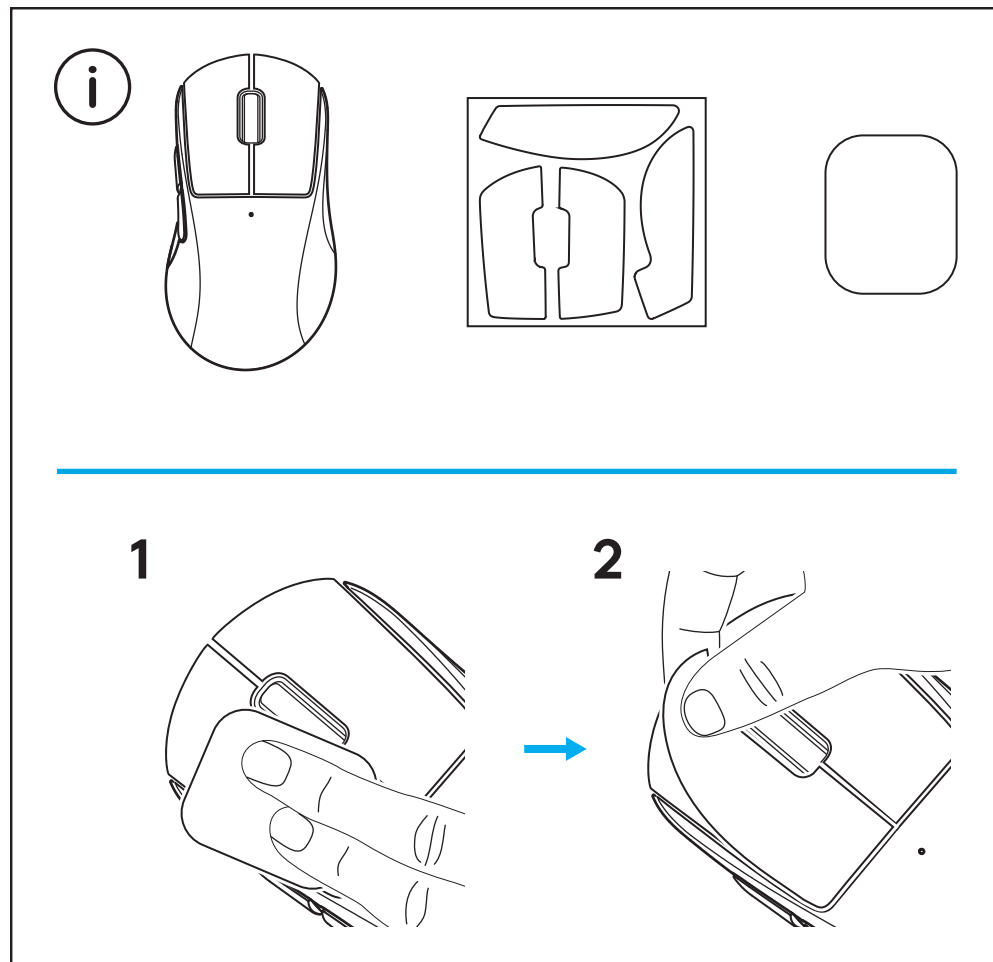

USB 接收器可以透過取下 POWERPLAY 底蓋來存放在滑鼠內部。這可以在滑鼠搭配羅技 G 系列 POWERPLAY 無線充電系統使用時，防止接收器遺失。

取下此底蓋也讓您安裝隨附之具 PTFE 腳墊的選用底蓋，而非預設的底蓋。

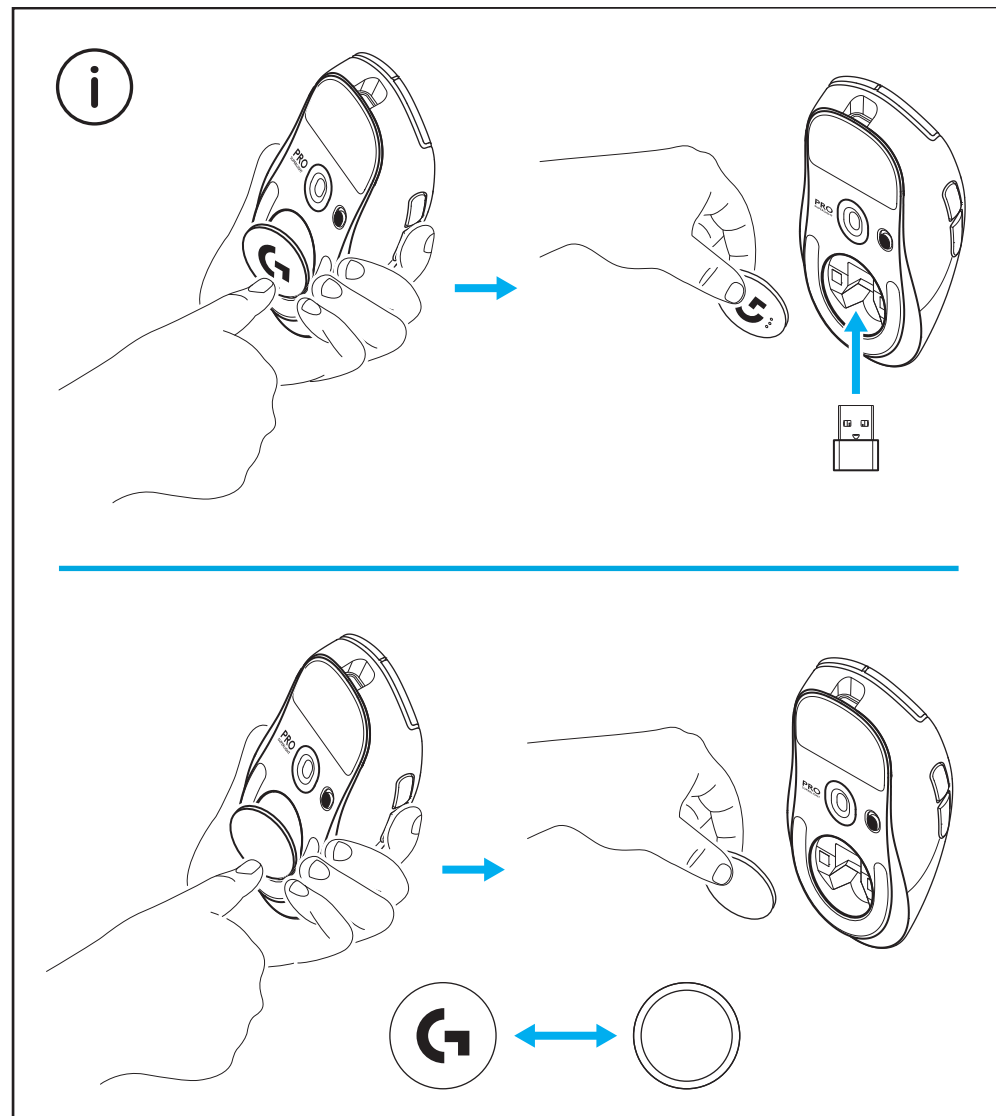

# 패키지 내용물

- 1 마우스
- 2 그립 테이프(선택 사항)
- 3 수신기(확장 어댑터에 장착됨)
- 4 USB 충전 및 데이터 케이블
- 5 표면 정리용 천
- 6 PTFE 피트가 있는 POWERPLAY 개구부(선택 사항)

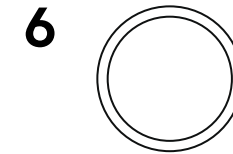
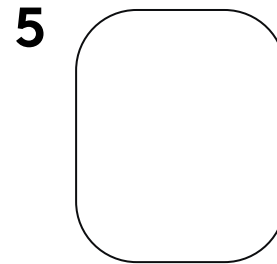
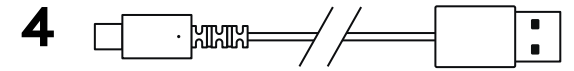
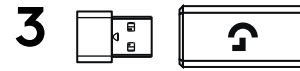
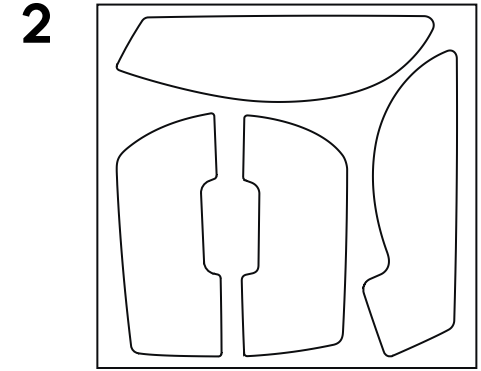
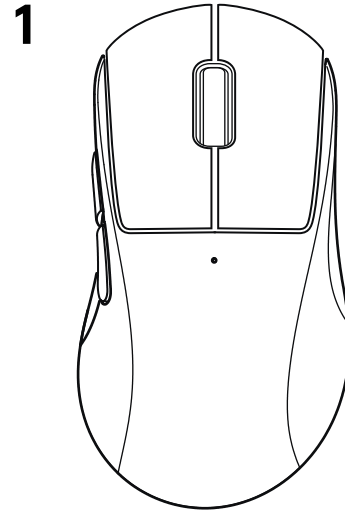



# 마우스 특징

- 1 왼쪽 클릭
- 2 오른쪽 클릭
- 3 가운데 클릭/스크롤
- 4 브라우저 뒤로
- 5 브라우저 앞으로
- 6 전원 LED
- 7 USB 충전/데이터 포트
- 8 전원 켜기/끄기
- 9 POWERPLAY™ 개구부

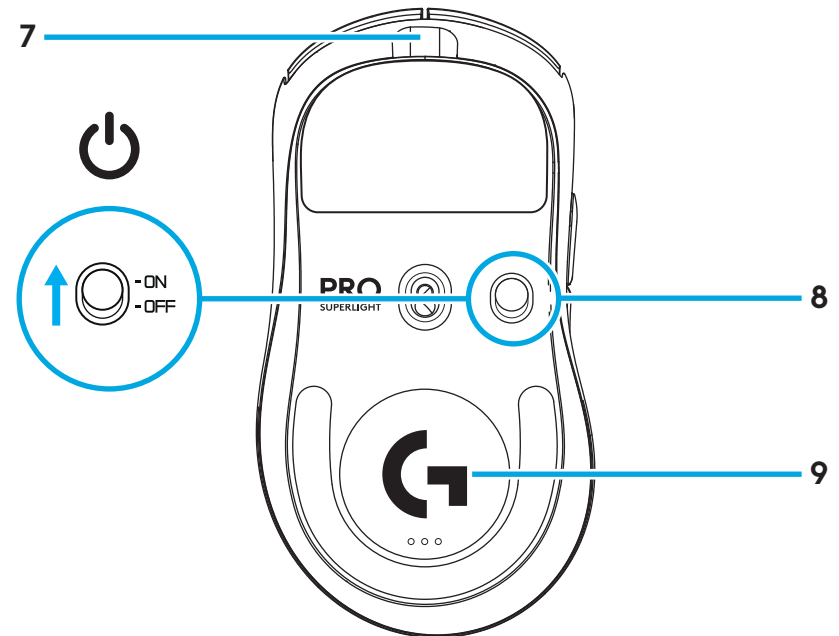
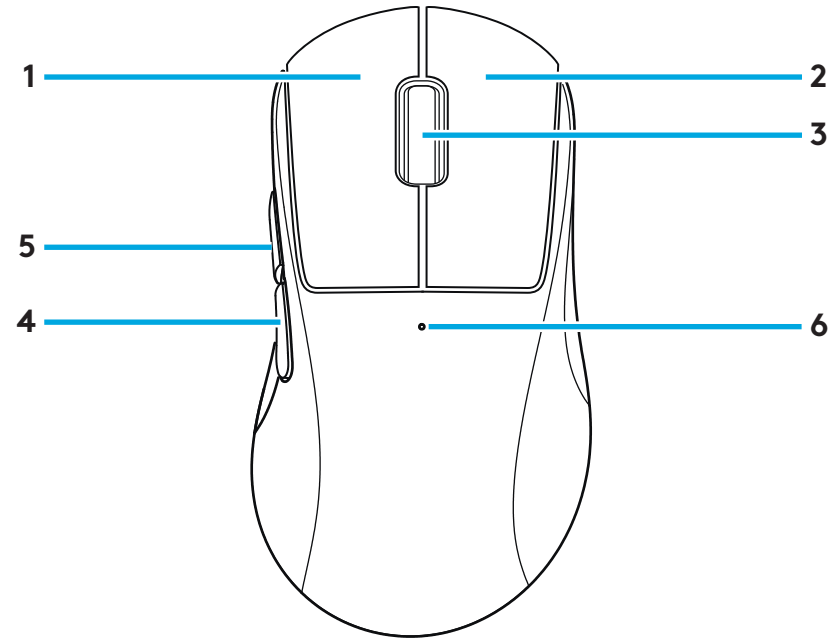

# 설치

- 1 충전/데이터 케이블을 PC에 연결한 다음, 확장 어댑터와 수신기를 충전/데이터 케이블에 연결합니다.

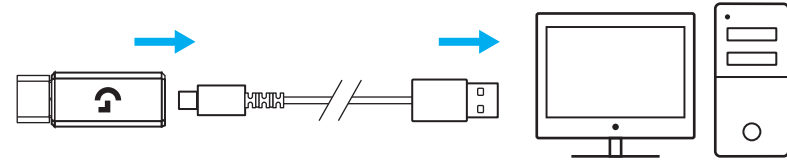

- 2 마우스의 전원을 켭니다.

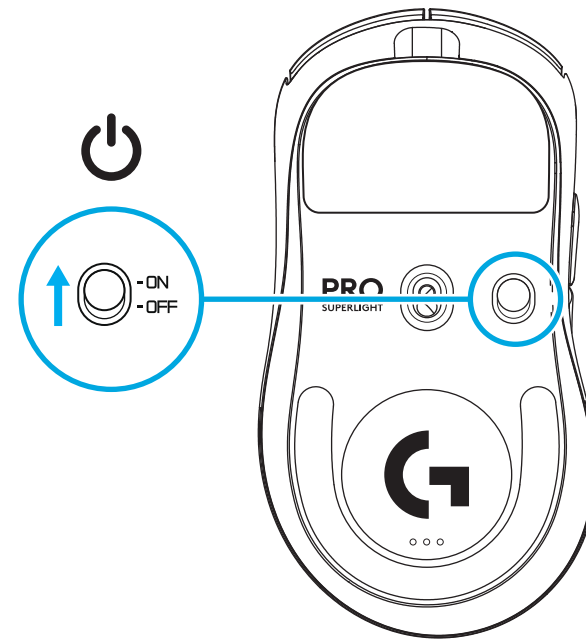

- 3 DPI나 보고율과 같은 마우스 설정을 구성하려면 [logitechG.com/GHUB](http://logitechG.com/GHUB)에서 G HUB 소프트웨어를 다운로드합니다.

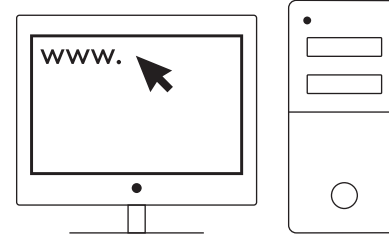

[logitechG.com/ghub](http://logitechG.com/ghub)

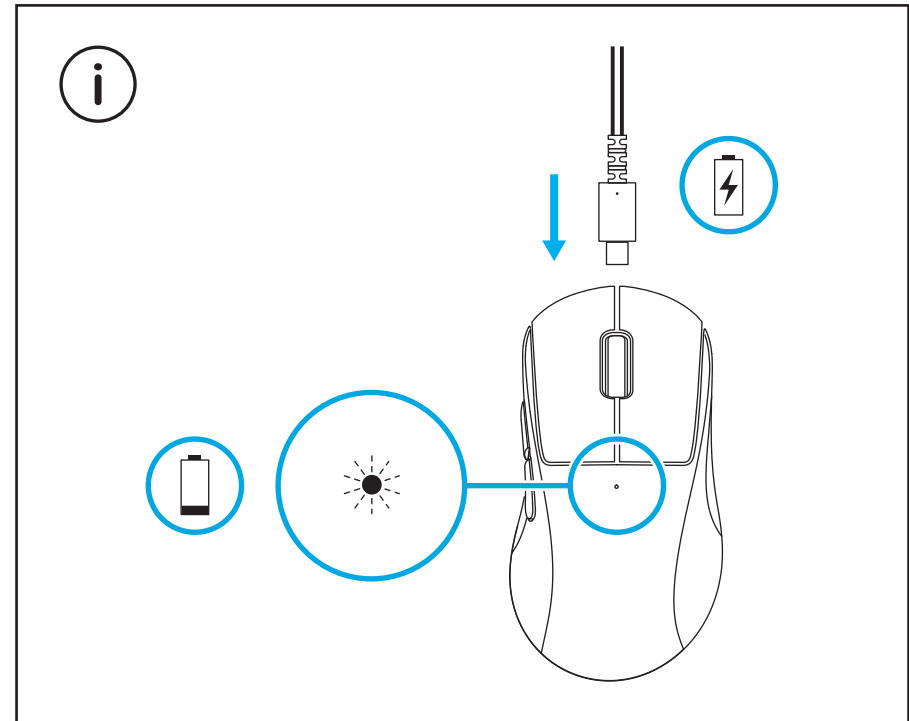



선택 사항인 그립 테이프를 사용하려면 먼저 동봉된 표면 정리용 천으로 마우스의 표면에 있는 기름기나 먼지를 제거합니다. 그 다음 마우스의 표면에 그립 테이프를 조심스럽게 붙입니다.

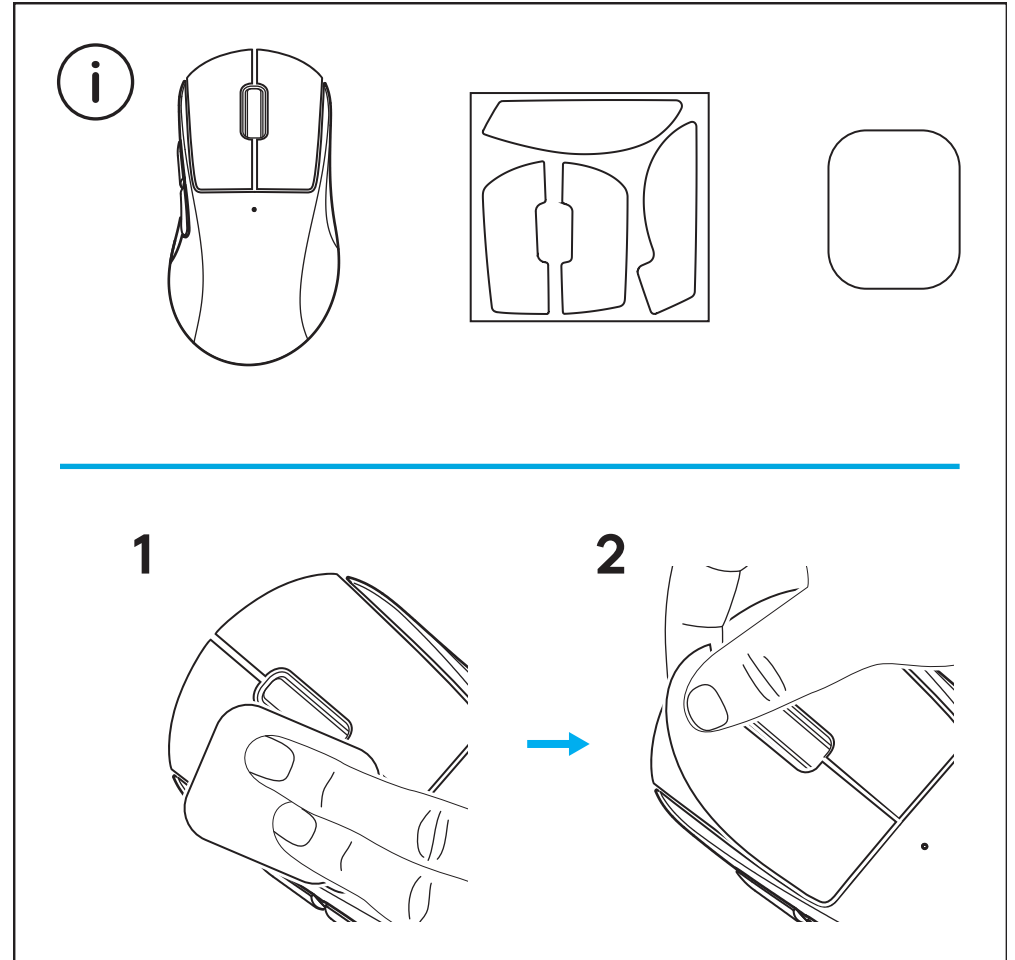

POWERPLAY 개구부를 제거하면 USB 수신기를 마우스 내부에 보관할 수 있습니다. 로지텍 G POWERPLAY 무선 충전 시스템과 마우스를 사용할 때도 수신기를 안전하게 보관할 수 있습니다.

또한 개구부를 열어 기본 개구부 대신 PTFE 피트가 있는 개구부(선택 사항)를 장착할 수 있습니다.

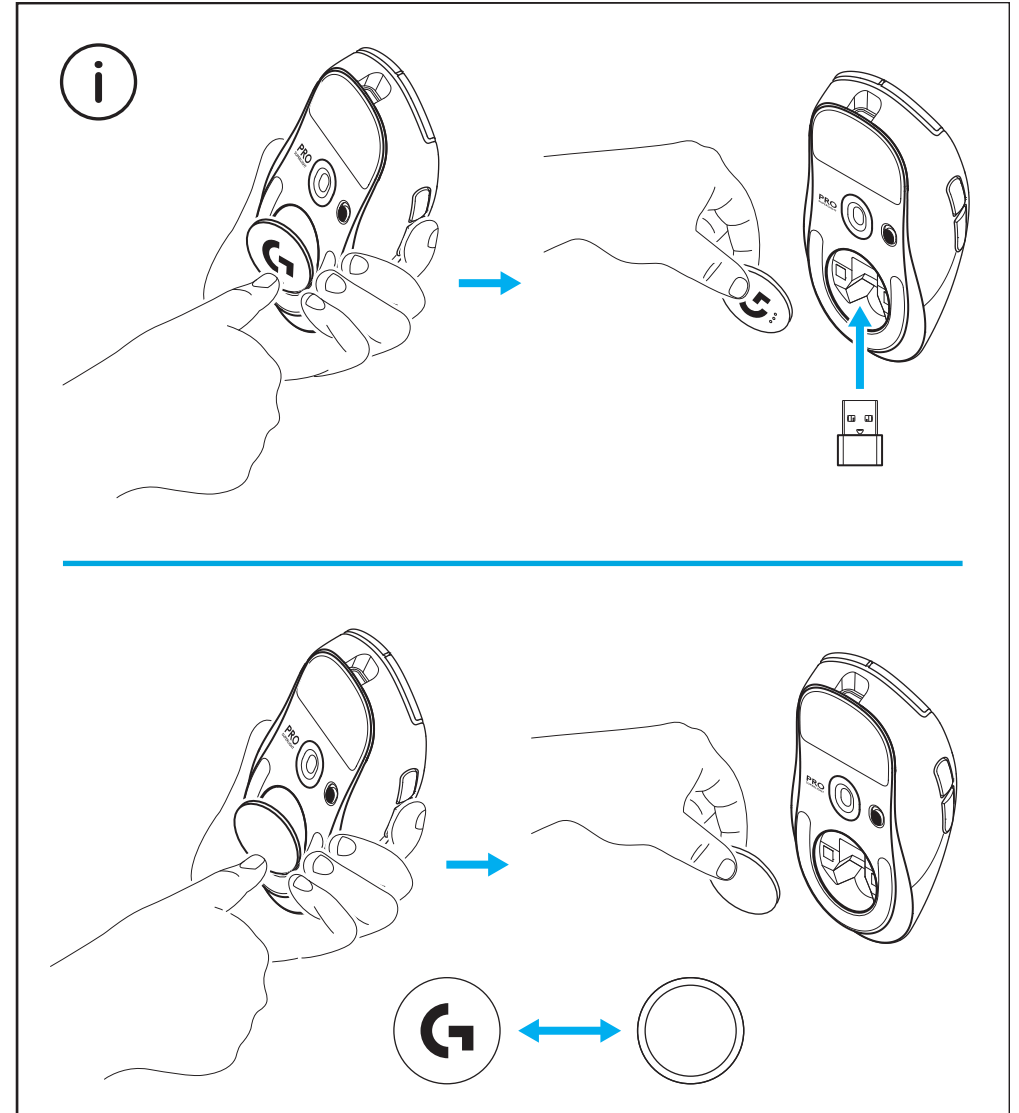



2024 Logitech. Logitech, Logitech G et leurs logos respectifs, et POWERPLAY et LIGHTSPEED sont des marques commerciales ou déposées de Logitech Europe S.A. et/ou de ses sociétés affiliées aux États-Unis et dans d'autres pays. USB-C est une marque déposée d'USB Implementers Forum. Toutes les autres marques sont la propriété exclusive de leurs détenteurs respectifs. Logitech décline toute responsabilité en cas d'erreurs susceptibles de s'être glissées dans le présent manuel. Les informations énoncées dans ce document peuvent faire l'objet de modifications sans préavis.

版权所有 2024 罗技。罗技、Logitech G 及其各自的标志、POWERPLAY 和 LIGHTSPEED 均为罗技欧洲公司和/或其美国及其他国家/地区附属公司的商标，并已注册。USB-C 是 USB Implementers Forum 的商标。所有其它商标均是其各自所有者的财产。罗技对于本手册中可能出现的任何错误不承担任何责任。本手册中包含的信息如有更改，恕不事先通知。本文内所使用的数据如无特别说明均来自罗技有限公司和/或其关联公司和/或其指定的供应商。图片仅作说明之用，可能与实物有所差别。

WEB-621-002584 002